



## Owner's Manual

2015 Audi A3 Sedan | S3 Sedan

Audi  
Vorsprung durch Technik







2015 Audi A3 Sedan

2015 Audi S3 Sedan

## **Foreword**

Thank you for choosing an Audi - we value your trust in us.

Your new Audi will allow you to experience the best in groundbreaking technology and premium quality equipment a vehicle has to offer. We recommend that you read your Owner's Manual thoroughly so that you quickly become acquainted with your Audi and make use of all of its features.

In addition to explaining how the different features work, we provide many useful tips and information concerning your safety, how to care for your vehicle and how to maintain your vehicle's value. We also give you useful tips and information on how to drive your vehicle more efficiently and in an environmentally friendly manner.

In the Owner's Manual, you will also find the Operating Manual for your Infotainment system and the vehicle maintenance schedule.

We hope you enjoy driving your Audi and we wish you safe and pleasant motoring.

**AUDI AG**

## Table of contents

---

<b>Owner's Literature</b> .....	5	<b>Driving</b> .....	70
<b>About this Owner's Manual</b> .....	6	General information .....	70
<b>Cockpit</b> .....	8	Economical and environmentally-friendly driving .....	70
<b>Cockpit overview</b> .....	8	Steering .....	72
Controls at a glance .....	8	Starting and stopping the engine (vehicles with an ignition lock) .....	73
<b>Instruments and indicator lights</b> .....	10	Starting and stopping the engine (vehicles with a convenience key) .....	75
Instruments .....	10	Driver messages .....	77
Indicator lights .....	13	Electromechanical parking brake .....	78
On-Board Diagnostic system (OBD) .....	25	Hill hold .....	80
<b>Driver information system</b> .....	27	<b>Automatic transmission</b> .....	82
Overview .....	27	S tronic .....	82
Operation .....	28	<b>Trailer mode</b> .....	91
Boost indicator .....	29	Driving with a trailer .....	91
Efficiency program .....	29	Trailer mode notes .....	92
Lap timer and engine oil temperature indicator .....	30	<b>Driver assistance</b> .....	94
<b>Start and drive</b> .....	33	<b>Assist</b> .....	94
<b>Opening and closing</b> .....	33	Electronic speed limiter* .....	94
Central locking .....	33	Speed warning system .....	94
Luggage compartment lid .....	39	Cruise control system .....	94
Child safety lock .....	40	Audi adaptive cruise control .....	96
Power windows .....	40	Audi pre sense .....	103
Panorama sunroof .....	42	General information .....	103
<b>Light and Vision</b> .....	43	Audi pre sense basic .....	103
Exterior lighting .....	43	Audi pre sense front .....	104
Interior lighting .....	46	Driver messages .....	106
Vision .....	47	Audi active lane assist .....	106
Windshield wipers .....	49	Audi side assist .....	109
Digital compass .....	51	Audi drive select (drive settings) .....	112
<b>Seats and storage</b> .....	53	<b>Parking systems</b> .....	115
General information .....	53	General information .....	115
Front seats .....	54	Rear parking system .....	116
Head restraints .....	56	Parking system plus .....	116
Socket .....	57	Rearview camera .....	117
Storage .....	58		
Luggage compartment .....	59		
Roof rack .....	62		
<b>Warm and cold</b> .....	64		
Climate control system .....	64		



Adjusting the display and the warning tones .....	121	<b>Maintenance and Care</b> .....	190
Error messages .....	121	<b>Checking and Filling</b> .....	190
<b>Intelligent Technology</b> .....	122	Gasoline .....	190
Notice about data recorded by the Event Data Recorder and vehicle control modules .....	122	Diesel fuel .....	191
Electronic stabilization control (ESC) ....	123	Refueling .....	192
Brakes .....	125	Catalytic converter .....	194
Electromechanical steering .....	126	Diesel particulate filter .....	195
All wheel drive (quattro) .....	127	Selective catalytic reduction .....	195
Energy management .....	128	Engine compartment .....	198
<b>Safety</b> .....	130	Engine oil .....	201
<b>Driving safety</b> .....	130	Cooling system .....	205
Basics .....	130	Brake fluid .....	207
Correct passenger seating positions .....	131	Battery .....	208
Driver's and front passenger's footwell ..	135	Windshield washer system .....	212
Pedal area .....	135	Service interval display .....	212
Storing cargo correctly .....	136	<b>Tires and wheels</b> .....	214
Reporting Safety Defects .....	138	Wheels .....	214
<b>Safety belts</b> .....	140	Tire pressure monitoring system .....	232
General notes .....	140	<b>Care and cleaning</b> .....	235
Why use safety belts? .....	141	General information .....	235
Safety belts .....	143	Car washes .....	235
Belt tensioners .....	146	Cleaning and care information .....	236
<b>Airbag system</b> .....	148	<b>Troubleshooting</b> .....	240
Important information .....	148	<b>Emergency assistance</b> .....	240
Front airbags .....	152	Luggage compartment lid emergency release .....	240
Monitoring the Advanced Airbag System .	160	General information .....	240
Knee airbags .....	164	Equipment .....	241
Side airbags .....	166	Replacing wheels .....	241
Side curtain airbags .....	169	Spare tire .....	246
<b>Child safety</b> .....	172	<b>Fuses and bulbs</b> .....	248
Important information .....	172	Electrical fuses .....	248
Child seats .....	178	Bulbs .....	250
Securing child seats .....	182	<b>Emergency situations</b> .....	252
LATCH system (Lower anchorages and tethers for children) .....	185	General .....	252
Additional information .....	189	Starting by pushing or towing .....	252
		Starting with jumper cables .....	252
		Using jump start cables .....	253
		Towing with a tow truck .....	254
		Raising the vehicle .....	256

## Table of contents

---

<b>Technical Data</b> .....	258
<b>Technical data</b> .....	<b>258</b>
Vehicle identification .....	258
Weights .....	258
Dimensions .....	259
Capacities .....	260
Gasoline engines .....	261
Diesel engine .....	261
<b>Consumer information</b> .....	<b>262</b>
Warranty coverages .....	262
Operating your vehicle outside the U.S.A. or Canada .....	262
Audi Service Repair Manuals and Literature .....	262
Maintenance .....	262
Accessories and technical changes .....	264
Declaration of Compliance, Telecommunication and Electronic Systems .....	265
<b>Index</b> .....	<b>266</b>



In addition to this Owner's Manual, your Audi comes with the

- MMI Operating Instructions
- Warranty & Maintenance booklet.

If you are missing one of these publications, or if you believe that the information is not complete, contact your authorized Audi dealer for assistance.

### **MMI Operating Instructions**

contain detailed description of the Audi Multi Media Interface (MMI) including the navigation system, the sound system and the handheld phone.

### **The Warranty & Maintenance booklet**

explains how you can keep your Audi in top driving condition by having it serviced regularly and contains detailed information about the warranties covering your Audi. Always have the booklet with you when you take your vehicle to an authorized Audi dealer for service. Your Audi Service Advisor will record each scheduled service and can answer any questions you may have regarding how to maintain your vehicle.

### **In Canada,**

the vehicle literature is also available in French. To obtain a copy, contact your dealer or write to:

Au Canada, on peut se procurer un exemplaire en français de ce document auprès du concessionnaire ou de:

Audi Canada  
Client Assistance  
Assistance a la Clientele  
777 Bayly Street, West,  
Ajax, Ontario L1S 7G7

### **If you sell your Audi**

all literature should be left in the vehicle to make the Warranty terms as well as all operating, safety and maintenance information available to the next owner.

### **If you change your address or if you bought this Audi used**

be sure to send in a "Notice of Address Change" / "Notice of Used Car Purchase" post card. This card can be found in the Warranty & Maintenance booklet or obtained from your authorized Audi dealer.

**It is in your own interest that we are able to contact you should the need arise.**

## About this Owner's Manual

---

This manual contains important information, tips, suggestions and warnings for using your vehicle.

Keep this manual in your vehicle at all times. This is especially important if you loan your vehicle to others or sell it.

This owner's manual describes the **equipment range** specified for this model at the time of printing. Individual equipment options described may only be available at a later date or may only be offered in certain countries.

Some sections in this manual do not apply to all vehicles. When this is the case, the beginning of the section indicates the **validity**, for example "Applies to vehicles: with auxiliary heating". Optional or vehicle-specific equipment is also identified with an asterisk "\*".

The **illustrations** are designed as a general guide and on your vehicle may look slightly different than what is illustrated.

There is a **Table of Contents** at the beginning of this owner's manual that lists all of the topics covered in this book in the order that they appear. There is also an alphabetical **Index** at the end of this owner's manual.

All **directions**, such as "left", "right", "front" and "rear", are based on the vehicle's direction of travel.

\* Optional or vehicle-specific equipment

▶ The section continues on the next page.

⇒ ⚠ Cross reference to a "WARNING" within a section. If a page number is indicated, the WARNING is located outside of the section.

### **WARNING**

Text with this symbol contains information about safety and how to reduce the risk of serious personal injury or death.

### **Note**

Text with this symbol contains information about reducing the risk of damage to your vehicle.



### **For the sake of the environment**

Text with this symbol contains information on protecting the environment.



### **Tips**

Text with this symbol contains additional useful information.





## Cockpit overview

### Controls at a glance

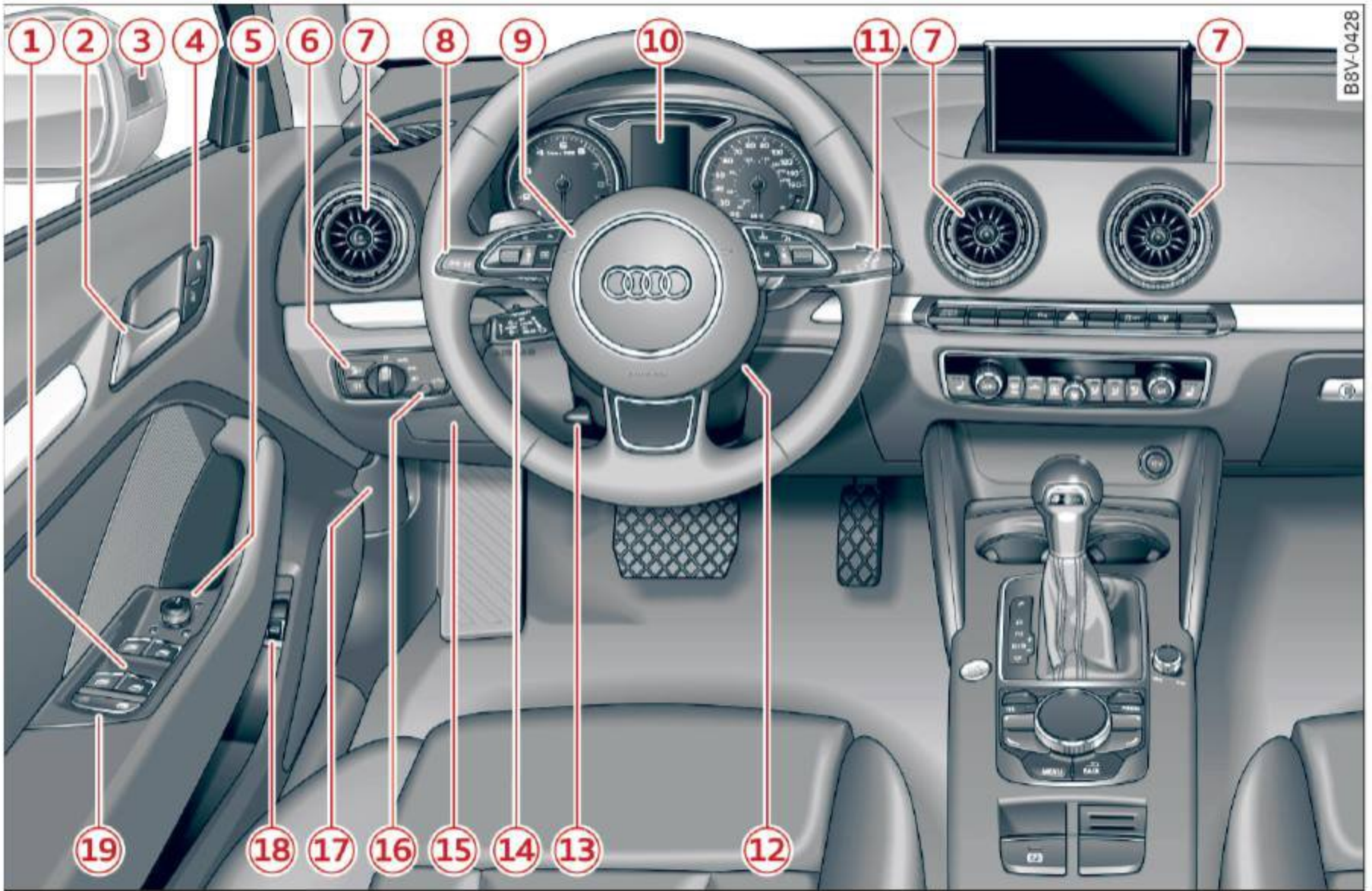

B8V-0428

Fig. 1 Cockpit: left section

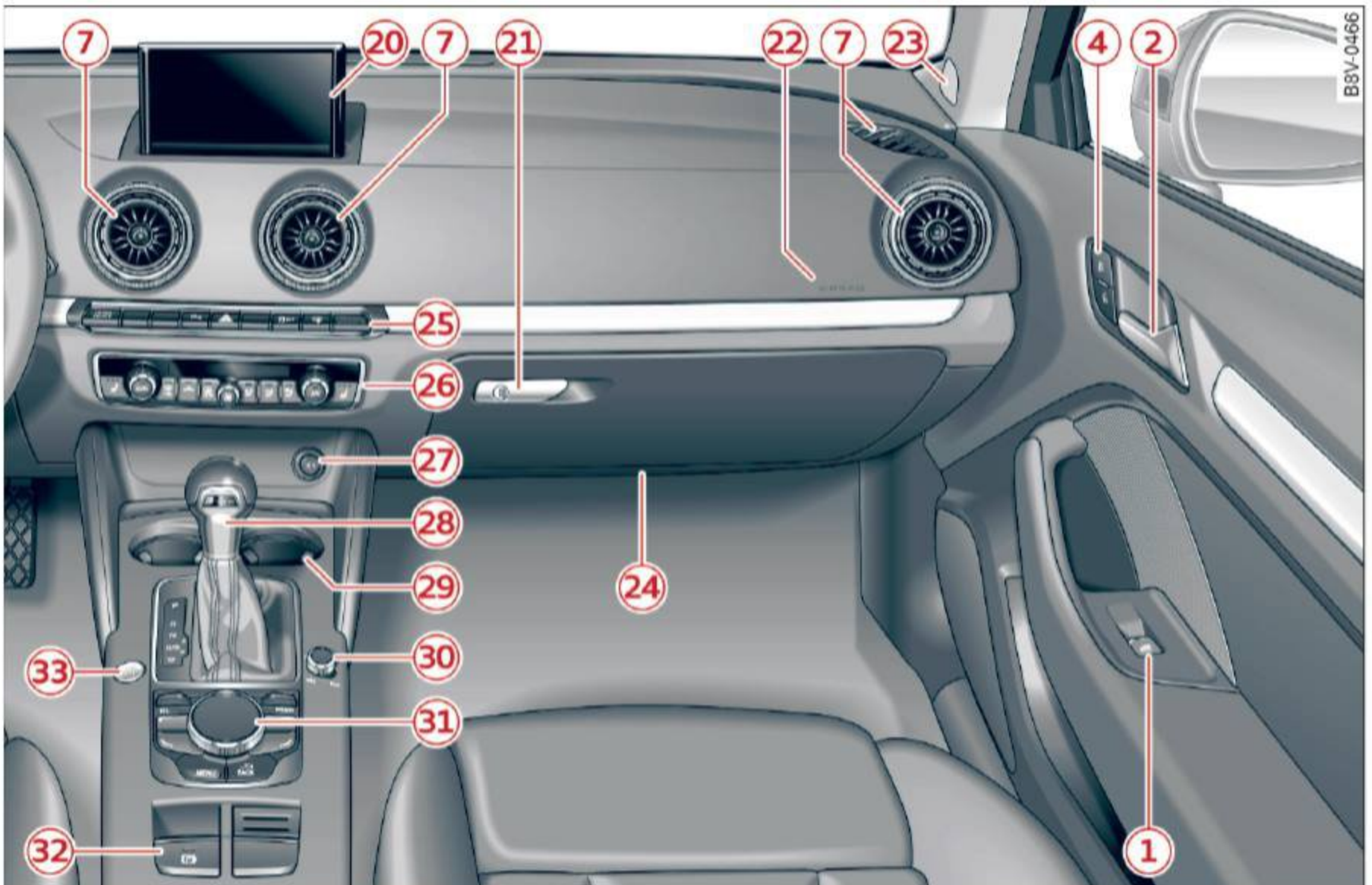

B8V-0466

Fig. 2 Cockpit: right section



① Power windows	40	– Emergency flashers	44
② Door handle		– Electronic Stabilization Control (ESC)	123
③ Audi side assist	109	– MMI Display	
④ Central locking switch	37	– Airbag Off indicator	160
⑤ Power exterior mirror adjustment	47	②⑥ Depending on equipment:	
⑥ Headlight control switch	43	– Manual climate control system	65
⑦ Vents	64	– Automatic climate control system	66
⑧ Lever for:		②⑦ Socket	57
– Turn signals and high beams	45	②⑧ S tronic selector lever	82
– Audi active lane assist	106	②⑨ Cup holder	58
⑨ Steering wheel with horn and		③⑩ MMI On/Off button	
– Driver's airbag	152	③① MMI control panel	
– On-board computer controls	28	③② Parking brake	78
– MMI, telephone, navigation and voice recognition system controls		③③ <b>START ENGINE STOP</b> button (vehicles with convenience key)	75
– tiptronic shift paddles (automatic transmission)	87		
⑩ Instrument cluster	10		
⑪ Windshield washer system lever	49		
⑫ Steering column with:			
– Ignition emergency operation (in vehicles with convenience key)	77		
– Ignition lock (in vehicles with mechanical key)	73		
⑬ Adjustable steering column	72		
⑭ Depending on equipment:			
– Cruise control lever	94		
– adaptive cruise control	96		
⑮ Driver's knee airbag	164		
⑯ Instrument illumination	47		
⑰ Hood release	199		
⑱ Luggage compartment release	39		
⑲ Child safety lock button	40		
⑳ MMI display (navigation, radio, TV/video)			
㉑ Glove compartment (lockable)	58		
㉒ Front passenger's airbag	152		
㉓ Treble speakers			
㉔ Front passenger's knee airbag	164		
㉕ Depending on equipment, buttons for:			
– Audi drive select	112		
– Parking aid plus (or with rearview camera)	116		

**i Tips**

- Some the equipment listed here is only installed in certain models or is available as an option.
- Operation of the Multi Media Interface (MMI) is described in a separate operating instructions manual. You can also find information on Audi connect there.



# Instruments and indicator lights

## Instruments

### Instrument cluster overview

The instrument cluster is the central information center for the driver.

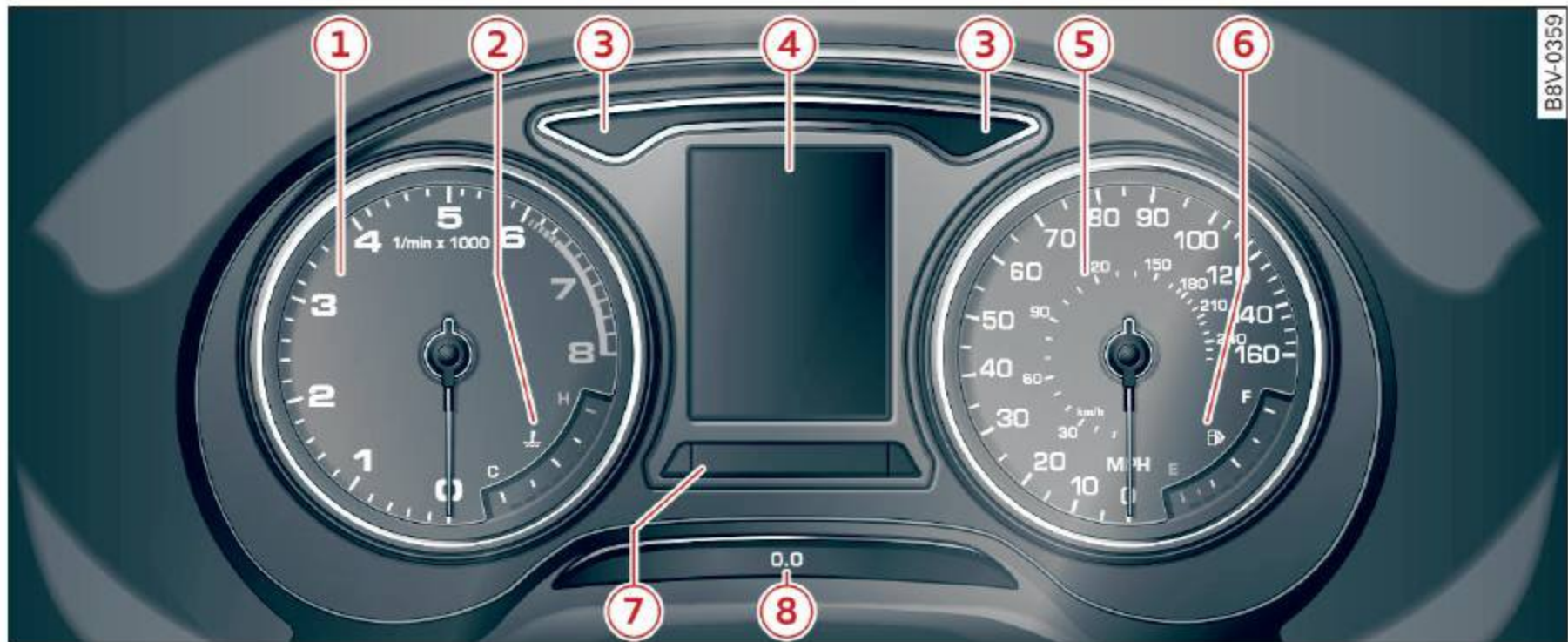

Fig. 3 Instrument cluster overview

- ① Tachometer with indicator lights
- ② Coolant temperature indicator\* or Boost\* (boost pressure indicator) 12, 29
- ③ Turn signal indicator lights
- ④ Display
  - Indicator lights or ..... 13
  - Driver information system ..... 27
  - Date and time ..... 10
  - Mileage ..... 11
  - Service interval display ..... 212
- ⑤ Speedometer with indicator lights
- ⑥ Fuel level ..... 11
- ⑦ Display for: Central indicator light or system displays ..... 13
- ⑧ Trip odometer reset button 0.0 . 11

### Setting the time/date



Fig. 4 Instrument cluster: time and date

The date, time of day, time and date format can be set in the MMI. Refer to the MMI owner's manual for instructions.

**i Tips**

The needles in the instrument cluster are illuminated when the ignition is switched on. The gauges are also illuminated when the lights are turned on. The instrument illumination dims automatically as the amount of light outside decreases. This helps to remind the driver to turn the headlights on as it becomes darker outside.

**i Tips**

- When you switch the ignition off or open the driver's door, the date and time are displayed for approximately 30 seconds.
- You can also turn on the display with the 0.0 button when the ignition is switched off ⇒ page 10, fig. 3.



## Tachometer

The tachometer shows the number of engine revolutions per minutes.

The beginning of the red zone in the tachometer indicates the maximum permissible engine speed for all gears once the engine has been broken in and when it is warm. You should select the “D/S” (Drive) selector lever position or take your foot off the accelerator pedal before reaching this area.

It is best to avoid high engine speeds, even when driving in tiptronic mode ⇒ page 87.

### ! Note

The tachometer needle ① ⇒ page 10, fig. 3 should only be in the red zone briefly:

### 🌱 For the sake of the environment

Upshifting early helps you to save fuel and reduce operating noise.

## Odometer



Fig. 5 Instrument cluster: odometer and reset button

The distance driven is shown in miles “mi” or kilometers “km”. The measurement units (miles “mi” / kilometers “km”) can be changed in the MMI. For more information, refer to your MMI operating instructions.

### Odometer/trip odometer

Ⓐ - The odometer shows the total distance that the vehicle has been driven.

Ⓑ - The trip odometer shows the distance that the vehicle has been driven since the last time the trip odometer was reset. It can be used to

measure short distances. The last digit indicates 1/10 miles or 100 meter increments.

The trip odometer can be reset to zero by pressing the **[0.0]** button ⇒ page 10, fig. 3.

### Malfunction indicator

If there is a malfunction in the instrument cluster, **DEF** will appear in the trip odometer display. Have the malfunction repaired as soon as possible.

### i Tips

- When you switch the ignition off or open the driver's door, the odometer is displayed for approximately 30 seconds.
- You can also turn on the display with the **[0.0]** button when the ignition is switched off ⇒ page 10, fig. 3.

## Outside temperature display

The instrument cluster display shows the outside temperature. At temperatures below 41 °F (+5 °C), a snowflake symbol appears in front of the temperature display.

If your vehicle is stationary or if you are driving at very low speeds, the temperature displayed may be slightly higher than the actual temperature outside due to the heat radiating from the engine.

### ⚠ WARNING

Do not assume the roads are free of ice based on the outside temperature display. Be aware that there may be ice on roads even when the outside temperature is around 41 °F (+5 °C) and that ice can increase the risk of accidents.

### i Tips

You can change the measurement units, for example for temperature or speed, in the MMI.

## Fuel level

The display ⑥ ⇒ page 10, fig. 3 only works when the ignition is switched on. When the display has ▶



reached the reserve mark, the bottom LED will turn red and the  indicator light turns on ⇒ *page 23*. The bottom LED blinks red when the fuel level is very low.



The on-board computer shows the range based on the fuel level ⇒ *page 28, On-board computer display*.

For the tank capacity in your vehicle, refer to the Technical Data ⇒ *page 260*.

### Note

Never drive until the tank is completely empty. The irregular supply of fuel that results from that can cause engine misfires. Uncombusted fuel will then enter the exhaust system. This can cause overheating and damage to the catalytic converter.

## Coolant temperature indicator

In vehicles without a coolant temperature indicator, an indicator light  will turn on when the coolant temperature is too high ⇒ *page 19*. Refer to ⇒ .

The coolant temperature indicator  ⇒ *page 10, fig. 3* only works when the ignition is switched on. To prevent engine damage, please observe the following notes about the temperature ranges.

### Cold range

If only the LEDs at the bottom of the gauge turn on, the engine has not reached operating temperature yet. Avoid high engine speeds, full accelerating and heavy engine loads.

### Normal range

The engine has reached its operating temperature once the LEDs up to the center of the gauge turn on under normal driving conditions. The LEDs higher up may turn on if the engine is under heavy load or the outside temperature is high. This is no cause for concern as long as the  indicator light in the instrument cluster does not turn on.

### Hot range

If the LEDs in the upper area of the display and the  indicator light in the instrument cluster display turn on, the coolant temperature is too high ⇒ *page 19*.

### WARNING

- Never open the hood if you can see or hear steam or coolant escaping from the engine compartment. This increases the risk of burns. Wait until you no longer see or hear steam or coolant escaping.
- The engine compartment in any vehicle can be a dangerous area. Stop the engine and allow it to cool before working in the engine compartment. Always follow the information found in ⇒ *page 198, Working in the engine compartment*.

### Note

- In vehicles with a boost pressure indicator\*, this indicator replaces the temperature display. To promote a long engine service life, avoiding high engine speeds, full acceleration and heavy engine loads during approximately the first 15 minutes when the engine is cold is recommended. The amount of time until the engine is warm depends on the outside temperature. Check the engine oil temperature\* if necessary. ⇒ *page 30*
- Auxiliary headlights and other accessories in front of the cooling-air intake impair the cooling effect of the coolant. This increases the risk of the engine overheating during high outside temperatures and heavy engine load.
- The front spoiler also helps to distribute cooling air correctly while driving. If the spoiler is damaged, the cooling effect will be impaired and the risk of the engine overheating will increase. See an authorized Audi dealer or authorized Audi Service Facility for assistance.



**i** Tips

Diesel engines: Due to the high efficiency of these engines, the engine may not always reach operating temperature in cold outside temperatures. This is normal and not a cause for concern.

## Indicator lights

### Description



Fig. 6 Instrument cluster: example of a display in vehicles with a monochrome display

- (A) Indicator light
- (B) Message
- (C) Status line:
  - / Central indicator light or additional displays for active systems such as
  - **PARK** (USA models) / (Canada models) electromechanical parking brake
  - **CRUISE** (USA models) / (Canada models) cruise control system\*
  - / Active lane assist\*

The indicator lights in the instrument cluster blink or turn on. They indicate functions or malfunctions.

The **central indicator light** (C) or also turns on with some indicator lights (A).

If the central indicator light (C) turns on, check the additional information in the instrument cluster display (A) and (B).

In addition to the indicator lights in the display, there are additional indicators in the tachometer. They blink or turn on to indicate functions or malfunctions. Messages (B) may also appear briefly

with some indicator lights. A warning tone also sounds at the same time.

If there are multiple malfunctions, the indicator lights will appear briefly one after another in the display.

The indicators and messages in the display can be covered over by other displays. In cases where the indicator light (A) is covered over, the central indicator light (C) will remain visible until the malfunction is repaired.

The messages can be displayed again in the driver information system ⇒ page 28, Operation.

### Overview

Some indicator lights turn on briefly to check the function of that system when you switch the ignition on. These systems are marked with a ✓ in the following tables. If one of these indicator lights does not turn on, there is a malfunction in that system.

Your vehicle has either a monochrome display or a multicolored display, depending on vehicle equipment. In a monochrome display, the indicator lights (A) only appear in white ⇒ page 13, fig. 6. The central indicator light (C) / also appears to indicate the priority of these indicator lights. Refer to the explanations for red or yellow indicator lights.















Examples of indicator lights in a monochrome display:



















(A)	Priority 1 (high priority)
(C)	Refer to red indicator lights
(A)	Priority 2 (medium priority)
(C)	Refer to yellow indicator lights
(A)	Priority 3 (low priority)
-- (C)	These are informative indicator lights



## Instruments and indicator lights











### Red indicator lights

















	Central indicator light (note additional information in the instrument cluster display) © ⇒ page 13, fig. 6
<b>BRAKE</b>	<b>USA models:</b> Brake system ✓ ⇒ page 17
	<b>Canada models:</b> Brake system ✓ ⇒ page 17
<b>PARK</b>	<b>USA models:</b> Electromechanical parking brake ⇒ page 18
	<b>Canada models:</b> Electromechanical parking brake ⇒ page 18
	Cooling system ⇒ page 19
or	
	
	
	Engine oil pressure ⇒ page 19
or	
	
	
	Alternator ⇒ page 19
or	
	
	
	Front safety belt ⇒ page 20
	Steering ✓ ⇒ page 126

	Steering lock ⇒ page 20
	Engine start system ⇒ page 20
or	
	
	
	Engine stop while driving ⇒ page 20
or	
	
	
	Transmission malfunction ⇒ page 88
or	
	
	
	Adaptive cruise control* ✓ ⇒ page 98
	<b>USA models:</b> Speed warning system ⇒ page 94
	<b>Canada models:</b> Speed warning system ⇒ page 94
<b>AdBlue</b> 	Fill AdBlue* ⇒ page 195
or	
<b>AdBlue</b> 	
	
<b>AdBlue</b> 	AdBlue malfunction* ⇒ page 195
or	
<b>AdBlue</b> 	
	





































**Yellow indicator lights**

	Central indicator light (note additional information in the instrument cluster display) ⓘ ⇒ page 13, fig. 6
	Electronic Stabilization Control (ESC) ✓ ⇒ page 21
	Electronic Stabilization Control (ESC) ✓ ⇒ page 21
<b>ESC OFF</b>	Electronic Stabilization Control (ESC) ⇒ page 123
<b>ABS</b>	<b>USA models:</b> Anti-lock braking system (ABS) ✓ ⇒ page 21
	<b>Canada models:</b> Anti-lock braking system (ABS) ✓ ⇒ page 21
<b>AIR BAG</b>	<b>USA models:</b> Speed warning system ✓ ⇒ page 20
	<b>Canada models:</b> Speed warning system ✓ ⇒ page 20
	Brake pads ⇒ page 21
	Electromechanical parking brake ⇒ page 18
	Hill hold* ⇒ page 22
or	
	
	
	Tire pressure monitoring system ✓ ⇒ page 232
<b>TPMS</b>	Tire pressure monitoring system ⇒ page 232

	Adaptive dampers* ⇒ page 25
or	
	
	
<b>EPC</b>	Engine control (gasoline engine) ✓ ⇒ page 22
	Engine control (diesel engine) ✓ ⇒ page 22
	Emissions control system ✓ ⇒ page 22
	Diesel particulate filter* ⇒ page 22
or	
	
	
	Engine speed limitation ⇒ page 23
or	
	
	
	Engine oil level (min.) ⇒ page 23
or	
	
	
	Engine oil sensor ⇒ page 23
or	
	
	

## Instruments and indicator lights

	Engine temperature ⇒ page 19		Convenience key ⇒ page 77
or		or	
			
			
	Battery charge ⇒ page 19		Convenience key ⇒ page 77
or			Battery in remote control key ⇒ page 34
			Defective light bulb warning ⇒ page 24
		or	
	Tank system ⇒ page 23		
	Washer fluid level ⇒ page 24		
or			Headlight range control system* ⇒ page 24
		or	
	Windshield wipers ⇒ page 24		
or			
			Adaptive light* ⇒ page 24
		or	
	Steering ✓ / steering lock ⇒ page 126		
	Steering lock ⇒ page 20		
	Engine start system ⇒ page 20		Light/rain sensor* ⇒ page 24
or		or	
			
			
			Active lane assist* ⇒ page 107



	Transmission ⇒ page 88
or	
	Fill AdBlue* ⇒ page 195
or	
	AdBlue malfunction* ⇒ page 195
or	

Other indicator lights

	Turn signals ⇒ page 25
	<b>USA models:</b> Cruise control system* ⇒ page 94
	<b>Canada models:</b> Cruise control system* ⇒ page 94
	Adaptive cruise control* ⇒ page 98
	Adaptive cruise control* ⇒ page 98
	Adaptive cruise control* ⇒ page 98
	Active lane assist* ⇒ page 107
	High beams ⇒ page 45
	Convenience key ⇒ page 77

	Electromechanical parking brake ⇒ page 18
	Adaptive cruise control* ⇒ page 98
	Active lane assist* ⇒ page 107
	Audi side assist* ⇒ page 111
	Transmission ⇒ page 88
<b>PARK BRAKE</b>	<b>USA models:</b> Electromechanical parking brake ⇒ page 18
	<b>Canada models:</b> Electromechanical parking brake ⇒ page 18
	Fill AdBlue* ⇒ page 195

**BRAKE/!** Brake system

If this indicator light turns on, there is a malfunction in the brake system.

**BRAKE** (USA models) / (Canada models)  
**Please stop vehicle and check brake fluid level!**

Stop the vehicle and check the brake fluid level. See an authorized Audi dealer or authorized Audi Service Facility for assistance if necessary.

**BRAKE** (USA models) / (Canada models)  
**Warning! Brake servo inoperative!**

If brake assist (brake booster) is not working, you have to use much more force when braking the vehicle. See an authorized Audi dealer or authorized Audi Service Facility for assistance.

**BRAKE** (USA models) / (Canada models)  
**Warning! Fault in brake system. Please contact Service**

If the ABS indicator light **ABS** (USA models) / (Canada models), the ESC indicator light , and the brake system indicator light **BRAKE** (USA models) / (Canada models) turn on and this message appears, then the ABS, ESC and braking distribution are malfunctioning ⇒ .



Drive to your authorized Audi dealer or authorized Audi Service Facility immediately to have the malfunction corrected ⇒ .

### **BRAKE** (USA models) / (Canada models) Parking brake system fault! See owner's manual

- If the indicator light and the message appear **when the vehicle is stationary or after switching the ignition on**, check if you can release the parking brake. If you cannot release the parking brake, see your authorized Audi dealer or authorized Audi Service Facility. If you can release the parking brake and the message still appears, see an authorized Audi dealer or authorized Audi Service Facility immediately to have the malfunction corrected.
- If the indicator light and message appear **while driving**, the hill start assist or emergency braking function may be malfunctioning. It may not be possible to set the parking brake or release it once it has been set. Do not park your vehicle on hills and see an authorized Audi dealer or authorized Audi Service Facility for assistance.

If the **BRAKE** and  warning lights turn on together, take your vehicle to an authorized Audi dealer or authorized Audi Service Facility immediately to have the brake pads inspected ⇒ *page 21*.

There is also a warning tone when the lights turn on.

### **WARNING**

- Read and following the warnings in ⇒ *page 198, Working in the engine compartment* before opening the hood and checking the brake fluid level.
- If the brake system indicator light does not turn off or it turns on while driving, the brake fluid level in the reservoir is too low, and this increases the risk of an accident. Stop the vehicle and do not continue driving. See an authorized Audi dealer or authorized Audi Service Facility for assistance.
- If the brake system indicator light turns on together with the ABS and ESC indicator lights, the ABS/ESC regulating function may be malfunctioning. Functions that stabilize

the vehicle are no longer available. This could cause the rear of the vehicle to swerve, which increases the risk that the vehicle will slide. Drive carefully to the nearest authorized Audi dealer or authorized Audi Service Facility and have the malfunction corrected.

### **PARK**/ Electromechanical parking brake

If the **PARK** (USA models) /  (Canada models) indicator light turns on, the parking brake was set.

### **PARK** (USA models) / (Canada models) **Caution: Vehicle parked too steep**

If the indicator light blinks and the message appears, there is not enough braking power to secure the vehicle. The brakes have overheated. The vehicle could roll away even on a small incline.

### **PARK** (USA models) / (Canada models) **Please press brake pedal to release parking brake**

To release the parking brake, press the brake pedal and press the  button at the same time, or start driving with hill start assist ⇒ *page 80, Starting from a stop*.

### **Parking brake!**

There is a malfunction in the parking brake. Drive to an authorized Audi dealer or authorized Audi Service Facility immediately to have the malfunction corrected.

### **Parking brake: limited functionality!**

There is a malfunction in the parking brake. Drive to an authorized Audi dealer or authorized Audi Service Facility immediately to have the malfunction corrected.

### **PARK BRAKE** (USA models) / (Canada models) **Please release parking brake.**

Release the parking brake if this message appears.

### **PARK BRAKE** (USA models) / (Canada models) **Parking brake auto release unavailable** ▶



If this message appears, press the brake pedal first and then release the parking brake.

**PARK BRAKE** (USA models) /  (Canada models)

**Caution: Vehicle parked too steep**

If the indicator light blinks and the message appears, there is not enough braking power to secure the vehicle. The brakes have overheated. The vehicle could roll away even on a small incline.

**PARK BRAKE** (USA models) /  (Canada models)

**Parking brake is applied**

If this message appears, press the brake pedal first and then release the parking brake if necessary.

 **Tips**

For additional information on the parking brake, refer to  $\Rightarrow$  page 78.

 **Cooling system**

 **Switch off engine and check coolant level!**

The coolant level is too low or the coolant temperature is too high.

Do not continue driving and switch the engine off. Check the coolant level  $\Rightarrow$  page 205.

- If the coolant level is too low, add coolant  $\Rightarrow$  page 206. Only continue driving once the indicator light turns off.
- If the coolant is at the correct level, the problem may be caused by a malfunction in the radiator fan. Do not continue driving. See an authorized Audi dealer or authorized Audi Service Facility for assistance.

 **Coolant temperature too high! Let engine run with vehicle stationary**

Let the engine cool by running it in idle for a few minutes.

 **WARNING**

- Never open the hood if you can see or hear steam or coolant escaping from the engine compartment. This increases the risk of burns. Wait until you no longer see or hear steam or coolant escaping.

– The engine compartment in any vehicle can be a dangerous area. Stop the engine and allow it to cool before working in the engine compartment. Always follow the information found in  $\Rightarrow$  page 198, *Working in the engine compartment*.

 **Note**

Do not continue driving if the  indicator light turns on - this increases the risk of engine damage.

 **Engine oil pressure**

 **Switch off engine! Oil pressure too low**

Stop the engine and do not continue driving. Check the engine oil level  $\Rightarrow$  page 203.

- If the engine oil level is too low, add engine oil  $\Rightarrow$  page 201. Only continue driving once the indicator light turns off.
- If the engine oil level is correct and the indicator light still turns on, turn the engine off and do not continue driving. See an authorized Audi dealer or authorized Audi Service Facility for assistance.

 **Tips**

The oil pressure warning is not an oil level indicator. Always check the oil level regularly.

 **Alternator/battery**

 **Alternator fault: battery is not being charged**

There is a malfunction in the alternator or the vehicle electrical system.

Drive to an authorized Audi dealer or authorized Audi Service Facility immediately. Because the vehicle battery is draining, turn off all unnecessary electrical equipment such as the MMI. Seek professional assistance if the battery charge level is too low.

 **Low battery charge: Battery will be charged while driving**

The starting ability may be impaired. ▶



## Instruments and indicator lights



If this message turns off after a little while, the battery charged enough while driving.

If the message does not turn off, have an authorized Audi dealer or authorized Audi Service Facility repair the malfunction.

### Safety systems

The  (USA models) /  (Canada models) indicator light monitors the safety systems.

#### Safety system

If the  (USA models) /  (Canada models) indicator light turns on or blinks, there is a malfunction in a safety system.

Drive to an authorized Audi dealer or authorized Audi Service Facility immediately to have the malfunction corrected.

#### WARNING

Have the safety systems inspected immediately. Otherwise, there is a risk that the systems may not activate during a collision, which increases the risk of serious injury or death.

### Front safety belt

The  indicator light stays on until the driver's and front passenger's safety belts are buckled. Above a certain speed, there will also be a warning tone.

#### Tips

For additional information on safety belts, refer to *⇒ page 140*.

### Steering lock

#### Do not drive vehicle: steering defective

There is a malfunction in the electronic steering lock. You cannot turn the ignition on.

Do **not** tow your vehicle because it cannot be steered. See an authorized Audi dealer or authorized Audi Service Facility for assistance.

#### Steering lock: system fault! Please contact Service

There is a malfunction in the electronic steering lock.

Drive to an authorized Audi dealer or authorized Audi Service Facility immediately to have the malfunction corrected.

#### WARNING

Do not tow your vehicle when there is a malfunction in the electronic steering lock - this increases the risk of an accident.

### Engine start system

#### Engine start system malfunction. Please contact Service

Do **not** switch the ignition off because you may not be able to switch it on again.

Drive to an authorized Audi dealer or authorized Audi Service Facility immediately to have the malfunction corrected.

#### Engine start system malfunction. Please contact Service

There is a malfunction in the engine starting system.

- Vehicles with ignition lock *⇒ page 73, Automatic start malfunction*
- Vehicles with convenience key *⇒ page 76, Automatic start malfunction*

Drive to an authorized Audi dealer or authorized Audi Service Facility immediately to have the malfunction corrected.

### Engine

#### Engine stopped: brake servo and power steering not possible

There is a malfunction in the engine or in the fuel supply system.

More force is needed to steer and brake the moving vehicle when the engine is stopped. If the vehicle is rolling, try to bring it to a stop off to the side from moving traffic. See an authorized Audi ►



dealer or authorized Audi Service Facility for assistance.

 **WARNING**



If the engine stops while driving, you will need to use more force to brake the vehicle. This increases the risk of an accident. There will still be power steering if the ignition is switched on while the vehicle is rolling and there is sufficient battery charge. Otherwise, you must use greater force when steering.

 **Electronic stabilization control (ESC) and  anti-lock braking system (ABS)**

If the  indicator light blinks while driving, the ESC or ASR (Anti-Slip Regulation) is actively regulating.

If the  indicator light turns on, the system has switched the ESC off. In this case, you can switch the ignition off and then on to switch the ESC on again. The indicator light turns off when the system is functioning fully.

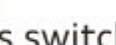
**Stabilization control (ESC): sport. Warning! Restricted stability**

If the  indicator light turns on, ESC sport mode was switched on using the  button ⇒ *page 124*. You can turn the ESC on again by press the  button again.

**Stabilization control (ESC): off. Warning! Restricted stability**

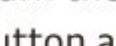

If the  indicator light turns on, the ESC was restricted or switched off using the  button ⇒ *page 124*. The message **ESC OFF** also appears. You can turn the ESC on again by press the  button again.

The system switched on when the ignition is switched on. The  indicator light turns off when the system is functioning fully.

**Stabilization control (ESC) malfunction! See owner's manual**

**Stabilization control (ESC/ABS) malfunction! See owner's manual**

**ABS malfunction! See owner's manual**

If the  indicator light and the ABS indicator light  (USA models) /  (Canada models) turn on and this message appears, there is a malfunction in the ABS system or electronic differential lock. This also causes the ESC to malfunction. The brakes still function with their normal power, but ABS is not active.

Drive to an authorized Audi dealer or authorized Audi Service Facility immediately to have the malfunction corrected.

 **WARNING**

If the **BRAKE** (USA models) /  (Canada models) brake system indicator light turns on together with the ABS and ESC indicator lights, the ABS/ESC regulating function may have failed. Functions that stabilize the vehicle are no longer available. This could cause the vehicle to swerve, which increases the risk that the vehicle will slide. Drive carefully to the nearest authorized Audi dealer or authorized Audi Service Facility and have the malfunction corrected.

 **Tips**

For additional information on ESC and ABS, refer to ⇒ *page 123*.

**BRAKE/ Brake pads**

**BRAKE** (USA models) /  (Canada models) **Brake pads!**

If the warning light illuminates, immediately contact your authorized Audi dealer or qualified workshop to have all brake pads inspected. Both sets of brake pads on an axle must always be replaced at the same time.

 **WARNING**

Driving with bad brakes can cause a collision and serious personal injury.



– If the warning light  or the warning light **BRAKE**<sup>1)</sup> with the message **Brake pads!** comes on in the instrument cluster display, immediately contact your authorized Audi dealer or qualified workshop to have all brake pads checked or replaced if necessary.

### Hill hold

#### Hill hold assist: unavailable

If the  indicator light turns on and this message appears, hill hold is not available.

#### Manual control!

If this message appears, press the brake pedal.

Continue driving with the help of the parking brake ⇒ *page 78*

### **EPC Engine control (gasoline engine)**

Applies to vehicles: with gasoline engine

If the **EPC** indicator light turns on if there is a malfunction in the engine control.

Drive slowly to an authorized Audi dealer or authorized Audi Service Facility to have the engine checked.

If the **EPC** indicator light turns on when you start the engine, there is an automatic start malfunction. To start the engine, follow these steps:

- Vehicles with a mechanical ignition  
⇒ *page 73, Automatic start malfunction*
- Vehicles with a convenience key ⇒ *page 76, Automatic start malfunction.*

### Engine control (diesel engine)

Applies to vehicles: with diesel engine

The engine is prewarming if the  indicator light turns on when the ignition is switched on.

If the indicator light blinks while driving, there is a malfunction in the engine control.

Drive slowly to an authorized Audi dealer or authorized Audi Service Facility to have the malfunction corrected.

If the  indicator light turns on when you start the engine, there is an automatic start malfunction. To start the engine, follow these steps:  
Vehicles with a mechanical ignition ⇒ *page 73*,  
vehicles with a convenience key ⇒ *page 76*

### System indicator light (MIL)

The system indicator light (MIL) is part of the On Board Diagnostic system (OBD II). The  symbol turns on when the ignition is switched on and turns off again once the engine is started and running at a steady idle speed. This indicates that the MIL is functioning correctly.

The indicator light turns on if there is a malfunction in the engine electronics. See an authorized Audi dealer or authorized Audi Service Facility to have the malfunction corrected.

The system indicator light (MIL) may turn on if the fuel filler cap is not closed correctly  
⇒ *page 192*.

For additional information, refer to ⇒ *page 25*.

### Diesel particulate filter

Applies to vehicles: with diesel engine and diesel particulate filter

#### Particulate filter: System fault See owner's manual

The diesel particulate filter requires regeneration. To support the filter's self-cleaning function:

Drive for approximately 15 minutes at 40 mph (60 km/h) or above in the S selector lever position. Keep the engine speed around 2,000 RPM. The temperature increase that will result from this can burn off the soot in the filter. The indicator light will turn off when the cleaning has completed successfully. ▶

1) **BRAKE**: USA models only



If the indicator light does **not** turn off, drive immediately to an authorized Audi dealer or authorized Audi Service Facility to have the malfunction corrected.

 **WARNING**

Always adapt your speed to the current weather, road and traffic conditions. You should never disobey traffic laws in order to follow driving recommendations.

 **Tips**

For additional information on the diesel particulate filter, refer to ⇨ *page 195*.

 **Engine speed limitation**

Applies to vehicles: with engine speed limitation

 **Max. engine speed: XXXX rpm**

The engine speed is automatically limited to the speed displayed in the driver information system. This protects the engine from overheating.

The engine speed limitation deactivates once the engine is no longer in the critical temperature range and you have released the accelerator pedal once.

If the engine speed limitation was activated by an engine control malfunction, the **EPC** indicator light also turns on. Make sure the engine speed does not go above the speed displayed, for example when downshifting. Drive to an authorized Audi dealer or authorized Audi Service Facility immediately to have the malfunction corrected.

 **Engine oil level (min.)**

 **Check oil level**

You may continue driving for the time being. Check the oil level as soon as possible ⇨ *page 201*.

- If the engine oil level is too low, add engine oil ⇨ *page 203*.
- If the engine oil level is correct and the indicator light still turns on, drive at low engine speed to an authorized Audi dealer or authorized Audi Service Facility.

 **Engine oil sensor**

 **Oil level sensor: system fault!**

The sensor to check the engine oil level has failed. Drive to an authorized Audi dealer or authorized Audi Service Facility immediately to have the malfunction corrected.

 **Oil level sens.: oil change necessary. Please contact Service**

The engine oil level is too high.

Drive to an authorized Audi dealer or authorized Audi Service Facility immediately to have the malfunction corrected.

 **Note**

Refer to the description in the Owner's Manual ⇨ *page 203, Checking the engine oil level* and ⇨ *page 203, Adding engine oil* .

 **Tank system**

 **Please refuel**

If the indicator light first turns on and this message appears, the tank contains the following amount of fuel:

- Front wheel drive: approximately 1.8 gallons (7 liters)
- All wheel drive: approximately 2.2 gallons (8.5 liters)

 **Please refuel immediately**

If the indicator light turns on the message appears, the fuel tank is almost empty. Refuel the vehicle immediately.

 **Fuel tank malfunction! Please contact Service**

If the indicator light turns on and the message appears:

- there is a malfunction in the fuel tank system, or
- in vehicles with diesel engines, water may have collected in the fuel filter. ▶



Drive to an authorized Audi dealer or authorized Audi Service Facility immediately to have the malfunction corrected.

### Note

Applies to vehicles with diesel engines: If the diesel fuel quality is poor, it may be necessary to have the water drained from the water separator <sup>1)</sup> in the **fuel filter** more often than specified in the maintenance schedule. This can help reduce engine malfunctions.

### For the sake of the environment

Fuel should never enter the sewer system or come into contact with the ground.

### Tips

More information on refueling is available on page ⇨ *page 192*.

## Washer fluid level

### Please add washer fluid

Fill the washer fluid with the ignition switched off ⇨ *page 212*.

## Windshield wipers

### Windshield wiper: system fault!

There is a malfunction with the windshield wipers.

Drive to an authorized Audi dealer or authorized Audi Service Facility immediately to have the malfunction corrected.

## Defective light bulb warning

Applies to vehicles: with driver information system

If the  indicator light turns on, a bulb has failed. The message indicates the location of the bulb.

Replace the bulb immediately.

### **Vehicle lights: system fault!**

There is a malfunction in the headlights or the light switch. Drive to an authorized Audi dealer or authorized Audi Service Facility immediately to have the malfunction corrected.

### WARNING

- Light bulbs are under pressure and can explode when bulbs are replaced - risk of injury.
- With gas-discharge lamps\* (xenon headlights), the high-voltage component must be handled appropriately. Otherwise, there is a risk of fatal injury.

## Dynamic Headlight range control system

Applies to vehicles: with Xenon lights

### Headlight range control system: system fault!

There is a malfunction in the dynamic headlight range control system, which may cause glare for other drivers.

Drive to an authorized Audi dealer or authorized Audi Service Facility immediately to have the malfunction corrected.

## Audi adaptive light

Applies to vehicles: with Audi adaptive light

### Audi adaptive light: system fault!

There is a malfunction in the adaptive lights. The headlights still function.

Drive to an authorized Audi dealer or authorized Audi Service Facility immediately to have the malfunction corrected.

## Light/rain sensor

Applies to vehicles: with light/rain sensor

### Automatic headlights: system fault!

### Automatic wipers: system fault!

The light/rain sensor is malfunctioning.

For safety reasons, the low beams are turned on permanently with the switch in **AUTO**. You can ▶

<sup>1)</sup> This function is not available in all countries.



continue to turn the lights on and off using the light switch. You can still control all wiper functions that are independent of the rain sensor.

Drive to an authorized Audi dealer or authorized Audi Service Facility immediately to have the malfunction corrected.

### Adaptive dampers



Applies to vehicles: with Audi drive select

### Suspension: system fault!

There is an adaptive damper malfunction.

Drive to an authorized Audi dealer or authorized Audi Service Facility immediately to have the malfunction corrected.

### Turn signals

If the  or  indicator light blinks, a turn signal is turned on. If both indicator lights are blinking, the emergency flashers are on.

If an indicator light blinks twice as fast as usual then a blinker bulb has failed. Carefully drive to your authorized Audi dealer immediately to have the malfunction corrected.

### Tips

For more information on the turn signals, refer to *⇒ page 45*.

## On-Board Diagnostic system (OBD)

### System indicator light (MIL)

The system indicator light (MIL)  in the instrument cluster is part of the On Board Diagnostic System (OBD II).

The warning/indicator light turns on when the ignition is switched on and turns off once the engine is started and is running in idle at a stable speed. This indicates that the MIL is functioning correctly.

**If the light does not turn off after starting the engine** or turns on while driving, this may indicate there is a malfunction in the engine. If the

indicator turns on, the catalytic converter may be damaged.

Drive **with reduced engine performance** (avoid high speeds for extended periods of time and/or fast acceleration) and have the malfunction corrected. See an authorized Audi dealer or authorized Audi Service Facility.

The indicator may turn on if the electronic speed limiter is faulty. For additional information, refer to *⇒ page 94, Electronic speed limiter\**.

**The MIL may also turn on if the fuel filler cap is not closed correctly** *⇒ page 192*.

### On-Board Diagnostics



Fig. 7 Location of Data Link Connector (DLC)

On-Board Diagnostics monitors the components of your emission control system. Each monitored component in your engine system has been assigned a code. In case of a malfunction, the component will be identified and the fault stored as a code in the control module memory.

The MIL light may also illuminate if there is a leak in the on-board fuel vapor recovery system. If the light illuminates after a refuelling, stop the vehicle and make sure the fuel filler cap is properly closed *⇒ page 192*.

In order to make an accurate diagnosis, the stored data can only be displayed using special diagnostic equipment (generic scan tool for OBD).

In order to connect the special diagnostic equipment, push the plug into the Data Link Connector (DLC). The DLC is located to the right of the hood release *⇒ fig. 7*.

Your authorized Audi dealer or a qualified service station can interpret the code and perform the necessary repair.

 **WARNING**

Do not use the diagnostic connector for personal use. Incorrect usage can cause malfunctions, which can increase the risk of a collision!



# Driver information system

## Overview

Applies to vehicles: with driver information system

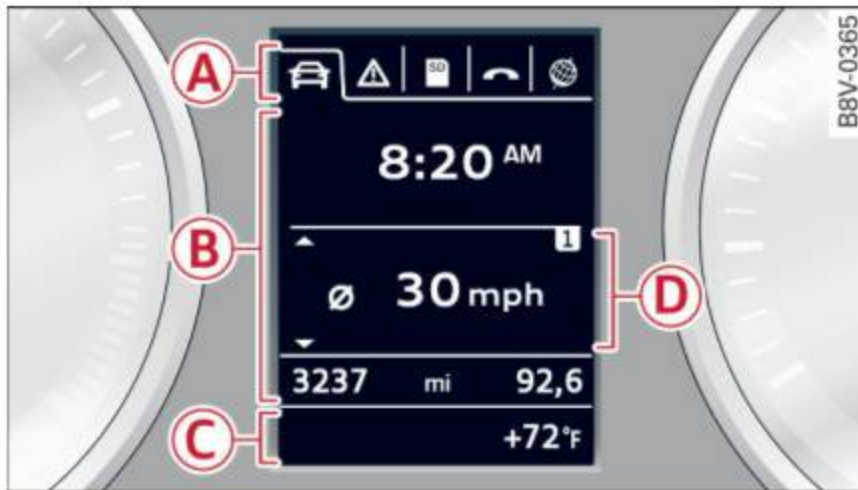

Fig. 8 Instrument cluster: driver information system (example)

Data is automatically recorded, processed and displayed in the driver information system. Settings for special equipment can be adjusted in the MMI. Select the **MENU** button > **Car** > **Systems\*** control button.

### Introduction

The driver information system is controlled through the multifunction steering wheel ⇒ page 28, fig. 9.

The Driver Information System ⇒ fig. 8 contains the following information:

- **A** Tab (register)
- **B** Vehicle information
- **C** Status line (selector lever position, outside temperature ⇒ page 11)
- **D** On-board computer

The following functions are possible, depending on vehicle equipment:

<b>A</b>	<b>B</b>
First tab	<b>Vehicle functions:</b> On-board computer, time, date ⇒ page 28 Efficiency program ⇒ page 29 Digital speedometer Assist Audi adaptive cruise control* ⇒ page 96 Audi active lane assist* ⇒ page 106 Lap timer* ⇒ page 30 Reduced display
Second tab	📞 / ⚠ Messages and indicator lights 🔑 Service reminder indicator ⇒ page 212
Third tab	🎵 / 📁 Audio / 📻 Radio
Fourth tab	☎ Telephone*
Fifth tab	🌐 / 🗺 Navigation*

The second tab is only visible if at least one indicator light or message is shown or if that system is switched on.

### Display

In the driver information system you will see:

Radio station or CD	
time and date	⇒ page 10
Odometer, trip odometer	⇒ page 11
Outside air temperature	⇒ page 11
Service interval display	⇒ page 212
Indicator lights and messages	⇒ page 13
Digital speedometer	
Lap timer*	⇒ page 30
Cruise control system	⇒ page 94
Speed warning	⇒ page 94
Selector lever positions	⇒ page 82
On-board computer display	⇒ page 28



### On-board computer display

The on-board computer display monitors the different memory levels:

- Short-term memory (on-board computer 1)
- Long-term memory (on-board computer 2)
- Efficiency program

The following information can be displayed in on-board computer 1 and 2 one after the other.

- Date
- Estimated range based on current fuel level
- Travel time
- Average consumption
- Average speed
- Distance
- Current fuel consumption
- Engine oil temperature indicator\*

### On-board computer 1 (short-term memory)

The short-term memory collects driving information from the time the ignition is switched on until it is switched off. If you continue driving **within two hours** after switching the ignition off, the new values are included when calculating the current trip information. If stopped for more than two hours, the short term memory is automatically erased once you begin driving.

### On-board computer 2 (long-term memory)

Unlike the short-term memory, the long-term memory is not erased automatically. You can select the time period for evaluating trip information yourself.

### Efficiency program

The efficiency program can help you to use less fuel ⇒ *page 29*.

#### Tips

- The on-board computer is controlled by the left button fields on the multifunction steering wheel.
- For information on using the other button fields, such as the audio, telephone\* and navigation\* functions, see the MMI owner's manual.

## Operation

Applies to vehicles: with driver information system

*The driver information system is controlled with the multifunction steering wheel.*



**Fig. 9** Multifunction steering wheel: driver information system controls

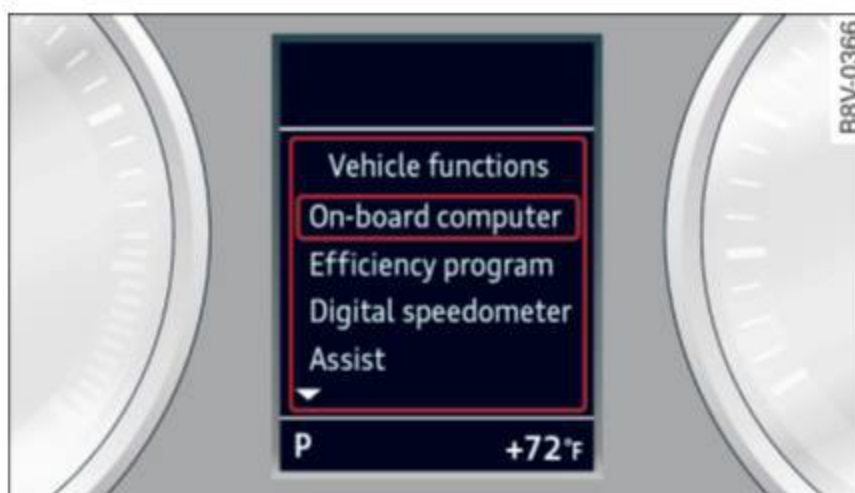

**Fig. 10** Driver information system: calling up the vehicle functions menu

In addition to information about the on-board computer (on-board computer 1, 2 and the efficiency program), information about other systems can also be shown in the display.

You can identify which level (on-board computer 1, 2 or the efficiency program) is shown in the display based on the small **1**, **2** or the nozzle .

The tab **A** ⇒ *page 27, fig. 8* is displayed once you press the button **1** ⇒ *fig. 9* on the multifunction steering wheel.

### Operating

- ▶ Switch on the ignition. The last select function is displayed.
- ▶ To switch between the tabs, press the rocker button **1** to the left or right ⇒ *fig. 9*.
- ▶ To access additional information below or above, rotate the thumbwheel **2** down or up. ▶



- ▶ To confirm a selection, press the thumbwheel ②.
- ▶ To select a function programmed to a steering wheel button, press the button ④. For additional information, see ⇒ page 29, *Assigning a function to a programmable steering wheel button*

### Opening the Vehicle functions

- ▶ Select the first tab with the button ①.
- ▶ Press the button ③. The **Vehicle functions** menu is displayed ⇒ fig. 10.
- ▶ To select a menu item, turn and press the thumbwheel ②.

### Resetting values to zero

- ▶ In the **Vehicle functions** menu, select **On-board computer** or **Efficiency program**.
- ▶ Select a value in the desired trip computer or in the efficiency program.
- ▶ To reset the values in a memory, press and hold the thumbwheel ② for one second.

### Recalling indicator lights and messages

- ▶ Press the button ① repeatedly until the  tab appears.

The  tab is only visible when there is a malfunction.

### Assigning a function to a programmable steering wheel button

- ▶ Select: the **MENU** button > **Car** > **Systems\*** control button > **Vehicle settings** > **Steering wheel button programming**.

The  tab is only visible when there is at least one indicator light or message displayed.

#### Tips

- If the vehicle battery is disconnected, all memory values are erased.
- Information on the efficiency program ⇒ page 29.
- There is more information on the multifunction steering wheel in the MMI\* owner's manual.

## Boost indicator

Applies to vehicles: with boost pressure indicator



Fig. 11 Instrument cluster: boost indicator

### Boost pressure indicator (boost)

A bar graph that begins on the left and fills in toward the right indicates the engine's current load (meaning the current boost pressure).

## Efficiency program

### Description

Applies to vehicles: with driver information system



Fig. 12 Instrument cluster: efficiency program (example)

### Calling up the efficiency program

- ▶ Call up the vehicle functions by pressing the button ③ ⇒ page 28, fig. 9 and select the menu item **Efficiency program** ⇒ page 29.

The efficiency program can help you to use less fuel. It evaluates driving information in reference to fuel consumption and shows other equipment influencing consumption ⇒ page 30. Fuel economy messages ⇒ page 30 provide tips for efficient driving.

The efficiency program receives data about the distance and fuel consumption from the on-board computer 1. If the data in the efficiency



program is deleted ⇒ *page 29*, the values in the on-board computer 1 are also reset.

### Other equipment

Applies to vehicles: with driver information system

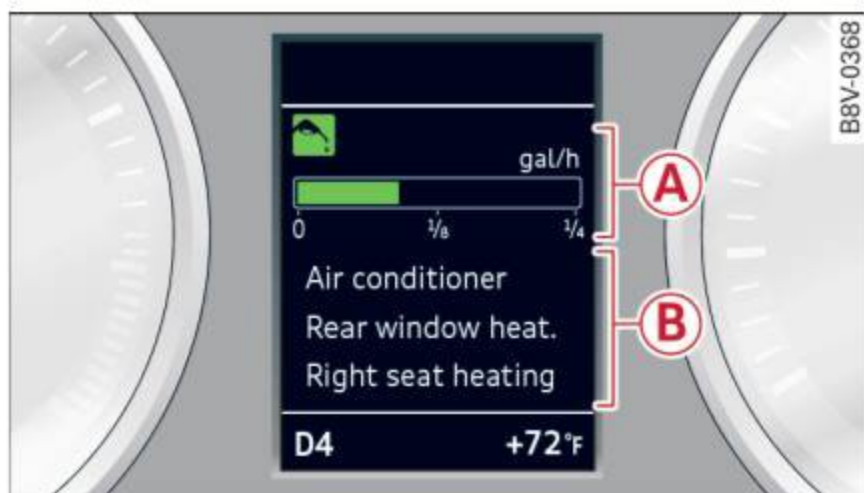

Fig. 13 Instrument cluster: Other equipment (example)

- ▶ Turn the menu thumbwheel ② ⇒ *page 28*, *fig. 9* until the other equipment affecting consumption appears.

Other equipment that is currently affecting fuel consumption is listed in the efficiency program. The display shows up to three other items of equipment (B). The equipment using the most fuel is listed first. If more than three items using fuel are switched on, the equipment that is currently using the most fuel is displayed.

A scale (A) also shows the current total consumption of all other equipment.

### Fuel economy messages

Applies to vehicles: with driver information system

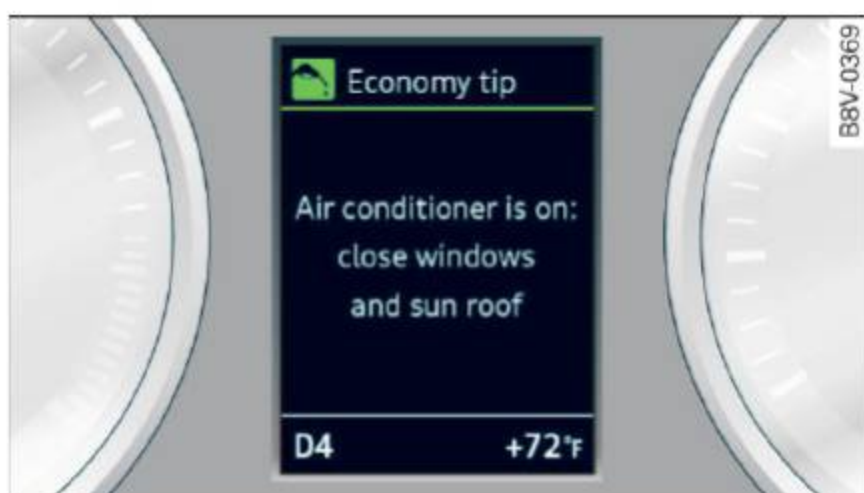

Fig. 14 Instrument cluster: economy tip (example)

Fuel economy messages are displayed when fuel consumption is increased by certain conditions. If you follow these economy tips, you can reduce your vehicle's consumption of fuel. The messages

appear automatically and are only displayed in the efficiency program. The fuel economy messages turn off automatically after a certain period of time.

- ▶ To turn an economy message off immediately after it appears, press any button on the multi-function steering wheel.

### i Tips

- Once you have turned an economy tip off, it will only appear again after you turn the ignition on again.
- The economy tips are not displayed in every instance, but rather in intervals over a period of time.

## Lap timer and engine oil temperature indicator

### Introduction

Applies to vehicles: with lap timer (S models)

The engine oil temperature is only shown in the lap timer display.

### Lap timer

You can record and evaluate lap times with the lap timer in the display ⇒ *page 31*, *fig. 16*. The time is measured in minutes, seconds and 1/10 seconds. With lap times longer than 60 minutes, the hour is also shown and the display of 1/10 seconds is removed.

The time measurement on an individual lap ends after 99 hours 59 minutes and 59 seconds. A new lap starts automatically after that.



The measurement ends after a maximum of 30 laps. You can then evaluate the lap times or start a new time measurement.

### Engine oil temperature indicator

If the engine oil temperature is below 140 °F (60 °C), the  symbol followed by three hyphens “- - -” and the °C unit is shown.

The engine has reached its operating temperature when the engine oil temperature is between **176 °F (80 °C)** and **248 °F (120 °C)** under normal driving conditions. The engine oil



temperature may be higher if there is heavy engine load and high temperatures outside. This is not a cause for concern as long as the  ⇒ page 19 or  ⇒ page 23 indicator lights in the display do not blink.

**! WARNING**

Your focus should always be on driving your vehicle safely. As the driver, you have complete responsibility for safety in traffic. Only use the functions such as the lap timer in such a way that you always maintain complete control over your vehicle in all traffic situations.

**i Tips**

You can retrieve information from the trip computer while the lap timer stopwatch is running.

**Opening the lap timer and measuring time**

Applies to vehicles: with lap timer (S models)



Fig. 15 Multifunction steering wheel: controls



Fig. 16 Instrument cluster: lap timer



**Opening the lap timer**

- ▶ Press the button **B** on the multifunction steering wheel and turn the thumbwheel **A** ⇒ fig. 15 until **Lap timer** ⇒ fig. 16 appears.

- ▶ Press the thumbwheel **A** to confirm the selection.

**Timing laps**

- ▶ To start timing, press the thumbwheel **A** while on the menu item **Lap 1 - press OK**. The time measurement is shown in line **3** ⇒ fig. 16.
- ▶ To measure the lap time, press the thumbwheel **A** again while on the menu item **New lap - press OK**. This also starts timing the next round. The last time measurement moves up to the top line **1**. Line **3** contains the current lap time.

If the symbol  is green during the current lap time measurement, the current time is faster than the previous best time. If the symbol  is red, the current time is slower **2**.

**Displaying split time and pausing timing**





- ▶ To display a split time , turn the thumbwheel **A** until **Split time** appears in line **4**. Press the thumbwheel **A** to confirm the selection. The split time appears for approximately 10 seconds in line **3**. The timing of the current lap continues.

If you would like to insert a pause  immediately after the split time, first press the thumbwheel **A** and then the menu item **Press OK to go back** to confirm.

- ▶ To insert a pause, turn the thumbwheel **A** until **Pause** appears in the line **A**. Press the thumbwheel **A** to confirm the selection. The pause symbol  appears in line **3**.
- ▶ To continue timing, press the thumbwheel **A**.

If timing is paused, you can continue it later even if you switch the ignition off.

Meaning of the indicators in the center display ⇒ fig. 16:

<b>1</b>	Display of last time measurement
<b>2</b>	Symbols: <ul style="list-style-type: none"> <li>- : Beginning of time measurement</li> <li>- : Slowest time</li> <li>- : Fastest time</li> <li>- : Split time</li> <li>- : Pause</li> </ul>



③	Current time measurement
④	Menu: - Lap 1 (start) - New lap (start another lap) - Split time (time within section of the route) - Pause (interrupts measurement) - Statistics (evaluation of lap times) - Reset (all values are deleted)

### Evaluating or resetting recorded times

Applies to vehicles: with lap timer (S models)

You can evaluate the fastest, slowest and average lap times.

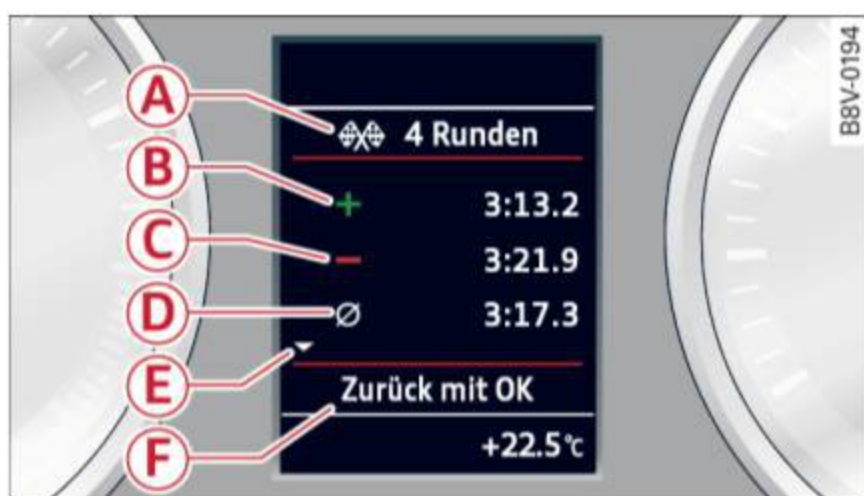

Fig. 17 Instrument cluster: Evaluating recorded times

After evaluating the lap times, you can continue the current timing round or start over, meaning start lap 1 again.

- ▶ To evaluate the time measurement, turn the thumbwheel (A) ⇒ page 31, fig. 15 until **Statistics** appears in line (4) ⇒ page 31, fig. 16. Press the thumbwheel (A) to confirm the selection. The display shows the fastest lap “+”, the slowest lap “-” and the average lap time “Ø”. To display the individual lap times, turn the thumbwheel (A) downward ▼ or upward ▲.
- ▶ To continue the lap measurement that was started, press the thumbwheel (A).
- ▶ To reset the time measurement to zero, first press the thumbwheel (A), then turn the thumbwheel (A) ⇒ page 31, fig. 15 until **Reset** appears in line (4) ⇒ page 31, fig. 16. Press the thumbwheel (A) to confirm the selection.
- ▶ To restart the lap timer for the new lap measurement, press the thumbwheel (A).

- ▶ To exit the lap timer, press the button (B) on the multifunction steering wheel and keep turning the thumbwheel (A) ⇒ page 31, fig. 15 until a new menu item appears. Press the thumbwheel (A) to confirm the selection.

Explanation of the evaluation ⇒ fig. 17:

(A)	All laps
(B)	+: Fastest lap time
(C)	-: Slowest lap time
(D)	Ø: Average lap time
(E)	▲/▼: up/down to other pages
(F)	Delete the entries or reset the lap/time measurement

### i Tips

- Saved lap times cannot be individually deleted from the total results.
- The saved lap timer values will remain after switching the ignition off.



## Opening and closing

### Central locking

#### Key set



Fig. 18 Your vehicle key set

The key set contains two remote control keys or convenience keys\*. To fold the key out and back in place, press the release button ⇒ *fig. 18* -arrow-.

#### Remote control key or convenience key

The convenience key is a vehicle remote control key with special functions ⇒ *page 36, Locking and unlocking with the convenience key* and ⇒ *page 75, Starting and stopping the engine (vehicles with a convenience key)*.

With the remote control key, you can lock and unlock the vehicle centrally and start the engine.

#### Number of keys

You can check the number of keys assigned to your vehicle in the MMI. This allows you to make sure you have received all of the keys when you purchase a used vehicle. Select: the **MENU** button > **Car** > **Systems\*** control button > **Programmed keys**.

#### Replacing a key

If a key is lost, see an authorized Audi dealer or authorized Audi Service Facility. Have *this* key deactivated. It is important to bring all keys with you. If a key is lost, you should report it to your insurance company.

#### Immobilizer

The immobilizer prevents unauthorized use of the vehicle. The vehicle may not start if another

radio device such as a key for another vehicle or a transponder is located on the key ring.

#### Data in the remote control key or convenience key

While driving, service and maintenance-relevant data is continuously stored on your remote control key or convenience key\*. Your Audi service advisor can read out this data and tell you about the work your vehicle needs.

#### WARNING

- Always take the vehicle key with you when leaving the vehicle, even for a short period of time. This applies particularly when children remain in the vehicle. Otherwise the children could start the engine or operate electrical equipment such as power windows.
- Do not remove the key from the ignition lock until the vehicle has come to a complete stop. Otherwise, the steering lock could engage suddenly and increase the risk of an accident.

#### Tips

The operation of the remote control key can be temporarily disrupted by interference from transmitters in the vicinity of the vehicle working in the same frequency range (e.g. a cell phone, radio equipment).

#### Central locking system description

You can lock and unlock the vehicle centrally. There are different ways, depending on vehicle equipment:

- Remote control key ⇒ *page 35*,
- Lock cylinder on the driver's door ⇒ *page 37*, or
- Sensors in the front door handles on vehicles with a convenience key\* ⇒ *page 36*,
- Central locking switch inside ⇒ *page 37*.

#### Selective unlocking

The doors and luggage compartment lid lock when they close. You can set in the MMI whether ►



## Opening and closing

only the driver's door or the entire vehicle should unlock when unlocking ⇒ page 37.

### Automatic locking (Auto Lock)

The Auto Lock function locks all doors and the luggage compartment lid once the speed has exceeded approximately 9 mph (15 km/h).

The car is unlocked again once the ignition key is removed. In addition, the vehicle can be unlocked if the opening function in the power locking system switch is used or one of the door handles is pulled.\*

Additionally, in the event of a crash with airbag deployment the doors are automatically unlocked to allow access to the vehicle.

### Anti-theft alarm system\*

If the anti-theft alarm system detects a vehicle break-in, audio and visual warning signals are triggered.

The anti-theft alarm system turns on automatically when you lock the vehicle. It deactivates when unlocking using the remote control key or by touching the sensor on the door handle (convenience key).

To switch the alarm off, press the  button on the remote control key or convenience key or switch the ignition on. The alarm also stops automatically after a certain amount of time.

### Turn signals

When you unlock the vehicle, the turn signals flash twice. When you lock the vehicle, the turn signals flash once.

If they do not flash, one of the doors, the luggage compartment lid or the hood is not locked or the ignition is still switched on (the latter applies to vehicles with a convenience key).

### Unintentionally locking yourself out

In the following cases there are safeguards to prevent you locking your remote master key in the vehicle:

- The vehicle does not lock with the central locking switch if the driver's door is open ⇒ page 37.

- On vehicles with a convenience key\*, the luggage compartment lid unlocks again after closing if the most recently used key is in the luggage compartment.

Do not lock your vehicle with the remote control key or convenience key\* until all doors and the luggage compartment lid are closed. In this way you avoid locking yourself out accidentally.

### Tips

- Do not leave valuables unattended in the vehicle. A locked vehicle is not a safe!
- If the LED in the upper edge of the driver's door turns on for about 30 seconds after the vehicle is locked, there is a malfunction in the power locking or the anti-theft alarm system\*. Have the problem corrected by an authorized Audi dealer or authorized Audi Service Facility.

### LED and batteries in the remote control key

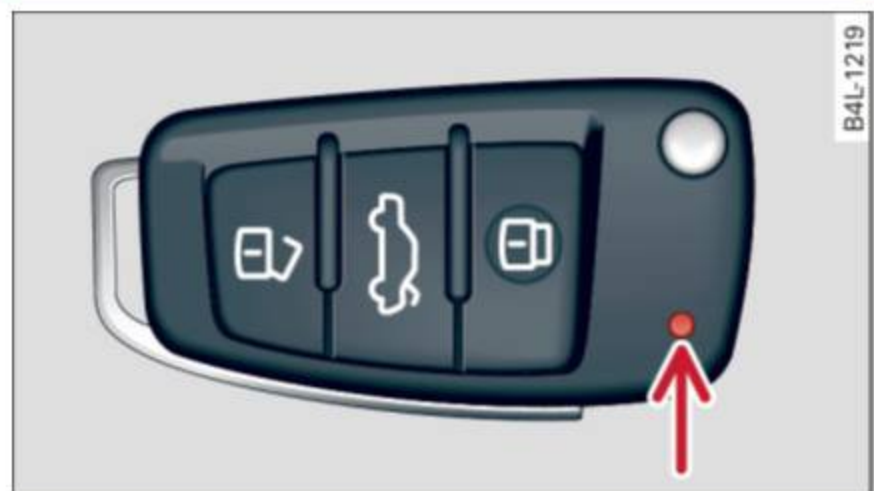

Fig. 19 Remote control key: LED

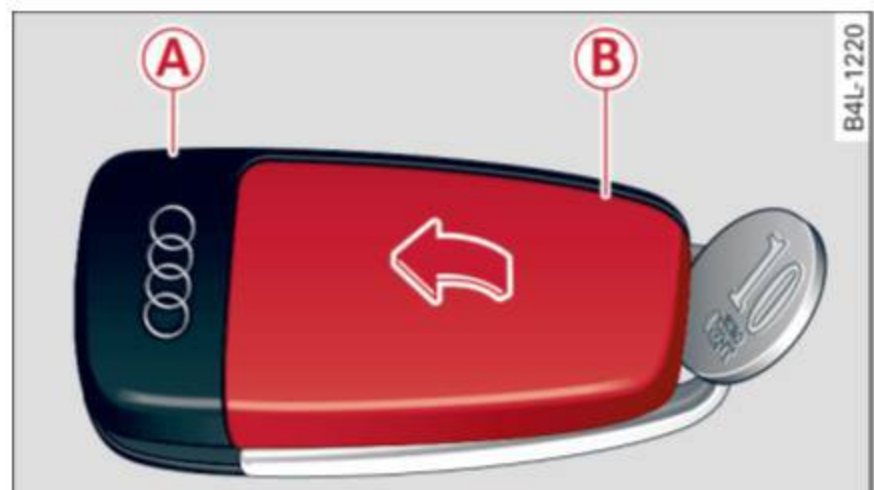



Fig. 20 Remote control key: opening the cover

### LED in the remote control key

The LED ⇒ fig. 19 can tell you about the function of the remote control key.



- ▶ If you press a button quickly, the LED blinks once.
- ▶ If you press a button longer (convenience opening\*), the LED blinks several times.
- ▶ If the LED does not blink, the remote control key battery is dead. The message  **Please change key battery** can also appear in the instrument cluster display. Replace the battery.

### Replacing the remote control key battery

- ▶ Pry off the cover with a coin ⇒ *fig. 20*.
- ▶ Insert the new battery with the “+” facing up.
- ▶ Press the cover back onto the key until it clicks into place.

We recommend having the battery replaced by an authorized Audi dealer or authorized Audi Service Facility.



#### For the sake of the environment

Dead batteries must be disposed of using methods that will not harm the environment. Do not dispose of them in household trash.





#### Tips

The replacement battery must meet the same specifications as the original battery.

### Remote control key synchronization



The remote control key must be synchronized if the vehicle does not lock and unlock with the remote control.





- ▶ Press the remote control key button .
- ▶ Insert the key in the driver door lock within 30 seconds.
- ▶ Press the  button or  button.

### Unlocking/locking by remote control



Fig. 21 Remote control key or convenience key: buttons

- Ⓐ  Open
- Ⓑ  Close
- Ⓒ  Unlock luggage compartment lid
- Ⓓ **PANIC** Trigger the alarm

- ▶ To unlock the vehicle, press the button Ⓐ  ⇒ *fig. 21*.
- ▶ To lock the vehicle, bring the selector lever into the P position and press the  button Ⓑ.
- ▶ To unlock the luggage compartment lid, press the  button Ⓒ briefly.
- ▶ To open the luggage compartment lid, press and hold the  button Ⓒ for at least one second.
- ▶ To trigger the alarm, press the red **PANIC** button Ⓓ. The vehicle horn and emergency flashers turn on.
- ▶ To turn off the alarm, press the red **PANIC** button Ⓓ again.

If the vehicle is unlocked and a door or the luggage compartment lid are not opened within 45 seconds, the vehicle locks again automatically. This feature prevents the vehicle from being accidentally left unlocked over a long period of time. This does not apply if you press the  button Ⓒ for at least one second.

For vehicles with **safety central locking** (selective unlocking) ⇒ *page 38*, only the driver's door and the fuel filler door are opened by pressing the  button Ⓐ once, and the entire vehicle unlocks when the button is pressed twice. ▶



### **WARNING**

Read and following all WARNINGS. ⇨  in Key set on page 33

### **Tips**

- Only use the remote control key or convenience key within view of the vehicle.
- Do not use the remote control when you are inside the vehicle. Otherwise, you could unintentionally lock the vehicle. If you then tried to start the engine or open a door, the alarm would be triggered. If this happens, press the unlock button .
- The vehicle can only be locked when the selector lever is in the P position.
- Only use the panic function in an emergency.
- For information on additional remote control key or convenience key functions, refer to ⇨ page 41, Convenience opening/closing.

### Locking and unlocking with the convenience key

Applies to vehicles: with convenience key

The front doors and the luggage compartment lid can be unlocked and locked without using the remote control key.

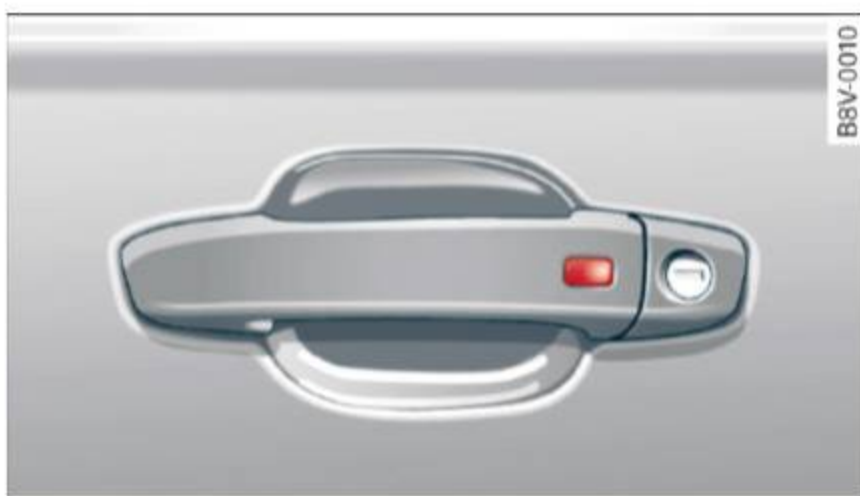

**Fig. 22** Driver's door: locking the vehicle with the convenience key

- ▶ To unlock the door automatically, grasp the driver's or front passenger's door handle ⇨ fig. 22.
- ▶ To open the door, pull the door handle.

- ▶ To unlock or open the luggage compartment lid, press the handle in the luggage compartment lid ⇨ page 39, fig. 26.
- ▶ To lock the vehicle, bring the selector lever into the P position, close the door and touch the sensor on the driver's door handle **one** time. Do not hold the door handle while doing this.

Only the front doors and luggage compartment lid can be unlocked or locked. The remote control key must be within a range of about 5 ft (1.5 m) from the door or the luggage compartment lid. It makes no difference whether the remote control key is in your jacket pocket, purse or briefcase.

If you grip the door handle while locking, this can adversely affect the locking function.

The door cannot be opened for a brief period directly after locking it. This allows you the opportunity to check that the driver's door is locked.

The settings in the MMI specify if the entire vehicle or one of the doors is unlocked when unlocking the vehicle ⇨ page 37.

### **WARNING**

Read and following all WARNINGS. ⇨  in Key set on page 33

### **Tips**

If your vehicle is left standing for a long period of time, note the following:

- The proximity sensor switches off after a few days to save energy. You then have to pull once on the door handle to unlock the vehicle and a second time to open it.
- To prevent the battery from draining and to retain the starting ability of your vehicle as long as possible, the energy management system gradually turns off unnecessary convenience functions. You may not be able to unlock your vehicle using the convenience key.
- For an explanation on conformity with the FCC regulations in the United States and the Industry Canada regulations, refer to ⇨ page 265.



## Unlocking/locking with the key

In the event that the power locking system fails, the driver's door can be locked and unlocked using the door lock.

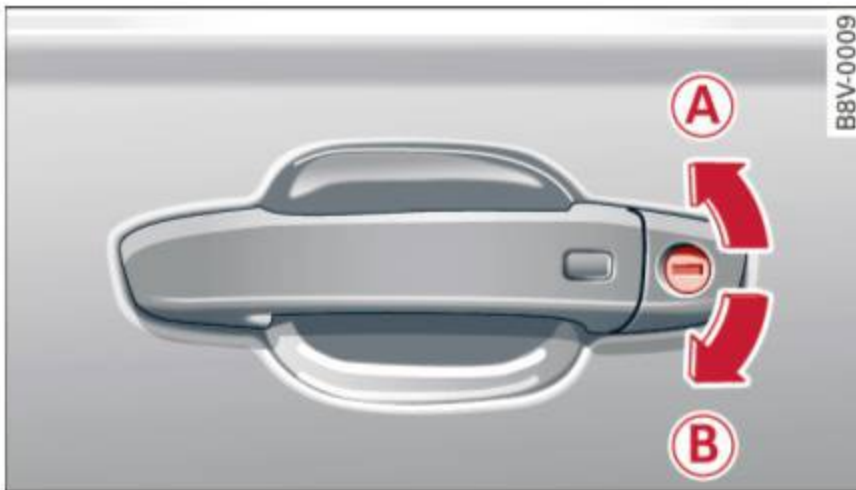

Fig. 23 Driver's door: Lock cylinder

- ▶ To unlock the driver's door, turn the key to the open position **A**.
- ▶ To lock the driver's door, move the selector lever to the P position and turn the key once to the close position **B**.

The settings in the MMI specify if the entire vehicle or one of the doors is unlocked when unlocking the vehicle ⇒ *page 37*.

### **!** WARNING

Read and following all WARNINGS. ⇒ **!** in Key set on *page 33*



### **i** Tips

For information on additional remote control key or convenience key functions, refer to ⇒ *page 41, Convenience opening/closing*.

## Central locking switch



Fig. 24 Driver's door: Central locking switch

- ▶ To lock the vehicle, press the  button ⇒ **!**.
- ▶ To unlock the vehicle, press the  button ⇒ *fig. 24*.

When locking the vehicle with the central locking switch, the following applies:

- Opening the door and the luggage compartment lid from the *outside* is not possible (for security such as when stopped at a light).
- The LED in the central locking switch turns on when all doors are closed and locked.
- Front doors: You can open the doors individually from the *inside* by pulling the door handle.
- Rear doors: Pull on the door handle *once* to unlock the door. Pull on the door handle *again* to open the door.
- In the event of a crash with airbag deployment, the doors unlock automatically to allow access to the vehicle.

### **!** WARNING

- The power locking switch works with the ignition off and automatically locks the entire vehicle when the  button is pressed.
- On a vehicle locked from the outside the power locking system switch is inoperative.
- Locked doors make it more difficult for emergency workers to get into the vehicle, which puts lives at risk. Do not leave anyone behind in the vehicle, especially children.

### **i** Tips

Your vehicle will lock automatically at a speed of 9 mph (15 km/h) ⇒ *page 33*. You can unlock the vehicle again using the central locking opening function.

## Setting central locking

Applies to vehicles: with driver information system

Various settings can be adjusted in the MMI:

### Adjusting door unlocking



You can determine which doors should unlock when opening the vehicle. ▶



## Opening and closing

- ▶ Select: the **MENU** button > **Car** > **Systems\*** control button > **Vehicle settings** > **Central locking** > **Door unlocking**.

Selecting **All** and pressing the  button on the remote control key unlocks the entire vehicle.

If you select **Driver** and then press the  button on the remote control key, only the driver's door will unlock. In vehicles with a convenience key, only the front door whose handle you pull will unlock. If you press the  button twice, the entire vehicle will unlock. If you press the  button, the entire vehicle will always lock.

### Folding\* the exterior mirrors

- ▶ Select: the **MENU** button > **Car** > **Systems\*** control button > **Vehicle settings** > **Central locking** > **Fold mirrors when locking**. For more information, refer to ⇨ *page 47, Adjusting the exterior mirrors*.

If you select **On**, the outside mirrors will fold in automatically when you press the  button on the remote control key ⇨ *page 47*.

### Tone when locking

- ▶ Select: the **MENU** button > **Car** > **Systems\*** control button > **Vehicle settings** > **Central locking** > **Tone when locking**.

When checked off ✓, a tone will sound when you lock the vehicle.

If you press the  button twice, the entire vehicle will lock. There is a locking tone at the same time <sup>1)</sup>.

## Electronic immobilizer

*The immobilizer prevents unauthorized use of your vehicle.*

A microchip in the key automatically deactivates the electronic immobilizer when the key is located in the vehicle. If you remove the key from the vehicle, the electronic immobilizer activates again automatically.

## WARNING

Always take the key with you whenever you leave your vehicle. The electronic immobilizer can be deactivated with the key, so this could make it possible for unauthorized persons to start the engine and operate vehicle systems such as the power windows or sunroof. This can increase the risk of serious injury.

## Tips

- The vehicle cannot be started if an unauthorized key is used. It may not be possible to start the vehicle under certain circumstances, for example if there is another radio module like the key from another vehicle or a transponder on the same keychain.
- For an explanation on conformity with the FCC regulations in the United States and the Industry Canada regulations, refer to ⇨ *page 265*.

## Safety central locking

Applies to vehicles: with safety central locking

Safety central locking provides the possibility, to only unlock the driver's door and the fuel filler door. The rest of the vehicle remains locked.

### Unlocking the driver's door and the fuel filler door

- ▶ Press the remote control key or convenience key  button *once* or turn the key *once* in the opening direction.

### Unlocking all doors, the luggage compartment lid and the fuel filler door

- ▶ Press the remote control key or convenience key  button *twice* within five seconds or turn the key *twice* within five seconds in the opening direction.

When unlocking just the driver's door, the anti-theft alarm system\* is also immediately deactivated.

In vehicles with an MMI, you can directly adjust the safety central locking ⇨ *page 37*.

<sup>1)</sup> This function is not available in all countries.



## Front passenger's door and rear doors emergency locking

All doors must be locked separately if the power locking system fails.



Fig. 25 Emergency door locking

The driver's door can be locked using the door lock cylinder ⇒ *page 37*.

The emergency lock on the other doors is located on the side of the front passenger's and rear doors. It is only visible when the door is open.

- ▶ Pull the cover cap out of the opening.
- ▶ Insert the key bit in the slot inside and turn the key all the way to the right (right door) or left (left door).

Once the door has been closed, it can no longer be opened from the outside. The door can be unlocked and opened from the inside by pulling the door handle once.

If the child safety lock on the rear doors is activated, pull the inner door handle first. Then you can open the door from the outside.

## Luggage compartment lid

### Opening and closing the luggage compartment lid





Fig. 26 Luggage compartment lid: opening (handle)



Fig. 27 Luggage compartment lid/grip: closing

### Opening the luggage compartment lid

- ▶ Press and hold the  button on the remote control key for at least one second, or
- ▶ Push the handle in the luggage compartment lid ⇒ *fig. 26*, or
- ▶ Pull the button  in the driver's door **18** ⇒ *page 8, fig. 1*.

### Closing the luggage compartment lid

- ▶ Use the inside grip to pull the luggage compartment lid down and allow it to drop gently to close it ⇒ *fig. 27* ⇒ .

### WARNING

- After closing the luggage compartment lid, make sure that it is latched. Otherwise the luggage compartment lid could suddenly open when driving, which increases the risk of an accident.



- Never drive with the luggage compartment lid ajar or open, because poisonous gases can enter the vehicle interior and create the risk of asphyxiation.
- Never leave your vehicle unattended when the luggage compartment lid is open. A child could climb into the vehicle through the luggage compartment. If the luggage compartment lid was then closed, the child would be trapped in the vehicle and unable to escape. To reduce the risk of injury, do not allow children to play in or around the vehicle. Always keep the luggage compartment lid and the doors closed when the vehicle is not in use.
- Always make sure no one is in the luggage compartment lid's range of motion when it is closing, especially near the hinges. Fingers or hands could be pinched.

### Tips

- When the vehicle is locked, the luggage compartment lid can be unlocked separately by pressing the  button on the remote control key. When the luggage compartment lid is closed again, it locks automatically.
- In case of an emergency or a faulty handle, the luggage compartment lid can be opened from the inside ⇒ page 240.

## Child safety lock

### Child safety lock

Applies to vehicles: with mechanical child safety lock

The child safety locks  prevent the rear doors from opening from the inside.



Fig. 28 Rear doors: Child safety lock

- ▶ To turn the child safety locks **on**, turn the ignition key in the direction of the arrow.
- ▶ To turn **off**, turn the ignition key opposite the direction of the arrow.

When the child safety locks are activated, the inside door handles do not work and the doors can only be opened from the outside.

The child safety lock only functions on the door in which it was activated.

## Power windows

### Controls

The driver can control all power windows.



Fig. 29 Section of the driver's door: Controls

All power window switches are provided with a **two-position function**:

### Opening the windows

- ▶ Press the switch to the **first stop** and hold it until the window reaches the desired position.
- ▶ Press the switch briefly to the **second stop** to automatically open the window.

### Closing the windows

- ▶ Pull the switch to the **first stop** and hold it until the window reaches the desired position.
- ▶ Pull the switch briefly to the **second stop** to automatically close the window.



### Power window switches

- A** Switch ⇒ fig. 29 for the window in the driver's door.
- B** Switch for the window in the front passenger's door.
- C** Switch for the window in the left rear door. ▶



- ⓓ Switch for the window in the right rear door.
- Ⓢ Safety button\*.

### Child safety lock

When the safety button  ⇒ *fig. 29* is pressed, the  symbol in the button lights up. The power window switches in the rear doors are switched off.

#### WARNING

- When you leave your vehicle - even if only briefly - always remove the ignition key. This applies particularly when children remain in the vehicle. Otherwise the children could start the engine or operate electrical equipment (e.g. power windows). The power windows are functional until the driver's door or passenger's door has been opened.
- Pay careful attention when closing the windows. It could cause injury by pinching.
- When locking the vehicle from outside, the vehicle must be unoccupied since the windows can no longer be opened in an emergency.

#### Tips

After turning the ignition off you can still open and close the windows for approximately 10 seconds. The power windows are not switched off until the driver's door or passenger's door has been opened.

### Convenience opening/closing

With the convenience opening/closing function, you can centrally and easily open the windows and the panorama sunroof\* from the outside.

#### Convenience open feature

- ▶ Press the open button  on the remote control key until all windows and the panorama sunroof\* have reached the desired position, or
- ▶ Hold the key in the driver's door lock until all windows and the panorama sunroof\* have reached the desired position.

#### Convenience close feature

- ▶ Hold the key in the driver's door lock in the lock position until all windows and the panorama sunroof\* are closed.

#### Convenience closing with the convenience key\*

- ▶ Touch the sensor\* on one of the front door handles and continue touching it until all of the windows and the panorama sunroof\* are closed. Do not place your hand in the door handle when doing this.

#### Adjusting the convenience opening in the MMI

- ▶ Select: the  button > **Car** > **Systems\*** control button > **Vehicle settings** > **Central locking** > **Long-press to open windows**

To enable convenience opening of the windows and the roof\*, the **Front windows**, **Rear windows\*** and **Roof\*** functions must be switched **On**.

#### WARNING

- Never close the windows or panorama sunroof\* carelessly or in an uncontrolled manner, because this increases the risk of injury.
- For security reasons, the windows can only be opened with the remote control key at a maximum distance of approximately 6 feet (2 meters) from the vehicle.
- Pay attention when using the lock cylinder to close the windows and the panorama sunroof\* so that no one is pinched. Closing stops when the key is moved into the starting position.

### Correcting power window malfunctions

*After disconnecting the vehicle battery, the one-touch up and down feature must be activated again.*

- ▶ Pull the power window switch until the window is completely raised.
- ▶ Release the switch and pull it again for at least one second.



## Panorama sunroof

### Description

Applies to vehicles: with panoramic sunroof

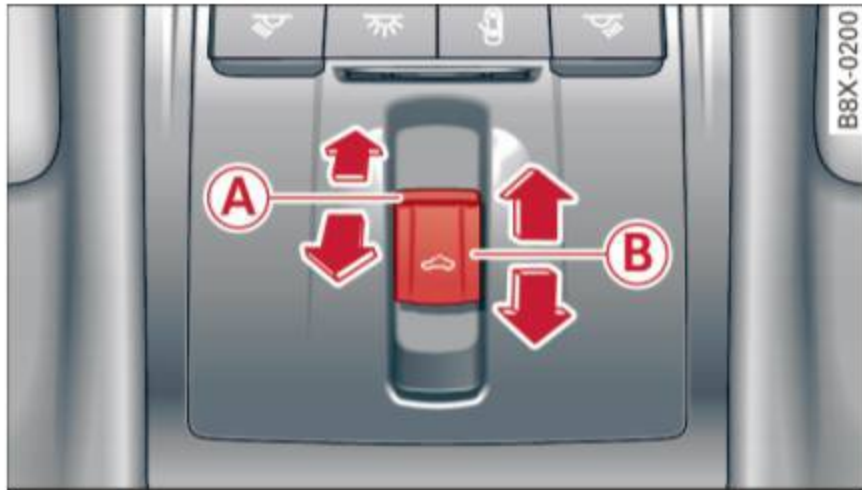

Fig. 30 Section from headliner: Panorama sunroof button

The button has two stages. In the second stage, the roof automatically runs to the end position (open/closed) when the button is operated briefly. The movement can be stopped by pressing the button.

#### A Tilting and sliding

- ▶ To tilt the sunroof completely, press the switch briefly to the second level.
- ▶ To close the roof completely, pull the button down briefly to the second level or slide the button forward briefly to the second level ⇒ ⚠.
- ▶ To select an intermediate position, press/pull the switch in the first level until the desired position is reached.

#### B Opening and closing

- ▶ To open the sunroof completely, slide the button back to just before the second level.
- ▶ To close the roof completely, push the button forward briefly to the second level or pull the button down briefly to the second level ⇒ ⚠.
- ▶ To select an intermediate position, press/pull the switch forward/back in the first level until the desired position is reached.

A wind deflector integrated in the panorama sunroof adapts automatically to the sunroof position. This reduces wind noise to a minimum in all panorama sunroof positions.

You can still operate the panorama sunroof for about 10 minutes after the ignition is switched

off. The switch is deactivated once the driver's or front passenger's door is opened.

### Sun blind

The sun shade can be opened and closed manually, depending on the position of the panorama sunroof. The sun shade can be opened partially.

#### ⚠ WARNING

Be careful when closing the panoramic sunroof - otherwise serious injury could result! Always take the ignition key with you when leaving the vehicle.

#### ! Note

Always close your panoramic sunroof when leaving your vehicle. Sudden rain can cause damage to the interior equipment of your vehicle, particularly the electronic equipment.

#### i Tips

- For information about convenience opening/closing, refer to ⇒ page 41.
- The panorama sunroof can only be opened when the temperature is warmer than -4°F (-20 °C).

### Panorama sunroof emergency closing

Applies to vehicles: with panoramic sunroof

If the panorama sunroof detects resistance or an object in its path while closing, the sunroof will open again automatically. If the sunroof fails to close after removing the object and after trying to close a second time, you can perform an emergency closing.

- ▶ Within five seconds after the sunroof opens automatically, pull the switch until the roof closes.

If you let go of the switch early, the panorama sunroof will open again.



## Light and Vision

### Exterior lighting

#### Switching lights on and off



Fig. 31 Instrument panel: Light switch (example)



The headlights only work when the ignition is switched on. The headlights turn off automatically when the engine is switched on or when the ignition is switched off. Only the side-marker lights stay on.

A warning symbol will appear in the driver information display if the system is not functioning correctly ⇒ page 24.

#### Light switch

Turn the switch ⇒ fig. 31 to the corresponding position. When the lights are switched on, the respective symbol turns on.

0 - lights off. In some countries, the day time running lights\* are turned on and off together with the ignition.

- **USA models:** The daytime running lights switch on automatically when the ignition is switched on and the light switch ⇒ fig. 31 is in the **0** position or the **AUTO** position (only in daylight). The **Daytime running lights** can be switched on and off in the MMI ⇒ page 45 ⇒ .
- **Canada models:** the daytime running lights switch on automatically when the ignition is switched on and the light switch ⇒ fig. 31 is in the **0** position,  or the **AUTO** position (only in daylight). ⇒ .

**AUTO\*** - Automatic headlights switch on and off depending on brightness, for example in twilight, during rain or in tunnels. In vehicles with integrated daytime running lights\*, either the day-

time running lights or the headlights will turn on automatically, depending on the amount of light (may vary depending on the country).

 - Parking light



 - Low beam headlight



The following will happen in these light switch positions when you lock the vehicle:

-  - Low beam headlight: the entire exterior lighting is switched off
- **AUTO\***: the Coming home\* function is turned on ⇒ page 45

#### Fog lights\*/rear fog light(s)

Press the corresponding button ⇒ fig. 31:



 - Front fog lights\* (not pictured). This button replaces the button for all-weather lights . When the fog lights are switched on, the  symbol in the button illuminates.

 - Rear fog light(s) When the rear fog lights are switched on, the  symbol in the button illuminates.

#### All-weather lights\*

applies to vehicles with LED headlights.

Press the corresponding button  ⇒ fig. 31 on the light switch:

 - All-weather lights. The symbol  in the button lights up when all-weather lights are switched on.

In vehicles with all-weather lights, the front lights are adjusted automatically so that you are less likely to see glare from your own headlights, for example when driving on a wet road.

#### Headlight range control system

The headlight range adjusts automatically when there is a change in vehicle load and during braking and accelerating so that the headlights do not cause glare for oncoming traffic.

#### Audi adaptive light\*

The adaptive light only works when the light switch is in the AUTO position. You can deactivate adaptive light in the MMI ⇒ page 45. ►



When switched on, adaptive light adjusts to curves depending on the vehicle speed and steering wheel angle. This provides better lighting through the curve. The system operates in a speed range from approximately 6 mph (10 km/h) to 68 mph (110 km/h).

**Static cornering light\*** (vehicles with adaptive light) - the cornering light switches on automatically when the steering wheel is turned at a certain angle at speeds up to approximately 44 mph (70 km/h) and when the turn signal is activated at speeds up to approximately 25 mph (40 km/h). The area to the side of the vehicle is illuminated better when turning.

**Speed dependent light distribution\*** - The speed dependent light distribution adapts the light in towns and on highways or expressways. Intersections can also be illuminated on vehicles with a navigation system\*.

### Highway light function\*

(Vehicles with adaptive light or LED headlights) - This function adapts the lighting for highway driving based on vehicle speed.

#### WARNING

- Automatic headlights\* are only intended to assist the driver. They do not relieve the driver of his responsibility to check the headlights and to turn them on manually according to the current light and visibility conditions. For example, fog cannot be detected by the light sensors. So always switch on the low beam under these weather conditions and when driving in the dark .
- Accidents could occur if you cannot see the road ahead of you well and if others on the road cannot see you. Always switch your headlights on so that you can see the road ahead of you and others can see your vehicle from behind.
- Please observe legal regulations when using the lighting systems described.

#### Note

The rear fog lights should only be turned on in accordance with traffic regulation, as the lights are bright for following traffic.

#### Tips

- The light sensor for the automatic headlights\* is in the rearview mirror mount. Therefore, do not place any stickers in this area on the windshield.
- Some functions of the exterior lighting can be adjusted  $\Rightarrow$  page 45.
- If you turn off the ignition while the exterior lights are on and open the door, you will hear a warning tone.
- In some market-specific versions, the tail lights do not turn on when switching on the daytime running lights.
- In cool or damp weather, the inside of the headlights, turn signals and taillights can fog over due to the temperature difference between the inside and outside. They will clear shortly after switching them on. This does not affect the service life of the lighting.
- A message will appear in the instrument cluster if there is a malfunction in the light sensor  $\Rightarrow$  page 24.

### Emergency flasher



Fig. 32 Instrument panel: emergency flasher button

The emergency flashers makes other drivers aware of your vehicle in dangerous situations.

- Press the  button to switch the emergency flashers on or off.



You can indicate a lane change or a turn when the emergency flashers are switched on by using the turn signal lever. The emergency flashers stop temporarily.

The emergency flashers also work when the ignition is turned off.

### **i** Tips

You should switch the emergency flashers on if:

- You are the last car in a traffic jam so that all other vehicles approaching from behind can see you, or if
- Your vehicle has broken down or you are having an emergency, or if
- Your vehicle is being towed or if you are towing another vehicle.

### Turn signal and high beam lever

The lever operates the turn signals, the high beams and the headlight flasher.

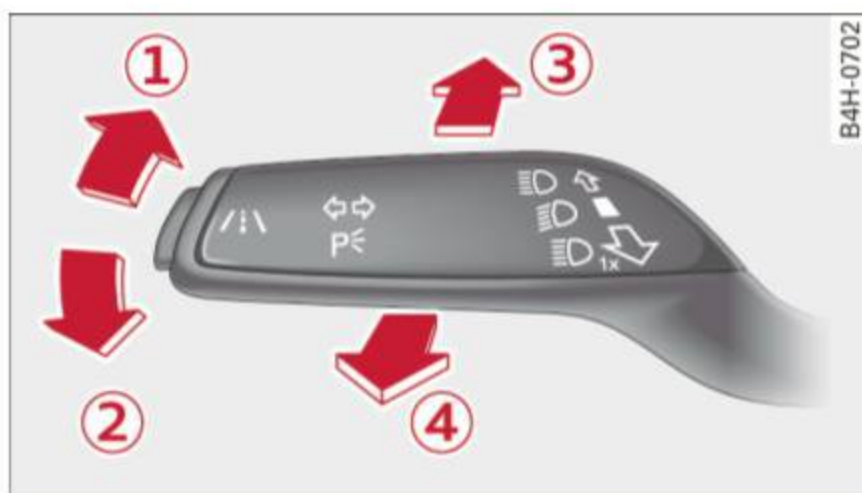

Fig. 33 Turn signal and high beam lever

### Turn signals ⇐⇒

The turn signals activate when you move the lever into a turn signal position when the ignition is switched on.

- ① - Turn signal
- ② - Turn signal

The turn signal blinks three times if you tap the lever (convenience turn signal).

### High beams and headlight flasher

Move the lever to the corresponding position:

- ③ - high beams on

- ④ - high beams off or headlight flasher

The  indicator light in the instrument cluster turns on.

### WARNING

High beams can cause glare for other drivers, which increases the risk of an accident. For this reason, only use the high beams or the headlight flasher when they will not create glare for other drivers.

### Adjusting the exterior lighting

The settings are adjusted in the MMI.

- ▶ Select: the **MENU** button > **Car** > **Systems\*** control button > **Vehicle settings** > **Exterior lighting**.

### Automatic headlights

You can adjust the following settings in the **Automatic headlights** menu:

**Activation sensitivity** - You can adjust if the headlights switch on **Early**, **Medium** or **Late** according to the sensitivity of the light sensor.

**Audi adaptive light\*** - you can switch adaptive light **On** and **Off**.

### Coming home, Leaving home\*

The coming home function illuminates the area outside the vehicle when you turn the ignition off and open the driver's door. To turn the function on, select **Lights when leaving car** > **On**.

The leaving home illuminates the area outside the vehicle when you unlock the vehicle. To turn the function on, select **Lights when unlocking car** > **On**.

The coming home and leaving home functions only operate when it is dark and the light switch is in the **AUTO** position.

### Daytime running lights\*

**USA models:** the daytime running lights can be switched on or off using the MMI. Select **On** or **Off**.



**Canada models:** This function cannot be switched off. They activate automatically each time the ignition is switched on. This menu item is shown with a “gray background”.

### Travel mode\*

The headlight beam is asymmetrical. This provides stronger illumination on the side of the road on which you are driving. In vehicles with **Xenon headlights\*** with **turning light\*** or **LED headlights\***, you must adjust the headlights when you are driving in a country where the traffic direction is opposite from your own country. Otherwise, oncoming traffic will be blinded by the glare from the headlights. An adjustment is not needed in vehicles with Xenon headlights without turning lights.

To prevent glare:

- Travel mode must be activated in vehicles with Xenon headlights\* and turning light\* or LED headlights\*. Select: the **MENU** button > **Car** > **Systems\*** control button > **Vehicle settings** > **Exterior lighting** > **Light for driving on left**, for example.

After you have adjusted the headlights, the following message will appear:

 **Headlight converter active for driving on left. Range reduced!**

### Tips

When travel mode is activated, a display in the driver information system indicates this each time you switch the ignition on.

## Interior lighting

### Front and rear interior lighting front



**Fig. 34** Front headliner: Interior lighting controls (example)



**Fig. 35** Rear headliner: LED reading lights\* (example)

Depending on equipment, the interior lighting may differ from the illustration.

 - Interior lighting on/off

 - Door contact switch. The interior lighting is controlled automatically.

\* - Reading lights on/off

### Interior lighting

There are other interior lighting functions that are available. Some functions can be adjusted in the MMI. Select: the **MENU** button > **Car** > **Systems\*** control button > **Vehicle settings** > **Ambient lighting**.



## Instrument illumination

The brightness of the instrument cluster and the center console can be adjusted.



Fig. 36 Instrument illumination

Requirement: The light must be switched on.

- ▶ Press the knob to release it.
- ▶ Turn the knob toward "-" or "+" to reduce or increase the brightness.
- ▶ Press the knob again to return it to its original position.

### Tips

The needles and gauges in the instrument cluster illuminate when the headlights are off and the ignition is switched on. The illumination reduces automatically and eventually turns off as brightness outside decreases. This function reminds the driver to turn the headlights on at the appropriate time.

## Vision



### Adjusting the exterior mirrors



Fig. 37 Driver's door: knob for the exterior mirrors (example)

Turn the knob to the desired position:

0 - All adjustment functions are deactivated.

/ - Adjusting the left/right exterior mirror. Move the knob in the desired direction.

 - Heating\* the mirror glass depending on the outside temperature.

 - Folding exterior mirrors\*.

### Front passenger's exterior mirror tilt function\*



To help you see the curb when backing into a parking space, the surface of the mirror tilts slightly. For this to happen, the knob must be in the position for the front passenger's outside mirror.

You can adjust the tilted mirror surface by turning the knob in the desired direction. When you move out of reverse and into another gear, the new mirror position is stored and assigned to the key you are using.

The mirror goes back into its original position once you drive forward faster than 9 mph (15 km/h) or turn the ignition off.

### Folding mirrors in and out

To fold the mirrors in with the knob, turn the knob in the  position.

To fold the mirrors out, turn the knob in the  or  or 0 position.

You can set in the MMI if the mirrors should fold in when locking the vehicle or not  $\Rightarrow$  page 38. When you lock the vehicle, the mirrors fold in. When you start the ignition, the mirrors fold out.

### WARNING

Curved mirror surfaces (convex) enlarge the field of vision. However, they make objects in the mirror appear smaller and further away. You may estimate incorrectly when you use these mirrors to gauge your distance from the vehicles behind you when changing lanes - accident risk!

### Note

– For vehicles with power folding exterior mirrors\*: if the mirror housing was moved by



outside forces (such as an impact when maneuvering), you must use the power folding function to fold the mirror all the way out. You will hear a loud noise when the mirrors are latched back in place. The mirror housing must not be moved back into place by hand because this would impair the function of the mirror mechanism.

- Applies to vehicles without power folding exterior mirrors: if the mirror housing was moved by outside forces (such as in impact during maneuvering), you must move the mirror housing back into place by hand.
- If you wash the vehicle in an automatic car wash, you must fold the exterior mirrors in to reduce the risk of damage to the mirrors. Never fold power folding exterior mirrors\* by hand. Only fold them in and out using the power controls.

### **i** Tips

If the power adjustment fails, both mirrors can be adjusted by hand by pressing on the edge of the mirror surface.

### Dimming the mirrors

Your vehicle is equipped with a manual or automatic\* dimming rearview mirror.

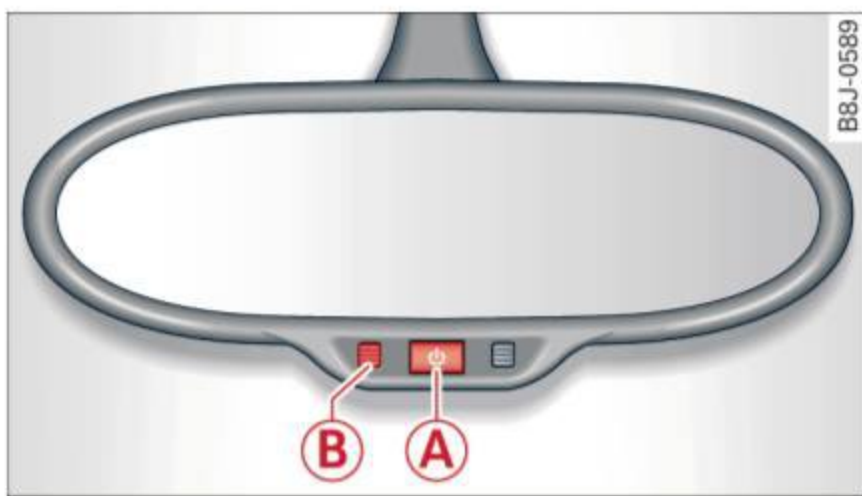

Fig. 38 Automatic dimming rearview mirror\*

### Manual dimming rearview mirror

- ▶ Pull the lever on the bottom of the mirror back.

### Automatic dimming rearview mirror\*

- ▶ Press the **(A)** button. The indicator light **(B)** turns on. The rearview and driver's exterior\* mirrors dim automatically when light shines on them,

for example from headlights on a vehicle to the rear.

### **!** WARNING

Electrolyte fluid can leak from automatic dimming mirrors if the glass is broken. Electrolyte fluid can irritate skin, eyes and airways.

- Repeated or long-term exposure to electrolyte fluid can lead to irritation of the airways, especially in people with asthma or other respiratory conditions. Take deep breaths immediately after leaving the vehicle or, if this is not possible, open all of the doors and windows as wide as possible.
- If electrolyte fluid enters the eyes, flush them thoroughly with a large amount of clean water for at least 15 minutes and then seek medical attention.
- If electrolyte fluid comes into contact with the skin, flush the affected area with clean water for at least 15 minutes and then clean with soap and water and seek medical attention. Clean affected clothing and shoes thoroughly before wearing again.
- If the fluid was swallowed and the person is conscious, flush the mouth with water for at least 15 minutes. Do not induce vomiting unless this is recommended by medical professionals. Seek medical attention immediately.

### **!** Note

If the glass on an automatic dimming mirror breaks, electrolyte can leak out. This liquid damages plastic surfaces. Clean this liquid as quickly as possible with a wet sponge.

### **i** Tips

- If the light reaching the rearview mirror is obstructed, the automatic dimming mirror will not function correctly,
- The automatic dimming mirrors do not dim when the interior lighting is turned on or the reverse gear is selected.



## Sun visors



Fig. 39 Left side: sun visor

The sun visors can be moved out of their brackets and turned toward the doors **1**. The sun shade can also be moved back and forth lengthwise in this position.

The mirror light switches on when the cover over the vanity mirror\* **2** opens.

## Windshield wipers

### Switching windshield wipers on

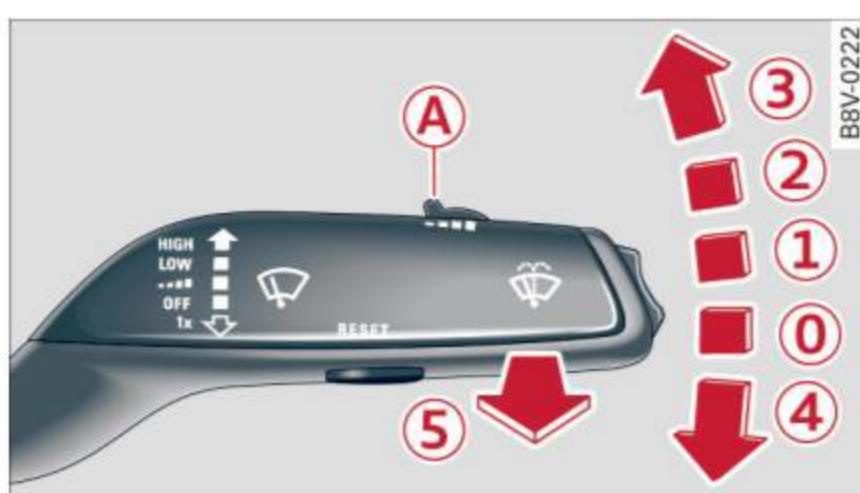

Fig. 40 Windshield wiper lever: Front wiper system operation

Requirement: ignition must be switched on.

Move the windshield wiper lever to the corresponding position:

- 0** - Front wipers off
- 1** - Interval mode. To increase/decrease the wiper intervals, move the switch **A** to the left/right. In vehicles with a light/rain sensor\*, the wipers turn on when it is raining, when the vehicle is stationary and the lever is tapped in the **5** position, or once the vehicle speed exceeds approximately 2 mph (4 km/h). The higher the sensitivity of the rain sensor is set (switch **A** to the right), the ear-

lier the windshield wipers react to moisture on the windshield.

- 2** - Slow wiping
- 3** - Fast wiping
- 4** - Single wipe If you hold the lever in this position longer, the wipers switch from slow wiping to fast wiping.
- 5** - Clean the windshield. To eliminate water droplets, the windshield wiper performs one afterwipe after several seconds in temperatures above 39 °F (4 °C). You can switch this function off by moving the lever to position **5** within 10 seconds after the afterwipe. The afterwipe function is reactivated the next time you switch the ignition on.

Cleaning the headlights\*. The headlight washer system\* operates only when the low beam headlights are on. If you move the lever in position **5**, the headlights will be cleaned in fixed intervals.

### ! WARNING

- The rain sensor is only intended to assist the driver. The driver is still responsible for manually switching the wipers on according to the visibility conditions.
- The windshield may not be treated with water-repelling windshield coating agents. Unfavorable conditions, such as wetness, darkness, low sun, can result in increased glare. Wiper blade chatter is also possible.
- Properly functioning windshield wiper blades are required for a clear view and safe driving ⇒ page 50, *Replacing front windshield wiper blades*.

### ! Note

- In the case of frost, check whether the windshield wiper blades are frozen to the windshield. Switching on the windshield wipers can damage the wiper blades!
- Prior to using a car wash, the windshield wiper system must be switched off (lever in position 0). This prevents unintentional switching on and damage to the windshield wiper system.



- Do not use the wipers to remove ice from the windows. Using windshield wipers as ice scrapers destroys the wiper blades.

### **i** Tips

- The windshield wipers are switched off when the ignition is turned off. Activate the windshield wipers after the ignition is switched back on by moving the windshield wiper lever to any position.
- Worn or dirty windshield wiper blades result in streaking. This can affect the rain sensor function. Check your windshield wiper blades regularly.
- The washer fluid nozzles in the windshield washer system are heated\* at low temperatures when the ignition is on.
- When stopping temporarily, such as at a traffic light, the speed of the windshield wipers automatically reduces by one level.
- In vehicles with an MMI, you can switch the rain sensor on or off in the **Driver assistance** menu.

### Cleaning windshield wiper blades

Clean the wiper blades when you see wiper streaks. Use a soft cloth and a glass cleaner.

- ▶ Place the windshield wiper arms in the service position ⇒ *page 50*.
- ▶ Fold the windshield wiper arms away from the windshield.

### **!** WARNING

Dirty windshield wiper blades can impair vision, which increases the risk of an accident.

### **!** Note

If you see streaks again after cleaning the wiper blades, the blades must be replaced ⇒ *page 50*.

### Replacing front windshield wiper blades

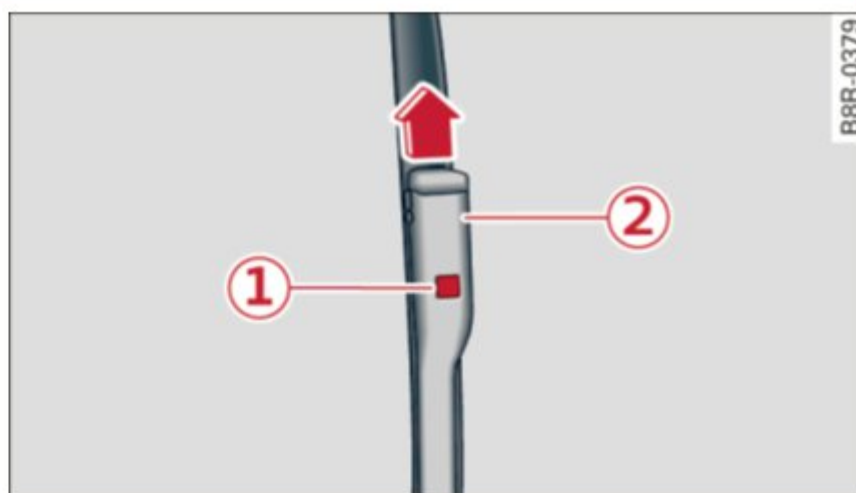

Fig. 41 Removing windshield wiper blades

### Wiper service position/blade replacement position

- ▶ To bring the wipers into the service position, turn the ignition off and move the windshield wiper lever into position ④ ⇒ *page 49, fig. 40*.
- ▶ To bring the wipers into the starting position, turn the ignition on and move the windshield wiper lever into position ④ ⇒ *page 49, fig. 40*.

### Removing the wiper blade

- ▶ Fold the windshield wiper arm away from the windshield.
- ▶ Press the locking knob ① ⇒ *fig. 41* on the wiper blade. Hold the wiper blade firmly.
- ▶ Remove the wiper blade in the direction of the arrow.

### Installing the wiper blade

- ▶ Insert the new wiper blade into the mount on the wiper arm ② until you hear it latch into place.
- ▶ Place the wiper arm back on the windshield.
- ▶ Turn the service position off.

### **!** WARNING

For safety reasons, the windshield wiper blades should be replaced once or twice each year.

### **!** Note

- The windshield wiper blades must only be folded away when in the service position! Otherwise, you risk damaging the paint on the hood or the windshield wiper motor.



- You should not drive your vehicle or press the windshield wiper lever when the wiper arms are folded away from the windshield. The windshield wipers would move back into their original position and could damage the hood and windshield.
- To prevent damage to the windshield washer system, always loosen wiper blades that have frozen to the windshield before turning the wipers on.
- To prevent damage to the wiper blades, do not apply gasoline, petroleum, thinning agents or other solvents on the wiper blades or near them.
- To prevent damage to the wiper arms or other components, do not try to move the windshield wipers by hand.

**i** Tips

- Commercial hot wax such as the types used by car washes make it more difficult to clean the windshield.
- You can also use the service position, for example, if you want to protect the windshield from icing by using a cover.
- You cannot activate the service position when the hood is open.

## Digital compass

### Switching the compass on and off

Applies to vehicles: with digital compass

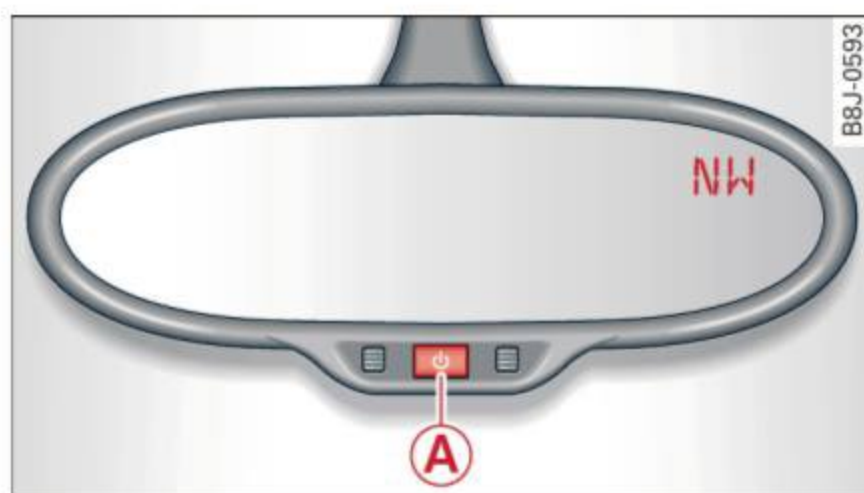

Fig. 42 Rearview mirror: Digital compass activated

- ▶ To turn the compass on or off, press the button **A** until the compass in the mirror appears or disappears.

The digital compass only works when the ignition is turned on. The directions are indicated with abbreviations: **N** (north), **NE** (northeast), **E** (east), **SE** (southeast), **S** (south), **SW** (southwest), **W** (west), **NW** (northwest).

You must recalibrate the compass if it does not display the correct direction ⇒ page 52, *Calibrating the compass*.

**i** Tips

To prevent inaccurate compass readings, do not bring any remote controls, electrical devices or metallic objects near the mirror.

### Adjusting the magnetic zone

Applies to vehicles: with digital compass

*The magnetic zone must be adjusted correctly for the compass to read accurately.*

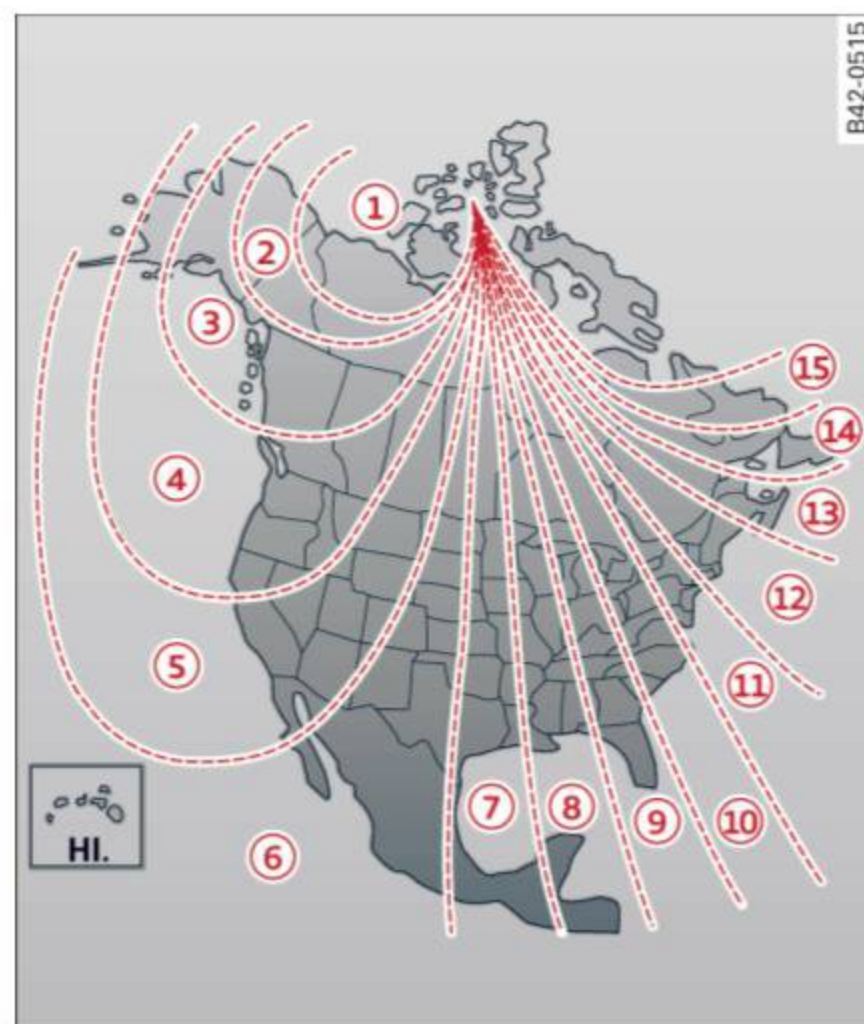

Fig. 43 North America: magnetic zone map

- ▶ Press and hold the button **A** ⇒ page 51, fig. 42 until the number of the magnetic zone appears in the rearview mirror.
- ▶ Press the button **A** repeatedly to select the correct magnetic zone. The selection mode turns off after a few seconds.



### Calibrating the compass

Applies to vehicles: with digital compass

*You must recalibrate the compass if it does not display the correct direction.*

- ▶ Press and hold the button  ⇒ page 51, fig. 42 until a **C** appears in the rearview mirror.
- ▶ Drive in a circle at about 5 mph (10 km/h) until a direction is displayed in the rearview mirror.



#### WARNING

- To avoid endangering yourself and other drivers, calibrate the compass in an area where there is no traffic.
- The digital compass should only be used as an orientation aid. If you want to check the compass while driving, you must still pay attention to traffic, the road, the weather and any other possible hazards.



## Seats and storage

### General information

#### Important information

#### WARNING

Refer to the chapter Driving Safely  
⇒ *page 130, Driving safety* for important information, tips, suggestions and warnings that you should read and follow for your own safety and the safety of your passengers.

#### Why is your seat adjustment so important?

*The safety belts and the airbag system can only provide maximum protection if the front seats are correctly adjusted.*

There are various ways of adjusting the front seats to provide safe and comfortable support for the driver and the front passenger. Adjust your seat properly so that:

- you can easily and quickly reach all the switches and controls in the instrument panel
- your body is properly supported thus reducing physical stress and fatigue
- the safety belts and airbag system can offer maximum protection ⇒ *page 148*.

In the following sections, you will see exactly how you can best adjust your seats.

There are special regulations and instructions for installing a child seat on the front passenger's seat. Always follow the information regarding child safety provided in ⇒ *page 172, Child safety*.

#### WARNING

Incorrect seating position of the driver and all other passengers can result in serious personal injury.

- Always keep your feet on the floor when the vehicle is in motion – never put your feet on top of the instrument panel, out of the window or on top of the seat cushion. This applies especially to the passengers. If your seating position is incorrect, you increase

the risk of injury in the case of sudden braking or an accident. If the airbag inflates and the seating position is incorrect, this could result in personal injury or even death.

- It is important for both the driver and front passenger to keep a distance of at least 10 inches (25 cm) between themselves and the steering wheel and/or instrument panel. If you're sitting any closer than this, the airbag system cannot protect you properly. In addition, the front seats and head restraints must be adjusted to your body height so that they can give you maximum protection.
- Always try to keep as much distance as possible between yourself and the steering wheel or instrument panel.
- Do not adjust the driver's or front passenger's seat while the vehicle is moving. Your seat may move unexpectedly, causing sudden loss of vehicle control and personal injury. If you adjust your seat while the vehicle is moving, you are out of position.

#### Driver's seat

*The correct seat position is important for safe and relaxed driving.*

We recommend that you adjust the driver's seat in the following manner:

- ▶ Adjust the seat in fore and aft direction so that you can easily push the pedals to the floor while keeping your knees slightly bent ⇒  in *Why is your seat adjustment so important?* on *page 53*.
- ▶ Adjust the backrest so that when you sit with your back against the backrest, you can still grasp the top of the steering wheel.
- ▶ For adjustable head restraints: adjust the head restraint so the upper edge is as even as possible with the top of your head. If that is not possible, try to adjust the head restraint so that it is as close to this position as possible ⇒ *page 56*. Move the head restraint so that it is as close to the back of the head as possible. ▶



### WARNING

Never place any objects in the driver's footwell. An object could get into the pedal area and interfere with pedal function. In case of sudden braking or an accident, you would not be able to brake or accelerate.

### Front passenger's seat

*Always move the front passenger seat into the rearmost position.*

To avoid contact with the airbag while it is deploying, do not sit any closer to the instrument panel than necessary and always wear the three-point safety belt provided adjusted correctly. We recommend that you adjust the passenger's seat in the following manner:

- ▶ Bring the backrest up to an (almost) upright position. **Do not** ride with the seat reclined.
- ▶ For adjustable head restraints: adjust the head restraint so the upper edge is as even as possible with the top of your head. If that is not possible, try to adjust the head restraint so that it is as close to this position as possible  
⇒ page 56. Move the head restraint so that it is as close to the back of the head as possible.
- ▶ Place your feet on the floor in front of the passenger's seat.

## Front seats

### Manual seat adjustment

Applies to vehicles: with manually adjustable seats

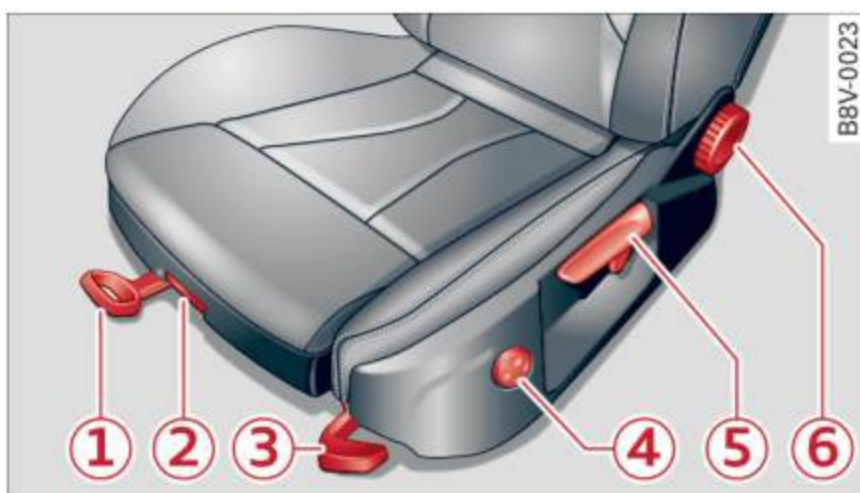

Fig. 44 Front seat: manual seat adjustment

- ① - Moving the seat forward/back: Pull the lever and move the seat.

- ② - Lengthening/shortening the upper thigh support\*: lift the grip handle.

- ③ - Adjusting the angle of the seat surface\*. Pull/press the lever.

- ④ - Adjusting the lumbar support\*: press the button in the desired direction.

- ⑤ - Moving the seat up/down: pull/press the lever.

- ⑥ - Adjusting the backrest angle: turn the adjusting wheel.

### WARNING

- Only adjust the front seat when the vehicle is stationary. Otherwise, this increases the risk of an accident
- Exercise caution when adjusting the seat height. Adjusting the seat carelessly or without checking can pinch hands and fingers.
- The front seat backrests must not be tilted too far back when driving, because this impairs the effectiveness of the safety belts and airbag system, which increases the risk of injury.
- To reduce the risk of injury during sudden braking or in a collision, the driver and front passenger should not have their backrests in the reclined position while driving or riding. The safety belts and airbag system can provide the greatest protection possible when the backrests are in the upright position and the safety belts are worn correctly. The more a backrest is reclined, the greater the risk of injury due to an incorrect seating position and safety belt position.



### Power seat adjustment

Applies to vehicles: with power adjustable seats

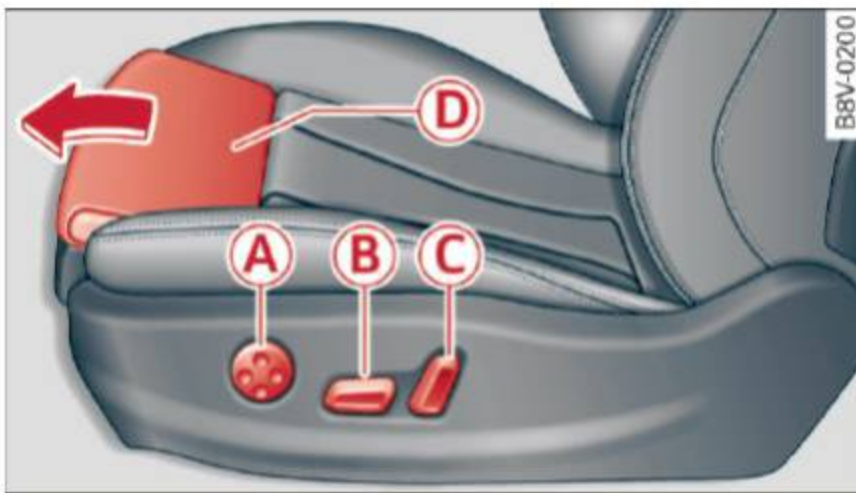

Fig. 45 Front seat: power seat adjustment

- Ⓐ - Adjusting the lumbar support: press the button in the desired direction.
- Ⓑ - Moving the seat up/down: press the button up/down. To adjust the front seat cushion, press the front button up/down. To adjust the rear seat cushion, press the rear button up/down.
- Ⓑ - Moving the seat forward/back: press the button forward/back.
- Ⓒ - Adjusting the backrest angle: turn the adjusting wheel.
- Ⓓ - Lengthening/shortening the upper thigh support\*: lift the grip handle.

#### WARNING

- Only adjust the front seat with when the vehicle is stationary. Otherwise, this increases the risk of an accident
- The power adjustment for the front seats also works with the ignition switched off or with the ignition key removed. For this reason, children should never be left unattended in the vehicle - they could be injured!
- Exercise caution when adjusting the seat height. Unsupervised or careless seat adjustment can pinch fingers or hands causing injuries.
- While the vehicle is moving, the seat backs of the front seats must not be inclined too far to the rear because the effectiveness of the safety belts and the airbag system is severely compromised - there is a risk of injury.

- To reduce the risk of injury during sudden braking or in a collision, the driver and front passenger should not have their backrests in the reclined position while driving or riding. The safety belts and airbag system can provide the greatest protection possible when the backrests are in the upright position and the safety belts are worn correctly. The more a backrest is reclined, the greater the risk of injury due to an incorrect seating position and safety belt position.

### Front center armrest

Applies to vehicles: with front center armrest

The center armrest can be adjusted to several levels.



Fig. 46 Armrest between the driver's/front passenger's seats.

- ▶ To adjust the angle, raise the armrest ⇒ fig. 46 notch by notch.
- ▶ To bring the armrest back down, raise it out of the top notch and fold it back down. Then lift the armrest to the desired position, if necessary.

Please note that the driver's ability to move his or arm may be restricted when the armrest is folded down. Because of this, the armrest should not be folded down during city driving.

The armrest can slide forward and back.

There is a storage compartment under the armrest.



### Rear center armrest

Applies to vehicles: with rear center armrest

The storage compartment and cup holder are integrated in the armrest.



Fig. 47 Rear armrest

### Folding the armrest down

- ▶ Tilt the armrest all the way down.

### Opening the storage compartment

- ▶ Lift the cover on the upper rim.

For more information on the use of the cup holders, see ⇒ page 58.

## Head restraints

### Front head restraints

Applies to vehicles: with adjustable head restraints

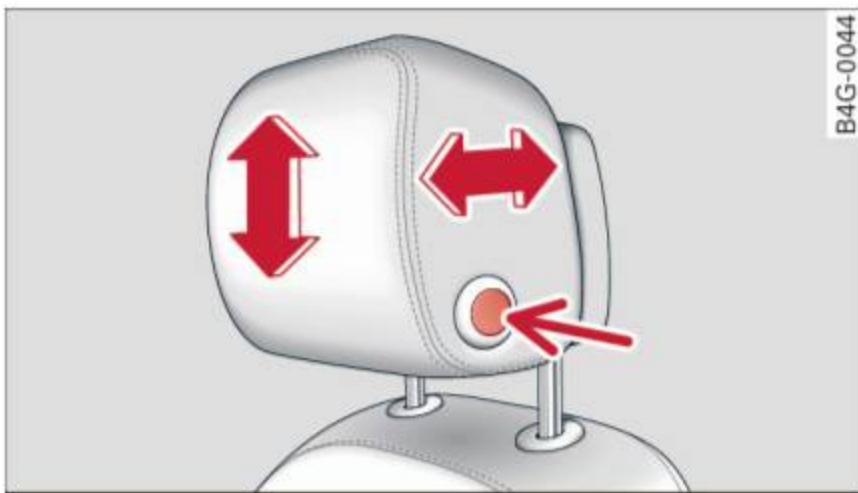

Fig. 48 Front seat: adjusting the head restraint

Applies to vehicles with super sport seats\* (no illustration): the head restraints are integrated in the backrest and cannot be adjusted.

Adjust the head restraints so the upper edge is as even as possible with the top of your head. If that is not possible, try to adjust as close to this position as possible. Push the head restraint as close as possible to the back of the head.

- ▶ To move the head restraint up or forward, slide it until it locks into place.
- ▶ To move the head restraint down or back, press the side button -arrow- ⇒ fig. 48 and slide the head restraint until it locks into place.

Refer to ⇒ page 134, *Proper adjustment of head restraints* for guidelines on how to adjust the height of the front head restraints to suit the occupant's body size.

### ! WARNING

- Driving without head restraints or head restraints that are not adjusted correctly dramatically increases the risk of serious or fatal neck injuries.
- Read and following the WARNINGS in ⇒ page 134, *Proper adjustment of head restraints*.

### i Tips

Head restraints that are adjusted correctly and safety belts are an extremely effective combination of safety equipment.

### Rear head restraints

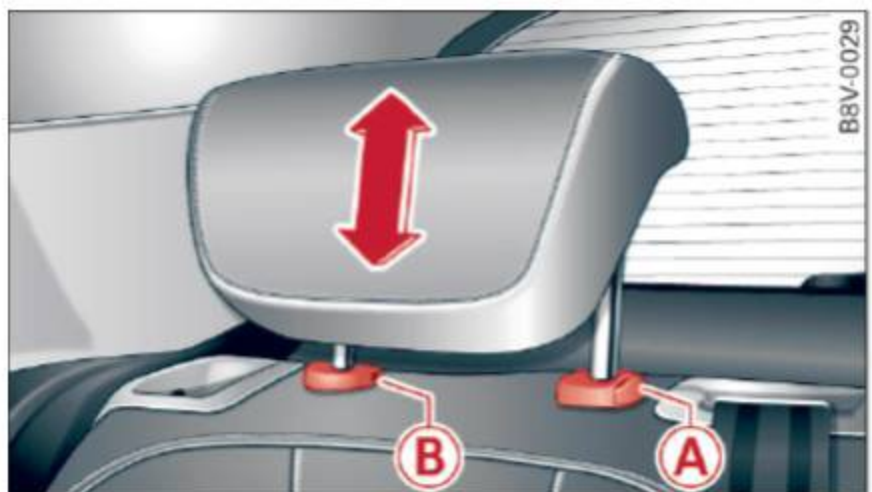

Fig. 49 Outer rear head restraints: release point

If there are passengers in the rear seat, fold the head restraints up on the occupied seats at least to the next notch ⇒ !.

### Adjusting the head restraints



- ▶ To move the head restraint up, hold it at the sides with both hands and slide it upward until you feel it click into place. ▶



- ▶ To move the head restraint down, press the button **(A)** ⇒ *fig. 49* and slide the head restraint downward.

### Removing the head restraints

To remove the head restraints, the backrest must be folded forward partially.

- ▶ Remove the screwdriver from the vehicle tool kit ⇒ *page 241*.
- ▶ Release the backrest ⇒ *page 60*.
- ▶ Press the button **(A)** ⇒ *fig. 49* and slide the head restraint up as far as it can go ⇒ .
- ▶ Place the screwdriver in position **(B)** in the opening, press the button **(A)** and pull the head restraint out of the backrest at the same time ⇒ .
- ▶ Fold the backrest down until it latches securely ⇒  in *Increasing the size of the luggage compartment on page 60*.

### Installing the head restraints

To install the head restraints, the backrest must be folded forward partially.

- ▶ Release the backrest ⇒ *page 60*.
- ▶ Slide the posts on the head restraint down into the guides until you feel the posts click into place. You should not be able to pull the head restraint out of the backrest.
- ▶ Fold the backrest down until it latches securely ⇒  in *Increasing the size of the luggage compartment on page 60*.

#### **WARNING**

- Only remove the rear seat head restraints when necessary in order to install a child seat. Install the head restraint again immediately once the child seat is removed. Driving with the head restraints removed or head restraints not in the highest position increases the risk of serious injury.
- Read and following the WARNINGS in ⇒ *page 134*.

## Socket

Applies to vehicles: with socket

*Electrical accessories can be connected in the 12 volt socket.*



**Fig. 50** Center console: front/rear 12 volt socket\*

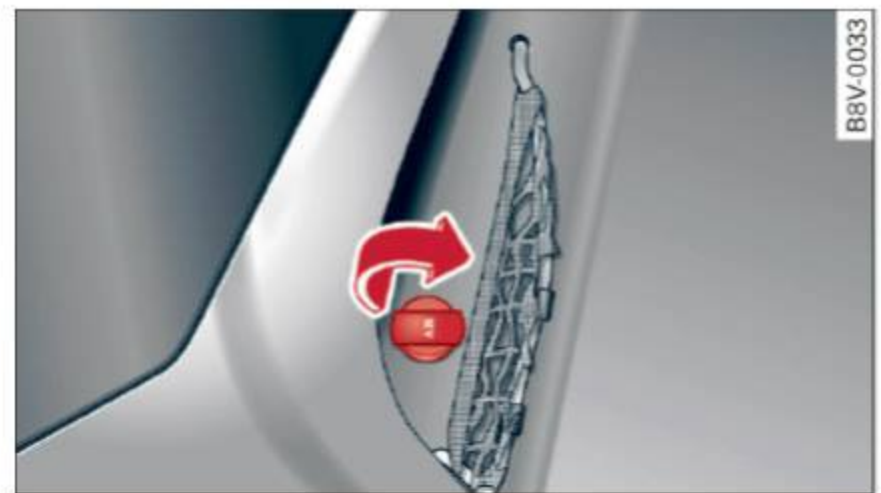

**Fig. 51** Luggage compartment side trim panel: 12 volt socket\* (example)

- ▶ Remove the plug from the center console socket ⇒ *fig. 50*, or
- ▶ Open the cover on the luggage compartment socket\* ⇒ *fig. 51*.
- ▶ Insert the plug of the electrical device into the socket.

The 12 volt socket can be used for electrical accessories. The power consumption at the outlet must not exceed 120 watts.

#### **WARNING**

The socket works only with the ignition switched on. Incorrect usage can lead to serious injuries or burns. To reduce the risk of injuries, never leave children unattended in the vehicle with the vehicle key.

#### **Note**

To prevent damage to the socket, only use the correct type of plugs.



## Seats and storage

- Never connect devices that generate electrical power such as solar panels or a battery charger to the 12 volt socket. They can damage the vehicle electrical system.
- To prevent damage to the socket, only use the correct type of plugs.

### **i** Tips

The vehicle battery drains when accessories are turned on but the engine is off.

## Storage

### Beverage holders



Fig. 52 Center console: front cup holders

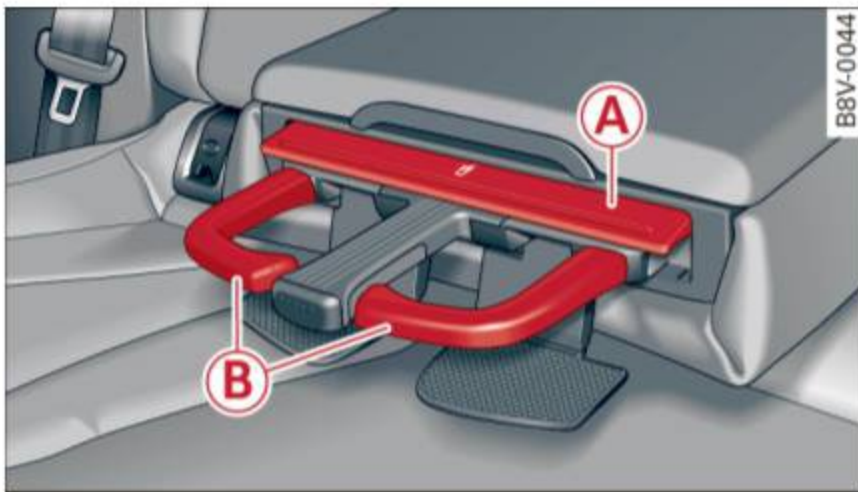

Fig. 53 Section of the rear bench seat: rear cup holders\*

### Front cup holders

- ▶ Place beverages in the holder ⇒ *fig. 52*. There is space for two beverages. A larger plastic bottle can be placed in the door trim.

### Rear\* cup holders

- ▶ To open the cup holders, tap on the rim **A** ⇒ *fig. 53*.
- ▶ To place the beverage container in the cup holder, push the arm **B** outward.
- ▶ Then push the arm against the beverage container so that the arm lies closely against it.

- ▶ To close the cup holders, push them back into the slot.

### **!** WARNING

Spilled hot liquid can increase the risk of accidents and injuries.

- Never drive with containers that contain hot liquid such as coffee or tea. The hot liquid could spill and cause burns during a collision, sudden braking or other vehicle movement. Spilled hot liquid can also increase the risk of accidents and injuries.
- Only use soft containers in the cup holders. Hard cups and glasses can increase the risk of injury during a collision.
- Never use the cup holder or the adapter as an ashtray - this is a fire hazard.

### **!** Note

Make sure your beverage container has a lid. If not, your beverage could spill out and cause damage to the vehicle electronic or stain the seat covers.

### Glove compartment



Fig. 54 Glove compartment

### Opening/closing

- ▶ To open the glove compartment, pull the handle in the direction of the arrow.
- ▶ To close the glove compartment, swing the lid upward until it clicks into place.

The glove compartment can be locked using the vehicle key.



**! WARNING**

Always leave the lid on the glove compartment cover closed while driving to reduce the risk of injury.

**Additional storage compartments**

There are additional storage compartments, compartments and holders at other locations in the vehicle:

- In the upper part of the glove compartment.
- In the center console under the center arm-rest\*.
- On the back of the right front seat. The compartment\* can hold a maximum weight of 2 lbs (1 kg).
- Garment hooks on the B-pillar ⇒ **!**

**! WARNING**

- Do not place any objects on the instrument panel. Objects that are not stored securely can slide around in the vehicle while driving, when accelerating or braking or when turning.
- Make sure that objects cannot fall out of the center console storage compartment or other compartments and into the footwell while driving. These objects could prevent you from braking or accelerating during sudden braking maneuvers.
- Garments hung on the hooks must not obstruct the driver's view. The garment hooks are only designed for light objects. Do not hang any garments with hard, sharp or heavy objects in the pockets on the garment hooks. These objects could injure vehicle occupants during sudden braking or in a collision - especially if the airbags deploy.
- Always keep the glove compartment closed while driving to reduce the risk of injury during a collision or heavy braking.
- Read and following the WARNINGS in ⇒ *page 168, Important safety instructions on the side airbag system.*
- Hang garments so that they do not obstruct the driver's view.

- The garment hooks should only be used for light articles of clothing. Do not leave any heavy or sharp-edged objects in the pockets that could interfere with the side airbags unfolding and cause injuries in the event of a collision.
- Do not use coat hangers to hang garments, because this could reduce the effectiveness of the side curtain airbags.
- Do not hang any heavy objects on the garment hooks, because they could cause injury during heavy braking.
- Because of their load capacity, the hooks should only be used to secure objects that weigh a maximum of 10 lb (5 kg). Heavy objects will not be secured sufficiently, and this increases the risk of injury.

**Luggage compartment**

**Loading luggage compartment**

*Luggage items must be stowed securely.*

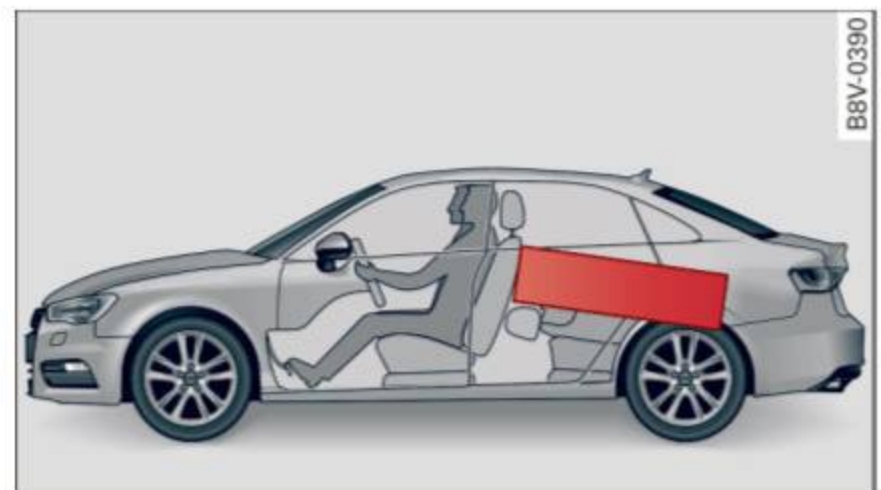

**Fig. 55** Place heavy objects as far forward as possible.

Note the following to preserve the vehicle's good handling characteristics.

- ▶ Distribute the load as evenly as possible.
- ▶ Place heavy objects as far forward as possible ⇒ *fig. 55.*
- ▶ Secure luggage items with the cargo net\* or with non-elastic retaining straps to the tie-down rings\* ⇒ *page 61.*

**! WARNING**

- Loose objects in the luggage compartment can slide about suddenly and alter the vehicle's handling characteristics.



- Loose objects in the passenger compartment can fly forward during abrupt maneuvers or accidents and injure occupants.
- Always store objects in the luggage compartment and use suitable straps, particularly with heavy objects.
- When you transport heavy objects, always remember that a change in the center of gravity may result in a change in the vehicle's handling characteristics.
- Follow all warnings ⇒ *page 130, Driving safety*.

### **i** Tips

The tire pressure must be adjusted to the load - see the tire pressure sticker located on the driver's side B-pillar.

## General information

### **!** WARNING

Refer to the chapter Driving Safely ⇒ *page 130, Driving safety* for important information, tips, suggestions and warnings that you should read and follow for your own safety and the safety of your passengers.

## Increasing the size of the luggage compartment

The rear seat backrests can be folded forward either separately or together.

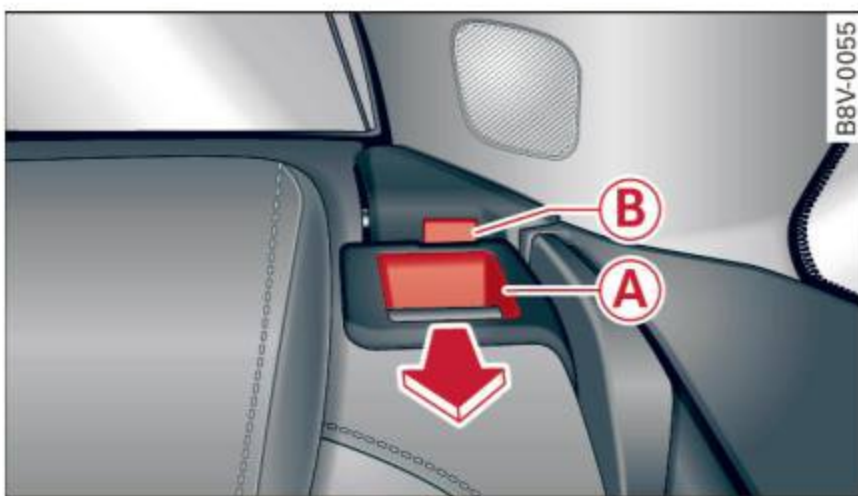

Fig. 56 Backrest: release lever (left side, example)

## Folding the backrest forward

- ▶ Push the corresponding head restraint downward ⇒ *page 56*.

- ▶ Press the release lever **A** in the direction of the arrow.
- ▶ Fold the backrest forward.

## Folding the backrest back into the upright position

- ▶ Fold the backrest down until it latches securely ⇒ **!**. When you can no longer see the red mark on the pin **B**, the seat is latched.

### **!** WARNING

- The backrest must be latched securely to ensure that the safety belt is protecting the center seating position.
- The backrest must be securely latched so objects cannot slide forward out of the luggage compartment during sudden braking.
- Always make sure the backrest is latched completely by pulling forward on it.
- Make sure the safety belt is not caught in the door hinges or the seat fittings and damaged.
- Torn or frayed safety belts can break, and belt anchors can break during a collision. Check the safety belts regularly. Safety belts with noticeable damage to the webbing, bindings, buckles or retractors must be replaced.

### **!** Note

- If you move the front seat back when the rear seat backrest is folded forward, you could damage the head restraints on the rear seat. If necessary, remove the rear seat head restraint before moving the front seat back.
- Make sure the safety belt is not pinched in the backrest lock and damaged when the rear seat backrest is folded back. Other objects should be removed from the rear bench seat to protect the rear backrest from damage.



### Tie-downs and cargo net

The cargo net\* prevents small objects from sliding.



Fig. 57 Luggage compartment: location of the tie-downs



Fig. 58 Luggage compartment: cargo net\* unhooked

- ▶ Secure the cargo to the tie-downs ⇒ *fig. 57* -arrows-.
- ▶ To secure the cargo net, first hang the front hooks in the tie-downs then hang the rear hooks -arrows- ⇒ *fig. 58*.
- ▶ Observe the safety notes ⇒ *page 136, Storing cargo correctly*.

#### WARNING

Weak, damaged or faulty straps used to secure objects to the tie-downs can fail during heavy braking or a collision and lead to serious injuries.

- Always use suitable straps and secure objects to the tie-downs in the luggage compartment to prevent objects from shifting and sliding forward.
- Never secure a child seat restraint to a tie-down.
- Because of their load capacity, the hooks should only be used to secure objects that weigh a maximum of 10 lb (5 kg). Heavy ob-

jects will not be secured sufficiently, and this increases the risk of injury.

### Storage hooks

Applies to vehicles: with bag hooks



Fig. 59 Luggage compartment: storage hooks

You can also use the hooks to hang light purses, bags, etc.

#### WARNING

The hooks can hold a maximum weight of 6 lb (3 kg). Heavier objects are not adequately secured. There is risk of personal injury.

### Reversible mat

Applies to vehicles: with cargo mat

The reversible mat protects the luggage compartment and bumper from dirt and scratches.



Fig. 60 Luggage compartment: reversible mat with backrest folded forward (example)

You can use the reversible mat with the dirt-resistant side or the decorative side. After loading or unloading, fold up the reversible mat and close the luggage compartment lid. Only store the reversible mat if it is dry.



### Pass-through

Applies to vehicles: with pass-through



Fig. 61 Backrest: pass-through cover

- ▶ Fold the rear seat center armrest down.
- ▶ Fold the pass-through cover down ⇒ *fig. 61*.

#### **WARNING**

- Make sure that all objects that you are transporting in the pass-through are secure. They could slide around during sudden braking maneuvers and cause injuries.
- Sharp edges on objects that are loaded must be covered for protection.

## Roof rack

### Description and mounting locations

Additional cargo can be carried with a roof luggage rack.



Fig. 62 Roof rack attachment points

- ▶ Always read and follow the instructions provided by the roof rack manufacturer when installing the roof rack system.

If luggage or cargo is to be carried on the roof, you must observe the following:

- Only use roof racks approved for your vehicle. These approved roof racks are the basis for a complete roof rack system. Additional attachments or carrier systems are needed to transport luggage and sports equipment. We recommend using roof racks from the Audi original accessories program.
- When installing the roof rack, make sure it is only mounted on the designated locations on the roof ⇒ *fig. 62*.
- We recommend that you keep the installation instructions for your roof rack system together with your Owner's literature in the vehicle.

#### When should the roof rack be removed?

- Before going through an automatic car wash (it is best to ask the car wash operator for advice).
- When not in use, to reduce fuel consumption, wind noise and to guard against theft.

#### **WARNING**

- Use of an unapproved roof rack or incorrect mounting of an approved roof rack can cause the roof rack or the items attached to it to fall off the roof onto the road.
- Objects falling from the roof of a vehicle can cause a crash and personal injury.
- Only mount the roof rack on the designated locations on the roof ⇒ *fig. 62*.
- The roof rack system must be installed exactly according to the instructions provided.
- When driving with a roof rack system, changes to the center of gravity and wind resistance can change the vehicle handling and lead to a collision. Always adapt your driving and your speed to the current conditions.

#### **Note**

- Your vehicle warranty does not cover any damages to the vehicle caused by using roof racks or mounting structures not approved by Audi for your vehicle. The same applies to damage resulting from incorrect roof rack installation.
- Always check the roof rack mountings and hardware before each trip and during a trip to make sure everything is securely



tightened. If necessary, retighten the mountings and check the entire system from time to time.

- After mounting a roof rack system, or when you transport objects on the roof of your vehicle, the height of the vehicle is naturally increased. Be careful when driving under low bridges or in parking garages for example. This could cause damage to the load and even the vehicle itself.
- Make sure the open rear lid and the sun-roof\* do not come into contact with the roof rack.

### Loading the roof rack

*Always distribute loads evenly. Make sure anything on the roof rack is securely tied down.*

- ▶ Always distribute the loads on the roof rack evenly.
- ▶ Always attach items to the roof rack securely before you drive off.

The maximum permissible roof weight is **165 lb (75 kg)**. The roof weight is the total of the weight of the roof rack, the attachments and the cargo you are carrying. You must also not exceed the maximum load weight for the roof rack you are using.

When using a roof rack system which has a lower load carrying capacity, you must not use up the total maximum permissible load carrying capacity specified above. Instead, you should load the roof rack system only to the maximum capacity specified by the manufacturer of the roof rack system.

### WARNING

Weak, damaged or improper straps used to secure items to the roof rack can fail during hard braking or in a collision and cause serious personal injury.

- Make sure the roof rack is installed exactly as specified above ⇨ *page 62*.
- Always use suitable mounting straps for securing items to the roof rack to help prevent items from shifting or flying forward.

- Items on the roof rack must always be securely mounted.
- The use of a roof rack can negatively affect the way a vehicle handles. Cargo that is large, heavy, bulky, long or flat will have a greater negative influence on the vehicle's aerodynamics, center of gravity and overall handling. Always drive slowly, avoid sudden braking and maneuvers when transporting cargo on the roof of your vehicle.
- Never exceed the maximum permissible load carrying capacity of the roof of your vehicle, the permissible axle weights and the permissible total weight of your vehicle ⇨ *page 258, Weights*.



### For the sake of the environment

As a result of the increased wind resistance created by a roof rack, your vehicle is using fuel unnecessarily. So remove the roof rack after using it.



## Warm and cold

### Climate control system

#### Description

Different systems could be installed.

- manual climate control system\* or
- automatic climate control system\*

The **climate control system**\* cools and removes humidity from the air in the vehicle interior. It is the most effective when the windows and panorama sunroof\* are closed. If there is a build-up of heat inside the vehicle, ventilation can help to speed up the cooling process. For this reason, the windows and panorama sunroof can be opened from the outside. ⇨ *page 41, Convenience opening/closing*

#### Pollutant filter

The pollutant filter removes pollutants such as dust and pollen from the air.

#### Key recognition

You can store various settings for the manual and automatic **climate control system**\* and assign them to the key being used.

#### WARNING

Poor visibility can lead to accidents.

- For safer driving, keep all windows free of ice, snow and fog.
- Become familiar as quickly as possible with the correct use and function of the climate control system, especially with the defrosting and defogging function.
- When the temperature is below freezing, only use the windshield washer system after the windshield has been warmed by the cli-

mate control system. The washer fluid could freeze on the windshield and impair visibility.

#### Note

- If you suspect that the climate control system is damaged, switch the system off to prevent further damage and have it checked by an authorized Audi dealer or authorized Audi Service Facility.
- Repairs to the Audi climate control system require special technical knowledge and special tools. See an authorized Audi dealer or authorized Audi Service Facility.

#### For the sake of the environment

Reducing the amount of fuel used also reduces the amount of pollutants that enter the air.

#### Tips

- To prevent interference with the heating and cooling output and to prevent the windows from fogging over, the air intake in front of the windshield must be free of ice, snow or leaves.
- Condensation from the cooling system\* can drip and form a puddle of water under the vehicle. This is normal and does not mean there is a leak.
- The energy management system may switch the seat heating\* or rear window defroster off temporarily. These systems are available again as soon as the energy balance has been restored.
- The flows through the vents under the rear window. Make sure the openings are not covered when placing clothing on the luggage compartment cover.



## Climate control system controls

Applies to vehicles: with manual climate control system

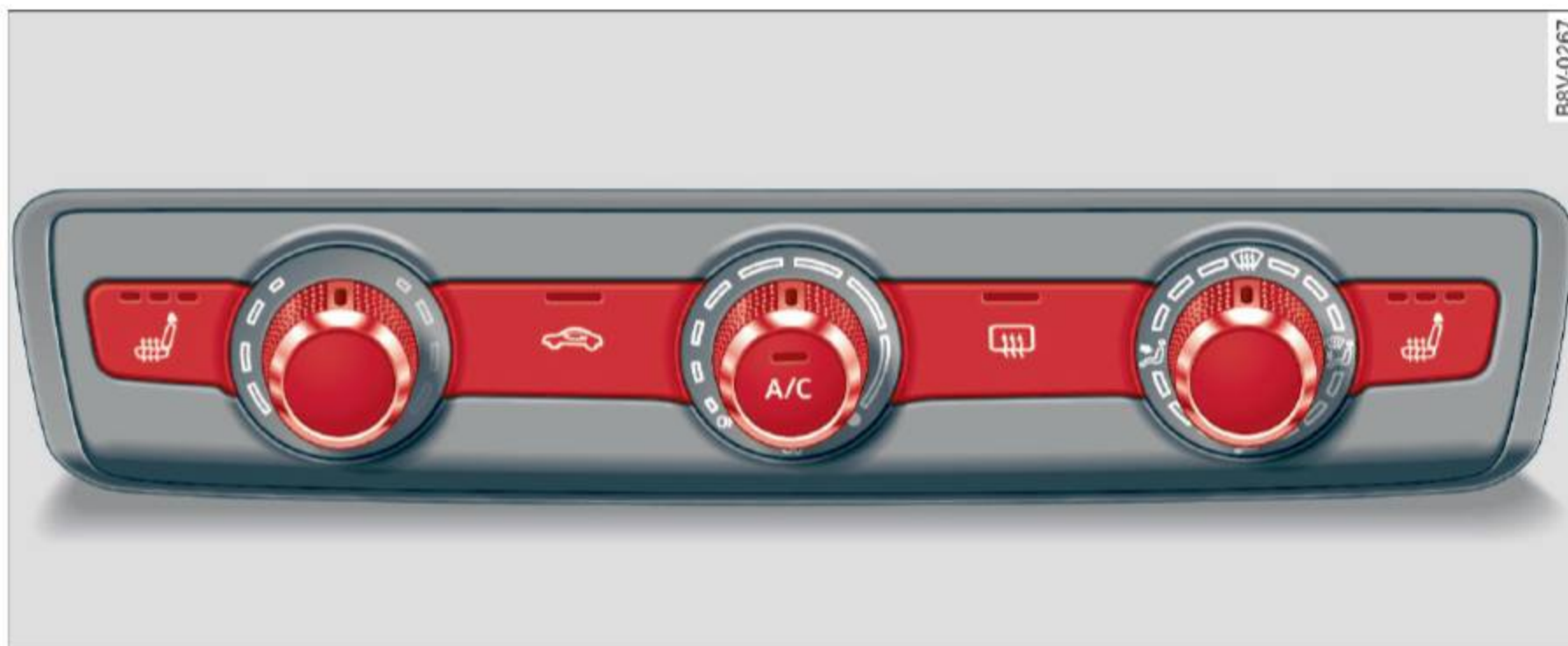



Fig. 63 Manual climate control system\*: controls

The functions are controlled using three dials and buttons. The LED in a button will light up when the function is switched on.

The rear window defogger  ⇒ *page 68* and the seat heating  ⇒ *page 68* are described separately.

### Manual climate control system\*

For a comfortable temperature, we recommend:

- in warmer times of the year, set the temperature so that it is only a few degrees below the outside temperature.
- set the blower at a moderate speed
- don't direct the air flow directly on the passengers

### **Switching the cooling mode\* on and off**

The cooling mode only functions with the blower turned on. The air is not cooled and humidity is not removed when cooling mode is switched off. This can cause fog on the windows. The cooling mode switches off automatically when there are cold outside temperatures.







### **Adjusting the blower**



To prevent the windows from fogging over, the blower should always run at a low speed. When the windows are fogged, we recommend using a higher blower speed and turning the knob to .

### **Adjusting the temperature**

The temperature can be adjusted in small increments with the dial.

### Adjusting air distribution and air vents

The **air distribution** is adjusted with the dials , ,  and . The setting between  and  provides a comfortable atmosphere in most cases.

In the  setting, the windshield and side windows are defrosted or cleared of condensation as quickly as possible. The recirculation mode switches off, but can be activated again by pressing the  button.

The round air vents in the cockpit are adjustable ⇒ *page 68*.

To keep the windows from fogging in damp weather, we recommend opening the side air vents and tilting them to the side ⇒ *page 68, Adjusting the air vents*.

Foot vents are located under the front seats to heat the rear of the vehicle.

### **Switching recirculation mode on and off**

In recirculation mode, the air inside the vehicle is circulated and filtered. This prevents the unfiltered air outside the vehicle from entering the



## Warm and cold

vehicle interior. We recommend switching recirculation mode on when driving through a tunnel or when sitting in traffic ⇒ .

Recirculation mode is switched off in the defrost setting .

### WARNING

You should not use the recirculation mode for an extended period since no fresh air is drawn in. With the air-conditioning\* switched off, the windows can fog up, which increases the risk of an accident.

## Automatic climate control system controls

Applies to vehicles: with automatic air conditioner



Fig. 64 Automatic climate control system: controls

The dial adjusts the temperature and the blower speed. Press the buttons to turn the functions on or off. The LED in a button will light up when the function is switched on.

The rear window defogger  ⇒ page 68 and the seat heating  ⇒ page 68 are described separately.



### Automatic climate control system

We recommend pressing the  button and setting the temperature to 72 °F (22 °C). The automatic climate control system automatically maintains a temperature once it has been set. The temperature of the air from the vents, fan speed, and air distribution are also automatically adjusted. In all heating mode functions except *defrost*, the blower only switches to a higher speed once the engine coolant has reached a certain temperature.

### Switching the cooling mode on and off

The cooling system is turned on and off with the  button. The air is not cooled and humidity is not removed when cooling mode is switched off. This can cause fog on the windows. The cooling mode switches off automatically when there are cold outside temperatures.

### Switching automatic mode on and off

The automatic mode is turned on using the  button. AUTO mode switches off once a button in the climate control system is pressed. Automatic mode maintains a constant temperature inside the vehicle. Air temperature, airflow and air distribution are controlled automatically. When automatic mode is active, pressing the  button briefly activates the “Eco” mode\*<sup>1)</sup>. In “Eco” mode\*, all settings are lowered slightly to save fuel. When in “Eco” mode\*, **Eco** is ►

1) This function is not available in all countries.



shown in the display. To exit “Eco” mode\*, press the **AUTO** button again.

### **Setting the temperature**



The temperature can be adjusted individually for the driver and front passenger using the dials. Temperatures between 60 °F (+16 °C) and 84 °F (+28 °C) can be set. If outside of this range, **LO** or **HI** will appear in the climate control system display. In both settings, the climate control runs with constantly at the maximum cooling or heating level. The temperature is not regulated.

**Synchronization:** by pressing the **AUTO** button for two seconds, the temperature setting for the driver is transferred to the front passenger's side. This applies a temperature change to the front passenger's side.

### **Adjusting the blower**

To prevent the windows from fogging over, the blower should always run at a low speed. You can adjust the volume of air generated by the blower to your preference. To have the blower regulated automatically, press the **AUTO** button.

### **Adjusting the air distribution**

The air distribution is adjusted with the ,  and  buttons. To have the air distribution regulated automatically, press the **AUTO** button.

The round air vents in the cockpit are adjustable ⇒ *page 68*.

To keep the windows from fogging in damp weather, we recommend opening the side air vents and tilting them to the side ⇒ *page 68, Adjusting the air vents*.

Foot vents are located under the front seats and adjustable vents on the end of the center console to heat the rear of the vehicle.

### **Switching the defroster on and off**

The windshield and side windows are defrosted or cleared of condensation as quickly as possible. The maximum amount of air flows mainly from the vents below the windshield. Recirculation mode switches off. The temperature is controlled automatically. In the  setting, the **A/C** cooling

mode switches on automatically, depending on the outside air temperature.



The **AUTO** button switches the defroster off.

### **Switching recirculation mode on and off**

The recirculation mode can be turned on manually or automatically\*.

- Switching manual recirculation mode on and off: press  The LED light up when switched on.
- Automatic\* recirculation mode: the auto recirculation must be activated in the MMI. Select: the **MENU** button > **Car** > **Systems\*** control button > **AC** > **Auto recirculation**. The air quality sensor that is designed for diesel and gasoline exhaust automatically switches the recirculation mode on or off depending on the level of pollutants in the outside air.

In recirculation mode, the air inside the vehicle is circulated and filtered. This prevents the unfiltered air outside the vehicle from entering the vehicle interior. We recommend switching recirculation mode on when driving through a tunnel or when sitting in traffic ⇒ .

The  button, **AUTO** or the  button switches recirculation mode off.

The system switches to recirculation mode when driving in reverse when the engine is cold.

### **WARNING**

You should not use the recirculation mode for an extended period since no fresh air is drawn in. With the air-conditioning switched off, the windows can fog up, which increases the risk of an accident.



## Adjusting the air vents

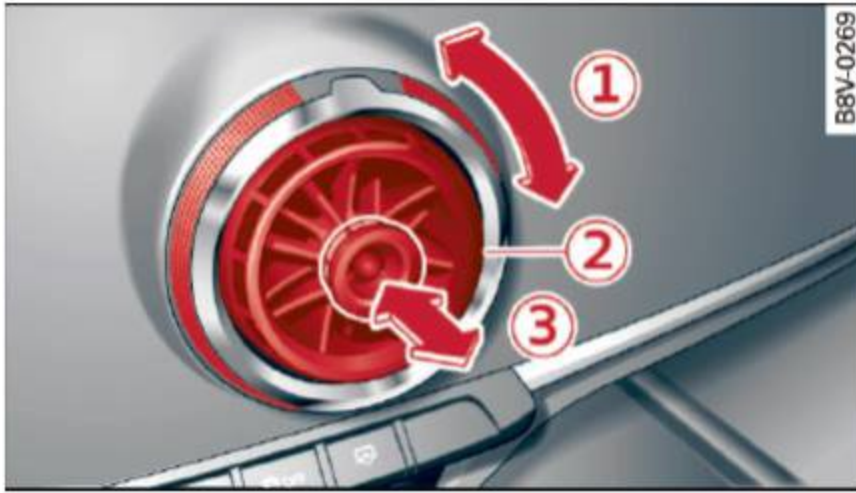

Fig. 65 Cockpit: adjusting the air vents

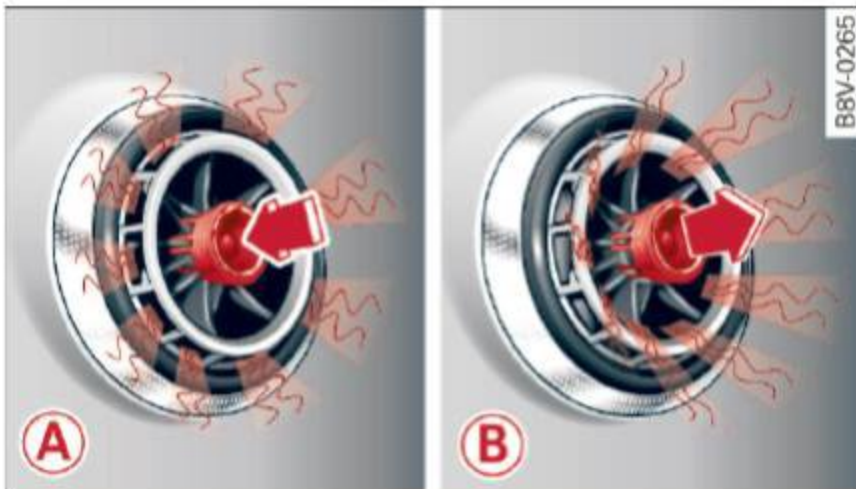

Fig. 66 Applies only to Canada: Vents: adjusting the air-flow setting A) Diffused B) Direct

The following settings are possible ⇒ *fig. 65*:

- ① Air flow amount
- ② Air flow direction
- ③ (*Applies only to Canada*) airflow setting (diffused or direct)

To adjust the **air flow amount**, turn the ridged outer adjusting ring ① ⇒ *fig. 65*. To stop the air flow, turn the adjusting ring all the way to the right.

To adjust the **air flow direction**, turn the air vent grill insert ②.

(*Applies only to Canada*) To adjust the **air flow settings**, pull or press the middle adjustment ring ③ ⇒ *fig. 65*:

- **Diffused** air flow (indirect ①): press the middle adjustment ring in lightly ⇒ *fig. 66*.
- **Direct** air flow (straight ②): pull the center adjustment ring out lightly ⇒ *fig. 66*.

## Rear window defogger

The LED in the button turns on when the function is switched on:

- Manual climate control system ⇒ *page 65, fig. 63*
- Automatic climate control system ⇒ *page 66, fig. 64*.

If the rear window defogger is activated when the ignition is switched on, the battery management determines based on the battery charge if it is possible to turn on. Otherwise, the rear window defogger functions with the engine running and switches off automatically after approximately 10 - 20 minutes, depending on the outside temperature.

To prevent the rear window defogger from switching off automatically, press and hold the or button for more than two seconds. This remains stored up to approximately 15 minutes after turning off the ignition.

## Seat heating

Applies to vehicles: with seat heating

The seat heating has three levels. The LED in the button indicates the selected heat level.

Manual climate control system ⇒ *page 65, fig. 63* and automatic climate control system ⇒ *page 66, fig. 64*.

- ▶ To switch the seat heating on, press the button once.
- ▶ To switch to a lower level, press the button again.
- ▶ To switch the seat heating off, press the button repeatedly until the LED turns off.

The seat heating switches automatically from setting 3 to setting 2 after 10 minutes.

### When seat heating should not be switched on

Do **not** turn the seat heating on under the following circumstances:

- The seat is unoccupied.
- The seat is covered with a seat cover.
- The seat is covered with a child seat.



- The seat is damp or wet.

** WARNING**

Individuals with reduced sensitivity to pain or temperature could develop burns when using the seat heating function. To reduce the risk of injury, these individuals should not use seat heating.

** Note**

To avoid damage to the heating elements in the seats, do not kneel on the seats or place heavy loads on a small area of the seat.

** Tips**

- The setting for the seat heating on the driver's side is assigned to the key that is in use.
- If the front passenger's seat heating is turned on, it will not turn on again automatically if more than 10 minutes have passed between switching the ignition off and switching it on again.

**Auxiliary heater**

Applies to vehicles: with diesel engine

In cool outside temperatures, the electric auxiliary heater helps the vehicle interior to warm more quickly. The auxiliary heater switches on and off automatically according to the vehicle heating settings.

The “auxiliary heater” function can be switched on and off in the MMI. Select: the **MENU** button > **Car** > **Systems\*** control button > **AC** > **Auxiliary heater**.



## Driving

### General information

#### The first 1,000 miles (1,500 km) and afterwards

The new engine needs to be run-in during the first 1,000 miles (1,500 km).

#### For the first 600 miles (1,000 kilometers):

- ▶ Do not use full throttle.
- ▶ Do not drive at engine speeds that are more than 2/3 of the maximum permitted RPM.
- ▶ Avoid high engine speeds.

#### From 600 to 1,000 miles (1,000 to 1,500 kilometers):

- ▶ Speeds can *gradually* be increased to the maximum permissible road or engine speed.

#### During and after break-in period

- ▶ Do not rev the engine up to high speeds when it is cold. This applies whether the transmission is in N (Neutral) or in gear.

#### After the break-in period

- ▶ Do not exceed maximum engine speed under any circumstances.
- ▶ Upshift into the next higher gear *before* reaching the red area at the end of the tachometer scale ⇨ *page 10*.

During the first few hours of driving, the engine's internal friction is higher than later when all the moving parts have been broken in. How well this break-in process is done depends to a considerable extent on the way the vehicle is driven during the first 1,000 miles (1,500 kilometers).

#### Note

Extremely high engine speeds are automatically reduced. However, these rpm limits are programmed for an engine well run-in, not a new engine.

#### For the sake of the environment

Do not drive with unnecessarily high engine speeds - upshifting early saves fuel, reduces noise and protects the environment.

### Driving through water on roads

Note the following to avoid vehicle damage when driving through water, for example on flooded roads:

- The water must not be any higher than the bottom of the vehicle body.
- Do not drive faster than walking speed.

#### WARNING

After driving through water or mud, the braking effect can be reduced due to moisture on the brake discs and brake pads. A few careful brake applications should dry off the brakes.

#### Note

Vehicle components such as the engine, transmission, suspension or electrical system can be severely damaged by driving through water.

#### Tips

- Determine the depth before driving through water.
- Do not stop the vehicle, drive in reverse or switch the engine off when driving through water.
- Keep in mind that oncoming vehicles may create waves that raise the water level and make it too deep for your vehicle to drive through safely.
- Avoid driving through salt water (corrosion).

## Economical and environmentally-friendly driving

### General

Your personal style of driving will determine the economy of your vehicle, as well as exhaust and noise levels.

Fuel economy, environmental impact, and wear on your engine, brakes and tires largely depend on three factors:

- your personal driving style
- operating conditions
- technical limitations



If you anticipate what you need to do next and drive economically, you can easily cut your fuel consumption by 10-15 percent. This section will give you some tips on how you can help the environment and your pocketbook.

### Tips

The consumption estimates as published by ENVIRONMENTAL PROTECTION AGENCY (EPA) and Transport Canada may not correspond to your actual consumption on the road, which will vary depending upon vehicle load and speed, road and weather conditions, trip length, etc.

### Drive smoothly and keep a lookout ahead

*Vehicles use the most fuel when they are accelerating.*

- ▶ Avoid unnecessary accelerating and braking.

Vehicles use the most fuel when they are accelerating. If you anticipate what is going to happen next, you will need to brake less and, thus, accelerate less. Let the vehicle coast whenever possible - for example when you see that the next traffic light is red.

### Avoid full throttle

*Driving at moderate speeds saves fuel and improves your mileage.*

- ▶ Try and keep well below your car's maximum speed.

Accelerating gently reduces fuel consumption, engine wear, and does not disturb the environment.

Fuel consumption, exhaust emissions and engine noise increase disproportionately at high speeds. If you drive at approximately three quarters of top speed, fuel consumption will be reduced by one half. Never drive faster than the posted speed limit and weather conditions permit.

### Reducing unnecessary idling

*Even when your car is just idling it burns up fuel.*

- ▶ Shut the engine off when you are not driving the vehicle.
- ▶ Do not warm up the vehicle by letting the engine run at idle.

It is efficient to switch off the engine when stopped at railroad crossings and long red lights. Turning the engine off for just 30-40 seconds saves more fuel than is burned by starting the engine again.

It takes a long time for the engine to warm up fully when it is running at idle. However, wear and noxious emissions are especially high when the engine is warming up. So you should drive away as soon as you start the engine and avoid running at high rpms while the engine is still warming up.

### Note

Do not leave engine idling unattended after starting. If warning lights should come on to indicate improper operation, they would go unheeded. Extended idling also produces heat, which could result in overheating or other damage to the vehicle or other property.

### Regular maintenance

*A badly tuned engine unnecessarily wastes a lot of fuel.*

- ▶ Have your vehicle serviced at regular intervals.

By having your vehicle regularly serviced by an Audi dealer helps to ensure that it runs properly and economically. The condition of your vehicle not only affects its safety and ability to hold its value, it also affects **fuel consumption**.

### Check your oil each time you fill your tank.

The amount of oil used is related to engine load and speed.

It is normal for the oil consumption of a new engine to reach its lowest value after a certain mileage has been driven. ▶



You must drive your vehicle about 3,000 miles (5,000 kilometers) before you can properly assess oil consumption.

This also applies to fuel consumption and engine output.

### Note

- Have your vehicle maintained properly and in accordance with the service recommendations in your Warranty & Maintenance booklet. Lack of proper maintenance as well as improper use of the vehicle will impair the function of the emission control system and could lead to damage.
- Do not alter or remove any component of the Emission Control System unless approved by the manufacturer.
- Do not alter or remove any device, such as heat shields, switches, ignition wires, valves, which are designed to protect your vehicle's Emission Control System and other important vehicle components.

### Fewer short trips

*Fuel consumption will always be relatively high on short trips.*

- ▶ Try to avoid driving short distances with a cold engine.

The engine and catalytic converter have to reach their optimal **operating temperature** to reduce fuel consumption and noxious emissions effectively.

Just after starting, a cold engine in a mid-size car only achieves a fuel economy of 6-8 miles per gallon (30-40 l/100 km). After about a half a mile, fuel economy climbs to 12 mpg (20 l/100 km). After about 2.5 miles (4 km), the engine is at its proper operating temperature and fuel economy has reached a normal level. So you can see that you should avoid short trips whenever possible.

The **outside temperature** is also critical in this regard. Your car consumes more fuel in the winter than in the summer.

## Steering

### Adjusting the steering wheel position

*The steering wheel position is fully adjustable up and down and forward and back.*



Fig. 67 Steering column: steering column adjustment lever

- ▶ Tilt the lever ⇒ *fig. 67* downward ⇒ .
- ▶ Bring the steering wheel into the desired position.
- ▶ Push the lever against the steering column until it latches.

### WARNING

Incorrect use of the steering wheel adjustment and an incorrect seating position can cause serious injuries.

- Only adjust the steering column when the vehicle is stationary so that you do not lose control of the vehicle.
- Adjust the driver's seat or steering wheel so that there is at least 10 inches (25 cm) distance between your chest and the steering wheel ⇒ *page 131, fig. 113*. If you do not maintain this distance, the airbag system will not be able to provide its full protection ⇒ *page 131, fig. 113*.
- If your physical characteristics prevent you from sitting at least 10 inches (25 cm) or more away from the steering wheel, see if your authorized Audi dealer or authorized Audi Service Facility can provide adapters that will help.
- If your face is level with the steering wheel, the airbag does not provide as much protection during a collision. Always make sure that the steering wheel is level with your chest.



- Always hold the steering wheel with your hands in the 9 o'clock and 3 o'clock positions to reduce the risk of injury if the airbag deploys.
- Never hold the steering wheel in the 12 o'clock position or with both hands on the rim or the center of the steering wheel. Holding the steering wheel incorrectly significantly increases the risk of injury to the hands, arms and head if the airbag deploys.

## Starting and stopping the engine (vehicles with an ignition lock)

### Starting the engine with the key

Applies to vehicles: with mechanical ignition lock

The ignition is switched on and the engine started with the key in the ignition.



Fig. 68 Ignition key positions

### Steering lock

If the steering wheel will not turn, the steering lock is engaged.

To engage the steering wheel lock: the selector lever must be in the P position.

- ▶ To engage the steering wheel lock, turn the wheel until it locks when the ignition key is removed.
- ▶ To release the steering wheel lock, insert the key in the ignition lock and turn the key in the -direction of the arrow- while turning the steering wheel.

### Switching the ignition on/off or prewarming

- ▶ To switch the ignition on, turn the ignition key to position ①.

- ▶ To switch the ignition off, turn the ignition key to position ①.

Diesel vehicles are preheated while the ignition is switched on ①.

### Starting the engine

Your vehicle is equipped with launch control. As soon as you have turned the ignition key to position ②, the engine will start automatically.

- ▶ Press the brake pedal and move the selector lever to the P or N position.
- ▶ Turn the key briefly to position ②. The ignition key automatically returns to position ①. Do not press the accelerator pedal when doing this.

Major electrical equipment switches off temporarily when starting the engine.

It is possible that there will be a slight delay when starting the engine in diesel vehicles in colder temperatures. Therefore, you must hold the brake pedal down until the engine starts. The indicator light turns on while the engine is preheating ①.

The prewarming time depends on the coolant temperature and outside temperature. The glow plug indicator light ① will only turn on for approximately 1 second when the engine is warm or the outside temperature is higher than 8 °C. That means you can start the engine *immediately*.

If the engine does not start immediately, stop the starting procedure by turning the ignition key to position ① and repeat after 30 seconds.

### Automatic start malfunction

If the **EPC** (gasoline engine) or ① (diesel engine) indicator light turns on and the message **Engine start system malfunction. Please contact Service** appears, there is an automatic start malfunction.

To start the engine, hold the ignition key in position ② until the engine runs.

Drive to an authorized Audi dealer or authorized Audi Service Facility immediately to have the malfunction corrected. ▶



## **WARNING**

- Never allow the engine to run in confined spaces, because this increases the risk of asphyxiation.
- Never remove the ignition key from the ignition lock while the vehicle is moving. Otherwise the steering lock will engage and you will not be able to steer the vehicle.
- Please note that the brake booster and power steering only work when the engine is running. When the engine off, you must use more force to steer or brake the vehicle. Because the usual steering and braking capability is not available, the risk of accidents or injuries increases.
- Always take the vehicle key with you when leaving the vehicle, even for a short period of time. This applies particularly when children remain in the vehicle. Otherwise the children could start the engine or operate electrical equipment such as power windows.

## **Note**

- Avoid high engine speed, full throttle, and heavy engine load as long as the engine has not reached operating temperature yet. You could damage the engine.
- The engine cannot be started by pushing or towing.

## **For the sake of the environment**

Do not let the engine run while parked to warm up. Begin driving immediately. This reduces unnecessary emissions.

## **Tips**

- If it is difficult to turn the key to position ①, turn the steering wheel back and forth slightly to release the steering wheel lock.
- After starting a cold engine, there may be a brief period of increased noise because the oil pressure must first build up in the hydraulic valve adjusters. This is normal and not a cause for concern.
- If the battery is disconnected and reconnected, you have to hold the ignition key in

position ① for five seconds for the engine to start.

- After switching the ignition off, you can only remove the key when the selector lever is in the “P” (Park) position. After that, the selector lever is locked.

## **Stopping the engine with the key**

Applies to vehicles: with mechanical ignition lock

### **Stopping the engine**

- ▶ Bring the vehicle to a full stop.
- ▶ Turn the key to position ①.

### **Releasing the steering lock**

Requirement: The selector lever must be in the P position.

- ▶ Remove the ignition key in position ①  
⇒ *page 75, fig. 69* ⇒ .
- ▶ Turn the steering wheel until you hear the steering wheel lock.

The locked steering helps prevent vehicle theft.

## **WARNING**

- Never turn off the engine before the vehicle has come to a complete stop. The full function of the brake booster and the power steering is not guaranteed. You must use more force to turn or brake if. Because you cannot steer and brake as you usually would, this could lead to accidents and serious injuries.
- Never remove the ignition key from the ignition lock while the vehicle is moving. Otherwise, the steering lock could suddenly engage and you would not be able to steer the vehicle.
- Please note that the brake booster and power steering only work when the engine is running. When the engine off, you must use more force to steer or brake the vehicle. Because the usual steering and braking capability is not available, the risk of accidents or injuries increases.
- Always take the vehicle key with you when leaving the vehicle, even for a short period of time. This applies particularly when



children remain in the vehicle. Otherwise the children could start the engine or operate electrical equipment such as power windows.

- For safety reasons, always park the vehicle with the selector lever in the P position. Otherwise, there is the risk that the vehicle could roll.
- After the engine has been switched off, the radiator fan can continue to run for up to 10 minutes - even with the ignition switched off. It can also switch on again after some time if the coolant temperature rises as a result of heat buildup or if the engine compartment is heated by sunlight and the engine is hot.

### ! Note

- If the engine has been under heavy load for an extended period of time, heat builds up in the engine compartment after the engine is switched off - there is a risk of damaging the engine. For this reason, let the engine run for at idle for approximately two minutes before shutting it off.

## Starting and stopping the engine (vehicles with a convenience key)

### Engine with the button **START ENGINE STOP** Starting

Applies to vehicles: with convenience key

The **START ENGINE STOP** button switches the ignition on and starts the engine.



Fig. 69 Center console: START ENGINE STOP button (with convenience key)

You can start your car without using your convenience key. You must simply be carrying the key with you.

### Switching the ignition on/off or prewarming

If the  indicator light blinks and the message **Please move steering wheel** appears when switching the ignition on, the steering is locked by the steering lock. In this case, turn the steering wheel slightly to the left/right.

- ▶ To switch the ignition on/off, press the **START ENGINE STOP** button. Do not press the brake pedal while doing this.

Diesel vehicles are preheated while the ignition is switched on .

### Starting the engine

Your vehicle is equipped with launch control. The engine starts automatically when you press the **START ENGINE STOP** button briefly.

- ▶ Press the brake pedal and move the selector lever to the P or N position.
- ▶ Press the **START ENGINE STOP** button briefly. The engine will start.

Major electrical equipment switches off temporarily when starting the engine.

It is possible that there will be a slight delay when starting the engine in diesel vehicles in colder temperatures. Therefore, you must hold the brake pedal down until the engine starts. The indicator light turns on while the engine is preheating .

The prewarming time depends on the coolant temperature and outside temperature. The glow plug indicator light  will only turn on for approximately 1 second when the engine is warm or the outside temperature is higher than 8 °C. That means you can start the engine *immediately*.

If the engine does not start immediately, stop the starting procedure by pushing the **START ENGINE STOP** button again and repeat after 30 seconds. ▶



### Automatic start malfunction

If the **EPC** (gasoline engine) or  (diesel engine) indicator light turns on when you start the engine, there is an automatic start malfunction.

To start the engine, press and hold the **START ENGINE STOP** button until the engine runs.

Drive to an authorized Audi dealer or authorized Audi Service Facility immediately to have the malfunction corrected.

#### **WARNING**

- Never allow the engine to run in confined spaces - danger of asphyxiation.
- Always take the vehicle key with you when leaving the vehicle, even for a short period of time. This applies particularly when children remain in the vehicle. Otherwise the children could start the engine or operate electrical equipment such as power windows.
- Please note that the brake booster and power steering only work when the engine is running. When the engine off, you must use more force to steer or brake the vehicle. Because the usual steering and braking capability is not available, the risk of accidents or injuries increases.

#### **Note**

- Avoid high engine speed, full throttle, and heavy engine load as long as the engine has not reached operating temperature yet. You could damage the engine.
- The engine cannot be started by pushing or towing.

#### **For the sake of the environment**

Do not let the engine run while parked to warm up. Begin driving immediately. This reduces unnecessary emissions.

#### **Tips**

- After starting a cold engine, there may be a brief period of increased noise because the oil pressure must first build up in the hydraulic valve adjusters. This is normal and not a cause for concern.
- If the  indicator light blinks in the instrument cluster before switching the ignition off, the ignition will not switch on again.  
⇒ page 126
- If you leave your vehicle with the ignition switched on, the ignition will switch off after a certain amount of time. Make sure that electrical equipment such as the exterior lights are switched off.

#### **Turning the engine off using the **START ENGINE STOP** button**

Applies to vehicles: with convenience key

- ▶ Bring the vehicle to a full stop.
- ▶ Move the selector lever into the P position.
- ▶ Press the **START ENGINE STOP** button  
⇒ page 75, fig. 69.

#### **Steering lock<sup>1)</sup>**

The steering locks when you turn the engine off using the **START ENGINE STOP**\* button, move the selector lever into the P position and open the driver's door.

The locked steering helps prevent vehicle theft.

#### **Emergency off**

If it is absolutely necessary, the engine can also be turned off while driving at speeds lower than 6 mph (10 km/h). To switch the engine off, press the **START ENGINE STOP** button twice in a row briefly or press and hold for longer than two seconds.

#### **WARNING**

- Never turn off the engine before the vehicle has come to a complete stop. The full function of the brake booster and the power steering is not guaranteed. You must use

<sup>1)</sup> This function is not available in all countries.



more force to turn or brake if necessary. Because you cannot steer and brake as you usually would, this could lead to crashes and serious injuries.

- Please note that the brake booster and power steering only work when the engine is running. When the engine off, you must use more force to steer or brake the vehicle. Because the usual steering and braking capability is not available, the risk of accidents or injuries increases.
- Always take the vehicle key with you when leaving the vehicle, even for a short period of time. This applies particularly when children remain in the vehicle. Otherwise the children could start the engine or operate electrical equipment such as power windows.
- For safety reasons, always park the vehicle with the selector lever in the P position. Otherwise, there is the risk that the vehicle could roll.
- After the engine has been switched off, the radiator fan can continue to run for up to 10 minutes - even with the ignition switched off. It can also switch on again after some time if the coolant temperature rises as the result of heat buildup or if the engine compartment is heated by the sun's rays and the engine is hot.

### Note

If the engine has been under heavy load for an extended period of time, heat builds up in the engine compartment after the engine is switched off - there is a risk of damaging the engine. For this reason, let the engine run for at idle for approximately two minutes before shutting it off.

### Starting the engine if there is a malfunction

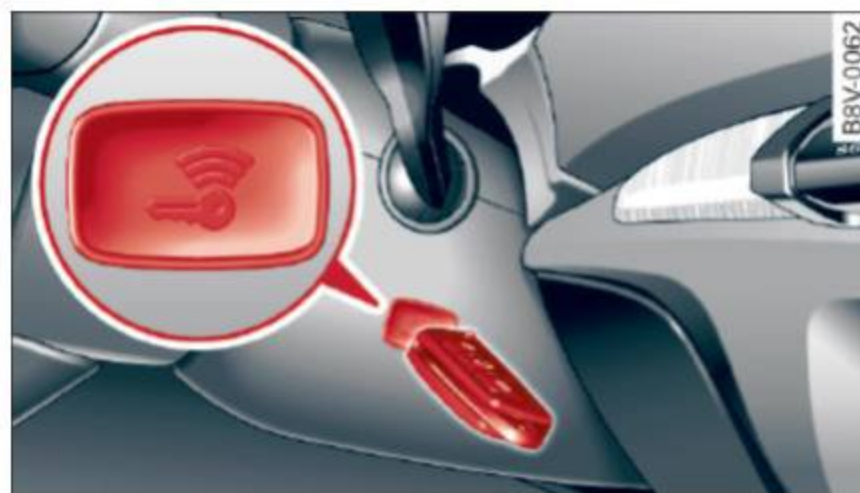

Applies to vehicles: with convenience key

*It may not be possible to start the engine under certain circumstances, for example if the battery in the vehicle key is drained, if interference is affected the key or if there is a system malfunction.*



**Fig. 70** Steering column/remote control key: starting the engine if there is a malfunction

As long as the message  **Key not recognized. See owners manual** appears, you can start your vehicle using the emergency start function.

- ▶ Press the brake pedal   in Engine with the button **START ENGINE STOP** Starting on page 76.
- ▶ Press the **START ENGINE STOP** button.
- ▶ Hold the master key in the location indicated as shown in the illustration   $\Rightarrow$  fig. 70. The engine will start.
- ▶ If the engine does not automatically start, press the **START ENGINE STOP** button again.

Drive to an authorized Audi dealer or authorized Audi Service Facility immediately to have the malfunction corrected.

### Tips

You can display the message that appears during an emergency by pressing the **START ENGINE STOP**\* button.

## Driver messages

**Turn off ignition before leaving car. Battery is discharging** 



This message appears and a warning tone sounds if you open the driver's door when the ignition is switched on. Switch the ignition off so that the battery will not discharge.

### Pressing start/stop button again will switch off engine!

This message appears when you press the **START ENGINE STOP**\* button while driving ⇒ *page 76, Emergency off.*

### Engine start system malfunction. Please contact Service

The engine automatic start system has a malfunction. Drive to an authorized Audi dealer or authorized Audi Service Facility immediately to have the malfunction corrected. To start the engine, press and hold the **START ENGINE STOP** button.

### Key not recognized. See owner's manual

This message appears if there is no convenience key inside the vehicle or if the system does not recognize the key. The convenience key may not be recognized, for example, if it is covered by an object that *disrupts* the signal (such as a briefcase), or if the key battery is weak. Electronic devices such as cell phones can also interfere with the signal.

To still be able to start or stop the engine, refer to "Correcting a malfunction" ⇒ *page 77.*

### Key not in vehicle?

The  indicator light turns on and this message appears if the convenience key was removed from the vehicle when the engine was running. If the convenience key is no longer in the vehicle, you cannot switch the ignition on or start the engine once you stop it. In addition, you cannot lock the vehicle from the outside.

### Press brake pedal

This message appears if you do not press the brake pedal when starting the engine.

### Please engage N or P

This message appears when starting or stopping the engine if the selector lever is not in the N or P position. The engine will not start/stop.

### Shift to P, otherwise vehicle can roll away.

### Doors do not lock if lever is not in P

This message appears for safety reasons along with a warning tone. It appears if the selector lever for the automatic transmission is not in the P position when switching the ignition off with the **START ENGINE STOP**\* button. Shift the selector lever to the P position. Otherwise, the vehicle could roll. You also cannot lock the vehicle using the locking sensor on the door handle or using the convenience key.

## Electromechanical parking brake

### Operating

*The electromechanical parking brake replaces the hand brake.*



Fig. 71 Center console: parking brake

- ▶ Pull the switch **A** ⇒ *fig. 71* to set the parking brake. The **PARK** (USA models) / **P** (Canada models) indicator lights in the button and in the instrument cluster display turn on.
- ▶ To release the parking brake, press the brake or accelerator pedal while the ignition is switched on and press the button **A** at the same time. The **PARK** (USA models) / **P** (Canada models) indicator lights in the button and in the display turn off.

Your vehicle is equipped with an electromechanical parking brake. The parking brake is designed to prevent the vehicle from rolling unintentionally and replaces the hand brake.

In addition to the normal functions of a traditional hand brake, the electromechanical parking



brake provides various convenience and safety functions.

### When starting from rest

- The integral hill start assist helps you when driving by automatically releasing the parking brake ⇒ *page 80, Starting from a stop.*
- When starting on inclines, the hill start assist prevents the vehicle from unintentionally rolling back. The braking force of the parking brake is not released until sufficient driving force has been built up at the wheels.





### Emergency brake function

An emergency braking functions ensures that the vehicle can be slowed down even if the *normal* brakes fail ⇒ *page 80, Emergency braking function.*



#### WARNING

- Do not press the accelerator pedal inadvertently if the vehicle is stationary but the engine is running and a gear is selected. Otherwise the vehicle will start to move immediately and could result in a crash.
- If the power supply fails, the released parking brake can no longer engage. In this case, park the vehicle on level ground and secure it by placing the selector lever in the P position. See an authorized Audi dealer or authorized Audi Service Facility for assistance.

#### Note

- If the  or **BRAKE** (USA models) /  (Canada models) indicator light in the instrument cluster blinks, there is a malfunction in the brake system. Refer to the detailed description of the indicator lights ⇒ *page 17.*
- If the **PARK** (USA models) /  (Canada models) or  indicator light turns on, there is a malfunction in the parking brake ⇒ *page 18.*



#### Tips

- If the parking brake is set while the ignition is switched off, the  indicator light in the button and in the instrument cluster display **PARK** (USA models) /  (Canada mod-

els) will turn off after a certain amount of time.

- If driver's door is opened while the ignition is switched on, the parking brake sets automatically. This prevents unintended rolling of the vehicle.
- Occasional noises when the parking brake is applied and released are normal and are not a cause for concern.
- When the vehicle is parked, the parking brake goes through a self-test cycle at regular intervals. Any noises associated with this are normal.
- If there is a power failure, the parking brake will not set if it is released, and it will not release if it is set ⇒ . See an authorized Audi dealer or authorized Audi Service Facility for assistance.

### Parking

- ▶ Press the brake pedal to stop the vehicle.
- ▶ Pull the switch  ⇒ *page 78, fig. 71* to set the parking brake.
- ▶ Place the selector lever in the P position.
- ▶ Turn the engine off ⇒ .
- ▶ Turn the steering wheel when parking on inclines so that the wheels will roll into the curb if the vehicle starts moving.

#### WARNING

- Always take the vehicle key with you when leaving the vehicle, even for a short period of time. This applies particularly when children remain in the vehicle. Otherwise the children could start the engine, release the parking brake or operate electrical equipment (e.g. power windows). There is the risk of an accident.
- When the vehicle is locked, no one - particularly not children should remain in the vehicle. Locked doors make it more difficult for emergency workers to get into the vehicle, which puts lives at risk.



### Starting from a stop

The start assist function ensures that the parking brake is released automatically upon starting.

### Stopping and applying parking brake

- ▶ Pull the switch  ⇒ page 78, fig. 71 to set the parking brake.

### Starting and automatically releasing the parking brake

Requirement: The driver's door must be closed.

- ▶ When you press the accelerator pedal, the parking brake is automatically released and your vehicle begins to move.

When stopping at a traffic signal or stopping in city traffic, the parking brake can be applied. The vehicle does not have to be held with the brake pedal. The parking brake eliminates the tendency to creep when a selector lever position is engaged. As soon as you press the accelerator pedal, the parking brake releases automatically and the vehicle starts to move.

### Starting on slopes



When starting on inclines, the hill start assist prevents the vehicle from unintentionally rolling back. The braking force of the parking brake is not released until sufficient driving force has been built up at the wheels.

#### Tips

For safety reasons, the parking brake only releases automatically when the driver's door is closed.



### Emergency braking function

In the event that the conventional brake system fails or locks.

- ▶ To brake your vehicle in an emergency, pull the  switch ⇒ page 78, fig. 71 and hold it pulled.
- ▶ As soon as you release the  switch or accelerate, the braking process stops.

Pulling and holding the  switch while driving at a speed of about 2 mph (3 km/h) or higher ini-

tiates the emergency braking function. The vehicle is braked at all four wheels by activating the hydraulic brake system. The brake performance is similar to heavy braking. ⇒ 

To help prevent activating the emergency braking by mistake, an audible warning tone (buzzer) sounds when the  switch is pulled. Emergency braking stops as soon as the  switch is released or the accelerator pedal is pressed.

#### WARNING

Emergency braking should only be used in an emergency, when the normal brake pedal has failed or the brake pedal is obstructed. During emergency braking, your vehicle will brake similar to heavy braking. ESC and the associated components (ABS, ASR, EDL) cannot overcome the laws of physics. In corners and when road or weather conditions are bad, a full brake application can cause the vehicle to skid or the rear end to break away, which increases the risk of an accident.

### Hill hold

Applies to vehicles: with Hill Hold

*Hill hold makes it easier to start on hills.*

Requirement: The driver door must be closed and the engine must be running.

The system is activated when the brake pedal is pressed while the vehicle is stationary.

To prevent the vehicle from rolling back when starting, the brake power is held for a brief moment after releasing the brake pedal. During this time, you can easily begin to move your vehicle.

#### WARNING

- The intelligent technology of Hill Hold cannot overcome the limitations imposed by natural physical laws. The increased comfort offered by Hill Hold should not cause you to take safety risks.
- Hill Hold cannot hold the vehicle in all hill start situations (for example, if the ground is slippery or icy).



- If you do not begin moving immediately after releasing the brake pedal, the vehicle could begin to roll backward under certain circumstances. Press the brake pedal or set the parking brake immediately.
- If the engine “stalls”, press the brake pedal or set the parking brake immediately.
- Starting on inclines in stop-and-go traffic:  
To help prevent the vehicle from rolling back when starting, press and hold the brake pedal for several seconds when the vehicle is stationary.

** Tips**

You can find out if your vehicle is equipped with Hill Hold by checking at an authorized Audi dealer or authorized Audi Service Facility.



# Automatic transmission

## S tronic

### Introduction

Applies to vehicles: with S tronic transmission

Your vehicle is equipped with an electronically-controlled DSG transmission called S tronic. Two independent clutches transfer the power between the engine and transmission. It allows the vehicle to accelerate without a noticeable interruption in traction.

The transmission upshifts or downshifts automatically. The driving style continuously influences the selection of the driving program.

When a **moderate driving style** is used, the transmission selects the most economical driving mode. The transmission upshifts at a lower RPM and downshifts at a higher RPM to improve fuel efficiency.

The transmission switches to a sporty mode after a kick-down or when the driver uses a **sporty driving style** characterized by quick accelerator pedal movements, heavy acceleration, frequent changes in speed and traveling at the maximum speed.

If desired, the driver can also select the gears manually (**tiptronic mode**) ⇒ page 87, *Shifting manually (tiptronic mode)*.

### Selector lever positions

Applies to vehicles: with S tronic transmission

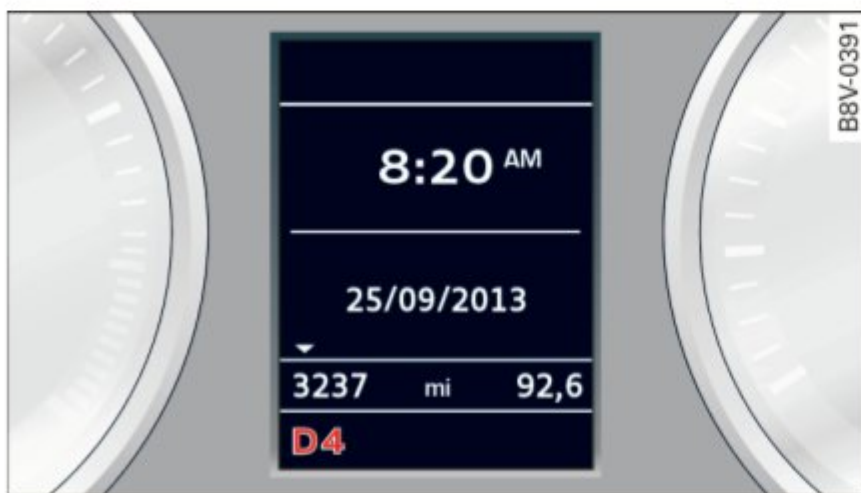

Fig. 72 Instrument cluster: Selector lever positions

The instrument cluster display shows the current selector lever position and current gear.

### P - Park

The wheels are mechanically locked in this position. You can only shift into Park when the vehicle is *stationary* ⇒ ⚠.

To shift in and out of the P selector lever position, press the interlock button in the selector lever *while* pressing the brake pedal.

### R - Reverse

Only shift into reverse gear when the vehicle is *stationary* and the engine is running at idle speed ⇒ ⚠.

To select the R selector lever position, press the interlock button *while* pressing the brake pedal. The back-up lights switch on in the R position if the ignition is switched on.

### N - Neutral

The transmission is in idle in this position.

### D/S - Normal position for driving forward

In the D/S selector lever position, the transmission can be operated either in the normal D mode or in the S sport mode. To select the S sport mode, pull the selector lever back briefly. Pulling the lever back again will select the normal D mode. The instrument cluster display shows the selected driving mode.

In the **normal mode** D, the transmission automatically selects the suitable gear ratio. It depends on engine load, vehicle speed and driving style.

Select the **sport mode** S for sporty driving. The vehicle makes full use of the engine's power. Shifting is may become noticeable when accelerating.

To move from selector lever position N to D, you must press the brake pedal and the vehicle must be traveling less than 1 mph (2 km/h) or be stationary ⇒ ⚠.

### ⚠ WARNING

- Read and following all WARNINGS.
- The vehicle can roll even if the ignition is switched off.



- Never select R or P while driving, because this increases the risk of an accident.
- Power is still transmitted to the wheels when the engine is running at idle. To prevent the vehicle from “creeping”, you must keep your foot on the brake in all selector lever positions (except P) when the engine is running. Otherwise, this increases the risk of an accident.
- Do not inadvertently press the accelerator pedal when the vehicle is stopped if a gear is engaged. Otherwise the vehicle will start to move immediately, even if the parking brake is set. This could result in a crash.
- Do not press the accelerator pedal when changing the selector lever position while the vehicle is stationary and the engine is running.
- Never leave your vehicle with the engine running while in gear. If you must leave your vehicle when the engine is running, set the parking brake and move the selector lever to the P position.
- Before opening the hood and working on a running engine, select the P position with the selector lever and activate the parking brake. Always read and follow the applicable warnings ⇒ *page 198, Working in the engine compartment.*

### ! Note

Never let the vehicle roll downhill with engine off and the selector lever in the N position, because this could damage the automatic transmission and catalytic converter.

### i Tips

- Audi drive select: Sporty shifting characteristics can be selected using the **Dynamic** driving mode. S will appear in the instrument cluster display instead of D.
- If you accidentally select N while driving, take your foot off the accelerator pedal immediately and wait for the engine to slow down to idle before selecting D or S.
- If there is a power failure, the selector lever will not move out of the P position. The

emergency release can be used if this happens ⇒ *page 89.*

### Selector lever lock

Applies to vehicles: with S tronic transmission

*The selector lever lock prevents you from selecting a gear accidentally, causing the vehicle to roll.*

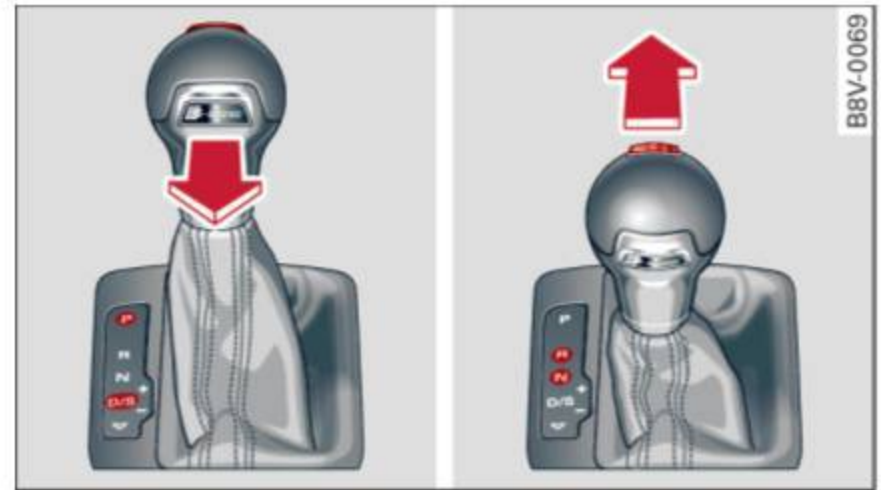

Fig. 73 Selector lever lock

To release the selector lever lock:

- ▶ Switch on the ignition.
- ▶ Press the brake pedal *while* pressing the interlock button.

### Automatic shift lock (ASL)

The selector lever is locked in the P and N positions when the ignition is switched on. You must press the brake pedal to select another position. You must also press the interlock button if you are moving from the P position. The following message appears in the display when the selector lever is in the P or N position to remind the driver:

#### When stationary apply footbrake while selecting gear

The automatic shift lock only functions when the vehicle is stationary or at speeds below 1 mph (2 km/h). At higher speeds, the lock is automatically deactivated in the N position.

The selector lever is not locked when shifting quickly through N, for example from R to D. This makes it possible to free the vehicle when it is stuck by “rocking” it. The selector lever lock engages if the lever stays in the N position longer ▶



than approximately 2 seconds when the brake pedal is not pressed.

### Interlock button

The interlock button in the selector lever handle prevents you from moving the selector lever inadvertently while in some selector lever positions. The positions that require the interlock button to be pressed are marked in color in the illustration ⇒ *fig. 73*.

### Ignition key safety interlock\*

You can only remove the key from the ignition after switching the ignition off if the selector lever is in the P position. The selector lever will be locked in the P position as long as the key is not in the ignition.

#### **WARNING**

Read and following all WARNINGS. ⇒  in *Selector lever positions on page 82*.

#### **Tips**

- If the selector lever does not engage, there is a malfunction. The engine is disabled to prevent the vehicle from driving off unintentionally. Press the brake pedal briefly to allow the selector lever lock to engage again.
- If the vehicle does not move forward or in reverse even though a drive position is selected, proceed as follows:
  - >If the vehicle does not move in the desired direction, the system may not have engaged the drive position correctly. Press the brake pedal and select the drive position again.
  - >If the vehicle still does not move in the desired direction, there is a system malfunction. See an authorized Audi dealer or authorized Audi Service Facility for assistance to have the system checked.

### Driving tips

Applies to vehicles: with S tronic transmission

*The transmission shifts up and down automatically when in the driving gears.*



**Fig. 74** Section of the center console: selector lever with interlock button

The engine will only be able start when the selector lever is in the P or N positions. At low temperatures (below 14 °F (-10 °C)), the engine can only be started when the selector lever is in the P position.

### Starting from a stop

- ▶ Press and hold the brake pedal.
- ▶ Press and hold the interlock button in the selector lever handle, select the desired selector lever position such as D ⇒ *page 82* and release the lock button.
- ▶ Wait a moment until the transmission shifts. You will notice a slight movement when the gear engages.
- ▶ Release the brake pedal and press the accelerator pedal ⇒ .

### Stopping temporarily

- ▶ Keep the vehicle stationary using the braking pedal, for example at traffic lights.
- ▶ Do not press the accelerator pedal when doing this.
- ▶ To prevent the vehicle from rolling when you start driving, set the parking brake when stopping on steep inclines ⇒ .
- ▶ The parking brake will release automatically and the vehicle will start moving once you press the accelerator pedal. Requirement: The door must be closed. ▶





## Stopping/parking

If the selector lever is not in the P position when you open the driver's door, the vehicle could roll. In vehicles with a convenience key\*, the message: **Shift to P, otherwise vehicle can roll away. Doors do not lock if lever is not in P** appears. You will also hear a warning tone.

- ▶ Press and hold the brake pedal ⇒ .
- ▶ Set the parking brake.
- ▶ Select the P selector lever position.

## Stopping on an incline

- ▶ *Always* press the brake pedal to hold the vehicle in place and prevent it from "rolling back" ⇒ . Do **not** try to prevent the vehicle from "rolling back" when a gear is engaged by increasing the engine speed ⇒ .

## Starting on an incline in vehicles without Hill Hold\*

- ▶ Set the parking brake.
- ▶ With the driving gear selected, press the accelerator pedal carefully. The parking brake releases automatically. Requirement: The door must be closed.

## Starting on an incline in vehicles with Hill Hold\*

- ▶ With the driving gear selected, remove your foot from the brake pedal and press the accelerator pedal ⇒ *page 80, Hill hold*.

Under certain circumstances, (such as driving in the mountains or towing a trailer), it may be useful to switch temporarily to the manual shift program in order to adjust the gears to the driving conditions by hand ⇒ *page 87*.

When parking on a level surface, simply place the selector lever in the P position. On inclines, activate the parking brake first and then move the selector lever to the P position ⇒ *page 78*. This prevents the locking mechanism from being loaded too heavily and will make it easier to move the selector lever out of the P position.



## WARNING

- The vehicle can roll even when the engine is switched off.
- Unintended vehicle movement can lead to serious injuries.
- Never leave your vehicle with the engine running while in gear. If you must leave your vehicle when the engine is running, set the parking brake and move the selector lever to the P position.
- Power is still transferred to the wheels when the engine is running at idle. To prevent the vehicle from "creeping", you must keep your foot on the brake when the engine is running and the selector lever is in the D, S or R position or "tiptronic" mode is selected.
- Do not inadvertently press the accelerator pedal when the vehicle is stationary. Otherwise the vehicle will start to move immediately, even if the parking brake is set. This could result in a crash.
- Do not press the accelerator pedal when changing the selector lever position while the vehicle is stationary and the engine is running.
- Never engage the R or P selector level positions while driving. It could cause a crash.
- Before driving down a steep slope, reduce your speed and shift into a lower gear with "tiptronic".
- Do not ride the brakes or press the brake pedal too often or too long when driving down a hill. Constant braking causes the brakes to overheat and substantially reduces braking performance, increases braking distance or causes complete failure of the brake system.
- If you must stop on an incline, always hold the vehicle in place with the foot brake or parking brake to prevent it from rolling back.
- Never hold the vehicle on an incline with a slipping clutch. The clutch opens automatically when it becomes too hot from the overload. The  indicator light turns on and a message appears ⇒ *page 88* when the clutch is overloaded.



- If the engine must run while you are working in the engine compartment with the hood open, make sure a gear is not engaged. The selector lever must be firmly in the P position and locked in place and the parking brake must be set ⇒ *page 198*. Otherwise, the vehicle could begin moving when the engine speed is high, even with the parking brake set.

### Note

- When stopping on an incline, do not try to hold the vehicle in place by pressing the accelerator pedal while a driving gear is selected. This can cause the automatic transmission to overheat and can damage it. Activate the parking brake or press the brake pedal to prevent the vehicle from rolling.
- Allowing the vehicle to roll when the engine is stopped and the selector lever is in the N position will damage the automatic transmission because it is not lubricated under those circumstances.
- The transmission can overheat and be damaged under certain driving and traffic conditions such as frequent starts, creeping for a long time, or stop-and-go traffic. When the  or  indicator light turns on, stop the vehicle at the next opportunity and let the transmission cool ⇒ *page 88*.
- Allowing the vehicle to roll when the engine is stopped will damage the S tronic transmission because it is not lubricated ⇒ *page 254, Towing with a tow truck*.

### Tips

For safety reasons, the parking brake only releases automatically when the driver's door is closed.

## Hill descent control

Applies to vehicles: with S tronic transmission

*The hill descent control system assists the driving when driving down declines.*

Hill descent control is activated when the selector lever is in the D or S position and you press

the brake pedal. The transmission automatically selects a gear that is suitable for the incline. Hill descent control tries to maintain the speed achieved at the time of braking, within physical and technical limitations. It may still be necessary to adjust the speed with the brakes. Because hill descent control cannot shift down farther than 3rd gear, it may be necessary to shift into tiptronic mode in very steep areas. In this case, shift into 1st or 2nd gear in tiptronic mode to use the engine's braking force to relieve the brakes.

Hill descent control switches off once the decline levels out or you press the accelerator pedal.

On vehicles with a cruise control system\* ⇒ *page 94*, hill descent control is also activated when the speed is set.

### WARNING

Hill descent control cannot overcome physical limitations, so it may not be able to maintain a constant speed under all conditions. Always be ready to apply the brakes.



### Shifting manually (tiptronic mode)

Applies to vehicles: with S tronic transmission / shift paddles

The tiptronic allow the driver to shift the gears manually.



Fig. 75 Center console: manual shifting with the selector lever

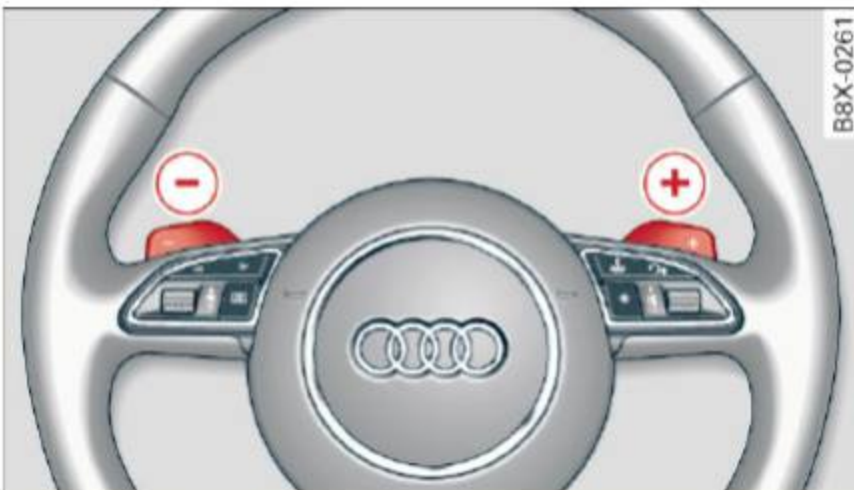

Fig. 76 Steering wheel: manual shifting with the shift paddles\*

### Shifting with the selector lever

You can shift into tiptronic mode while stationary and while driving.

- ▶ To shift into tiptronic mode, push the selector lever from the D/S setting to the right in the tiptronic shift gate. Once the transmission has switched modes, the selector lever position **M** is shown in the instrument cluster display ⇒ page 82, fig. 72. For example **M4**, means the fourth gear is engaged.
- ▶ To shift up a gear, tap the selector lever forward (+) ⇒ fig. 75.
- ▶ To shift down a gear, tap the selector lever to back (-).

### Shifting with the shift paddles\*

You can operate the shift paddles in the D/S or **M** (tiptronic shift gate) selector lever positions.

- ▶ To shift up one gear, tap the shift paddle (+) ⇒ fig. 76.
- ▶ To shift down one gear, tap the shift paddle (-).

If the shift paddles are tapped while in the D/S selector lever position, automatic mode switches off briefly. To switch from manually shifting back to automatic shifting immediately, tap the shift paddle (+) ⇒ fig. 76 for 1 second.

To keep shifting using the shift paddles, move the selector lever to the right out of the D/S position into the tiptronic shift gate.

The transmission automatically shifts up or down before critical engine speed is reached.

The transmission only allows manual shifting when the engine speed is within the permitted range.

### **i** Tips

- If you shift to the next lowest gear, the transmission will only shift if the engine will not be over-revved.
- With kick-down, the transmission shifts to a lower gear, depending on vehicle speed and engine speed.
- tiptronic does not work if the transmission is running in emergency mode.

### Kick-down

Applies to vehicles: with S tronic transmission

*Kick-down enables maximum acceleration.*

When you press the accelerator pedal down beyond the resistance point, the automatic transmission downshifts into a lower gear, depending on vehicle speed and engine RPM. It shifts up into the next higher gear once the maximum specified engine RPM is reached.

### **!** WARNING

Please note that the wheels could spin on slick or slippery roads when kick-down is active.



### Launch Control-Program

Applies to vehicles: with launch control

*The Launch Control Program enables maximum acceleration.*

Requirement: The engine must be at operating temperature and the steering wheel must not be turned.

- ▶ With the engine running, press the  button briefly one time <sup>1)</sup>.
- ▶ Pull the selector lever back out of the D/S position briefly to select the S position, or press it toward the right into the tiptronic position or select the **Dynamic** driving mode in drive select\* ⇒ *page 112*.
- ▶ Press the brake pedal firmly with your left foot and hold it all the way down for at least 1 second.
- ▶ At the same time, press the gas pedal all the way down with your right foot until the engine reaches and stays at a high RPM level.
- ▶ Remove your left foot from the brake.

#### **WARNING**

- Always adapt your driving to the traffic flow.
- Only use Launch Control when road and traffic conditions allow it and other drivers will not be endangered or impacted by your driving and the vehicle's acceleration.
- Please note that the drive wheels can spin and the vehicle can break away when sport mode is switched on, especially when the road is slippery.
- Once the vehicle has started moving, press the  button briefly to turn the sport mode off.

#### **Tips**

- The transmission temperature may increase significantly after using the launch control program. If that happens, the program may

not be available for a few minutes. It will be available again after a cool-down period.

- When accelerating using the launch control program, all vehicle parts are subject to heavy loads. This can lead to increased wear.

### Emergency mode

Applies to vehicles: with S tronic transmission

*In the event of a system malfunction, there is an emergency program.*

If all of the selector lever positions are highlighted with a light background in the instrument cluster display, there is a system malfunction and the S tronic transmission is running in the emergency program. The vehicle can still be driven in emergency mode, but only with reduced speed and not in all gears. In some cases, the vehicle **cannot drive in reverse**.

#### **Note**

If the transmission runs in emergency mode, drive to an authorized Audi dealer or authorized Audi Service Facility immediately to have the malfunction corrected.

### Transmission malfunction

#### **Transmission malfunction! Please stop the vehicle and select P**

There is a malfunction in the transmission. Park the vehicle securely and do not continue driving. See an authorized Audi dealer or authorized Audi Service Facility for assistance.

#### **Transmission overheating! Please stop the vehicle!**

The transmission is too hot and can become damaged. Stop and let the transmission cool with the engine running (at idle) in the P selector lever position. Then the indicator light and the message turn off, drive to an authorized Audi dealer or authorized Audi Service Facility immediately to have ►

<sup>1)</sup> In vehicles with a driver information system, an ESC light in the instrument cluster stays on continuously and the message **Stabilization control (ESC): sport. Warning! Restricted stability** appears temporarily.



the malfunction corrected. If the indicator light and the driver message do not turn off, do not continue driving. See an authorized Audi dealer or authorized Audi Service Facility for assistance.

**⚠️ Transmission malfunction: you can continue driving**

Drive to an authorized Audi dealer or authorized Audi Service Facility immediately to have the malfunction corrected.

**⚠️ Transmission malfunction: no reverse gear (you can continue driving)**

Drive to an authorized Audi dealer or authorized Audi Service Facility immediately to have the malfunction corrected.

**⚠️ Transmission malfunction: You can continue driving in D until engine off**

Drive the vehicle away from moving traffic and park. See an authorized Audi dealer or authorized Audi Service Facility for assistance.

**⚠️ Transmission overheating! Please adapt driving style**

Continue driving moderately. When the indicator light turns off, you can continue driving normally.

**⚠️ Transmission: Please press brake pedal and select gear again**

If the transmission malfunctions because the temperature is too high, a message appears when the transmission is cooled.

### Selector lever emergency release

Applies to vehicles: with S tronic transmission

*If the vehicle's power supply fails, the selector lever can be released in an emergency.*



Fig. 77 Selector lever: removing the cover



Fig. 78 Selector lever: using the emergency release to move out of the Park position

The emergency release mechanism is located in the right area under the selector lever shift gate. Using the emergency release can be complicated. We recommend contacting your authorized Audi dealer for assistance, if necessary.

The screwdriver from the vehicle tool kit located in the luggage compartment is needed to for the emergency release ⇒ *page 241*. Use the flat side of the reversible screwdriver blade.

### Removing the selector lever cover

- ▶ Set the parking brake (P) ⇒ ⚠️ to secure your vehicle from rolling.
- ▶ Insert the flat side of the screwdriver sideways in the slot near the shift cover and pry the shift cover up ⇒ *fig. 77*.
- ▶ Pull up the corners of the shift cover carefully with your hands and fold it over the shifter knob ⇒ *fig. 78*.

### Selector lever emergency release

- ▶ Press and hold the yellow release button with the screwdriver ⇒ *fig. 78*.
- ▶ Press the release button in the selector lever (A) and move the lever into the N position.
- ▶ Clip the shift cover back into the shift gate after using the emergency release.

If the vehicle must be pushed or towed due to a power failure (for example, the battery is dead), the selector lever must first be moved to the N position using the emergency release mechanism.



 **WARNING**

Only move the selector lever out of the P position when the parking brake is set. If that does not work, secure the vehicle with the brake pedal. Otherwise, the vehicle could start to move unintentionally when the selector lever is moved out of the P position.



## Trailer mode

### Driving with a trailer

#### General information

Your Audi was designed primarily for passenger transportation.

If you plan to tow a trailer, please remember that the additional load will affect durability, economy and performance.

Trailer towing not only places more stress on the vehicle, it also calls for more concentration from the driver.

For this reason, always follow the operating and driving instructions provided and use common sense.

#### Technical requirements

##### Trailer hitch

Use a weight-carrying hitch conforming to the gross trailer weight. The hitch must be suitable for your vehicle and trailer and must be mounted securely on the vehicle's chassis at a *technically sound* location. Use only a trailer hitch with a removable ball mount. Always check with the trailer hitch manufacturer to make sure that you are using the correct hitch.

##### Do not use a bumper hitch.

The hitch must be installed in such a way that it does not interfere with the impact-absorbing bumper system. No modifications should be made to the vehicle exhaust and brake systems. From time to time, check that all hitch mounting bolts remain securely fastened.

When you are not towing a trailer, remove the trailer hitch ball mount. This prevents the hitch from causing damage should your vehicle be struck from behind ⇒ ⚠.

##### Trailer brakes

If your trailer is equipped with a braking system, check to be sure that it conforms to all regulations.

The trailer hydraulic brake system must not be directly connected to the vehicle's hydraulic brake system.

##### Safety chains

Always use safety chains between your vehicle and the trailer.

##### Trailer lights

Trailer lights must meet all regulations. Be sure to check with your Audi dealer for correct wiring, switches and relays.

##### Mirrors

If you are unable to see the traffic behind you using the regular outside mirrors, then you *must* install extended mirrors. It is important that you *always* have clear vision to the rear.



#### WARNING

After removing the trailer hitch, do not store it in your vehicle. In case of sudden braking, the hitch could fly forward and injure you or your passengers.

#### Operating instructions

##### Maximum trailer weight

A trailer for your vehicle is limited to a typical class 1 or class 2 trailer.

##### Trailer load distribution

Be sure the load in the trailer is held securely in place to prevent it from shifting forward, backward or sideways.

**Never allow a passenger to ride in a trailer** ⇒ ⚠ in *Driving instructions on page 92*.

##### Engine cooling system

Towing a trailer makes the engine work harder. It is important that the cooling system's performance is up to the additional load. Make sure that the cooling system has enough fluid.

##### Tire pressure

When towing a trailer, inflate the tires of your vehicle to the cold tire pressure listed under "Full" ►



## Trailer mode

load” on the label located on the driver's side B-pillar (visible when the door is open). Inflate trailer tires to trailer and tire manufacturers' specifications.

### Lights

Check to make sure both vehicle and trailer lights are working properly.

### Safety chains

Be sure trailer safety chains are properly connected from the trailer to the hitch on the vehicle. Leave enough slack in the chains to permit turning corners. When you install safety chains, make sure they will not drag on the road when you are driving.

The chains should cross under the trailer tongue to prevent it from dropping in case of separation from the hitch.

## Driving instructions

*Driving with a trailer always requires extra care and consideration.*

To obtain the best possible handling of vehicle and trailer, please note the following:

- ▶ Do not tow a loaded trailer when your car itself is not loaded.
- ▶ Be especially careful when passing other vehicles.
- ▶ Observe speed limits.
- ▶ Do not drive at the maximum permissible speed.
- ▶ Always apply brakes early.
- ▶ Monitor the temperature gauge.

### Weight distribution

Towing a loaded trailer with an empty car results in a highly unstable distribution of weight. If this cannot be avoided, drive at very low speeds only to avoid the risk of losing steering control.

A “balanced” rig is easier to operate and control. This means that the tow vehicle should be loaded to the extent possible and permissible, while keeping the trailer as light as possible under the circumstances. Whenever possible, transfer some cargo to the luggage compartment of the

tow vehicle while observing tongue load requirements and vehicle loading considerations.

### Speed

The higher the speed, the more difficult it becomes for the driver to control the rig. Do not drive at the maximum permissible speed. Reduce your speed even more if load, weather or wind conditions are unfavorable - particularly when going downhill.

Reduce vehicle speed **immediately** if the trailer shows the slightest sign of swaying. **Do not try to stop the swaying by accelerating.**

Observe speed limits. In some areas, speeds for vehicles towing trailers are lower than for regular vehicles.

Always apply brakes early. When driving downhill, shift into a lower gear to use the engine braking effect to slow the vehicle. Use of the brakes alone can cause them to overheat and fail.

### Coolant temperature

The coolant temperature gauge ⇒ *page 12* must be observed carefully. The coolant temperature can increase if you drive on long inclines in a low gear at high engine speeds. Reduce your speed immediately if the LEDs in the top part of the display turn on.

For more information about indicator lights, refer to  ⇒ *page 19*.



### WARNING

Anyone not properly restrained in a moving vehicle is at a much greater risk in an accident. Never let anyone ride in your car who is not properly wearing the restraints provided by Audi.

## Trailer mode notes

### Important to know

Your vehicle handles differently when towing a trailer because of the additional weight and different weight distribution. Safety, performance and economy will greatly depend on how carefully you load your trailer and operate your rig. ►



Before you actually tow your trailer, practice turning, stopping and backing up in an area away from traffic. Keep practicing until you have become completely familiar with the way your vehicle-trailer combination behaves and responds.

Backing up is difficult and requires practice. Backing up with a trailer generally requires steering action opposite to that when backing up your vehicle without a trailer.

Maintain a greater distance between your vehicle and the one in front of you. You will need more room to stop. To compensate for the trailer, you will need a larger than normal turning radius.

When passing, remember that you cannot accelerate as fast as you normally would because of the added load. Make sure you have enough room to pass. After passing, allow plenty of room for your trailer before changing lanes again.

Avoid jerky starts, sharp turns or rapid lane changes.

### Tips

- Do not tow a trailer during the break-in period of your vehicle.
- If you tow a trailer, your Audi may require more frequent maintenance due to the extra load ⇒ *page 262*.

## Parking on a slope

*Do not park on a slope with a trailer. If it cannot be avoided, do so only after doing the following:*

### When parking:

- ▶ Apply the foot brake.
- ▶ Have someone place chocks under both the vehicle and the trailer wheels.
- ▶ With chocks in place, slowly release the brakes until the wheel chocks absorb the load.
- ▶ Turn the wheels towards the curb.
- ▶ Apply the parking brake.
- ▶ Select the P selector lever position.

### When restarting after parking:

- ▶ Apply the foot brake.
- ▶ Start the engine.
- ▶ Select the D/S selector lever position.

- ▶ Release the parking brake and slowly pull out and away from the wheel chocks.
- ▶ Stop and have someone retrieve the wheel chocks.

### Tips

If you move the selector lever of the automatic transmission to P before applying the parking brake and before blocking the wheels, you may have to use more force later to move the lever out of the P position.



## Assist

### Electronic speed limiter\*

Applies to vehicles: with electronic speed limiter

Your vehicle may be factory equipped with tires that are rated for a maximum speed of 130 mph (210 km/h). This is less than the maximum speed of your vehicle. To reduce the risk of sudden tire failure and loss of control if the vehicle is operated at excessive speeds, your vehicle also has an electronic speed limiter. The electronic speed limiter prevents your vehicle from going faster than the tire speed rating. For more information ⇒ page 221.

If the engine control unit receives faulty vehicle road speed signals, the Malfunction Indicator Lamp (MIL)  will illuminate. If this occurs, contact the nearest authorized Audi dealer for assistance.





#### WARNING

Always observe the posted speed limits and adjust your speed to suit prevailing road, traffic and weather conditions. Never drive your vehicle faster than the maximum speed rating of the tires installed.

## Speed warning system

### Introduction

*The speed warning system helps you to stay under a specified maximum speed.*

The speed warning system warns you if you are exceeding the maximum speed that you have set. You will hear a warning tone when your speed exceeds the stored value by approximately 3 mph (3 km/h). The  (USA models) /  (Canada models) indicator light and the message **Speed limit exceeded!** appear in the instrument cluster display at the same time. The  /  indicator light turns off when the speed decreases below the stored maximum speed.

Setting a threshold is recommended if you would like to be reminded when you reach a certain maximum speed. Situations where you may want to do so include driving in a country with a gener-

al speed limit or if there is a specified maximum speed for winter tires.

#### Tips

Regardless of the speed warning system, you should always monitor your speed using the speedometer and make sure you are following the legal speed limit.

### Setting the threshold

*You can set, change and delete the threshold in the MMI.*

- ▶ Select: the **MENU** button > **Car** > **Systems\*** control button > **Driver assistance** > **Speed warning**.

You can set any threshold between 20 mph (30 km/h) and 150 mph (240 km/h). Settings can each be adjusted in increments of 6 mph (10 km/h).

## Cruise control system

### Description

Applies to vehicles: with cruise control system

The cruise control system makes it possible to drive at a constant speed starting at 15 mph (20 km/h).

The speed is kept constant by modifying engine power or through an active brake intervention.

#### WARNING

- Always pay attention to the traffic around you when the cruise control is in operation. You are always responsible for your speed and the distance between your vehicle and other vehicles.
- For reasons of safety, cruise control should not be used in the city, in stop-and-go traffic, on winding roads and when road conditions are poor (such as ice, fog, gravel, heavy rain and hydroplaning) - you could have an accident.
- Switch the cruise control off temporarily when driving in turning lanes, highway exits or in construction zones.



- Please note that unconsciously “resting” your foot on the accelerator pedal prevents the cruise control from braking. This is due to the control system being overridden by the driver's acceleration.
- If there is a brake system malfunction such as overheating when the speed warning system is switched on, the braking function in the system will be deactivated. The remaining speed warning system functions will remain active, as long as the **CRUISE** (USA models) /  (Canada models) indicator light is on.

### Tips

- The cruise control system is ideal for stretches with speed limits. The driver is responsible for adhering to the correct speed.
- The cruise control remains active when shifting gears.
- The brake lights turn on when the brakes are activated.

### Switching on

Applies to vehicles: with cruise control system



Fig. 79 Operating lever: cruise control system

- ▶ To switch the cruise control on, pull the lever into position **1** ⇒ *fig. 79*.
- ▶ Drive at the speed to be controlled.
- ▶ To store the speed, press the button **A**. The **CRUISE** (USA models) /  (Canada models) turns on in the instrument cluster.

### Changing speed

Applies to vehicles: with cruise control system

- ▶ To increase or decrease the speed in increments, **tap** the lever in the **+**/**-** direction ⇒ *page 95, fig. 79*.
- ▶ To increase or decrease the speed quickly, **hold** the lever in the **+**/**-** direction until the desired speed is reached.

### Overriding the speed

You can press the accelerator pedal down to increase your speed, for example if you want to pass someone. The speed you saved earlier will resume as soon as you let off of the accelerator pedal.

If, however, you exceed your saved speed by 5 mph (10 km/h) for longer than 6 minutes, the cruise control turns off temporarily. The **CRUISE** (USA models) /  (Canada models) indicator light in the instrument cluster turns off and the stored speed is retained.

### Preselecting the speed

Applies to vehicles: with cruise control system

*You can pre-select your desired speed while the vehicle is not moving.*

- ▶ Switch on the ignition.
- ▶ Pull the lever into position **1** ⇒ *page 95, fig. 79*.
- ▶ To increase or decrease the speed, tap the lever in the **+**/**-** direction.

This function makes it possible, for example, to save the speed you want before driving on the highway. Once on the highway, activate the cruise control by pulling the lever toward **1**.

### Switching off

Applies to vehicles: with cruise control system

#### Temporary deactivation

- ▶ Step on the brake pedal, or
- ▶ Press the lever into position **2** (not clicked into place) ⇒ *page 95, fig. 79*, or



### Switching off completely

- ▶ Press the lever into position ② (clicked into place), or
- ▶ switch the ignition off.

The speed you saved will be retained if the cruise control has been switched off temporarily. To resume the stored speed, release the brake pedal and pull the lever into position ①.

The stored speed is erased when the cruise control is switched off completely or the ignition is switched off.

**! WARNING**

You should only resume the saved speed if it is not too high for existing traffic conditions. Otherwise you risk an accident.

**i Tips**

- If the brakes become too heated while driving, the cruise control switches off. If this happens while driving downhill, you can relieve the brakes by shifting into a lower gear.
- When the cruise control is activated, ESC sport mode cannot be switched on.

## Audi adaptive cruise control

### Description

Applies to vehicles: with Audi adaptive cruise control

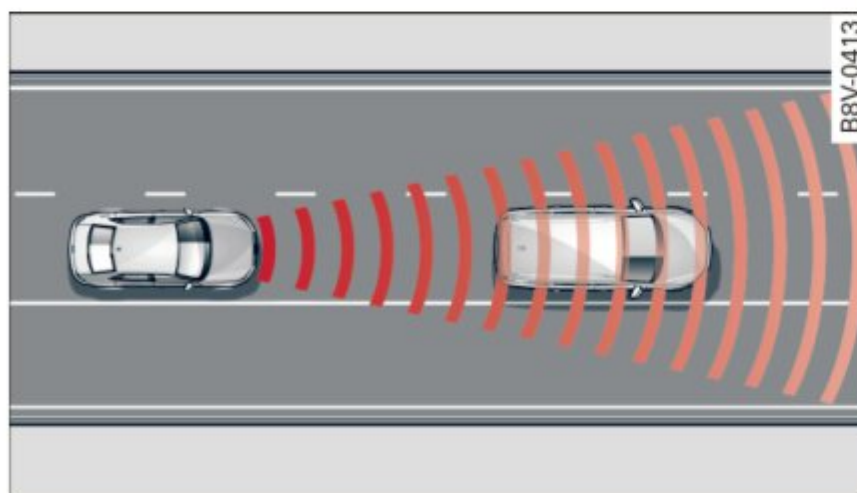

Fig. 80 Detection range

The adaptive cruise control system is a combination of speed and distance regulation. It assists the driver by both regulating the speed and maintaining a distance to the object ahead, with-

in the abilities of the system. If the system detects an object, adaptive cruise control can brake and accelerate your vehicle. This makes driving more comfortable both on long stretches of highway and in stop-and-go traffic.

### What can adaptive cruise control do?

The adaptive cruise control system uses radar and a video camera. The radar is subject to designated system limits ⇒ *page 97*.

On open roads with no traffic, it functions like a cruise control system. The stored speed is maintained. When approaching an object ahead and the system detects it, the adaptive cruise control system automatically brakes to match that object's speed and then maintains the stored distance. As soon as the system does not detect an object ahead, adaptive cruise control accelerates up to the stored speed.

Within the limits of the system, adaptive cruise control can brake in stop-and-go traffic until the vehicle is stationary and then begin driving again under certain conditions ⇒ *page 100, Driving in stop-and-go traffic*.

### Which functions can be controlled?

When you switch adaptive cruise control on, you can set the current speed as the “control speed” ⇒ *page 98, Switching on/off*.

When driving, you can stop cruise control ⇒ *page 100* or change the speed ⇒ *page 100* at any time.

You can also adjust the following settings:

- Distance ⇒ *page 101*
- Driving program ⇒ *page 102*
- Driving mode ⇒ *page 102*



## General information

Applies to vehicles: with Audi adaptive cruise control and Audi pre sense front



Fig. 81 Front of vehicle: sensor

The general information applies to adaptive cruise control\* and pre sense front\* ⇒ *page 103*.

The radar sensor area ⇒ *fig. 81* must not be covered with stickers, deposits or any other obstructions as it may impair the function of the adaptive cruise control and the pre sense front. For information on cleaning, refer to ⇒ *page 235*. The same applies for any modifications made in the front area.

The function of the adaptive cruise control system and pre sense front is limited in some conditions:

- Objects can only be detected when they are within the sensor range ⇒ *page 96, fig. 80*.
- The system has a limited ability to detect objects that are a short distance ahead, off to the side of your vehicle or moving into your lane.
- Objects that are difficult to detect such as motorcycles, vehicles with high ground clearance or an overhanging load are detected late or not detected at all.
- When driving through curves ⇒ *page 98*.
- With stationary objects ⇒ *page 98*.

### WARNING

Always pay attention to traffic when adaptive cruise control is switched on and the pre sense front is active ⇒ *page 103*. As the driver, you are still responsible for starting and for maintaining speed and distance to other objects. The pre sense front is used to assist you. The driver must always take action to

avoid a collision. The driver is always responsible for braking at the correct time.

- Using adaptive cruise control incorrectly can cause collisions, other accidents and serious injuries.
- For safety reasons, do not use adaptive cruise control when driving on roads with many curves, when the road surface is in poor condition and/or in bad weather (such as ice, fog, gravel, heavy rain and hydroplaning). Using the system under these conditions could result in a collision.
- Switch adaptive cruise control off temporarily when driving in turning lanes, on expressway exits or in construction zones. This prevents the vehicle from accelerating to the set speed when in these situations.
- The adaptive cruise control system will not brake by itself if you put your foot on the accelerator pedal. Doing so can override the speed and distance regulation.
- When approaching stationary objects such as stopped traffic, adaptive cruise control will not respond and pre sense front will have limited function.
- The adaptive cruise control system and pre sense front do not react to people, animals, objects crossing the road or oncoming objects.
- The function of the radar sensors can be affected by reflective objects such as guard rails, the entrance to a tunnel, heavy rain or ice.
- Always maintain enough distance from vehicles ahead so that you can still brake your vehicle safely. The adaptive cruise control cannot safely slow your vehicle or brake it to a stop if you are driving too close behind a vehicle. Please note that the automatic braking function cannot brake suddenly or apply the brakes fully under these conditions.
- To reduce the risk of unintended actions, switch the ACC off when you are not actively using it.



**!** Note

The sensor can be displaced by impacts or damage to the bumper, wheel housing and underbody. The adaptive cruise control and pre sense front may become impaired as a result. Have an authorized Audi dealer or authorized Audi Service Facility check their function.

**In curves**

Applies to vehicles: with Audi adaptive cruise control and Audi pre sense front

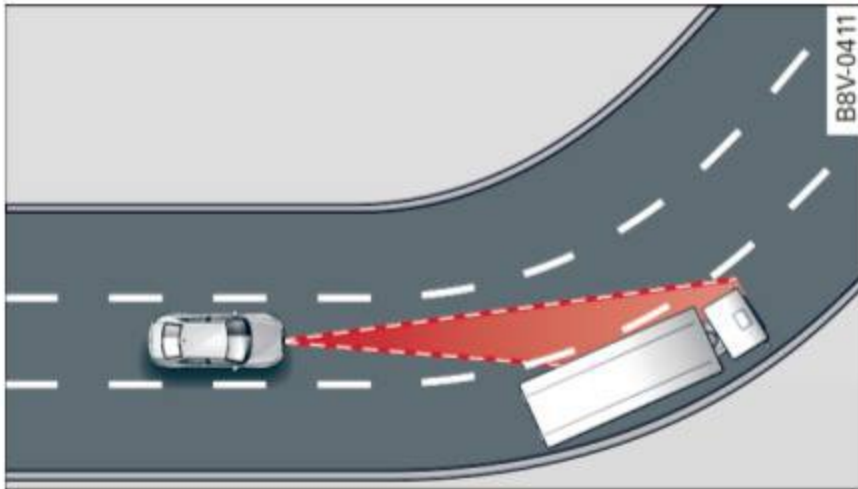

Fig. 82 Example: driving into a curve

When driving into a curve ⇒ *fig. 82* and out of a curve, the adaptive cruise control may react to an object in the neighboring lane and apply the brakes. You can prevent that by pressing the accelerator pedal briefly.

**Stationary objects**

Applies to vehicles: with Audi adaptive cruise control and Audi pre sense front

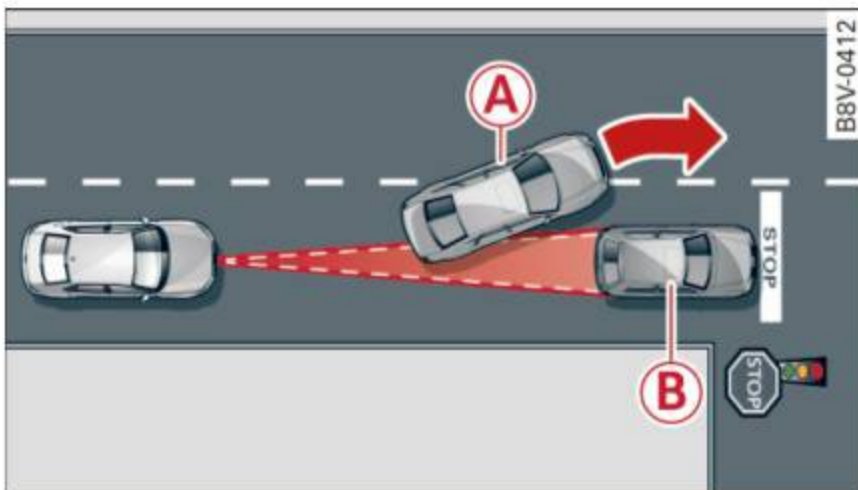

Fig. 83 Example: object changing lanes and stationary object

**Adaptive cruise control**

The adaptive cruise control system only reacts to objects that are moving or that the system has already detected as moving. For example, it can react when a vehicle that has already been detected (A) turns or changes lanes, but adaptive cruise control does not react to a stationary vehicle (B). Press the brake pedal to slow your vehicle down!

**Pre sense front**

Pre sense front only reacts to stationary objects at low speeds.

**Switching on/off**

Applies to vehicles: with Audi adaptive cruise control

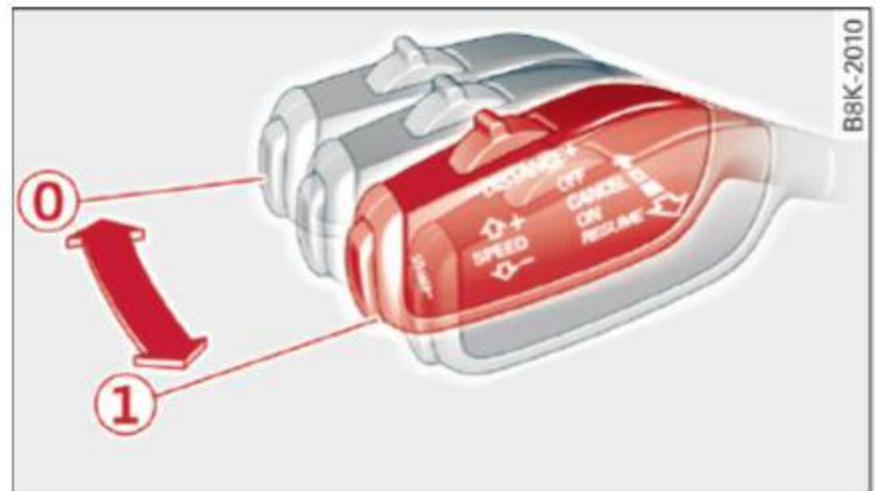

Fig. 84 Operating lever: switching on/off



Fig. 85 Instrument cluster: adaptive cruise control

You can set any speed <sup>1)</sup> between 20 mph and 95 mph (30 and 150 km/h).

Indicator lamps and messages in the instrument cluster display inform you about the current situation and settings.

<sup>1)</sup> Speed limits depend on the country and the speedometer.



## Switching adaptive cruise control on

- ▶ Pull the lever toward you into position ①  
⇒ *fig. 84*. **ACC: standby** appears in the instrument cluster display.

## Saving the speed and activating regulation

- ▶ To save the current speed, press the **SET**  
⇒ *fig. 84* button. The stored speed is shown in the tachometer LED line ② and appears briefly in the information line ③ ⇒ *fig. 85*.
- ▶ To activate the regulation while stationary, you must press the brake pedal.

## Switching adaptive cruise control off

- ▶ Push the lever away from you into position ④ until it clicks into place. The message **ACC: off** appears.

The stored speed in the LED line is erased.

## ② Indicator lights

 - adaptive cruise control is switched on. Objects ahead are not detected. The stored speed is maintained.

 - An object ahead was detected. The adaptive cruise control system regulates the speed and distance to the object ahead and brakes/accelerates automatically.

 - adaptive cruise control is switched on. An object ahead was detected. Your vehicle remains stopped and will not start driving automatically.

 - The automatic braking is not enough to maintain a sufficient distance to an object ahead. You must intervene ⇒ *page 102, Request for driver intervention*.

## ③ Instrument cluster display

If adaptive cruise control is not shown in the instrument cluster display, you can call it up using the multifunction steering wheel buttons ⇒ *page 28*.

Based on the graphics in the display, you can determine if the system is maintaining a distance to a vehicle ahead and what that distance to this vehicle is:

**No vehicle** - No object ahead was detected.

**White vehicle** - An object ahead was detected.

**Red vehicle** - Request for the driver to take action ⇒ *page 102*.

Both **arrows** on the **scale** ④ indicate the distance to the object ahead. No arrow appears when the vehicle is on an open road and there is no object ahead. If an object is detected ahead, the arrow moves on the scale.

The green zone on the scale indicates the store distance. For information on changing the distance, refer to ⇒ *page 101*. If the distance selected is exceeded or not reached, the arrow moves into the red zone on the scale.

## WARNING

- Using adaptive cruise control incorrectly can cause collisions, other accidents and serious injuries.
- If you press the **SET** button when driving at speeds below 20 mph (30 km/h), the vehicle accelerates automatically up to 20 mph (30 km/h), which is the minimum speed that can be set.

## Tips

- If you switch the ignition or the adaptive cruise control system off, the set speed is erased for safety reason.
- The Electronic Stabilization Control (ESC) and Anti-Slip Regulation (ASR) both switch on when the adaptive cruise control is switched on. ESC and ASR cannot be switched off when adaptive cruise control is switched on.
- With the adaptive cruise control activated the ESC sport mode cannot be activated.



## Changing the speed

Applies to vehicles: with Audi adaptive cruise control



Fig. 86 Operating lever: changing the speed

- ▶ To increase or reduce the speed in increments, **tap** the lever up or down.
- ▶ To increase or decrease the speed quickly, **hold** the lever up or down until the red LED **A** reaches the desired speed ⇒ *page 98, fig. 85*.

After each change, the new stored speed appears briefly in the information line ⇒ *page 98, fig. 85* **D**.

## Driving in stop-and-go traffic

Applies to vehicles: with Audi adaptive cruise control

The adaptive cruise control system assists you in stop-and-go traffic. If an object that is detected ahead stops, your vehicle will brake and stay at a stop, within the limits of the system.

### Starting with adaptive cruise control<sup>1)</sup>

If your vehicle brakes to a stop because an object is detected ahead, **ACC autom. go** appears briefly in the instrument cluster display. Your vehicle is in automatic start mode.

As long as the message **ACC autom. go** is displayed and the object detected ahead starts to move, your vehicle will continue driving ⇒ **A**.

You can activate **ACC autom. go** again for a short time by pulling the lever to position **2** ⇒ *page 100, fig. 87*.

The start mode **ACC autom. go** ends when the brake pedal is pressed.

## Criteria for switching off

The adaptive cruise control switches off for safety reasons when stationary:

- when the driver's door is open,
- when the vehicle is stationary for more than 3 minutes,
- when the driver's safety belt is not fastened.

### **!** WARNING

If the message **ACC autom. go<sup>1)</sup>** appears, the vehicle continues driving, even if there is an obstacle between your vehicle and the object ahead. This increases the risk of an accident.

### **i** Tips

If adaptive cruise control is active and your vehicle does not start driving even though the message **ACC autom. go<sup>1)</sup>** appears, you can start by tapping the accelerator pedal.

- If an obstacle is detected when driving with adaptive cruise control, the system will request you to begin driving ⇒ *page 102*. Your vehicle will begin driving more slowly. This can also happen in situations where there is no visible obstacle.

## Interrupting cruise control

Applies to vehicles: with Audi adaptive cruise control

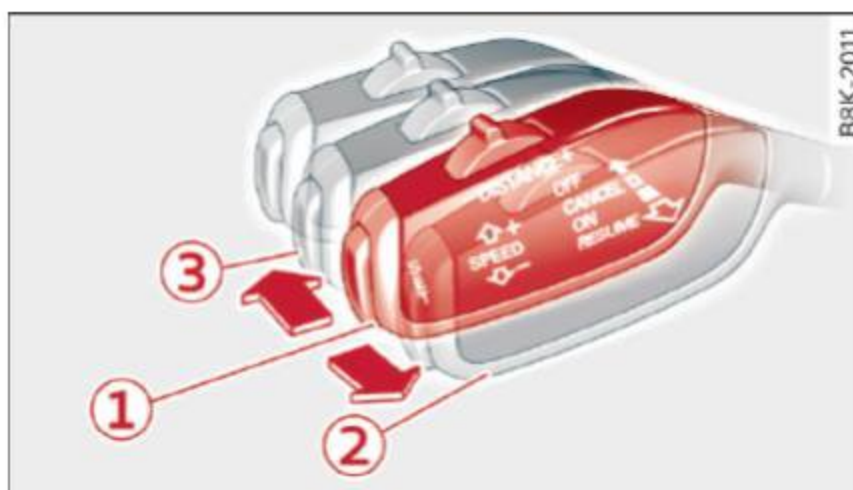

Fig. 87 Operating lever

Requirement: The adaptive cruise control is switched on.

<sup>1)</sup> This is not available in some countries.



## Overriding cruise control

Overriding means exceeding the selected speed when adaptive cruise control is active, for example when pressing the accelerator pedal when passing.

- ▶ To accelerate manually, pull the lever toward you into position ② and hold it there. The message **ACC: override** appears. Or
- ▶ press the accelerator pedal.
- ▶ To resume cruise control, release the lever or take your foot off the accelerator pedal.

## Interrupting cruise control while driving

- ▶ Move the lever into position ③. The message **ACC: standby** appears. Or
- ▶ press the brake pedal.
- ▶ To resume the stored speed, move the lever into position ②.

## Interrupting cruise control when stopped

- ▶ Push the lever away from you into position ③. The message **ACC: standby** appears.
- ▶ To resume cruise control, press the brake pedal and pull the lever toward you into position ②.

### WARNING

It is dangerous to activate cruise control and resume the stored speed when the current road, traffic or weather conditions do not permit this. This could result in a crash.

## Setting the distance

Applies to vehicles: with Audi adaptive cruise control

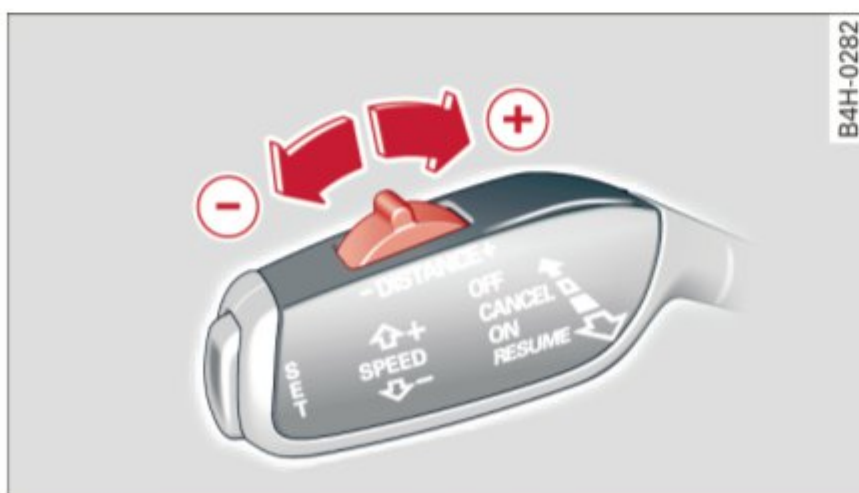



Fig. 88 Operating lever: setting the distance

- ▶ Tap the switch to display the current set distance ⇒ *fig. 88*.

- ▶ To increase or reduce the distance in increments, tap the switch again to the right or left. The distance between the two vehicles will change in the instrument cluster display.

When approaching an object detected ahead, the adaptive cruise control system brakes to match that object's speed and then regulates to the stored distance. If the object detected ahead accelerates, adaptive cruise control will also accelerate up to the stored speed.

The higher the speed, the greater the distance in meters ⇒ . The **Distance 3** setting is recommended. That is equal to the general recommendation of “half the speed shown on the speedometer”.

The distances provided are example values. Depending on the driving situation, the current speed and the way the object detected ahead is driving, the actual distance may be more or less than these target distances.

 **Distance 1:** This setting corresponds to a distance of 92 feet / 28 meters when traveling at 62 mph (100 km/h), or a time distance of 1 second.

 **Distance 2:** This setting corresponds to a distance of 118 ft / 36 meters when traveling at 62 mph (100 km/h), or a time distance of 1.3 second.

 **Distance 3:** This setting corresponds to a distance of 164 ft / 50 meters when traveling at 62 mph (100 km/h), or a time distance of 1.8 second.

 **Distance 4:** This setting corresponds to a distance of 219 ft / 67 meters when traveling at 62 mph (100 km/h), or a time distance of 2.4 second.

### WARNING

- Driving too close to other vehicles increases the risk of collisions and serious injuries.
- Setting short distances to vehicles ahead reduces the distance and time that you have to stop your vehicle safely. This increases the need for you to pay attention to traffic.



- Always follow applicable traffic laws, use common sense and select a distance to vehicles ahead that takes the current traffic, road and weather conditions into account.

### **i** Tips

**Distance 3** is set automatically each time you switch the ignition on. If you would like to have this distance as a basic setting, you can have the **adaptive cruise control** menu extended / enabled from an authorized Audi dealer or authorized Audi Service Facility.

### Setting the driving program

Applies to vehicles: with Audi adaptive cruise control

A adaptive cruise control driving program is adjustable on vehicles without Audi drive select\*.

- ▶ In the MMI, select: the **MENU** button > **Car** > **Systems\*** control button > **Driver assistance** > **Adaptive cruise control** > **Driving program** > **Comfort/Standard/Dynamic**.

### Selecting the driving mode

Applies to vehicles: with Audi adaptive cruise control

The adaptive cruise control driving program is adjustable for vehicles with Audi drive select using the driving mode.

- ▶ Select the desired driving mode **Comfort**, **Auto**, **Dynamic** or **Individual\*** with the knob  
⇒ *page 112*.

### Request for driver intervention

Applies to vehicles: with Audi adaptive cruise control



Fig. 89 Instrument cluster: driver intervention request

In some situations, the braking from the adaptive cruise control system is not enough to maintain enough distance to the object ahead. In these situations, the system will request you to take action.

The  indicator light and the graphic in the display will warn you about the danger ⇒ *fig. 89*. You will also hear an audio signal. Press the brake pedal to slow your vehicle down.

### Driver messages

Applies to vehicles: with Audi adaptive cruise control

#### ACC: unavailable

The system cannot guarantee that it will detect objects correctly and is switched off. The sensor was moved or is faulty. Drive to an authorized Audi dealer or authorized Audi Service Facility immediately to have the malfunction corrected.

#### ACC: currently unavailable. No sensor vision

#### ACC and Audi pre sense: currently unavailable. No sensor vision

This message appears if the sensor view is obstructed, for example by leaves, snow, heavy spray or dirt. Clean the sensor ⇒ *page 97, fig. 81*.

#### ACC: currently unavailable. Gradient too steep

The road exceeds the maximum possible angle for safe adaptive cruise control operation. The adaptive cruise control cannot be switched on.

#### ACC: only available in D, S or M

Select the D/S or M selector lever position.

#### ACC: parking brake applied

The adaptive cruise control system switches off automatically if the parking brake is set. The adaptive cruise control is available again after releasing the parking brake.

#### ACC: currently unavailable. Stabilization control input

This message appears if the Electronic Stabilization Control (ESC) is taking action to stabilize the vehicle. In this case, adaptive cruise control switches off automatically.



### ACC off: manual control!

This message appears if the vehicle rolls back when starting on a slight incline, even though ACC is active. Press the brake pedal to prevent the vehicle from rolling or starting to move.

### ACC: engine speed

This message appears if the driver has not shifted up or down in time when the adaptive cruise control is braking or accelerating, causing the vehicle to exceed or to not reach the permitted engine speed. The adaptive cruise control turns off. A chime sounds as a reminder.

•••

Three white dots appear if a setting cannot be selected with the operating lever. For example, this happens if adaptive cruise control cannot be activated when stopped because the driver has not fastened the safety belt.

### Door open

Adaptive cruise control cannot be switched on when the vehicle is stationary and the driver's door is open.

## Audi pre sense

### Introduction

Applies to vehicles: with Audi pre sense basic or Audi pre sense front

Within the limits of the system, pre sense basic and pre sense front can initiate steps to protect vehicle occupants in certain dangerous situations.

Critical driving situations can be recognized by the pre sense front via a network of different vehicle systems and can take steps to prepare the vehicle occupants for a potential collision.

The pre sense front works with a radar sensor and a video camera\*. It also functions within the limits of the system when adaptive cruise control\* is switched off.

## General information

### General information

Applies to vehicles: with Audi pre sense front or Audi adaptive cruise control

### WARNING

Also follow the general information found on [⇒ page 97, General information](#).

## Audi pre sense basic

### Description

Applies to vehicles: with Audi pre sense basic

The function of the pre sense basic is activated at a speed of 20 mph (30 km/h) or higher.

The following functions can be triggered under certain conditions within the limits of the system:

- Tensioning of the safety belts (for example, during heavy braking): the front safety belts have reversible belt pretensioners. If a collision does not occur, the safety belts loosen slightly and are ready to trigger again.
- Closing the windows and the sunroof\* (for example, when over- or understeering): the windows and the sunroof\* close until there is only a small gap open.

Audi drive select: the deployment time is adapted in dynamic mode.

### WARNING

The pre sense basic cannot overcome natural physical laws. It is a system designed to assist and it cannot prevent a collision. Do not let the increased safety provided tempt you into taking risks. This could increase your risk of a collision.

- The system can deploy incorrectly due to system-specific limits.

### Tips

- Certain pre sense basic functions switch off when ESC is switched off (sport mode) or when driving in reverse.



- The pre sense basic functions may not be available if there is a malfunction in the ESC system or the airbag control module.
- Note that with pre sense basic, the reversible safety belt pretensioner on the front passenger's side deactivates when the front passenger's airbag is deactivated.

## Audi pre sense front

### Description

Applies to vehicles: with Audi pre sense front or Audi adaptive cruise control

Pre sense front informs you if the distance to the vehicle ahead falls below the safe distance for an extended period of time. It can warn of a possible collision and initiate braking maneuvers, within the limits of the system.

When detected in time, the system can assess dangerous situations where an object ahead brakes suddenly or if your own vehicle is traveling at a high speed and approaching an object that is moving more slowly. If detection is not possible, then pre sense front does not react.

### Warnings

Applies to vehicles: with Audi pre sense front or Audi adaptive cruise control





Fig. 90 Instrument cluster: approach warning

The system recognizes various dangerous situations:

- Vehicles with adaptive cruise control: the **distance warning** occurs if you drive too closely to the object ahead for a long period of time. If the object ahead brakes strongly, you would not

be able to avoid a collision. The indicator light  indicates this.

- The **approach warning** occurs when an object ahead is traveling more slowly or brakes strongly. When this warning occurs, it may only be possible to avoid a collision by swerving or braking strongly. The message **Audi pre sense  Distance** ⇒ *fig. 90* and a warning tone will warn you about the danger. For vehicles with adaptive cruise control, the  indicator light also turns on.

If you do not react enough or not at all to a dangerous situation that was detected by the system, pre sense front provides assistance by applying the brakes.

- If a collision is imminent, the system will first provide an **acute warning** by braking sharply. You will also be made aware of the danger by the instrument cluster display ⇒ *fig. 90*. For vehicles with adaptive cruise control, the  indicator light also turns on.
- If you do not react to the acute warning, pre sense front can brake with increasing force within the limits of the system <sup>1)</sup>. This reduces the vehicle speed in the event of a collision. The message **Audi pre sense - Input** also appears.
- At low driving speeds, pre sense front can begin complete deceleration shortly before a collision <sup>1)</sup>.
- If pre sense front determines that you are not braking strongly enough when a collision is imminent, it can increase the braking force.

### WARNING

- Pre sense front cannot overcome natural physical laws. It is a system designed to assist and it cannot prevent a collision. The driver must always intervene. The driver is always responsible for braking at the correct time. Do not let the increased safety provided tempt you into taking risks. This could increase your risk of a collision.
- The system can deploy incorrectly due to system-specific limits.

<sup>1)</sup> This is not available in some countries.



- Please note that the sensor does not always detect all objects. This increases the risk of a collision.
- Pre sense front does not react to people or animals or objects that are crossing the vehicle's path or are difficult to detect  
⇒ *page 97*.
- Reflective objects such as guard rails or the entrance to a tunnel, heavy rain and ice can affect the function of the radar sensor and the system's ability to detect a collision risk.
- Lack of attention can lead to collisions, other accidents and serious injuries. pre sense front is an assistance system and cannot prevent a collision by itself. The driver must always intervene. The driver is always responsible for braking at the right time.
- Always pay attention to traffic, even when pre sense front is switched on. Always be ready to intervene and take over complete control of the vehicle whenever it is necessary. Always follow traffic laws regarding maintaining a safe distance between your vehicle and vehicles ahead.
- pre sense front works within certain limits and cannot react to situations that are outside of the system limits, such as when approaching a stationary vehicle or a stationary obstacle (the end of a traffic jam or a vehicle that has broken down).
- Always keep in mind that the radar sensor for pre sense front only works within defined detection zones, which means other vehicles may not always be detected correctly.
- The function and range of the radar sensor can be impaired by rain, snow and heavy mist. Vehicles ahead may not be detected right away, or not detected at all.
- Reflective surfaces such as guard rails or entrances to tunnels may impair the function of the radar sensor.

### Note

The sensor can be displaced by impacts or damage to the bumper, wheel housing and underbody. The pre sense front sensor can be damaged by this. Have an authorized Audi

dealer or authorized Audi Service Facility check their function.

### Tips

- You can cancel the braking with increasing force that is initiated by the system by braking yourself, by accelerating noticeably or by swerving.
- For information on driver messages about pre sense, refer to ⇒ *page 106*.
- Keep in mind that pre sense front can brake unexpectedly. Always secure any cargo or objects that you are transporting to reduce the risk of damage or injury.
- Certain pre sense front functions switch off when ESC is switched off (sport mode) or when driving in reverse.
- The pre sense front functions are not available if there is a malfunction in the adaptive cruise control\* system ⇒ *page 102* or ⇒ *page 106*.
- Keep in mind that pre sense front can brake abruptly. Always secure cargo or objects that you transport to reduce the risk of damage or injury.

### Settings in the Infotainment system

Applies to vehicles: with Audi pre sense front or Audi adaptive cruise control

- ▶ In the MMI, select: the **MENU** button > **Car** > **Systems\*** car > **Driver assistance** > **Audi pre sense**.

### Switching the system on and off

Audi pre sense (**System**): if the system is switched off, it switches on again automatically once the ignition is switched on again.

**System** - Switch Audi pre sense **On-Off**. With this, you can switch the prewarning and the braking intervention from Audi pre sense on or off.

**Early warning** - The distance and approach warnings can be switched **On/Off**.

### Tips

- If you restrict or switch off the ESC, the pre sense also switches itself off ⇒ *page 124*.



- Switch the pre sense off when you are loading the vehicle onto a vehicle carrier, train, ship or other type of transportation. This can prevent undesired warnings from the pre sense system.

## Driver messages

Applies to vehicles: with Audi pre sense or Audi adaptive cruise control

### Audi pre sense currently unavailable. No sensor vision

This message appears if the sensor view is obstructed, for example by leaves, snow, heavy spray or dirt. Clean the sensor ⇒ *page 97, fig. 81.*

### Audi pre sense: off

This message appears when the ESC is switched to sport mode, for example ⇒ *page 124.*

### Audi pre sense: system fault!

This message appears when the pre sense function is affected. For example, this could be caused by a faulty sensor.

If the message stays on, drive to an authorized Audi dealer or authorized Audi Service Facility to have the malfunction corrected.

## Audi active lane assist

### Description

Applies to vehicles: with Audi active lane assist

Active lane assist detects lane marker lines within the limits of the system using a camera in the windshield. If you are approaching a detected lane marker line and it appears likely that you will leave the lane, the system will warn you with corrective steering. You can override this steering at any time. If you pass over a line, the steering wheel will vibrate lightly. In order for this warning vibration to occur, it must first be switched on in the MMI. Active lane assist is operable when the lane marker line is detected on at least one side of the vehicle.

The system will not warn you before crossing a lane marker line if you have activated the turn signal. In this case, it assumes that you are changing lanes intentionally.

The system is designed for driving on expressways and highways and therefore only activates at speeds above approximately 40 mph (65 km/h).

### WARNING

- The system warns the driver that the vehicle is leaving the lane using corrective steering. The driver is always responsible for keeping the vehicle within the lane.
- The system can help you keep the vehicle in the lane, but it does not drive by itself. Always keep your hands on the steering wheel.
- Corrective steering may not occur in certain situations, such as during heavy braking.
- There may be cases where the camera does not recognize all lane marker lines. Corrective steering can only take place on the side of the vehicle where lane marker lines are detected.
- Other road structures or objects could possibly be identified unintentionally as lane marker lines. As a result, corrective steering may be unexpected or may not occur.
- The camera view can be restricted, for example by vehicles driving ahead or by rain, snow, heavy spray light shining into the camera or by dirt on the window. This can result in active lane assist not detecting the lane marker lines or detecting them incorrectly.
- In certain situations where visibility is low, the vehicle may switch from “early” to “late” corrective steering <sup>1)</sup>.
- Under certain conditions such as ruts in the road, an inclined roadway or crosswinds, the corrective steering alone may not be enough to keep the vehicle in the middle of the lane.

<sup>1)</sup> This function is not available in all countries.



- For safety reasons, active lane assist must not be used when there are poor road and/or weather conditions such as slippery roads, fog, gravel, heavy rain, snow and the potential for hydroplaning. Using active lane assist under these conditions may increase the risk of a crash.

**Switching on and off**

Applies to vehicles: with Audi active lane assist

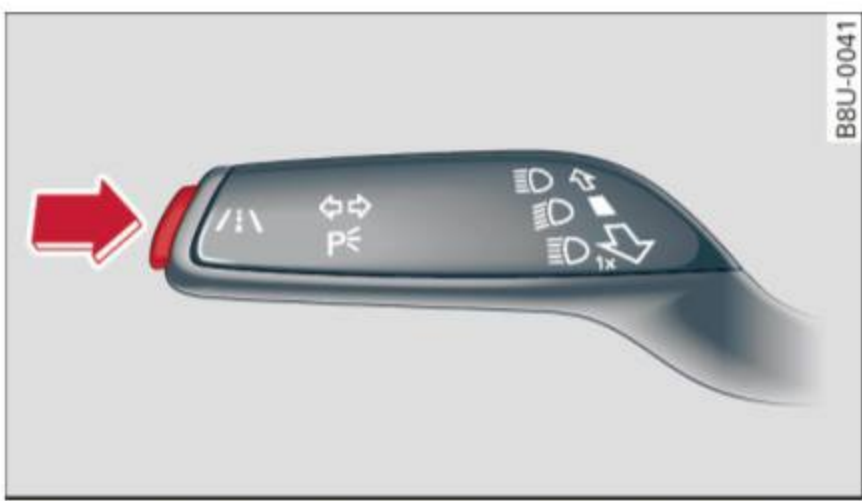

Fig. 91 Turn signal lever: button for active lane assist

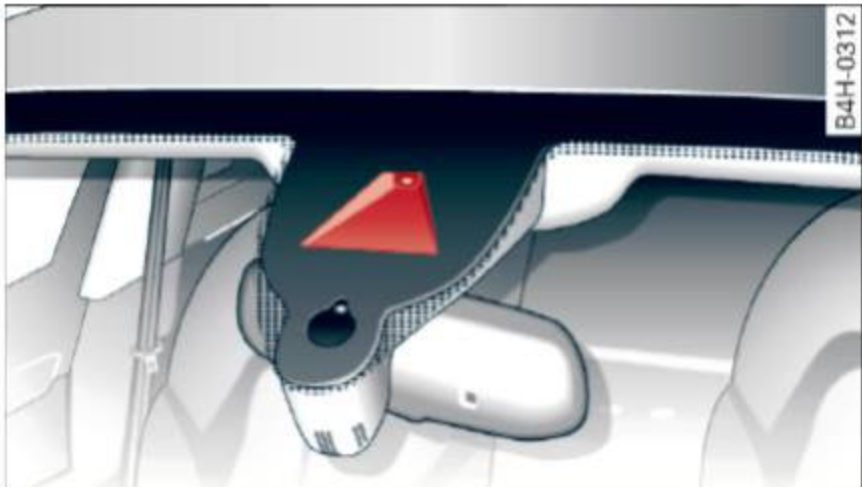

Fig. 92 Windshield: camera window for active lane assist

- ▶ Press the ⇨ *fig. 91* button to switch the system on and off. The or indicator light in the instrument cluster turns on or off.

**Indicator lights**

**Bereit:** the indicator light turns on when the system is ready for use. The system can now be operated.

**Not ready:** the indicator light turns on if the system is switched on but is inoperable. This may be due to the following reasons:

- There is no lane boundary line.
- The relevant lane marker lines are not detected (for example, markings in a construction zone

- or because they are obstructed by snow, dirt, water or lighting).
- The vehicle speed is below the activation speed of approximately 40 mph (65 km/h) (the speed may vary depending on your country).
- The lane is narrower than 8 ft (2.5 m) or wider than 18 ft (5.5 m).
- The curve is too narrow.
- The driver's hands are not on the steering wheel.

**i Tips**

- Make sure the camera's field of view ⇨ *fig. 92* is not obstructed by stickers or anything else. For information on cleaning, refer to ⇨ *page 235*.
- Market-specific: in certain countries: If the system is switched on, it will remain operable each time the ignition is switched on.

**Lane assist display in the instrument cluster**

Applies to vehicles: with Audi active lane assist



Fig. 93 Instrument cluster: monochrome display



Fig. 94 Instrument cluster: multicolored display

The lane assist display can be called up using the buttons in the **multifunction steering wheel** ⇨ *page 28*.



### Monochrome display

Refer to ⇒ *fig. 93*

(A)	solid lines: active lane assist is switched on and ready to provide warnings on the side that is indicated.
(A)	blinking line (left or right): active lane assist is warning you by a vibration in the steering wheel that you are leaving the lane.
(B)	unfilled line(s): lane assist is activated, but not ready to give warning
	no lines: active lane assist is switched off.

### Multicolored display

Refer to ⇒ *fig. 94*

(A)	solid white lines: active lane assist is switched on and ready to provide warnings on the side that is indicated.
(A)	red line (left or right): active lane assist is warning you by a vibration in the steering wheel that you are leaving the lane.
(B)	solid gray lines: lane assist is activated, but not ready to give warning
	no lines: active lane assist is switched off.

### Messages in the instrument cluster display

If the active lane assist has a malfunction, the  indicator light in the instrument cluster display turns off and one of the following messages appears:

#### Audi active lane assist: currently not available. No camera view

This message appears if the camera is unable to detect the lines. This could happen if:

- The camera field of view ⇒ *page 107, fig. 92* is dirty or covered in ice. Clean this area on the windshield.
- The camera field of view is fogged over. Wait until the fog has cleared before switching the active lane assist on again.
- The system has been unable to detect the lanes for an extended period of time due to road con-

ditions. Switch the active lane assist back on when the lines are more visible.

#### Audi active lane assist: Currently unavailable

There is a temporary active lane assist malfunction. Try switching the active lane assist on again later.

#### Audi active lane assist: system fault!

Drive to an authorized Audi dealer or authorized Audi Service Facility immediately to have the malfunction corrected.

#### Audi active lane assist: Please continue steering vehicle!

This message appears if you are not steering by yourself. If this is the case, active lane assist does not switch off, but it is “not ready” to provide a warning. The system can help you keep the vehicle in the lane. However, you are responsible for driving the vehicle and must steer it yourself.

### Adjusting the steering time and vibration warning

Applies to vehicles: with Audi active lane assist

*You can adjust individual active lane assist settings in the MMI.*

- ▶ Select: the MENU button > **Car** > **Systems\*** control button > **Driver assistance** > **Audi active lane assist**.

#### Steering time<sup>1)</sup>

**Early:** in this setting, the corrective steering happens continuously to help keep the vehicle in the center of the lane.

**Late:** in this setting, the system provides corrective steering just before a vehicle wheel touches a detected lane marker line.

#### Vibration warning

You can switch the additional vibrating warning in the steering wheel on or off. ▶

<sup>1)</sup> This function is not available in all countries.



**! WARNING**

With the vibration warning switched off, no visible warning will appear in the instrument cluster display when crossing a lane marker.

**i Tips**

Market-specific: your settings are automatically stored and assigned to the remote control key being used.

## Audi side assist

### Description

Applies to vehicles: with Audi side assist

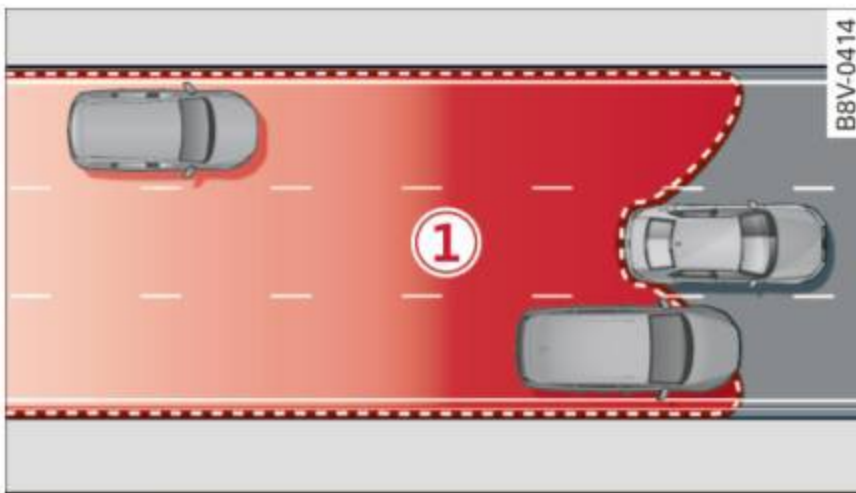

Fig. 95 Sensor detection range



Fig. 96 Display on the exterior mirror

Side assist helps you monitor your blind spot and traffic behind your vehicle. Within the limits of the system, it warns you about vehicles that are coming closer or that are traveling with your within sensor range ① ⇒ fig. 95: If a lane change is classified as critical, the display ② in the exterior mirror turns on ⇒ fig. 96.

The display in the left exterior mirror provides assistance when making a lane change to the left, while the display in the right exterior mirror pro-

vides assistance when making a lane change to the right.

### Information stage

As long as you do not activate the turn signal, side assist *informs* you about vehicles that are detected and classified as critical. The display in the mirror turns on, but is dim.

The display remains dim in the information stage so that your view toward the front is not disturbed.

### Warning stage

If you activate the turn signal, side assist *warns* you about vehicles that are detected and classified as critical. The display in the respective mirror blinks brightly. If this happens, check traffic by glancing in the rearview mirror and over your shoulder ⇒ **!** in *General information on page 110*.

**i Tips**

- You can adjust the brightness on of the display on the rearview mirror ⇒ *page 111*.



**General information**

Applies to vehicles: with Audi side assist

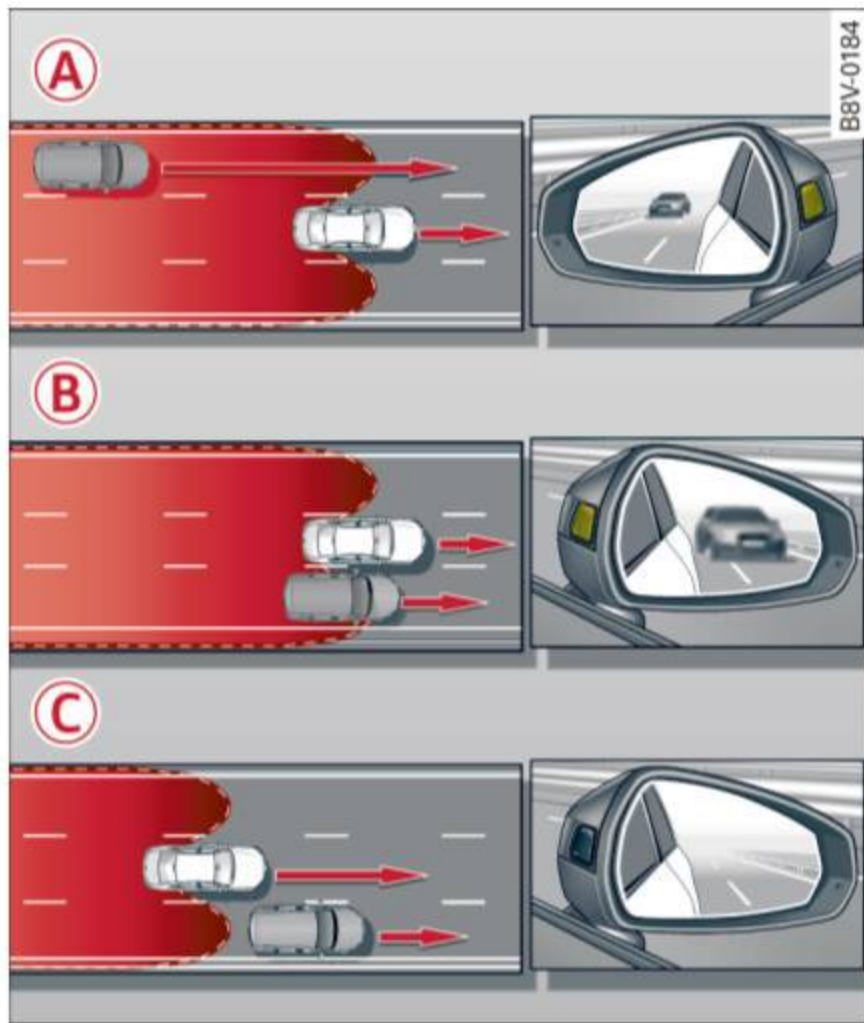

Fig. 97 Driving situations



Fig. 98 Rear of vehicle: sensor positions

Side assist functions at speeds above approximately 19 mph (30 km/h).

**(A) Vehicles that are approaching**

In certain cases, a vehicle will be classified as critical for a lane change even if it is still somewhat far away. The faster a vehicle approaches, the sooner the display in the exterior mirror will turn on.

**(B) Vehicles traveling with you**

Vehicles traveling with you are indicated in the exterior mirror if they are classified as critical for a lane change. All vehicles detected by side assist

are indicated by the time they enter your “blind spot”, at the latest.

**(C) Vehicles left behind**

If you slowly pass a vehicle that side assist has detected (the difference in speed between the vehicle and your vehicle is less than 9 mph or 15 km/h), the display in the exterior mirror turns on as soon as the vehicle enters your blind spot.

The display will not turn on if you quickly pass a vehicle that side assist has detected (the difference in speed between the vehicle and your vehicle is greater than 9 mph or 15 km/h).

**Functional limitations**

The radar sensors are designed to detect the left and right adjacent lanes when the road lanes are the normal width. In some situations, the display in the exterior mirror may turn on even though there is no vehicle located in the area that is critical for a lane change. For example:

- If the lanes are narrow or if you are driving on the edge of your lane. If this is the case, the system may have detected the vehicle in another lane that is *not* adjacent to your current lane.
- If you are driving through a curve. Side assist may react to a vehicle that is one lane over from the adjacent lane.
- If side assist reacts to other objects (such as high or displaced guard rails).
- In poor weather conditions. The side assist functions are limited.

Do not cover the radar sensors ⇒ *fig. 98* with stickers, deposits, bicycle wheels or other objects, because this will affect the function. For information on cleaning, see ⇒ *page 235*.

**⚠ WARNING**

- Always pay attention to traffic and to the area around your vehicle. Side assist cannot replace a driver's attention. The driver alone is always responsible for lane changes and similar driving maneuvers.
- In some situations, the system may not function or its function may be limited. For example:



- If vehicles are approaching or being left behind very quickly. The display may not turn on in time.
- In poor weather conditions such as heavy rain, snow or heavy mist.
- On very wide lanes, in tight curves, or if there is a rise in the road surface. Vehicles in the adjacent lane may not be detected because they are outside of the sensor range.
- Audi side assist cannot detect all vehicles under all conditions, which can increase the risk of accidents.
- Please note that side assist only displays approaching vehicles or vehicles in your blind spot if your vehicle is traveling at least 19 mph (30 km/h).
- In certain situations, the system may not work or its function may be limited. For example:
  - The display may not turn on at the right time if vehicles are approaching or passing very quickly.
  - In poor weather conditions, such as heavy rain, snow or fog.
  - In very wide lanes, in tight curves or when there are slopes in the roadway, vehicles in the neighboring lanes may not be detected because they are outside of the sensor range.

### Note

The sensors can be displaced by impacts or damage to the bumper, wheel housing and underbody. This can affect the system. Have an authorized Audi dealer or authorized Audi Service Facility check their function.

### Tips

- If the window glass in the driver's door or front passenger's door has been tinted, the display in the exterior mirror may be misinterpreted.
- For an explanation on conformity with the FCC regulations in the United States and the Industry Canada regulations, refer to ⇒ *page 265*.

## Switching on and off

Applies to vehicles: with Audi side assist

The system can be switched on and off in the MMI\*.

- ▶ Select: the **MENU** button > **Car** > **Systems\*** control button > **Driver assistance** > **Audi side assist**. With **Off**, the system is switched off.

An activated system will signal every time the ignition is switched on by turning the displays in the exterior mirrors on briefly.

## Adjusting the display brightness

Applies to vehicles: with Audi side assist

*The display brightness can be adjusted in the MMI\*.*

- ▶ Select: the **MENU** button > **Car** > **Systems\*** control button > **Driver assistance** > **Audi side assist**.

The display brightness adjusts automatically to the brightness of the surroundings, both in the information and in the warning stage. In very dark or very bright surroundings, the display is already set to the minimum or maximum level by the automatic adjustment. In such cases, you may notice no change when adjusting the brightness, or the change may only be noticeable once the surroundings change.

Adjust the brightness to a level where the display in the information stage will not disrupt your view forward. If you change the brightness, the display in the exterior mirror will briefly show the brightness level in the information stage. The brightness of the warning stage is linked to the brightness in the information stage and is adjusted along with the information stage adjustment.

### Tips

- Side assist is not active while you are making the adjustment.
- Your settings are automatically stored and assigned to the remote control key being used.



## Driver messages

Applies to vehicles: with Audi side assist

If the side assist switches off automatically, a message appears in the instrument cluster display.

### **Audi side assist: currently unavailable. No sensor vision**

The radar sensors' vision is affected. Do not cover the area in front of the sensors with bike wheels, stickers, dirt or other objects. Clean the area in front of the sensors, if necessary ⇒ *page 110, fig. 98.*

### **Audi side assist: currently unavailable**

Side assist cannot be switched on temporarily because there is a malfunction (for example, the battery charge level may be too low).

### **Audi side assist: System fault!**

The system cannot guarantee that it will detect vehicles correctly and it is switched off. The sensors have been displaced or are faulty. Have the system checked by an authorized Audi dealer or authorized Audi Service Facility soon.

## Audi drive select (drive settings)

### Introduction

Applies to vehicles: with Audi drive select

Audi drive select makes it possible to experience different types of vehicle settings in one vehicle. The driver can select from three **Comfort**, **Auto** and **Dynamic** modes using the  button in the center console or the MMI to switch between a sporty and a comfortable driving mode, for example. In the **individual\*** mode, the settings can be adjusted to your personal preferences. This makes it possible to combine settings such as a sporty engine tuning with light steering.

### **WARNING**

Using Audi drive select incorrectly can lead to collisions, other accidents and serious injuries.

## Description

Applies to vehicles: with Audi drive select

The vehicle setup in each mode depends on the vehicle's features. However, the engine and steering are always affected.

### Engine and automatic transmission

Depending on the mode, the engine and automatic transmission\* respond more quickly or in a more balanced manner to accelerator pedal movements.

### Adaptive dampers (Audi magnetic ride)\*

The adaptive dampers use sensors to record information regarding steering movements, braking and acceleration operations by the driver, road surface, driving speed, and load. With Audi drive select you can adjust the adaptive dampers sporty (dynamic), comfortable (comfort) or balanced (auto).

### Steering

The steering adapts in terms of steering assistance. There are different modes ⇒ *page 113.* Indirect steering that moves easily as in comfort mode is especially suited to long drives on a highway. The dynamic mode provides sporty, direct steering.

For vehicles with progressive steering\* the steering performance is more agile.

### Cornering light\*

The cornering light adjusts when driving on curves at speeds between 6 mph (10 km/h) and 68 mph (110 km/h). The pivoting action and the lighting are also adapted to the mode.

### Adaptive cruise control\*

The behavior when accelerating can be adjusted from comfortable to sporty, depending on the Audi drive select mode. Adaptive cruise control also responds to the driving behavior of the vehicle ahead in a more conservative or sporty manner. ▶



**i Tips**

In some models, the maximum vehicle speed can only be reached in the auto and dynamic modes.

**Selecting the driving mode**

Applies to vehicles: with Audi drive select

You can choose between comfort, auto, dynamic and individual\*.



Fig. 99 Center console: drive select button



Fig. 100 MMI: drive select

- ▶ To set the mode, press the <sup>drive select</sup> button ⇒ fig. 99 repeatedly until the desired mode is displayed in the instrument cluster. Or
- ▶ In the MMI, select: the **MENU** button > **Car** > **Systems\*** control button > **Comfort, Auto, Dynamic** or **Individual\***.

You can change the driving mode when the vehicle is stationary or while driving. If traffic permits, after changing modes, briefly take your foot off the accelerator pedal so that the recently selected mode is also activated for the engine.

**Comfort** - provides a comfort-oriented vehicle setup and is suited for long drives on highways.

**Auto** - provides an overall comfortable yet dynamic driving feel and is suited for every day use.

**Dynamic** - gives the driver a sporty driving feel and is suited to a sporty driving style.

**Individual\*** - ⇒ page 113.

The last chosen mode is retained when the vehicle is started again.

**! WARNING**

Pay attention to traffic when operating the drive select to prevent potential risk of an accident.

**Adjusting the Individual mode**

You can adjust the vehicle settings to your personal preferences.

- ▶ Select: the **MENU** button > **Car** > **Systems\*** control button > **Set individual** control button. Once you select the menu, you will automatically drive in the **individual\*** mode.

After you have closed the settings, you are automatically driving in the **individual\*** driving mode.

The equipment in your vehicle will determine which settings you can adjust. The following table gives an overview of the characteristics.

Systems	comfort	auto	dynamic
Engine and Transmission	comfortable	balanced	sporty
Steering	comfortable	balanced	sporty
Cornering light*	comfortable	balanced	sporty



Systems	comfort	auto	dynamic
Audi adaptive cruise control*	comfortable	balanced	sparty
Adaptive dampers*	comfortable	balanced	sparty
Engine sound*	subtle	subtle/sparty <sup>a)</sup>	sparty

a) Subtle in the selector lever position D and sparty in S.

### Tips

Your **individual\*** mode settings are automatically stored and assigned to the remote control key being used.



## Parking systems

### General information

Applies to vehicles: with rear parking systems/parking system plus/rearview camera

Depending on your vehicle's equipment, various parking aids will help you when parking and maneuvering.

The **rear parking system** is an audible parking aid that warns you of obstacles *behind* the vehicle ⇒ *page 116*.

The **parking system plus** assists you when parking by audibly and visually indicating objects detected *in front of* and *behind* the vehicle ⇒ *page 116*.

The **rearview camera** shows the area behind the vehicle in the MMI display. This display assists you when you are cross or parallel parking. The parking system plus functions are also available ⇒ *page 117*.

#### WARNING

- Always look for traffic and check the area around your vehicle by looking at it directly as well. The parking system cannot replace the driver's attention. The driver is always responsible when entering or leaving a parking space and during similar maneuvers.
- Please note that some surfaces, such as clothing, are not detected by the system.
- Sensors and cameras have blind spots in which people and objects cannot be detected. Be especially cautious of small children and animals.
- Always pay attention to the area around the vehicle – using the rearview mirror, too.
- The sensors can be displaced by impacts or damage to the radiator grille, bumper, wheel housing and the underbody. The parking system may become impaired as a result. Have an authorized Audi dealer or authorized Audi Service Facility check their function.
- Make sure the sensors are not obstructed by stickers, deposits or other materials. If they are, the sensor function could be impaired.

For additional information on cleaning, refer to ⇒ *page 235*.

#### Note

- Some objects are not detected or displayed by the system under certain circumstances:
  - Objects such as barrier chains, trailer draw bars, vertical poles or fences
  - Objects above the sensors such as wall extensions
  - Objects with specific surfaces or structures such as chain link fences or powder snow
- If you continue driving closer to a low-lying object, it may disappear from the sensor range. Note that you will no longer be warned about this obstacle.
- The sensors can be displaced by impacts or damage to the radiator grille, bumper, wheel housing and the underbody. The parking system may become impaired as a result. Have an authorized Audi dealer or authorized Audi Service Facility check their function.

#### Tips

- The system may provide a warning even though there are no obstacles in the coverage area in some situations, such as:
  - certain road surfaces or for long grass.
  - external ultrasonic sources e.g. from cleaning vehicles.
  - heavy rain, snow, or thick vehicle exhaust.
- We recommend that you practice parking in a traffic-free location or parking lot to become familiar with the system. When doing this, there should be good light and weather conditions.
- You can change the volume and pitch of the signals as well as the display ⇒ *page 121*.
- What appears in the MMI display is somewhat time-delayed.
- The sensors must be kept clean and free of snow and ice for the park assist to operate.



## Rear parking system

### Description

Applies to vehicles: with rear parking system

The rear parking system is an audible parking aid.

### Description

There is a sensor in the rear bumper cover. If these detect an obstacle, audible signals warn you.

Make sure the sensors are not covered by stickers, deposits or any other obstructions as it may impair the sensor function. For information on cleaning, refer to ⇒ page 235.

The range at which the sensors begin to measure is approximately:

Side rear	3 ft (0.90 m)
Side center	5.2 ft (1.60 m)

The closer you get to the obstacle, the shorter the interval between the audible signals. A continuous tone sounds when the obstacle is less than approximately 1 foot (0.30 meters) away. Do not continue backing up ⇒ ⚠ in General information on page 115, ⇒ ⚠ in General information on page 115!

If the distance to an obstacle remains constant, the volume of the distance warning gradually drops after about four seconds (this is not apply in the continuous tone range).

### Activating

The parking system activates automatically when the reverse gear is selected. You will hear a brief confirmation tone.

## Parking system plus

### Description

Applies to vehicles: with parking system plus

The parking system plus provides audio and visual signals when parking.

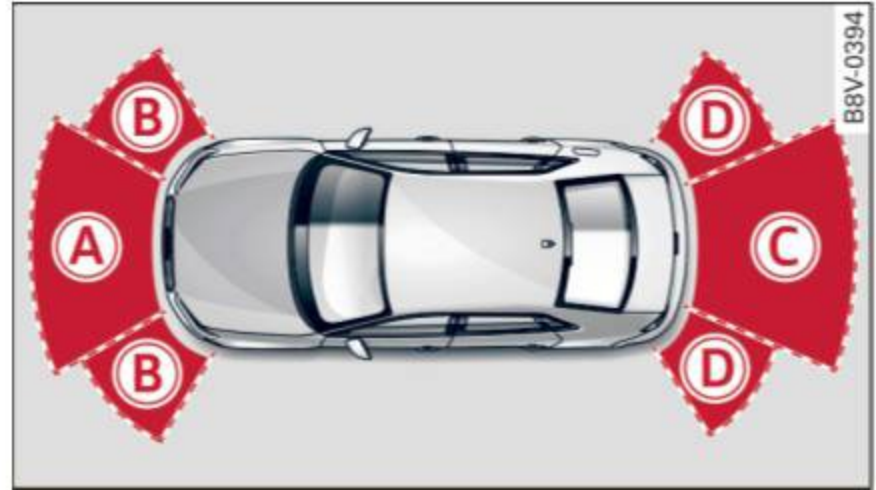

Fig. 101 Display field

Sensors are located in the front and rear bumpers. If these detect an obstacle, audible and visual signals warn you.

Make sure the sensors are not covered by stickers, deposits or any other obstructions as it may impair the sensor function. For information on cleaning, refer to ⇒ page 235.

The display field begins approximately at:

A	4 ft (1.20 m)
B	3 ft (0.90 m)
C	5.2 ft (1.60 m)
D	3 ft (0.90 m)

The closer you get to the obstacle, the shorter the interval between the audible signals. A continuous tone sounds when the obstacle is less than approximately 1 foot (0.30 meters) away. Do not continue driving forward or in reverse ⇒ ⚠ in General information on page 115, ⇒ ⚠ in General information on page 115!

If the distance to an obstacle remains constant, the volume of the distance warning gradually drops after about four seconds (this is not apply in the continuous tone range).



## Switching on/off

Applies to vehicles: with parking system plus



Fig. 102 Center console: parking aid button



Fig. 103 MMI: optical distance display

### Switching on

- ▶ Shift into reverse, or
- ▶ Press the **P** button in the center console ⇒ *fig. 102*. A short confirmation tone sounds and the LED in the button turns on.

### Switching off

- ▶ Drive faster than 6 mph (10 km/h), or
- ▶ Press the **P** button, or
- ▶ switch the ignition off.

### Segments in the visual display

The segments in front of and behind the vehicle (vehicles with parking system plus\*) help you to determine the distance between you and an obstacle. On some equipment the red lines mark the expected direction of travel according to the steering angle. A white segment indicates an identified obstacle that is outside of the vehicle's path. Red segments show identified obstacles that are in your vehicle's path. As your vehicle comes closer to the obstacle, the segments move closer to the vehicle. The collision area has been reached when the next to last segment is dis-

played. Obstacles in the collision area, including those outside of the vehicle's path, are shown in red. Do not continue driving forward or in reverse ⇒ **!** in *General information on page 115*, ⇒ **!** in *General information on page 115*!

## Rearview camera

### Introduction

Applies to vehicles: with parking system plus with rearview camera

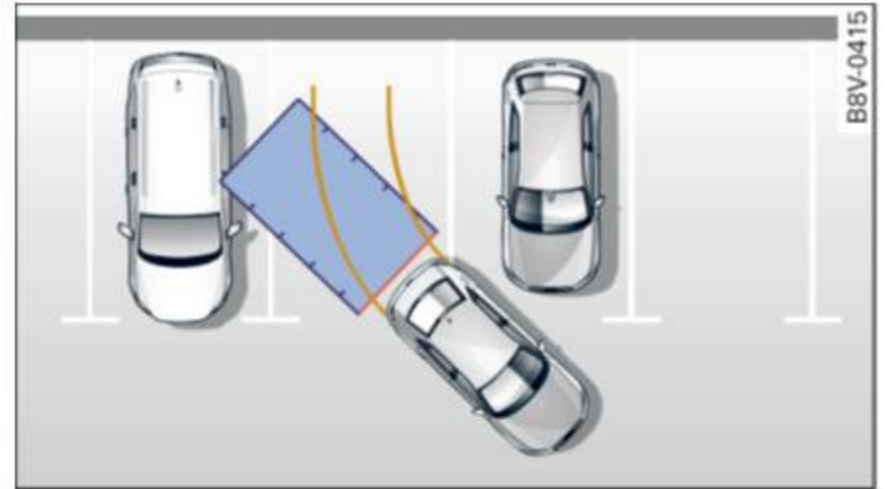

Fig. 104 Illustration: cross parking

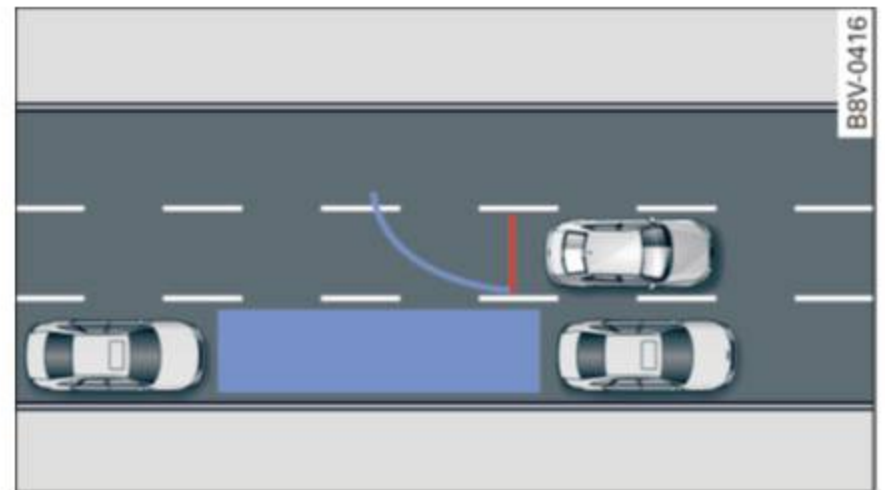

Fig. 105 Illustration: parallel parking

In addition to parking system plus ⇒ *page 116*, this parking system also has a rearview camera.

You can use *cross parking* for example, to park in a parking space or in a garage ⇒ *fig. 104*. You can use *parallel parking* if you would like to park on the side of the road ⇒ *fig. 105*.



### General information

Applies to vehicles: with parking system plus with rearview camera



**Fig. 106** Area covered ① and area not covered ② by the rearview camera.



**Fig. 107** Luggage compartment lid: location of the rearview camera

The rearview camera is located above the rear license plate bracket. Make sure that the lens for the parking system ⇒ *fig. 107* is not covered by deposits or any other obstructions because this can affect the function of the parking system. For information on cleaning, refer to ⇒ *page 235*.

The rearview camera coverage area includes ① ⇒ *fig. 106*. Only this area is displayed in the MMI. Objects that are outside of this area ② are not displayed.

The accuracy of the orientation lines and blue surfaces diminishes if **Dynamic** mode is activated ⇒ *page 112*.

### ⚠ WARNING

- Always read and follow the applicable warnings ⇒ ⚠ in *General information on page 115*.
- If the position and the installation angle of the rearview camera was changed, for example, after a collision, do not continue to use

the system for safety reasons. Have it checked by an authorized Audi dealer or authorized Audi Service Facility.

- Only use the rearview camera to assist you if it shows a good, clear picture. For example, the image may be affected by the sun shining into the lens, dirt on the lens or if there is a defect.
- Use the rearview camera only if the luggage compartment lid is completely closed. If the luggage compartment lid is open the orientation lines and blue surfaces are hidden. Make sure any objects you may have mounted on the luggage compartment lid do not block the rearview camera.
- The camera lens enlarges and distorts the field of vision. The object appears both altered and inaccurate on the screen.
- In certain situations, people or objects in the display appear closer or further away:
  - For objects that do not touch the ground, such as the bumper of a parked vehicle, a trailer hitch or the rear of a truck. Do not use the help lines in this case.
  - If driven from a level surface onto an incline, or a downward slope.
  - If driven toward protruding objects.
  - If the vehicle is carrying too much load in the rear.

### ⚠ Note

- Always read and follow the applicable warnings ⇒ ⚠ in *General information on page 115*.
- The orange colored orientation lines in the MMI display show the direction of travel of the vehicle rear depending on the steering wheel angle. The front of the vehicle front swings out more than the rear of the vehicle. Maintain plenty of distance so that your outside mirror or a corner of your vehicle does not collide with any obstacles.



### Switching on/off

Applies to vehicles: with parking system plus with rearview camera

#### Switching on

- ▶ Shift into reverse, or
- ▶ Press the **P** button in the center console  
⇒ page 117, fig. 102. A short confirmation tone sounds and the LED in the button turns on.

#### Switching between the rearview camera and optical display

- ▶ Press the **Graphic** control button ⑤  
⇒ page 119, fig. 108 to see the optical display.
- ▶ Press the **Rear view** control button to see the rearview camera image.

#### Switching off

- ▶ Drive faster than 6 mph (10 km/h), or
- ▶ Press the **P** button, or
- ▶ switch the ignition off.

#### **i** Tips

The visual display in the left part of the display should help you detect the critical vehicle areas.

### Cross parking

Applies to vehicles: with parking system plus with rearview camera

*This view may be used when parking in a garage or in a parking space.*

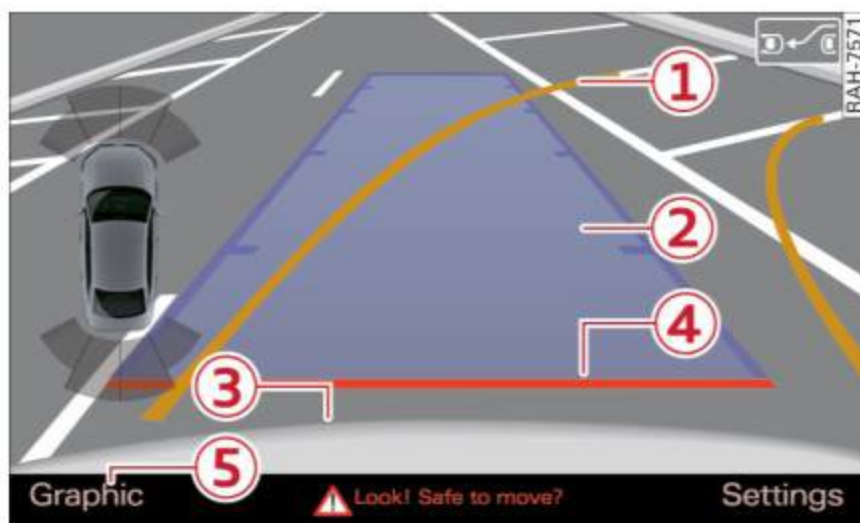

Fig. 108 MMI: aiming at a parking spot

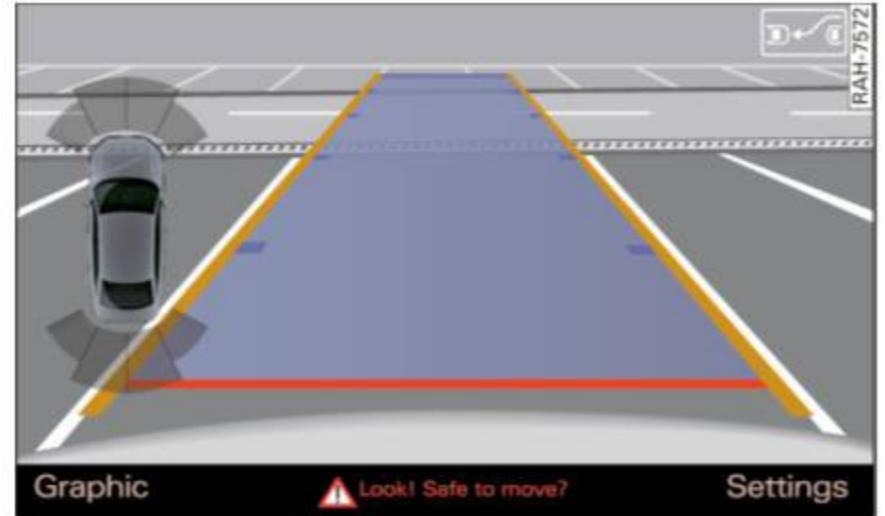

Fig. 109 MMI: aligning the vehicle

- ▶ Turn the MMI on and select the reverse gear.
- ▶ The orange orientation lines ① show the direction of travel of the vehicle. Turn the steering wheel until the orange orientation lines appear in the parking space ⇒ fig. 108. Use the markings ② to help you estimate the distance from an obstacle. Each marking represents approximately 3 ft (1 m). The blue area represents an extension of the vehicle's outline by approximately 16 ft (5 meters) to the rear.
- ▶ While driving in reverse gear, adjust the steering wheel angle to fit the parking space with the aid of the orange orientation lines ⇒ ⚠ in General information on page 118, ⇒ ⚠ in General information on page 118. ③ marks the rear bumper. Stop the vehicle, at the latest, when the red orientation line ④ borders an object.



### Parallel parking

Applies to vehicles: with parking system plus with rearview camera

This view may be used when parallel parking along the side of a street.

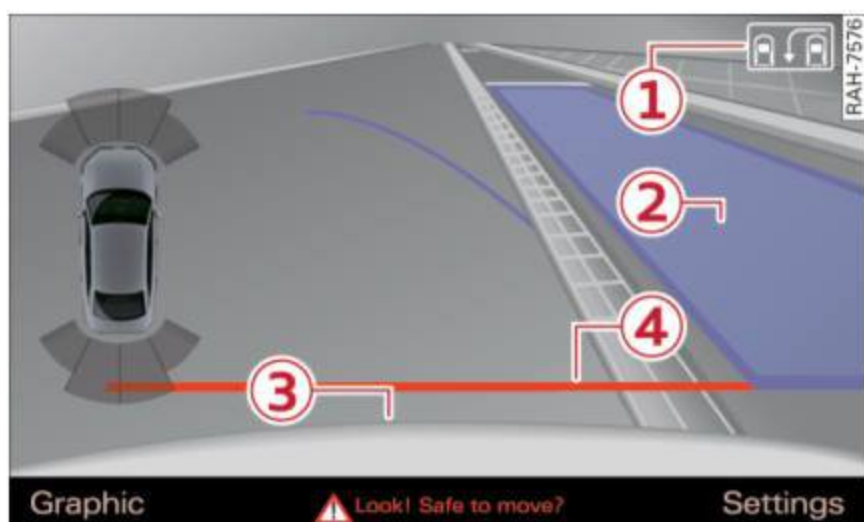

Fig. 110 MMI: blue surface aligned with parking spot

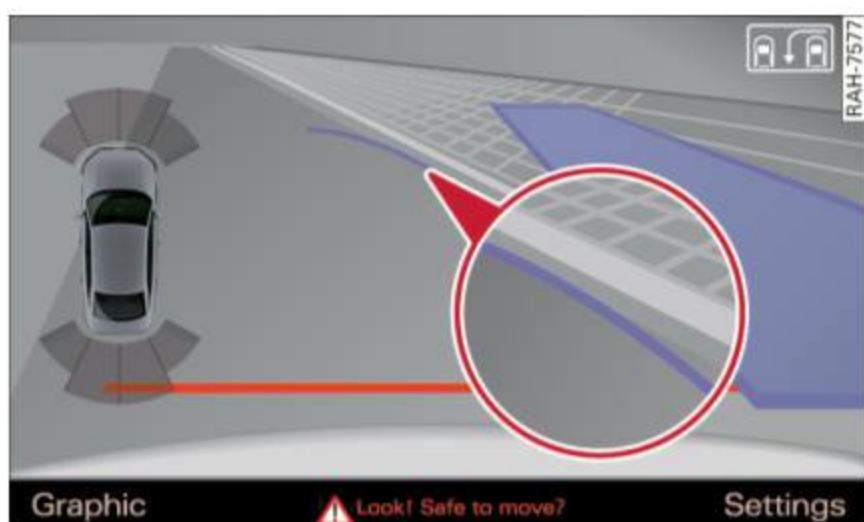

Fig. 111 MMI: contact of the blue curved line with the curb

Parking on the **right** is described here. It is identical when parking on the left.

If there is an obstacle next to the parking space (such as a wall), refer to “Information for parking next to obstacles” ⇒ page 120.

- ▶ Turn on the right turn signal.
- ▶ Position your vehicle next to a parked vehicle in front of the desired parking space. The distance to this vehicle should be approximately 3 ft (1 m).
- ▶ Turn the MMI on and select the reverse gear. The parking system is turned on and the **cross parking** indicator is displayed.
- ▶ Press the control button on the MMI-controls to select ① ⇒ fig. 110. The **parallel parking** indicator is displayed.
- ▶ Back up and align your vehicle so the blue area ② borders on the rear end of the vehicle behind you or on the parking space line ⇒ ⚠ in Gener-

al information on page 118, ⇒ ⚠ in General information on page 118. The blue area represents an extension of the vehicle's outline by approximately 16 ft (5 meters) to the rear. The long side of the blue area should be on the curb. The entire blue area must fit into the parking space.

- ▶ With the vehicle stopped, turn the steering wheel to the right as far as it will go.
- ▶ Back into the parking space until the blue curve ⇒ fig. 111 touches the curb ⇒ ⚠ in General information on page 118, ⇒ ⚠ in General information on page 118. Stop the vehicle.
- ▶ With the vehicle stopped, turn the steering wheel to the left as far as it will go.
- ▶ Continue to back into the parking space until the vehicle is parked parallel to the curb ⇒ ⚠ in General information on page 118, ⇒ ⚠ in General information on page 118. ③ marks the rear bumper. Stop the vehicle, at the latest, when the red orientation line ④ borders an object. Keep an eye on the front of your vehicle while doing this.

### Parking next to obstacles

If there is an obstacle (such as a wall) next to the parking space, position the vehicle so there is more space on that side. Position the long side of the blue surface so that there is sufficient space from the obstacle. The surface must not be touching. You will also need to start turning the steering wheel much earlier. The blue curve ⇒ fig. 111 must **not** touch the obstacle and should have sufficient room.

#### ! Note

Keep enough distance from the curb to avoid damage to the rims.

#### i Tips

The left or right orientation lines and surfaces will be displayed, depending on the turn signal being used.



## Adjusting the display and the warning tones

Applies to vehicles: with parking system plus/rearview camera

The display and warning tones can be adjusted in the MMI.

- ▶ Select: the **MENU** button > **Car** > **Systems\*** control button > **Driver assistance** > **Parking aid**.

### Display

**On\*** - optical display is shown for the parking system plus, rearview camera image is shown for parking system plus with rearview camera\*.

**Off** - when the parking system is switched off, only audible signals are given.

### Warning tones

**Front volume** - Volume for the front and side\* area

**Rear volume** - Volume for the rear area

**Front frequency** - Frequency for the front and side\* area

**Rear frequency** - Frequency for the rear area

**Entertainment volume lowering** - When the parking system is turned on, the volume of the audio/video source is lowered.

The newly adjusted value is briefly heard from the signal generator.

### Tips

- The warning tones can also be adjusted directly from the visual display or the rearview camera image\*. Simply press the **Settings** control button.
- The settings are automatically stored and assigned to the remote control key that is in use.

## Error messages

Applies to vehicles: with parking system plus/rearview camera

There is an error in the system if the LED in the **P** button is blinking and you hear a continuous

alarm for a few seconds after switching on the parking system or when the parking system is already activated. If the error is not corrected before you switch off the ignition, the LED in the **P** button will blink the next time you switch on the parking system by shifting into reverse.

### Parking system plus\*

If a sensor is faulty, the **P** symbol will appear in front of/behind the vehicle in the MMI display. If a rear sensor is faulty, only obstacles that are in areas **A** and **B** are shown ⇒ page 116, fig. 101. If a front sensor is faulty, only obstacles that are in areas **C** and **D** are shown.

Drive to an authorized Audi dealer or authorized Audi Service Facility immediately to have the malfunction corrected.



## Intelligent Technology

### Notice about data recorded by the Event Data Recorder and vehicle control modules

#### Event Data Recorder

This vehicle is equipped with an Event Data Recorder (EDR). The main purpose of an EDR is to record, in certain crash or near crash-like situations, such as an airbag deployment or hitting a road obstacle, data that will assist in understanding how a vehicle's systems performed. The EDR is designed to record data related to vehicle dynamics and safety systems for a short period of time, typically 30 seconds or less. The EDR in this vehicle is designed to record such data as:

- How various systems in your vehicle were operating;
- Whether or not the driver and passenger safety belts were buckled/fastened;
- How far (if at all) the driver was depressing the accelerator and/or brake pedal; and,
- How fast the vehicle was traveling.

These data can help provide a better understanding of the circumstances in which crashes and injuries occur. NOTE: EDR data are recorded by your vehicle only if a non-trivial crash situation occurs; no data are recorded by the EDR under normal driving conditions and no personal data (e.g., name, gender, age, and crash location) are recorded. However, other parties, such as law enforcement, could combine the EDR data with the type of personally identifying data routinely acquired during a crash investigation.

To read data recorded by an EDR, special equipment is required, and access to the vehicle or the EDR is needed. In addition to the vehicle manufacturer, other parties, such as law enforcement, that have the special equipment, can read the information if they have access to the vehicle or the EDR.

Some state laws restrict the retrieval or downloading of data stored by EDRs installed in a vehicle for the express purpose of retrieving data af-

ter an accident or crash event without the owner's consent.

Audi will not access the EDR and/or similar data or give it to others -

- unless the vehicle owner (or lessee if the vehicle has been leased) agrees; or
- upon the official request by the police; or
- upon the order of a court of law or a government agency; or
- for the defense of a lawsuit through the judicial discovery process.
- Audi may also use the data for research about vehicle operation and safety performance or provide the data to a third party for research purposes without identifying the specific vehicle or information about the identity of its owner or lessee and only after the recorded vehicle data has been accessed.

#### Vehicle control modules

Your vehicle is also equipped with a number of electronic control modules for various vehicle systems, such as engine management, emission control, airbags, and safety belts.

These electronic control modules record data during normal vehicle operation that may be needed by trained technicians for diagnostic and repair purposes. The recording capability of these modules is limited to data (no sound is recorded). Only a small amount of data is actually recorded over a very limited period of time, or stored when a system fault is detected by a control module. Some of the data stored may relate to vehicle speed, direction, or braking, as well as restraint system use and performance in the event of a crash. Stored data can also only be read and downloaded with special equipment that is directly connected to the vehicle.

#### Tips

Your vehicle may be equipped with Audi connect. Your use of certain Audi connect features requires wireless services that are provided by a third party wireless telecommunications provider. For details regarding how information obtained through Audi connect is collected, processed, transmitted, used, and



shared, please see your contract with the wireless telecommunications provider and the “About Audi connect” tab in your vehicle’s MMI: **MENU** button > **Audi connect** > **About Audi connect**.

## Electronic stabilization control (ESC)

### Description

The Electronic Stabilization Control (ESC) reinforces driver safety. It reduces the risk of slipping and improves driving stability. ESC detects critical situations such as the vehicle oversteering and understeering or the wheels are spinning. The vehicle is stabilized by applying the brakes or reducing engine torque. Once the ESC is activated, the indicator light  blinks in the instrument cluster.

The following systems are integrated in the ESC:

#### Anti-lock braking system (ABS)

ABS prevents the wheels from locking when braking. The vehicle can still be steered even during hard braking. Apply steady pressure to the brake pedal. Do not pump the pedal. A pulsing in the brake pedal indicates that the system is acting to stabilize the vehicle.

#### Brake assist system

The brake assist system can decrease braking distance. It increases braking power when the driver presses the brake pedal quickly in emergency situations. You must press and hold the brake pedal until the dangerous situation is over. In vehicles with adaptive cruise control\*, the brake assist system is more sensitive if the distance detected to the vehicle ahead is too small.

#### Anti-slip regulation (ASR)

ASR reduces engine power when the drive wheels begin spinning and adapts the force to the road conditions. This makes it easier to start, accelerate and drive up inclines.

#### Electronic differential lock (EDL)

The EDL brakes wheels that are spinning and transfers the drive power to the other drive wheel or wheels if the vehicle is equipped with all wheel drive\*). This function is not available at higher speeds.

In extreme cases, EDL automatically switches off to keep the brake on the braked wheel from overheating. The vehicle is still working correctly. EDL will switch on again automatically when conditions have returned to normal.

#### Steering recommendation

The ESC helps to stabilize the vehicle by changing the steering torque.

#### Selective wheel torque control

Selective wheel torque control is used when driving on curves. The front wheel on the inside of the curve or both wheels on the inside of the curve are braked selectively as needed. This allows more precise driving in curves.

#### Automatic post-collision braking system

The “Automatic post-collision braking system” can help to reduce the risk of sliding and of other collisions after an accident. If the airbag control module detects a collision above a certain vehicle speed, the vehicle is braked by the ESC.

The vehicle does not brake automatically if:

- the driver presses the accelerator pedal, or
- the braking force generated by the pressed brake pedal is greater than the braking force that would be initiated by the system, or
- the ESC, the brake system or the vehicle electrical system are not functioning.



#### WARNING

- The ESC and its integrated systems cannot overcome the limits posed by natural physical laws. This is especially important on slippery or wet roads. If the systems begin acting to stabilize your vehicle, you should immediately alter your speed to match the



road and traffic conditions. Do not let the increased safety provided tempt you into taking risks. This could increase your risk of a collision.

- Please note the risk of a collision increases when driving fast, especially through curves and on slippery or wet roads, and when driving too close to objects ahead. The ESC and its integrated systems cannot always prevent collisions - there is still a risk of accidents!
- Press the accelerator pedal carefully when accelerating on even, slippery surfaces such

as ice and snow. The drive wheels can spin even when these control systems are installed and this can affect driving stability and increase the risk of a collision.

**i Tips**

- ABS and ASR only function correctly when all four wheels are equipped with identical tires. Different tire sizes can lead to a reduction in engine power.
- You may hear noises when the systems described are working.

**Switching on/off**

ESC turns on automatically when you start the engine.



Fig. 112 Upper center console: ESC button

function of the ESC is limited or switched off. The amount of stabilization control will differ depending on the level.

In the following unusual situations it may make sense to switch the ESC sport mode on to allow the wheels to spin:

- Rocking the vehicle to free it when it is stuck
- Driving in deep snow or on loose ground

The ESC is designed to function in levels. Depending on the level that is selected, the stabilization

	Sport mode on	ESC/ASR off	Sport mode off or ESC/ASR on
<b>Behavior</b>	The ESC and ASR stabilization functions are limited ⇒	The stabilization function is not available ⇒ . ESC and ASR are switched off.	The full stabilization function of the ESC and ASR is available again.
<b>Operation</b>	Press the  button briefly.	Press and hold the  button longer than 3 seconds.	Press the  button again.
<b>Indicator lights</b>	turns on.	and <b>ESC OFF*</b> turn on.	turns off or  and <b>ESC OFF*</b> turn off.
<b>Driver messages</b>	<b>Stabilization control (ESC): sport. Warning! Restricted stability</b>	<b>Stabilization control (ESC): off. Warning! Restricted stability</b>	<b>Stabilization control (ESC): on</b>



**! WARNING**

You should only switch sport mode on or switch ESC/ASR off if your driving abilities and road conditions permit.

- The stabilization function is limited when sport mode is switched on. The driving wheels could spin and the vehicle could swerve, especially on slick or slippery road surfaces.
- There is no vehicle stabilization when ESC/ASR are switched off.

**i Tips**

- ESC/ASR cannot be switched off or sport mode cannot be switched on if the cruise control system\* or the adaptive cruise control\* is switched on.
- Malfunctions in the Audi magnetic ride may make it impossible to switch the ESC/ASR off or to switch sport mode on.

## Brakes

### New brake pads

New brake pads do not achieve their full braking effect during the first 250 mi (400 km). They must be “broken in” first. However, you can compensate for the slightly reduced braking force by pressing firmly on the brake pedal. Avoid heavy braking during the break-in period.

### Wear

**Brake pad** wear is largely dependent on the way the vehicle is driven and on operating conditions. This is especially true if you are driving frequently in the city and on curves or with a sporty driving style.

### Operating noise

Noises may occur when braking depending on the speed, braking force and outside conditions such as temperature and humidity.

### Effect of water and road salt

In certain situations, for example after driving through water, in heavy rain, after overnight condensation or after washing your car, the braking

effect can be reduced by moisture or ice on the brake rotors and brake pads. The brakes must be “dried” first with a few careful brake applications.

At higher speeds and with the windshield wipers turned on, the brake pads press against the brake rotors for a short amount of time. This action which is not felt by the driver happens at regular intervals and facilitates a better reaction time for the brakes in wet weather.

The braking effect can also be reduced if you are driving on salted roads and you do not apply the brakes for long periods of time. The layer of salt on the brake rotors and pads must be worn off first when the brakes are applied.

### Corrosion

Leaving the vehicle parked for long periods of time, low mileage and avoiding heavy braking can contribute to corrosion on the brake rotors and dirty brake pads.

If you usually avoid heavy braking or if there is corrosion present, occasional heavy braking at high speeds is recommended to clean the brake rotors and pads ⇒ .

### Brake system malfunction

if you notice that the brake pedal travel has *suddenly* gotten larger, then a brake circuit may have failed. Drive to an authorized Audi dealer or authorized Audi Service Facility immediately to have the problem corrected. On the way there, drive with reduced speed and keep in mind that a long braking distance and increased pressure on the brake pedal will be necessary.

### Low brake fluid level

When the brake fluid level is low, malfunctions in the brake system may occur. The brake fluid level is electronically monitored.

### Brake booster

The brake booster amplifies the pressure you apply to the brake pedal. It only works when the engine is running. ►



### **WARNING**

- New brake pads do not achieve their full braking effect during the first 250 mi (400 km). They must be “broken in” first. However, you can compensate for the slightly reduced braking force by pressing firmly on the brake pedal. Avoid heavy braking during the break-in period.
- Always apply the brakes for the purpose of cleaning the brake system when road and traffic conditions permit. You must not endanger other road users. This increases the risk of an accident.
- On steep slopes, reduce the speed and select a lower gear or lower selector lever position. Drive as little as possible while pressing the brake pedal and avoid putting your left foot on the brake pedal while driving. This could cause the brakes to overheat and impair the efficiency of the brakes.
- Do not let the brakes “grind” by always keeping your foot on the brake pedal. This can cause the brakes to overheat, increase wear and increase braking distance unnecessarily.
- Certain weather and operating conditions such as driving through water, driving in heavy rain or driving after washing your vehicle can impair the effectiveness of the brakes. In the winter, ice may build up on the brake pads, rotors and drums. Check these components by braking carefully. Applying the brakes carefully several times dries the brakes and removes ice build-up.
- The efficiency of the brakes can also be impaired by driving for long stretches on roads covered with salt without using the brakes. You can remove salt deposits from the brake rotors and pads by carefully applying the brakes several times.
- If the front spoiler is damaged or you install another spoiler, make sure the front wheel brakes are ventilated properly. Otherwise, the brake system could overheat, which reduces their effectiveness.
- Failure of a brake circuit impairs braking performance, which increases braking dis-

- tance. Avoid driving the vehicle and have it towed to the nearest authorized Audi dealer or authorized Audi Service Facility.
- Never let the vehicle roll while the engine is stopped because this increases the risk of an accident.
- If the brake booster is not working, you will have to press much harder on the brake pedal to compensate for the lack of the booster.

### **Note**

- Never let the brakes “rub” by pressing the pedal lightly when braking is not really necessary. This causes the brakes to overheat and increases braking distance and causes wear.
- Before driving on a long stretch with steep slopes, reduce your speed and shift to the next lower gear. This makes use of the engine braking effect and relieves the brakes. If you need to brake additionally, brake in intervals and not continuously.

### **Tips**

- If the brake booster is not working, you must press the brake pedal with much more force than normal.
- If you retrofit your vehicle with a front spoiler, wheel covers or similar items, make sure that the air flow to the front wheels is not interrupted. Otherwise the brake system can become too hot.

## Electromechanical steering

*The electromechanical steering supports the driver's steering movements.*

Power steering adapts *electronically* based on the vehicle speed.

The vehicle still has full steering functionality if the power steering fails or when the engine is stopped (towing). To steer, you must apply much more force than usual.

### Indicator lights and messages

 **Do not drive vehicle: steering defective** ►



If this indicator light turns on and stays on and this message appears, the power steering may have failed.

Do **not** continue driving. See an authorized Audi dealer or authorized Audi Service Facility for assistance.

#### **Do not drive vehicle: steering defective**

There is a malfunction in the electronic steering lock. You cannot turn the ignition on.

Do **not** tow your vehicle because it cannot be steered. See an authorized Audi dealer or authorized Audi Service Facility for assistance.

#### **Steering malfunction: you can continue driving**

If the indicator light turns on, the steering wheel may be more difficult to move or more sensitive than usual. The steering wheel may also be at an angle when driving straight.

Drive slowly to an authorized Audi dealer or authorized Audi Service Facility to have the malfunction corrected.

#### **Steering lock: system fault! Please contact Service**



There is a malfunction in the electronic steering lock.

Drive to an authorized Audi dealer or authorized Audi Service Facility immediately to have the malfunction corrected.

#### **WARNING**

Have the system malfunction corrected as soon as possible by an authorized Audi dealer or authorized Audi Service Facility, as this increases the risk of an accident.

#### **Tips**

If the  or  indicator light only stays on for a short time, you may continue driving.

## All wheel drive (quattro)

Applies to vehicles: with all wheel drive

*In all wheel drive, all four wheels are powered.*

### General information

In all wheel drive, the driving power is divided between all four wheels. This happens automatically depending on your driving behavior as well as the current road conditions. Refer to  $\Rightarrow$  page 123, *Electronic stabilization control (ESC)*.

The all wheel drive concept is designed for high engine power. Your vehicle is exceptionally powerful and has excellent driving characteristics both under normal driving conditions and on snow and ice. Always read and follow safety precautions  $\Rightarrow$  .

### Winter tires

By using all wheel drive, your vehicle has good *forward* motion with standard tires in winter conditions. However, in winter we recommend using winter or all season tires on *all four* wheels, because this will improve the *braking* effect.

### Snow chains

If there are snow chain laws, snow chains must also be used on vehicles with all wheel drive  $\Rightarrow$  page 230, *Snow chains*.

### Replacing tires

For vehicles with all wheel drive, only wheels with the same rolling circumference should be used. Avoid wheels with different tread depths  $\Rightarrow$  page 221.

### Offroad vehicle?

Your Audi is not an offroad vehicle - there is not enough ground clearance. For this reason, avoid difficult terrain. Refer to  $\Rightarrow$  page 259.

#### **WARNING**

- Also, in vehicles with all wheel drive, adapt your driving style to the current road and traffic conditions. Do not let the increased safety provided tempt you into taking risks.
- The braking ability of your vehicle is limited to the traction of the wheels. In this way, it



is not different from a two wheel drive vehicle. Do not be tempted to accelerate to a high speed when the road is slippery this increases the risk of an accident.

- Note that on wet streets, the front wheels can “hydroplane” if driving at speeds that are too high. Unlike front wheel drive vehicles, the engine does not rev higher suddenly when the vehicle begins hydroplaning. For this reason, pay attention to the road conditions regardless of your speed.

## Energy management

### The starting ability is optimized

*The energy management system manages the electrical energy distribution and optimizes the availability of electrical energy for starting the engine.*

When a vehicle with a conventional energy system is not driven for a long time, the battery is drained by equipment (for example the immobilizer). In certain circumstances, there could may not be enough energy to start the engine.

Your vehicle is equipped with an intelligent energy management system for distributing electricity. This significantly improves the starting ability and increases the battery life.

The energy management system Is made up of **battery diagnosis, idling current management and dynamic energy management.**

### Battery diagnosis

The battery diagnosis determines the battery charge level. The sensors determine the battery voltage, the battery current, and the battery temperature. The current charge level and the performance of the battery are determined based on this.

### Idling current management

The idling current management decreases the energy used while parked. With the engine switched off, it manages the energy distribution to the different electrical components. Data from battery diagnosis is taken into account for this.

Depending on the battery charge level, electrical equipment is switched off one item after the other, to prevent the battery from draining and to retain the starting ability.

### Dynamic energy management

While driving, dynamic energy management distributes the appropriate amount of energy to the electrical equipment. It controls the battery charge level so that more energy is not used than is being generated in order to maintain an optimal battery charge level.

### Tips

- Energy management cannot overcome the laws of physics. Note that the charge level and length of the battery life are limited.
- When the starting ability is endangered, the  indicator light turns on ⇒ page 19.

### What you should know

*Maintaining the starting ability is the highest priority.*

A lot of stress is placed on the battery when driving short distances, in traffic, and at cold times of the year. A lot of energy is used but little is generated. It is also critical when the engine is not running but electrical equipment is switched on. In this case, energy is used but none is generated.

In situations like this, energy management will actively regulated the distribution of energy.

### Long periods without use

If you do not drive your vehicle for several days or weeks, electrical consumers are gradually scaled back or switched off. This reduces energy use and ensures the vehicle will be able to start after long periods of time. Some convenience functions such as opening with the remote control key may not be available. These convenience functions will be available again once you switch the ignition on and start the engine. ►



**With the engine switched off**

The battery will drain if you use functions such as listening to the radio while the engine is switched off.

The vehicle's ability to start may be impaired by the energy use, a message will appear in the Infotainment system display.

The message indicates that the system will switch off automatically soon. If you would like to continue using the functions, you must start the engine.

**With the engine running**

Although electrical energy is generated while driving, the battery can drain. This can happen when little energy is generated, and much is used and the charge level of the battery is not optimal.

To restore the balance of energy, components that require large amounts of energy are temporarily scaled back or switched off. Heating systems in particular require a great deal of energy. If you notice, for example, that the seat heating\* or rear window defroster is not working, then it has been temporarily reduced or switched off. These systems are available again as soon as the energy balance has been restored.

In addition, you may notice that the idle speed has slightly increased. That is normal and no cause for concern. Due to the increased idling speed, the additional required energy will be generated and the battery will be charged.



## Driving safety

### Basics

#### Safe driving habits

*Please remember - safety first!*

This chapter contains important information, tips, instructions and warnings that you need to read and observe for your own safety, the safety of your passengers and others. We have summarized here what you need to know about safety belts, airbags, child restraints as well as child safety. Your safety is for us *priority number 1*. Always observe the information and warnings in this section - for your own safety as well as that of your passengers.

The information in this section applies to all model versions of your vehicle. Some of the features described in this sections may be standard equipment on some models, or may be optional equipment on others. If you are not sure, ask your authorized Audi dealer.

#### WARNING

- Always make sure that you follow the instructions and heed the WARNINGS in this Manual. It is in your interest and in the interest of your passengers.
- Always keep the complete Owner's Literature in your Audi when you lend or sell your vehicle so that this important information will always be available to the driver and passengers.
- Always keep the Owner's literature handy so that you can find it easily if you have questions.
- Always adjust your speed to the weather traffic and conditions. Follow the speed limits.
- Always drive in such a way that you can stop your vehicle safely.
- Always adjust your speed to the general flow of traffic. Follow the speed limits.

#### Safety equipment

*The safety features are part of the occupant restraint system and work together to help reduce the risk of injury in a wide variety of accident situations.*

Your safety and the safety of your passengers should not be left to chance. Advances in technology have made a variety of features available to help reduce the risk of injury in an accident. The following is a list of just a few of the safety features in your Audi:

- sophisticated safety belts for driver and all passenger seating positions,
- safety belt pretensioners,
- safety belt force limiters for the front seats,
- safety belt height adjustment systems for the front seats,
- front airbags,
- knee airbags for the front seats\*
- side airbags in the front seats and outer rear seats\*,
- side curtain airbags with ejection mitigation features,
- special LATCH anchorages for child restraints,
- head restraints for each seating position,
- adjustable steering column.
- pre sense basic\* (preventative passenger protection)

These individual safety features, can work together as a system to help protect you and your passengers in a wide range of accidents. These features cannot work as a system if they are not always correctly adjusted and correctly used.

**Safety is everybody's responsibility!**

#### Important things to do before driving

*Safety is everybody's job! Vehicle and occupant safety always depends on the informed and careful driver.*

For your safety and the safety of your passengers, **before driving always:**

- ▶ Make sure that all lights and signals are operating correctly.
- ▶ Make sure that the tire pressure is correct. ▶



- ▶ Make sure that all windows are clean and afford good visibility to the outside.
- ▶ Secure all luggage and other items carefully ⇒ *page 59*, ⇒ *page 59*.
- ▶ Make sure that nothing can interfere with the pedals.
- ▶ Adjust front seat, head restraint and mirrors correctly for your height.
- ▶ Instruct passengers to adjust the head restraints according to their height.
- ▶ Make sure to use the right child restraint correctly to protect children ⇒ *page 172, Child safety*.
- ▶ Sit properly in your seat and make sure that your passengers do the same ⇒ *page 54, Front seats*.
- ▶ Fasten your safety belt and wear it properly. Also instruct your passengers to fasten their safety belts properly ⇒ *page 140*.

### What impairs driving safety?

*Safe driving is directly related to the condition of the vehicle, the driver as well as the driver's ability to concentrate on the road without being distracted.*

The driver is responsible for the safety of the vehicle and all of its occupants. If your ability to drive is impaired, safety risks for everybody in the vehicle increase and you also become a hazard to everyone else on the road ⇒ ⚠. Therefore:

- ▶ Do not let yourself be distracted by passengers or by using a cellular telephone.
- ▶ NEVER drive when your driving ability is impaired (by medications, alcohol, drugs, etc.).
- ▶ Observe all traffic laws, rules of the road and speed limits and plain common sense.
- ▶ ALWAYS adjust your speed to road, traffic and weather conditions.
- ▶ Take frequent breaks on long trips. Do not drive for more than two hours at a stretch.
- ▶ Do NOT drive when you are tired, under pressure or when you are stressed.

### ⚠ WARNING

Impaired driving safety increases the risk of serious personal injury and death whenever a vehicle is being used.

## Correct passenger seating positions

### Proper seating position for the driver

*The proper driver seating position is important for safe, relaxed driving.*

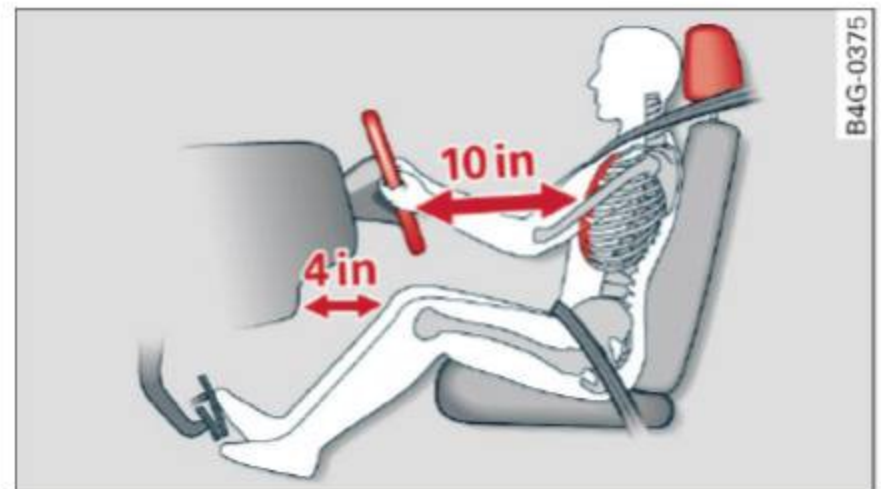

Fig. 113 Correct seating position

For your own safety and to reduce the risk of injury in the event of an accident, we recommend that you adjust the driver's seat to the following position:

- ▶ Adjust the driver's seat so that you can easily push the pedals all the way to the floor while keeping your knee(s) slightly bent ⇒ ⚠.
- ▶ Adjust the angle of the seatback so that it is in an upright position so that your back comes in full contact with it when you drive.
- ▶ Adjust the steering wheel so that there is a distance of at least 10 inches (25 cm) between the steering wheel and your breast bone ⇒ *fig. 113*. If not possible, see your authorized Audi dealership about adaptive equipment.
- ▶ Adjust the steering wheel so that the steering wheel and airbag cover points at your chest and not at your face.
- ▶ Grasp the top of the steering wheel with your elbow(s) slightly bent.
- ▶ For adjustable head restraints: Adjust the head restraint so the upper edge is as even as possible with the top of your head. If that is not possible, try to adjust the head restraint so that it ▶



is as close to this position as possible. Move the head restraint so that it is as close to the back of the head as possible.

- ▶ Fasten and wear safety belts correctly  
⇒ *page 143*.
- ▶ Always keep both feet in the footwell so that you are in control of the vehicle at all times.

For detailed information on how to adjust the driver's seat, see ⇒ *page 55*.

### **WARNING**

Drivers who are unbelted, out of position or too close to the airbag can be seriously injured by an airbag as it unfolds. To help reduce the risk of serious personal injury:

- Always adjust the driver's seat and the steering wheel so that there are at least 10 inches (25 cm) between your breastbone and the steering wheel.
- Always adjust the driver's seat and the steering wheel so that there are at least 4 inches (10 cm) between the knees and the lower part of the instrument panel.
- Always hold the steering wheel on the outside of the steering wheel rim with your hands at the 9 o'clock and 3 o'clock positions to help reduce the risk of personal injury if the driver's airbag inflates.
- Never hold the steering wheel at the 12 o'clock position or with your hands at other positions inside the steering wheel rim or on the steering wheel hub. Holding the steering wheel the wrong way can cause serious injuries to the hands, arms and head if the driver's airbag inflates.
- Pointing the steering wheel toward your face decreases the ability of the supplemental driver's airbag to protect you in a collision.
- Always sit in an upright position and never lean against or place any part of your body too close to the area where the airbags are located.
- Before driving, always adjust the front seats properly and make sure that all passengers are properly restrained.

- For adjustable head restraints: before driving, always also adjust the head restraints properly.
- Never adjust the seats while the vehicle is moving. Your seat may move unexpectedly and you could lose control of the vehicle.
- Never drive with the backrest reclined or tilted far back! The farther the backrests are tilted back, the greater the risk of injury due to incorrect positioning of the safety belt and improper seating position.
- Children must always ride in child seats  
⇒ *page 172*. Special precautions apply when installing a child seat on the front passenger seat ⇒ *page 148*.

### **Proper seating position for the front passenger**

*The proper front passenger seating position is important for safe, relaxed driving.*

For your own safety and to reduce the risk of injury in the event of an accident, we recommend that you adjust the seat for the front passenger to the following position:

- ▶ Adjust the angle of the seatback so that it is in an upright position and your back comes in full contact with it whenever the vehicle is moving.
- ▶ For adjustable head restraints: adjust the head restraint so the upper edge is as even as possible with the top of your head. If that is not possible, try to adjust the head restraint so that it is as close to this position as possible  
⇒ *page 134*. Move the head restraint so that it is as close to the back of the head as possible.
- ▶ Keep both feet flat on the floor in front of the front passenger seat.
- ▶ Fasten and wear safety belts correctly  
⇒ *page 143*.

For detailed information on how to adjust the front passenger's seat, see ⇒ *page 54*.

### **WARNING**

Front seat passengers who are unbelted, out of position or too close to the airbag can be



seriously injured or killed by the airbag as it unfolds. To help reduce the risk of serious personal injury:

- Passengers must always sit in an upright position and never lean against or place any part of their body too close to the area where the airbags are located.
- Passengers who are unbelted, out of position or too close to the airbag can be seriously injured by an airbag as it unfolds with great force in the blink of an eye.
- Always make sure that there are at least 10 inches (25 cm) between the front passenger's breastbone and the instrument panel.
- Always make sure that there are at least 4 inches (10 cm) between the front passenger's knees and the lower part of the instrument panel.
- Each passenger must always sit on a seat of their own and properly fasten and wear the safety belt belonging to that seat.
- Before driving, always adjust the front passenger seat properly.
- For adjustable head restraints: before driving, always also adjust the head restraints properly.
- Always keep your feet on the floor in front of the seat. Never rest them on the seat, instrument panel, out of the window, etc. The airbag system and safety belt will not be able to protect you properly and can even increase the risk of injury in a crash.
- Never drive with the backrest reclined or tilted far back! The farther the backrests are tilted back, the greater the risk of injury due to incorrect positioning of the safety belt and improper seating position.
- Children must always ride in child seats ⇒ *page 172*. Special precautions apply when installing a child seat on the front passenger seat ⇒ *page 148*.

### Proper seating positions for passengers in rear seats

*Rear seat passengers must sit upright with both feet on the floor consistent with their physical size and be properly restrained whenever the vehicle is in use.*

To reduce the risk of injury caused by an incorrect seating position in the event of a sudden braking maneuver or an accident, your passengers on the rear bench seat must always observe the following:

- ▶ For adjustable head restraints: adjust the head restraint so the upper edge is as even as possible with the top of your head. If that is not possible, try to adjust the head restraint so that it is as close to this position as possible ⇒ *page 134*.
- ▶ Keep both feet flat in the footwell in front of the rear seat.
- ▶ Fasten and wear safety belts properly ⇒ *page 143*.
- ▶ Make sure that children are always properly restrained in a child restraint that is appropriate for their size and age ⇒ *page 172*.



#### WARNING

Passengers who are improperly seated on the rear seat can be seriously injured in a crash.

- Each passenger must always sit on a seat of their own and properly fasten and wear the safety belt belonging to that seat.
- Safety belts only offer maximum protection when the safety belts are properly positioned on the body and securely latched. By not sitting upright, a rear seat passenger increases the risk of personal injury from improperly positioned safety belts!
- For adjustable head restraints: always adjust the head restraint properly so that it can give maximum protection.



### Proper adjustment of head restraints

Applies to vehicles: with adjustable head restraints

*Correctly adjusted head restraints are an important part of your vehicle's occupant restraint system and can help to reduce the risk of injuries in accident situations.*

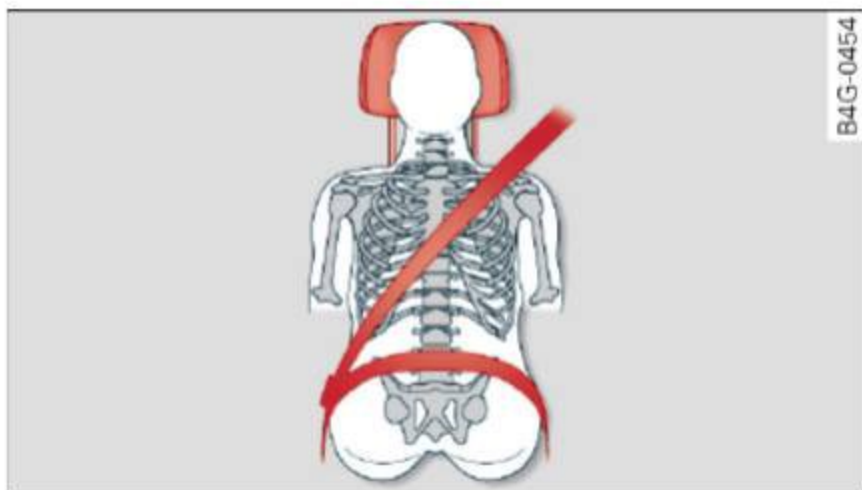

Fig. 114 Head restraint: viewed from the front

The head restraints must be correctly adjusted to achieve the best protection.

- ▶ Adjust the head restraint so the upper edge is as even as possible with the top of your head. If that is not possible, try to adjust the head restraint so that it is as close to this position as possible ⇒ *fig. 114*. Move the head restraint so that it is as close to the back of the head as possible.
- ▶ If there is a passenger on the rear center seating position, slide the center head restraint upward at least to the next notch.

Adjusting head restraints ⇒ *page 56*.

### WARNING

All seats are equipped with head restraints. Driving without head restraints or with head restraints that are not properly adjusted increases the risk of serious or fatal neck injury dramatically. To help reduce the risk of injury:

- Always drive with the head restraints in place and properly adjusted.
- Every person in the vehicle must have a properly adjusted head restraint.
- Always make sure each person in the vehicle properly adjusts their head restraint. Adjust the head restraint so the upper edge is as even as possible with the top of your head. If that is not possible, try to adjust the head

restraint so that it is as close to this position as possible. Move the head restraint so that it is as close to the back of the head as possible.

- Never attempt to adjust head restraint while driving. If you have driven off and must adjust the driver headrest for any reason, first stop the vehicle safely before attempting to adjust the head restraint.
- Children must always be properly restrained in a child restraint that is appropriate for their age and size ⇒ *page 172*.

### Examples of improper seating positions

*The occupant restraint system can only reduce the risk of injury if vehicle occupants are properly seated.*

Improper seating positions can cause serious injury or death. Safety belts can only work when they are properly positioned on the body. Improper seating positions reduce the effectiveness of safety belts and will even increase the risk of injury and death by moving the safety belt to critical areas of the body. Improper seating positions also increase the risk of serious injury and death when an airbag deploys and strikes an occupant who is not in the proper seating position. A driver is responsible for the safety of all vehicle occupants and especially for children. Therefore:

- ▶ Never allow anyone to assume an incorrect seating position when the vehicle is being used ⇒ .

The following bulletins list only some sample positions that will increase the risk of serious injury and death. Our hope is that these examples will make you more aware of seating positions that are dangerous.

#### **Therefore, whenever the vehicle is moving:**

- never stand up in the vehicle
- never stand on the seats
- never kneel on the seats
- never ride with the seatback reclined
- never lie down on the rear seat
- never lean up against the instrument panel



- never sit on the edge of the seat
- never sit sideways
- never lean out the window
- never put your feet out the window
- never put your feet on the instrument panel
- never rest your feet on the seat cushion or back of the seat
- never ride in the footwell
- never ride in the cargo area

### WARNING

Improper seating positions increase the risk of serious personal injury and death whenever a vehicle is being used.

- Always make sure that all vehicle occupants stay in a proper seating position and are properly restrained whenever the vehicle is being used.

## Driver's and front passenger's footwell

### Important safety instructions

Applies to vehicles: with knee airbags

### WARNING

Always make sure that the knee airbag can inflate without interference. Objects between yourself and the airbag can increase the risk of injury in an accident by interfering with the way the airbag deploys or by being pushed into you as the airbag deploys.

- No persons (children) or animals should ride in the footwell in front of the passenger seat. If the airbag deploys, this can result in serious or fatal injuries.
- No objects of any kind should be carried in the footwell area in front of the driver's or passenger's seat. Bulky objects (shopping bags, for example) can hamper or prevent proper deployment of the airbag. Small objects can be thrown through the vehicle if the airbag deploys and injure you or your passengers.

## Pedal area

### Pedals

*The pedals must always be free to move and must never be interfered with by a floor mat or any other object.*

Make sure that all pedals move freely without interference and that nothing prevents them from returning to their original positions.

Only use floor mats that leave the pedal area free and can be secured with floor mat fasteners.

If a brake circuit fails, increased brake pedal travel is required to bring the vehicle to a full stop.

### WARNING

Pedals that cannot move freely can cause loss of vehicle control and increase the risk of serious injury.

- Never place any objects in the driver's footwell. An object could get into the pedal area and interfere with pedal function. In case of sudden braking or an accident, you would not be able to brake or accelerate!
- Always make sure that nothing can fall or move into the driver's footwell.

### Floor mats on the driver side

*Always use floor mats that can be securely attached to the floor mat fasteners and do not interfere with the free movement of the pedals.*

- ▶ Make sure that the floor mats are properly secured and cannot move and interfere with the pedals ⇒ .

Use only floor mats that leave the pedal area unobstructed and that are firmly secured so that they cannot slip out of position. You can obtain suitable floor mats from your authorized Audi Dealer.

Floor mat fasteners are installed in your Audi.

Floor mats used in your vehicle must be attached to these fasteners. Properly securing the floor



mats will prevent them from sliding into positions that could interfere with the pedals or impair safe operation of your vehicle in other ways.

### **WARNING**

Pedals that cannot move freely can result in a loss of vehicle control and increase the risk of serious personal injury.

- Always make sure that floor mats are properly secured.
- Never place or install floor mats or other floor coverings in the vehicle that cannot be properly secured in place to prevent them from slipping and interfering with the pedals or the ability to control the vehicle.
- Never place or install floor mats or other floor coverings on top of already installed floor mats. Additional floor mats and other coverings will reduce the size of the pedal area and interfere with the pedals.
- Always properly reinstall and secure floor mats that have been taken out for cleaning.
- Always make sure that objects cannot fall into the driver footwell while the vehicle is moving. Objects can become trapped under the brake pedal and accelerator pedal causing a loss of vehicle control.

## Storing cargo correctly

### Loading the luggage compartment

*All luggage and other objects must be properly stowed and secured in the luggage compartment.*

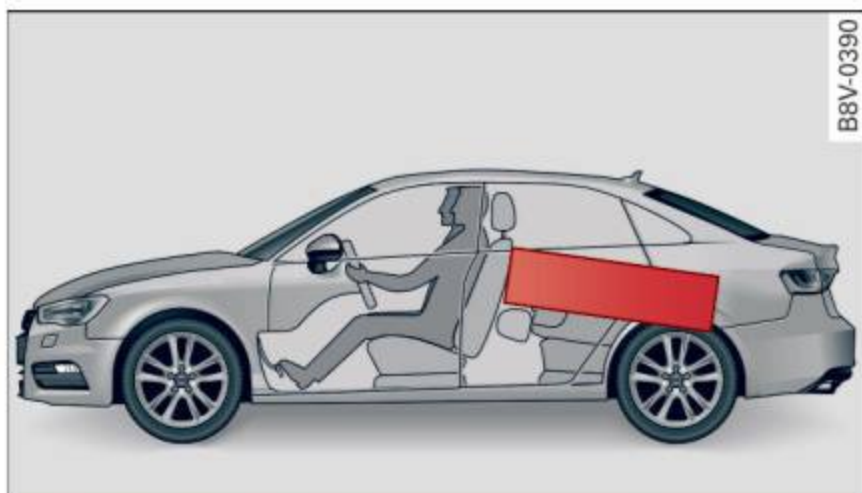

**Fig. 115** Safe load positioning: place heavy objects as low and as far forward as possible.

Loose items in the luggage compartment can shift suddenly, changing vehicle handling characteristics. Loose items can also increase the risk of serious personal injury in a sudden vehicle maneuver or in a collision.

- ▶ Distribute the load evenly in the luggage compartment.
- ▶ Always place and properly secure heavy items in the luggage compartment as far forward as possible.
- ▶ Secure luggage using the tie-downs provided ⇒ *page 59*.
- ▶ Make sure that the rear seatback is securely latched in place.

### **WARNING**

Improperly stored luggage or other items can fly through the vehicle causing serious personal injury in the event of hard braking or an accident. To help reduce the risk of serious personal injury:

- Always put objects, for example, luggage or other heavy items in the luggage compartment.
- Always secure objects in the luggage compartment using the tie-down hooks and suitable straps.

### **WARNING**

Heavy loads will influence the way your vehicle handles. To help reduce the risk of a loss of control leading to serious personal injury:

- Always keep in mind when transporting heavy objects, that a change in the center of gravity can also cause changes in vehicle handling:
  - Always distribute the load as evenly as possible.
  - Place heavy objects as far forward in the luggage compartment as possible.
- Never exceed the Gross Axle Weight Rating or the Gross Vehicle Weight Rating specified on the safety compliance sticker on the left door jamb. Exceeding permissible weight standards can cause the vehicle to slide and handle differently.



- Please observe information on safe driving ⇒ page 130.

### WARNING

To help prevent poisonous exhaust gas from being drawn into the vehicle, always keep the rear lid closed while driving.

- Never transport objects larger than those fitting completely into the luggage area because the rear lid cannot be fully closed.
- If you absolutely must drive with the rear lid open, observe the following notes to reduce the risk of poisoning:
  - Close all windows,
  - Close the power roof\*,
  - Open all air outlets in the instrument panel,
  - Switch off the air recirculation,
  - Set the fresh air fan to the highest speed.

### WARNING

Always make sure that the doors, all windows, the power roof\* and the rear lid are securely closed and locked to reduce the risk of injury when the vehicle is not being used.

- After closing the rear lid, always make sure that it is properly closed and locked.
- Never leave your vehicle unattended especially with the rear lid left open. A child could crawl into the vehicle through the luggage compartment and close the rear lid becoming trapped and unable to get out. Being trapped in a vehicle can lead to serious personal injury.
- Never let children play in or around the vehicle.
- Never let passengers ride in the luggage compartment. Vehicle occupants must always be properly restrained in one of the vehicle's seating positions.

### Tips

- Air circulation helps to reduce window fogging. Stale air escapes to the outside through vents in the trim panel. Be sure to keep these slots free and open.

- The tire pressure must correspond to the load. The tire pressure is shown on the tire pressure label. The tire pressure label is located on the driver's side B-pillar. The tire pressure label lists the recommended cold tire inflation pressures for the vehicle at its maximum capacity weight and the tires that were on your vehicle at the time it was manufactured. For recommended tire pressures for normal load conditions, please see chapter ⇒ page 224.

### Tie-downs

*The luggage compartment is equipped with four tie-downs to secure luggage and other items.*

Use the tie-downs to secure your cargo properly ⇒ page 136, *Loading the luggage compartment.*

In a collision, the laws of physics mean that even smaller items that are loose in the vehicle will become heavy missiles that can cause serious injury. Items in the vehicle possess energy which vary with vehicle speed and the weight of the item. Vehicle speed is the most significant factor.

For example, in a frontal collision at a speed of 30 mph (48 km/h), the forces acting on a 10-lb (4.5 kg) object are about 20 times the normal weight of the item. This means that the weight of the item would suddenly be about 200 lbs. (90 kg). You can imagine the injuries that a 200 lbs. (90 kg) item flying freely through the passenger compartment could cause in a collision like this.

### WARNING

Weak, damaged or improper straps used to secure items to tie-downs can fail during hard braking or in a collision and cause serious personal injury.

- Always use suitable mounting straps and properly secure items to the tie-downs in the luggage compartment to help prevent items from shifting or flying forward as dangerous missiles.
- When the rear seat backrest is folded down, always use suitable mounting straps and properly secure items to the tie-downs in



the luggage compartment to help prevent items from flying forward as dangerous missiles into the passenger compartment.

- Never attach a child safety seat tether strap to a tie-down.

## Reporting Safety Defects

### Applicable to U.S.A.

If you believe that your vehicle has a defect which could cause a crash or could cause injury or death, you should immediately inform the National Highway Traffic Safety Administration (NHTSA) in addition to notifying Audi of America, Inc.

If NHTSA receives similar complaints, it may open an investigation, and if it finds that a safety defect exists in a group of vehicles, it may order a recall and remedy campaign. However, NHTSA cannot become involved in individual problems between you, your dealer, or Audi of America, Inc.

To contact the NHTSA, you may either call:

Tel.: 1-888-327-4236 (TTY: 1-800-424-9153) or 1-800-424-9393

or you may write to:

NHTSA

U.S. Department of Transportation

1200 New Jersey Ave., S.E.

West Building

Washington, DC 20590

You can also obtain other information about motor vehicle safety from:

<http://www.safercar.gov>

### Applicable to Canada

If you live in Canada and you believe that your vehicle has a defect that could cause a crash, injury or death, you should immediately inform Transport Canada, Defect Investigations and Recalls. You should also notify Audi Canada.

Canadian customers who wish to report a safety-related defect to Transport Canada, Defect Investigations and Recalls, may either call Transport Canada toll-free at:

Tel.: 1-800-333-0510 or

Tel.: 1-819-994-3328 (Ottawa region and from other countries)

TTY for hearing impaired: Tel.:

1-888-675-6863

or contact Transport Canada by mail at: 



Transport Canada  
Motor Vehicle Safety Investiga-  
tions Laboratory  
80 Noel Street  
Gatineau, QC  
J8Z 0A1

For additional road safety infor-  
mation, please visit the Road  
Safety website at:

[http://www.tc.gc.ca/eng/  
roadsafety/menu.htm](http://www.tc.gc.ca/eng/roadsafety/menu.htm)



# Safety belts

## General notes

### Always wear safety belts!

*Wearing safety belts correctly saves lives!*

This chapter explains why safety belts are necessary, how they work and how to adjust and wear them correctly.

- ▶ Read all the information that follows and heed all of the instructions and WARNINGS.

### WARNING

Not wearing safety belts or wearing them improperly increases the risk of serious personal injury and death.

- Safety belts are the single most effective means available to reduce the risk of serious injury and death in automobile accidents. For your protection and that of your passengers, always correctly wear safety belts when the vehicle is moving.
- Pregnant women, injured, or physically impaired persons must also use safety belts. Like all vehicle occupants, they are more likely to be seriously injured if they do not wear safety belts. The best way to protect a fetus is to protect the mother - throughout the entire pregnancy.

### Number of seats

Your Audi has a total of five seating positions: two in the front and three in the rear. Each seating position has a safety belt.

### WARNING

Not wearing safety belts or wearing them improperly increases the risk of serious personal injury and death.

- Never strap more than one person, including small children, into any belt. It is especially dangerous to place a safety belt over a child sitting on your lap.
- Never let more people ride in the vehicle than there are safety belts available.

- Be sure everyone riding in the vehicle is properly restrained with a separate safety belt or child restraint.

### Safety belt warning light

Your vehicle has a warning system for the driver and front seat passenger (on USA models only) to remind you about the importance of buckling-up.



Fig. 116 Safety belt warning light in the instrument cluster - enlarged

### Before driving off, always:

- ▶ Fasten your safety belt and make sure you are wearing it properly.
- ▶ Make sure that your passengers also buckle up and properly wear their safety belts.
- ▶ Protect children with a child restraint system appropriate for the size and age.

The warning light  in the instrument cluster lights up when the ignition is on as a reminder to fasten the safety belts. In addition, you will hear a warning tone for a certain period of time.

**Fasten your safety belt and make sure that your passengers also properly put on their safety belts.**

### WARNING

- Safety belts are the single most effective means available to reduce the risk of serious injury and death in automobile accidents. For your protection and that of your passengers, always correctly wear safety belts when the vehicle is moving.
- Failure to pay attention to the warning light that come on, could lead to personal injury.



## Why use safety belts?

### Frontal collisions and the law of physics

Frontal crashes create very strong forces for people riding in vehicles.

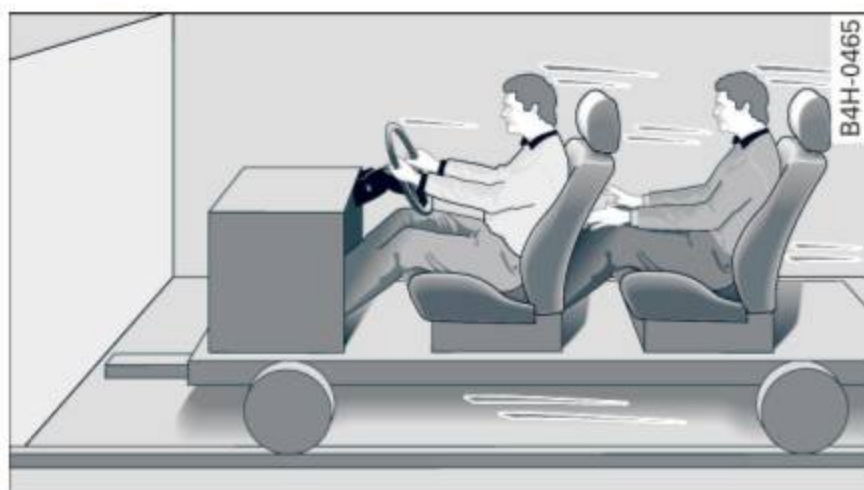

Fig. 117 Unbelted occupants in a vehicle heading for a wall



Fig. 118 The vehicle crashes into the wall

The physical principles are simple. Both the vehicle and the passengers possess energy which varies with vehicle speed and body weight. Engineers call this energy “kinetic energy.”

The higher the speed of the vehicle and the greater the vehicle's weight, the more energy that has to be “absorbed” in the crash.

Vehicle speed is the most significant factor. If the speed doubles from 15 to 30 mph (25 to 50 km/h), the energy increases 4 times!

Because the passengers of this vehicle are not using safety belts ⇒ *fig. 117*, they will keep moving at the same speed the vehicle was moving just before the crash, until something stops them - here, the wall ⇒ *fig. 118*.

The same principles apply to people sitting in a vehicle that is involved in a frontal collision. Even at city speeds of 20 to 30 mph (30 to 50 km/h), the forces acting on the body can reach one ton

(2,000 lbs, or 1,000 kg) or more. At greater speeds, these forces are even higher.

People who do not use safety belts are also not attached to their vehicle. In a frontal collision they will also keep moving forward at the speed their vehicle was travelling just before the crash. Of course, the laws of physics don't just apply to frontal collisions, they determine what happens in all kinds of accidents and collisions.

### What happens to occupants not wearing safety belts?

In crashes unbelted occupants cannot stop themselves from flying forward and being injured or killed. Always wear your safety belts!



Fig. 119 A driver not wearing a safety belt is violently thrown forward



Fig. 120 A rear passenger not wearing a safety belt will fly forward and strike the driver

Unbelted occupants are not able to resist the tremendous forces of impact by holding tight or bracing themselves. Without the benefit of safety restraint systems, the unrestrained occupant will slam violently into the steering wheel, instrument panel, windshield, or whatever else is in the way ⇒ *fig. 119*. This impact with the vehicle interior has all the energy they had just before the crash.



Never rely on airbags alone for protection. Even when they deploy, airbags provide only additional protection. Airbags are not supposed to deploy in all kinds of accidents. Although your Audi is equipped with airbags, all vehicle occupants, including the driver, must wear safety belts correctly in order to minimize the risk of severe injury or death in a crash.

Remember too, that airbags will deploy only once and that your safety belts are always there to offer protection in those accidents in which airbags are not supposed to deploy or when they have already deployed. Unbelted occupants can also be thrown out of the vehicle where even more severe or fatal injuries can occur.

It is also important for the rear passengers to wear safety belts correctly. Unbelted passengers in the rear seats endanger not only themselves but also the driver and other passengers ⇒ *fig. 120*. In a frontal collision they will be thrown forward violently, where they can hit and injure the driver and/or front seat passenger.

### Safety belts protect

*People think it's possible to use the hands to brace the body in a minor collision. It's simply not true!*



**Fig. 121** Driver is correctly restrained in a sudden braking maneuver

Safety belts used properly can make a big difference. Safety belts help to keep passengers in their seats, gradually reduce energy levels applied to the body in an accident, and help prevent the uncontrolled movement that can cause serious injuries. In addition, safety belts reduce the danger of being thrown out of the vehicle.

Safety belts attach passengers to the car and give them the benefit of being slowed down more gently or “softly” through the “give” in the safety belts, crush zones and other safety features engineered into today's vehicles. By “absorbing” the kinetic energy over a longer period of time, the safety belts make the forces on the body more “tolerable” and less likely to cause injury.

Although these examples are based on a frontal collision, safety belts can also substantially reduce the risk of injury in other kinds of crashes. So, whether you're on a long trip or just going to the corner store, always buckle up and make sure others do, too. Accident statistics show that vehicle occupants properly wearing safety belts have a lower risk of being injured and a much better chance of surviving an accident. Properly using safety belts also greatly increases the ability of the supplemental airbags to do their job in a collision. For this reason, wearing a safety belt is legally required in most countries including much of the United States and Canada.

Although your Audi is equipped with airbags, you still have to wear the safety belts provided. Front airbags, for example, are activated only in some frontal collisions. The front airbags are not activated in all frontal collisions, in side and rear collisions, in roll overs or in cases where there is not enough deceleration through impact to the front of the vehicle. The same goes for the other airbag systems in your Audi. So, always wear your safety belt and make sure everybody in your vehicle is properly restrained!

### Important safety instructions about safety belts

*Safety belts must always be correctly positioned across the strongest bones of your body.*

- ▶ Always wear safety belts as illustrated and described in this chapter.
- ▶ Make sure that your safety belts are always ready for use and are not damaged.



**! WARNING**

Not wearing safety belts or wearing them improperly increases the risk of serious personal injury and death. Safety belts can work only when used correctly.

- Always fasten your safety belts correctly before driving off and make sure all passengers are correctly restrained.
- For maximum protection, safety belts must always be positioned properly on the body.
- Never strap more than one person, including small children, into any belt.
- Never place a safety belt over a child sitting on your lap.
- Always keep feet in the footwell in front of the seat while the vehicle is being driven.
- Never let any person ride with their feet on the instrument panel or sticking out the window or on the seat.
- Never remove a safety belt while the vehicle is moving. Doing so will increase your risk of being injured or killed.
- Never wear belts twisted.
- Never wear belts over rigid or breakable objects in or on your clothing, such as eye glasses, pens, keys, etc., as these may cause injury.
- Never allow safety belts to become damaged by being caught in door or seat hardware.
- Do not wear the shoulder part of the belt under your arm or otherwise out of position.
- Several layers of heavy clothing may interfere with correct positioning of belts and reduce the overall effectiveness of the system.
- Always keep belt buckles free of anything that may prevent the buckle from latching securely.
- Never use comfort clips or devices that create slack in the shoulder belt. However, special clips may be required for the proper use of some child restraint systems.
- Torn or frayed safety belts can tear, and damaged belt hardware can break in an accident. Inspect belts regularly. If webbing, bindings, buckles, or retractors are dam-

aged, have belts replaced by an authorized Audi dealer or qualified workshop.

- Safety belts that have been worn and loaded in an accident must be replaced with the correct replacement safety belt by an authorized Audi dealer. Replacement may be necessary even if damage cannot be clearly seen. Anchorages that were loaded must also be inspected.
- Never remove, modify, disassemble, or try to repair the safety belts yourself.
- Always keep the belts clean. Dirty belts may not work properly and can impair the function of the inertia reel ⇒ *table Internal cleaning on page 237.*

## Safety belts

### Fastening safety belts

*Safety first - everybody buckle up!*



**Fig. 122** Belt buckle and tongue on the driver's seat

To provide maximum protection, safety belts must always be positioned correctly on the wearer's body.

- ▶ Adjust the front seat and head restraint properly ⇒ *page 54, Front seats.*
- ▶ Make sure the seatback of the rear seat bench is in an upright position and securely latched in place before using the belt ⇒ **!**
- ▶ Hold the belt by the tongue and pull it evenly across the chest and pelvis ⇒ **!**
- ▶ Insert the tongue into the correct buckle of your seat until you hear it latch securely ⇒ *fig. 122.*
- ▶ Pull on the belt to make sure that it is securely latched in the buckle.



### Automatic safety belt retractors

Every safety belt is equipped with an automatic belt retractor on the shoulder belt. This feature locks the belt when the belt is pulled out fast, during hard braking and in an accident. The belt may also lock when you drive up or down a steep hill or through a sharp curve. During normal driving the belt lets you move freely.

### Safety belt pretensioners

The safety belts are equipped with a belt pretensioner that helps to tighten the safety belt and remove slack when the pretensioner is activated ⇒ *page 146*. The function of the pretensioner is monitored by a warning light ⇒ *page 20*.

### Convertible locking retractor

Every safety belt except the one on the driver seat is equipped with a convertible locking retractor that **must** be used when the safety belt is used to attach a child seat. Be sure to read the important information about this feature ⇒ *page 182*.

#### **WARNING**

Improperly positioned safety belts can cause serious injury in an accident ⇒ *page 144*, *Safety belt position*.

- Safety belts offer optimum protection only when the seatback is upright and belts are properly positioned on the body.
- Always make sure that the rear seat backrest to which the center rear safety belt\* is attached is securely latched whenever the rear center safety belt is being used. If the backrest is not securely latched, the passenger will move forward with the backrest during sudden braking, in a sudden maneuver and especially in a crash.
- Never attach the safety belt to the buckle for another seat. Attaching the belt to the wrong buckle will reduce safety belt effectiveness and can cause serious personal injury.
- A passenger who is not properly restrained can be seriously injured by the safety belt itself when it moves from the stronger parts

of the body into critical areas like the abdomen.

- Always lock the convertible locking retractor when you are securing a child seat in the vehicle ⇒ *page 184*.

#### **Tips**

For information on safety belt pretensioners, refer to ⇒ *page 146*.

### Safety belt position

*Correct belt position is the key to getting maximum protection from safety belts.*

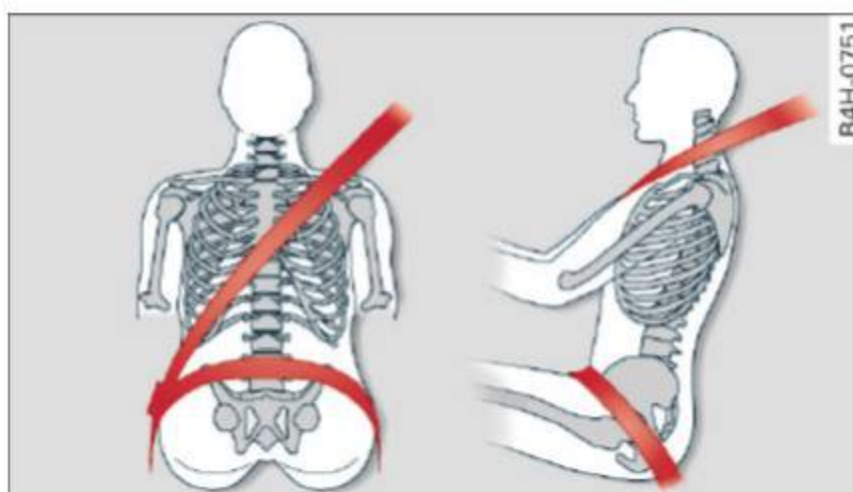

**Fig. 123** Safety belt position

Use the height adjustment to change the position of the shoulder belt of the front safety belts.

#### **WARNING**

Improperly positioned safety belts can cause serious personal injury in an accident.

- The shoulder belt should lie as close to the center of the collar bone as possible and should fit well on the body. Hold the belt above the latch tongue and pull it evenly across the chest so that it sits as low as possible on the pelvis and there is no pressure on the abdomen. The belt should always fit snugly ⇒ *fig. 123*. Pull on the belt to tighten if necessary.
- The lap belt portion of the safety belt must be positioned as low as possible across pelvis and never over the abdomen. Make sure the belt lies flat and snug ⇒ *fig. 123*. Pull on the belt to tighten if necessary.



- A loose-fitting safety belt can cause serious injuries by shifting its position on your body from the strong bones to more vulnerable, soft tissue and cause serious injury.
- Always read and heed all WARNINGS and other important information ⇒ *page 142*.

### Pregnant women must also be correctly restrained

The best way to protect the fetus is to make sure that expectant mothers always wear safety belts correctly - throughout the pregnancy.



Fig. 124 Safety belt position during pregnancy

To provide maximum protection, safety belts must always be positioned correctly on the wearer's body ⇒ *page 144*.

- ▶ Adjust the front seat and adjustable head restraint\* correctly ⇒ *page 54, Front seats*.
- ▶ Hold the belt by the tongue and pull it evenly across the chest and pelvis ⇒ *fig. 124*, ⇒ ⚠.
- ▶ Insert the tongue into the correct buckle of your seat until you hear it latch securely ⇒ *page 143, fig. 122*.
- ▶ Pull on the belt to make sure that it is securely latched in the buckle.

### ⚠ WARNING

Improperly positioned safety belts can cause serious personal injury in an accident.

- Expectant mothers must always wear the lap portion of the safety belt as low as possible across the pelvis and below the rounding of the abdomen.
- Always read and heed all WARNINGS and other important information ⇒ ⚠ in *Fastening safety belts on page 144*.

### Unfastening safety belts

Unbuckle the safety belt with the red release button only after the vehicle has stopped.



Fig. 125 Releasing the tongue from the buckle

- ▶ Push the red release button on the buckle ⇒ *fig. 125*. The belt tongue will spring out of the buckle ⇒ ⚠.
- ▶ Let the belt wind up on the retractor as you guide the belt tongue to its stowed position.

### ⚠ WARNING

Never unfasten safety belt while the vehicle is moving. Doing so will increase your risk of being injured or killed.

### Adjusting the safety belt latch tongue



Fig. 126 Safety belt: latch tongue clip (example)

- ▶ Slide the clip so that you can easily reach the belt latch when putting the safety belt on.



### Adjusting safety belt height

With the aid of the safety belt height adjustment, the three point safety belt strap routing can be fitted to the shoulder area, according to body size.

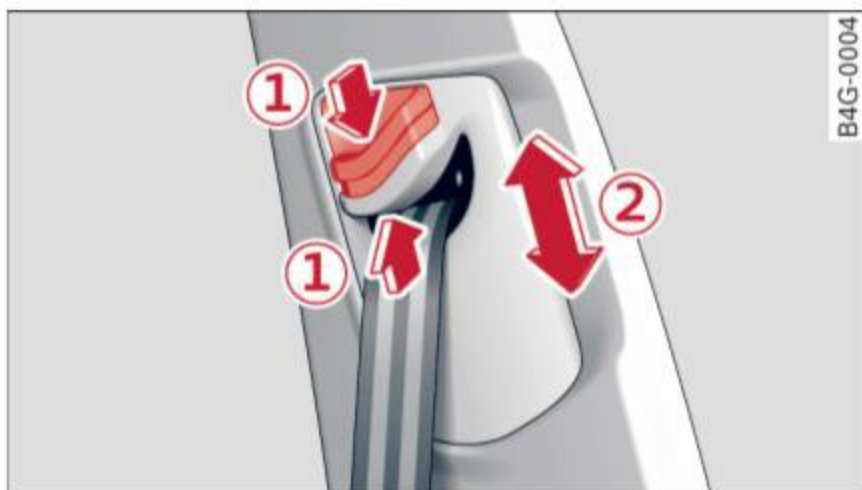

Fig. 127 Safety belt height adjustment for the front seats - loop-around fittings

The shoulder belt should lie as close to the center of the collar bone as possible and should fit well on the body ⇒ ⚠ in *Safety belt position on page 144*.

- ▶ Push the loop-around fittings **up** ⇒ fig. 127 ②, or
- ▶ squeeze together the ① button, and push the loop-around fittings **down** ②.
- ▶ Pull the belt to make sure that the upper attachment is properly engaged.

### ⚠ WARNING

Always read and heed all WARNINGS and other important information ⇒ *page 142*.

### i Tips

With the front seats, the height adjustment of the seat can also be used to adjust the position of the safety belts.

### Improperly worn safety belts

*Incorrectly positioned safety belts can cause severe injuries.*

Wearing safety belts improperly can cause serious injury or death. Safety belts can only work when they are correctly positioned on the body. Improper seating positions reduce the effectiveness of safety belts and will even increase the risk

of injury and death by moving the safety belt to critical areas of the body. Improper seating positions also increase the risk of serious injury and death when an airbag deploys and strikes an occupant who is not in the correct seating position. A driver is responsible for the safety of all vehicle occupants and especially for children. Therefore:

- ▶ Never permit anyone to assume an incorrect sitting position in the vehicle while traveling ⇒ ⚠.

### ⚠ WARNING

Improperly worn safety belts increase the risk of serious personal injury and death whenever a vehicle is being used.

- Always make sure that all vehicle occupants are correctly restrained and stay in a correct seating position whenever the vehicle is being used.
- Always read and heed all WARNINGS and other important information ⇒ *page 142*.

## Belt tensioners

### How safety belt pretensioners work

*In front, side and rear-end collisions above a particular severity and in a rollover, safety belts are tensioned automatically.*

### Reversible safety belt tensioners

The safety belts on the front seats are equipped with power reversible tensioners. The following functions are available when the driver's/front passenger's safety belts are fastened:

- Automatic tensioners: at the start of a drive, the safety belts automatically adjust to the passenger after a certain time period or vehicle speed.
- In certain driving situations, the safety belts may tighten with a reversible tensioning function ⇒ *page 103*.
- The safety belts may also tighten with this reversible tensioning function in minor collisions.

### Pyrotechnic safety belt pretensioners

The safety belts are equipped with safety belt pretensioners. The system is activated by sensors ►



in front, side and rear-end collisions of great severity and in a rollover. This tightens the belt and takes up belt slack ⇒  *in Service and disposal of safety belt pretensioner on page 147*. Taking up the slack helps to reduce forward occupant movement during a collision.

### WARNING

- It is possible for the pretensioners to deploy incorrectly.
- The pyrotechnic system can only provide protection for one collision. If the pyrotechnic pretensioners deploy, the pretensioning system must be replaced.

### Tips

- The pyrotechnic safety belt pretensioners can only deploy once.
- The safety belt pretensioners do not deploy in minor frontal and side collisions, in rear-end collisions, in rollovers and in collisions involving very little impact force.
  - A fine dust is released when the pyrotechnic safety belt pretensioners deploy. This is normal and is not caused by a fire in the vehicle.
  - The relevant safety requirements must be observed when the vehicle or components of the system are scrapped. A qualified dealership is familiar with these regulations and will be pleased to pass on the information to you.
  - Be sure to observe all safety, environmental and other regulations if the vehicle or individual parts of the system, particularly the safety belt or airbag, are to be disposed. We recommend you have your authorized Audi dealer perform this service for you.

## Service and disposal of safety belt pretensioner

The safety belt pretensioners are parts of the safety belts on your Audi. Installing, removing, servicing or repairing of belt pretensioners can damage the safety belt system and prevent it from working correctly in a collision.

There are some important things you have to know to make sure that the effectiveness of the system will not be impaired and that discarded components do not cause injury or pollute the environment.

### WARNING

- Improper care, servicing and repair procedures can increase the risk of personal injury and death by preventing a safety belt pretensioner from activating when needed or activating it unexpectedly:
- The belt pretensioner system can be activated only once. If belt pretensioners have been activated, the system must be replaced.
  - Never repair, adjust, or change any parts of the safety belt system.
  - Safety belt systems including safety belt pretensioners cannot be repaired. Special procedures are required for removal, installation and disposal of this system.
  - For any work on the safety belt system, we strongly recommend that you see your authorized Audi dealer or qualified technician who has an Audi approved repair manual, training and special equipment necessary.

### For the sake of the environment

Undeployed airbag modules and pretensioners might be classified as Perchlorate Material -special handling may apply, see [www.dtsc.ca.gov/hazardouswaste/perchlorate](http://www.dtsc.ca.gov/hazardouswaste/perchlorate). When the vehicle or parts of the restraint system including airbag modules safety belts with pretensioners are scrapped, all applicable laws and regulations must be observed. Your authorized Audi dealer is familiar with these requirements and we recommend that you have your dealer perform this service for you.



# Airbag system

## Important information

### Importance of wearing safety belts and sitting properly

*Airbags are only supplemental restraints. For airbags to do their job, occupants must always properly wear their safety belts and be in a proper seating position.*

For your safety and the safety of your passengers, before driving off, always:

- ▶ Adjust the driver's seat and steering wheel properly ⇒ *page 131*,
- ▶ Adjust the front passenger's seat properly ⇒ *page 54*,
- ▶ Wear safety belts properly ⇒ *page 142*,
- ▶ Always properly use the proper child restraint to protect children ⇒ *page 172*.

In a collision, airbags must inflate within the blink of an eye and with considerable force. The supplemental airbags can cause injuries if the driver or the front seat passenger is not seated properly. Therefore in order to help the airbag to do its job, it is important, both as a driver and as a passenger to sit properly at all times.

By keeping room between your body and the steering wheel and the front of the passenger compartment, the airbag can inflate fully and completely and provide supplemental protection in certain frontal collisions ⇒ *page 131, Correct passenger seating positions*. For details on the operation of the seat adjustment controls ⇒ *page 54*.

It's especially important that children are properly restrained ⇒ *page 172*.

There is a lot that the driver and the passengers can and must do to help the individual safety features installed in your Audi work together as a system.

Proper seating position is important so that the front airbag on the driver side can do its job. If you have a physical impairment or condition that prevents you from sitting properly on the driver seat with the safety belt properly fastened and

reaching the pedals, or if you have concerns with regard to the function or operation of the Advanced Airbag System, please contact your authorized Audi dealer or qualified workshop, or call Audi Customer Relations at 1-800-822-2834 for possible modifications to your vehicle.

When the airbag system deploys, a gas generator will fill the airbags, break open the padded covers, and inflate between the steering wheel and the driver and between the instrument panel and the front passenger. The airbags will deflate immediately after deployment so that the front occupants can see through the windshield again without interruption.

All of this takes place in the blink of an eye, so fast that many people don't even realize that the airbags have deployed. The airbags also inflate with a great deal of force and nothing should be in their way when they deploy. Front airbags in combination with properly worn safety belts slow down and limit the occupant's forward movement. Together they help to prevent the driver and front seat passenger from hitting parts of the inside of the vehicle while reducing the forces acting on the occupant during the crash. In this way they help to reduce the risk of injury to the head and upper body in the crash. Airbags do not protect the arms or the lower parts of the body.

Both front airbags will not inflate in all frontal collisions. The triggering of the airbag system depends on the vehicle deceleration rate caused by the collision and registered by the electronic control unit. If this rate is below the reference value programmed into the control unit, the airbags will not be triggered, even though the car may be badly damaged as a result of the collision. Vehicle damage, repair costs or even the lack of vehicle damage is not necessarily an indication of whether an airbag should inflate or not.

Since the circumstances will vary considerably between one collision and another, it is not possible to define a range of vehicle speeds that will cover every possible kind and angle of impact that will always trigger the airbags. Important factors include, for example, the nature (hard or soft) of the object which the car hits, the angle of impact, vehicle speed, etc. The front airbags will ►



also not inflate in side or rear collisions, or in roll-overs.

**Always remember:** Airbags will deploy only once, and only in certain kinds of collisions. Your safety belts are always there to offer protection in those situations in which airbags are not supposed to deploy, or when they have already deployed; for example, when your vehicle strikes or is struck by another vehicle after the first collision.

This is just one of the reasons why an airbag is a supplementary restraint and is not a substitute for a safety belt. The airbag system works most effectively when used with the safety belts. Therefore, always properly wear your safety belts ⇒ *page 140*.

### **WARNING**

Sitting too close to the steering wheel or instrument panel will decrease the effectiveness of the airbags and will increase the risk of personal injury in a collision.

- Never sit closer than 10 inches (25 cm) to the steering wheel or instrument panel.
- If you cannot sit more than 10 inches (25 cm) from the steering wheel, investigate whether adaptive equipment may be available to help you reach the pedals and increase your seating distance from the steering wheel.
- All vehicle occupants and especially children must be restrained properly whenever riding in a vehicle. An unrestrained or improperly restrained child could be injured by striking the interior or by being ejected from the vehicle during a sudden maneuver or impact. An unrestrained or improperly restrained child is also at greater risk of injury or death through contact with an inflating airbag.
- If you are unrestrained, leaning forward, sitting sideways or out of position in any way, your risk of injury is much higher.
- You will also receive serious injuries and could even be killed if you are up against the airbag or too close to it when it inflates - even with an Advanced Airbag.

- To reduce the risk of injury when an airbag inflates, always wear safety belts properly ⇒ *page 143, Safety belts*.
- Always make certain that children age 12 or younger always ride in the rear seat. If children are not properly restrained, they may be severely injured or killed when an airbag inflates.
- Never let children ride unrestrained or improperly restrained in the vehicle. Adjust the front seats properly.
- Never ride with the backrest reclined.
- Always sit as far as possible from the steering wheel or the instrument panel ⇒ *page 131*.
- Always sit upright with your back against the backrest of your seat.
- Never place your feet on the instrument panel or on the seat. Always keep both feet on the floor in front of the seat to help prevent serious injuries to the legs and hips if the airbag inflates.
- Never recline the front passenger's seat to transport objects. Items can also move into the area of the side airbag or the front airbag during braking or in a sudden maneuver. Objects near the airbags can become projectiles and cause injury when an airbag inflates.

### **WARNING**

Airbags that have deployed in a crash must be replaced.

- Use only original equipment airbags approved by Audi and installed by a trained technician who has the necessary tools and diagnostic equipment to properly replace any airbag in your vehicle and assure system effectiveness in a crash.
- Never permit salvaged or recycled airbags to be installed in your vehicle.

### **Child restraints on the front seat – some important things to know**

- ▶ Be sure to read the important information and heed the WARNINGS for important details ▶



about children and Advanced Airbags  
⇒ *page 172*.

Even though your vehicle is equipped with an Advanced Airbag System, make certain that all children, especially those 12 years and younger, always ride in the back seat properly restrained for their age and size. The airbag on the passenger side makes the front seat a potentially dangerous place for a child to ride. The front seat is not the safest place for a child in a forward-facing child seat. It can be a very dangerous place for an infant or a child in a rearward-facing seat.

The Advanced Airbag System in your vehicle has been certified to comply with the requirements of United States Federal Motor Vehicle Safety Standard 208 as applicable at the time your vehicle was manufactured.

The Standard requires the front airbag on the passenger side to be turned off (“suppressed”) if a child up to about one year of age restrained in one of the rear-facing or forward-facing infant restraints listed in Federal Motor Vehicle Safety Standard 208 with which the Advanced Airbag System in your vehicle was certified has been installed on the front passenger seat. For a listing of the child restraints that were used to certify compliance with the US Safety Standard  
⇒ *page 174*.

The **PASSENGER AIR BAG OFF** light in the instrument panel tells you when the front Advanced Airbag on the passenger side has been turned off by the electronic control unit.

Each time you switch on the ignition, the **PASSENGER AIR BAG OFF** light will come on for a few seconds and:

- will stay on if the front passenger seat is not occupied,
- will stay on if the electrical capacitance measured by the capacitive passenger detection system for the front passenger seat equals the combined capacitance of an infant up to about one year of age and one of the rearward-facing or forward-facing child restraints listed in Federal Motor Vehicle Safety Standard 208 with which the Advanced Airbag System in your vehicle was certified. For a listing of the child re-

straints that were used to certify your vehicle's compliance with the U.S. Safety Standard  
⇒ *page 174*.

- will stay on if there is a small child or child restraint on the front passenger seat,
- will go off if the front passenger seat is occupied by an adult as registered by the capacitive passenger detection system ⇒ *page 160, Monitoring the Advanced Airbag System*.

The **PASSENGER AIR BAG OFF** light comes on when electrical capacitance registered on the front passenger seat is equal to or less than the combined capacitance of a typical 1 year-old infant and one of the rearward-facing or forward-facing child restraints listed in Federal Motor Vehicle Safety Standard 208 with which the Advanced Airbag System in your vehicle was certified.

If the total electrical capacitance registered on the front passenger seat is more than that of a typical 1 year-old child but less than the weight of a small adult, the front airbag on the passenger side can deploy (the **PASSENGER AIR BAG OFF** light does not come on).

If the **PASSENGER AIR BAG OFF** light does not come on, the front airbag on the passenger side has not been turned off by the electronic control unit and can deploy if the control unit senses an impact that meets the conditions stored in its memory.

**For example, the airbag may deploy if:**

- a small child that is heavier than a typical 1 year-old child is on the front passenger seat (regardless of whether the child is in one of the child seats listed ⇒ *page 174*), or
- a child who has outgrown child restraints is on the front passenger seat.

If the front passenger airbag is turned off, the **PASSENGER AIR BAG OFF** light comes on in the instrument cluster and stays on.

If the front passenger airbag deploys, the Federal Standard requires the airbag to meet the “low risk” deployment criteria to reduce the risk of injury through interaction with the airbag. “Low risk” deployment occurs in those crashes that



take place at lower decelerations as defined in the electronic control unit ⇒ *page 160, PASSENGER AIR BAG OFF light.*

Always remember, a child seat or infant carrier installed on the front seat may be struck and knocked out of position by the rapidly inflating passenger's airbag in a frontal collision. The airbag could greatly reduce the effectiveness of the child restraint and even seriously injure the child during inflation.

For this reason, and because the back seat is the safest place for children - when properly restrained according to their age and size - we strongly recommend that children always sit in the back seat ⇒ *page 172, Child safety.*

### WARNING

A child in a rearward-facing child seat installed on the front passenger seat will be seriously injured and can be killed if the front airbag inflates - even with an Advanced Airbag System.

- The inflating airbag will hit the child seat or infant carrier with great force and will smash the child seat and child against the backrest, center armrest, door or roof.
- Always install rear-facing child seats on the rear seat.
- If you must install a rearward facing child seat on the front passenger seat because of exceptional circumstances and the **PASSENGER AIR BAG OFF** light does not come on and stay on, immediately install the rear-facing child seat in a rear seating position and have the airbag system inspected by your Audi dealer.
- Forward-facing child seats installed on the front passenger's seat may interfere with the deployment of the airbag and cause serious personal injury to the child.

### WARNING

If, in exceptional circumstances, you must install a forward-facing child restraint on the front passenger's seat:

- Always make sure the forward-facing seat has been designed and certified by its man-

ufacturer for use on a front seat with a passenger front and side airbag.

- Never put the forward-facing child restraint up against or very near the instrument panel.
- Always move the passenger seat into its rearmost position in the seat's fore and aft adjustment range, as far away from the airbag as possible before installing the forward-facing child restraint. The backrest must be adjusted to an upright position.
- Make sure that the **PASSENGER AIR BAG OFF** light comes on and stays on all the time whenever the ignition is switched on.

### WARNING

To reduce the risk of serious injury, make sure that the **PASSENGER AIR BAG OFF** light will be displayed whenever a child restraint is installed on the front passenger seat and the ignition is switched on.

- If the **PASSENGER AIR BAG OFF** light does not stay on, perform the checks described ⇒ *page 160, Monitoring the Advanced Airbag System.*
- Take the child restraint off the front passenger seat and install it properly at one of the rear seat positions if the **PASSENGER AIR BAG OFF** light does not stay on.
- Have the airbag system inspected by your Audi dealer immediately.
- Always carefully follow instructions from child restraint manufacturers when installing child restraints.

### WARNING

If, in exceptional circumstances, you must install a forward or rearward-facing child restraint on the front passenger's seat:

- Improper installation of child restraints can reduce their effectiveness or even prevent them from providing any protection.
- An improperly installed child restraint can interfere with the airbag as it deploys and seriously injure or even kill the child - even with an Advanced Airbag System.



- Always carefully follow the manufacturer's instructions provided with the child seat or carrier.
- Always make sure that there is nothing on the front passenger seat that will cause the capacitive passenger detection system in the seat to signal to the Airbag System that the seat is occupied by a person when it is not, or to signal that it is occupied by someone who is heavier than the person actually sitting on the seat. The presence of additional objects could cause the passenger front airbag to be turned on when it should be off, or could cause the airbag to work in a way that is different from the way it would have worked without the object on the seat.

## Front airbags

### Description of front airbags

*The airbag system can provide supplemental protection to properly restrained front seat occupants.*



**Fig. 128** Location of driver airbag: in steering wheel



**Fig. 129** Location of front passenger's airbag: in the instrument panel

Your vehicle is equipped with an “Advanced Airbag System” in compliance with United States

Federal Motor Vehicle Safety Standard (FMVSS) 208 as applicable at the time your vehicle was manufactured. The safety belts for the seats have “pretensioners” that help to take slack out of the belt system. The pretensioners are also activated by the electronic control unit for the airbag system.

The front safety belts also have load limiters to help reduce the forces applied to the body in a crash.

The airbag for the driver is in the steering wheel hub ⇒ *fig. 128* and the airbag for the front passenger is in the instrument panel ⇒ *fig. 129*. The general location of the airbags is marked “AIR-BAG”.

There is a lot you need to know about the airbags in your vehicle. We urge you to read the detailed information about airbags, safety belts and child safety in this and the other chapters that make up the owner's literature. Please be sure to heed the WARNINGS - they are extremely important for your safety and the safety of your passengers, especially infants and small children.

### **WARNING**

- Never rely on airbags alone for protection.
- Even when they deploy, airbags provide only supplemental protection.
- Airbags work most effectively when used with properly worn safety belts.
- Therefore, always wear your safety belts and make sure that everybody in your vehicle is properly restrained.
- Always hold the steering wheel with both hands on the outside of the steering wheel rim at the 9:00 o'clock and 3:00 o'clock positions to help reduce the risk of personal injury if the driver's airbag inflates.
- Never hold the steering wheel at the 12 o'clock position or with your hands anywhere inside the steering wheel or on the steering wheel hub. Holding the steering wheel the wrong way increases the risk of severe injury to the arms, hands, and head if the driver airbag deploys.



**! WARNING**

Objects between you and the airbag will increase the risk of injury in a crash by interfering with the way the airbag unfolds and/or by being pushed into you as the airbag inflates.

- Always make sure nothing is in the front airbag deployment zone that could be struck by the airbag when it inflates.
- Objects in the zone of a deploying airbag can become projectiles when the airbag deploys and cause serious personal injury.
- Never hold things in your hands or on your lap when the vehicle is in use.
- Never place accessories or other objects (such as cup holders, telephone brackets, note pads, navigation systems, or things that are large, heavy, or bulky) on the doors; never attach them to the doors or the windshield; never place them over or near or attach them to the area marked „AIRBAG“ on the steering wheel, instrument panel or the seat backrests; never place them between these areas and you or any other person in the vehicle.
- Never attach objects to the windshield above the passenger front airbag, such as accessory GPS navigation units or music players. Such objects could cause serious injury in a collision, especially when the airbags inflate.
- Never recline the front passenger seat to transport objects. Items can also move into the deployment area of the side airbags or the front airbag during braking or in a sudden maneuver. Objects near the airbags can fly dangerously through the passenger compartment and cause injury, particularly when the seat is reclined and the airbags inflate.

**! WARNING**

A person on the front passenger seat, especially infants and small children, will receive serious injuries and can even be killed by being too close to the airbag when it inflates.

- Although the Advanced Airbag System in your vehicle is designed to turn off the front

passenger airbag if an infant or a small child is on the front passenger seat, nobody can absolutely guarantee that deployment under these special conditions is impossible in all conceivable situations that may happen during the useful life of your vehicle.

- The Advanced Airbag System can deploy in accordance with the „low risk“ option for 3- and 6-year-old children under the U.S. Federal Standard if a child with electrical capacitance greater than the combined capacitance of a typical one-year old infant restrained in one of the forward facing or rearward-facing child seats with which your vehicle was certified is on the front passenger seat and the other conditions for airbag deployment are met.
- Accident statistics have shown that children are generally safer in the rear seat area than in the front seating position.
- For their own safety, all children, especially 12 years and younger, should always ride in the back properly restrained for their age and size.

**Advanced front airbag system**

Your vehicle is equipped with a front Advanced Airbag System in compliance with United States Federal Motor Vehicle Safety Standard 208 as applicable at the time your vehicle was manufactured.

The front Advanced Airbag System supplements the safety belts to provide additional protection for the driver's and front passenger's heads and upper bodies in frontal crashes. The airbags inflate only in frontal impacts when the vehicle deceleration is high enough.

The front Advanced Airbag System for the front seat occupants is not a substitute for your safety belts. Rather, it is part of the overall occupant restraint system in your vehicle. Always remember that the airbag system can only help to protect you, if you are sitting upright, wearing your safety belt and wearing it properly. This is why you ►



and your passengers must always be properly restrained, not just because the law requires you to be.

The Advanced Airbag System in your vehicle has been certified to meet the “low risk” requirements for 3 and 6 year-old children on the passenger side and very small adults on the driver side. The low risk deployment criteria are intended to help reduce the risk of injury through interaction with the front airbag that can occur, for example, by being too close to the steering wheel and instrument panel when the airbag inflates.

In addition, the system has been certified to comply with the “suppression” requirements of the Safety Standard, to turn off the front airbag for infants 12 months old and younger who are restrained on the front passenger seat in child restraints that are listed in the Standard ⇒ *page 174, Child restraints and Advanced front airbag system.*

“Suppression” requires the front airbag on the passenger side to be turned off if:

- a child up to about one year of age is restrained on the front passenger seat in one of the rear-facing or forward-facing infant restraints listed in Federal Motor Vehicle Safety Standard 208 with which the Advanced Airbag System in your vehicle was certified. For a listing of the child restraints that were used to certify your vehicle's compliance with the US Safety Standard ⇒ *page 174,*
- When a person is detected on the front passenger seat that has an electrical capacitance that is more than the total electrical capacitance of a child that is about 1 year old restrained in one of the rear-facing or forward-facing infant restraints (listed in Federal Motor Vehicle Safety Standard 208 with which the Advanced Airbag System in your vehicle was certified), the front airbag on the passenger side may or may not deploy.

The **PASSENGER AIR BAG OFF** light comes on when the electronic control unit detects a total electrical capacitance on the front passenger seat that requires the front airbag to be turned off. If the **PASSENGER AIR BAG OFF** light does not

come on, the front airbag on the passenger side has not been turned off by the control unit and can deploy if the control unit senses an impact that meets the conditions stored in its memory.

If the total electrical capacitance registered on the front passenger seat is more than that of a typical 1 year-old, but less than the weight of a small adult, the front airbag on the passenger side may deploy (the **PASSENGER AIR BAG OFF** light does not come on).

**For example, the airbag may deploy if:**

- a small child that is heavier than a typical 1 year-old child is on the front passenger seat (regardless of whether the child is in one of the child seats listed ⇒ *page 174*),
- a child who has outgrown child restraints is on the front passenger seat.

If the front passenger airbag is turned off, the **PASSENGER AIR BAG OFF** light in the center of the instrument panel will come on and stay on.

If the front passenger airbag deploys, the Federal Standard requires the airbag to meet the “low risk” deployment criteria to help reduce the risk of injury through interaction with the airbag. “Low risk” deployment occurs in those crashes that take place at lower decelerations as defined in the electronic control unit ⇒ *page 160.*

**Always remember:** Even though your vehicle is equipped with Advanced Airbags, the safest place for children is properly restrained on the back seat. Please be sure to read the important information in the sections that follow and be sure to heed all of the WARNINGS.



### WARNING

To reduce the risk of injury when an airbag inflates, always wear safety belts properly.

- If you are unrestrained, leaning forward, sitting sideways or out of position in any way, your risk of injury is much higher.
- You will also receive serious injuries and could even be killed if you are up against the airbag or too close to it when it inflates - even with an Advanced Airbag ⇒ *page 148.*



**! WARNING**

A child in a rearward-facing child seat installed on the front passenger seat will be seriously injured and can be killed if the front airbag inflates - even with an Advanced Airbag System.

- Although the Advanced Airbag System in your vehicle is designed to turn off the front airbag when a rearward-facing child restraint has been installed on the front passenger seat, nobody can absolutely guarantee that deployment is impossible in all conceivable situations that may happen during the useful life of your vehicle.
- The inflating airbag will hit the child seat or infant carrier with great force and will smash the child seat and child against the backrest, center armrest, door, or roof.
- Always install rearward-facing child restraints on the rear seat.
- If you must install a rearward facing child seat on the front passenger seat because of exceptional circumstances and the **PASSENGER AIR BAG OFF** light does not come on and stay on, immediately install the rear-facing child seat in a rear seating position and have the airbag system inspected by your Audi dealer.

**! WARNING**

If, in exceptional circumstances, you must install a forward-facing child restraint on the front passenger's seat:

- Always make sure the forward-facing seat has been designed and certified by its manufacturer for use on a front seat with a passenger front and side airbag.
- Never put the forward-facing child restraint up against or very near the instrument panel.
- Always move the passenger seat into its rearmost position in the seat's fore and aft adjustment range, as far away from the airbag as possible, before installing the forward-facing child restraint. The backrest must be adjusted to an upright position.

- Always make sure that there is nothing on the front passenger seat that will cause the capacitive passenger detection system in the seat to signal to the Airbag System that the seat is occupied by a person when it is not, or to signal that it is occupied by someone who is heavier than the person actually sitting on the seat. The presence of additional objects could cause the passenger front airbag to be turned on when it should be off, or could cause the airbag to work in a way that is different from the way it would have worked without the object on the seat.
- Make sure that the **PASSENGER AIR BAG OFF** light comes on and stays on all the time whenever the ignition is switched on.

**Advanced Airbag System components**

The front passenger seat in your vehicle has a lot of very important parts of the Advanced Airbag System in it. These parts include the capacitive passenger detection system, wiring, brackets, and more. The control unit monitors the system on the front passenger seat when the ignition is switched on and turns the airbag indicator light on when a malfunction in the one of the system components is detected ⇒ *page 160*. Because the front passenger seat contains important parts of the Advanced Airbag System, you must take care to prevent it from being damaged. Damage to the seat may prevent the Advanced Airbag System for the front passenger seat from doing its job in a crash.

**The front Advanced Airbag System consists of the following:**

- Crash sensors in the front of the vehicle that measure vehicle acceleration/deceleration to provide information to the Advanced Airbag System about the severity of the crash.
- An electronic control unit, with integrated crash sensors for front and side impacts. The control unit “decides” whether to fire the front airbags based on the information received from the crash sensors. The control unit also “decides” whether the safety belt pretensioners should be activated.



## Airbag system

- An Advanced Airbag with gas generator for the driver inside the steering wheel hub.
- An Advanced Airbag with gas generator inside the instrument panel for the front passenger.
- A capacitive passenger detection system underneath the front passenger seat cover. This system measures the electrical capacitance of the person in the seat. The information registered is sent continuously to the electronic control unit to regulate deployment of the front Advanced Airbag on the passenger side.
- An airbag monitoring system and indicator light in the instrument cluster ⇒ *page 160*.
- A sensor in each front seat registers the distance between the respective seat and the steering wheel or instrument panel. The information registered is sent continuously to the electronic control unit to regulate deployment of the front Advanced Airbags.
- The **PASSENGER AIR BAG OFF** light comes on and stays on in the center of the instrument panel ⇒ *page 198* and tells you when the front Advanced Airbag on the passenger side has been turned off.
- A sensor in the safety belt latch for the driver and for the front seat passenger that senses whether that safety belt is latched or not and transmits this information to the electronic control unit.

### **WARNING**

Damage to the front passenger seat can prevent the front airbag from working properly.

- Improper repair or disassembly of the front passenger and driver seat will prevent the Advanced Airbag System from functioning properly.
- Repairs to the front passenger seat must be performed by qualified and properly trained workshop personnel.
- Never remove the front passenger or driver seat from the vehicle.
- Never remove the upholstery from the front passenger seat.
- Never disassemble or remove parts from the seat or disconnect wires from it.

- Never carry sharp objects in your pockets or put them on the seat. The capacitive passenger detection mat in the front passenger seat will not function properly if it is punctured.
- Never carry things on your lap or carry objects on the front passenger seat. Such objects can influence the capacitance registered by the capacitive passenger detection system, so that incorrect information is provided to the airbag control unit.
- Never store items under the front passenger seat. Parts of the Advanced Airbag System under the passenger seat could be damaged, preventing them and the airbag system from working properly.
- Never place seat covers or replacement upholstery that have not been specifically approved by Audi on the front seats.
- Seat covers can prevent the Advanced Airbag System from recognizing child restraints or occupants on the front passenger seat and prevent the side airbag in the seat backrest from deploying properly.
- If a seat heater has been retrofitted or otherwise added to the front passenger seat, never install any child restraint system on this seat.
- Never use cushions, pillows, blankets, or similar items on the front passenger seat. The additional layers prevent the capacitive passenger detection system from accurately measuring the capacitance of the child safety seat and/or the person on the seat and thus keep the Advanced Airbag System from working properly.
- Never place or use any electrical device (such as a laptop, CD player, electronic games device, power inverter or seat heater for child seats) on the front passenger seat if the device is connected to the 12-volt socket or the cigarette lighter socket. Such devices can influence the capacitance registered by the capacitive passenger detection system, so that incorrect information is provided to the airbag control unit.



- If you must use a child restraint on the front passenger seat and the child restraint manufacturer's instructions require the use of a towel, foam cushion or something else to properly position the child restraint, make certain that the **PASSENGER AIR BAG OFF** light comes on and stays on whenever the child restraint is installed on the front passenger seat.
- If the **PASSENGER AIR BAG OFF** light does not come on and stay on, immediately install child restraint in a rear seating position and have the airbag system inspected by your Audi dealer.

### WARNING

If the front passenger seat gets wet, dry it immediately.

- If liquid soaks into the front passenger seat, this can keep the airbag system from working properly and may, for instance, deactivate the passenger frontal airbag. If this happens, the **PASSENGER AIR BAG OFF** light will come on and stay on together with the airbag indicator light  in the instrument cluster.
- If liquid is pooled on the seat, but has not soaked in, this may also keep the airbag system from working properly and cause the passenger frontal airbag to be enabled (turned on), even though there is a properly installed child restraint system on the seat. Wet towels or other wet things on the seat cushion can have the same effect. If the front passenger frontal airbag is turned on, the **PASSENGER AIR BAG OFF** light will go out.

### How the Advanced Airbag System components work together

The front Advanced Airbag System and the side airbags supplement the protection offered by the front three-point safety belts with pretensioners and load limiters and the adjustable head restraints\* to help reduce the risk of injury in a wide range of accident and crash situations. Be

sure to read the important information about safety and heed the WARNINGS in this chapter.

Deployment of the Advanced Airbag System and the activation of the safety belt pretensioners depend on the deceleration measured by the crash sensors and registered by the electronic control unit. Crash severity depends on speed and deceleration as well as the mass and stiffness of the vehicle or object involved in the crash.

On the passenger side, regardless of safety belt use, the front passenger frontal airbag will be turned off if the electrical capacitance measured by the capacitive passenger detection system on the front passenger seat is less than the amount programmed in the electronic control unit. The front passenger frontal airbag will also be turned off if the capacitance measured by the system for the front passenger seat equals that of an infant of about one year of age in one of the child seats that was used to certify the Advanced Airbag System under Federal Motor Vehicle Safety Standard 208. The **PASSENGER AIR BAG OFF** light comes on and stays on to tell you when the front Advanced Airbag System on the passenger side has been turned off ⇒ *page 160*.

### WARNING

To reduce the risk of injury when an airbag inflates, always wear safety belts properly.

- If you are unrestrained, leaning forward, sitting sideways or out of position in any way, your risk of injury is much higher.
- You will also receive serious injuries and could even be killed if you are up against the airbag or too close to it when it inflates - even with an Advanced Airbag ⇒ *page 148*.



### More important things to know about front airbags



Fig. 130 Inflated front airbags

Safety belts are important to help keep front seat occupants in the proper seated position so that airbags can unfold properly and provide supplemental protection in a frontal collision.

The front airbags are designed to provide additional protection for the chest and face of the driver and the front seat passenger when:

- safety belts are worn properly,
- the seats have been positioned so that the occupant is properly seated as far as possible from the airbag,
- and for adjustable head restraints: the head restraints have been properly adjusted.

Because airbags inflate in the blink of an eye with great force, things you have on your lap or have placed on the seat could become dangerous projectiles, and be pushed into you if the airbag inflates.

When an airbag deploys, fine dust is released. This is normal and is not caused by a fire in the vehicle. This dust is made up mostly of a powder used to lubricate the airbags as they deploy. It could irritate skin.

It is important to remember that while the supplemental airbag system is designed to reduce the likelihood of serious injuries, other injuries, for example swelling, bruising and minor abrasions, can also happen when airbags inflate. Airbags do not protect the arms or the lower parts of the body. Front airbags supplement the three-point safety belts only in some frontal collisions

in which the vehicle deceleration is high enough to deploy the airbags.

#### Front airbags will not deploy:

- if the ignition is switched off when a crash occurs,
- in side collisions,
- in rear-end collisions,
- in rollovers,
- when the crash deceleration measured by the airbag system is less than the minimum threshold needed for airbag deployment as registered by the electronic control unit.

#### The front passenger airbag also will not deploy:

- when the front passenger seat is not occupied,
- when the electrical capacitance measured by the capacitive passenger detection system for the front passenger seat indicates that the passenger side frontal airbag must be switched off by the electronic control unit (the **PASSENGER AIR BAG OFF** light ⇒ *page 160* and how they work comes on and stays on).

#### **WARNING**

Sitting in the wrong position can increase the risk of serious injury in crashes.

- To reduce the risk of injury when the airbags inflate, the driver and passengers must always sit in an upright position, must not lean against or place any part of their body too close to the area where the airbags are located.
- Occupants who are unbelted, out of position or too close to the airbag can be seriously injured by an airbag as it unfolds with great force in the blink of an eye ⇒ *page 149*.

#### **WARNING**

A child in a rearward-facing child seat installed on the front passenger seat will be seriously injured and can be killed if the front airbag inflates - even with an Advanced Airbag System.

- The inflating airbag will hit the child seat or infant carrier with great force and will



smash the child seat and child against the backrest, center armrest, door or roof.

- Always install rear-facing child seats on the rear seat.
- If you must install a rearward facing child seat on the front passenger seat because of exceptional circumstances and the **PASSENGER AIR BAG OFF** light does not come on and stay on, immediately install the rear-facing child seat in a rear seating position and have the airbag system inspected by your Audi dealer.

### **WARNING**

Objects between you and the airbag will increase the risk of injury in a crash by interfering with the way the airbag unfolds or by being pushed into you as the airbag inflates.

- Never hold things in your hands or on your lap when the vehicle is in use.
- Never transport items on or in the area of the front passenger seat. Objects could move into the area of the front airbags during braking or other sudden maneuvers and become dangerous projectiles that can cause serious personal injury if the airbags inflate.
- Never place or attach accessories or other objects (such as cup holders, telephone brackets, large, heavy or bulky objects) on the doors, over or near the area marked “AIRBAG” on the steering wheel, instrument panel, seat backrests or between those areas and yourself. These objects could cause injury in a crash, especially when the airbags inflate.
- Never recline the front passenger's seat to transport objects. Items can also move into the area of the side airbag or the front airbag during braking or in a sudden maneuver. Objects near the airbags can become projectiles and cause injury, particularly when the seat is reclined.
- Never place or transport objects on the front passenger seat. Objects on the front passenger seat could cause the capacitive sensor in the seat to signal to airbag system

that the seat is occupied by a person when it in fact is not, or that the person on the seat is heavier than he or she actually is. The change in electric capacitance because of such objects can cause the passenger front airbag to be turned on when it should be off, or can cause the airbag to work in a way that is different from the way it would have worked without objects on the seat.

- Always make sure that there is nothing on the front passenger seat that will cause the capacitive passenger detection system in the seat to signal to the Airbag System that the seat is occupied by a person when it is not, or to signal that it is occupied by someone who is heavier than the person actually sitting on the seat. The presence of an object could cause the passenger front airbag to be turned on when it should be off, or could cause the airbag to work in a way that is different from the way it would have worked without the object on the seat.

### **WARNING**

The fine dust created when airbags deploy can cause breathing problems for people with a history of asthma or other breathing conditions.

- To reduce the risk of breathing problems, those with asthma or other respiratory conditions should get fresh air right away by getting out of the vehicle or opening windows or doors.
- If you are in a collision in which airbags deploy, wash your hands and face with mild soap and water before eating.
- Be careful not to get the dust into your eyes, or into any cuts or scratches.
- If the residue should get into your eyes, flush them with water.



## Monitoring the Advanced Airbag System

### **AIR BAG** Airbag monitoring indicator light

Two separate indicators monitor the function of the Advanced Airbag System: the airbag monitoring indicator light and the **PASSENGER AIR BAG OFF** light.

The Advanced Airbag System as well as the side airbags and side curtain airbags with ejection mitigation features (including the electronic control unit, sensors and system wiring) are all monitored continuously to make sure that they are functioning properly whenever the ignition is on. Every time you turn on the ignition, the airbag system indicator light **AIR BAG** will come on for a few seconds (function check).

### The system must be inspected when the indicator light **AIR BAG**:

- does not come on when the ignition is switched on,
- does not go out a few seconds after you have switched on the ignition, or
- comes on while driving.

If an airbag system malfunction is detected, the indicator light will first start flashing to catch the driver's attention and then stay on continuously to serve as a constant reminder to have the system inspected immediately.

If a malfunction occurs that turns the front airbag on the passenger side off, the **PASSENGER AIR BAG OFF** light will come on and stay on whenever the ignition is on.

### **!** WARNING

An airbag system that is not functioning properly cannot provide supplemental protection in a frontal crash.

- If the airbag indicator light ⇨ *page 20* comes when the vehicle is being used, have the system inspected immediately by your authorized Audi dealer. It is possible that the airbag will inflate when it is not supposed to, or will not inflate when it should.

### **PASSENGER AIR BAG OFF** light



Fig. 131 Center console: passenger airbag off warning light

The **PASSENGER AIR BAG OFF** light is located in the center of the instrument panel ⇨ *fig. 131*.

The **PASSENGER AIR BAG OFF** light will come on and stay on to tell you when the front Advanced Airbag on the passenger side has been turned off by the electronic control unit. If the bulb for the **PASSENGER AIR BAG OFF** light burns out, the airbag indicator light **AIR BAG** will come on to signal a malfunction in the Advanced Airbag System. Although the burned-out bulb will not change the way the front passenger's frontal airbag works, it will no longer be possible to use the **PASSENGER AIR BAG OFF** light to make sure that the airbag on/off status is correct for the occupant on the front passenger seat. Have the airbag system inspected immediately by your authorized Audi dealer.

### The **PASSENGER AIR BAG OFF** light will blink for about 5 seconds when:

- the ignition is switched on and
- the capacitive passenger detection system, which switches the front seat passenger's frontal Advanced Airbag on and off, detects a change in the status of the front passenger seat.

As soon as the **PASSENGER AIR BAG OFF** light stops blinking, always make sure that the airbag status (on or off) as shown by the **PASSENGER AIR BAG OFF** light is proper for the age, size and electrical capacitance of the person occupying the front passenger seat. Always make sure that the safety belt for the front passenger seat is properly fastened.



The **PASSENGER AIR BAG OFF** light will show the status of the front seat passenger's frontal Advanced Airbag a few seconds after the ignition is switched on and the airbag indicator light goes off. The **PASSENGER AIR BAG OFF** light:

- will stay on if the front passenger seat is not occupied;
- will stay on if the electrical capacitance measured by the capacitive passenger detection system for the front passenger seat equals the combined capacitance of an infant up to about one year of age and one of the rearward-facing or forward-facing child restraints listed in Federal Motor Vehicle Safety Standard 208 with which the Advanced Airbag System in your vehicle was certified; For a listing of the child restraints that were used to certify your vehicle's compliance with the U.S. Safety Standard ⇒ *page 174*.
- will go out if the front passenger seat is occupied by an adult as registered by the capacitive passenger detection system.
- The **PASSENGER AIR BAG OFF** light must come on and stay on if the ignition is on and...
  - a car bed has been installed on the front passenger seat, or
  - a rearward-facing child restraint has been installed on the front passenger seat, or
  - a forward-facing child restraint has been installed on the front passenger seat,
  - and if the electrical capacitance registered on the front passenger seat is equal to or less than the combined capacitance of a typical 1 year-old infant and one of the rearward-facing or forward-facing child restraints listed in Federal Motor Vehicle Safety Standard 208 with which the Advanced Airbag System in your vehicle was certified.

If the front passenger seat is not occupied, the front airbag will not deploy, and the **PASSENGER AIR BAG OFF** light will stay on. Never install a rearward-facing child restraint on the front passenger seat, the safest place for a child in any kind of child restraint is at one of the seating positions on the rear seat ⇒ *page 149, Child re-*

*straints on the front seat – some important things to know and ⇒ page 172, Child safety.*

### If the **PASSENGER AIR BAG** light comes on ...

If the **PASSENGER AIR BAG OFF** light comes on when one of the conditions listed above is met, be sure to check the light regularly to make certain that the **PASSENGER AIR BAG OFF** light stays on continuously whenever the ignition is on. If the **PASSENGER AIR BAG OFF** light does not appear on and does not stay on all the time, stop as soon as it is safe to do so and

- reactivate the system by turning the ignition off for more than 4 seconds and then turning it on again;
- remove and reinstall the child restraint. Make sure that the child restraint is properly installed and that the safety belt for the front passenger seat has been correctly routed through the child restraint as described in the child restraint manufacturer's instructions;
- make sure that the convertible locking retractor on the safety belt for the front passenger seat has been activated and that the safety belt has been pulled tight.
- make sure that no electrical device (such as a laptop, CD player, electronic games device, power inverter or seat heater for child seats) is placed or used on the front passenger seat if the device is connected to the 12-volt socket or the cigarette lighter socket;
- make sure that no seat heater has been retrofitted or otherwise added to the front passenger seat;
- make sure that nothing can interfere with the safety belt buckles and that they are not obstructed;
- make sure that there are no wet objects (such as a wet towel) and no water or other liquids on the front passenger seat cushion.

### If the **PASSENGER AIR BAG** light still does not come on ...

If the **PASSENGER AIR BAG OFF** light still does not come on and does not stay on continuously (when the ignition is switched on),



## Airbag system

- take the child restraint off the front passenger seat and install it properly at one of the rear seat positions. Have the airbag system inspected by your Audi dealer immediately.
- move the child to a rear seat position and make sure that the child is properly restrained in a child restraint that is appropriate for its size and age.

### The **PASSENGER AIR BAG** light should **NOT** come on ...

The **PASSENGER AIR BAG OFF** light should NOT come on when the ignition is on and an adult is sitting in a proper seating position on the front passenger seat. If the **PASSENGER AIR BAG OFF** light comes on and stays on or flashes for about 5 seconds while driving, under these circumstances, make sure that:

- the adult on the front passenger seat is properly seated on the center of the seat cushion with his or her back up against the backrest and the backrest is not reclined,
- the adult is not taking weight off the seat by holding on to the passenger assist handle above the front passenger door or supporting their weight on the armrest,
- the safety belt is being properly worn and that there is not a lot of slack in the safety belt webbing,
- there are no aftermarket seat covers or cushions or other things (such as blankets) on the front passenger seat that might cause the capacitive passenger detection system to miscalculate electrical capacitance.

### Important safety instructions on monitoring the Advanced Airbag System

#### **WARNING**

- If the status of the Advanced Airbag System has changed while the vehicle is moving, the **PASSENGER AIR BAG OFF** light blinks for about 5 seconds to catch the driver's attention. If this happens, always stop as soon as it is safe to do so and check the steps described above.

- If the **PASSENGER AIR BAG OFF** light does not go off when an adult who is not very small is sitting on the front passenger seat after taking the steps described above, make sure the adult is properly seated and restrained at one of the rear seating positions. Have the airbag system inspected by your authorized Audi dealer before transporting anyone on the front passenger seat.

#### **WARNING**

An airbag system that is not functioning properly cannot provide supplemental protection in a frontal crash.

- If the airbag indicator light ⇒ *page 20* comes when the vehicle is being used, have the system inspected immediately by your authorized Audi dealer. It is possible that the airbag will inflate when it is not supposed to, or will not inflate when it should.

#### **WARNING**

If the front airbag inflates, a child without a child restraint, or in a rearward-facing child safety seat, or in a forward-facing child restraint that has not been properly installed will be seriously injured and can be killed.

- Even though your vehicle is equipped with an Advanced Airbag System, make certain that all children, especially 12 years and younger, always ride on the back seat properly restrained for their age and size.
- Always install forward or rear-facing child seats on the rear seat – even with an Advanced Airbag System.
- If you must install a rearward-facing child seat on the front passenger seat because of exceptional circumstances and the **PASSENGER AIR BAG OFF** light does not appear and stay on, immediately install the rear-facing child seat in a rear seating position and have the airbag system inspected by your Audi dealer.
- If, in exceptional circumstances, you must install a forward-facing child restraint on the front passenger seat, always move the



seat into its rearmost position in the seat's fore and aft adjustment range, as far away from the airbag as possible. The backrest must be adjusted to an upright position. Make sure that the **PASSENGER AIR BAG OFF** light comes on and stays on all the time whenever the ignition is switched on.

### WARNING

- If the **PASSENGER AIR BAG OFF** light does not go out when an adult is sitting on the front passenger seat after taking the steps described above, make sure the adult is properly seated and restrained at one of the rear seating positions.
- Have the airbag system inspected by your Audi dealer before transporting anyone on the front passenger seat.

### Tips

If the capacitive passenger detection system determines that the front passenger seat is empty, the frontal airbag on the passenger side will be turned off, and the **PASSENGER AIR BAG OFF** light will stay on.

## Repair, care and disposal of the airbags

Parts of the airbag system are installed at many different places on your Audi. Installing, removing, servicing or repairing a part in an area of the vehicle can damage a part of an airbag system and prevent that system from working properly in a collision.

There are some important things you have to know to make sure that the effectiveness of the system will not be impaired and that discarded components do not cause injury or pollute the environment.

### WARNING

Improper care, servicing and repair procedures can increase the risk of personal injury and death by preventing an airbag from deploying when needed or deploying an airbag unexpectedly:

- Never cover, obstruct, or change the steering wheel horn pad or airbag cover or the instrument panel or modify them in any way.
- Never attach any objects such as cup holders or telephone mountings to the surfaces covering the airbag units.
- For cleaning the horn pad or instrument panel, use only a soft, dry cloth or one moistened with plain water. Solvents or cleaners could damage the airbag cover or change the stiffness or strength of the material so that the airbag cannot deploy and protect properly.
- Never repair, adjust, or change any parts of the airbag system.
- All work on the steering wheel, instrument panel, front seats or electrical system (including the installation of audio equipment, cellular telephones and CB radios, etc.) must be performed by a qualified technician who has the training and special equipment necessary.
- For any work on the airbag system, we strongly recommend that you see your authorized Audi dealer or qualified workshop.
- Never modify the front bumper or parts of the vehicle body.
- Always make sure that the side airbag can inflate without interference:
  - Never install seat covers or replacement upholstery over the front seatbacks that have not been specifically approved by Audi.
  - Never use additional seat cushions that cover the areas where the side airbags inflate.
  - Damage to the original seat covers or to the seam in the area of the side airbag module must always be repaired immediately by an authorized Audi dealer.
- The airbag system can deploy only once. After an airbag has been deployed, it must be replaced with new replacement parts designed and approved especially for your Audi model version. Replacement of complete airbag systems or airbag components must be performed by qualified workshops only. Make sure that any airbag service action is



entered in your Audi Warranty & Maintenance booklet under *AIRBAG REPLACEMENT RECORD*.

- For safety reasons in severe accidents, the alternator and starter are separated from the vehicle battery with a pyrotechnic circuit interrupter.
- Work on the pyrotechnic circuit interrupter must only be performed by a qualified technicians who have the experience, information and special tools necessary to perform the work safely.
- If the vehicle or the circuit interrupter is scrapped, all applicable safety precautions must be followed.



### For the sake of the environment

Undeployed airbag modules and pretensioners might be classified as Perchlorate Material - special handling may apply, see [www.dtsc.ca.gov/hazardouswaste/perchlorate](http://www.dtsc.ca.gov/hazardouswaste/perchlorate). When the vehicle or parts of the restraint system including airbag modules and safety belts with pretensioners are scrapped, all applicable laws and regulations must be observed. Your authorized Audi dealer is familiar with these requirements and we recommend that you have your dealer perform this service for you.

### Other things that can affect Advanced Airbag performance

Changing the vehicle's suspension system can change the way that the Advanced Airbag System performs in a crash. For example, using tire-rim combinations not approved by Audi, lowering the vehicle, changing the stiffness of the suspension, including the springs, suspension struts, shock absorbers etc. can change the forces that are measured by the airbag sensors and sent to the electronic control unit. Some suspension changes can, for example, increase the force levels measured by the sensors and make the airbag system deploy in crashes in which it would not deploy if the changes had not been made. Other kinds of changes may reduce the force levels measured by

the sensors and prevent the airbag from deploying when it should.



### WARNING

Changing the vehicle's suspension including use of unapproved tire-rim combinations can change Advanced Airbag performance and increase the risk of serious personal injury in a crash.

- Never install suspension components that do not have the same performance characteristics as the components originally installed on your vehicle.
- Never use tire-rim combinations that have not been approved by Audi.

## Knee airbags

### Description of knee airbags

Applies to vehicles: with knee airbags

*The knee airbag system can provide supplemental protection to properly restrained front seat occupants.*

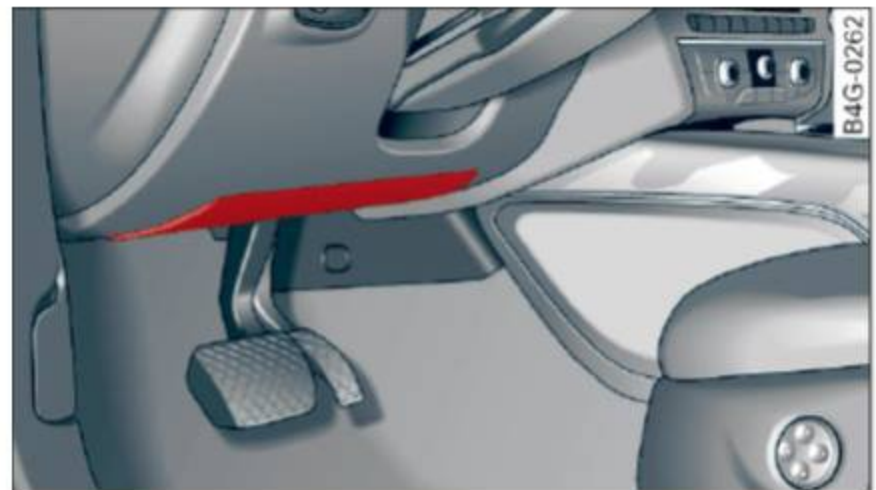

Fig. 132 Driver's knee airbag

The driver knee airbag is in the instrument panel underneath the steering wheel ⇒ *fig. 132*, the airbag for the passenger is at about the same height in the instrument panel underneath the glove compartment.

The knee airbag offers additional protection to the driver's and passenger's knees and upper and lower thigh areas and supplements the protection provided by the safety belts.

If the front airbags deploy, the knee airbags also deploy in frontal collisions when the deployment threshold stored in the control unit is met



⇒ page 158, *More important things to know about front airbags.*

In addition to their normal safety function, safety belts help keep the driver or front passenger in position in a frontal collision so that the airbags can provide supplemental protection.

The airbag system is not a substitute for your safety belt. Rather, it is part of the overall occupant restraint system in your vehicle. Always remember that the airbag system can only help to protect you if you are wearing your safety belt and wearing it properly. This is why you should always wear your safety belt, not just because the law requires you to do so ⇒ page 140, *General notes.*

Remember too, airbags will deploy only once and only in certain kinds of accidents - your safety belts are always there to offer protection in those accidents in which airbags are not supposed to deploy or when they have already deployed, for example when your vehicle strikes or is struck by another after the first collision.

This is just one of the reasons why an airbag is not a substitute for the safety belt. The airbag system works most effectively when used with the safety belts. Therefore, always wear your safety belts correctly.

It is important to remember that while the supplemental knee airbag system is designed to reduce the likelihood of serious injuries, other injuries, for example, swelling, bruising and minor abrasions and friction burns can also occur when an airbag inflates.

#### **The knee airbag system basically consists of:**

- The electronic control module
- Two inflatable airbags (airbag and gas generator), one for the driver and one for the front passenger
- The airbag indicator light in the instrument panel

#### **The knee airbag system will not deploy:**

- when the ignition is switched off
- in frontal collisions when the deceleration measured by the control unit is too low

- in side collisions
- in rear-end collisions
- in rollovers
- in the event of a system malfunction (warning/indicator light is on) ⇒ page 20.

#### **! WARNING**

- Safety belts and the airbag system can only provide protection when occupants are in the proper seating position ⇒ page 158.
- If the airbag indicator light ⇒ page 20 comes when the vehicle is being used, have the system inspected immediately by your authorized Audi dealer. It is possible that the airbag will inflate when it is not supposed to, or will not inflate when it should.

#### **How knee airbags work**

Applies to vehicles: with knee airbags

*The risk of injury to the leg area can be reduced by fully inflated knee airbags.*

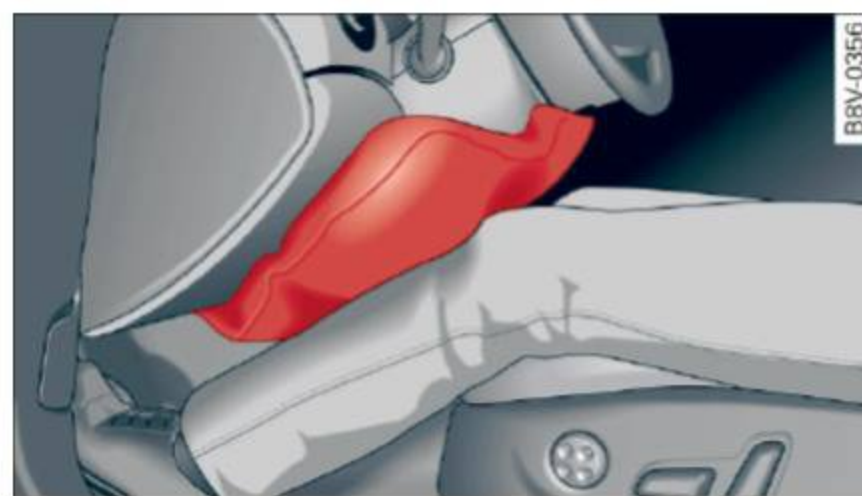

**Fig. 133** Inflated airbags protecting in a frontal collision

The knee airbag system has been designed so that the airbags for the driver and front passenger deploy in certain but not all frontal collisions.

If the front airbags deploy, the knee airbags also deploy in frontal collisions when the deployment threshold stored in the control unit is met.

When the system deploys, the airbags fill with a compressed propellant gas, and inflate between the lower part of the instrument panel and the driver and the lower part of the instrument panel and the front passenger ⇒ page 158, fig. 130.

Although they are not a soft pillow, they can “cushion” the impact and in this way they can



## Airbag system

help to reduce the risk of injury to the lower extremities.

All of this takes place in the blink of an eye, so fast that many people don't even realize that the airbags have deployed. The airbags also inflate with a great deal of force and it is important for occupant safety that nothing should be in their way when they deploy.

Fully inflated airbags in combination with properly worn safety belts slow down and limit the occupant's forward movement and help to reduce the risk of injury.

### Important safety instructions on the knee airbag system

Applies to vehicles: with knee airbags

*Airbags are only supplemental restraints. Always wear safety belts correctly and ride in a proper seating position.*

There is a lot that you and your passengers must know and do to help the safety belts and airbags to provide supplemental protection.

#### WARNING

An inflating knee airbag can cause serious injury. Wearing safety belts incorrectly and improper seating positions increase the risk of serious personal injury and death whenever a vehicle is being used.

- The knee airbag system cannot protect you properly if you are seated too close to any of the airbag locations. When adjusting their seat positions, it is important that both the driver and the front passenger keep their upper bodies and knees at the following minimum safe distances:
  - at least 10 inches (25 cm) between the chest and the steering wheel/instrument panel.
  - at least 4 inches (10 cm) between the knees and the lower part of the instrument panel.
- The risk of personal injury increases if you lean forward or to the side, or if the seat is improperly positioned and you are not wear-

ing your safety belt. The risk increases even more should the airbag deploy.

- Always make sure that the knee airbag can inflate without interference. Objects between you and the airbag can increase the risk of injury in an accident by interfering with the way the airbag deploys or by being pushed into you as the airbag deploys.
- Never let anybody, especially children or animals ride in the footwell in front of the passenger seat. If the airbag deploys, this can result in serious or fatal injuries.
- Never carry objects of any kind in the footwell area in front of the driver's or passenger's seat. Bulky objects (shopping bags, for example) can interfere with or prevent proper deployment of the airbag. Small objects can be thrown through the vehicle if the airbag deploys and injure you or your passengers.
- Make sure there are no cracks, deep scratches or other damage in the area of the instrument panel where the knee airbags are located.
- If children are incorrectly seated, their risk of injury increases in a collision  
⇒ page 172, *Child safety*.

## Side airbags

### Description of side airbags

*The airbag system can provide supplemental protection to properly restrained occupants.*

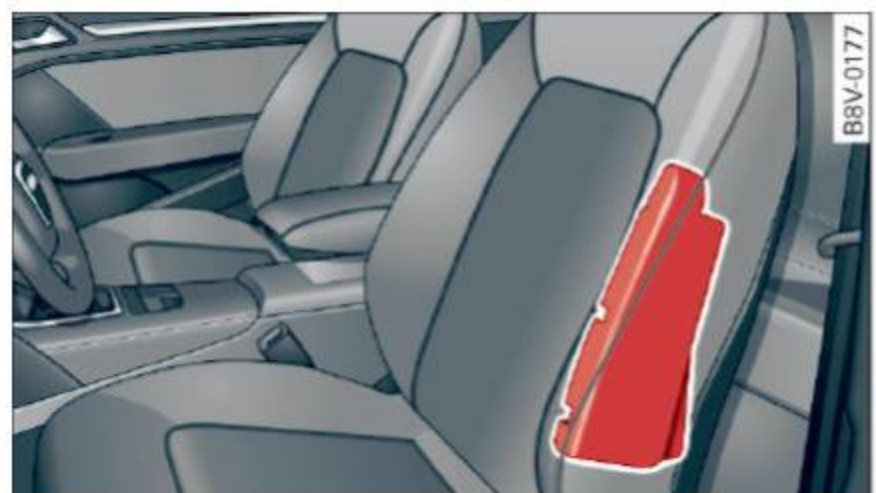

**Fig. 134** Side airbag location in the driver's seat

The side airbags are located in the sides of the front seat backrests ⇒ *fig. 134* and the rear backrest facing the doors.



The side airbags installed for the front seating positions have been designed and certified to help reduce the risk of injury that can be caused by airbags when they inflate, particularly when the occupant sitting next to it is not seated properly. The side airbag for the front passenger seat can be used with properly installed child restraints. Please be sure to read the important information and warnings whenever using a child restraint in a vehicle: Safety belts ⇒ *page 140*, Airbag system ⇒ *page 148*, Child safety ⇒ *page 172*.

#### The side airbag system basically consists of:

- the electronic control module and external side impact sensors
- the two airbags located in the sides of the front backrests and the two airbags\* located in the rear backrest
- the airbag warning light in the instrument cluster.

The airbag system is monitored electronically to make certain that it is functioning properly at all times. Each time you switch on the ignition, the airbag system indicator light will come on for a few seconds (self diagnostics).

The side airbag system supplements the safety belts and can help to reduce the risk of injury to the driver's, front and rear passenger's upper torso on the side of the vehicle that is struck in a side collision. The airbag deploys only in side impacts and only when the vehicle acceleration registered by the control unit is high enough. If this rate is below the reference value programmed into the control unit, the side airbags will not be triggered, even though the car may be badly damaged as a result of the collision. It is not possible to define an airbag triggering range that will cover every possible angle of impact, since the circumstances will vary considerably between one collision and another. Important factors include, for example, the nature (hard or soft) of the impacting object, the angle of impact, vehicle speed, etc. ⇒ *page 168, Important safety instructions on the side airbag system*.

Aside from their normal safety function, safety belts work to help keep the driver or front pas-

senger in position in the event of a side collision so that the side airbags can provide protection.

The airbag system is *not* a substitute for your safety belt. Rather, it is part of the overall occupant restraint system in your vehicle. Always remember that the side airbag system can only help to protect you if you are wearing your safety belt and wearing it properly. This is another reason why you should always wear your safety belts, not just because the law requires you to do so ⇒ *page 140, General notes*.

It is important to remember that while the supplemental side airbag system is designed to reduce the likelihood of serious injuries, other injuries, for example, swelling, bruising, friction burns and minor abrasions can also be associated with deployed side airbags. Remember too, side airbags will deploy only once and only in certain kinds of accidents - your safety belts are always there to offer protection.

Vehicle damage, repair costs or even the lack of vehicle damage are not necessarily an indication of over-sensitive or failed airbag activation. In some collisions, both front and side airbags may inflate. Remember too, that airbags will deploy only once and only in certain kinds of collisions - your safety belts are always there to offer protection in those accidents in which airbags are not supposed to deploy or when they have already deployed.

#### The side airbag system will not deploy:

- when the ignition is switched off
- in side collisions when the acceleration measured by the sensor is too low
- in front-end collisions
- in rear-end collisions
- in rollovers.

In some types of accidents the front airbags, side curtain airbags and side airbags may be triggered together.

#### WARNING

- Safety belts and the airbag system will only provide protection when occupants are in the proper seating position ⇒ *page 168*.



- If the airbag indicator light ⇒ *page 20* comes when the vehicle is being used, have the system inspected immediately by your authorized Audi dealer. It is possible that the airbag will inflate when it is not supposed to, or will not inflate when it should.

### How supplemental side airbags work

*Side airbags deploy instantly and can help reduce the risk of upper torso injuries for occupants who are properly restrained.*

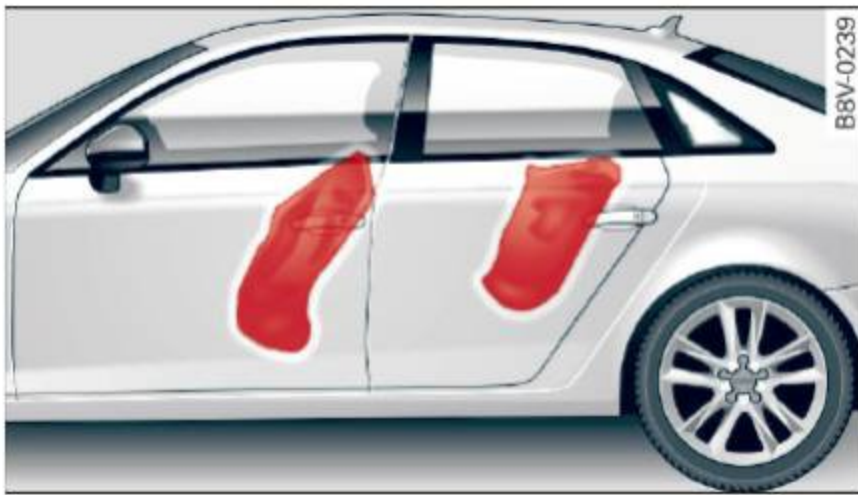

**Fig. 135** Side impact protection: inflated side airbags

When the system is triggered, the airbag is filled with propellant gas and breaks through a seam in the seat surface area marked "AIRBAG". It expands between the side trim panel and the passenger. In order to help provide this additional protection, the side airbag must inflate within a fraction of a second at very high speed and with great force. The supplemental side airbag could injure you if your seating position is not proper or upright or if items are located in the area where the supplemental side airbag expands. This applies especially to children ⇒ *page 172, Child safety*. Supplemental side airbags inflate between the occupant and the door panel on the side of the vehicle that is struck in certain side collision ⇒ *fig. 135*.

Although they are not a soft pillow, they can "cushion" the impact and in this way they can help to reduce the risk of injury to the upper part of the body.

A fine dust may develop when the airbag deploys. This is normal and does not mean there is a fire in the vehicle.

### Important safety instructions on the side airbag system

*Airbags are only supplemental restraints. Always properly wear safety belts and ride in a proper seating position.*

There is a lot that you and your passengers must know and act accordingly to help the safety belts and airbags do their job to provide supplemental protection.

#### **WARNING**

An inflating side airbag can cause serious or fatal injury. Improperly wearing safety belts and improper seating positions increase the risk of serious personal injury and death whenever a vehicle is being used.

- In order to reduce the risk of injury when the supplemental side airbag inflates:
  - Always sit in an upright position and never lean against the area where the supplemental side airbag is located.
  - Never let a child or anyone else rest their head against the side trim panel in the area where the supplemental side airbag inflates.
  - Always make sure that safety belts are worn correctly,
  - Do not let anyone sitting in the front seat put their hand or any other parts of their body out of the window.
- Always make sure that the side airbag can inflate without interference.
  - Never install seat covers or replacement upholstery over the front seatbacks that have not been specifically approved by Audi.
  - Never use additional seat cushions that cover the areas where the side airbags deploy.
  - Damage to the original seat covers or to the seam in the area of the side airbag module must always be repaired immediately by an authorized Audi dealer.
- Objects between you and the airbag can increase the risk of injury in an accident by interfering with the way the airbag unfolds or



by being pushed into you as the airbag inflates.

- Never place or attach accessories or other objects (such as cup holders, telephone brackets, or even large, bulky objects) on the doors, over or near the area marked “AIRBAG” on the seat backrests.
- Such objects and accessories can become dangerous projectiles and cause injury when the supplemental side airbag deploys.
- Never carry any objects or pets in the deployment space between them and the airbags or allow children or other passengers to travel in this position.
- Always use the built-in coat hooks only for lightweight clothing. Never leave any heavy or sharp-edged objects in the pockets that may interfere with side airbag deployment and can cause personal injury in an accident.
- Always prevent the side airbags from being damaged by heavy objects knocking against or hitting the sides of the seatbacks.
- The airbag system can only be triggered once. If the airbag has been triggered, the system must be replaced by an authorized Audi dealership.
- Damage (cracks, deep scratches etc.) to the original seat covers or to the seam in the area of the side airbag module must always be repaired immediately by an authorized Audi dealer.
- If children are seated improperly, their risk of injury increases in the case of an accident ⇒ *page 172, Child safety*.
- Never attempt to modify any components of the airbag system in any way.
- In a side collision, side airbags will not function properly if sensors cannot correctly measure increasing air pressure inside the doors when air escapes through larger, unclosed openings in the door panel.
  - Never drive with interior door trim panels removed.
  - Never drive when parts have been removed from the inside door panel and the openings they leave have not been properly closed.

- Never drive when loudspeakers in the doors have been removed unless the speaker holes have been properly closed.
- Always make certain that openings are covered or filled if additional speakers or other equipment is installed in the inside door panels.
- Always have work on the doors done by an authorized Audi dealer or qualified workshop.

## Side curtain airbags

### Description of side curtain airbags

The side curtain airbag system can provide supplemental protection to properly restrained occupants.

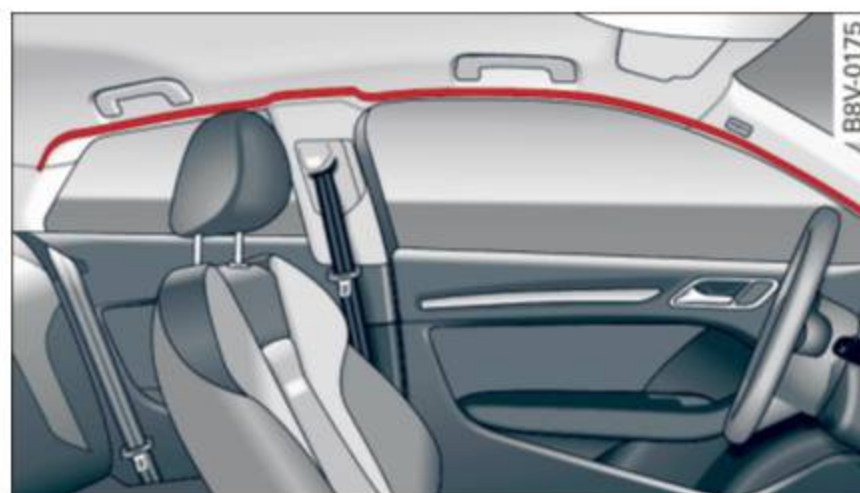

**Fig. 136** Side curtain airbags, driver's side: side curtain airbag location

The side curtain airbags are located on both sides of the interior above the front and rear side windows ⇒ *fig. 136*. They are identified by the word “AIRBAG” on the windshield frame and the center roof pillar.

The side curtain airbags contain features that provide ejection mitigation to help prevent vehicle occupants or parts of their bodies from being completely or partially ejected from the vehicle interior in certain side impacts and vehicle roll-overs.

The side curtain airbag system supplements the safety belts and can help to reduce the risk of injury for occupants' heads and upper torso on the side of the vehicle that is struck in a side collision. The side curtain airbag inflates in side impacts and only when the vehicle acceleration



registered by the control unit is high enough. If this rate is below the reference value programmed into the control unit, the side curtain airbag will not be triggered, even though the car may be badly damaged as a result of the collision. It is not possible to define an airbag triggering range that will cover every possible angle of impact, since the circumstances will vary considerably between one collision and another. Important factors include, for example, the nature (hard or soft) of the impacting object, the angle of impact, vehicle speed, etc. ⇒ *page 170, How side curtain airbags work.*

Aside from their normal safety function, safety belts work to help keep the driver or front passenger in position in the event of a collision so that the side curtain airbags can provide protection.

The airbag system is not a substitute for your safety belt. Rather, it is part of the overall occupant restraint system in your vehicle. Always remember that the airbag system can only help to protect you if you are wearing your safety belt and wearing it properly. This is another reason why you should always wear your safety belts, not just because the law requires you to do so ⇒ *page 140, General notes.*

It is important to remember that while the side curtain airbag system is designed to help reduce the likelihood of serious injuries, other injuries, for example, swelling, bruising, friction burns and minor abrasions can also be associated with these airbags upon deployment. Remember too, these airbags will deploy only once and only in certain kinds of accidents - your safety belts are always there to offer protection.

### The side curtain airbag system basically consists of:

- The electronic control module and external side impact sensors
- The side curtain airbags above the front and rear side windows with ejection mitigation features
- The airbag indicator light in the instrument panel

The airbag system is monitored electronically to make certain it is functioning properly at all times. Each time you switch on the ignition, the airbag system indicator light will come on for a few seconds (self diagnostics).

### The side curtain airbag is not activated:

- if the ignition is switched off,
- in side collisions when the acceleration measured by the sensor is too low,
- in rear-end collisions.

### WARNING

- Safety belts and the airbag system will only provide protection when occupants are in the proper seating position ⇒ *page 54, Front seats.*
- If the airbag indicator light ⇒ *page 20* comes when the vehicle is being used, have the system inspected immediately by your authorized Audi dealer. It is possible that the airbag will inflate when it is not supposed to, or will not inflate when it should.

### How side curtain airbags work

Side curtain airbags can work together with side airbags to help reduce the risk of head and upper torso injuries for occupants who are properly restrained.



**Fig. 137** Illustration of principle: Inflated side curtain airbags on the left side

The side curtain airbags inflate between the occupant and the windows on the side of the vehicle that is struck in a side collision ⇒ *fig. 137.*

When the system is triggered, the side curtain airbag is filled with propellant gas and breaks



through a seam above the front and rear side windows identified by the AIRBAG label. In order to help provide this additional protection, the side curtain airbag must inflate within the blink of an eye at very high speed and with great force. The side curtain airbag could injure you if your seating position is not proper or upright or if items are located in the area where the supplemental side curtain airbag inflates. This applies especially to children ⇒ page 172.

Although they are not a soft pillow, side curtain airbags can “cushion” the impact and in this way they can help to reduce the risk of injury to the head and the upper part of the body.

A fine dust may develop when the airbag deploys. This is quite normal and does not mean there is a fire in the vehicle.

### Important safety instructions on the side curtain airbag system

*Airbags are only supplemental restraints. Always properly wear safety belts and ride in a proper seating position.*

There is a lot that you and your passengers must know and do to help the safety belts and airbags do their job to provide supplemental protection.

#### WARNING

Improperly wearing safety belts and improper seating positions increase the risk of serious personal injury and death whenever a vehicle is being used.

- Never let occupants place any parts of their bodies in the area from which the side curtain airbag inflates.
- Always make sure that the side curtain airbags can inflate without interference.
- Use the built-in coat hooks only for light-weight clothing. Never leave any heavy or sharp-edged objects in the pockets that may interfere with airbag deployment and can cause personal injury in a collision.
- Never use hangers to hang clothes on the hooks.

- Only use factory-installed sun shades or, if shades installed after the vehicle leaves the factory, use only genuine Audi sun shades.
- Never swing the sun visors over to the side windows if things such as pens, garage door openers, hands-free speakers, etc. are attached to the sun visors. They could come loose and cause serious injury if the side curtain airbag inflates.
- A deploying airbag inflates in a fraction of a second and with great force.
- Never attach objects to the cover or in the deployment zone of a side curtain airbag.
- The airbag deployment zones must be kept clear at all times. Make sure there are no objects, pets, or other persons in the space between any vehicle occupant and any airbag at any time.
- Do not attach any accessories to the doors.

#### WARNING

- The airbag system can deploy only once. If the airbag has been triggered, the system must be replaced by an authorized Audi dealer or qualified workshop.
- Always have work involving the side curtain airbag system, removal and installation of the airbag components, or other repairs performed by a qualified dealership. Otherwise the airbag system may not work correctly.
- Never attempt to modify any components of the airbag system in any way.



## Child safety

### Important information

#### Introduction

*The rear seat is generally the safest place in a collision.*

The physical principles of what happens when your vehicle is in a crash apply also to children ⇒ *page 141, What happens to occupants not wearing safety belts?*. But unlike adults and teenagers, their muscles and bones are not fully developed. In many respects children are at greater risk of serious injury in crashes than adults.

Because children's bodies are not fully developed, they require restraint systems especially designed for their size, weight, and body structure. Many countries and all states of the United States and provinces of Canada have laws requiring the use of approved child restraint systems for infants and small children.

In a frontal crash at a speed of 20-35 mph (30-56 km/h) the forces acting on a 13-pound (6 kg) infant will be more than 20 times the weight of the child. This means the weight of the child would suddenly be more than 260 pounds (120 kg). Under these conditions, only an appropriate child restraint properly used can reduce the risk of serious injury. Child restraints, like adult safety belts, must be used properly to be effective. Used improperly, they can increase the risk of serious injury in an accident.

Consult the child safety seat manufacturer's instructions in order to be sure the seat is right for your child's size ⇒ *page 175, Important safety instructions for using child safety seats*. Please be sure to read and heed all of the important information and WARNINGS about child safety, Advanced Airbags, and the installation of child restraints in this chapter.

There is a lot you need to know about the Advanced Airbags in your vehicle and how they work when infants and children in child restraints are on the front passenger seat. Because of the large amount of important information, we cannot re-

peat it all here. We urge you to read the detailed information in this owner's manual about airbags and the Advanced Airbag System in your vehicle and the very important information about transporting children on the front passenger seat. Please be sure to heed the WARNINGS - they are extremely important for your safety and the safety of your passengers, especially infants and small children.

#### WARNING

- Accident statistics have shown that children are generally safer in the rear seat area than in the front seating position. Always restrain any child age 12 and under in the rear.
- All vehicle occupants and especially children must be restrained properly whenever riding in a vehicle. An unrestrained or improperly restrained child could be injured by striking the interior or by being ejected from the vehicle during a sudden maneuver or impact. An unrestrained or improperly restrained child is also at greater risk of injury or death through contact with an inflating airbag.
- A suitable child restraint properly installed and used at one of the rear seating positions provides the highest degree of protection for infants and small children in most accident situations.

#### WARNING

- Children on the front seat of any car even with Advanced Airbags can be seriously injured or even killed when an airbag inflates. A child in a rearward-facing child safety seat installed on the front passenger seat will be seriously injured and can be killed if the front airbag inflates.
- The inflating airbag will hit the child safety seat or infant carrier with great force and will smash the child safety seat and child against the backrest, center armrest, or door.
  - Always install rear-facing child safety seats on the rear seat.
  - If you must install a rearward facing child safety seat on the front passenger seat in



exceptional circumstances and the **PASSENGER AIR BAG OFF** light does not come on and stay on, immediately install the rear-facing child safety seat in a rear seating position and have the airbag system inspected immediately by your Audi dealer.

### **WARNING**

- Forward-facing child seats installed on the front passenger seat may interfere with the deployment of the airbag and cause serious personal injury to the child.
- If exceptional circumstances require the use of a forward-facing child restraint on the front passenger's seat, the child's safety and well-being require the following special precautions to be taken:
  - Always make sure that the forward-facing seat has been designed and certified by its manufacturer for use on a front passenger seat with a front and side airbag.
  - Always carefully follow the manufacturer's instructions provided with the child seat or infant carrier.
  - Never install a child restraint without a properly attached top tether strap if the child restraint manufacturer's instructions require the top tether strap to be used.
  - Never put the forward-facing child restraint up against or very near the instrument panel.
  - Always set the safety belt upper anchorage to the adjustment position that permits proper installation in accordance with the child restraint manufacturer's instructions.
  - Always move the passenger seat into its rearmost position in the seat's fore and aft adjustment range, as far away from the airbag as possible before installing the child restraint. The backrest must be adjusted to an upright position.
  - Always make sure that nothing prevents the front passenger's seat from being moved to the rearmost position in its fore and aft adjustment range.

- Never place objects on the seat (such as a laptop, CD player, electronic games device, power inverter or seat heater for child seats). These may influence the electrical capacitance measured by the capacitive passenger detection system and can also fly around in an accident and cause serious personal injury.
- Never place or use any electrical device (such as a laptop, CD player, electronic games device, power inverter or seat heater for child seats) on the front passenger seat if the device is connected to the 12-volt socket or the cigarette lighter socket.
- If a seat heater has been retrofitted or otherwise added to the front passenger seat, never install any child restraint system on this seat.
- Make sure that there are no wet objects (such as a wet towel) and no water or other liquids on the front passenger seat cushion.
- Always make sure that the **PASSENGER AIR BAG OFF** light comes on and stays on all the time whenever the ignition is switched on.
- If the **PASSENGER AIR BAG OFF** light does not come on and stay on, immediately install the forward-facing child seat in a rear seating position and have the airbag system inspected by your authorized Audi dealer.
- Always buckle the child seat firmly in place even if a child is not sitting in it. A loose child seat can fly around during a sudden stop or in a collision.
- Always read and heed all WARNINGS whenever using a child restraint in a vehicle ⇒ *page 140, Safety belts*, ⇒ *page 148, Airbag system* and ⇒ *page 172, Important information*.

### **Tips**

Always replace child restraints that were installed in a vehicle during a crash. Damage to a child restraint that is not visible could cause it to fail in another collision situation.



### Advanced front airbag system and children

Your vehicle is equipped with a front “Advanced Airbag System” in compliance with United States Federal Motor Vehicle Safety Standard (FMVSS) 208 as applicable at the time your vehicle was manufactured.

The Advanced Airbag system in your vehicle has been certified to meet the “low-risk” requirements for 3- and 6-year old children on the passenger side and small adults on the driver side. The low risk deployment criteria are intended to reduce the risk of injury through interaction with the airbag that can occur, for example, by being too close to the steering wheel and instrument panel when the airbag inflates. In addition, the system has been certified to comply with the “suppression” requirements of the Safety Standard, to turn off the front airbag for infants up to 12 months who are restrained on the front passenger seat in child restraints that are listed in the Standard.

Even though your vehicle is equipped with an Advanced Airbag system, all children, especially those 12 years and younger, should always ride in the back seat properly restrained for their age and size. The airbag on the passenger side makes the front seat a potentially dangerous place for a child to ride. The front seat is not the safest place for a child in a forward-facing child safety seat. It can be a very dangerous place for an infant or a larger child in a rearward-facing seat.

The vehicle's Advanced Airbag System has a capacitive passenger detection system in the front passenger seat cushion that can detect the presence of a baby or a child in a child restraint system on this seat.

The capacitive passenger detection system registers the changes that result in an electrical field when a child, a child restraint, and a baby blanket are on the front passenger seat. The change in the measured capacitance due to the presence of a child, a child restraint, and a baby blanket on the front passenger seat is related to the child restraint system resting on the seat. The measured capacitance of a child restraint system varies de-

pending on the type of system and specific make and model.

The electrical capacitance of the various types, makes, and models of child restraints specified by the U.S. National Highway Traffic Safety Administration (NHTSA) in the relevant safety standard are stored in the Advanced Airbag System control unit together with the capacitances typical of infants and a 1-year old child. When a child restraint is used on the front passenger seat with a typical 1 year-old infant, the Advanced Airbag System compares the capacitance measured by the capacitive passenger detection system with the data stored in the electronic control unit.

### Child restraints and Advanced front airbag system

Regardless of the child restraint that you use, make sure that it has been certified to meet United States Federal Motor Vehicle Safety Standards and has been certified by its manufacturer for use with an airbag. Always be sure that the child restraint is properly installed at one of the rear seating positions. If in exceptional circumstances you must use it on the front passenger seat, carefully read all of the information on child safety and Advanced Airbags and heed all of the applicable WARNINGS. Make certain that the child and child restraint are correctly recognized by the capacitive passenger detection system in the front passenger seat, that the front passenger airbag is turned off, and that the airbag status is always correctly signaled by the **PASSENGER AIR BAG OFF** light.

Many types and models of child restraints have been available over the years, new models are introduced regularly incorporating new and improved designs and older models are taken out of production. Child restraints are not standardized. Child restraints of the same type typically have different weights and sizes and different “footprints”, the size and shape of the bottom of the child restraint that sits on the seat, when they are installed on a vehicle seat. These differences make it virtually impossible to certify compliance with the requirements for advanced airbags with ►



each and every child restraint that has ever been sold in the past or will be sold over the course of the useful life of your vehicle.

For this reason, the United States National Highway Traffic Safety Administration has published a list of specific type, makes and models of child restraints that must be used to certify compliance of the Advanced Airbag System in your vehicle with the suppression requirements of Federal Motor Vehicle Safety Standard 208. These child restraints are:

#### Subpart A – Car bed child restraints

Model	Manufactured on or after
Angel Guard Angel Ride AA2403FOF	September 25, 2007

#### Subpart B – Rear-facing child restraints

Model	Manufactured on or after
Century SmartFit 4543	December 1, 1999
Cosco Arriva 22-013PAW and base 22-999WHO	September 25, 2007
Evenflo Discovery Adjust Right 212	December 1, 1999
Evenflo First Choice 204	December 1, 1999
Graco Infant 8457	December 1, 1999
Graco Snugride	September 25, 2007
Peg Perego Primo Viaggio SIP IMUN00US	September 25, 2007

#### Subpart C – Forward-facing and convertible child restraints

Model	Manufactured on or after
Britax Roundabout E9L02xx	September 25, 2007
Cosco Touriva 02519	December 1, 1999
Cosco Summit Deluxe High Back Booster 22-262	September 25, 2007

Model	Manufactured on or after
Cosco High Back Booster 22-209	September 25, 2007
Evenflo Tribute V 379xxxx	September 25, 2007
Evenflo Medallion 254	December 1, 1999
Evenflo Generations 352xxxx	September 25, 2007
Graco ComfortSport	September 25, 2007
Graco Toddler Safety Seat Step 2	September 25, 2007
Graco Platinum Cargo	September 25, 2007

#### WARNING

To reduce the risk of serious injury, make sure that the **PASSENGER AIR BAG OFF** light comes on and stays on whenever a child restraint is installed on the front passenger seat and the ignition is switched on.

- Take the child restraint off the front passenger seat and install it properly at one of the rear seat positions if the **PASSENGER AIR BAG OFF** light does not stay on.
- Have the airbag system inspected by your authorized Audi dealer immediately.

#### Tips

The child seats listed in categories A to C have been statically tested by Audi only for the Advanced Airbag function.

#### Important safety instructions for using child safety seats

*Correct use of child safety seats substantially reduces the risk of injury in an accident!*

As the driver, you are responsible for the safety of everybody in the vehicle, especially children:

- ▶ Always use the right child safety seat for each child and always use it properly ⇒ *page 178*.
- ▶ Always carefully follow the child safety seat manufacturer's instructions on how to route the safety belt properly through the child safety seat.



- ▶ When using the vehicle safety belt to install a child safety seat, you must first activate the convertible locking retractor on the safety belt to prevent the child safety seat from moving  
⇒ *page 182*.
- ▶ Push the child safety seat down with your full weight to get the safety belt really tight so that the seat cannot move forward or sideways more than one inch (2.5 cm).
- ▶ Secure unused safety belts on the rear seat  
⇒ *page 177*.

Always remember: Even though your vehicle is equipped with an Advanced Airbag system, all children, especially those 12 years and younger, should always ride in the back seat properly restrained for their age and size.

### **WARNING**

Not using a child safety seat, using the wrong child safety seat or improperly installing a child restraint increases the risk of serious personal injury and death.

- All vehicle occupants and especially children must be restrained properly whenever riding in a vehicle. An unrestrained or improperly restrained child could be injured by striking the interior or by being ejected from the vehicle during a sudden maneuver or impact. An unrestrained or improperly restrained child is also at greater risk of injury or death through contact with an inflating airbag.
- Commercially available child safety seats are required to comply with U.S. Federal Motor Vehicle Safety Standard (FMVSS) 213 (in Canada CMVSS 213).
  - When buying a child restraint, select one that fits your child and the vehicle.
  - Only use child restraint systems that fully contact the flat portion of the seat cushion. The child restraint must not tip or lean to either side. Audi does not recommend using child safety seats that rest on legs or tube-like frames. They do not provide adequate contact with the seat.
  - Always heed all legal requirements pertaining to the installation and use of child safety seats and carefully follow the in-

- instructions provided by the manufacturer of the seat you are using.
- Never allow children under 57 inches (1.45 meters) to wear a normal safety belt. They must always be restrained by a proper child restraint system. Otherwise, they could sustain injuries to the abdomen and neck areas during sudden braking maneuvers or accidents.
- Never let more than one child occupy a child safety seat.
- Never let babies or older children ride in a vehicle while sitting on the lap of another passenger.
  - Holding a child in your arms is never a substitute for a child restraint system.
  - The strongest person could not hold the child with the forces that exist in an accident. The child will strike the interior of the vehicle and can also be struck by the passenger.
  - The child and the passenger can also injure each other in an accident.
- Never install rear-facing child safety seats or infant carriers on the front passenger seat. A child will be seriously injured and can be killed when the passenger airbag inflates – even with an Advanced Airbag System.
- The inflating airbag will hit the child safety seat or infant carrier with great force and will smash the child safety seat and child against the backrest, center armrest, door or roof.
- Always install rear-facing child safety seats or infant carriers on the rear seat.
- Forward-facing child safety seats installed on the front passenger's seat can interfere with the airbag when it inflates and cause serious injury to the child. Always install forward-facing child safety seats on the rear seat.
- If exceptional circumstances require the use of a forward-facing child restraint on the front passenger's seat, the child's safety and well-being require that the following special precautions be taken: ▶



- Make sure the forward-facing seat has been designed and certified by its manufacturer for use on a front seat with a passenger front and side airbag.
- Always carefully follow the manufacturer's instructions provided with the child safety seat or carrier.
- Always move the front passenger seat into the rearmost position of the passenger seat's fore and aft adjustment range, and as far away from the airbag as possible before installing the child restraint.
- Always make sure that nothing prevents the front passenger's seat from being moved to the rearmost position in its fore and aft adjustment range.
- Always make sure that the backrest is in the upright position.
- Never place or use any electrical device (such as a laptop, CD player, electronic games device, power inverter or seat heater for child seats) on the front passenger seat if the device is connected to the 12-volt socket or the cigarette lighter socket.
- If a seat heater has been retrofitted or otherwise added to the front passenger seat, never install any child restraint system on this seat.
- Make sure that there are no wet objects (such as a wet towel) and no water or other liquids on the front passenger seat cushion.
- Never place objects on the seat (such as a laptop, CD player, electronic games device, power inverter or seat heater for child seats). These may influence the electrical capacitance measured by the capacitive passenger detection system and can also fly around in an accident and cause serious personal injury.
- Always buckle the child safety seat firmly in place even if a child is not sitting in it. A loose child safety seat can fly around during a sudden stop or in a collision.
- Always read and heed all WARNINGS whenever using a child restrained in a vehicle is being used ⇒ *page 140, Safety belts,*

⇒ *page 148, Airbag system and*  
 ⇒ *page 172, Child safety.*

### **WARNING**

To reduce the risk of serious injury, make sure that the **PASSENGER AIR BAG OFF** light comes on and stays on whenever a child restraint is installed on the front passenger seat and the ignition is switched on.

- Take the child restraint off the front passenger seat and install it properly at one of the rear seat positions if the **PASSENGER AIR BAG OFF** light does not stay on.
- Have the airbag system inspected by your authorized Audi dealer immediately.

### **Secure unused safety belts on the rear seat**



**Fig. 138** Schematic overview: keep unused safety belts away from children in child safety seats. **A** - outer rear safety belt, **B** - center rear safety belt\*

If a child safety seat is used on the rear bench, especially with LATCH universal lower anchorages, the unused safety belts **must** be secured so that the child in the child restraint cannot reach them ⇒ .

- Guide the safety belt webbings **A** and **B**\* behind the head restraint of the seat where the child restraint is installed ⇒ *fig. 138*. When doing so, do not engage the convertible locking retractor! You should not hear a “clicking” sound when winding up the safety belt.
- Let the belt retractor wind up the safety belt webbing.



**! WARNING**

A child in a child safety seat installed with the LATCH lower anchorages or with the standard safety belt or a child in a booster seat on the rear seat could play with unused rear seat safety belts and become entangled. This could cause the child serious personal injury and even death.

- Always secure unused rear seat safety belts out of reach of children in child seats such as by properly routing them around the head restraint of the seat where the child restraint is installed.
- Never activate the convertible locking retractor when routing the safety belts around the head restraints.
- Never let anyone sit at the center rear seating position if the center rear safety belt has been routed around a rear head restraint.

## Child seats

### Infant seats

Babies and infants up to about one year old and 20 lbs. or 9 kg need special rearward-facing child restraints that support the back, neck and head in a crash.



Fig. 139 Schematic overview: rearward-facing infant seat, properly installed on the rear seat

- ▶ When using the vehicle safety belt to install a child safety seat, you must first activate the convertible locking retractor on the safety belt to prevent the child safety seat from moving ⇒ page 182 or install the seat using the LATCH attachments.
- ▶ Push the child safety seat down with your full weight to get the safety belt really tight so that

the seat cannot move forward or sideways more than one inch (2.5 cm).

- ▶ Secure unused safety belts on the rear seat ⇒ page 177.

Infants up to about one year (20 lbs. or 9 kg) are best protected in special infant carriers and child safety seats designed for their age group. Many experts believe that infants and small children should ride only in special restraints in which the child faces the back of the vehicle. These infant seats support the baby's back, neck and head in a crash ⇒ fig. 139.

The airbag on the passenger side makes the front seat a potentially dangerous place for a child to ride. The front seat is not the safest place for a child in a forward-facing child seat. It is a very dangerous place for an infant or a larger child in a rearward-facing seat.

**! WARNING**

Not using a child safety seat, using the wrong child safety seat or improperly installing a child restraint increases the risk of serious personal injury and death in a crash.

- Never install rear-facing child safety seats or infant carriers on the front passenger seat - even with an Advanced Airbag System. A child will be seriously injured and can be killed when the inflating airbag hits the child safety seat or infant carrier with great force and smashes the child safety seat and child against the backrest, center armrest, door or roof ⇒ page 149, *Child restraints on the front seat - some important things to know.*
- Always install rear-facing child safety seats or infant carriers on the rear seat.
- Never install a rear-facing child restraint in the forward-facing direction. Such restraints are designed for the special needs of infants and very small children and cannot protect them properly if the seat is forward-facing.
- If you must install a rearward facing child safety seat on the front passenger seat because of exceptional circumstances and the **PASSENGER AIR BAG OFF** light does not come on and stay on, immediately install



the rear-facing child safety seat in a rear seating position and have the airbag system inspected by your Audi dealer.

- Never place or use any electrical device (such as a laptop, CD player, electronic games device, power inverter or seat heater for child seats) on the front passenger seat if the device is connected to the 12-volt socket or the cigarette lighter socket.
- If a seat heater has been retrofitted or otherwise added to the front passenger seat, never install any child restraint system on this seat.
- Make sure that there are no wet objects (such as a wet towel) and no water or other liquids on the front passenger seat cushion.
- Never place objects on the seat (such as a laptop, CD player, electronic games device, power inverter or seat heater for child seats). These may influence the electrical capacitance measured by the capacitive passenger detection system and can also fly around in an accident and cause serious personal injury.
- Always read and heed all WARNINGS whenever using a child restrained in a vehicle is being used ⇒ *page 140, Safety belts*, ⇒ *page 148, Airbag system* and ⇒ *page 172, Important information*.

### Convertible child safety seats

Properly used convertible child safety seats can help protect toddlers and children over age one who weigh between 20 and 40 lbs. (9 and 18 kg) in a crash.

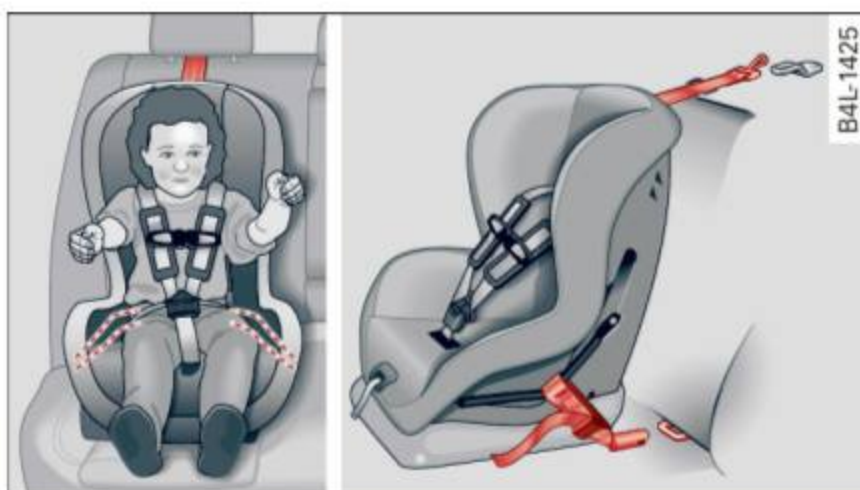

**Fig. 140** Schematic overview: installation of the attachments applicable to a LATCH seat

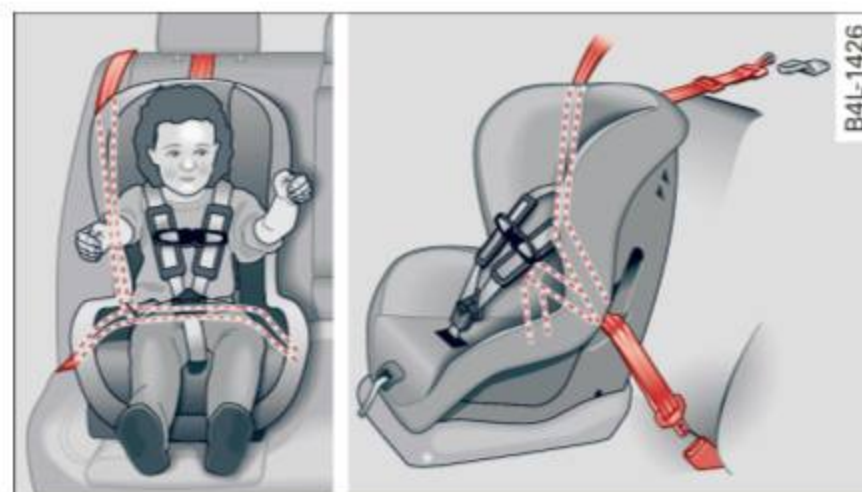

**Fig. 141** Schematic overview: installation of the seat using the vehicle's safety belt system

- ▶ When using the vehicle safety belt to install a child safety seat, you must first activate the convertible locking retractor on the safety belt to prevent the child safety seat from moving ⇒ *page 182* or install the seat using the LATCH attachments.
- ▶ Push the child safety seat down with your full weight to get the safety belt really tight so that the seat cannot move forward or sideways more than one inch (2.5 cm) ⇒ *page 182*.
- ▶ If the child safety seat is equipped with a tether strap, attach it to the tether anchors ⇒ *page 188*.
- ▶ Secure unused safety belts on the rear seat ⇒ *page 177*.

A toddler or child is usually too large for an infant restraint if it is more than one year old and weighs more than 20 lbs. (9 kg).

Toddlers and children who are older than one year up to about 4 years old and weigh more than 20 lbs (9 kg) up to 40 lbs. (18 kg) must always be properly restrained in a child safety seat certified for their size and weight ⇒ *fig. 140* and ⇒ *fig. 141*.

The airbag on the passenger side makes the front seat a potentially dangerous place for a child to ride. The front seat is not the safest place for a child in a forward-facing child safety seat. It is a very dangerous place for an infant or a larger child in a rearward-facing seat.

#### WARNING

Not using a child safety seat, using the wrong child safety seat or improperly installing a child restraint increases the risk of serious



personal injury and death in a collision or other emergency situation.

- Children on the front seat of any car, even with Advanced Airbags, can be seriously injured or even killed when an airbag inflates. A child in a rearward-facing child safety seat installed on the front passenger seat will be seriously injured and can be killed if the front airbag inflates – even with an Advanced Airbag System.
- The inflating airbag will hit the child safety seat or infant carrier with great force and will smash the child safety seat and child against the backrest, center arm rest, door or roof.
- Always install rear-facing child safety seats on the rear seat.
- If you must install a rearward facing child safety seat on the front passenger seat because of exceptional circumstances and the **PASSENGER AIR BAG OFF** light does not come on and stay on, immediately install the rear-facing child safety seat in a rear seating position and have the airbag system inspected by your Audi dealer.
- The rear side of the child safety seat should be positioned as close as possible to the backrest on the vehicle seat.
- For adjustable head restraints: adjust or remove the rear seat head restraint if it is difficult to install the child seat with the head restraint in place ⇒ *page 56*. Install the head restraint again immediately once the child seat is removed. Driving without head restraints or with head restraints that are not properly adjusted increases the risk of serious or fatal neck injury dramatically.
- Always read and heed all WARNINGS whenever using a child restrained in a vehicle is being used ⇒ *page 140, Safety belts*, ⇒ *page 148, Airbag system* and ⇒ *page 172, Important information*.

### WARNING

If exceptional circumstances require the use of a forward-facing child restraint on the front passenger's seat, the child's safety and well-

being require that the following special precautions be taken:

- Make sure the forward-facing seat has been designed and certified by its manufacturer for use on a front seat with a passenger front and side airbag.
- Always follow the manufacturer's instructions provided with the child safety seat or infant carrier.
- Always move the front passenger seat into the rearmost position of the passenger seat's fore and aft adjustment range, and as far away from the airbag as possible before installing the child restraint.
- Always make sure that nothing prevents the front passenger's seat from being moved to the rearmost position in its fore and aft adjustment range.
- Always make sure the backrest is in an upright position.
- Never place or use any electrical device (such as a laptop, CD player, electronic games device, power inverter or seat heater for child seats) on the front passenger seat if the device is connected to the 12-volt socket or the cigarette lighter socket.
- If a seat heater has been retrofitted or otherwise added to the front passenger seat, never install any child restraint system on this seat.
- Make sure that there are no wet objects (such as a wet towel) and no water or other liquids on the front passenger seat cushion.
- Never place objects on the seat (such as a laptop, CD player, electronic games device, power inverter or seat heater for child seats). These may influence the electrical capacitance measured by the capacitive passenger detection system and can also fly around in an accident and cause serious personal injury.
- Make sure that the **PASSENGER AIR BAG OFF** light comes on and stays on all the time whenever the ignition is switched on.
- If the **PASSENGER AIR BAG OFF** light does not come on and stay on, immediately install the forward-facing child seat at a seating position on the rear seat and have the



airbag system inspected by your authorized Audi dealer.

- Take the child restraint off the front passenger seat and install it properly at one of the rear seat positions if the **PASSENGER AIR BAG OFF** light does not stay on whenever the ignition is switched on.

### Booster seats and safety belts

*Properly used booster seats can help protect children weighing between about 40 lbs. and 80 lbs. (18 kg and 36 kg) who are less than 4 ft. 9 in. (57 inches/1.45 meters) tall.*



**Fig. 142** Rear seat: child properly restrained in a booster seat

The vehicle's safety belts alone will not fit most children until they are at least 4 ft. 9 in. (57 inches/1.45 meters) tall and weigh about 80 lbs. (36 kg). Booster seats raise these children up so that the safety belt will pass properly over the stronger parts of their bodies and the safety belt can help protect them in a crash.

- ▶ Do not use the convertible locking retractor when using the vehicle's safety belt to restrain a child on a booster seat.
- ▶ The shoulder belt must lie as close to the center of the child's collar bone as possible and must lie flat and snug on the upper body. It must never lie across the throat or neck. The lap belt must lie across the pelvis and never across the stomach or abdomen. Make sure the belt lies flat and snug. Pull on the belt to tighten if necessary.
- ▶ If you must transport an older child in a booster seat on the front passenger seat, you can use the safety belt height adjustment to help adjust the shoulder portion properly.

- ▶ Secure unused safety belts on the rear seat  
⇒ page 177.

Children up to at least 8 years old (over 40 lbs or 18 kg) are best protected in child safety seats designed for their age and weight. Experts say that the skeletal structure, particularly the pelvis, of these children is not fully developed, and they must not use the vehicle safety belts without a suitable child restraint.

It is usually best to put these children in appropriate booster seats. Be sure the booster seat meets all applicable safety standards.

Booster seats raise the seating position of the child and reposition both the lap and shoulder parts of the safety belt so that they pass across the child's body in the right places. The routing of the belt over the child's body is very important for the child's protection, whether or not a booster seat is used. Children age 12 and under must always ride in the rear seat.

Children who are at least 4 ft. 9 in. (57 inches/1.45 meters) tall can generally use the vehicle's three point lap and shoulder belts. Never use the lap belt portion of the vehicle's safety belt alone to restrain any child, regardless of how big the child is. Always remember that children do not have the pronounced pelvic structure required for the proper function of lap belt portion of the vehicle's three point lap and shoulder belts. The child's safety absolutely requires that a lap belt portion of the safety belt be fastened snugly and as low as possible around the pelvis. Never let the lap belt portion of the safety belt pass over the child's stomach or abdomen.

In a crash, airbags must inflate within a blink of an eye and with considerable force. In order to do its job, the airbag needs room to inflate so that it will be there to protect the occupant as the occupant moves forward into the airbag.

A vehicle occupant who is out of position and too close to the airbag gets in the way of an inflating airbag. When an occupant is too close, he or she will be struck violently and will receive serious or possibly even fatal injury. ▶



In order for the airbag to offer protection, it is important that all vehicle occupants, especially any children, who must be in the front seat because of exceptional circumstances, be properly restrained and as far away from the airbag as possible. By keeping room between the child's body and the front of the passenger compartment, the airbag can inflate completely and provide supplemental protection in certain frontal collisions.

### **WARNING**

Not using a booster seat, using the booster seat improperly, incorrectly installing a booster seat or using the vehicle safety belt improperly increases the risk of serious personal injury and death in a collision or other emergency situation. To help reduce the risk of serious personal injury and/or death:

- The shoulder belt must lie as close to the center of the child's collar bone as possible and must lie flat and snug on the upper body. It must never lie across the throat or neck. The lap belt must lie across the pelvis and never across the stomach or abdomen. Make sure that the belt lies flat and snug. Pull on the belt to tighten if necessary.
- Failure to properly route safety belts over a child's body will cause severe injuries in an accident or other emergency situation ⇒ *page 140*.
- The rear side of the child safety seat should be positioned as close as possible to the backrest on the vehicle seat.
- For adjustable head restraints: adjust or remove the rear seat head restraint if it is difficult to install the child seat with the head restraint in place ⇒ *page 56*. Install the head restraint again immediately once the child seat is removed. Driving without head restraints or with head restraints that are not properly adjusted increases the risk of serious or fatal neck injury dramatically.
- Children on the front seat of any car, even with Advanced Airbags, can be seriously injured or even killed when an airbag inflates.
- Never let a child stand or kneel on any seat, for example the front seat.

- Never let a child ride in the cargo area of your vehicle.
- Always remember that a child leaning forward, sitting sideways or out of position in any way during an accident can be struck by a deploying airbag. This will result in serious personal injury or death.
- If you must install a booster seat on the front passenger seat because of exceptional circumstances the **PASSENGER AIR BAG OFF** light must come on and stay on, whenever the ignition is switched on.
- If the **PASSENGER AIR BAG OFF** light does not come on and stay on, perform the checks described ⇒ *page 160, Monitoring the Advanced Airbag System*.
- Take the child restraint off the front passenger seat and install it properly at one of the rear seat positions if the **PASSENGER AIR BAG OFF** light does not stay on whenever the ignition is switched on.
- Always read and heed all WARNINGS whenever using a child restrained in a vehicle is being used ⇒ *page 140, Safety belts*, ⇒ *page 148, Airbag system* and ⇒ *page 172, Important information*.

## Securing child seats

### Securing a child safety seat using a safety belt

*Safety belts for the rear seats and the front passenger can be locked with the convertible locking retractor to properly secure child safety seats.*

The safety belts emergency locking retractors for the rear seats safety belts and for the front passenger's seat safety belt have a convertible locking retractor for child restraints. The safety belt must be locked so that belt webbing cannot unreel. The retractor can be activated to lock the safety belt and prevent the safety belt webbing from loosening up during normal driving. A child safety seat can only be properly installed when the safety belt is locked so that the child and child safety seat will stay in place.

Always remember: Even though your vehicle is equipped with an Advanced Airbag system, all



children, especially those 12 years and younger, should always ride in the back seat properly restrained for their age and size.

### **WARNING**

Improperly installed child safety seats increase the risk of serious personal injury and death in a collision.

- Always make sure that the safety belt retractor is locked when installing a child safety seat. An unlocked safety belt retractor cannot hold the child safety seat in place during normal driving or in a crash.
- Always buckle the child safety seat firmly in place even if a child is not sitting in it. A loose child safety seat can fly around during a sudden stop or in a collision.
- Always make sure that the rear seat backrest to which the center rear safety belt\* is attached is securely latched whenever the rear center safety belt is being used to secure a child restraint.
- If the backrest is not securely latched, the child and the child restraint will be thrown forward together with the backrest and will strike parts of the vehicle interior. The child can be seriously injured or killed.
- Never install rear-facing child safety seats or infant carriers on the front passenger seat. A child will be seriously injured and can be killed when the passenger airbag inflates.
- The inflating airbag will hit the child safety seat or infant carrier with great force and will smash the child safety seat and child against the backrest, center armrest, door or roof.
- Always install rear-facing child safety seats or infant carriers on the rear seat.
- Forward-facing child safety seats or infant carriers installed on the front passenger's seat may interfere with the deployment of the airbag and cause serious injury to the child.
- It is safer to install a forward-facing child safety seat on the rear seat.
- Always read and heed all WARNINGS whenever using a child restrained in a vehicle is being used ⇒ *page 172*. Special precautions

apply when installing a child safety seat on the front passenger seat ⇒ *page 149, Child restraints on the front seat – some important things to know*.

### **WARNING**

Always take special precautions if you must install a forward or rearward-facing child restraint on the front passenger's seat in exceptional situations:

- Whenever a forward or rearward-facing child restraint is installed on the front passenger seat, the **PASSENGER AIR BAG OFF** light must come on and stay on whenever the ignition is switched on.
- If the **PASSENGER AIR BAG OFF** light does not come on and stay on, perform the checks described ⇒ *page 160, Monitoring the Advanced Airbag System*.
- Take the child restraint off the front passenger seat and install it properly at one of the rear seat positions if the **PASSENGER AIR BAG OFF** light does not stay on whenever the ignition is switched on.
- Improper installation of child restraints can reduce their effectiveness or even prevent them from providing any protection.
- An improperly installed child restraint can interfere with the airbag as it deploys and seriously injure or even kill the child.
- Always carefully follow the manufacturer's instructions provided with the child safety seat or carrier.
- After checking to make sure that the child restraint is properly installed, make certain that the child restraint is correctly recognized by the capacitive passenger detection system in the front passenger seat and that the **PASSENGER AIR BAG OFF** light signals the correct front passenger frontal airbag status.

### **WARNING**

Forward-facing child restraints: ►



- Always make sure the forward-facing seat has been designed and certified by its manufacturer for use on a front seat with a passenger front and side airbag.
- Never put the forward-facing child restraint up, against or very near the instrument panel.
- Always move the passenger seat into its rearmost position in the seat's fore and aft adjustment range, as far away from the airbag as possible before installing the forward-facing child restraint. The backrest must be adjusted to an upright position.
- Make sure that the **PASSENGER AIR BAG OFF** light comes on and stays on all the time whenever the ignition is switched on.

### **WARNING**

Rearward-facing child restraints:

- A child in a rearward-facing child safety seat installed on the front passenger seat will be seriously injured and can be killed if the front airbag inflates - even with an Advanced Airbag System.
- The inflating airbag will hit the child safety seat or infant carrier with great force and will smash the child safety seat and child against the backrest, center armrest, door or roof.
- Always be especially careful if you must install a rearward facing child safety seat on the front passenger seat in exceptional circumstances.
- Make sure that the **PASSENGER AIR BAG OFF** light comes on and stays on all the time whenever the ignition is switched on.
- If the **PASSENGER AIR BAG OFF** light does not come on and stay on, immediately install the rear-facing child safety seat in a rear seating position and have the airbag system inspected by your Audi dealer.

### **Activating the convertible locking retractor**

*Use the convertible locking retractor to secure a child restraint.*

Always heed the child safety seat manufacturer's instructions when installing a child restraint in your vehicle. To activate the convertible locking retractor:

- ▶ Place the child restraint on a seat, preferably on the rear seat.
- ▶ Slowly pull the belt **all the way out**.
- ▶ Route it around or through the child restraint belt path ⇒ .
- ▶ Push the child safety seat down with your full weight to get the safety belt really tight.
- ▶ Insert the belt tongue into the buckle for that seating position.
- ▶ Guide the safety belt back into the retractor until the belt lies flat and snug on the child safety seat.
- ▶ You should hear a “clicking” noise as the belt winds back into the inertia reel. Test the convertible locking retractor by pulling on the belt. You should no longer be able to pull the belt out of the retractor. The convertible locking retractor is now activated.
- ▶ Make sure that the red release button is facing away from the child restraint so that it can be unbuckled quickly.
- ▶ Pull on the belt to make sure the safety belt is properly tight and fastened so that the seat cannot move forward or sideways more than one inch (2.5 cm).

### **WARNING**

Using the wrong child restraint or an improperly installed child restraint can cause serious personal injury or death in a crash.

- Always make sure that the safety belt retractor is locked when installing a child safety seat. An unlocked safety belt retractor cannot hold the child safety seat in place during normal driving or in a crash.
- Always buckle the child safety seat firmly in place even if a child is not sitting in it. A loose child safety seat can fly around during a sudden stop or in a crash.



- Always make sure the seat backrest to which the child restraint is installed is in an upright position and securely latched into place and cannot fold forward. Otherwise, the seatback with the child safety seat attached to it could fly forward in the event of an accident or other emergency situation.
- Always read and heed all WARNINGS whenever using a child restrained in a vehicle is being used ⇒ *page 172*. Special precautions apply when installing a child safety seat on the front passenger seat ⇒ *page 149, Child restraints on the front seat – some important things to know*.

### Deactivating the convertible locking retractor

*The convertible locking retractor for child restraints will be deactivated automatically when the belt is wound all the way back into the retractor.*

- ▶ Press the red button on the safety belt buckle. The belt tongue will pop out of the buckle.
- ▶ Guide the safety belt all the way back into its stowed position.

Always let the safety belt retract completely into its stowed position. The safety belt can now be used as an ordinary safety belt without the convertible locking retractor for child restraints.

If the convertible locking retractor should be activated inadvertently, the safety belt must be unfastened and guided completely back into its stowed position to deactivate this feature. If the convertible locking retractor is not deactivated, the safety belt will gradually become tighter and uncomfortable to wear.

#### **WARNING**

Improperly installed child safety seats increase the risk of serious personal injury and death in a collision.

- Never unfasten the safety belt to deactivate the convertible locking retractor for child restraints while the vehicle is moving. You

would not be restrained and could be seriously injured in an accident.

- Always read and heed all WARNINGS whenever using a child restrained in a vehicle is being used ⇒ *page 172*. Special precautions apply when installing a child safety seat on the front passenger seat ⇒ *page 149, Child restraints on the front seat – some important things to know*.

## LATCH system (Lower anchorages and tethers for children)

### Child Restraint System anchors and how are they related to child safety

To provide a simpler and more practicable way to attach the child restraint on the vehicle seat, Federal regulations require special lower anchorages in vehicles and devices on new child restraints to attach to the vehicle anchorages.

The combination of the tether anchorages and the lower anchorages is now generally called the **LATCH** system for “**L**ower **A**nchorages and **T**ethers for **C**hildren.”

Forward-facing child restraints manufactured after September 1, 1999, are required by U.S. federal regulations to comply with new child head movement performance requirements. These new performance requirements make a tether necessary on most new child seats.

Installing a child restraint that requires a top tether without one can seriously impair the performance of the child restraint and its ability to protect the child in a collision. Installing a child restraint that requires a top tether without the top tether may be a violation of state law.

Child restraint manufacturers offer LATCH lower anchorages on their child seats with hook-on or push-on connectors attached to adjustable straps.

In addition to the LATCH lower anchorages, these child restraint systems usually require the use of tether straps to help keep the child restraint firmly in place. ▶



**! WARNING**

Improper installation of child restraints will increase the risk of injury and death in a crash.

- Always follow the instructions provided by the manufacturer of the child restraint you intend to install in your vehicle.
- Never install a child restraint without a properly attached top tether strap if the child restraint manufacturer's instructions require the top tether strap to be used.
- Improper use of child restraint LATCH lower anchorage points can lead to injury in a collision. The LATCH lower anchorage points are designed to withstand only those loads imposed by correctly fitted child restraints.
- Never mount two child restraint systems on one LATCH lower anchorage point.
- Never secure or attach any luggage or other item to the LATCH lower anchorages.

**i Tips**

- In Canada, the terms “top tether” with “lower universal anchorages” (or “lower universal anchorage bars”) are used to describe the system.
- In other countries, the term “ISOFIX” is used to describe the lower anchorages.

**Location**

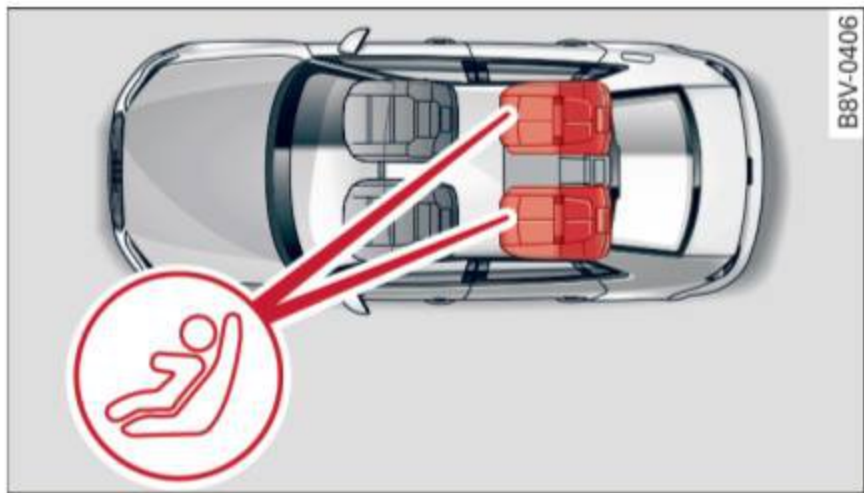
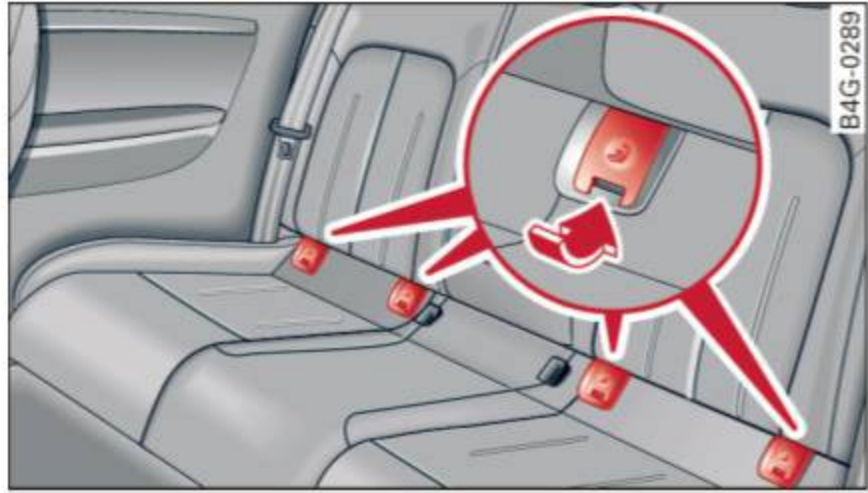

**Fig. 143** Schematic overview: LATCH anchorage point locations

The illustration shows the seating locations in your vehicle which are equipped with the lower anchorages system.

**Description**

The lower anchorage positions are marked for quick locating.



**Fig. 144** Lower anchorages, covers marked

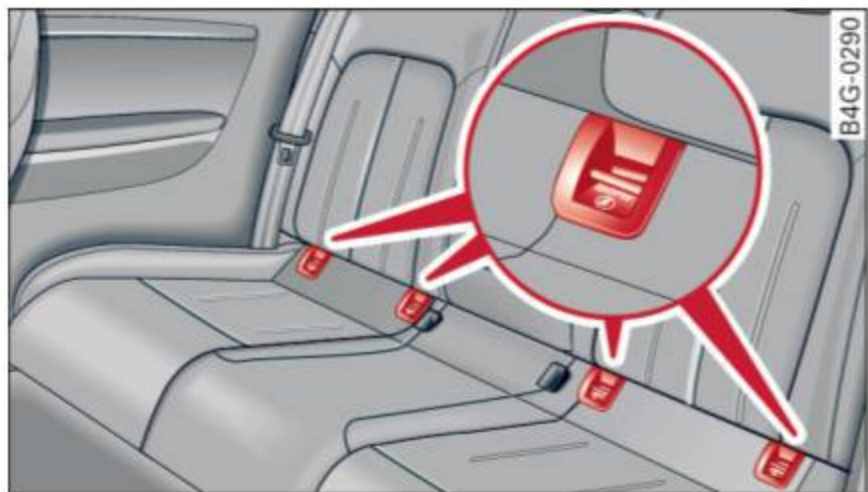

**Fig. 145** Rear seats: lower anchorage bracket locations

**Lower anchorages**

The circular markings on the rear seat help you to identify the location of lower anchorages for the two outboard seating positions ⇒ *fig. 144*. The LATCH lower universal anchorage attachment points are between the rear seatback and rear seat cushion.

Remove the covers ⇒ *fig. 144* to access the lower anchorage attachment points.

The lower anchorage attachment points are visible ⇒ *fig. 145*.

Lower anchorages secure the child restraint in the seat without using the vehicle's safety belts. Anchorages provide a secure and easy-to-use attachment and minimize the possibility of improper child restraint installation.

All child restraints manufactured after September 1, 2002, must have lower anchorage attachments for the LATCH system.



Please remember that the lower anchorage points are only intended for installation and attachment of child restraints specifically certified for use with *LATCH* lower anchorages. Child restraints that are not equipped with the lower anchorage attachments can still be installed in compliance with the child restraint manufacturer's instructions on using vehicle safety belts.

### WARNING

Improper use of *LATCH* lower anchorages can cause serious personal injury in an accident.

- Always carefully follow the child restraints manufacturer's instructions for proper installation of the child restraint and proper use of the lower anchorages or safety belts in your vehicle.
- Never secure or attach any luggage or other items to the *LATCH* lower anchorages.
- Always read and heed the important information about child restraints in this chapter and WARNINGS ⇒ page 172, *Child safety*.

### Installing a child restraint with *LATCH* lower anchorages

Applies to vehicles: with top tether

*Whenever you install a child restraint always follow the child restraint manufacturer's instructions.*

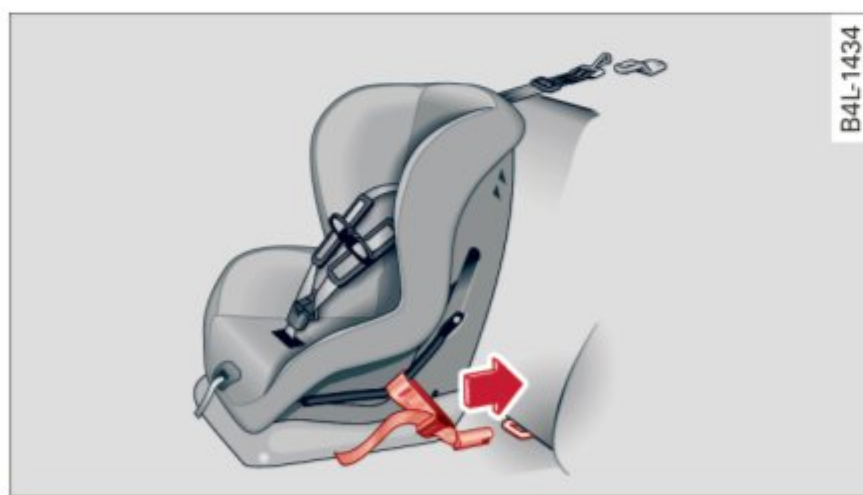

Fig. 146 Lower anchorages: proper mounting

### Mounting

- ▶ Make sure the seatback of the rear seat bench is in the upright position and securely latched in place.
- ▶ Attach both hook-on connectors with the spring catch release on the child safety seat onto the

*LATCH* lower anchorage so that the connectors lock into place ⇒ fig. 146.

- ▶ Pull on the connector attachments to make sure they are properly attached to the *LATCH* lower anchorage.
- ▶ Pull straps tight following the child restraint manufacturer's instructions.

### Releasing

- ▶ Loosen the tension on the straps following the child restraint manufacturer's instructions.
- ▶ Depress the spring catches to release the anchorage hooks from the lower anchorages.

Remember: Use tether straps to help keep the child restraint firmly in place.

### WARNING

Improper use of the *LATCH* system can increase the risk of serious personal injury and death in an accident.

- These anchors were developed only for child safety seats using the “*LATCH*” system.
- Never attach other child safety seats, belts or other objects to these anchors.
- Always make sure that you hear a click when latching the seat in place. If you do not hear a click the seat is not secure and could fly forward and hit the interior of the vehicle, or be ejected from the vehicle.

### WARNING

Improper installation of child restraints will increase the risk of injury in an accident.

- Always follow the child restraint system manufacturer's instructions for proper installation of the child restraint system and proper use of tether straps as well as the lower anchorages or safety belts in your vehicle.
- Always read and heed the important information and WARNINGS about child safety and the installation of child restraint systems ⇒ page 172, *Child safety*.



### Tether anchors and tether straps

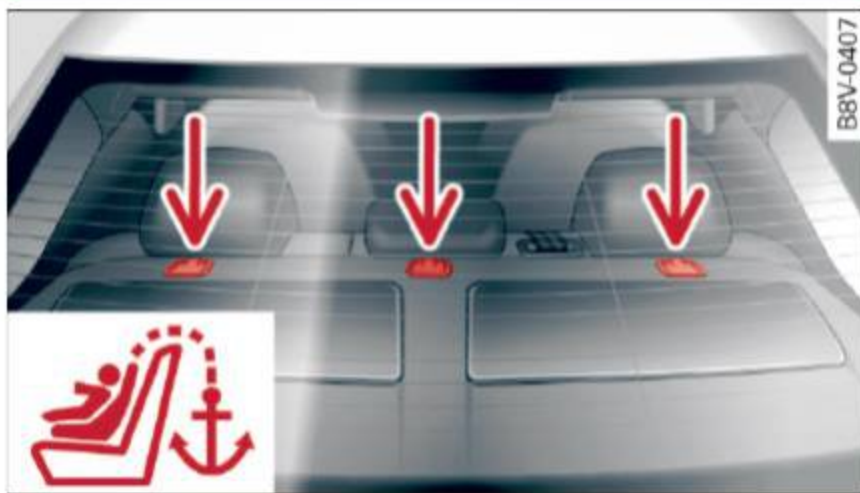

Fig. 147 Tether anchors: recess flaps behind the rear seat-backs

The tether anchors for the rear seating positions are located in recesses in the rear window shelf ⇒ *fig. 147*

A tether is a straight or V-shaped strap that attaches the top part of a child restraint to special anchorage points in the vehicle.

The purpose of the tether is to reduce the forward movement of the child restraint in a crash, in order to help reduce the risk of head injury that could be caused by striking the vehicle interior.

Forward facing child restraints manufactured after September 1, 1999, are required by U.S. federal regulations to comply with new child head movement performance requirements. These new performance requirements make a tether necessary on most new child safety seats.

#### **WARNING**

Improper installation of child restraints will increase the risk of injury and death in a crash.

- Always follow the instructions provided by the manufacturer of the child restraint you intend to install in your Audi.
- Improper use of child restraint anchors (including tether anchors) can lead to injury in a collision. The anchors are designed to withstand only those loads imposed by correctly fitted child restraints.
- Never mount two child restraint systems on one LATCH lower anchor point.
- Never attach two child restraint systems to one tether strap or tether anchorage.

- Never attach a tether strap to a tie-down hook in the luggage compartment.
- Never use child restraint tether anchorages to secure safety belts or other kinds of occupant restraints.
- Never secure or attach any luggage or other items to the LATCH lower anchorages or to the tether anchors.
- If you must install a rearward facing child safety seat on the front passenger seat because of exceptional circumstances and the **PASSENGER AIR BAG OFF** light does not come on and stay on, immediately install the rear-facing child safety seat in a rear seating position and have the airbag system inspected by your Audi dealer.

### Installing the upper tether strap on the anchorage

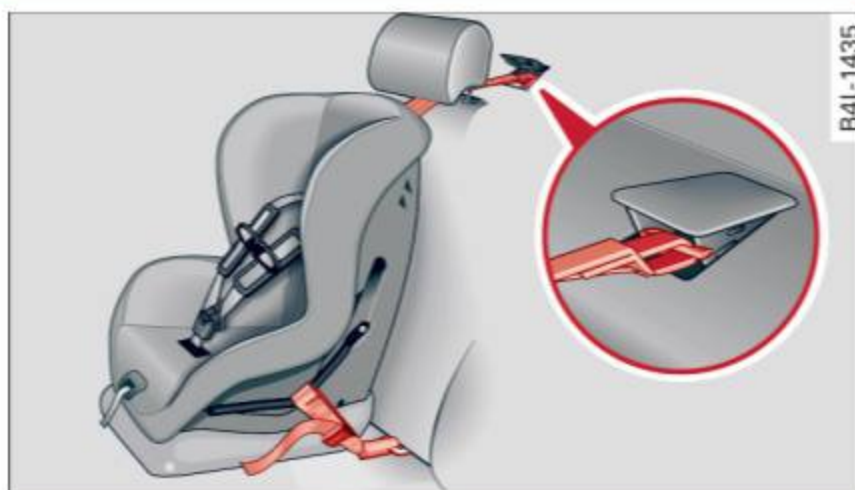

Fig. 148 Tether strap: proper routing and mounting

#### Installing the tether strap

- ▶ Release or deploy the tether strap on the child restraint according to the child restraint manufacturer's instructions.
- ▶ Guide the upper tether strap **under** the rear head restraint ⇒ *fig. 148* (raise the head restraint if necessary).
- ▶ Tilt the recess flap up to expose the anchor bracket.
- ▶ Attach the tether strap anchorage hook into the opening of the tether anchorage.
- ▶ Pull on the tether strap hook so that the spring catch of the hook engages.
- ▶ Tighten the tether strap firmly following the child restraint manufacturer's instructions. ▶



## Releasing the tether strap

- ▶ Loosen the tension following the child restraint manufacturer's instructions.
- ▶ Depress the spring catch on the hook and release it from the anchorage.

### Note

If you leave the child restraint with the tether strap firmly installed for several days, this could leave a mark on the upholstery on the seat cushion and backrest in the area where the tether strap was installed. The upholstery would also be permanently stretched around the tether strap. This applies especially to leather seats.

## Using tether straps on rearward-facing child restraints

Currently, few rear-facing child restraint systems come with a tether. Please read and heed the child restraint system manufacturer's instructions carefully to determine how to properly install the tether.

### WARNING

A child in a rearward-facing child safety seat installed on the front passenger seat will be seriously injured and can be killed if the front airbag inflates - even with an Advanced Airbag System.

- The inflating airbag will hit the child safety seat or infant carrier with great force and will smash the child safety seat and child against the backrest, center armrest, or door.
- If you must install a rearward facing child safety seat on the front passenger seat because of exceptional circumstances and the **PASSENGER AIR BAG OFF** light does not come on and stay on, immediately install the rear-facing child safety seat in a rear seating position and have the airbag system inspected by your Audi dealer.

## Additional information

### Sources of information about child restraints and their use

There are a number of sources of additional information about child restraint selection, installation and use:

NHTSA advises that the best child safety seat is the one that fits your child and fits in your vehicle, and that you will use correctly and consistently.

Try before you buy!

#### U.S National Highway Traffic Safety Administration

Tel.: 1-888-327-4236 (TTY: 1-800-424-9153)  
www.nhtsa.gov

#### National SAFE KIDS Campaign

Tel.: (202) 662-0600  
www.safekids.org

#### Safety BeltSafe U.S.A

Tel.: (800) 745-SAFE (English)  
Tel.: (800) 747-SANO (Spanish)  
www.carseat.org

#### Transport Canada Information Centre

Tel.: 1-800-333-0371 or call 1-613-998-8616 if you are in the Ottawa area  
<http://www.tc.gc.ca/eng/roadsafety/menu.htm>

#### Audi Customer Relations

Tel.: (800) 822-2834



# Checking and Filling

## Gasoline

### Fuel supply

Applies to vehicles: with gasoline engine

*Using the right fuel helps keep the environment clean and prevents engine damage.*

### Fuel recommendation

The fuel recommended for your vehicle is **unleaded premium** grade gasoline. Audi recommends using TOP TIER Detergent Gasoline with a minimum octane rating of 91 AKI (95 RON). For more information on TOP TIER Detergent Gasoline, please go to the official website ([www.toptiergas.com](http://www.toptiergas.com)).

The recommended gasoline octane rating for your engine can also be found on a label located on the inside of the fuel filler flap. This rating may be specified as AKI or RON.

Your vehicle may also be operated using unleaded regular gasoline with a minimum octane rating of 87 AKI/91 RON. However, using 87 AKI/91 RON octane fuel will slightly reduce engine performance.

**Use unleaded gasoline only.** Unleaded gasoline is available throughout the USA, Canada, and in most European countries. We recommend that you do not take your vehicle to areas or countries where unleaded gasoline may not be available.

For more information on refueling your vehicle, see ⇒ *page 192*.

### Octane rating

Octane rating indicates a gasoline's ability to resist engine damaging "knock" caused by premature ignition and detonation. Therefore, buying the correct grade of gasoline is very important to help prevent possible engine damage and a loss of engine performance.

Gasoline most commonly used in the United States and Canada has the following octane ratings that can usually be found on the filler pump:

– Premium Grade: 91 - 96 AKI

– Regular Grade: 87 - 90 AKI

Explanation of the abbreviations:

AKI = **Anti Knock Index** =  $(R+M)/2 = (RON+MON)/2$

RON = **Research Octane Number**

MON = **Motor Octane Number**.

### Note

- Do not use any fuel with octane ratings lower than 87 AKI or 91 RON otherwise expensive engine damage will occur.
- Do **not** use leaded gasoline. The use of leaded gasoline will severely damage your vehicle's catalytic converter and its ability to control exhaust emissions.

### Blended gasoline

Applies to vehicles: with gasoline engine

#### Use of gasoline containing alcohol or MTBE (methyl tertiary butyl ether)

You may use unleaded gasoline blended with alcohol or MTBE (commonly referred to as oxygenates) if the blended mixture meets the following criteria:

#### Blend of gasoline methanol (wood alcohol or methyl alcohol)

- Anti-knock index must be 87 AKI or higher.
- Blend must contain no more than 3% methanol.
- Blend must contain more than 2% co-solvents.

#### Blend of gasoline and ethanol (grain alcohol or ethyl alcohol)

- Anti-knock index must be 87 AKI or higher.
- Blend must not contain more than 15% ethanol.

#### Blend of gasoline and MTBE

- Anti-knock index must be 87 AKI or higher.
- Blend must contain not more than 15% MTBE.

#### Seasonally adjusted gasoline

Many gasoline grades are blended to perform especially well for winter or summer driving. During seasonal change-over, we suggest that you



fill up at busy gas stations where the seasonal adjustment is more likely to be made in time.

### Note

- Methanol fuels which do not meet these requirements may cause corrosion and damage to plastic and rubber components in the fuel system.
- Do not use fuels that fail to meet the specified criteria in this chapter.
- If you are unable to determine whether or not a particular fuel blend meets the specifications, ask your service station or its fuel supplier.
- Do not use fuel for which the contents cannot be identified.
- Fuel system damage and performance problems resulting from the use of fuels different from those specified are not the responsibility of Audi and are not covered under the New Vehicle or the Emission Control System Warranties.
- If you experience a loss of fuel economy or driveability and performance problems due to the use of one of these fuel blends, we recommend that you switch to unblended fuel.

## Gasoline additives

A major concern among many auto manufacturers is carbon deposit build-up caused by the type of gasoline you use.

Although gasoline grades differ from one manufacturer to another, they have certain things in common. All gasoline grades contain substances that can cause deposits to collect on vital engine parts, such as fuel injectors and intake valves. Although most gasoline brands include additives to keep engine and fuel systems clean, they are not equally effective.

Audi recommends using TOP TIER Detergent Gasoline. For more information on TOP TIER Detergent Gasoline, please go to the official website ([www.toptiergas.com](http://www.toptiergas.com)).

After an extended period of using inadequate fuels, carbon deposit build-ups can rob your engine of peak performance.

### Note

Damage or malfunction due to poor fuel quality is not covered by the Audi New Vehicle Limited Warranty.

## Diesel fuel

Applies to vehicles: with diesel engine

Always use ULSD (Ultra Low Sulfur Diesel) No. 2. The ULSD No. 2 meets the ASTM D975.

Diesel fuel with concentrations of biodiesel higher than 5 % such as B11, B20 or B100 are strictly prohibited.

Service station fuel pumps are labeled with the correct fuel information for easy recognition by the user. If the diesel fuel pump is not labeled ask the station operator what fuel is being dispensed before filling up your vehicle.

ULSD No. 2 may not be available outside the USA and Canada. Be sure to check before traveling to other countries.

ULSD No. 2 can become thicker in very cold temperatures, and this can impair the engine's starting and running. Depending on the season, gas stations provide ULSD No. 2 that flows better in cold temperatures so that you can continue operating your vehicle as usual.

### Note

- Your vehicle's diesel engine was designed solely for use with ULSD No. 2. Therefore, never use gasoline, heating oil, other fuels or flow improvers. These contain substances that will severely damage the fuel system and the engine. Such damage will not be covered by your New Vehicle Limited Warranty.
- If you put any amount of incorrect fuel in the fuel tank, do not start the engine under any circumstances. Immediately contact the nearest authorized Audi dealer or authorized Audi Service Facility for assistance.



These fuels contain substances that can severely damage the fuel system and the engine if the engine is started.

- If the diesel fuel quality is poor, it may be necessary to have the water drained from the water separator in the **fuel filter** more often than specified in the maintenance schedule. This can help reduce engine malfunctions ⇒ *page 23*.

## Refueling

### Fuel filler neck

The fuel filler neck is located on the right rear side panel behind the fuel filler flap.

If the power locking system should fail, you can still open the flap manually - for detailed instructions see ⇒ *page 194*.

You can find the fuel tank capacity of your vehicle in ⇒ *page 260*.

The label on the inside of the fuel filler flap tells you the correct fuel for your vehicle. For more information about fuel specifications, see ⇒ *page 190*.

Your vehicle fuel tank has an onboard refuelling vapor recovery system. This feature helps to prevent fuel vapors from escaping from the tank and polluting the environment while you refuel your vehicle. In order to fill the tank properly while protecting the environment, please follow this refueling procedure carefully.

### WARNING

Under normal operating conditions, never carry additional fuel containers in your car. Gas canisters and other containers used to transport fuel can be dangerous. Such containers, full or empty, may leak and could cause a fire in a collision. If you must transport fuel to use for your lawn mower, snow blower, etc., be very careful and always observe local and state laws regarding the use, transportation and storage of such fuel containers. Make certain the container meets industry standards (ANSI/ASTM F852 - 86).

### Note

Never drive your vehicle until the fuel tank is completely empty. The irregular supply of fuel can cause misfiring. Gasoline could enter the exhaust system and damage the catalytic converter.

### Fueling procedure



**Fig. 149** Right rear vehicle side: opening the fuel filler door



**Fig. 150** Fuel filler door with attached fuel cap

Read and follow the information and warnings when filling AdBlue ⇒ *page 195*.

The fuel filler door is unlocked or locked by the central locking system.

### Opening the fuel flap

- ▶ Press the left side of the fuel filler door to open it -arrow- ⇒ *fig. 149*.
- ▶ Unscrew the tank cap counterclockwise.
- ▶ Place the cap from above on the open fuel filler door ⇒ *fig. 150*.

### Closing the fuel cap

- ▶ Turn the fuel cap clockwise until you hear it lock.
- ▶ Close fuel filler door until it latches.



Once the pump nozzle switches off, the fuel tank is “full”. Do not fill the tank more. Otherwise the expansion space in the tank will be filled.

The correct fuel type for your vehicle can be found on a label located on the inside of the fuel filler door. For additional information on fuel, refer to ⇒ *page 190*.

The fuel tank capacity of your vehicle is in the **Technical Data** ⇒ *page 260*.

To avoid fuel spilling or evaporating from the fuel tank always close fuel filler cap properly and completely. An improperly closed fuel filler cap may also cause the MIL lamp ⇒ *page 25* to come on.

 **WARNING**

Not paying attention when fueling or handling fuel incorrectly can lead to fires, explosions or serious injuries.

- Fuel ignites easily and can cause serious burns and other injuries.
- If you do not switch the engine off when fueling and/or do not insert the fuel nozzle completely into the tank opening, fuel can leak out or run over. Leaked fuel can ignite and start a fire.
- Do not use the telephone while fueling. The electromagnetic rays can cause sparks, which can ignite fuel vapors and start a fire.
- Do not sit in your vehicle while fueling. If you must make an exception and enter your vehicle again while fueling, close the door and touch metal to discharge static electricity before touching the fuel nozzle. Static electricity can create sparks, which can ignite vapors when fueling.
- Do not smoke or have an open flame in the area when fueling your vehicle or filling a fuel container because this increases the risk of an explosion.
- For your safety, carrying fuel containers in your vehicle is not recommended. Whether full or empty, the container can leak and cause a fire in the event of an accident.
- If you must make an exception and transport a fuel container, note the following:

- Never fill the fuel container with fuel while it is in or on the vehicle. Static electricity is discharged when filling which can cause the fuel vapors to ignite and increases the risk of an explosion.
- Always place a fuel container on the ground before filling.
- Always hold the fuel nozzle completely in the fuel container when filling.
- If the fuel container is made of metal, the fuel nozzle must always be in contact with the container when filling it with fuel. This prevents static electricity from discharging.
- Never spill fuel in the vehicle or the luggage compartment. Evaporated fuel is explosive and increases the risk of serious injury or death.
- Follow legal requirements when using, storing and transporting fuel containers.
- Make sure the fuel container conforms to industry standards (ANSI/ASTM F852-86).

 **Note**

- Remove spilled fuel from vehicle paint immediately, because it can damage paint.
- Never drive until the fuel tank is completely empty. The irregular supply of fuel that results from that can cause engine misfires. Uncombusted fuel will enter the exhaust system and increase the risk of damage to the catalytic converter.
- If the fuel tank runs completely empty in a vehicle with a **diesel engine**, the ignition must remain switched on for at least 30 seconds after refueling before starting the engine. It may take longer than usual for the engine to start, even up to a minute. This is because the air must first bleed out of the fuel system when starting the engine.

 **For the sake of the environment**

- If the fuel nozzle is used correctly, it will indicate that the tank is full the first time it switches off automatically. Do not try to add more fuel, because it can spill over. Also,



the expansion space in the tank will fill, which can result in fuel spilling out when it becomes warm and polluting the environment.

### **i** Tips

- If the engine is running while fueling, vapors can escape or the fuel can spill over. Because of this, the fuel nozzle switches off before the tank is full.
- Do not fuel the vehicle when the ignition is switched on. Otherwise, the fuel gauge may not show the correct level after fueling the vehicle.
- Diesel vehicles are equipped with a diesel misfueling guard <sup>1)</sup>. It allows the vehicle to be fueled only with a diesel fuel pump nozzle.
- A worn or damaged nozzle or a nozzle that is too small may not be able to open the diesel misfueling protector. If this is the case, try turning the nozzle before inserting it in the fuel filler neck, use a different fuel pump or see an authorized Audi dealer or authorized Audi Service Facility for assistance.
- The misfueling guard does not open when adding fuel from a fuel container. You can bypass it by adding the diesel fuel slowly.
- The fuel filler door on your vehicle does not lock when you lock the vehicle from the inside.

### Fuel filler door emergency release

*If the central locking system is faulty, the fuel filler door can be unlocked manually.*



**Fig. 151** Right rear luggage compartment: emergency release

The emergency release mechanism is located behind the right side trim panel in the luggage compartment.

- ▶ Remove the cover in the side panel.
- ▶ Loosen the loop from the retainer and then pull on the loop carefully -arrow- ⇒ . The fuel filler door is released.
- ▶ To open the fuel filler door, press on the left side ⇒ *page 192, fig. 149*.

### **!** Note

Only pull on the loop until you feel resistance. You will not hear it release. Otherwise you could damage the emergency release mechanism.

## Catalytic converter

Applies to vehicles: with gasoline engine

*It is very important that your emission control system (catalytic converter) is functioning properly to ensure that your vehicle is running in an environmentally sound manner.*

- ▶ Always use lead-free gasoline ⇒ *page 190, Fuel supply*.
- ▶ Never run the tank down all the way to empty.
- ▶ Never put too much motor oil in your engine ⇒ *page 203, Adding engine oil* .
- ▶ Never try to push- or tow-start your vehicle. ▶

<sup>1)</sup> Market-specific



The catalytic converter is an efficient “clean-up” device built into the exhaust system of the vehicle. The catalytic converter burns many of the pollutants in the exhaust gas before they are released into the atmosphere.

The exclusive use of unleaded fuel is critically important for the life of the catalytic converter and proper functioning of the engine.

 **WARNING**

The temperature of the exhaust system is high, both when driving and after stopping the engine.

- Never touch the exhaust tail pipes once they have become hot. This could result in burns.
- Do not park or operate the vehicle in areas where the hot exhaust system may come in contact with dry grass, brush, fuel spill or other material which can cause a fire.
- Do not apply additional undercoating or rustproofing on or near the exhaust manifold, exhaust pipes, catalytic converter or heat shields. During driving, the substance used for undercoating could overheat and cause a fire.

 **Note**

- Be aware that just one tank filling with **lead-ed** fuel will already seriously degrade the performance of the catalytic converter.
- Do not exceed the correct engine oil level ⇒ *page 203*.
- Do not drive until the fuel tank becomes completely empty. The engine could misfire. Unburned fuel could also get into the exhaust system and this could cause the catalytic converter to overheat.
- Do not switch off the ignition while the vehicle is moving.
- Do not continue to operate your vehicle under these conditions, as otherwise fuel can reach the catalytic converter. This could result in overheating of the converter, requiring its replacement.
- To assure efficient operation of the Emission Control System:

- Have your vehicle maintained properly and in accordance with the service recommendations in your Warranty & Maintenance booklet.
- Lack of proper maintenance as well as improper use of the vehicle will impair the function of the emission control system and could lead to damage.

 **For the sake of the environment**

Even when the Emission Control System is operating properly, the exhaust gas can have a sulfur-like exhaust gas smell under some operating states. This depends on the sulfur content of the fuel being used. Using a different brand of fuel may help, or filling the tank with lead-free super grade gasoline.

## Diesel particulate filter

Applies to vehicles: with diesel engine

The diesel particulate filter filters nearly all of the soot particles out of the exhaust. The filter cleans itself automatically under normal driving conditions. If the filter cannot clean itself (for example, because you are only driving short distances), the filter becomes clogged with soot and the  symbol for the diesel particulate filter illuminates ⇒ *page 22*.

 **WARNING**

- Do not park your vehicle over flammable materials such as grass or leaves because the high temperature of the diesel particulate filter could start a fire.
- Do not apply an underbody protectant in the exhaust system area or a fire could start.

## Selective catalytic reduction

**General information**

Applies to vehicles: with diesel engine

In vehicles with selective catalytic reduction, a urea solution (AdBlue) is injected into the exhaust system before a nitrogen oxide catalytic converter to reduce nitrogen emissions. ►



AdBlue is the marketing name for Diesel Exhaust Fluid (DEF).

The AdBlue is carried in a separate tank in the vehicle. The AdBlue usage accounts for approximately 0.5% to 1.2% of the diesel fuel that is used.

When a message about refilling the AdBlue appears in the instrument cluster display, you must refill the AdBlue yourself or have it refilled by an authorized Audi dealer or authorized Audi Service Facility ⇒ *page 197*.

### WARNING

Failure to heed AdBlue refill information in the instrument cluster can prevent the vehicle from being started and driven. If the vehicle cannot be driven and an emergency arises, personal injury can occur.

- Always have the AdBlue tank refilled well before the tank runs dry.

### Tips

- The instrument cluster display indicates the distance remaining that can be driven ⇒ *page 196*. If the AdBlue tank is completely empty, the engine will not start again after the ignition is switched off.
- AdBlue is required by law to operate this vehicle.

## Messages in the instrument cluster display

Applies to vehicles: with diesel engine

*The display indicates if the AdBlue level is low or if there is a system malfunction.*

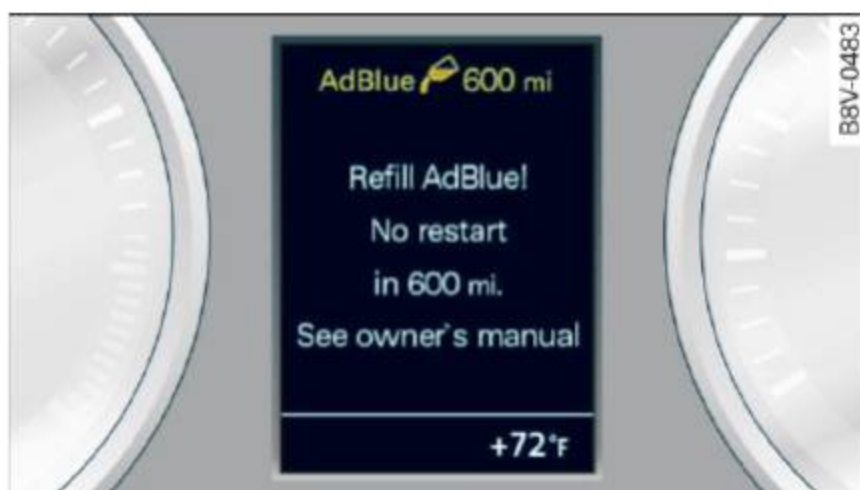



Fig. 152 Instrument cluster: indicator in the display

### AdBlue level low

You will be informed if the AdBlue in the tank drops below a certain level.

**AdBlue**  Please refill AdBlue. Range 1500 mi (2400 km)

This message appears when there is only enough AdBlue left to drive the distance indicated in the driver information system. Fill the AdBlue.

**AdBlue**  Refill AdBlue! No restart in 600 miles (1000 km)! See owner's manual

This message appears when there is only enough AdBlue left to drive the distance indicated in the driver information system. Fill the AdBlue. Otherwise the engine will not start again if you stop it once the distance indicated has been driven. As long as the **AdBlue**  indicator light is on, you can check the remaining range in the trip computer\*.

**AdBlue**  Refill AdBlue! Engine start not possible! See owner's manual

This message appears when the AdBlue tank is empty. Fill the AdBlue. Otherwise you will not be able to start the engine again once you stop it.

The AdBlue must be refilled when the amount in the tank has reached the minimum level ⇒ *page 197, Filling the AdBlue*.

### Incorrect filling/system malfunction

A message appears if the AdBlue tank was filled with a fluid other than AdBlue and the system has detected that the tank was filled incorrectly, or if there is a system malfunction.

**AdBlue**  AdBlue: System fault! No restart in 600 miles (1000 km). See owner's manual.

This message appears when it is only possible to drive the distance indicated in the driver information system. Drive to the nearest authorized Audi dealer or authorized Audi Service Facility to have the malfunction corrected. Otherwise the engine will not start again if you stop it once the distance indicated has been driven.

**AdBlue**  AdBlue: system fault. Engine start not possible! See owner's manual



This message appears if the system has detected that the tank was filled incorrectly or that there is a malfunction. Drive immediately to the nearest authorized Audi dealer or authorized Audi Service Facility to have the malfunction corrected. Otherwise you will not be able to start the engine again once you stop it.

### Filling the AdBlue

Applies to vehicles: with selective catalytic reduction

*A special refill bottle must be used to fill the AdBlue.*



Fig. 153 Right rear vehicle side: removing the AdBlue cap

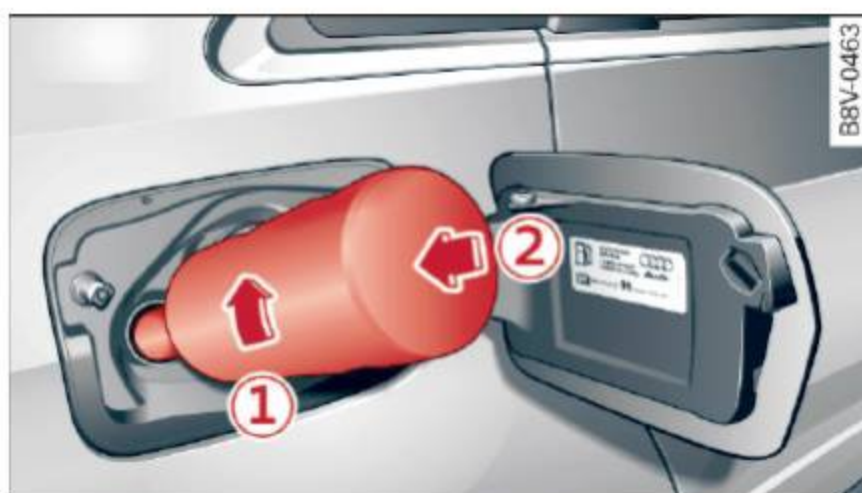

Fig. 154 AdBlue filler tube: inserting the refill bottle

The AdBlue tank opening is located near the diesel tank opening. Add at least 1 gallon (3.8 liters) of AdBlue (two bottles). This is the minimum amount required to ensure the system detects the refilling and to start the engine. You can add a maximum of approximately 4 gallons (15 liters).

### Opening the filler tube and adding AdBlue

Requirement: the request to add AdBlue must appear in the instrument cluster display.

- ▶ Park your vehicle on a level surface.
- ▶ switch the ignition off.

- ▶ Open the tank door ⇒ *page 192*.
- ▶ Turn the cap on the tank opening to the left to remove ⇒ *fig. 153*.
- ▶ Remove the cap from the refill bottle.
- ▶ Position the refill bottle on the filler tube and turn the bottle clockwise until it stops turning ① ⇒ *fig. 154*.
- ▶ Press lightly against the bottom of the bottle ② to empty it. Continue pressing the bottom of the bottle until it is empty or until fluid stops flowing into the tank.
- ▶ Turn the bottle to the left without pressing on the bottom.

### Closing the filler neck

- ▶ Turn the AdBlue cap to the right on the filler tube until the cap clicks into place.
- ▶ Close the tank cover.

### After filling

The vehicle must be driven. The system may take up to two minutes to detect that the AdBlue has been filled.

- ▶ If there was no AdBlue left in the tank and a range of **0 mi (0 km)** was displayed in the instrument cluster, switch the ignition on for about 30 seconds before starting the engine.

### ! WARNING

AdBlue can irritate the skin, eyes and respiratory system. If there is contact with the fluid, flush immediately with plenty of water. Consult a physician if necessary.

### ! Note

- Only use AdBlue that conforms to the standard ISO 22241-1. Do not mix any additives with the AdBlue and do not dilute it with water.
- Do not add AdBlue to the diesel tank or add diesel fuel to the AdBlue tank. Mixing can lead to damage to the engine and the AdBlue tank system. Warranty does not cover damage caused by this.
- AdBlue attacks surfaces such as painted vehicle components, plastic and carpet. Remove the fluid as quickly as possible with a



damp cloth and plenty of cold water. If the AdBlue has already crystallized, use warm water and a sponge. AdBlue residue that is not removed will crystallize and can damage the affected surface.

- Do not store the refill bottle in the vehicle. If it leaks, the escaping AdBlue could damage the vehicle interior.
- Do not allow AdBlue to come into contact with clothing. If there is contact with the fluid, flush immediately with plenty of water.

### Tips

- You can obtain refill bottles from an authorized Audi dealer or authorized Audi Service Facility.
- Follow the AdBlue manufacturer's instructions for use and storage.

## Engine compartment

### Working in the engine compartment

*Special care is required if you are working in the engine compartment*

**For work in the engine compartment such as checking and filling fluids, there is a risk of injury, scalding, accidents, and burns. For this reason, follow all the following listed warnings and general safety precautions. The engine compartment is a dangerous area! ⇒ ⚠**

### WARNING

To reduce the risk of injuries, complete the following steps before opening the hood:

- Turn the engine off.
- switch the ignition off.
- Set the parking brake.
- Place the selector lever in the P position.
- Let the engine cool down.
- Never open the hood when you see that steam or coolant drips from the engine compartment- there is a danger of burns! Wait until no steam or coolant flows out.
- Keep children away from the engine compartment.

- Never spill fluids on a hot engine. These fluids (such as the freeze protection contained in the coolant) can catch fire.
- Avoid short circuits in the electrical system, especially the battery.
- When working in the engine compartment, remember that the radiator fan can switch on even if the ignition is switched off, which increases the risk of personal injury.
- Never open the cap on the coolant expansion tank when the engine is warm. The cooling system is under pressure.
- To protect your face, hands, and arms from hot steam or coolant, cover the cap with a large cloth when opening.
- Do not remove the engine cover under any circumstances. This increases the risk of burns.
- If tests need to be performed with the engine running, there is additional danger due to moving components (such as the ribbed belt, alternator and radiator fan) and from the high voltage ignition system.
- Never reach into the radiator fan. The electric auxiliary fan is controlled by temperature and can switch on suddenly.
- Pay attention to the following warnings listed when work on the fuel system or on the electrical equipment is required.
  - Always disconnect the vehicle battery from the vehicle electrical system
  - Do not smoke
  - Never work near open flames
  - Always have a working fire extinguisher nearby
- To reduce the risk of electric shock and injury, never touch the following components when the engine is running or is being started:
  - Ignition cable
  - Other components in the electronic high voltage ignition system
- If you must check or perform work on the engine while it is running:
  - Set the parking brake and place the selector lever in the P (park) position first.



- Always proceed with extreme caution so that clothing, jewelry or long hair do not become caught in the radiator fan, fan belt or other moving components or do not come into contact with hot components. Tie back long hair before beginning work and do not wear clothing that can hang down into the engine.
- Limit your exposure to exhaust and chemicals to as short a time as possible ⇒ ⚠.

**⚠ WARNING**

California Proposition 65 Warning:

- Engine exhaust, some of its constituents, and certain vehicle components contain or emit chemicals known to the State of California to cause cancer and birth defects and reproductive harm. In addition, certain fluids contained in vehicles and certain products of component wear contain or emit chemicals known to the State of California to cause cancer and birth defects or other reproductive harm.
- Battery posts, terminals and related accessories contain lead and lead compounds, chemicals known to the State of California to cause cancer and reproductive harms. Wash hands after handling.

**! Note**

When filling fluids, be sure not to mix the fluids up. Otherwise severe malfunctions and engine damage will occur.

**🌳 For the sake of the environment**

You should regularly check the ground under your vehicle in order to detect leaks quickly. If there are visible spots from oil or other fluids, bring your vehicle to an authorized Audi dealer or authorized Audi Service Facility to be checked.

**Opening the hood**

The hood is released from the interior.

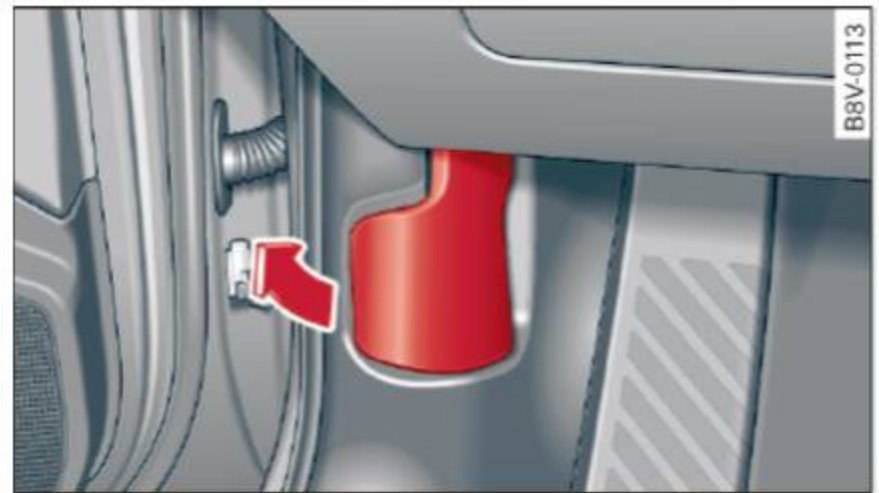

Fig. 155 Section from the driver's footwell: release lever



Fig. 156 Rocker switch under the hood

Make sure the wiper arms are not raised up from the windshield. Otherwise the paint could be damaged.

- ▶ With the driver's door open, pull the lever below the instrument panel in the direction of the arrow ⇒ fig. 155.
- ▶ Raise the hood slightly ⇒ ⚠.
- ▶ Press the rocker switch under the hood upward ⇒ fig. 156. This releases the catch.
- ▶ Open the hood.

**⚠ WARNING**

Never open the hood when you see that steam or coolant drips from the engine compartment- there is a danger of burns! Wait until no steam or coolant flows out.

- Never open the hood when you see that steam or coolant drips from the engine compartment- there is a danger of burns! Wait until no steam or coolant flows out.



### Closing the hood

- ▶ Push the hood down until the force of the strut is overcome.
- ▶ Let the hood fall lightly into the latch. *Do not press it in.* ⇒ ⚠.

#### ⚠ WARNING

If the hood is not latched completely, it could fly up while you are driving and obstruct your vision.

- For safety reasons, the hood must always be closed securely while driving. Because of this, always check the hood after closing it to make sure it is latched correctly. The hood is latched if the front corners cannot be lifted.
- If you notice that the hood is not latched while you are driving, stop immediately and close it, because this increases the risk of an accident.

### Gasoline engine compartment overview

The most important check points.

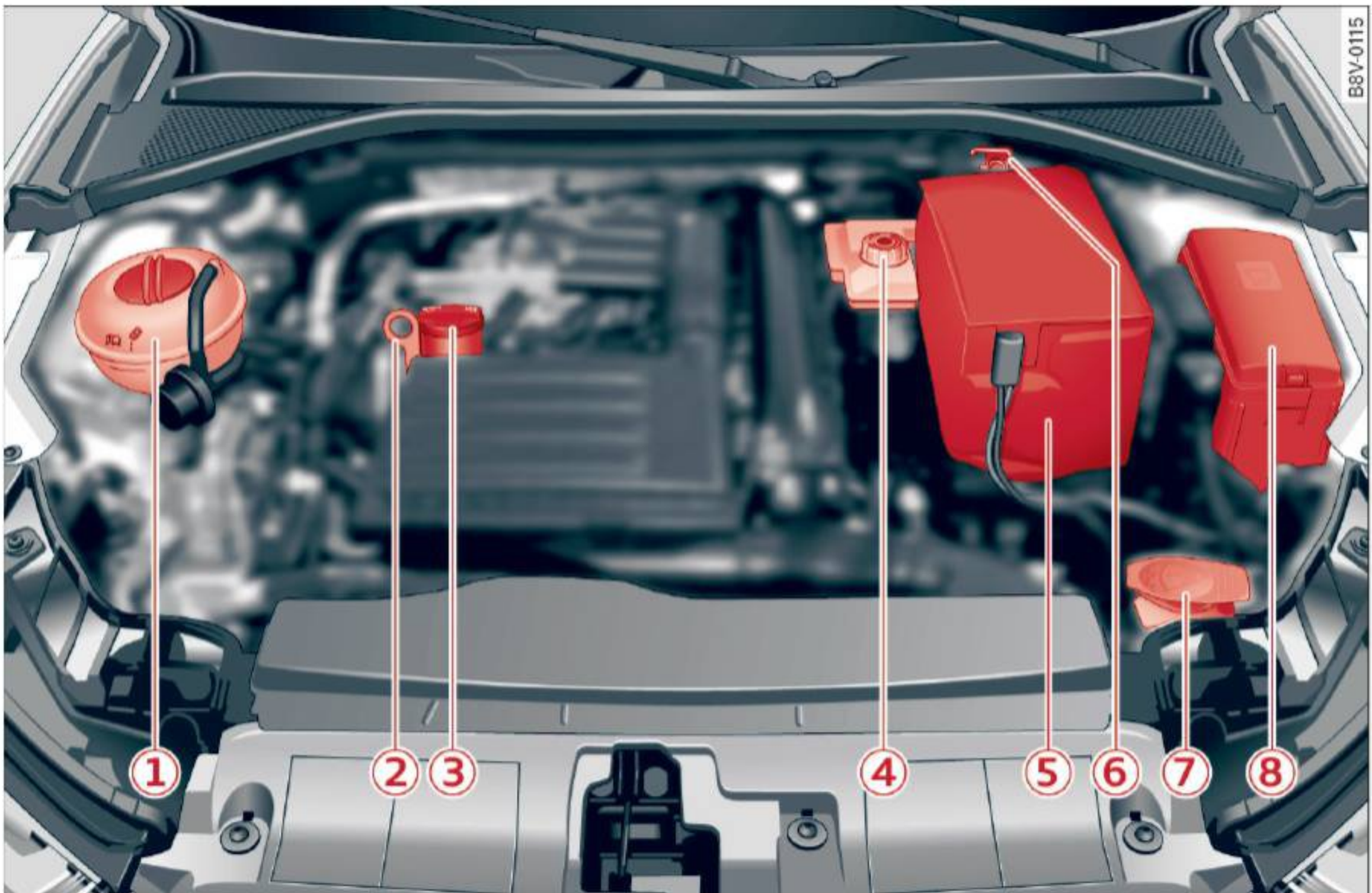

Fig. 157 Typical location of the reservoir, engine oil dipstick, and engine oil filler opening

①	Coolant expansion tank (📏)	206
②	Engine oil dipstick	203
③	Engine oil filler opening (🛢)	203
④	Brake fluid reservoir (📏)	207
⑤	Battery (+) under a cover	209
⑥	Body ground point (-)	
⑦	Washer fluid reservoir (🛢)	212
⑧	Fuse housing	248

The engine oil filler opening and the dipstick (items ③ and ②) ⇒ *fig. 157* may be located in a different area depending on engine version.

#### ⚠ WARNING

Read and following the WARNINGS before checking anything in the engine compartment ⇒ *page 198*.



**Diesel engine compartment overview**

The most important check points.

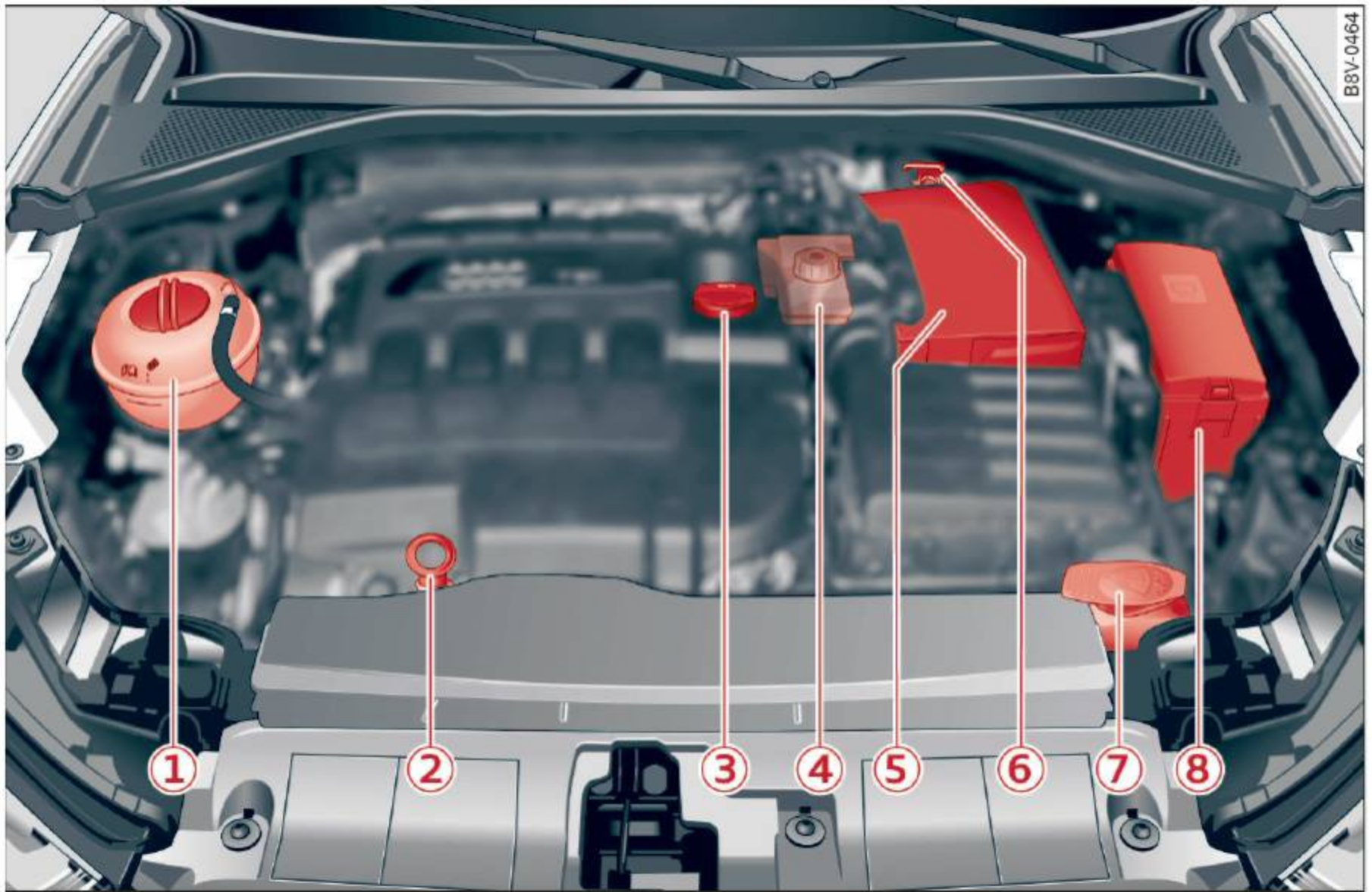

Fig. 158 Typical location of the reservoir, engine oil dipstick, and engine oil filler opening

- ① Coolant expansion tank (☞) . . . . . 206
- ② Engine oil dipstick . . . . . 203
- ③ Engine oil filler opening (☞) . . . . . 203
- ④ Brake fluid reservoir (☞) . . . . . 207
- ⑤ Battery (+) under a cover . . . . . 209
- ⑥ Body ground point (-)
- ⑦ Washer fluid reservoir (☞) . . . . . 212
- ⑧ Fuse housing . . . . . 248

The engine oil filler opening and the dipstick (items ③ and ②) ⇒ fig. 158 may be located in a different area depending on engine version.

**⚠ WARNING**

Read and following the WARNINGS before checking anything in the engine compartment ⇒ page 198.

**Engine oil**

**Engine oil specifications**

The engine oil used must conform to exact specifications.

The service interval display in the instrument cluster of your vehicle will inform you when it is time for an oil change. We recommend that you have your oil changed by an authorized Audi Service Advisor.

If you have to top off the oil between oil changes, use the Audi oil quality standard specified in the table.

	Audi oil quality standard
<b>Gasoline engine</b>	VW 502 00 or VW 504 00
<b>Diesel engine</b>	VW 507 00



Using the proper engine oil is important for the functionality and service life of the engine. Your engine was factory-filled with a high-quality oil which can usually be used throughout the entire year.

### Note

- Your Limited New Vehicle Warranty does not cover damage or malfunctions due to failure to follow recommended maintenance and use requirements as set forth in the Audi Owner's Manual and Warranty & Maintenance booklet.
- Use only a high quality engine oil that expressly complies with the Audi oil quality standard specified for your vehicle's engine. Using any other oil can cause serious engine damage.
  - Do not mix any lubricants or other additives into the engine oil. Doing so can cause engine damage.

### Tips

- If you need to add oil and there is none available that meets the Audi oil quality standard your engine requires, you may add a total of no more than 0.5 quart/liter of a high-quality "synthetic" oil that meets the following specifications.
- Vehicles with gasoline engine: ACEA A3 or API SM with a viscosity grade of SAE 0W-30, SAE 5W-30 or SAE 5W-40.
  - Vehicles with diesel engine: ACEA C3 or API CF with a viscosity grade of SAE 0W-30 or SAE 5W-30.
  - For more information about engine oil that has been approved for your vehicle, please contact either your authorized Audi dealer or Audi Customer Relations at 1 (800) 822-2834 or visit our web site at [www.audiusa.com](http://www.audiusa.com) or [www.audicanada.ca](http://www.audicanada.ca).

## Engine oil consumption

*The engine in your vehicle depends on an adequate amount of oil to lubricate and cool all of its moving parts.*

In order to provide effective lubrication and cooling of internal engine components, all internal

combustion engines consume a certain amount of oil. Oil consumption varies from engine to engine and may change significantly over the life of the engine. Typically, engines with a specified break-in period (see ⇒ *page 70*) consume more oil during the break-in period than they consume after oil consumption has stabilized.

Under normal conditions, the rate of oil consumption depends on the quality and viscosity of the oil, the RPM (revolutions per minute) at which the engine is operated, the ambient temperature and road conditions. Further factors are the amount of oil dilution from water condensation or fuel residue and the oxidation level of the oil. As any engine is subject to wear as mileage builds up, the oil consumption may increase over time until replacement of worn components may become necessary.

With all these variables coming into play, no standard rate of oil consumption can be established or specified. There is no alternative to regular and frequent checking of the oil level, see **Note**.

If the yellow engine oil level warning symbol  in the instrument cluster lights up, you should check the oil level as soon as possible ⇒ *page 203*. Top off the oil at your earliest convenience ⇒ *page 203*.

### WARNING

Before you check anything in the engine compartment, always read and heed all WARNINGS ⇒ *page 198*.

### Note

Driving with an insufficient oil level is likely to cause severe damage to the engine.

### Tips

- The oil pressure warning display  is not an indicator of the oil level. Do not rely on it. Instead, check the oil level in your engine at regular intervals, preferably each time you refuel, and always before going on a long trip.



– If you have the impression your engine consumes excessive amounts of oil, we recommend that you consult an authorized Audi dealer to have the cause of your concern properly diagnosed. Keep in mind that the accurate measurement of oil consumption requires great care and may take some time. An authorized Audi dealer has instructions about how to measure oil consumption accurately.

### Checking the engine oil level

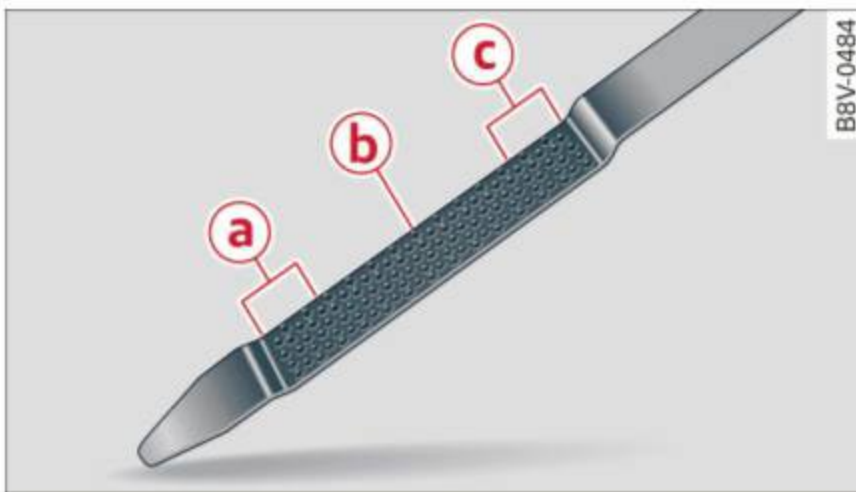

Fig. 159 Gasoline engine oil dipstick: guide for measuring the oil level (example)

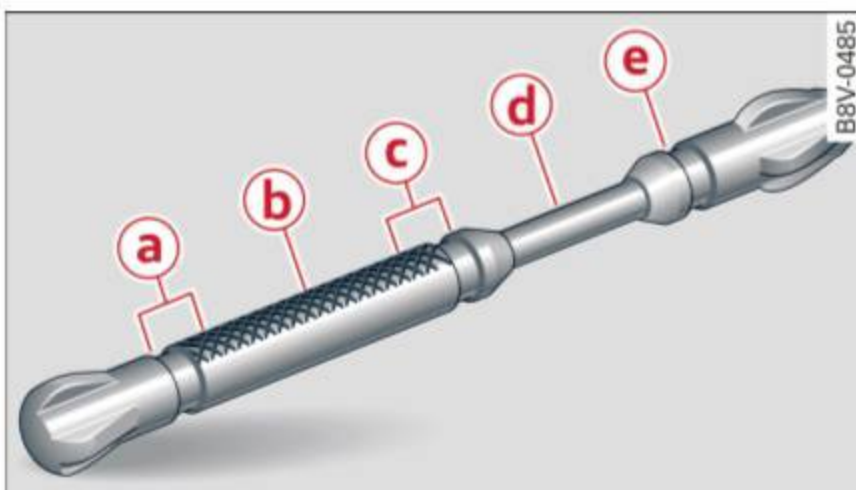

Fig. 160 Diesel engine oil dipstick: guide for measuring the oil level (example)

### Determining the oil level

- ▶ Park your vehicle on a level surface.
- ▶ Let the engine run in idle briefly while it is at operating temperature and then shut the engine off.
- ▶ Wait approximately two minutes.
- ▶ Remove the oil dipstick. Wipe off the oil dipstick with a clean cloth and insert it all the way in again.
- ▶ Remove the dipstick again and then read the oil level ⇒ *fig. 159* or ⇒ *fig. 160*.

- ▶ Evaluate the oil level ⇒ *table on page 203*. Add engine oil if necessary ⇒ *page 203*.

(a)	You must add oil. After adding oil, the level should be in the (c) area.
(b)	You may add oil. After adding oil, the level should be in the (c) area.
(c)	Do not add any oil.
(d)	Do not add any oil. You may continue driving.
(e)	Do not add any oil. Drive to an authorized Audi dealer or authorized Audi Service Facility immediately.

Applies to vehicles with diesel engines: if you operate your vehicle with biodiesel, fuel may enter the engine oil. This raises the oil level in the engine. It also decreases the quality of the engine oil ⇒ *page 23*.

The oil consumption of the engine may be up to 1/2 quart per 600 miles (0.5 liter per 1,000 km), depending on driving style and conditions. Consumption may be higher during the first 3,000 miles (5,000 km). Because of this, the engine oil level must be checked regularly. It would be best to check each time you refuel your vehicle and before long drives.

### Adding engine oil



Fig. 161 Engine compartment: engine oil filler opening cover

- ▶ Turn the engine off.
- ▶ Unscrew the engine oil filler opening cap ⇒ *fig. 161*, ⇒ *page 200*, *fig. 157*.
- ▶ Carefully add 0.5 quart (0.5 liter) of the appropriate oil ⇒ *page 201*.



- ▶ Check the oil level again after two minutes  
⇒ *page 203, Checking the engine oil level.*
- ▶ Add oil, if necessary.
- ▶ Close the engine oil filler cap and push the dipstick all the way in.

### **WARNING**

- When adding oil, do not let oil drip onto hot engine components. There could be risk of a fire.
- You must secure the cap on the oil filler opening correctly so that oil does not leak out onto the hot engine and exhaust system when the engine is running, because this is a fire hazard.
- Always clean skin thoroughly if it comes into contact with engine oil.

### **Note**

- Applies to vehicles with gasoline engines: the oil level cannot be above the **(c)** range  
⇒ *page 203, fig. 159*, because this can cause damage to the catalytic converter or the engine. Contact an authorized Audi dealer or authorized Audi Service Facility to have excess oil extracted if necessary.
- Applies to vehicles with diesel engines: the oil level must not be in the **(e)** range  
⇒ *page 203, fig. 160* - The oil must *not* be extracted, because this can damage the engine. Drive to an authorized Audi dealer or authorized Audi Service Facility immediately.
- Do not mix any additional lubricants into the engine oil. Damage cause by such additives is not covered by the warranty.

### **For the sake of the environment**

- Oil should never enter the sewer system or come into contact with the ground.
- Pay attention to legal requirements when disposing of empty oil containers.

## Changing the engine oil

*We recommend that have your oil changed by an authorized Audi dealer or a qualified service station.*

Before you check anything in the engine compartment, **always read and heed all WARNINGS**  
⇒ *page 198.*

The engine oil must be changed according to the intervals specified in your Warranty & Maintenance booklet. This is very important because the lubricating properties of oil diminish gradually during normal vehicle use.

Under some circumstances the engine oil should be changed more frequently. Change oil more often if you drive mostly short distances, operate the vehicle in dusty areas or under predominantly stop-and-go traffic conditions, or have your vehicle where temperatures remain below freezing for extended periods.

Detergent additives in the oil will make fresh oil look dark after the engine has been running for a short time. This is normal and is not a reason to change the oil more often than recommended.

Because of the problem of proper disposal, along with the special tools and necessary expertise required, we strongly recommend that you have your oil changed by an authorized **Audi dealer** or a qualified service station.

**If you choose to change your oil yourself**, please note the following important information:

### **WARNING**

To reduce the risk of personal injury if you must change the engine oil in your vehicle yourself:

- Wear eye protection.
- To reduce the risk of burns from hot engine oil, let the engine cool down to the touch.
- When removing the oil drain plug with your fingers, stay as far away as possible. Always keep your forearm parallel to the ground to help prevent hot oil from running down your arm.



- Drain the oil into a container designed for this purpose, one large enough to hold at least the total amount of oil in your engine.
- Engine oil is poisonous. Keep it well out of the reach of children.
- Continuous contact with used engine oil is harmful to your skin. Always protect your skin by washing oil off thoroughly with soap and water.

**! Note**  
 Never mix oil additives with your engine oil. These additives can damage your engine and adversely affect your Audi Limited New Vehicle Warranty.

**🌱 For the sake of the environment**

- Before changing your oil, first make sure you know where you can properly dispose of the used oil.
- Always dispose of used engine oil properly. Do not dump it on garden soil, wooded areas, into open streams or down sewage drains.
- Recycle used engine oil by taking it to a used engine oil collection facility in your area, or contact a service station.

## Cooling system

### Coolant

*The engine coolant performs two functions: it keeps the engine from overheating and it protects the engine from freezing in the winter.*

The cooling system is sealed and generally requires little attention.

The cooling system has been filled at the factory with a permanent coolant which does not need to be changed. The coolant consists of a mixture of specially conditioned water and the manufacturer's glycol-based coolant additive G13 antifreeze with anticorrosion additives (50% for USA models; 60% for Canadian models). This mixture both assures the necessary frost protection and protects metal components in the engine's cooling

system from corrosion and scaling. It also raises the boiling point of the coolant.

Do not reduce the concentration of the coolant in the summer by adding plain water. **The proportion of coolant additive must be at least 50% but not more than 60%** to maintain antifreeze protection and cooling efficiency. If the coolant frost protection is too low, the coolant could freeze and damage the vehicle heating and engine cooling system.

For year-round driving, antifreeze is added at the factory for temperatures down to:

- - 31 °F ( - 35 °C) USA
- - 40 °F ( - 40 °C) Canada.

If you must add coolant, use a mixture of water and coolant additive. Mixing the coolant additive with distilled water is recommended.

**! WARNING**  
 Before you check anything in the engine compartment, always read and heed all WARNINGS ⇨ *page 198.*

**! Note**

- Before winter sets in, have the coolant checked to see if the coolant additive in your vehicle is sufficient to meet the climate conditions. This is especially important if you live in a region where the winter is extremely cold. If necessary, increase the proportion of coolant additive to 60%.
- When adding coolant additive to your cooling system, remember:
  - We recommend using only coolant additive G12++ or G13 (check the label) for your vehicle. This coolant additive is available at authorized Audi dealers. Other types of antifreeze can significantly reduce corrosion protection. The resulting corrosion can cause a loss of coolant and serious engine damage.
  - Do not add any type of radiator leak sealant to your vehicle's engine coolant. Adding radiator repair fluid may adversely affect the function and performance of your cooling



system and could result in damage not covered by your New Vehicle Limited Warranty.

### Adding coolant



Fig. 162 Engine compartment: markings on the coolant expansion tank

**Read and following the WARNINGS** before checking anything in the engine compartment ⇒ *page 198*.

### Checking the engine coolant level

- ▶ Park your vehicle on a level surface.
- ▶ switch the ignition off.
- ▶ Read the coolant level on the coolant expansion tank ⇒ *fig. 162*. The coolant level must be between the markings when the engine is cold. When the engine is warm it can be slightly above the upper marking.

### Adding coolant

Requirement: there must be a residual amount of coolant in the expansion tank ⇒ .

- ▶ Let the engine cool down.
- ▶ Place a cloth over the coolant expansion tank cap and unscrew the cap counterclockwise ⇒ .
- ▶ Add coolant mixed in the correct ratio ⇒ *page 205* up to the upper marking.
- ▶ Make sure that the fluid level remains stable. Add more coolant if necessary.
- ▶ Close the cap securely.

A coolant loss suggests a leak. Immediately drive your vehicle to an authorized Audi dealer or authorized Audi Service Facility and have the cooling system inspected. If the cooling system is not leaking, a loss can come from the coolant boiling

through overheating and being pushed out of the cooling system.

### WARNING

The cooling system is pressurized and can become very hot. To reduce the risk of burns from hot coolant:

- Do not open the coolant expansion tank cap with the engine hot. There is a risk of burns.
- Stop the engine and allow it to cool.
- Protect your face, hands and arms from escaping coolant and steam by covering the coolant tank cap with a large, thick cloth.
- Turn the coolant tank cap counterclockwise slowly and keep light pressure on the cap.
- To reduce the risk of burns, do not allow any antifreeze or coolant to drip onto the exhaust system or hot engine components. The ethylene glycol in engine coolant can catch fire under certain circumstances.
- The coolant additive and the coolant can be dangerous to your health. For this reason, keep the coolant in the original container away from children. There is a risk of poisoning.
- When working in the engine compartment, remember that the radiator fan can switch on even if the ignition is switched off, which increases the risk of personal injury.

### Note

Do not add coolant if the expansion tank is empty. Air could enter the cooling system and damage the engine. If this is the case, do not continue driving. See an authorized Audi dealer or authorized Audi Service Facility for assistance.

### Radiator fan

*The radiator fan switches on automatically by itself.*

An auxiliary electric radiator fan switches on and off depending on coolant temperature and other vehicle operating conditions.

After you switch the engine off, the auxiliary fan can continue running for up to 10 minutes - even ▶



with the ignition off. It can even switch on again later by itself ⇒ ⚠, if

- the temperature of the engine coolant rises due to the heat build-up from the engine in the engine compartment, or
- the engine compartment heats up because the vehicle is parked in intense sunlight.

**⚠ WARNING**

- To reduce the risk of personal injury never touch the radiator fan.
- The auxiliary electric fan is temperature controlled and can switch on suddenly even when the engine is not running.
- The auxiliary radiator fan switches on automatically when the engine coolant reaches a certain temperature and will continue to run until the coolant temperature drops.

## Brake fluid

### Checking brake fluid level



Fig. 163 Engine compartment: cover on the brake fluid reservoir

Before you check anything in the engine compartment, **always read and heed all WARNINGS** ⇒ page 198.

- Read the brake fluid level from the brake fluid reservoir ⇒ fig. 163, ⇒ page 200, fig. 157. The brake fluid level must be between the “MIN” and “MAX” markings.

The location of the brake fluid reservoir can be seen in the engine compartment illustration ⇒ page 200.

The fluid level may drop *slightly* after some time due to the automatic adjustment of the brake pads. This is not cause for alarm.

If the brake fluid level falls *considerably* below the “MIN” mark, the brake warning/indicator light **BRAKE** (U.S. models) /  (Canadian models) will come on ⇒ page 17. Do not continue to operate the vehicle. The complete brake system should be thoroughly checked by an authorized Audi dealer or other qualified facility and the cause corrected. If the brake fluid level is too low, the brake warning/indicator light will illuminate. Contact an authorized Audi dealer **immediately**.

### Changing brake fluid

*Have the brake fluid changed by an experienced technician.*

Brake fluid absorbs moisture from the air. If the water content in the brake fluid is too high, corrosion in the brake system may result after a period of time. The boiling point of the brake fluid will also decrease considerably and decrease braking performance.

Therefore, the brake fluid must be changed **every two years**. Always use new brake fluid which conforms to Federal Motor Vehicle Standard “FMVSS 116 DOT 4”.

The brake fluid reservoir can be difficult to reach, therefore, we recommend that you have the brake fluid changed by your authorized **Audi dealer**. Your dealer has the correct tools, the right brake fluid and the know-how to do this for you.

**⚠ WARNING**

- Brake fluid is poisonous. It must be stored only in the closed original container out of the reach of children!
- Brake failure can result from old or inappropriate brake fluid. Observe these precautions:
  - Use only brake fluid that meets SAE specification J 1703 and conforms to Federal Motor Vehicle Standard 116. Always check with your authorized Audi dealer to make



sure you are using the correct brake fluid. The correct type of brake fluid is also indicated on the brake fluid reservoir.

- The brake fluid must be new. Heavy use of the brakes can cause a vapor lock if the brake fluid is left in the system too long. This can seriously affect the efficiency of the brakes as well as your safety. This could result in an accident.

### Note

Brake fluid will damage the paint of your vehicle.

### For the sake of the environment

Because of the problem of proper disposal of brake fluid as well as the special tools required and the necessary expertise, we recommend that you have the brake fluid changed by your authorized Audi dealer.

## Battery

### General information

The battery in your Audi does not need any maintenance under **normal** operating conditions. Audi recommends having the electrolyte level checked by an authorized Audi dealer or authorized Audi Service Facility when there are *high* outside temperatures or when driving all day. The electrolyte level should also be checked each time the battery is charged ⇒ *page 210*.

Have the battery checked when you bring your vehicle in for an inspection. It is a good idea to replace the battery if it is more than 5 years old.

During certain types of airbag deployments, the battery is disconnected from the vehicle electrical system for safety reasons ⇒  *in Repair, care and disposal of the airbags on page 163*.

### Disconnecting the battery terminals

Some vehicle functions (such as power windows) are not available when the battery is disconnected. These functions must be programmed after the battery is reconnected. To avoid having to do this, only disconnect the battery from the vehicle

electrical system when that is necessary to perform repairs.

To reprogram the functions, proceed as follows:

Function	Reprogramming
Power window one-touch up/down function	⇒ <i>page 41, Correcting power window malfunctions</i>
Remote control key or Convenience key	If the vehicle does not react to the key, it must be synchronized ⇒ <i>page 35</i>
Digital clock	⇒ <i>page 10</i>
ESC indicator light	The indicator light goes out after driving a few meters

### Not running the vehicle for long periods of time

If you do not drive your vehicle for several days or weeks, electrical components are gradually reduced or switched off. This reduces energy consumption and maintains the vehicle's ability to start over a long period of time ⇒ *page 128*.

Some convenience functions, such as interior lighting or power seats\* may not work. These convenience functions will be available again once you switch the ignition on and start the engine.

### Winter operation

During the winter months, it is common for the battery capacity to decrease as the temperatures become lower. This is because more power is needed to start the vehicle and components such as the headlights and the rear window defogger are used more frequently.

Avoid using power unnecessarily, especially in city driving or on short trips. Have your authorized Audi dealer or authorized Audi Service Facility check the battery capacity before the start of winter ⇒ *page 210*. A well-charged battery will not only reduce starting problems in cold weather, but it will also last longer. ►



**! WARNING**

- Work on the battery requires expert knowledge. Contact an authorized Audi dealer or authorized Audi Service Facility for information regarding the vehicle battery. There is a risk for chemical burns or explosions.
- Never open the vehicle battery. Do not try to change the battery electrolyte level. Otherwise explosive gas will escape from the battery and increase the risk of an explosion.

**i Tips**

If your vehicle is not driven for several weeks in very cold temperatures, remove the battery and store it in a place where it will not freeze. This prevents the battery from being damaged and needing to be replaced.



**Working on the battery**



*Be especially careful when working on or near the battery.*

The battery is located in the luggage compartment under the floor. Before you check anything in the luggage compartment, **read and heed all WARNINGS** ⇒ **!**.

Always heed the **safety warnings**, when working on the vehicle battery or the vehicle electrical system to prevent injury.

**The following WARNINGS are very important when working on the battery:**

<b>Always heed the following WARNING SYMBOLS and safety precautions when working on the battery.</b>	
	<b>Always wear eye protection.</b>
	<b>Battery acid contains sulfuric acid. Always wear gloves and eye protection.</b>
	<b>No</b> - sparks - flames - smoking.

	<b>When a battery is charged, it produces hydrogen gas which is explosive and could cause personal injury.</b>
	<b>Always keep the battery well out of reach of children.</b>

**! WARNING**

Whenever working on the battery or on the electrical system, there is the risk of injury, accident and even fire. Read and heed the following WARNINGS:

- Always wear eye protection. Do not let battery acid or any lead particles get on your skin or clothing. Shield your eyes. Explosive gases can cause blindness or other injury.
- Battery acid contains sulfuric acid. Sulfuric acid can cause blindness and severe burns.
  - Always wear gloves and eye protection. Do not tilt the battery because acid could leak out of the ventilation openings.
- If you get battery acid in your eyes or on your skin, immediately rinse with cold water for several minutes and get medical attention.
- If you should ingest any battery acid, seek medical attention immediately.
- Do not expose the battery to an open flame, electric sparks or an open light.
- Do not smoke.
- Do not interchange the positive and negative cables.
- When working on the battery, be sure not to short-circuit the terminals with tools or other metal objects. This would cause the battery to heat up very quickly, which could lead to damage or explosion and personal injury.
- When a battery is charged, it produces hydrogen gas which is explosive and could cause personal injury.
- Always keep the battery well out of the reach of children.
- Before work is done on the electrical system, disconnect the negative ground cable.
- Before performing any work on the electrical system, switch off the engine and ignition as well as any electrical equipment. The



negative cable on the battery must be disconnected. If you are just going to replace a light bulb, then it is enough to switch off the lights.

- Before disconnecting the battery, switch off the anti-theft alarm system! Otherwise you will set off the alarm.
- When disconnecting the battery, first disconnect the negative cable and then the positive cable.
- Before reconnecting the battery, make sure all electrical consumers are switched off. Reconnect the positive cable first and then the negative cable. Never interchange the cables - this could start a fire!
- Never charge a frozen or a thawed-out battery. It could explode! If a battery has frozen, then it must be replaced. A discharged battery can freeze over at 32 °F (0 °C).
- Make sure the vent hose is always attached to the opening on the side of the battery.
- Never use batteries which are damaged. There is the danger of an explosion! Always replace a damaged battery.

### **WARNING**

California Proposition 65 Warning:

- Battery posts, terminals and related accessories contain lead and lead compounds, chemicals known to the State of California to cause cancer and reproductive problems. Wash hands after handling.

### **Note**

- Do not disconnect the vehicle battery when the ignition is on or when the engine is running, otherwise, you will damage electronic components in the electrical system.
- If your vehicle is going to stand for a long period of time without being driven, protect the battery from “freezing”, otherwise it will be damaged and will then have to be replaced.

## Battery charging

Starting the engine requires a well charged battery.

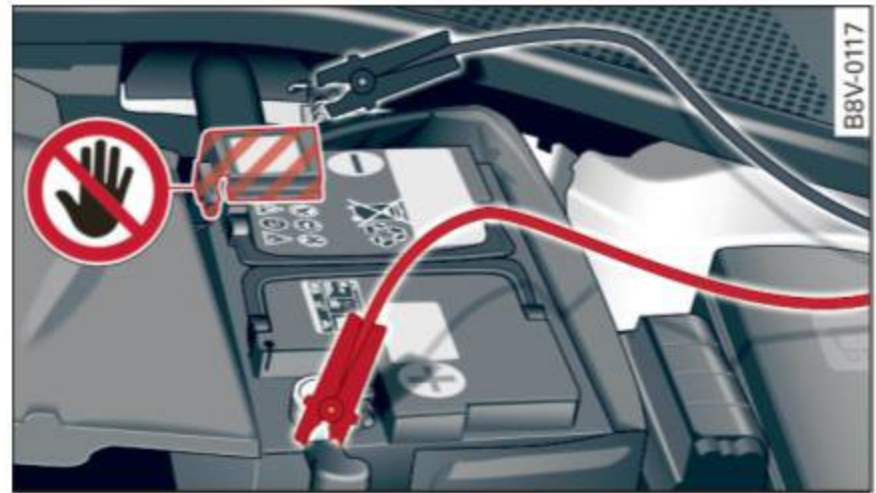



Fig. 164 Engine compartment: connectors for a charger and jump start cables

**Always read and heed all WARNINGS** below  
⇒  and ⇒  in *Working on the battery* on page 209.

- ▶ Switch off the ignition and all electrical consumers.
- ▶ Make sure the area is well ventilated when you charge the battery.
- ▶ Open the engine hood ⇒ page 199.
- ▶ Open the red cover on the positive pole ⇒ fig. 164.
- ▶ Clamp the charger terminal clamps as instructed on the **battery terminal (+)** and only on the **body ground point (-)**.
- ▶ Only now plug the mains lead for the charging equipment into the wall outlet and turn it on ⇒ .
- ▶ **Make sure the charging rate is not over 30 amps / 14.8 Volt.**
- ▶ When the battery is fully charged: Turn the charging equipment off and remove the mains lead from the wall outlet.
- ▶ Now remove the clamps for the charging equipment.
- ▶ Close the red cover on the positive pole.
- ▶ Close the hood ⇒ page 200.

A discharged battery can **freeze** at temperatures of only 32 F° (0 °C). Allow a frozen battery to thaw completely before attempting to charge it ⇒ . However, we recommend not using a thawed battery again because the battery casing ▶



can be cracked due to ice formation and can leak battery acid.

### Battery charging (Maximum charging rate of 30 amps / 14.8 Volt)

When charging at *low* voltages (e.g. with a **trickle charger**), the battery cables do not have to be disconnected first. The battery caps should *not* be opened when charging a battery.

It is not necessary to remove the battery from the luggage compartment, and it is also not necessary to disconnect the cables.

### Fast charging the battery (charging rate above 14.8 Volts)

For technical reasons do not use a battery charger that uses voltage greater than 14.8 Volts to charge your vehicle's battery.

#### WARNING

- Charging a battery can be dangerous.
- Always follow the operating instructions provided by the battery charger manufacturer when charging your battery.
  - Never charge a frozen battery. It may explode because of gas trapped in the ice. Allow a frozen battery to thaw out first.
  - Do not reuse batteries which were frozen. The battery housing may have cracked and weakened when the battery froze.
  - Charge the battery in a well ventilated area. Keep away from open flame or electrical spark. Do not smoke. Hydrogen gas generated by the battery is explosive.
  - To reduce the danger of explosion, never connect or disconnect charger cables while the charger is operating.
  - Fast charging a battery is dangerous and should only be attempted by a competent technician with the proper equipment.
  - Battery acid that may spill during charging should be washed off with a solution of warm water and baking soda to neutralize the acid.

#### Note

Never use a fast charger as a booster to start the engine. This will seriously damage sensitive electronic components, such as control units, relays, radio, etc., as well as the battery charger.

#### Battery replacement

*The new battery must have the same specifications and dimensions as the original equipment battery.*

Intelligent energy management in your vehicle is responsible for distributing the electrical energy throughout your vehicle ⇒ *page 128*. The intelligent energy management system will keep the engine battery charged better than vehicles without this system. To make sure the additional electrical energy is available once again after you have changed the battery, we recommend that you install batteries of the same type and manufacture only (the same as those installed at the time your vehicle was delivered). Specifications are listed on the battery housing. Your authorized dealer must code the battery in the energy management system to enable you to use the energy management functions correctly after replacing the battery.

The new battery must have the same capacity, voltage (12-volts), amperage, construction and plug sealing.

When installing the battery, make sure the ignition and all electrical consumers are switched off.

#### Note

Make sure the ventilation hose on the side of the battery is connected, otherwise fumes or battery acid can leak out.

#### For the sake of the environment

Because of the problem of proper disposal of a battery, we recommend your authorized Audi dealer change the battery for you. Batteries contain sulfuric acid and lead and must always be disposed of properly in compliance with all environmental regulations. Disposing



of vehicle batteries improperly is very dangerous to the environment.

## Windshield washer system



Fig. 165 Engine compartment: washer fluid reservoir cap

The washer fluid reservoir  contains the windshield washer fluid ⇒ *page 200, fig. 157*. Reservoir capacity ⇒ *page 260*.

- ▶ Read and follow all **WARNINGS** before working in the engine compartment ⇒ *page 198*.
- ▶ Open the cap.
- ▶ Add the washer fluid and close the cap.

To reduce the risk of lime scale deposits on the spray nozzles, use clean water with low amounts of calcium. Always add a window cleaner to the water. It should contain freeze protection in the winter.

### Note

- Never add radiator anti-freeze or other additives to the washer fluid.
- Do not use a glass cleaner that contains paint solvents, there is a risk of damaging the paint.

## Service interval display

The service interval display detects when your vehicle is due for service.



Fig. 166 Instrument cluster: Service interval display (example)

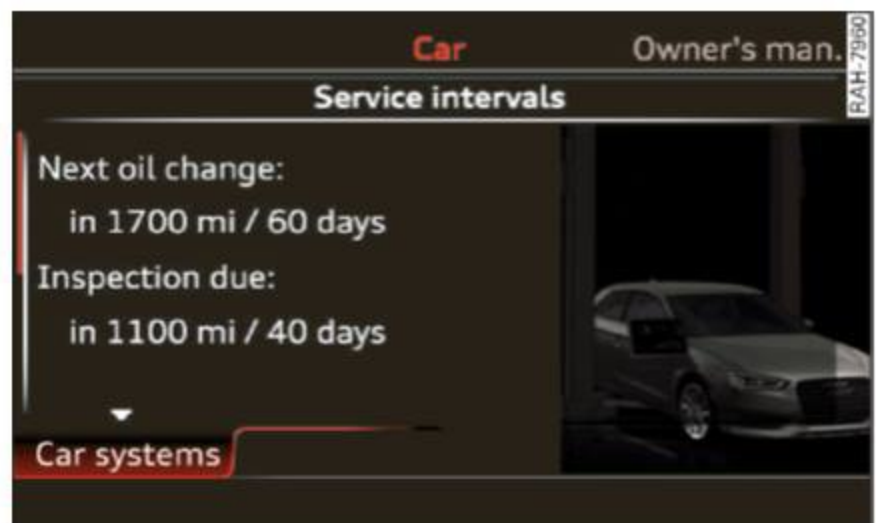

Fig. 167 Display in the MMI panel: service interval display (example)

The service interval display works in two stages:

- **Inspection or oil change reminder:** After a certain distance driven, a message appears in the instrument cluster display each time the ignition is switched on or off ⇒ *fig. 166*. The remaining distance or time is displayed briefly.
- **Inspection or oil change due:** If your vehicle has reached an inspection or oil change interval or both intervals at the same time, the message: **Inspection due!** or **Oil change due!** or **Oil change and inspection due!** appears briefly after switching the ignition on/off.

### Checking service intervals

You can check the remaining distance or time until the next oil change or next inspection in the MMI ⇒ *fig. 167*. Select the **MENU** button > **Car** > **Systems\*** control button > **Service & control** > **Service intervals**.



## Resetting the indicator

Your authorized Audi dealer or authorized Audi Service Facility will reset the service interval display after performing service.

If you perform an oil change yourself to the Audi specifications, you must reset the service interval display.

To reset the display, select the **MENU** button > **Car** > **Systems\*** control button > **Service & control** > **Service intervals** > **Reset oil change interval**.

### Note

- Only reset the oil change indicator if the oil was changed.
- Following the service intervals is critical to maintaining the service life and value of your vehicle, especially the engine. Even if the mileage on the vehicle is low, do not exceed the time for the next service.
- Calculating the time to the next oil change is interrupted when the vehicle battery is disconnected. If the vehicle is not driven for a long period of time, check the maintenance schedule so that you can follow the maintenance intervals.



## Tires and wheels

### Wheels

#### General information

- ▶ Check your tires regularly for damage (punctures, cuts, cracks and bulges). Remove foreign objects from the tire tread.
- ▶ If driving over curbs or similar obstacles, drive slowly and approach the curb at an angle.
- ▶ Have faulty tires or rims replaced immediately.
- ▶ Protect your tires from oil, grease and fuel.
- ▶ Mark tires before removing them so that the same running direction can be maintained if they are reinstalled.
- ▶ Lay tires flat when storing and store them in a cool, dry location with as little exposure to light as possible.

#### ! Note

–Please note that summer and winter tires are designed for the conditions that are typical in those seasons. Audi recommends using winter tires during the winter months. Low temperatures significantly decrease the elasticity of summer tires, which affects traction

and braking ability. If summer tires are used in very cold temperatures, cracks can form on the tread bars, resulting in permanent tire damage that can cause loud driving noise and unbalanced tires.

- Burnished, polished or chromed rims must not be used in winter driving conditions. The surface of the rims does not have sufficient corrosion protection for this and could be permanently damaged by road salt or similar substances.

#### Tire designations

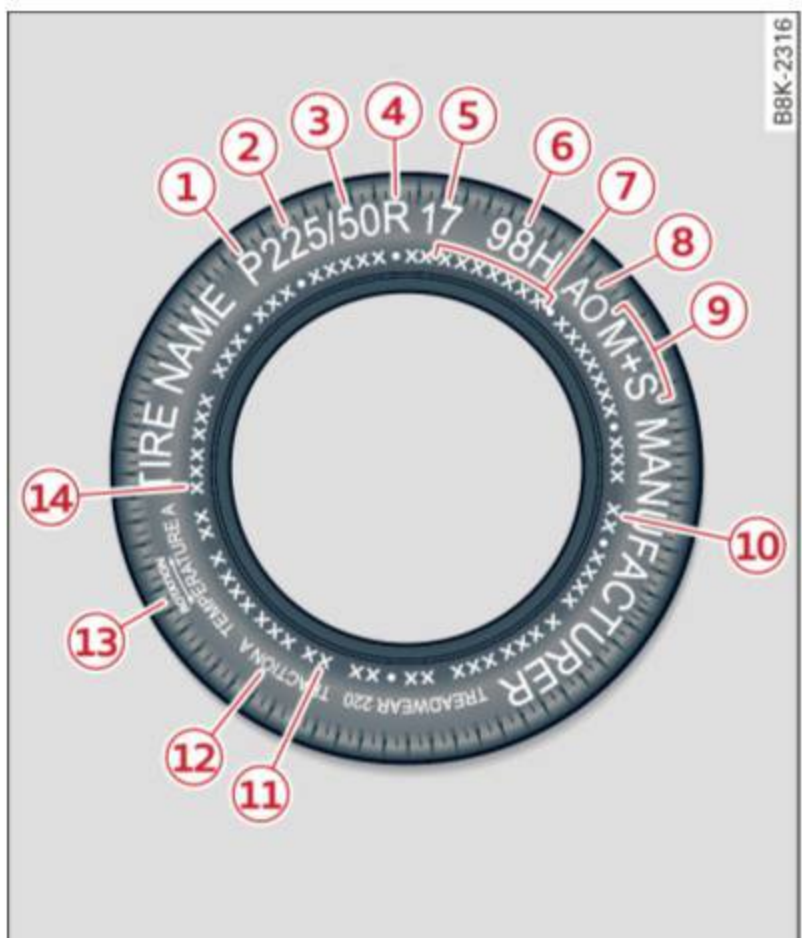

**Fig. 168** Tire specification codes on the sidewall of a tire



## ① Tires for passenger vehicles (if applicable)

P indicates a tire for a passenger vehicle. T indicates a tire designated for temporary use.

## ② Nominal width

Nominal width of the tire between the sidewalls in millimeters. In general: the larger the number, the wider the tire.

## ③ Aspect ratio

Height/width ratio expressed as a percentage.

## ④ Tire construction

R indicates a radial tire.

## ⑤ Rim diameter

Size of the rim diameter in inches.

## ⑥ Load index and speed rating

The load index indicates the tire's load-carrying capacity.

The speed rating indicates the maximum permitted speed ⇒  in *Winter tires on page 229*.

“EXTRA LOAD”, “xl” or “RF” indicates that the tire is reinforced or is an Extra Load tire.

Speed rating	Maximum permitted speed
P	up to 93 mph (150 km/h)
Q	up to 99 mph (160 km/h)

Speed rating	Maximum permitted speed
R	up to 106 mph (170 km/h)
S	up to 110 mph (180 km/h)
T	up to 118 mph (190 km/h)
U	up to 124 mph (200 km/h)
H	up to 130 mph (210 km/h)
V	up to 149 mph (149.13 mi/h) <sup>a)</sup>
Z	above 149 mph (240 km/h) <sup>a)</sup>
W	up to 168 mph (167.77 mi/h) <sup>a)</sup>
Y	up to 186 mph (186.41 mi/h) <sup>a)</sup>

<sup>a)</sup> Tire manufacturers sometimes use “ZR” for tires with a maximum speed above 149 mph (240 km/h).

## ⑦ US DOT number (TIN) and manufacture date

The manufacture date is listed on the tire sidewall (it may only appear on the inner side of the tire):

**DOT ... 2214 ...**

means, for example, that the tire was produced in the 22nd week of the year 2014.

## ⑧ Audi Original equipment tires

Audi Original equipment tires with the designation “AO” or “RO” have been specially matched to your Audi. When used correctly, these tires meet the highest standards of safety and handling. An authorized Audi dealer or authorized Audi Service Facility will ►



be happy to provide more information.

### ⑨ **Mud and snow capability**

“M/S” or “M+S” indicates the tire has characteristics that make it suitable for driving on mud and snow.  indicates a winter tire.

### ⑩ **Composition of the tire cord and materials**

The number of plies indicates the number of rubberized fabric layers in the tire. In general: the more layers, the more weight a tire can carry. Tire manufacturers must also specify the materials used in the tire. These include steel, nylon, polyester and other materials.

### ⑪ **Maximum permitted load**

This number indicates the maximum load in kilograms and pounds that the tire can carry.

### ⑫ **Uniform tire quality grade standards for treadwear, traction and temperature resistance**

Treadwear, traction and temperature ranges ⇒ *page 231*.

### ⑬ **Running direction**

The arrows indicate the running direction of unidirectional tires.

You must always follow the specified running direction  
⇒ *page 245*.

### ⑭ **Maximum permitted inflation pressure**

This number indicates the maximum pressure to which a tire can be inflated under normal operating conditions.

## **Glossary of tire and loading terminology**

### **Accessory weight**

means the combined weight (in excess of those standard items which may be replaced) of automatic transmission, power steering, power brakes, power windows, power seats, radio, and heater, to the extent that these items are available as factory-installed equipment (whether installed or not).

### **Aspect ratio**

means the ratio of the height to the width of the tire in percent. Numbers of 55 or lower indicate a low sidewall for improved steering response and better overall handling on dry pavement. ▶



**Bead**

means the part of the tire that is made of steel wires, wrapped or reinforced by ply cords and that is shaped to fit the rim.

**Bead separation**

means a breakdown of the bond between components in the bead.

**Cord**

means the strands forming the plies in the tire.

**Cold tire inflation pressure**

means the tire pressure recommended by the vehicle manufacturer for a tire of a designated size that has not been driven for more than a couple of miles (kilometers) at low speeds in the three hour period before the tire pressure is measured or adjusted.

**Curb weight**

means the weight of a motor vehicle with standard equipment including the maximum capacity of fuel, oil, and coolant, air conditioning and additional weight of optional equipment.

**Extra load tire**

means a tire designed to operate at higher loads and at higher in-

flation pressures than the corresponding standard tire. Extra load tires may be identified as “XL”, “xl”, “EXTRA LOAD”, or “RF” on the sidewall.

**Gross Axle Weight Rating (“GAWR”)**

means the load-carrying capacity of a single axle system, measured at the tire-ground interfaces.

**Gross Vehicle Weight Rating (“GVWR”)**

means the maximum total loaded weight of the vehicle.

**Groove**

means the space between two adjacent tread ribs.

**Load rating (code)**

means the maximum load that a tire is rated to carry for a given inflation pressure. You may not find this information on all tires because it is not required by law.

**Maximum load rating**

means the load rating for a tire at the maximum permissible inflation pressure for that tire.

**Maximum loaded vehicle weight**

means the sum of: ►



- (a) Curb weight
- (b) Accessory weight
- (c) Vehicle capacity weight, and
- (d) Production options weight

**Maximum (permissible) inflation pressure**

means the maximum cold inflation pressure to which a tire may be inflated. Also called “maximum inflation pressure.”

**Normal occupant weight**

means 150 lbs. (68 kilograms) times the number of occupants seated in the vehicle up to the total seating capacity of your vehicle.

**Occupant distribution**

means distribution of occupants in a vehicle.

**Outer diameter**

means the overall diameter of an inflated new tire.

**Overall width**

means the linear distance between the exteriors of the sidewalls of an inflated tire, including elevations due to labeling, decorations, or protective bands or ribs.

**Ply**

means a layer of rubber-coated parallel cords.

**Production options weight**

means the combined weight of those installed regular production options weighing over 5 lbs. (2.3 kg) in excess of those standard items which they replace, not previously considered in curb weight or accessory weight, including heavy duty brakes, ride levelers, roof rack, heavy duty battery, and special trim.

**Radial ply tire**

means a pneumatic tire in which the ply cords that extend to the beads are laid at substantially 90 degrees to the centerline of the tread.

**Recommended inflation pressure**

see ⇨ *page 217, Cold tire inflation pressure.*

**Reinforced tire**

means a tire designed to operate at higher loads and at higher inflation pressures than the corresponding standard tire. Reinforced tires may be identified as ▶



“XL”, “xl”, “EXTRA LOAD”, or “RF” on the sidewall.

### **Rim**

means a metal support for a tire or a tire and tube assembly upon which the tire beads are seated.

### **Rim diameter**

means nominal diameter of the bead seat. If you change your wheel size, you will have to purchase new tires to match the new rim diameter.

### **Rim size designation**

means rim diameter and width.

### **Rim width**

means nominal distance between rim flanges.

### **Sidewall**

means that portion of a tire between the tread and bead.

### **Speed rating (letter code)**

means the speed at which a tire is designed to be driven for extended periods of time. The ratings range from 93 mph (150 km/h) to 186 mph (298 km/h) ⇒ *table on page 215*. You may not find this information on all tires because it is not required by law.

The speed rating letter code, where applicable, is molded on the tire sidewall and indicates the maximum permissible road speeds ⇒ *▲ in Winter tires on page 229*.

### **Tire pressure monitoring system\***

means a system that detects when one or more of a vehicle's tires are underinflated and illuminates a low tire pressure warning telltale.

### **Tread**

means that portion of a tire that comes into contact with the road.

### **Tread separation**

means pulling away of the tread from the tire carcass.

### **Treadwear indicators (TWI)**

means the projections within the principal grooves designed to give a visual indication of the degrees of wear of the tread. See ⇒ *page 223, Treadwear indicator* for more information on measuring tire wear. ▶



## **Uniform Tire Quality Grading**

is a tire information system developed by the United States National Highway Traffic Safety Administration (NHTSA) that is designed to help buyers make relative comparisons among tires. The UTQG is not a safety rating and not a guarantee that a tire will last for a prescribed number of miles (kilometers) or perform in a certain way. It simply gives tire buyers additional information to combine with other considerations, such as price, brand loyalty and dealer recommendations. Under UTQG, tires are graded by the tire manufacturers in three areas: treadwear, traction, and temperature resistance. The UTQG information on the tires, molded into the sidewalls.

## **U.S. DOT Tire Identification Number (TIN)**

This is the tire's "serial number". It begins with the letters "DOT" and indicates that the tire meets all federal standards. The next two numbers or letters indicate the plant where it was manufactured, and the last four numbers represent the week and year of manufacture. For example,

## **DOT ... 2214 ...**

means that the tire was produced in the 22nd week of 2014. The other numbers are marketing codes that may or may not be used by the tire manufacturer. This information is used to contact consumers if a tire defect requires a recall.

## **Vehicle capacity weight**

means the rated cargo and luggage load plus 150 lbs. (68 kilograms) times the vehicle's designated seating capacity.

## **Vehicle maximum load on the tire**

means that load on an individual tire that is determined by distributing to each axle its share of the maximum loaded vehicle weight and dividing by two.

## **Vehicle normal load on the tire**

means that load on an individual tire that is determined by distributing to each axle its share of the curb weight, accessory weight, and normal occupant weight (distributed in accordance with ⇒ *table on page 226*) and dividing by two. ▶



## Occupant loading and distribution for vehicle normal load for various designated seating capacities

Refer to the tire inflation pressure label ⇒ *page 224, fig. 171* for the number of seating positions. Refer to the table ⇒ *table on page 226* for the number of people that correspond to the vehicle normal load.

### New tires or wheels

Audi recommends having all work on tires or wheels performed by an authorized Audi dealer or authorized Audi Service Facility. These facilities have the proper knowledge and are equipped with the required tools and replacement parts.

- ▶ New tires do not yet have the optimum adhesion properties. Drive carefully and at moderate speeds for the first 350 miles (500 km) with new tires.
- ▶ Use tires of the same construction, size (rolling circumference) and as close to the same tread pattern as possible on all four wheels.

- ▶ Do not replace tires individually. At least replace both tires on the same axle at the same time.
- ▶ Audi recommends that you use Audi Original equipment tires. If you would like to use different tires, please note that the tires may perform differently even if they are the same size ⇒ ⚠.
- ▶ If you would like to equip your vehicle with a tire/rim combination that is different from what was installed at the factory, consult with an authorized Audi dealer or authorized Audi Service Facility before making a purchase ⇒ ⚠.

The spare tire\* is different from the regular tires installed on the vehicle - for example, if winter tires or wide tires are installed - then only use the spare tire\* temporarily in case of emergency and drive carefully while it is in use. It should be replaced with a regular tire as soon as possible.

On **all wheel drive** vehicles, all four wheels must be equipped with tires that are the same brand and have the same construction and tread pattern so that the drive system is not damaged by ▶



different tire speeds. For this reason, in case of emergency, only use a spare tire\* that is the same circumference as the regular tires.

### WARNING

- Only use tire/rim combinations and suitable wheel bolts that have been approved by Audi. Otherwise, damage to the vehicle and an accident could result.
- For technical reasons, it is not possible to use tires from other vehicles - in some cases, you cannot even use tires from the same vehicle model.
- Make sure that the tires you select have enough clearance to the vehicle. Replacement tires should not be chosen simply based on the nominal size, because tires with a different construction can differ greatly even if they are the same size. If there is not enough clearance, the tires or the vehicle can be damaged and this can reduce driving safety and increase the risk of an accident.
- Only use tires that are more than 6 years old when abso-

lutely necessary and drive carefully when doing so.

- Do not use run-flat tires on your vehicle. Using them when not permitted can lead to vehicle damage or accidents.
- If you install wheel covers on the vehicle, make sure they allow enough air circulation to cool the brake system. If they do not, this could increase the risk of an accident.

## Tire wear/damage



**Fig. 169** Tire profile: treadwear indicator

### Tire wear

- Check the tires regularly for wear.
- Inflation pressure that is too low or high can increase tire wear considerably.
  - Driving quickly through curves, rapid acceleration and heavy braking increase tire wear. ▶



- Have an authorized Audi dealer or authorized Audi Service Facility check the wheel alignment if there is unusual wear.
- Have the wheels rebalanced if an imbalance is causing noticeable vibration in the steering wheel. If you do not, the tires and other vehicle components could wear more quickly.

### Treadwear indicator

Original equipment tires contain treadwear indicators in the tread pattern, which are bars that are 1/16 inch (1.6 mm) high and are spaced evenly around the tire perpendicular to the running direction ⇒ *fig. 169*. The letters “TWI” or triangles on the tire sidewall indicate the location of the treadwear indicators.

The tires have reached the minimum tread depth <sup>1)</sup> when they have worn down to the treadwear indicators. Replace the tires with new ones ⇒ .

### Wheel rotation

Rotating the wheels regularly is recommended to ensure the tires

wear evenly. To rotate wheels, install the wheels from the rear axle on the front axle and vice versa. This will allow the tires to have approximately the same length of service life.

For unidirectional tires, make sure the tires are installed according to the running direction indicated on the tire sidewall ⇒ *page 245*.

### Hidden damage

Damage to tires and rims can often occur in locations that are hidden. Unusual vibrations in the vehicle or pulling to one side may indicate that there is tire damage. Reduce your speed immediately. Check the tires for damage. If no damage is visible from the outside, drive slowly and carefully to the nearest authorized Audi dealer or authorized Audi Service Facility to have the vehicle inspected.



#### WARNING

Tread that has worn too low or different tread depths on the tires can reduce driving safety. This can especially have a

<sup>1)</sup> Obey any applicable regulations in your country.



negative effect on handling, on the risk aquaplaning when driving through water, when driving through curves and when braking, which increases the risk of an accident.

## Tire pressure

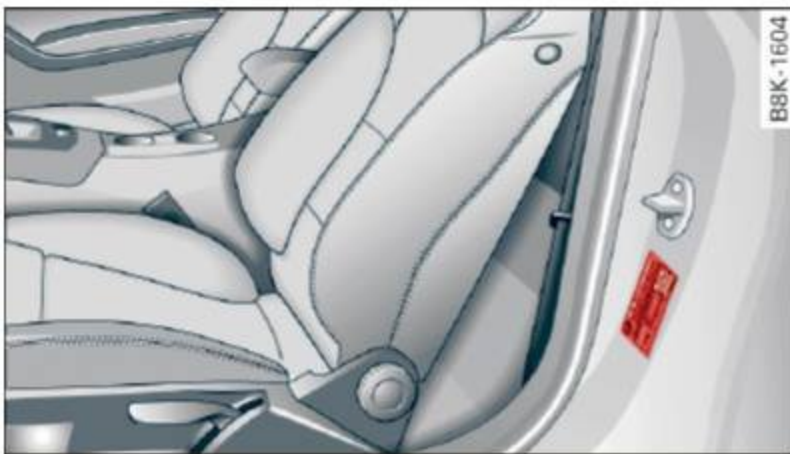

**Fig. 170** Driver's side B-pillar: tire pressure label

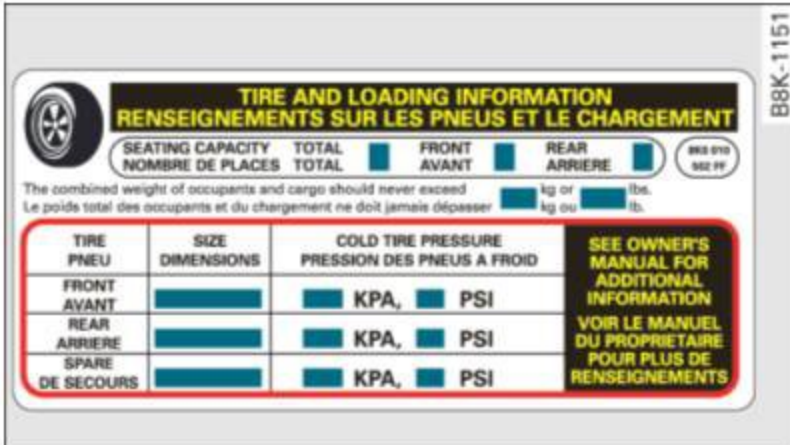

**Fig. 171** Tire pressure label

The correct tire pressure for tires mounted in the factory and for the spare tire\* is indicated on a label. The label is located on the B-pillar ⇒ *fig. 170*, ⇒ *fig. 171*.

When the vehicle is partially loaded (up to 3 people), use the tire pressure specified for normal

loads ⇒ *table on page 226*. If driving the vehicle when fully loaded, you must increase the tire pressure to the maximum specified pressure ⇒ ⚠.

## Checking/correcting tire pressure

- ▶ Check the tire pressure at least once per month and also check it before every long drive.
- ▶ Always check the tire pressure when the tires are *cold*. Do not reduce the pressure if it increases when the tires are warm.
- ▶ Check the label ⇒ *fig. 171* for the correct tire pressure based on vehicle load.
- ▶ Correct the tire pressure if necessary.
- ▶ Vehicles with Tire Pressure Monitoring System\*: store the modified tire pressure in the Infotainment system ⇒ *page 234*.
- ▶ Check the pressure in the emergency tire\*/spare tire\*. Always maintain the maximum temperature that is specified for the tire.

### ⚠ WARNING

Always adapt the tire pressure to your driving style and vehicle load.



- Overloading can lead to loss of vehicle control and increase the risk of an accident. Read and follow the important safety precautions in ⇒ *page 227, Tires and vehicle load limits.*
- The tire must flex more if the tire pressure is too low or if the vehicle speed or load are too high. This heats the tire up too much. This increases the risk of an accident because it can cause the tire to burst and result in loss of vehicle control.
- Incorrect tire pressure increases tire wear and has a negative

effect on driving and braking behavior, which increases the risk of an accident.

 **Note**

Replace lost valve caps to reduce the risk of damage to the tire valves.

 **For the sake of the environment**

Tire pressure that is too low increases fuel consumption.

 **Tips**

Audi recommends using the tire pressure specified for a normal load ⇒ *table on page 226* or for a full load when the vehicle is partially loaded.

## Tire pressure table

Please note that the information contained in the following table was correct at the time of printing, and the information is subject to change. If there are differences between this information and the tire pressures specified on the label on the driver's side B-pillar, always follow the specification on the B-pillar label ⇒ *page 224, fig. 170.*

Make sure that the tire designation on your tire matches the designation on the tire pressure label and the tire pressure table.

The following table lists recommended tire pressures in cold tires according to the load and the size of the tires installed. ▶



## Tires and wheels

Model/ Engine	Tire designation	Tire pressure							
		Normal load (up to 3 people) <sup>a)</sup>				Maximum load			
		front		rear		front		rear	
		PSI	kPA	PSI	kPA	PSI	kPA	PSI	kPA
<b>A3 sedan: 1.8L</b> 4 cylinders (Gasoline engine)	<b>225/45 R17 91Y High Performance</b>	30	210	26	180	35	240	35	240
	<b>225/40 R18 92Y XL High Performance</b>	35	240	32	220	35	240	35	240
	<b>225/45 R17 91H All Season</b>	32	220	29	200	39	270	39	270
	<b>225/40 R18 92H XL All Season</b>	35	240	32	220	39	270	39	270
	<b>235/35 R19 91Y XL High Performance</b>	33	230	32	220	35	240	35	240
<b>A3 sedan: 2.0L</b> 4 cylinders (Gasoline engine)	<b>225/45 R17 91Y High Performance</b>	30	210	28	190	36	250	36	250
	<b>225/40 R18 92Y XL High Performance</b>	35	240	32	220	36	250	36	250
	<b>225/45 R17 91H All Season</b>	33	230	30	210	41	280	41	280
	<b>225/40 R18 92H XL All Season</b>	36	250	33	230	41	280	41	280
	<b>235/35 R19 91Y XL High Performance</b>	35	240	32	220	36	250	36	250
<b>A3 sedan: 2.0L</b> 4 cylinders (Diesel en- gine)	<b>225/45 R17 91Y High Performance</b>	30	210	28	190	36	250	36	250
	<b>225/40 R18 92Y XL High Performance</b>	35	240	32	220	36	250	36	250
	<b>225/45 R17 91H All Season</b>	33	230	30	210	41	280	41	280
	<b>225/40 R18 92H XL All Season</b>	36	250	33	230	41	280	41	280
	<b>235/35 R19 91Y XL High Performance</b>	35	240	32	220	36	250	36	250
<b>S3 sedan: 2.0L</b> 4 cylinders (Gasoline engine)	<b>225/40 R18 92Y XL High Performance</b>	39	270	36	250	42	290	42	290
	<b>225/40 R18 92H XL All Season</b>	38	260	35	240	41	280	41	280
	<b>235/35 R19 91Y XL High Performance</b>	39	270	36	250	44	300	44	300

**XL = reinforced or extra load tire. It may also appear as xl, EXTRA LOAD, or RF on the tire sidewall.**

a) 2 people in the front, 1 person in the rear



**! WARNING**

Please note the important safety precautions regarding tire pressure ⇒ *page 224* and load limits ⇒ *page 227*.

## Tires and vehicle load limits

There are limits to the amount of load or weight that any vehicle and any tire can carry. A vehicle that is overloaded will not handle well and is more difficult to stop. Overloading can not only lead to loss of vehicle control, but can also damage important parts of the vehicle and can lead to sudden tire failure, including a blowout and sudden deflation that can cause the vehicle to crash.

Your safety and that of your passengers also depends on making sure that load limits are not exceeded. Vehicle load includes everybody and everything in and on the vehicle. These load limits are technically referred to as the vehicle's **Gross Vehicle Weight Rating** ("GVWR").

The "GVWR" includes the weight of the basic vehicle, all factory installed accessories, a full tank of fuel, oil, coolant and other fluids

plus maximum load. The maximum load includes the number of passengers that the vehicle is intended to carry ("seating capacity") with an assumed weight of 150 lbs. (68 kg) for each passenger at a designated seating position and the total weight of any luggage in the vehicle. If you tow a trailer, the weight of the trailer hitch and the tongue weight of the loaded trailer must be included as part of the vehicle load.

The **Gross Axle Weight Rating** ("GAWR") is the maximum load that can be applied at each of the vehicle's two axles.

The fact that there is an upper limit to your vehicle's Gross Vehicle Weight Rating means that the total weight of whatever is being carried in the vehicle (including the weight of a trailer hitch and the tongue weight of the loaded trailer) is limited. The more passengers in the vehicle or passengers who are heavier than the standard weights assumed mean that less weight can be carried as luggage.

The Gross Vehicle Weight Rating and the Gross Axle Weight Rating ►



are listed on the safety compliance sticker label located on the driver's side B-pillar ⇒ *page 224, fig. 170.*

 **WARNING**

Overloading a vehicle can cause loss of vehicle control, a crash or other accident, serious personal injury, and even death.

- Carrying more weight than your vehicle was designed to carry will prevent the vehicle from handling properly and increase the risk of the loss of vehicle control.
- The brakes on a vehicle that has been overloaded may not be able to stop the vehicle within a safe distance.
- Tires on a vehicle that has been overloaded can fail suddenly, including a blowout and sudden deflation, causing loss of control and a crash.
- Always make sure that the total load being transported – including the weight of a trailer hitch and the tongue weight of a loaded trailer – does not make the vehicle heavier than the vehicle's Gross Vehicle Weight Rating.

## Determining correct load limit

Use the example below to calculate the total weight of the passengers and luggage or other things that you plan to transport so that you can make sure that your vehicle will not be overloaded.

### Steps for Determining Correct Load Limit

1. Locate the statement “THE COMBINED WEIGHT OF OCCUPANTS AND CARGO SHOULD NEVER EXCEED XXX KG OR XXX LBS” on your vehicle's placard (tire inflation pressure label) ⇒ *page 224, fig. 170.*
2. Determine the combined weight of the driver and passengers that will be riding in your vehicle.
3. Subtract the combined weight of the driver and passengers from “XXX” kilograms or “XXX” pounds shown on the sticker ⇒ *page 224, fig. 170.*
4. The resulting figure equals the available amount of cargo and luggage load capacity. For example, if the “XXX” amount equals 1400 lbs. and there will ▶



be five 150 lbs. passengers in your vehicle, the amount of available cargo and luggage load capacity is 650 lbs.

(1400-750 (5 x 150) = 650 lbs.)

5. Determine the combined weight of luggage and cargo being loaded on the vehicle. That weight may not safely exceed the available cargo and luggage load capacity calculated in Step 4.
  6. If your vehicle will be towing a trailer, load from your trailer will be transferred to your vehicle. Consult this manual to determine how this reduces the available cargo and luggage load capacity of your vehicle.
- ▶ Check the tire sidewall (⇒ *page 214, fig. 168*) to determine the designated load rating for a specific tire.

### Wheel bolts and rims

#### Wheel bolts

Wheel bolts must be clean and loosen/tighten easily.

#### Rims

Rims with a bolted rim ring\* or with bolted wheel covers\* consist of multiple pieces. These components were bolted together using special bolts and a special procedure. You must not repair or disassemble them ⇒ ⚠.

#### WARNING

Wheel bolts that are tightened or repaired incorrectly can become loose and result in loss of vehicle control, which increases the risk of an accident. For the correct tightening specification, refer to ⇒ *page 242, After changing a wheel.*

- Always keep the wheel bolts and the threads in the wheel hub clean and free of grease.
- Only use wheel bolts that fit the rim.
- Always have damaged rims repaired by an authorized Audi dealer or authorized Audi Service Facility. Never repair or disassemble rims yourself, because this increases the risk of an accident.

### Winter tires

Winter tires significantly improve the vehicle's handling when driving in winter conditions. Because of their construction (width, compound, tread pattern), summer tires provide less traction on ice and snow.

- ▶ Use winter tires on all four wheels.
- ▶ Only use winter tires that are approved for your vehicle.
- ▶ Please note that the maximum permitted speed may be lower with winter tires ⇒ ⚠. An authorized Audi dealer or authorized Audi Service Facility can inform you about the maximum permitted speed for your tires.
- ▶ Check the tire pressure after installing wheels ⇒ *page 224.*

The effectiveness of winter tires is reduced greatly when the tread is worn down to a depth of 0.157 inch (4 mm). The characteristics of winter tires also decrease greatly as the tire ages, regardless of the remaining tread.

#### WARNING

- Never drive faster than the maximum permitted speed for your tires. This could cause the tires to heat up too much. This increases the risk of an accident because it can cause the tire to burst.



- Always adapt your driving to the road and traffic conditions. Drive carefully and reduce your speed on icy or slippery roads. Even winter tires can lose traction on black ice.



### For the sake of the environment

Reinstall summer tires at the appropriate time, because they provide better handling when roads are free of snow and ice. Summer tires cause less road noise, tire wear and fuel consumption.



### Tips

You can also use all season tires instead of winter tires. Please note that in some countries where winter tires are required, only winter tires with the  symbol may be permitted.

## Snow chains

*Snow chains improve traction in the snow.*

- ▶ Only install snow chains on the *front* wheels. This applies also to vehicles with all wheel drive\*.
- ▶ Check and correct the seating of the snow chains if necessary after driving a few feet. Follow the instructions from the manufacturer.
- ▶ Note the maximum permitted speed when driving with snow chains. Do not exceed 30 mph (50 km/h).

Snow chains not only improve the *driving* in winter road conditions, but also the *braking*.

Use of snow chains is only permitted with certain rim/tire combinations due to technical reasons. Check with an authorized Audi dealer or authorized Audi Service Facility to see if you may use snow chains.

Use **fine-mesh snow chains**. They must not add more than 0.53 inch (13.5 mm) in height, including the chain lock.

You must remove the chains when driving on roads that are *free* of snow. When roads are free of snow, snow chains can impair handling and

damage the tires, and the chains will quickly be destroyed.



### WARNING

Using incorrect snow chains or installing snow chains incorrectly can result in loss of vehicle control, which increases the risk of an accident.



### Note

- Snow chains can damage the rims/wheel covers\* if the chains come into direct contact with them. Remove the wheel covers\* first. Use coated snow chains.

## Low aspect ratio tires

Your Audi is factory-equipped with low aspect ratio tires. These tires have been thoroughly tested and been selected specifically for your model for their superb performance, road feel and handling under a variety of driving conditions. Ask your authorized Audi dealer for more details.

The low aspect ratio of these tires is indicated by a numeral of **55 or less** in the tire's size designation. The numeral represents the ratio of the tire's sidewall height in relation to its tread width expressed in percentage. Conventional tires have a height/width ratio of 60 or more.

**The performance of low-aspect-ratio tires is particularly sensitive to improper inflation pressure. It is therefore important that low aspect ratio tires are inflated to the specified pressure and that the inflation pressure is regularly checked and maintained. Tire pressures should be checked at least once a month and always before a long trip ⇒ page 224.**

### What you can do to avoid tire and rim damage

Low aspect ratio tires can be damaged more easily by impact with potholes, curbs, gullies or ridges on the road, particularly if the tire is underinflated. ▶



In order to minimize the occurrence of impact damage to the tires of your vehicle, we recommend that you observe the following precautions:

- Always maintain recommended inflation pressures. Check your tire pressure every 2,000 miles (3,000 km) and add air if necessary.
- Drive carefully on roads with potholes, deep gullies or ridges. The impact from driving through or over such obstacles can damage your tires. Impact with a curb may also cause damage to your tires.
- After any impact, immediately inspect your tires or have them inspected by the nearest authorized Audi dealer. Replace a damaged tire as soon as possible.
- Inspect your tires every 2,000 miles (3,000 km) for damage and wear. Damage is not always easy to see. Damage can lead to loss of air and underinflation, which could eventually cause tire failure. If you believe that a tire may have been damaged, replace the tire as soon as possible.
- These tires may wear more quickly than others.
- Please also remember that, while these tires deliver responsive handling, they may ride less comfortably and make more noise than other choices.

### Reduced performance in winter/cold season conditions

All tires are designed for certain purposes. The low aspect ratio, ultra high performance tires originally installed on your vehicle are intended for maximum dry and wet road performance and handling. They are not suitable for cold, snowy or icy weather conditions. If you drive under those circumstances, you should equip your vehicle with all-season or winter tires, which offer better traction under those conditions. We suggest you use the recommended snow or all-season tires specified for your vehicle, or their equivalent.

Refer to ⇒ *page 229* for more detailed information regarding winter tires.

### Uniform tire quality grading

- Tread wear

- Traction AA A B C
- Temperature A B C

Quality grades can be found where applicable on the tire side wall between tread shoulder and maximum section width ⇒ *page 214, fig. 168*.

**For example:** Tread wear **200**, Traction **AA**, Temperature **A**.

All passenger car tires must conform to Federal Safety Requirements in addition to these grades.

### Tread wear

The *tread wear* grade is a comparative rating based on the wear rate of the tire when tested under controlled conditions on a specified government test course.

For example, a tire graded 150 would wear one and one half (1 1/2) times as well on the government course as a tire graded 100.

The relative performance of tires depends upon the actual conditions of their use, however, and may depart significantly from the norm due to variations in driving habits, service practices and differences in road characteristics and climate.

### Traction

The *traction* grades, from highest to lowest, are AA, A, B and C. Those grades represent the tire's ability to stop on wet pavement as measured under controlled conditions on specified government test surfaces of asphalt and concrete. A tire marked C may have poor traction performance ⇒ .

### Temperature

The *temperature* grades are A (the highest), B, and C, representing the tire's resistance to the generation of heat and its ability to dissipate heat when tested under controlled conditions on a specified indoor laboratory test wheel.

Sustained high temperature can cause the material of the tire to degenerate and reduce tire life, and excessive temperature can lead to sudden tire failure ⇒ .



The grade C corresponds to a level of performance which all passenger car tires must meet under the Federal Motor Vehicle Safety Standard No. 109. Grades B and A represent higher levels of performance on the laboratory test wheel than the minimum required by law.

### WARNING

The traction grade assigned to this tire is based on straight-ahead braking traction tests, and does not include acceleration, cornering, hydroplaning or peak traction characteristics.

### WARNING

The temperature grade for this tire is established for a tire that is properly inflated and not overloaded. Excessive speed, underinflation, or excessive loading, either separately or in combination, can cause heat buildup and possible tire failure.

### WARNING

Temperature grades apply to tires that are properly inflated and not over or underinflated.

## Tire pressure monitoring system

### General notes

Applies to vehicles: with tire pressure monitoring system

Each tire, including the spare (if provided), should be checked monthly when cold and inflated to the inflation pressure recommended by the vehicle manufacturer on the vehicle placard or tire inflation pressure label. (If your vehicle has tires of a different size than the size indicated on the vehicle placard or tire inflation pressure label, you should determine the proper tire inflation pressure for those tires).

As an added safety feature, your vehicle has been equipped with a tire pressure monitoring system (TPMS) that illuminates a low tire pressure telltale when one or more of your tires is significantly under-inflated. Accordingly, when the low tire pressure telltale illuminates, you should stop and

check your tires as soon as possible, and inflate them to the proper pressure. Driving on a significantly under-inflated tire causes the tire to overheat and can lead to tire failure. Under-inflation also reduces fuel efficiency and tire tread life, and may affect the vehicle's handling and stopping ability.

Please note that the TPMS is not a substitute for proper tire maintenance, and it is the driver's responsibility to maintain correct tire pressure, even if under-inflation has not reached the level to trigger illumination of the TPMS low tire pressure telltale.

Your vehicle has also been equipped with a TPMS malfunction indicator to indicate when the system is not operating properly. The TPMS malfunction indicator is combined with the low tire pressure telltale. When the system detects a malfunction, the telltale will flash for approximately one minute and then remain continuously illuminated. This sequence will continue upon subsequent vehicle start-ups as long as the malfunction exists.

When the malfunction indicator is illuminated, the system may not be able to detect or signal low tire pressure as intended. TPMS malfunctions may occur for a variety of reasons, including the installation of replacement or alternate tires or wheels on the vehicle that prevent the TPMS from functioning properly. Always check the TPMS malfunction telltale after replacing one or more tires or wheels on your vehicle to ensure that the replacement or alternate tires and wheels allow the TPMS to continue to function properly.



## If the Tire Pressure Monitoring System indicator appears

Applies to vehicles: with tire pressure monitoring system

The tire pressure indicator in the instrument cluster informs you if the tire pressure is too low or if there is a system malfunction.

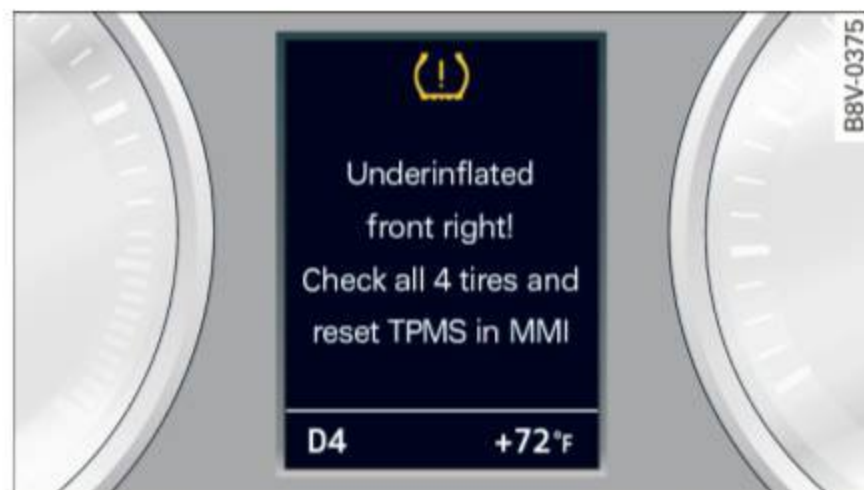



Fig. 172 Instrument cluster: indicator light with message



Using the ABS sensors, the tire pressure monitoring system compares the tire tread circumference and vibration characteristics of the individual tires. If the pressure changes in one or more tires, this is indicated in the instrument cluster display with an indicator light  and a message  $\Rightarrow$  fig. 172. If only one tire is affected, the location of that tire will be indicated. The message turns off after a few minutes. You can display the message again  $\Rightarrow$  page 29.

The tire pressures must be stored in the menu display again each time the pressures change (switching between partial and full load pressure) or after changing or replacing a tire on your vehicle  $\Rightarrow$  page 234. The tire pressure monitoring system only monitors the tire pressure you have stored. You can find the recommended tire pressures for your vehicle on the label on the driver's door pillar  $\Rightarrow$  page 224.

Tire tread circumference and vibration characteristics can change and cause a tire pressure warning if:

- If the tire pressure in one or more tires is too low,
- the tire has structural damage,
- The tire was replaced or the tire pressure changed and it was not stored again  $\Rightarrow$  page 234.
- the spare tire is installed.

## Indicator lights

 - Loss of pressure in at least one tire  $\Rightarrow$  . Check the tires and replace or repair if necessary. Check/correct the pressures of all four tires. Then store the tire pressures in the MMI  $\Rightarrow$  page 234.

**TPMS** (Tire Pressure Monitoring System) **Tire pressure: System malfunction!** If **TPMS** appears after switching the ignition on or while driving and the  indicator light in the instrument cluster blinks for approximately one minute and then stays on, there is system malfunction. Try to store the correct tire pressures  $\Rightarrow$  page 234. If the indicator light does turn off or turns on again after a short period of time, drive to an authorized Audi dealer or authorized Audi Service Facility immediately to have the malfunction corrected.

### WARNING

- If the tire pressure warning light  in the instrument cluster turns on, the pressure in one or more tires is too low. Reduce the vehicle speed immediately and avoid any hard steering or braking maneuvers. Stop as soon as possible, check the tire and inflate the tire to the correct pressure, which is specified on the tire pressure label on the vehicle  $\Rightarrow$  page 224. Driving with a tire with low pressure causes the tire to overheat and can result in failure of the tire. Low pressure can also have a negative effect on the driving and braking behavior of the vehicle.
- The driver is responsible for maintaining the correct tire pressures. You must check the tire pressures regularly.
- Under certain conditions (such as a sporty driving style, winter conditions or unpaved roads), the pressure monitor indicator may be delayed.
- Do not use run-flat tires on your vehicle. Using them when not permitted can lead to vehicle damage or accidents.

### Tips

- The tire pressure monitoring system can also stop working when there is an ESC malfunction.



- Using snow chains may result in a system malfunction.
- The tires with the identification “AO” or “RO” ⇒ *page 221* have been matched with your Audi tire pressure monitoring system. We recommend that you use these tires.
- The tire pressure monitoring system can only monitor the tire pressure of the driving tires. Check the tire pressure of the spare wheel in the luggage compartment so that if necessary it is ready for use.

### Storing tire pressures

Applies to vehicles: with tire pressure monitoring system

*A change in tire pressure or a change in tires must be stored in the system.*

The tire pressure is stored in the MMI.

- ▶ Make sure before storing that the tire pressures of all four tires meet the specified values and are adapted to the load. Otherwise the system could malfunction ⇒ *page 224*.
- ▶ Switch on the ignition.
- ▶ Select: the **MENU** button > **Car** > **Systems\*** control button > **Service & control** > **Tire pressure monitor** > **Store tire pressure** > **Yes, store now**.

### Tips

Do not store the tire pressures if snow chains are installed. Otherwise the system could malfunction.



## Care and cleaning

### General information

Regular, proper care helps to maintain your vehicle's value. It can also be a requirement when submitting warranty claims for corrosion damage and paint defects on the body.

The necessary care products can be obtained from an authorized Audi dealer or authorized Audi Service Facility. Read and follow the instructions for use on the packaging.

#### WARNING

- Using cleaning and care products incorrectly can be dangerous to your health.
- Always store cleaning and care products out of reach of children to reduce the risk of poisoning.

#### For the sake of the environment

- Preferably use environmentally-friendly products when buying cleaning agents.
- Do not dispose of leftover cleaning and care products with household trash.

### Car washes

The longer that deposits such as insects, bird droppings, tree sap or road salt remain on the vehicle, the more the surface can be damaged. High temperatures such as those caused by sunlight increase the damaging effect.

Before washing, rinse off heavy deposits with plenty of water.

Stubborn deposits such as bird droppings or tree sap are best removed with plenty of water and a microfiber cloth.

Also, wash the underside of your vehicle once road salt stops being used for the season.

#### Pressure washers

When washing your vehicles with a pressure washer, always follow the operating instructions provided with the pressure washer. This is especially important in regard to the pressure and spraying distance. Do not aim the spray directly

at seals on side windows, doors, the hood, the luggage compartment lid or the sunroof\* or at tires, rubber hoses, insulating material, sensors\* or camera lenses\*. Keep a distance of at least 16 inches (40 cm).

Do not remove snow and ice with a pressure washer.

Never use rotary nozzles or high pressure nozzles.

The water temperature must not be above 140 °F (60 °C).

#### Automatic car washes

Spray off the vehicle before washing.

Make sure that the windows and roof\* are closed and the windshield wipers are off. Follow instructions from the car wash operator, especially if there are accessories attached to your vehicle.

If possible, use car washes that do not have brushes.

#### Washing by hand

Clean the vehicle starting from the top and working down using a soft sponge or cleaning brush. Use solvent-free cleaning products.

#### Washing vehicles with matte finish paint by hand

To avoid damaging the paint when washing, first remove dust and large particles from your vehicle. Insects, grease spots and fingerprints are best removed with a special cleaner for matte finish paint.

Apply the product using a microfiber cloth. To avoid damaging the paint surface, do not use too much pressure.

Rinse the vehicle thoroughly with water. Then clean using a neutral shampoo and a soft microfiber cloth.

Rinse the vehicle thoroughly again and let it air dry. Remove any water residue using a shammy. ►



 **WARNING**

- Only wash the vehicle when the ignition is off and follow the instructions from the car wash operator to reduce the risk of accidents.
- To reduce the risk of cuts, protect yourself from sharp metal components when washing the underbody or the inside of the wheel housings.
- After washing the vehicle, the braking effect may be delayed due to moisture on the brake rotors or ice in the winter. The brakes must be dried first with a few careful brake applications.

 **Note**

- If you wash the vehicle in an automatic car wash, you must fold the exterior mirrors in to reduce the risk of damage to the mirrors. Power folding exterior mirrors\* must only be folded in and out using the power folding function.

- To prevent paint damage, do not wash the vehicle in direct sunlight.
- To reduce the risk of damage to the surface, do not use insect removing sponges, kitchen sponges or similar items.
- Matte finish painted vehicle components:
  - To reduce the risk of damage to the surface, do not use polishing agents or hard wax.
  - Never use protective wax. It can destroy the matte finish effect.
  - Do not place any stickers or magnetic signs on vehicle parts painted with matte finish paint. The paint could be damaged when the stickers or magnets are removed.

 **For the sake of the environment**

Only wash the vehicle in facilities specially designed for that purpose. This will reduce the risk of dirty water contaminated with oil from entering the sewer system.

## Cleaning and care information

When cleaning and caring for individual vehicle components, refer to the following tables. The information contained there is simply recommendations. For questions or for components that

are not listed, consult an authorized Audi dealer or authorized Audi Service Facility. Also follow the information found in ⇨ .

### Exterior cleaning

Component	Situation	Solution
<b>Windshield wiper blades</b>	Deposits	⇨ page 50, <i>Cleaning windshield wiper blades</i>
<b>Headlights/ Tail lights</b>	Deposits	Soft sponge with a mild soap solution <sup>a)</sup>
<b>Sensors/ camera lenses</b>	Deposits	Sensors: soft cloth with solvent-free cleaning solution Camera lenses: soft cloth with alcohol-free cleaning solution
	Snow/ice	Hand brush/solvent-free de-icing spray
<b>Wheels</b>	Road salt	Water
	Brake dust	Acid-free special cleaning solution
<b>Exhaust tail pipes</b>	Road salt	Water, cleaning solution suitable for stainless steel, if necessary
<b>Decorative parts/ trim</b>	Deposits	Mild soap solution <sup>a)</sup> , a cleaning solution suitable for stainless steel, if necessary



Component	Situation	Solution
<b>Paint</b>	Paint damage	Refer to the paint number on the vehicle data label, repair with touch up paint ⇒ <i>page 258</i>
	Spilled fuel	Rinse with water immediately
	Surface rust	Rust remover, then protect with hard wax; for questions, consult an authorized Audi dealer or authorized Audi Service Facility.
	Corrosion	Have it removed by an authorized Audi dealer or authorized Audi Service Facility.
	Water no longer beads on the surface of clean paint	Protect with hard wax (at least twice per year)
	No shine even though paint has been protected/paint looks poor	Treat with suitable polish; then apply paint protectant if the polish that was used does not contain any protectant
	Deposits such as insects, bird droppings, tree sap and road salt	Dampen with water immediately and remove with a micro-fiber cloth
	Grease-based contaminants such as cosmetics or sunblock	Remove immediately with a mild soap solution <sup>a)</sup> and a soft cloth
<b>Carbon parts</b>	Deposits	clean the same way as painted parts ⇒ <i>page 235</i>
<b>Decorative decals</b>	Deposits	Soft sponge with a mild soap solution <sup>a)</sup>

<sup>a)</sup> Mild soap solution: maximum two tablespoons of neutral soap in 1 quart (1 liter) of water

### Internal cleaning

Component	Situation	Solution
<b>Windows</b>	Deposits	Glass cleaner, then wipe dry
<b>Decorative parts/trim</b>	Deposits	Mild soap solution <sup>a)</sup>
<b>Plastic parts</b>	Deposits	Damp cloth
	Heavier deposits	Mild soap solution <sup>a)</sup> , detergent-free plastic cleaning solution, if necessary
<b>Displays</b>	Deposits	Soft cloth with LCD cleaner
<b>Controls</b>	Deposits	Soft brush, then a soft cloth with a mild soap solution <sup>a)</sup>
<b>Safety belts</b>	Deposits	Mild soap solution <sup>a)</sup> , allow to dry before letting them retract



## Care and cleaning

Component	Situation	Solution
<b>Textiles artificial leather, Alcantara</b>	Deposits adhering to the surface	Vacuum cleaner
	Water-based deposits such as coffee, tea, blood, etc.	Absorbent cloth and mild soap solution <sup>a)</sup>
	Oil-based deposits such as oil, make-up, etc.	Apply a mild soap solution <sup>a)</sup> , blot away the dissolved oil or dye, treat afterward with water, if necessary
	Special deposits such as ink, nail polish, latex paint, shoe polish, etc.	Special stain remover, blot with absorbent material, treat afterward with mild soap solution, if necessary <sup>a)</sup>
<b>Natural leather</b>	Fresh stains	Wool cloth with a mild soap solution <sup>a)</sup>
	Water-based deposits such as coffee, tea, blood, etc.	fresh stains: absorbent cloth dried stains: stain remover suitable for leather
	Oil-based deposits such as oil, make-up, etc.	Fresh stains: absorbent cloth and stain remover suitable for leather dried stains: oil cleaning spray
	Special deposits such as ink, nail polish, latex paint, shoe polish, etc.	Spot remover suitable for leather
	Care	Regularly apply conditioning cream that protects from light and penetrates into the material. Use specially-colored conditioning cream, if necessary.
<b>Carbon parts</b>	Deposits	clean the same way as plastic parts

<sup>a)</sup> Mild soap solution: maximum two tablespoons of neutral soap in 1 quart (1 liter) of water

### **WARNING**

The windshield may not be treated with water-repelling windshield coating agents. Unfavorable conditions such as wetness, darkness, or low sun can result in increased glare. Wiper blade chatter is also possible.

### **Note**

- **Headlights/tail lights**
  - Never clean headlights or tail lights with a dry cloth or sponge.
  - Do not use any cleaning product that contains alcohol, because they could cause cracks to form.
- **Wheels**

- Never use any paint polish or other abrasive materials.
- Damage to the protective layer on the rims such as stone chips or scratches must be repaired immediately.
- **Sensors/camera lenses**
  - Never use warm or hot water to remove snow or ice from the camera lens. This could cause the lens to crack.
  - Never use abrasive cleaning materials or alcohol to clean the camera lens. This could cause scratches and cracks.
- **Door windows**
  - Remove snow and ice on windows and exterior mirrors with a plastic scraper. To



avoid scratches, move the scraper only in one direction and not back and forth.

- Never remove snow or ice from door windows and mirrors using warm or hot water because this could cause cracks to form.
- To avoid damage to the rear window defogger, do not apply any stickers on the heating wires on the inside of the window.
- **Decorative parts/trim**
  - Never use chrome care or cleaning products.
- **Paint**
  - To reduce the risk of scratches, the vehicle must be free of dirt and dust before polishing or waxing.
  - To prevent paint damage, do not polish or wax the vehicle in direct sunlight.
  - To reduce the risk of paint damage, do not polish away rust spots.
  - Remove cosmetics and sunscreen immediately - these could damage the paint.
- **Displays**
  - To avoid scratches, do not use dry cleaning methods on displays.
- **Controls**
  - Make sure that no fluids enter the controls, because this could cause damage.
- **Safety belts**
  - Do not remove the safety belts to clean them.
  - Never clean safety belts or their components chemically or with corrosive fluids or solvents and never allow sharp objects to come into contact with the safety belts. This could cause damage to the belt webbing.
  - If there is damage to the webbing, the connections, the retractors or the buckles, have them replaced by an authorized Audi dealer or authorized Audi Service Facility.
- **Textiles/artificial leather/Alcantara**
  - Never treat artificial leather/Alcantara with leather care products, solvents, floor polish, shoe polish, spot remove or similar products.
  - Have a specialist remove stubborn stains to prevent damage.

- Never use steam cleaners, brushes, hard sponges, etc. when cleaning.
- Do not turn on the seat heating\* to dry the seat.
- Objects with sharp edges such as zippers, rivets on clothing or belts can cause damage to the surface.
- Open hook and loop fasteners, for example on clothing, can damage seat covers. Make sure hook and loop fasteners are closed.

#### – **Natural leather**

- Never treat leather with solvents, floor polish, shoe polish, spot remover or similar products.
- Objects with sharp edges such as zippers, rivets on clothing or belts can cause damage to the surface.
- Never use steam cleaners, brushes, hard sponges, etc. when cleaning.
- Do not turn on the seat heating\* to dry the seat.
- To help prevent the leather from fading, do not leave the vehicle in direct sunlight for long periods of time. If leaving the vehicle parked for long periods of time, you should cover the leather to protect it from direct sunlight.

#### **Tips**

- Insects are easier to remove from paint that has been freshly waxed.
- Regular waxing can prevent rust spots from forming.



## Emergency assistance

### Luggage compartment lid emergency release

The luggage compartment can be opened from the inside in an emergency.



Fig. 173 Section of the luggage compartment: access to the emergency release

To reach the emergency release mechanism, the rear bench seat backrest must be folded down  
⇒ page 60

- ▶ Push the latch upward in the direction of the arrow until the lock releases.

The trunk escape handle inside the rear lid is made of fluorescent material to glow in the dark.

#### WARNING

The trunk escape handle is to be used only in an emergency.

#### Tips

The emergency release lever should *never* be used as a handle for closing the rear lid.

### General information

- ▶ Park the vehicle as far as possible from moving traffic in the event of a flat tire. In the event of a flat tire, park the vehicle on a level surface. If you are on a steep incline, be especially careful.
- ▶ Set the parking brake.
- ▶ Place the selector lever in the P position.
- ▶ Switch the emergency flashers on.
- ▶ Put on a reflective vest, if available.
- ▶ Set up the warning triangle, if available.

- ▶ Have the passengers exit the vehicle. They should move to a safe place, for example behind a guard rail.

#### WARNING

Pay attention to the steps above. They are for your protection and the for the safety of other drivers.

#### WARNING

Improper use of the vehicle jack can cause serious personal injuries.

- Never use the screw driver hex head to tighten wheel bolts, since the bolts cannot attain the necessary tightening torque if you use the hex head, potentially causing an accident.
- The factory-supplied jack is intended only for your vehicle model. Under no circumstances should it be used to lift heavy vehicles or other loads; you risk injuring yourself.
- Never start the engine when the vehicle is raised, which could cause an accident.
- Support the vehicle securely with appropriate stands if work is to be performed underneath the vehicle; otherwise, there is a potential risk for injury.
- Never use the jack supplied with your Audi on another vehicle, particularly on a heavier one. The jack is only suitable for use on the vehicle it came with.

#### Tips

- Some of the onboard items listed above are provided on certain models only or are optional extras.
- Before storing the jack\*, make sure it is wound back down as far as it will go.



## Equipment

### Vehicle tool kit

Applies to vehicles: with vehicle tool kit



**Fig. 174** Luggage compartment: cargo floor cover folded upward

The vehicle tool kit is located in the luggage compartment under the cargo floor cover ⇒ *fig. 174*.

### Cargo floor cover

- ▶ Hang the plastic hook on the luggage compartment weather strip -arrow-.

## Replacing wheels

### Before changing a wheel

Observe the following precautions for your own and your passenger's safety when changing a wheel.

- ▶ After you experience a tire failure, pull the car well away from moving traffic and try to reach **level** ground before you stop ⇒ ⚠.
- ▶ All passengers should **leave the car** and move to a safe location (for instance, behind the guardrail) ⇒ ⚠.
- ▶ Engage the **parking brake** to prevent your vehicle from rolling unintentionally ⇒ ⚠.
- ▶ Move **selector lever to position P** ⇒ ⚠.
- ▶ If you are towing a trailer, unhitch the trailer from your vehicle.
- ▶ Take the **jack** ⇒ *page 241* and the **spare tire** ⇒ *page 246* out of the luggage compartment.

### ⚠ WARNING

You or your passengers could be injured while changing a wheel if you do not follow these safety precautions:

- If you have a flat tire, move a safe distance off the road. Turn off the engine, turn the emergency flashers on and use other warning devices to alert other motorists.
- Make sure that passengers wait in a safe place away from the vehicle and well away from the road and traffic.
- To help prevent the vehicle from moving suddenly and possibly slipping off the jack, always fully set the parking brake and block the wheel diagonally opposite the wheel being changed. When one front wheel is lifted off the ground, placing the Automatic Transmission in P (Park) will *not* prevent the vehicle from moving.
- Before you change a wheel, be sure the ground is level and firm. If necessary, use a sturdy board under the jack.
- Always store the vehicle tool kit, the jack and the replaced tire in the luggage compartment ⇒ *page 136*.

### Changing a wheel

When you change a wheel, follow the sequence described below step-by-step and in exactly that order.

1. Remove the **decorative wheel cover\***. For more details see also ⇒ *page 242, Decorative wheel covers* or ⇒ *page 242, Wheels with wheel bolt caps*.
2. Loosen the **wheel bolts** ⇒ *page 243*.
3. Locate the proper mounting point for the jack and align the jack below that point ⇒ *page 243*.
4. **Raise** the car with the jack ⇒ *page 243*.
5. Remove the **wheel with the flat tire** and then install **the spare** ⇒ *page 244*.
6. Tighten all wheel bolts lightly.
7. **Lower** the vehicle with the jack.
8. Use the wheel bolt wrench and **firmly** tighten all wheel bolts ⇒ *page 243*.
9. Replace the decorative **wheel cover\***. ▶



### WARNING

Always read and follow all WARNINGS and information ⇒  in *Raising the vehicle on page 244* and ⇒ *page 245*.

### After changing a wheel

*A wheel change is not complete without the doing the following.*

- ▶ Always store the vehicle tool kit, the jack\* and the replaced tire in the luggage compartment ⇒ *page 136*.
- ▶ Check the **tire pressure** on the spare wheel immediately after mounting it.
- ▶ As soon as possible, have the **tightening torques** on all wheel bolts checked with a torque wrench. The correct tightening torque is 90 ft lb (120 Nm).
- ▶ Have the flat tire **replaced** as soon as possible.

### Tips

- If you notice that the wheel bolts are corroded and difficult to turn while changing a tire, they should be replaced before you check the tightening torque.
- Drive at reduced speed until you have the tightening torques checked.
- After changing a wheel, the tire pressure in all four tires must be checked/corrected and the tire pressure monitoring indicator must be stored in the MMI ⇒ *page 234*.

### Decorative wheel covers

Applies to vehicles: with decorative wheel covers

*The decorative wheel covers must be removed first to access the wheel bolts.*



Fig. 175 Changing a wheel: Removing the wheel cover

### Removing

- ▶ Insert the **hook** (provided with the vehicle tool kit) in the hole in the wheel hub cover.
- ▶ Pull off the **decorative wheel cover** ⇒ *fig. 175*.

### Wheels with wheel bolt caps

Applies to vehicles: with wheel bolts with caps

*The caps must be removed first from the wheel bolts before the bolts can be unscrewed.*



Fig. 176 Changing a wheel: removing the wheel bolt caps

### Removing

- ▶ Push the **plastic clip** (provided with the vehicle tool kit) over the wheel bolt cap until the inner retainers on the clip align with the edge of the cover.
- ▶ Remove the cap with the **plastic clip** (vehicle tool kit) ⇒ *fig. 176*.

### Refitting

- ▶ Place the caps over the wheel bolts and push them back on.

The caps are to protect and keep the wheel bolts clean.



## Loosening and tightening the wheel bolts

The wheel bolts must be loosened before raising the vehicle.



Fig. 177 Changing a wheel: loosening the wheel bolts

### Loosening

- ▶ Slide the **wheel wrench** onto the wheel bolt as far as it will go.
- ▶ Take tight hold of the *end* of the wrench handle and turn the wheel bolts **counter-clockwise** about *one single* turn in the direction of arrow ⇒ *fig. 177*.

### Tightening

- ▶ Slide the wheel wrench onto the wheel bolt as far as it will go.
- ▶ Take tight hold of the *end* of the wrench handle and turn each wheel bolt **clockwise** until it is seated.

### ⚠ WARNING

- Do not use force or hurry when changing a wheel - you can cause the vehicle to slip off the jack and cause serious personal injuries.
- *Do not* loosen the wheel bolts *more than one turn* before you raise the vehicle with the jack. - You risk an injury.

### i Tips

- Never use the hexagonal socket in the handle of the screwdriver to loosen or tighten the wheel bolts.
- If a wheel bolt is very tight, you may find it easier to loosen by carefully pushing down on the end of the wheel bolt wrench with *one foot only*. As you do so, hold on to the

car to keep your balance and take care not to slip.

## Raising the vehicle

The vehicle must be lifted with the jack first before the wheel can be removed.



Fig. 178 Sill panels: markings

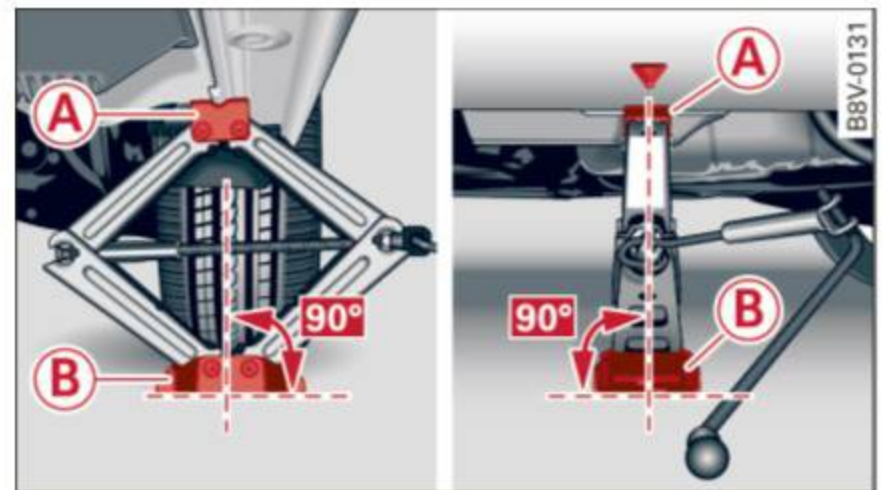

Fig. 179 Sill: positioning the vehicle jack

- ▶ Engage the **parking brake** to prevent your vehicle from rolling unintentionally.
- ▶ Move the **selector lever to position P**.
- ▶ Find the **marking** (imprint) on the sill that is nearest the wheel that will be changed ⇒ *fig. 178*. Behind the marking, there is a **lifting point** on the sill for the vehicle jack.
- ▶ Vehicles with a sill: Note the position of the sill when positioning the vehicle jack ⇒ *fig. 179*.
- ▶ Place the vehicle jack (vehicle tool kit) on a firm surface. Use a flat, stable support if necessary. On a slippery surface such as tile, you should use a non-slip pad (such as a rubber mat) .
- ▶ Turn the **vehicle jack** located under the lifting point on the sill to raise the jack until its arm (A) ⇒ *fig. 179* is located under the designated plastic mount ⇒ ⚠, ⇒ !.
- ▶ Align the jack so that its arm (A) ⇒ *fig. 179* engages in the designated lifting point in the door sill and the movable base (B) lies flat on the



ground. The base **(B)** must be *vertical* under the lifting point **(A)**.

- ▶ Wind the jack up further until the flat tire comes off the ground ⇒ ⚠.

Position the vehicle jack **only** under the designated lifting points on the sill ⇒ *fig. 178*. There is exactly *one* location for each wheel. The jack must not be positioned at any other location ⇒ ⚠ ⇒ ⚠.

An **unstable surface** under the jack can cause the vehicle to slip off the jack. Always provide a firm base for the jack on the ground. If necessary place a sturdy board or similar support under the jack. On **hard, slippery surfaces** (such as tiles) use a rubber mat or similar to prevent the jack from slipping ⇒ ⚠.

### ⚠ WARNING

- You or your passengers could be injured while changing a wheel if you do not follow these safety precautions:
  - Position the vehicle jack only at the designated lifting points and align the jack. Otherwise, the vehicle jack could slip and cause an injury if it does not have sufficient hold on the vehicle.
  - A soft or unstable surface under the jack may cause the vehicle to slip off the jack. Always provide a firm base for the jack on the ground. If necessary, use a sturdy board under the jack.
  - On hard, slippery surface (such as tiles) use a rubber mat or similar to prevent the jack from slipping.
  - Only raise your vehicle with the vehicle jack provided by the factory. If you use a vehicle jack for another vehicle, your vehicle can slide and cause injury.
  - Changes in temperature or load can affect the height of the vehicle.
  - Never start the engine when the vehicle is raised, which could cause an accident.
  - Support the vehicle securely with appropriate stands if work is to be performed underneath the vehicle; otherwise, there is a potential risk for injury.

- To help prevent injury to yourself and your passengers:
  - Do not raise the vehicle until you are sure the jack is securely engaged.
  - Passengers must not remain in the vehicle when it is jacked up.
  - Make sure that passengers wait in a safe place away from the vehicle and well away from the road and traffic.
  - Make sure jack position is correct, adjust as necessary and then continue to raise the jack.
  - Changes in temperature or load can affect the height of the vehicle.

### ⚠ Note

Do not lift the vehicle by the sill. Position the vehicle jack only at the designated lifting points on the sill. Otherwise, your vehicle will be damaged.

## Taking the wheel off/installing the spare

Follow these instructions step-by-step for changing the wheel.



**Fig. 180** Changing a wheel: using the screwdriver handle (with the blade removed) to turn the bolts



**Fig. 181** Changing a wheel: alignment pin inside the top hole



After you have loosened all wheel bolts and raised the vehicle off the ground, remove and replace the wheel as follows:

### Removing the wheel

- ▶ Use the **hexagonal socket in the screwdriver handle** to completely remove the topmost wheel bolt and set it aside on a *clean* surface ⇒ *fig. 180*.
- ▶ Screw the threaded end of the **alignment pin** from the tool kit hand-tight into the empty bolt hole ⇒ *fig. 181*.
- ▶ Then remove the other wheel bolts as described above.
- ▶ Take off the wheel leaving the alignment pin in the bolt hole ⇒ .

### Putting on the compact spare wheel

- ▶ Lift the spare wheel and carefully slide it over the alignment pin to guide it in place ⇒ .
- ▶ Use the hexagonal socket in the screwdriver handle to screw in and tighten all wheel bolts *slightly*.
- ▶ Remove the alignment pin and insert and tighten the remaining wheel bolt slightly like the rest.
- ▶ Turn the jack handle counter-clockwise to lower the vehicle until the jack is fully released.
- ▶ Use the wheel bolt wrench to tighten all wheel bolts firmly ⇒ *page 243*. Tighten them *cross-wise*, from one bolt to the (approximately) opposite one, to keep the wheel centered.

#### Note

When removing or installing the wheel, the rim could hit the brake rotor and damage the rotor. Work carefully and have a second person help you.

#### Tips

Never use the hexagonal socket in the handle of the screwdriver to loosen or tighten the wheel bolts.

- Pull the reversible blade from the screwdriver before you use the hexagonal socket in the handle to turn the wheel bolts.

- When mounting tires with **unidirectional tread design** make sure the tread pattern is pointed the right way ⇒ *page 245*.
- The wheel bolts should be clean and easy to turn. Check for dirt and corrosion on the mating surfaces of both the wheel and the hub. Remove all dirt from these surfaces before remounting the wheel.

### Tires with unidirectional tread design

*Tires with unidirectional tread design must be mounted with their tread pattern pointed in the right direction.*

### Using a spare tire with a tread pattern intended for use in a specific direction

When using a spare tire with a tread pattern intended for use in a specific direction, please note the following:

- The direction of rotation is marked by an arrow on the side of the tire.
- If the spare tire has to be installed in the incorrect direction, use the spare tire only temporarily since the tire will not be able to achieve its optimum performance characteristics with regard to aquaplaning, noise and wear.
- We recommend that you pay particular attention to this fact during wet weather and that you adjust your speed to match road conditions.
- Replace the flat tire with a new one and have it installed on your vehicle as soon as possible to restore the handling advantages of a unidirectional tire.

### Notes on wheel changing

Please read the information ⇒ *page 221* if you are going to use a spare tire which is different from the tires on your vehicle.

After you change a tire:

- **Check the tire pressure on the spare immediately after installation.**



- Have the wheel bolt tightening torque checked with a torque wrench as soon as possible by your authorized Audi dealer or a qualified service station.
- With steel and alloy wheel rims, the wheel bolts are correctly tightened at a torque of 90 ft lb (120 Nm).
- If you notice that the wheel bolts are corroded and difficult to turn while changing a tire, they should be replaced before you check the tightening torque.
- Replace the flat tire with a new one and have it installed on your vehicle as soon as possible. Remount the wheel cover.

Until then, drive with extra care and at reduced speeds.

### WARNING

- If you are going to equip your vehicle with tires or rims which differ from those which were factory installed, then be sure to read the information ⇒ *page 221*.
- Always make sure the damaged wheel or even a flat tire and the jack and tool kit are properly secured in the luggage compartment and are not loose in the passenger compartment.
- In an accident or sudden maneuver they could fly forward, injuring anyone in the vehicle.
- Always store damaged wheel, jack and tools securely in the luggage compartment. Otherwise, in an accident or sudden maneuver they could fly forward, causing injury to passengers in the vehicle.

## Spare tire

### General information

Applies to vehicles: with space-saving spare tire (compact spare tire)



Fig. 182 Luggage compartment: cargo floor cover folded upward



Fig. 183 Compact spare tire

The spare tire ⇒ *fig. 183* is intended for short-term use only. Have the damaged tire checked and replaced if necessary by an authorized Audi dealer or authorized Audi Service Facility as soon as possible.

There are some restrictions on the use of the compact spare tire. The compact spare tire has been designed specifically for your type of vehicle. Do not replace it with the spare tire from another type of vehicle.

### Removing the spare tire

- ▶ Lift the cargo floor by the plastic handle.
- ▶ Hang the plastic hook on the luggage compartment weather strip -arrow- ⇒ *fig. 182*.
- ▶ Turn the large screw counter-clockwise.
- ▶ Remove the spare tire.

### Snow chains

For technical reasons, the use of snow chains on the compact spare tire is not permitted. ►



If you have to drive with snow chains and a front tire fails, mount the spare wheel in place of a rear tire. Install the snow chains on the rear tire that you removed, and install that in place of the front tire that failed.

 **WARNING**

- After installing a spare tire, the tire pressure must be checked as soon as possible. The tire pressure is available on  $\Rightarrow$  page 224, fig. 171.
- If the spare tire is more than 6 years old, use it only in an emergency and with extreme caution and careful driving.
- The spare tire is intended only for temporary and short-term use. It should be replaced as soon as possible with the normal wheel and tire.
- After mounting the compact spare tire, the tire pressure must be checked as soon as possible. The tire pressure of the compact spare tire must be 61 psi (420 kPA); otherwise, you risk having an accident.
- Do not drive faster than 50 mph (80 km/h). You risk having an accident.
- Avoid full-throttle acceleration, heavy braking, and fast cornering. You risk having an accident.
- Never drive using more than one spare wheel and tire. You risk having an accident.
- Normal summer or winter tires must not be mounted on the compact spare wheel rim.
- For technical reasons, the use of tire chains on the spare tire is not permitted. If it is necessary to drive with tire chains, the spare wheel must be mounted on the front axle in the event of a flat in a rear tire. The newly available front wheel must then be installed in place of the rear wheel with the flat tire. Installing the tire chain before mounting the wheel and tire is recommended.
- Loose items in the passenger compartment can cause serious personal injury during hard braking or in an accident. Never store the inflatable spare tire or jack and tools in the passenger compartment.
- Normal summer or winter tires must not be mounted on the compact spare wheel rim.



## Fuses and bulbs

### Electrical fuses

#### Replacing fuses

A fuse that has blown will have metal strips that have burned through.

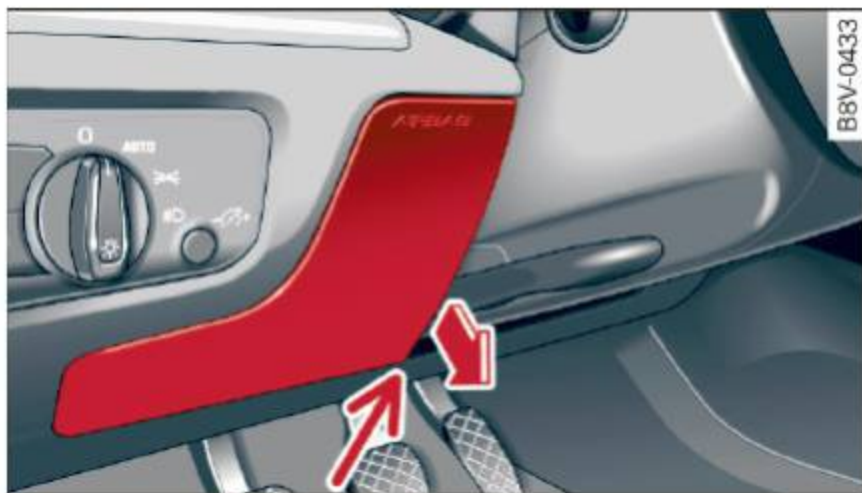

Fig. 184 Steering column area: cover

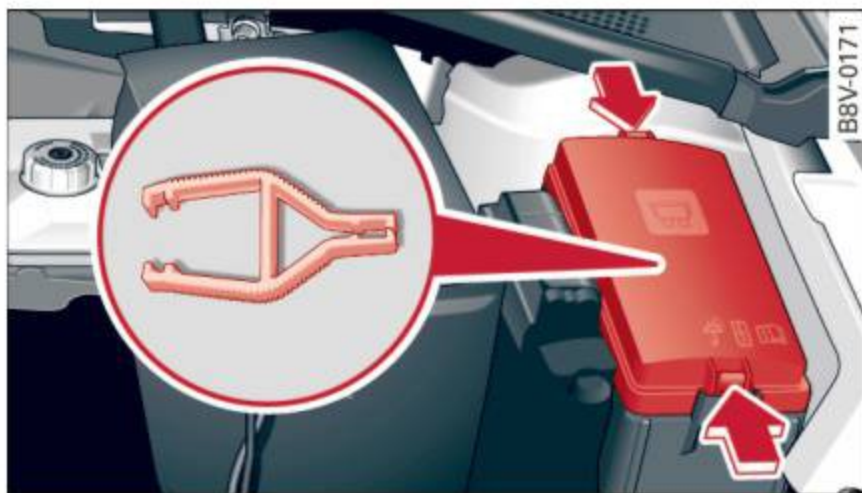

Fig. 185 Left side of the engine compartment: fuse cover

#### Fuses in the interior

The fuses are behind the cover in the steering column area ⇒ *fig. 184*.

- ▶ Switch the ignition and all electrical equipment off.
- ▶ Check the following table to see which fuse belongs to the equipment ⇒ *page 249*.
- ▶ Remove the cover (“AIRBAG” label) ⇒ *fig. 184*. Begin at the bottom right corner -arrow-.
- ▶ Remove the plastic clip from the fuse panel cover in the engine compartment ⇒ *fig. 185*.
- ▶ Remove the fuse using the plastic clamp.
- ▶ Replace the burned fuse with an identical new one.
- ▶ Install the cover.

#### Fuses in the engine compartment

- ▶ Turn off the ignition and the failed electrical equipment.

- ▶ Check the following table to see which fuse belongs to the equipment ⇒ *page 250*.
- ▶ Remove the fuse panel cover ⇒ *fig. 185*.
- ▶ Remove the plastic clip from the fuse panel cover ⇒ *fig. 185*.
- ▶ Remove the fuse using the plastic clamp.
- ▶ Replace the burned fuse with an identical new one.
- ▶ Reinstall the cover.

The individual circuits are protected by safety fuses. The fuses are located under the steering wheel behind a cover and in the left side of the engine compartment.

#### Fuse color identification

Color	Current rating in amps
Black	1
Purple	3
Light brown	5
Brown	7,5
Red	10
Blue	15
Yellow	20
White or transparent	25
green	30
orange	40

#### WARNING

Do not repair fuses and never replace a blown fuse with one that has a higher amp rating. This can cause damage to the electrical system and a fire.

#### Note

If a new fuse blows again shortly after you have installed it, have the electrical system checked by an authorized Audi dealer or authorized Audi Service Facility.

#### Tips

– The following table does not list fuse locations that are not used.



– Some of the equipment listed in the following tables applies only to certain model versions or certain optional equipment.

**Interior fuse assignment**

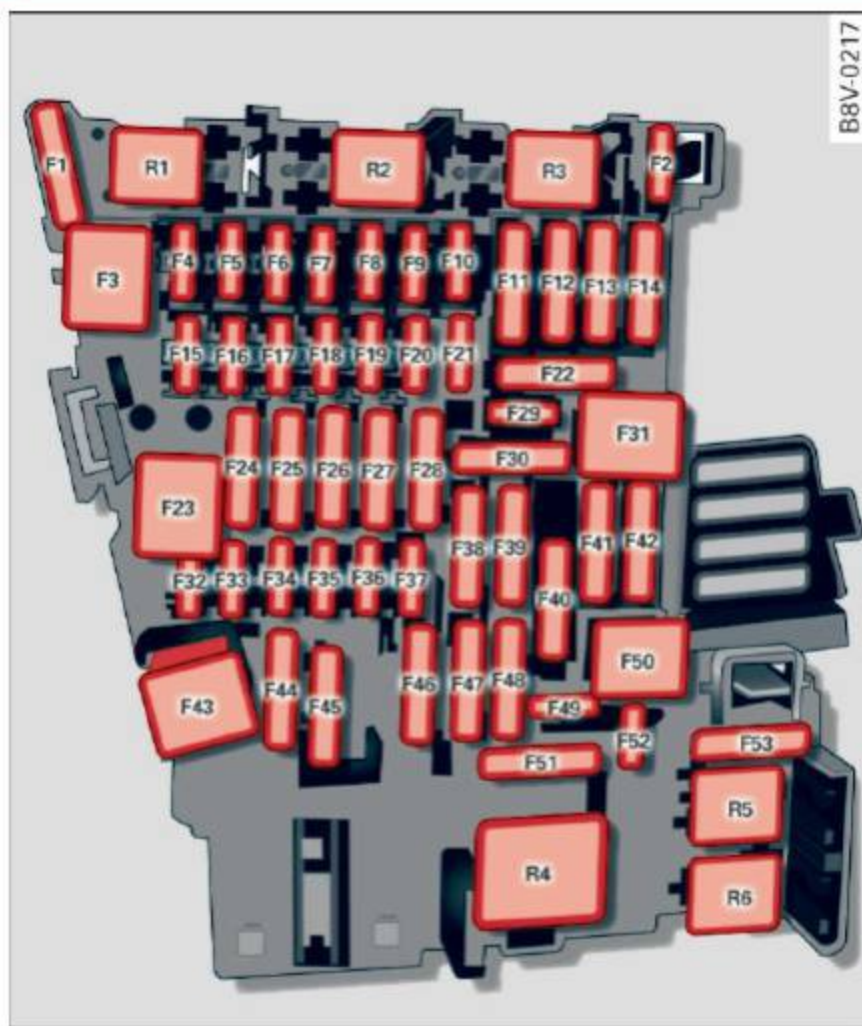

Fig. 186 Vehicle interior: fuse assignment

No.	Equipment
F1	Engine components
F2	Seat adjustment
F3	Hydraulic pump cover (Cabriolet)
F4	MM controls, MMI-components
F5	Gateway
F6	Anti-theft alarm system
F7	Climate/heating control, selector lever (automatic transmission), parking heater, rear window heater relay coil
F8	Diagnosis, electromechanical parking brake switch, light switch, rain/light sensor, interior lighting
F9	Steering column switch module
F10	Display
F11	Reversible driver's side safety belt tensioners
F12	MMI area
F13	Adaptive dampers control module

No.	Equipment
F14	Climate control system blower
F15	Electronic steering column lock
F16	MMI area
F17	Instrument cluster
F18	Rearview camera
F19	Convince key system control module, tank system
F20	Tank system
F23	Exterior lighting, heated washer fluid nozzles
F24	Panorama sunroof / power top control module, power top latch (Cabriolet)
F25	Door/driver's side doors (for example power windows)
F26	Seat heating
F27	Sound-amplifier
F28	Power top control module, electronics (Cabriolet)
F29	Interior lighting
F31	Exterior lighting
F32	Driver assistance systems
F33	Airbag
F34	Button illumination, coils for upper cabin heating relay (Cabriolet) and socket relay, interior sound, back-up light switch, temperature sensor, oil level sensor
F35	Diagnosis, headlight range control system, air quality sensor, automatic dimming rearview mirror
F36	Right cornering light / right LED-headlight
F37	Left cornering light / left LED-headlight
F39	Door/front passenger's side doors (for example, power windows)
F40	Sockets
F41	Reversible front passenger's side safety belt tensioners
F42	Central locking components, windshield washer system
F43	Headlights, lighting
F44	all wheel drive



## Fuses and bulbs

No.	Equipment
F49	Starter, clutch sensor, headlight relay coil
F53	Rear window defogger

The power seats\* are protected via **circuit breakers** that automatically switch on after a few seconds after the overload has been reduced.

### Tips

Note that the following table was accurate at the time of printing and is subject to change.

### Left engine compartment fuse assignment



Fig. 187 Engine compartment: fuse assignment

No.	Equipment
F1	ESC control module
F2	ESC control module
F3	Engine control module (gasoline/diesel)
F4	Engine cooling, engine components, auxiliary heater coil relay (1+2), secondary air injection pump relay
F5	Engine components, tank system
F6	Brake light sensor
F7	Engine components, water pumps
F8	Oxygen sensor

No.	Equipment
F9	Engine components, exhaust door, glow time control module, SULEV valve
F10	Fuel injectors, fuel control module
F11	Auxiliary heater heating element 2
F12	Auxiliary heater heating element 3
F13	Automatic transmission control module
F15	Horn
F16	Ignition coil
F17	ESC control module, engine control module
F18	Terminal 30 (reference voltage)
F19	Windshield wipers
F20	Horn
F22	Terminal 50 diagnosis
F23	Starter
F24	Auxiliary heater heating element 1
F31	Vacuum pump
F32	LED headlights

### Tips

Note that the following table was accurate at the time of printing and is subject to change.

## Bulbs

### Replacing light bulbs

*For your safety, we recommend that you have your authorized Audi dealer replace burned out bulbs for you.*

It is becoming increasingly more and more difficult to replace vehicle light bulbs since in many cases, other parts of the car must first be removed before you are able to get to the bulb. This applies especially to the light bulbs in the front of your car which you can only reach through the engine compartment.

Sheet metal and bulb holders can have sharp edges that can cause serious cuts, and parts must be correctly taken apart and then properly put back together to help prevent breakage of parts and long term damage from water that can



enter housings that have not been properly resealed.

For your safety, we recommend that you have your authorized Audi dealer replace any bulbs for you, since your dealer has the proper tools, the correct bulbs and the expertise.

#### Gas discharge lamps (Xenon lights):

Due to the high electrical voltage, have the bulbs replaced by a qualified technician. Headlights with Xenon light can be identified by the high voltage sticker.

LED headlights\* require no maintenance. Please contact your authorized Audi dealer if a bulb needs to be replaced.

#### WARNING

Contact with high-voltage components of the electrical system and improper replacement of gas discharge (Xenon) headlight bulbs can cause serious personal injury and death.

- Xenon bulbs are pressurized and can explode when being changed.
- Changing Xenon lamps requires the special training, instructions and equipment.
- Only an authorized Audi dealer or other qualified workshop should change the bulbs in gas discharge lamps.

#### WARNING

There are parts with sharp edges on the openings and on the bulb holders that can cause serious cuts.

- If you are uncertain about what to do, have the work performed by an authorized Audi dealer or other qualified workshop. Serious personal injury may result from improperly performed work.

#### Tips

- If you still prefer to replace the light bulbs yourself, be aware that the engine compartment is a hazardous area to work in  
⇒ *page 198* ⇒ 
- It is best to ask your authorized Audi dealer whenever you need to change a bulb.



## Emergency situations

### General

This chapter is intended for trained emergency crews and working personnel who have the necessary tools and equipment to perform these operations.

### Starting by pushing or towing

#### Note

Vehicles with an automatic transmission cannot be started by pushing or towing.

### Starting with jumper cables

*If necessary, the engine can be started by connecting it to the battery of another vehicle.*

If the engine should fail to start because of a discharged or weak battery, the battery can be connected to the battery of *another* vehicle, using a **pair of jumper cables** to start the engine.

#### Jumper cables

Use *only* jumper cables of sufficiently large **cross section** to carry the starter current safely. Refer to the manufacturer's specifications.

Use only jumper cables with *insulated* terminal clamps which are distinctly marked:

**plus (+) cable** in most cases colored **red**

**minus (-) cable** in most cases colored **black**.

#### WARNING

Batteries contain electricity, acid, and gas. Any of these can cause very serious or fatal injury. Follow the instructions below for safe handling of your vehicle's battery.

- Always shield your eyes and avoid leaning over the battery whenever possible.
- A discharged battery can freeze at temperatures just below 32 °F (0 °C). Before connecting a jumper cable, you must thaw the

frozen battery completely, otherwise it could explode.

- Do not allow battery acid to contact eyes or skin. Flush any contacted area with water immediately.
- Improper use of a booster battery to start a vehicle may cause an explosion.
- Vehicle batteries generate explosive gases. Keep sparks, flame and lighted cigarettes away from batteries.
- Do not try to jump start any vehicle with a low acid level in the battery.
- The voltage of the booster battery must also have a 12-volt rating. The capacity (Ah) of the booster battery should not be lower than that of the discharged battery. Use of batteries of different voltage or substantially different "Ah" rating may cause an explosion and personal injury.
- Never charge a frozen battery. Gas trapped in the ice may cause an explosion.
- Never charge or use a battery that has been frozen. The battery case may have been weakened.
- Use of batteries of different voltage or substantially different capacity (Ah) rating may cause an explosion and injury. The capacity (Ah) of the booster battery should not be lower than that of the discharged battery.
- Before you check anything in the engine compartment, always read and heed all WARNINGS ⇒ page 198.

#### Note

- Applying a higher voltage booster battery will cause expensive damage to sensitive electronic components, such as control units, relays, radio, etc.
- There must be no electrical contact between the vehicles as otherwise current could already start to flow as soon as the positive (+) terminals are connected.

#### Tips

The discharged battery must be properly connected to the vehicle's electrical system. ►



When jump starting or charging the battery, never connect the negative ground cable to the battery negative post because the battery manager system must be able to detect the battery's state of charge. Always connect the negative ground cable to the negative ground post of the battery manager control unit.

## Using jump start cables

Connect the jump start cables in the exact order described below.

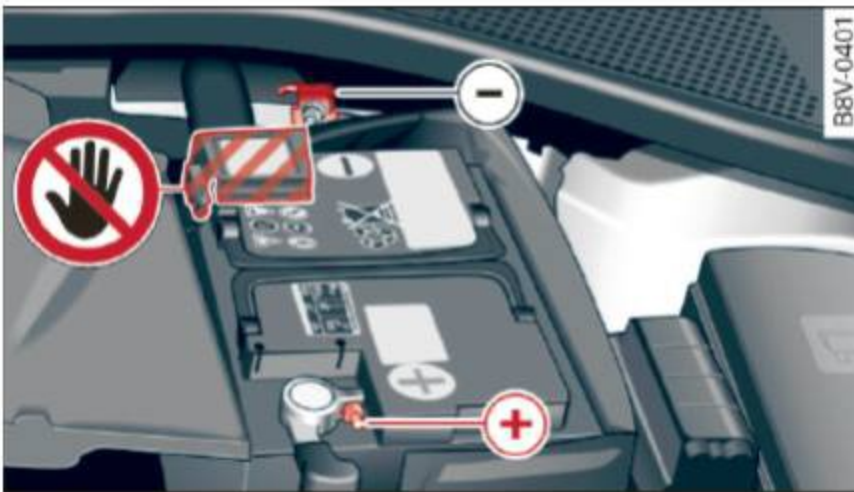

Fig. 188 Engine compartment: connectors for jump start cables and a charger

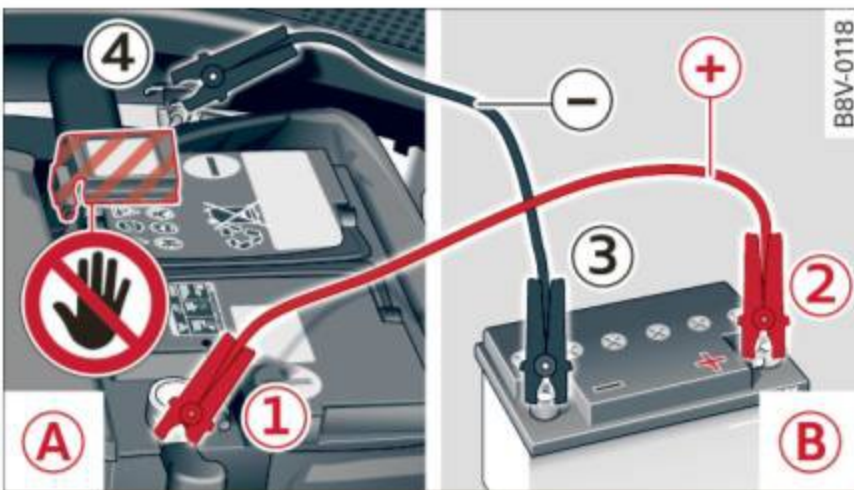

Fig. 189 Jump starting the battery with another vehicle:  
 (A) - drained battery, (B) - starter battery

The battery is located to the left in the engine compartment. **Do not jump start a frozen or thawed battery** ⇒ ⚠ in *Starting with jumper cables on page 252! Replace the battery.* The procedure for connecting jump start cables that is described next is designed to help jump start your vehicle.

### Vehicle with drained battery:

- ▶ Read the following carefully ⇒ *page 252*
- ▶ Set the parking brake and place the selector lever in the P position.

- ▶ Turn the ignition and electrical equipment off in both vehicles.

### Connecting the negative terminal (-) to the negative terminal (-) (black)

- ▶ To reach the battery terminals, flip the battery cover cap to the side ⇒ *fig. 188*.
1. Clamp the end of the red jump start cable to the terminal ① ⇒ *fig. 189* on the dead battery (A) ⇒ ⚠ in *Starting with jumper cables on page 252*.
  2. Clamp the other end of the red jump start cable to the terminal ② on the charging battery (B).

### Connect NEGATIVE (-) to NEGATIVE (-) (black)

3. Clamp the black end of the jump start cable **preferably at the ground point**, or on the negative terminal ③ on the charging battery (B).
4. Clamp the other black end of the jump start cable **only on the ground point ④ on your vehicle (A)** ⇒ ⚠.
5. Route the jump start cables so they cannot get caught in the moving parts in the engine compartment.

### Starting the engine

6. Start the engine in the vehicle giving the charge and let it run at idle.
7. Start the engine in the vehicle with the dead battery and wait two to three minutes until it "runs smoothly".
8. If the engine does not start: stop the starting procedure after 10 seconds and then repeat it after approximately 30 seconds.
9. In the vehicle that is being jump started, switch the heater fan and rear window defroster on to reduce any voltage peaks that may occur when disconnecting the jumper cables. The headlights must be switched off.
10. With the engines running, remove the cables in *reverse* order of the way they were installed. Make sure the cables do not get caught in moving engine components.
11. Switch the heater fan and rear window defroster off.
12. Close the battery cover. ▶



The battery is vented to the outside so that not gases enter the passenger compartment. Make sure that the connected positive terminal clamps on the jump start cable have sufficient contact with metal.

### **WARNING**

Follow the warnings and instructions from the jump start cable manufacturer to reduce the risk of serious injuries and vehicle damage. If you are unsure about anything, call roadside assistance.

- The jump start cables must be long enough so that the vehicles do not touch.
- Route the jump start cables so they cannot get caught in the moving parts in the engine compartment.
- Always read and follow the warnings before checking anything in the engine compartment ⇒ *page 198*.

### **Note**

Connecting jump start cables incorrectly can destroy the alternator.

- Always connect the positive terminal (+) to the positive terminal (+) and the negative terminal (-) to the negative terminal (-) on the body ground point, but not the negative terminal on the battery.
- Make sure the screw plugs on the battery cells are installed securely. If not, tighten the plugs before connecting the clamps to the negative terminal on the battery.
- Please note that the connecting process described below for the jump start cables is intended for when your vehicle is being jump started. If you are jump starting another vehicle, do not connect the negative cable to the negative terminal (-) on the drained battery, but rather connect it to a large metal component that is bolted securely to the engine block, or to the engine block itself. If the battery in the vehicle being jump started is not vented to the outside, there is a risk of explosion due to hydrogen gas.
- Make sure that the connected positive terminal clamps have sufficient contact with metal.

- Do not use the battery negative terminal for jump starting or a malfunction could occur in the vehicle electrical system.

## Towing with a tow truck

### General hints

*Your Audi requires special handling for towing.*

The following information is to be used by commercial tow truck operators who know how to operate their equipment safely.

- **Never tow your Audi. Towing will cause damage to the engine and transmission.**
- **Never wrap the safety chains or winch cables around the brake lines.**
- **To prevent unnecessary damage, your Audi must be transported with a flat bed truck.**
- **To load the vehicle on to the flat bed, use the towing loop found in the vehicle tools and attach to the front or rear anchorage**  
⇒ *page 255* and ⇒ *page 255*.

### **WARNING**

A vehicle being towed is not safe for passengers. Never allow anyone to ride in a vehicle being towed, for any reason.



## Front towing loop



Fig. 190 Right front bumper: removing the cover



Fig. 191 Right front bumper: towing loop installed

The threaded opening for the towing loop is located behind a cover on the right side of the front bumper.

- ▶ Remove the towing loop from the vehicle tool kit ⇒ *page 241*.
- ▶ Press inward on the *upper left* side of the cap to remove it from the bumper ⇒ *fig. 190*.
- ▶ Insert the towing loop in the threaded opening until it stops ⇒ *fig. 191* and tighten it with a wheel wrench.
- ▶ After using, place the towing loop back in the vehicle tool kit.

 **WARNING**

If the towing loop is not installed securely, it could loosen from the threads while towing and cause damage to the vehicle or injury to people.

## Rear towing loop



Fig. 192 Right rear towing loop: cover



Fig. 193 Right rear towing loop: towing loop installed

The towing loop threaded opening is located in the right of the rear bumper cover under a cover.

- ▶ Remove the towing loop from the vehicle tool kit ⇒ *page 241*.
- ▶ Press inward on the *upper* area -arrow- and lift it upward from the *lower* area ⇒ *fig. 192*.
- ▶ Insert the towing loop in the threaded opening until it stops ⇒ *fig. 193* and tighten it with a wheel wrench.
- ▶ After using, place the towing loop back in the vehicle tool kit.

Depending on the model, the shape of the cover can vary.

 **WARNING**

If the towing loop is not installed securely, it could loosen from the threads while towing and cause damage to the vehicle or injury to people.



### Loading the vehicle onto a flat bed truck



Fig. 194 Vehicle on flat bed truck

### Front hook up

- ▶ Align the vehicle with the centerline of the car carrier ramp.
- ▶ Attach the winch hook to the front towline eye previously installed.

### Rear hook up

- ▶ Align the vehicle with the centerline of the car carrier ramp.
- ▶ Attach the winch hook to the rear towline eye previously installed.

### Tips

Check carefully to make sure the hook-up is secure before moving the car up the flatbed truck ramp.

## Raising the vehicle

### Lifting with workshop hoist and with floor jack

The vehicle may only be lifted at the lifting points illustrated.



Fig. 195 Front lifting point



Fig. 196 Rear lifting point

- ▶ Read and heed WARNING ⇒ .
- ▶ Locate lifting points ⇒ *fig. 195* and ⇒ *fig. 196*.
- ▶ Adjust lifting arms of workshop hoist or floor jack to match vehicle lifting points.
- ▶ Insert a rubber pad between the floor jack/workshop hoist and the lifting points.

**If you must lift your vehicle with a floor jack to work underneath, be sure the vehicle is safely supported on stands intended for this purpose.**

### Front lifting point

The lifting point is located on the floor pan reinforcement about at the same level as the jack mounting point ⇒ *fig. 195*. **Do not lift the vehicle at the vertical sill reinforcement.**

### Rear lifting point

The lifting point is located on the vertical reinforcement of the lower sill for the on-board jack ⇒ *fig. 196*.

### Lifting with vehicle jack

Refer to ⇒ *page 243*.

### WARNING

- To reduce the risk of serious injury and vehicle damage.
- Always lift the vehicle only at the special workshop hoist and floor jack lift points illustrated ⇒ *fig. 195* and ⇒ *fig. 196*.
- Failure to lift the vehicle at these points could cause the vehicle to tilt or fall from a lift if there is a change in vehicle weight distribution and balance. This might happen, for example, when heavy components



such as the engine block or transmission are removed.

- When removing heavy components like these, anchor vehicle to hoist or add corresponding weights to maintain the center of gravity. Otherwise, the vehicle might tilt or slip off the hoist, causing serious personal injury.

 **Note**

- Be aware of the following points before lifting the vehicle:
  - **The vehicle should never be lifted or jacked up from underneath the engine oil pan, the transmission housing, the front or rear axle or the body side members. This could lead to serious damage.**
  - **To avoid damage to the underbody or chassis frame, a rubber pad must be inserted between the floor jack and the lift points.**
  - **Before driving over a workshop hoist, check that the vehicle weight does not exceed the permissible lifting capacity of the hoist.**
  - **Before driving over a workshop hoist, ensure that there is sufficient clearance between the hoist and low parts of the vehicle.**



## Technical data

### Vehicle identification



Fig. 197 Vehicle Identification Number (VIN) plate: location on driver's side dash panel

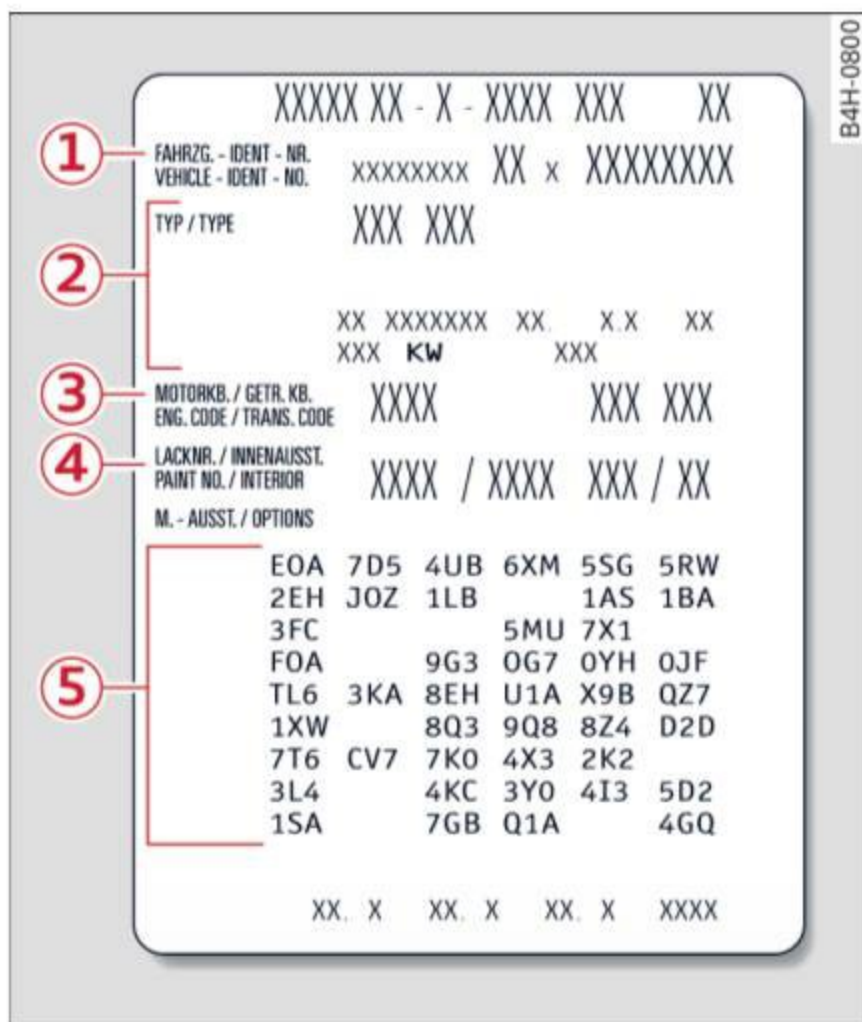

Fig. 198 The vehicle identification label – inside the luggage compartment

#### Vehicle Identification Number (VIN)

The Vehicle Identification Number is located in different places:

- under the windshield on the driver's side ⇒ *fig. 197*.
- in the MMI: Select: the **MENU** button > **Car** > **Systems\*** control button > **Service & control** > **VIN number**.
- on the vehicle identification label.

#### Vehicle identification label

The vehicle identification label is located in the luggage compartment in the spare wheel well.

The label ⇒ *fig. 198* shows the following vehicle data:

- 1 Vehicle Identification Number (VIN)
- 2 Vehicle type, engine output, transmission
- 3 Engine and transmission code
- 4 Paint number and interior
- 5 Optional equipment numbers

The information of the vehicle identification label can also be found in your Warranty & Maintenance booklet.

#### Safety compliance sticker

The safety compliance sticker is your assurance that your new vehicle complies with all applicable Federal Motor Vehicle Safety Standards which were in effect at the time the vehicle was manufactured. You can find this sticker on the door jamb on the driver's side. It shows the month and year of production and the vehicle identification number of your vehicle (perforation) as well as the Gross Vehicle Weight Rating (GVWR) and the Gross Axle Weight Rating (GAWR).

#### High voltage warning label

The high voltage warning label is located in the engine compartment next to the engine hood release. The spark ignition system complies with the Canadian standard ICES-002.

## Weights

#### Gross Vehicle Weight Rating

The Gross Vehicle Weight Rating (GVWR), and the Gross Axle Weight Rating (GAWR) for front and rear are listed on a sticker on the door jamb on the driver's side.

The Gross Vehicle Weight Rating includes the weight of the basic vehicle plus full fuel tank, oil and coolant, plus maximum load, which includes passenger weight (150 lbs/68 kg per designated seating position) and luggage weight ⇒ . ▶



### Gross Axle Weight Rating

The Gross Axle Weight Rating is the maximum load that can be applied at each axle of the vehicle ⇒ ⚠.

### Vehicle capacity weight

The vehicle capacity weight (max. load) is listed either on the driver's side B-pillar or inside the fuel filler flap.

#### WARNING

- The actual Gross Axle Weight Rating at the front and rear axles should not exceed the permissible weights, and their combination must not exceed the Gross Vehicle Weight Rating.

- Exceeding permissible weight ratings can result in vehicle damage, accidents and personal injury.

#### Note

- The vehicle capacity weight figures apply when the load is distributed evenly in the vehicle (passengers and luggage). When transporting a heavy load in the luggage compartment, carry the load as near to the rear axle as possible so that the vehicle's handling is not impaired.
- Do not exceed the maximum permissible axle loads or the maximum gross vehicle weight. Always remember that the vehicle's handling will be affected by the extra load. Therefore, adjust your speed accordingly.
- Always observe local regulations.

## Dimensions

The dimensions can vary depending on the model and equipment.

When driving on poor roads, by curbs and on steep ramps, make sure that low-lying compo-

nents such as the spoiler and exhaust system do not come into contact with these or they could be damaged. This applies especially when the vehicle is fully loaded.

### A3 Sedan

Length	in (mm)	175.3 (4456)
Width	in (mm)	70.7 (1796)
Width (across mirrors)	in (mm)	77.1 (1960)
Height (unloaded) <sup>a)</sup>	in (mm)	55.7 (1416)

<sup>a)</sup> The height of the vehicle depends on the tires and suspension.

### S3 Sedan

Length	in (mm)	175.8 (4469)
Width	in (mm)	70.7 (1796)
Width (across mirrors)	in (mm)	77.1 (1960)
Height (unloaded) <sup>a)</sup>	in (mm)	54.8 (1392)

<sup>a)</sup> The height of the vehicle depends on the tires and suspension.



## Capacities

Fuel tank		
Front wheel drive	gallons (liters)	approximately 13.2 (50.0)
all wheel drive	gallons (liters)	approximately 14.5 (55.0)
Windshield washer system	quarts (liters)	approximately 3.2 (3.1)
Windshield and headlight washer system*	quarts (liters)	approximately 4.7 (4.7)



## Gasoline engines

### A3 sedan 1.8L, 4 cylinders

Maximum output SAE net	hp @ rpm	170 @ 4500 - 6200
Maximum torque SAE net	lb-ft @ rpm	200 @ 1600 - 4400
Displacement	CID (cm <sup>3</sup> )	110 (1798)
Engine oil with filter change	quarts (liters)	5.5 (5.2)
Fuel	<b>Premium unleaded (91 AKI)</b> , ⇨ <i>page 190, Gasoline</i>	

### A3 sedan 2.0L, 4 cylinders

Maximum output SAE net	hp @ rpm	220 @ 4500 - 6200
Maximum torque SAE net	lb-ft @ rpm	258 @ 1600 - 4400
Displacement	CID (cm <sup>3</sup> )	121 (1984)
Engine oil with filter change	quarts (liters)	6.0 (5.7)
Fuel	<b>Premium unleaded (91 AKI)</b> , ⇨ <i>page 190, Gasoline</i>	

### S3 sedan 2.0L, 4 cylinders

Maximum output SAE net	hp @ rpm	292 @ 5400 - 6200
Maximum torque SAE net	lb-ft @ rpm	280 @ 1900 - 5300
Displacement	CID (cm <sup>3</sup> )	121 (1984)
Engine oil with filter change	quarts (liters)	6.0 (5.7)
Fuel	<b>Premium unleaded (91 AKI)</b> , ⇨ <i>page 190, Gasoline</i>	

## Diesel engine

### A3, 2.0L TDI, 4 cylinder

Maximum output SAE net	hp @ rpm	150 @ 3500 - 4000
Maximum torque SAE net	lb-ft @ rpm	237 @ 1750 - 3000
Displacement	CID (cm <sup>3</sup> )	120 (1968)
Engine oil with filter change	quarts (liters)	5.8 (5.5)
Fuel	<b>ULSD-Diesel No. 2</b> , ⇨ <i>page 191, Diesel fuel</i>	



## Consumer information

### Warranty coverages

Your Audi is covered by the following warranties:

- *New Vehicle Limited Warranty*
- *Limited Warranty Against Corrosion Perforation*
- *Emissions Control System Warranty*
- *Emissions Performance Warranty*
- *California Emissions Control Warranty (USA vehicles only)*
- *California Emissions Performance Warranty (USA vehicles only)*

Detailed information regarding your warranties can be found in your **Warranty & Maintenance booklet**.

### Operating your vehicle outside the U.S.A. or Canada

Government regulations in the United States and Canada require that automobiles meet specific emission regulations and safety standards.

Therefore, vehicles built for the U.S.A. and Canada differ from vehicles sold in other countries.

If you plan to take your vehicle outside the continental limits of the United States or Canada, there is the possibility that:

- unleaded fuels for vehicles with catalytic converter may not be available;
- fuel may have a considerably lower octane rating. Improper fuel may cause engine damage;
- service may be inadequate due to lack of proper service facilities, tools or testing equipment;
- replacement parts may not be readily available.
- Navigation systems for vehicles built for the U.S.A. and Canada will not necessarily work in Europe, and may not work in other countries outside North America.

#### Note

Audi cannot be responsible for mechanical damage that could result from inadequate fuel, service or parts availability.

### Audi Service Repair Manuals and Literature

Audi Official Factory Service Manuals and Literature are published as soon as possible after model introduction. Service manuals and literature are available to order from the Audi Technical Literature Ordering Center at:

[www.audi.techliterature.com](http://www.audi.techliterature.com)

### Maintenance

#### General

Your vehicle has been designed to help keep maintenance requirements to a minimum. However, a certain amount of regular maintenance is still necessary to assure your vehicle's safety, economy and reliability. For detailed vehicle maintenance consult your **Warranty & Maintenance booklet**.

**Under difficult operating conditions**, for example at extremely low outside temperatures, in very dusty regions, when towing a trailer very frequently, etc., some service work should be performed between the intervals specified. This applies particularly to:

- oil changes, and
- cleaning or replacing the air filter.

#### For the sake of the environment

By regularly maintaining your vehicle, you help make sure that emission standards are maintained, thus minimizing adverse effects on the environment.

#### Important considerations for you and your vehicle

The increasing use of electronics, sophisticated fuel injection and emission control systems, and the generally increasing technical complexity of ►



today's automobiles, have steadily reduced the scope of maintenance and repairs which can be carried out by vehicle owners. **Also, safety and environmental** concerns place very strict limits on the nature of repairs and adjustments to engine and transmission parts which an owner can perform.

Maintenance, adjustments and repairs usually require special tools, testing devices and other equipment available to specially trained workshop personnel in order to assure proper performance, reliability and safety of the vehicle and its many systems.

Improper maintenance, adjustments and repairs can impair the operation and reliability of your vehicle and even void your vehicle warranty. Therefore, proof of servicing in accordance with the maintenance schedule may be a condition for upholding a possible warranty claim made within the warranty period.

Above all, operational safety can be adversely affected, creating unnecessary risks for you and your passengers.

If in doubt about any servicing, have it done by your authorized Audi dealer or any other properly equipped and qualified workshop. We strongly urge you to give your authorized Audi dealer the opportunity to perform all scheduled maintenance and necessary repairs. Your dealer has the facilities, original parts and trained specialists to keep your vehicle running properly.

### Performing limited maintenance yourself

The following pages describe a limited number of procedures which can be performed on your vehicle with ordinary tools, should the need arise and trained personnel be unavailable. Before performing any of these procedures, always thoroughly read all of the applicable text and carefully follow the instructions given. Always rigorously observe the **WARNINGS** provided.

**Before you check anything in the engine compartment, always read and heed all WARNINGS**

⇨  and ⇨ page 198.

### WARNING

- Serious personal injury may occur as a result of improperly performed maintenance, adjustments or repairs.
- Always be extremely careful when working on the vehicle. Always follow commonly accepted safety practices and general common sense. Never risk personal injury.
- Do not attempt any of the maintenance, checks or repairs described on the following pages if you are not fully familiar with these or other procedures with respect to the vehicle, or are uncertain how to proceed.
- Do not do any work without the proper tools and equipment. Have the necessary work done by your authorized Audi dealer or another properly equipped and qualified workshop.
- The engine compartment of any motor vehicle is a potentially hazardous area. Never reach into the area around or touch the radiator fan. It is temperature controlled and can switch on suddenly - even when the engine is off. The radiator fan switches on automatically when the coolant reaches a certain temperature and will continue to run until the coolant temperature drops.
- Always switch off the ignition before anyone gets under the vehicle.
- Always support your vehicle with safety stands if it is necessary to work underneath the vehicle. The jack supplied with the vehicle is not adequate for this purpose and could collapse causing serious personal injury.
- If you must work underneath the vehicle with the wheels on the ground, always make sure the vehicle is on level ground, that the wheels are always securely blocked and that the engine cannot be started.
- Always make sure the transmission selector lever (automatic transmission) is in P (Park position) and the park brake is applied.





### For the sake of the environment

- Changing the engine settings will adversely affect emission levels. This is detrimental to the environment and increases fuel consumption.
- Always observe environmental regulations when disposing of old engine oil, used brake fluid, dirty engine coolant, spent batteries or worn out tires.
- Undeployed airbag modules and pretensioners might be classified as Perchlorate Material -special handling may apply, see [www.dtsc.ca.gov/hazardouswaste/perchlorate](http://www.dtsc.ca.gov/hazardouswaste/perchlorate). When the vehicle or parts of the restraint system including airbag modules safety belts with pretensioners are scrapped, all applicable laws and regulations must be observed. Your authorized Audi dealer is familiar with these requirements and we recommend that you have your dealer perform this service for you.

## Accessories and technical changes

### Additional accessories and parts replacement

*Always consult an authorized Audi dealer before purchasing accessories.*

Your vehicle incorporates the latest safety design features ensuring a high standard of active and passive safety.

This safety could be compromised by non-approved changes to the vehicle. For this reason, if parts have to be replaced, please observe the following points when installing additional accessories:

Approved Audi accessories and genuine Audi parts are available from authorized Audi dealers.

These dealers also have the necessary facilities, tools and trained specialists to install the parts and accessories properly.



### WARNING

- Using the wrong spare parts or using non-approved accessories can cause damage to the vehicle and serious personal injury.
- Use only accessories expressly approved by Audi and genuine Audi spare parts
  - These parts and accessories have been specially designed to be used on your vehicle.
  - Never install accessories such as telephone cradles or beverage holders on airbag covers or within the airbag deployment zones. Doing so will increase the risk of injury if airbags are triggered in an accident!
  - Before you check anything in the engine compartment, always read and heed all WARNINGS ⇒ *page 198*.



### Note

- If items other than genuine Audi spare parts, add-on equipment and accessory items are used or if repair work is not performed according to specified methods, this can result in severe damage to your vehicle's engine and body (such as corrosion) and adversely affect your vehicle's warranty.
- If emergency repairs must be performed elsewhere, have the vehicle examined by an authorized Audi dealer as soon as possible.
- The manufacturer cannot be held liable for damage which occurs due to failure to comply with these stipulations.

### Technical Modifications

*Our guidelines must be complied with when technical modifications are made.*

Always consult an authorized Audi dealer **before** starting work on any modifications.

This will help ensure that vehicle function, performance and safety are not impaired ⇒

Attempting to work on electronic components and the software used with them can cause malfunctions. Because of the way electronic components are interconnected with each other, such malfunctions can also have an adverse affect on other systems that are not directly involved. This ►



means that you risk both a substantial reduction in the operational safety of your vehicle and an increased wear of vehicle parts ⇒ ⚠.

Authorized Audi dealers will perform this work in a professional and competent manner or, in special cases, refer you to a professional company that specializes in such modifications.

### **WARNING**

Improper repairs and modifications can change the way vehicle systems work and cause damage to the vehicle and serious personal injury.

### **Note**

If emergency repairs must be performed elsewhere, have the vehicle examined by an authorized Audi dealer as soon as possible.

## Declaration of Compliance, Telecommunication and Electronic Systems

*Radio Frequency Devices and Radiocommunication Equipment User Manual Notice.*

The manufacturer is not responsible for any radio or TV interference caused by unauthorized modifications to this equipment.

### Devices

The following devices each comply with FCC Part 15.19, FCC 15.21 and RSS-Gen Issue 1:

- Adaptive cruise control\*
- Audi side assist\*
- Cell phone package\*
- Convenience key\*
- Electronic immobilizer
- HomeLink universal remote control\*
- Remote control key

### FCC Part 15.19

This device complies with part 15 of the FCC Rules. Operation is subject to the following two conditions:

(1) This device may not cause harmful interference, and

(2) this device must accept any interference received, including interference that may cause undesired operation.

### FCC Part 15.21

CAUTION:

Changes or modifications not expressly approved by the party responsible for compliance could void the user's authority to operate the equipment.

### RSS-Gen Issue 1

Operation is subject to the following two conditions:

(1) this device may not cause interference, and

(2) this device must accept any interference, including interference that may cause undesired operation of the device.



<b>A</b>	
A/C	
<i>refer to</i> Climate control system (automatic)	66
<i>refer to</i> Climate control system (manual)	65
A/C (automatic climate control system)	66
A/C (manual climate control system)	65
Accessories	57, 264
Active lane assist	106
Activating vibration warning	108
Adjusting steering time	108
Cleaning the camera area	236
Driver messages	107
Indicator light	107
switching on and off	107
Adaptive cruise control	96
Automatic transmission	100
Cleaning the sensor	236
Driver messages	102
General Information	97
Request for driver intervention	102
Stop-and-go traffic	100
Adaptive dampers	112
Indicator light	25
Adaptive light	43, 112
Indicator light	24
AdBlue	195
Filling	197
Messages	196
Adjusting air distribution (Climate control system)	67
Adjusting air vents	68
Adjusting air vents (manual climate control system)	65
Adjusting automatic headlights	45
Adjusting the center console lighting	47
Adjusting the temperature	
manual climate control system	65
advanced key	
<i>refer to</i> Convenience key	75
Airbag	148
Indicator light	20
Airbag system	168
Advanced Airbag-System	152
Advanced Airbag System components	155
Care	163
Children	174
Child restraints	174
Components (front airbags)	155
Danger of fitting a child seat on the front passenger seat	149
Disposal	163
Front airbags	152, 153
How do the front airbags work?	158
How many airbags does my vehicle have?	155
How the Advanced Airbag System components work together	157
Important information	148
Important safety instructions on the knee airbag system	166
Knee airbags	164
Monitoring	160
PASSENGER AIR BAG OFF light	160
Repairs	163
Safety instructions	162
Side airbags	166
Side curtain airbags	169
Warning/Indicator lights	160
When must the system be inspected?	160
Alarm system	
<i>refer to</i> Anti-theft alarm system	33
Alignment pin (changing the wheel)	241
All-weather lights (LED headlights)	43
All season tires	229
All wheel drive	127
Alternator	
<i>refer to</i> Alternator (indicator light)	19
Alternator (indicator light)	19
Ambient lighting	46
Anti-freeze	
<i>refer to</i> Engine coolant	205
Anti-lock braking system	123
Indicator light	21
Anti-slip regulation	123
Indicator light	21
Anti-theft alarm system	33
Anti-theft protection	
Electronic immobilizer	38
Audi active lane assist	
<i>refer to</i> Active lane assist	106
Audi adaptive cruise control	
<i>refer to</i> Adaptive cruise control	96
Audi adaptive light	
<i>refer to</i> Adaptive light	43



Audi drive select		Replacing the battery	211
<i>refer to</i> Drive select	112	Winter operation	208
Audi magnetic ride		Working on the battery	209
<i>refer to</i> Adaptive dampers	112	Before driving	130
Audi Service Repair Manuals and Literature	262	Belt tensioners	146
Audi side assist		Blended gasoline	190
<i>refer to</i> Side assist	109	Blower	
AUTO		automatic Climate control system	67
Automatic climate control system	66	Manual climate control system	65
Automatic headlights	43	Boost	29
Auto Lock (central locking system)	34	Booster seats	181
Automatic belt retractor	143	Boost pressure indicator	29
Automatic climate control system		Brake fluid	
<i>refer to</i> Climate control system (automatic)	66	Changing the brake fluid	207
Automatic headlights	43	Checking the brake fluid level	207
Automatic post-collision braking system	123	Brakes	125
Automatic transmission	82	Brake assist system	123
Driving tips	84	Brake booster	125
Emergency mode	88	Indicator light	24
Hill descent control	86	New brake pads	125
Ignition key safety interlock	73	Brake system	
Kick-down	87	Brake fluid	207
Launch Control-Program	88	Brake fluid specifications for refill and re-	
malfunction	83	placement	207
Selector lever emergency release	89	Fluid reservoir	207
Selector lever lock	83	Worn brake pads symbol	21
Selector lever positions	82	Braking	
Shifting manually	87	Emergency braking function	80
Steering wheel with shift paddles	87	Indicator light	17
S tronic	82	Parking brake	78
tiptronic	87	Starting on inclines	80
Automatic wipe/wash system	49	Break-in period	70
Auto Safety Hotline	138	Breaking in	
Auxiliary heater (vehicles with diesel engines)	69	New tires	221
Average consumption	28	Bulbs	250
Average speed	28		
<b>B</b>		<b>C</b>	
Battery	208	California Proposition 65 Warning	199
Charge level	128	Battery specific	210
Charging	19, 210	Capacities	
Energy management	128	AdBlue	195
Important warnings	209	Fuel tank	260
Indicator light	19	Washer fluid reservoir	260
Jump starting	252	Care	235
Location	209	<i>also refer to</i> Cleaning	235
		Cargo area	136



Cargo net . . . . .	61	Child seats . . . . .	178
Catalytic converter . . . . .	194	Securing . . . . .	182
CD-ROM player (navigation) . . . . .	58	Cleaning . . . . .	235
CD changer . . . . .	58	Cleaning/removing ice from windows . . . . .	237
Central indicator light . . . . .	13	Cleaning Alcantara . . . . .	238
Central locking . . . . .	33	Cleaning artificial leather . . . . .	238
Central locking switch . . . . .	37	Cleaning carbon parts . . . . .	237, 238
Convenience key . . . . .	36	Cleaning controls . . . . .	237
Emergency locking . . . . .	39	Cleaning decorative parts and trim . . . . .	236, 237
Folding the exterior mirrors . . . . .	37	Cleaning displays . . . . .	237
Luggage compartment lid . . . . .	39	Cleaning exhaust tail pipes . . . . .	236
Panorama sunroof . . . . .	41	Cleaning plastic parts . . . . .	237
Power windows . . . . .	41	Cleaning rims . . . . .	236
Remote control key . . . . .	35	Cleaning seat covers . . . . .	238
Safety central locking . . . . .	38	Cleaning tail lights . . . . .	236
Setting . . . . .	37	Cleaning textiles . . . . .	238
Certification . . . . .	265	Climate control system	
Changing engine oil . . . . .	204	Key recognition . . . . .	64
Child restraints		Climate control system (automatic)	
Danger of using child restraints in the front		Adjusting air vents . . . . .	67, 68
seat . . . . .	149	Air distribution, air vents . . . . .	67
Where can I get additional information		AUTO (climate control system) . . . . .	66
about child restraints and their use? . . . . .	189	Blower . . . . .	67
Child restraint system anchors . . . . .	185	Controls . . . . .	66
Child safety . . . . .	172	Defrosting the windshield . . . . .	67
Important safety instructions for using child		Drive select . . . . .	112
safety seats . . . . .	175	Rear window defogger . . . . .	68
Tether anchors . . . . .	188	Recirculation mode . . . . .	67
Tether straps . . . . .	188	Setting the temperature . . . . .	67
Child safety lock		synchronizing . . . . .	67
Power windows . . . . .	40	Climate control system (manual)	
Rear doors . . . . .	40	Adjusting air vents . . . . .	65, 68
Child safety seats		Adjusting the temperature . . . . .	65
Booster seats . . . . .	181	Air distribution, air vents . . . . .	65
Convertible child seats . . . . .	179	Blower . . . . .	65
How do I properly install a child safety seat		Defrosting windows . . . . .	65
in my vehicle? . . . . .	175	Operation . . . . .	65
Infant seats . . . . .	178	Rear window defogger . . . . .	68
Installing a child restraint using the LATCH		Recirculation mode . . . . .	65
system . . . . .	187	Clock . . . . .	10
LATCH system . . . . .	187	Closing	
Lower anchorages . . . . .	186	Hood . . . . .	200
Mounting and releasing the anchorage		Panorama sunroof . . . . .	42
hook . . . . .	187	Windows . . . . .	40
Safety instructions . . . . .	175	Closing/opening	
Unused safety belts on the rear seat . . . . .	177	by remote control . . . . .	35
		with the central locking switch . . . . .	37



with the convenience key . . . . .	36	<b>D</b>	Data recorder . . . . .	122
with the door lock . . . . .	37		Date display . . . . .	10
Cockpit (overview) . . . . .	8		Daytime running lights . . . . .	43
Coming home . . . . .	45		Declaration of compliance	
Compartments . . . . .	58		Adaptive cruise control . . . . .	265
Compass in the mirror . . . . .	51		Audi side assist . . . . .	265
Compliance . . . . .	265		Cell phone package . . . . .	265
Consumer information . . . . .	262		Convenience key . . . . .	265
Consumer Information . . . . .	138		Electronic immobilizer . . . . .	265
Consumption (fuel) . . . . .	28		HomeLink universal remote control . . . . .	265
Contacting NHTSA . . . . .	138		Remote control key . . . . .	265
Convenience key			Defective light bulb warning	
Emergency operation . . . . .	77		Indicator light . . . . .	24
Indicator light . . . . .	77		Defrosting (windshield)	
Starting the engine (START ENGINE STOP button) . . . . .	75		automatic climate control system . . . . .	67
Stopping the engine (START ENGINE STOP button) . . . . .	76		manual climate control system . . . . .	65
Switching on the ignition . . . . .	75		DEF (instrument cluster) . . . . .	11
unlocking/locking . . . . .	36		Deluxe automatic climate control	
Convenience opening/closing . . . . .	41		<i>refer to</i> Climate control system (automatic) .66	
Convertible child safety seats . . . . .	179		Determining correct load limit . . . . .	228
Convertible locking retractor		Diesel		
Activating . . . . .	184	Indicator light . . . . .	22	
Deactivating . . . . .	185	Preheating (button) . . . . .	75	
Using to secure a child safety seat . . . . .	184	Preheating (key) . . . . .	73	
Coolant		Diesel fuel . . . . .	191	
<i>refer to</i> Engine coolant . . . . .	205	Diesel particulate filter . . . . .	195	
Cooling mode (automatic climate control sys- tem) . . . . .	66	Digital compass . . . . .	51	
Cooling mode (manual climate control sys- tem) . . . . .	65	Dimensions . . . . .	259	
Cooling system		Dimming the rearview mirror . . . . .	48	
Adding coolant . . . . .	206	Distance . . . . .	28	
Coolant level checking . . . . .	206	Door/luggage compartment lid warning . . .	27	
Coolant temperature indicator . . . . .	12	Door contact switch . . . . .	46	
Indicator light . . . . .	19	Doors		
Cornering light . . . . .	43	Child safety lock (mechanical) . . . . .	40	
Cruise control system		Driver information system . . . . .	27	
Changing speed . . . . .	95	Boost . . . . .	29	
Description . . . . .	94	CD/radio display . . . . .	27	
Preselecting speed . . . . .	95	Door/luggage compartment lid warning . .	27	
Switching off . . . . .	95	Efficiency program . . . . .	29	
switching on . . . . .	95	Engine oil temperature indicator . . . . .	30	
Cup holders . . . . .	58	Indicator lights . . . . .	13	
Current consumption . . . . .	27, 28	Lap timer . . . . .	30	
		Messages . . . . .	13	
		On-board computer . . . . .	28	
		Outside temperature display . . . . .	27	



Service interval display . . . . .	212	Emergency release	
Using the multifunction steering wheel . . .	27	Fuel filler door . . . . .	194
Driver seating position . . . . .	131	Selector lever . . . . .	89
Drive select . . . . .	112	Emergency starting . . . . .	252
Indicator light . . . . .	25	Energy management . . . . .	128
Driving economically . . . . .	70	Indicator light . . . . .	19
Driving safely . . . . .	130	Engine	
Driving through water . . . . .	70	Coolant . . . . .	205
Driving time . . . . .	28	Preheating (button) . . . . .	75
Dust filter		Preheating (key) . . . . .	73
refer to Pollutant filter . . . . .	64	Starting with jumper cables . . . . .	252
		Starting (button) . . . . .	75
		Starting (driver messages with convenience key) . . . . .	77
		Starting (key) . . . . .	73
		stopping (button) . . . . .	76
		stopping (key) . . . . .	74
		Engine compartment	
		Closing the hood . . . . .	200
		Opening the hood . . . . .	199
		Overview . . . . .	200, 201
		Safety precautions . . . . .	198
		Engine control (indicator light) . . . . .	22
		Engine coolant . . . . .	205
		Radiator fan . . . . .	206
		Engine oil . . . . .	201
		adding . . . . .	203
		Changing . . . . .	204
		Checking the oil level . . . . .	203
		Dipstick . . . . .	200, 201, 203
		Indicator light . . . . .	19
		Oil consumption . . . . .	202
		Specification and viscosity . . . . .	201
		Temperature indicator . . . . .	30
		Use . . . . .	203
		Engine speed limitation (indicator light) . . .	23
		Environment	
		Break-in period . . . . .	70
		Catalytic converter . . . . .	194
		Diesel particulate filter . . . . .	195
		Disposing of your vehicle battery . . . . .	211
		Driving at high speeds . . . . .	71
		Letting the vehicle stand and warm up . . . .	71
		Proper disposal of drained brake fluid . . .	207
		Proper disposal of drained engine oil . . . .	204
		Unleaded fuel . . . . .	190
		What should I do with an old battery? . . .	211
		EPC (engine control) . . . . .	22
ECO mode (automatic climate control system) . . . . .	66		
Efficiency program . . . . .	29		
Description . . . . .	29		
Fuel economy messages . . . . .	30		
Other equipment . . . . .	30		
Electrical accessories			
refer to Socket . . . . .	57		
Electromechanical parking brake			
refer to Parking brake . . . . .	78		
Electromechanical steering . . . . .	126		
Indicator lights . . . . .	126		
Electronic differential lock . . . . .	123		
Indicator light . . . . .	21		
Electronic immobilizer . . . . .	38		
also refer to Immobilizer . . . . .	33		
Electronic speed limiter . . . . .	94		
Electronic stabilization control (ESC)			
Indicator light . . . . .	21		
Sport mode . . . . .	124		
Electronic Stabilization Control (ESC) . . . .	123		
Emergency assistance . . . . .	240		
Emergency flasher . . . . .	44		
Emergency flashers			
Indicator light . . . . .	25		
Emergency operation			
Emergency braking function . . . . .	80		
Front passenger's door/rear doors . . . . .	39		
Luggage compartment lid . . . . .	240		
Panorama sunroof . . . . .	42		
with convenience key . . . . .	77		



- ESC  
 Automatic post-collision braking system . 123  
 Electronic stabilization control . . . . . 123  
 Sport mode . . . . . 124  
*also refer to Electronic Stabilization Control (ESC)* . . . . . 123
- ESP  
*refer to Electronic Stabilization Control (ESC)* . . . . . 123
- Event Data Recorder (EDR) . . . . . 122
- Exterior lighting . . . . . 43
- Exterior mirrors  
 Adjusting . . . . . 47  
 Dimming . . . . . 48  
 folding . . . . . 47  
 Heating . . . . . 47
- F**
- Fastening  
 Booster seats . . . . . 181  
 Convertible child safety seats . . . . . 179  
 Infant seats . . . . . 178
- Floor mats . . . . . 135
- Fog lights/rear fog light(s) . . . . . 43
- Folding the exterior mirrors  
 Center locking . . . . . 37
- Folding the rear seats . . . . . 60
- Foot pedals . . . . . 135
- Footwell lighting . . . . . 46
- For the sake of the environment  
 Environmentally-friendly driving . . . . . 70  
 Fueling . . . . . 192  
 Leaks . . . . . 199  
 Rear window defogger . . . . . 68
- Freeze protection  
 Windshield washer system . . . . . 212
- Front airbags  
 Description . . . . . 152  
 How they work . . . . . 158
- Frontal collisions and the laws of physics . . 141
- Front armrest . . . . . 55
- Front passenger's door emergency locking . . 39
- Front seats  
 Adjusting . . . . . 132  
 Child restraints in the front seat . . . . . 149  
*also refer to Seats* . . . . . 53, 60
- Fuel  
 Additives . . . . . 190  
 Blended gasoline . . . . . 190  
 Current consumption . . . . . 28  
 Fuel filler neck . . . . . 192  
 Fuel gauge . . . . . 10, 11  
 Fuel tank capacity . . . . . 260  
 Gasoline . . . . . 190  
 Gasoline additives . . . . . 191  
 Indicator light . . . . . 23  
 Octane rating . . . . . 190  
 Recommendation . . . . . 190  
 Saving fuel . . . . . 70, 112
- Fuel economy messages (efficiency program) . 30
- Fueling  
 Fuel filler door emergency release . . . . . 194  
 Fuel gauge . . . . . 11  
 Fuel tank capacity . . . . . 260  
 Opening the fuel filler door . . . . . 192
- Fuses  
 Assignment . . . . . 249  
 Interior . . . . . 248  
 replacing . . . . . 248
- G**
- Garment hooks . . . . . 59
- Gas discharge lamps . . . . . 250
- Glossary of tire and loading terminology . . 216
- Glove compartment . . . . . 58  
 CD changer . . . . . 58
- Gross Vehicle Weight Rating (GVWR) . . . . . 258
- H**
- Headlight range control system . . . . . 43  
 Indicator light . . . . . 24
- Headlights . . . . . 43, 45  
 Cleaning . . . . . 236  
 Headlight range control system . . . . . 43  
 Left hand drive, right hand drive . . . . . 46  
 Travel mode . . . . . 46  
 Washer system . . . . . 49
- Head restraints . . . . . 134  
 adjusting . . . . . 56  
 Adjusting . . . . . 134  
 removing and installing . . . . . 56



Heated  
 exterior mirrors ..... 47  
 Rear window ..... 68  
 Seats ..... 68  
 Washer fluid nozzles ..... 49  
 Heating (diesel engine auxiliary heater) .... 69  
 Heavy clothing and safety belts ..... 142  
 Hex socket ..... 241  
 High voltage warning label ..... 258  
 Highway light ..... 44  
 Hill descent control ..... 86  
 Hill hold ..... 80  
 Hill hold assist  
     *refer to* Hill hold ..... 80  
 Horn ..... 8  
 How are child restraint system anchors related to child safety ..... 185  
 How many airbags does my vehicle have? .. 155  
 How safety belt pretensioners work ..... 146

**I**

Ignition  
 Indicator light ..... 20  
 Switching on/off (with button) ..... 75  
 Ignition key safety interlock ..... 73  
 Ignition lock  
     mechanical ..... 73  
 Imbalance (wheels) ..... 222  
 Immobilizer ..... 33  
 Important things to do before driving .... 130  
 Improperly worn safety belts ..... 146  
 Indicator lights ..... 13  
 Infant seats ..... 178  
 Inflation pressure (tires) ..... 224  
 Inspection interval  
     with driver information system ..... 212  
 Installing child safety seats  
     Safety belts ..... 182  
 Installing the upper tether strap on the anchorage ..... 188  
 Instrument cluster ..... 10  
 Instruments ..... 10  
     Adjusting the lighting ..... 47  
 Interior lighting ..... 46  
 Intermittent (windshield wipers) ..... 49

**J**  
 Jump-starting ..... 252  
 Jump start cables ..... 253

**K**  
 Key ..... 33  
     Checking the number ..... 33  
     Driver messages (mechanical ignition key) . 77  
     Driver messages (with convenience key) ... 77  
     Key not recognized ..... 77  
     Key replacement ..... 33  
     Replacing the battery ..... 34  
     unlocking/locking ..... 35, 36, 37  
 Key recognition  
     Climate control system ..... 64  
 Kick-down  
     Automatic transmission ..... 87  
 Knee airbags ..... 164  
     Description ..... 164  
     How they work ..... 165  
     Important safety instructions ..... 166

**L**  
 Lane assist  
     *refer to* Active lane assist ..... 106  
 Lap timer ..... 30  
     Evaluating recorded times ..... 32  
     Starting ..... 31  
 LATCH ..... 185  
     Description ..... 186  
     Installing a child restraint ..... 187  
     Location ..... 186  
     Mounting and releasing the anchorage  
         hook ..... 187  
 Launch Control-Program (automatic transmission) ..... 88  
 Leather care/cleaning ..... 238  
 Leaving home ..... 45  
 LED headlights  
     All-weather lights ..... 43  
 Left hand drive ..... 46  
 Lifting jack ..... 243  
 Light  
     Adaptive light ..... 43  
     Adjusting automatic headlights ..... 45



- Coming/Leaving home . . . . . 45
- Fog lights/rear fog light(s) . . . . . 43
- Headlight flasher . . . . . 45
- Headlights . . . . . 43, 45
- Highway light . . . . . 44
- Low beams . . . . . 43
- Parking light . . . . . 43
- Switching daytime running lights on and off . . . . . 45
- Travel mode . . . . . 46
- Light/rain sensor
- Headlights . . . . . 43
- Indicator light . . . . . 24
- Intermittent (windshield wipers) . . . . . 49
- Lighting
- Exterior . . . . . 43
- Interior . . . . . 46
- Lights
- Ambient lighting . . . . . 46
- Headlight range control system . . . . . 43
- Interior/reading . . . . . 46
- Loading the roof rack . . . . . 63
- Locking/unlocking
- by remote control . . . . . 35
- with the central locking switch . . . . . 37
- with the convenience key . . . . . 36
- with the door lock . . . . . 37
- Long-term memory . . . . . 28
- Low beam
- Indicator light . . . . . 24
- Low beams . . . . . 43
- Lower universal anchorages (Canada) . . . . . 185
- Luggage compartment . . . . . 59
- Cargo net . . . . . 61
- Increasing the size . . . . . 60
- Loading . . . . . 59
- Pass-through . . . . . 62
- Reversible mat . . . . . 61
- Socket . . . . . 57
- Storage hooks . . . . . 61
- Storing cargo correctly . . . . . 136
- Stowing luggage . . . . . 136
- Tie-downs . . . . . 61
- Luggage compartment lid
- Central locking . . . . . 39
- Emergency release . . . . . 240
- Lumbar support . . . . . 54, 55
- M**
- Magnetic ride
- refer to* Adaptive dampers . . . . . 112
- Maintenance . . . . . 262
- Maintenance intervals
- with driver information system . . . . . 212
- Mirror
- Digital compass switching on and off . . . . . 51
- dimming . . . . . 48
- Vanity mirror . . . . . 49
- Mirror compass . . . . . 51
- Mirrors
- Adjusting the exterior mirrors . . . . . 47
- Monitoring the Advanced Airbag System . . . . . 160
- Motor
- stopping (driver messages with mechanical ignition key) . . . . . 77
- Multifunction steering wheel . . . . . 28
- On-board computer . . . . . 28
- N**
- Natural leather care/cleaning . . . . . 238
- Navigation system
- CD-ROM player . . . . . 58
- NHTSA
- Contacting . . . . . 138
- Nitrogen oxide (NOx) catalytic converter
- refer to* AdBlue . . . . . 195
- Number of seats . . . . . 140
- Number of vehicle keys . . . . . 33
- O**
- Occupant protection . . . . . 103
- Occupant seating positions . . . . . 131
- Octane rating . . . . . 190
- Odometer . . . . . 11
- Oil
- Indicator light . . . . . 23
- also refer to* Engine oil . . . . . 201, 203
- Oil change interval
- with driver information system . . . . . 212
- On-Board-Diagnostic System (OBD)
- System indicator light (MIL) . . . . . 25
- On-board computer . . . . . 27
- Operation (multifunction steering wheel) . . . . . 28



On-Board Diagnostic System (OBD)	
Data Link Connector (DLC) . . . . .	25
Electronic speed limiter . . . . .	94
Opening . . . . .	33
Fuel filler door . . . . .	192
Hood . . . . .	199
Luggage compartment lid . . . . .	39
Panorama sunroof . . . . .	42
Windows . . . . .	40
Opening/closing	
with the central locking switch . . . . .	37
with the convenience key . . . . .	36
with the door lock . . . . .	37
Other equipment (efficiency program) . . . . .	30
Outside temperature display . . . . .	11
Overview (Cockpit) . . . . .	8
Owner's Literature . . . . .	5
<b>P</b>	
Paint damage . . . . .	237
Paint No. . . . .	258
Panorama sunroof . . . . .	42
Convenience opening/closing . . . . .	41
Emergency closing . . . . .	42
Parking aid	
Cleaning sensors/camera . . . . .	236
Parking brake . . . . .	78
Emergency braking function . . . . .	80
Indicator light . . . . .	18
Parking . . . . .	79
Power supply failure . . . . .	78
Setting/releasing . . . . .	78
Starting from a stop . . . . .	80
<i>also refer to</i> Parking brake . . . . .	78
Parking light . . . . .	43
Parking system	
Adjusting the display/warning tone . . . . .	121
Cleaning the rearview camera . . . . .	118
Malfunction . . . . .	121
Parking system plus . . . . .	116
Peripheral display . . . . .	116
Rearview camera . . . . .	117
<i>also refer to</i> Parking systems . . . . .	116, 117
Parking systems . . . . .	115
Rear parking system . . . . .	116
Parking (automatic transmission) . . . . .	84, 85
particulate filter	
<i>refer to</i> Diesel particulate filter . . . . .	195
Parts replacement . . . . .	264
Pass-through . . . . .	62
PASSENGER AIR BAG OFF light . . . . .	160
Pedals . . . . .	135
Peripheral display . . . . .	116
Physical principles of a frontal collision . . . . .	141
Polishing . . . . .	237
Pollen filter	
<i>refer to</i> Pollutant filter . . . . .	64
Pollutant filter . . . . .	64
Power	
seat adjustment . . . . .	55
Windows . . . . .	40
Power windows . . . . .	40
Convenience opening/closing . . . . .	41
Malfunction . . . . .	41
Pregnant women	
Special considerations when wearing a safety belt . . . . .	145
Preheating	
With button . . . . .	75
with key . . . . .	73
Pre sense . . . . .	103
Basic (description) . . . . .	103
Driver messages . . . . .	102, 106
Front (description) . . . . .	104
General information . . . . .	103
General Information . . . . .	97
Settings . . . . .	105
Warnings . . . . .	104
Pressure (tires) . . . . .	233
Proper occupant seating positions . . . . .	131
Proper safety belt position . . . . .	144
Proper seating position	
Front passenger . . . . .	132
Occupants . . . . .	131
Rear passengers . . . . .	133
Protecting . . . . .	237
Protection mat	
<i>refer to</i> Reversible mat . . . . .	61
<b>Q</b>	
Question	
What happens to unbelted occupants? . . . . .	141



- R**
- Radiator fan ..... 206
  - Radio clock
    - refer to* Clock ..... 10
  - Rain/light sensor
    - Headlights ..... 43
    - Indicator light ..... 24
    - Intermittent (windshield wipers) ..... 49
    - Switching on/off ..... 49
  - Raising the vehicle ..... 256
  - Range (tank contents) ..... 28
  - Rear armrest ..... 56
  - Rear lid
    - refer to* Luggage compartment lid ..... 39
  - Rear light
    - Indicator light ..... 24
  - Rearview camera
    - refer to* Parking systems ..... 116, 117
  - Rearview mirror
    - refer to* Mirror ..... 48
  - Rearview mirror dimming ..... 48
  - Rear window defogger ..... 68
  - Recirculation mode
    - automatic control system ..... 67
    - manual climate control system ..... 65
  - Reducing fuel consumption
    - Efficiency program ..... 29
  - Remote control
    - refer to* Remote control key ..... 33
  - Remote control key ..... 33
    - LED ..... 33, 34
    - Replacing the battery ..... 34
    - Synchronization ..... 35
    - unlocking/locking ..... 35
  - Repair manuals ..... 262
  - Repairs
    - Airbag system ..... 163
  - Replacement key ..... 33
  - Replacing
    - Light bulbs ..... 250
  - Replacing windshield wiper blades ..... 50
  - Reporting Safety Defects ..... 138
  - Reset button (trip odometer) ..... 11
  - Resetting the trip odometer ..... 11
  - Retract
    - New brake pads ..... 125
  - Retractor ..... 143
  - Reverse (automatic transmission) ..... 82
  - Reversible mat ..... 61
  - Right hand drive ..... 46
  - Rims ..... 229
  - Roof rack ..... 62
    - Loading ..... 63
    - Roof weight ..... 63
- S**
- Saddlebag ..... 61
  - Safe driving habits ..... 130
  - Safety
    - Airbag system ..... 148
    - Belts ..... 140
    - Cargo ..... 136
    - Correct seating position ..... 131
    - Pedal area ..... 135
  - Safety belt position ..... 144
    - Safety belt height adjustment ..... 146
    - Safety belts worn by pregnant women ... 145
  - Safety belt pretensioner
    - Service and disposal ..... 147
  - Safety belts ..... 140, 143
    - Adjusting ..... 145
    - Cleaning ..... 237
    - Danger to passengers who do not wear a safety belt ..... 141
    - Fastening ..... 143
    - Height adjustment ..... 146
    - Improperly worn ..... 146
    - Indicator light ..... 20
    - Not worn ..... 141
    - Safety belt position ..... 144
    - Safety instructions ..... 142
    - Securing child safety seats ..... 182
    - Special considerations for pregnant women ..... 145
    - Unfastening ..... 145
    - Warning/indicator light ..... 140
    - Worn properly ..... 142
  - Safety belt warning light ..... 140
  - Safety central locking ..... 38
  - Safety compliance sticker ..... 258
  - Safety equipment ..... 130



Safety features for occupant restraint and protection . . . . .	130	Side airbags	
Safety guidelines		Description . . . . .	166
Seat adjustment . . . . .	53	How they work . . . . .	168
Safety instructions		Side assist . . . . .	109
for side curtain airbags . . . . .	171	Adjusting the brightness . . . . .	111
for using child safety seats . . . . .	175	Cleaning the sensors . . . . .	236
for using safety belts . . . . .	142	Sensor range . . . . .	110
Monitoring the Advanced Airbag System . . . . .	162	switching on and off . . . . .	111
Safety systems (indicator light) . . . . .	20	<i>also refer to</i> Side assist . . . . .	109
Screwdriver . . . . .	241	Side curtain airbags . . . . .	169
Seat adjustment		Description . . . . .	169
Driver's seat . . . . .	53	How they work . . . . .	170
Front passenger's seat . . . . .	54	Safety instructions . . . . .	171
Head restraints . . . . .	134	Sliding/tilting sunroof	
Safety guidelines . . . . .	53	<i>refer to</i> Panorama sunroof . . . . .	42
Seat heating . . . . .	68	Snow chains . . . . .	230
Seating position		All wheel drive . . . . .	127
Driver . . . . .	131	Socket . . . . .	57
Front passenger . . . . .	132	Sources of information about child restraints and their use . . . . .	189
How to adjust the front seats . . . . .	132	Speed limiter . . . . .	94
Incorrect seat position . . . . .	134	Speedometer . . . . .	27
Occupants . . . . .	131	Speed warning system . . . . .	94
Rear passengers . . . . .	133	Sport mode . . . . .	124
Seats		Stabilization program	
adjusting . . . . .	54, 55	<i>refer to</i> Electronic Stabilization	
Correct seating position . . . . .	131	Control (ESC) . . . . .	123
Folding . . . . .	60	Star button . . . . .	28
Seats (number) . . . . .	140	START ENGINE STOP button (convenience key) . . . . .	75
Selective catalytic reduction		START ENGINE STOP (convenience key) . . . . .	76
<i>refer to</i> AdBlue . . . . .	195	Starting	
Selective wheel torque control . . . . .	123	Hill hold . . . . .	80
Selector lever (automatic transmission)		Starting from a stop	
Emergency operation . . . . .	89	Hill start assist . . . . .	80
Position . . . . .	82	Starting (engine)	
Service and disposal		Malfunction (button) . . . . .	76
Safety belt pretensioner . . . . .	147	Malfunction (key) . . . . .	73
Service interval display		With button . . . . .	75
with driver information system . . . . .	212	With key . . . . .	73
Setting the clock . . . . .	10	Steering	
Setting the date . . . . .	10	Electromechanical steering . . . . .	126, 0
Setting the temperature		Indicator light . . . . .	20
automatic climate control system . . . . .	67	Locking steering (ignition key) . . . . .	74
Setting the time . . . . .	10	Locking the steering (button) . . . . .	76
SETUP (basic settings) . . . . .	10	Locking (mechanical ignition lock) . . . . .	73
Shift paddles (automatic transmission) . . . . .	87	<i>also refer to</i> Electromechanical steering . . . . .	126
Short-term memory . . . . .	28		



- Steering wheel  
 adjusting ..... 72  
 Buttons ..... 28  
 Multifunction steering wheel ..... 27  
 Shift paddles (automatic transmission) ... 87
- Steps for determining correct load limit ... 228
- Stopping (engine)  
 with button ..... 76  
 with key ..... 74
- Storage compartments ..... 58, 59
- Storage hooks ..... 61
- S tronic (automatic transmission) ..... 82
- Sun visors ..... 49
- Switching daytime running lights on and off 45
- Switching the ignition on/off (with key) .... 73
- Symbols  
*refer to* Indicator lights ..... 13
- System indicator light (MIL) ..... 22, 25
- T**
- Tachometer ..... 10, 11
- TDI clean diesel  
*refer to* AdBlue ..... 195
- Technical Data ..... 258
- Technical modifications ..... 264
- Temperature display  
 Coolant ..... 10  
 Outside temperature ..... 11
- Tether anchors ..... 188
- Tether strap ..... 188
- The first 1,000 miles (1,500 km) and after-wards ..... 70
- Tie-downs ..... 61, 137
- Tips for the environment  
 Saving fuel ..... 63
- tiptronic (automatic transmission) ..... 87
- Tires ..... 214  
 Low aspect ratio tires ..... 230  
 Replacing ..... 241  
 Service life ..... 222  
 Tire pressure ..... 224  
 Tire pressure monitoring system ... 232, 233  
 Tire pressure table ..... 225  
 Treadwear indicators ..... 222  
 Unidirectional ..... 216  
 Uniform tire quality grading ..... 231
- Tires and wheels  
 Glossary of tire and loading terminology . 216  
 Tires and vehicle load limits ..... 227
- Tool kit ..... 241
- Torn or frayed safety belts ..... 142
- Towing  
 Tow trucks ..... 254
- Towing loop ..... 255
- TPMS (tire pressure monitoring system) ... 233
- Trailer mode ..... 91  
 Notes ..... 92
- Trailer towing  
 Operating instructions ..... 91  
 Technical requirements ..... 91, 92
- Transmission malfunction (indicator light) .. 88
- Transport Canada ..... 138
- Travel mode ..... 46
- Trunk  
*refer to* Luggage compartment ..... 59
- Turning light ..... 43
- Turn signals ..... 45  
 Indicator light ..... 25
- U**
- ULSD No. 2 (Diesel fuel) ..... 191
- Unfastening safety belts ..... 145
- Uniform tire quality grading ..... 231
- Unlocking/locking  
 by remote control ..... 35  
 with the central locking switch ..... 37  
 with the convenience key ..... 36  
 with the door lock ..... 37
- V**
- Vanity mirror ..... 49
- Vehicle  
 Care/cleaning ..... 235  
 Dimensions ..... 259
- Vehicle control modules ..... 122
- Vehicle identification label ..... 258
- Vehicle Identification Number (VIN) ..... 258
- Vehicle jack ..... 241, 243
- Vehicle key ..... 33
- Vehicle tool kit ..... 241



**W**

Warning/indicator lights  
 System indicator light (MIL) ..... 22

Warning/Indicator lights  
 Airbag system ..... 160  
 PASSENGER AIR BAG OFF ..... 160

Warning lights  
*refer to* Indicator lights ..... 13

Warranty coverages ..... 262

Washer fluid level (indicator light) ..... 24

Washing matte finish paint ..... 235

Weights ..... 258

What happens if you wear your safety belt too loose? ..... 144

What happens to unbelted occupants? .... 141

What impairs driving safety? ..... 131

Wheel bolts ..... 229

Wheels ..... 214  
 All wheel drive ..... 127  
 Cleaning ..... 236  
 Glossary of tire and loading terminology . 216  
 Replacing ..... 241  
 Tires and vehicle load limits ..... 227

Wheel wrench ..... 241

When must a safety belt be replaced? .... 142

When must the airbag system be inspected? .160

Where are lower anchorages located? ..... 186

Windows  
 Cleaning/removing ice ..... 237

Windshield  
 cleaning ..... 49  
 defrosting (automatic climate control system) ..... 67  
 defrosting (manual climate control system) .65  
*also refer to* Windshield ..... 49

Windshield washer system ..... 49, 212  
 Filling ..... 212  
 Reservoir capacity ..... 260

Windshield wipers  
 Cleaning wiper blades ..... 50  
 Folding up ..... 50  
 Indicator light ..... 24  
 Replacing windshield wiper blades ..... 50  
 Switching on and off ..... 49

Winter driving  
 Snow chains ..... 230  
 Tires ..... 229

Winter operation  
 Battery ..... 208  
 Cooling system ..... 205  
 Windshield washer system ..... 212

Winter tires ..... 229

Winter use  
 Car washes ..... 235  
 defrosting the windshield (automatic climate control system) ..... 67  
 Removing ice from windows ..... 237  
 Seat heating ..... 68

**X**

Xenon-Lights ..... 250

Xenon headlights ..... 43, 46



© 2014 AUDI AG

It has always been Audi's policy to continuously improve its products. Audi, therefore, reserves the right to make changes in design and specifications, and to make additions or improvements in its products without incurring any obligation to install them on products previously manufactured. Text, illustrations and specifications in this book are based on the most up-to-date information available at the time of printing.

These instructions may not be reproduced or translated in whole or in part without written

consent of AUDI AG. All rights reserved by AUDI AG. Subject to alteration or amendment. Printed in Germany.

**Editorial deadline: 19.08.14**



**For the sake of the environment**

Printed on environmentally friendly paper  
(bleached without chlorine, recyclable)



**Owner's Manual**  
**2015 Audi A3 Sedan**  
**2015 Audi S3 Sedan**  
**Englisch USA 11.2014**  
**155.561.8V0.23**



1555618V023

[www.audi.com](http://www.audi.com)