

Owner's Manual
for Vehicle



The Ultimate
Driving Machine



X5 xDrive30i
X5 xDrive48i
X5 xDrive35d

X6 xDrive 35i
X6 xDrive 50i

X5 M
X6 M

Owner's Manual for Vehicle

Congratulations, and thank you for choosing a BMW.

Thorough familiarity with your vehicle will provide you with enhanced control and security when you drive it. We therefore have this request:

Please take the time to read this Owner's Manual and familiarize yourself with the information that we have compiled for you before starting off in your new vehicle. It contains important data and instructions intended to assist you in gaining maximum use and satisfaction from your BMW's unique range of technical features. The manual also contains information on maintenance designed to enhance operating safety and contribute to maintaining the value of your BMW throughout an extended service life.

This manual is supplemented by a Service and Warranty Information Booklet for US models or a Warranty and Service Guide Booklet for Canadian models.

We wish you an enjoyable driving experience.

BMW Group

© 2009 Bayerische Motoren Werke
Aktiengesellschaft
Munich, Germany
Reprinting, including excerpts,
only with the written consent of
BMW AG, Munich.
US English VI/09, 09 07 500
Printed on environmentally friendly paper,
bleached without chlorine, suitable for recycling.

Contents

The fastest way to find specific topics is to use the index, refer to page 279.

Using this Owner's Manual

- 4 Notes
- 7 Reporting safety defects

At a glance

- 10 Cockpit
- 16 iDrive
- 21 Letters and numbers
- 22 Voice activation system

Controls

- 26 Opening and closing
- 43 Adjusting
- 55 Transporting children safely
- 59 Driving
- 71 Everything under control
- 82 Technology for comfort, convenience and safety
- 102 Lamps
- 107 Climate
- 115 Practical interior accessories

Driving tips

- 130 Things to remember when driving

Navigation

- 140 Navigation system
- 141 Destination entry
- 150 Destination guidance
- 157 What to do if ...

Entertainment

- 160 On/off and tone
- 163 Radio
- 166 Satellite radio
- 171 CD/DVD player and CD/DVD changer
- 178 Music collection
- 183 External devices
- 187 DVD system in rear

Communications

- 202 Telephone
- 213 Contacts
- 215 BMW Assist

Mobility

- 224 Refueling
- 229 Wheels and tires
- 239 Under the hood
- 244 Maintenance
- 246 Care
- 250 Replacing components
- 261 Giving and receiving assistance

Reference

- 268 Technical data
- 273 Short commands of voice activation system
- 279 Everything from A to Z

Notes

About this Owner's Manual

We have made every effort to ensure that you are able to find what you need in this Owner's Manual as quickly as possible. The fastest way to find specific topics is to refer to the detailed index at the back of the manual. If you wish to gain an initial overview of your vehicle, you will find this in the first chapter.

Should you sell your BMW some day, please remember to hand over the Owner's Manual as well; it is an important component of your vehicle.

Additional sources of information

If you have additional questions, your BMW Sports Activity Vehicle Center is always happy to advise you.

You can find information on BMW, e.g. on technology, on the Internet at www.bmwusa.com.

Symbols used



Indicates precautions that must be followed precisely in order to avoid the possibility of personal injury and serious damage to the vehicle. ◀



Indicates information that will assist you in gaining the optimum benefit from your vehicle and enable you to care more effectively for your vehicle. ◀



Refers to measures that can be taken to help protect the environment. ◀

◀ Marks the end of a specific item of information.

* Indicates special equipment, country-specific equipment and optional accessories, as well as equipment and functions not yet available at the time of printing.

"..." Identifies Control Display texts used to select individual functions.

›...‹ Verbal instructions to use with the voice activation system.

››...‹‹ Identifies the answers generated by the voice activation system.

Symbols on vehicle components



Indicates that you should consult the relevant section of this Owner's Manual for information on a particular part or assembly.

The individual vehicle

When purchasing your BMW, you have decided in favor of a model with individualized equipment and features. This Owner's Manual describes the entire array of options and equipment available with a specific BMW model.

Please bear in mind that the manual may contain information on accessories and equipment that you have not specified for your own vehicle. Sections describing options and special equipment are marked by asterisks * to assist you in identifying possible differences between the descriptions in this manual and your own vehicle's equipment.

If equipment in your BMW is not described in this Owner's Manual, please refer to the accompanying Supplementary Owner's Manuals.

Editorial notice

BMW pursues a policy of continuous, ongoing development that is conceived to ensure that our vehicles continue to embody the highest quality and safety standards combined with advanced, state-of-the-art technology. For this reason, it is possible that the features described in this Owner's Manual could differ from those on your vehicle.

For your own safety

Maintenance and repairs

 Advanced technology, e.g. the use of modern materials and high-performance electronics, requires specially adapted maintenance and repair methods. Therefore, have corresponding work on your BMW performed only by your BMW Sports Activity Vehicle Center or a workshop that works according to BMW repair procedures with correspondingly trained personnel. If this work is not carried out properly, there is a danger of subsequent damage and related safety hazards. ◀

Parts and accessories

 For your own safety, use genuine parts and accessories approved by BMW.

When you purchase accessories tested and approved by BMW and Genuine BMW Parts, you simultaneously acquire the assurance that they have been thoroughly tested by BMW to ensure optimum performance when installed on your vehicle.

BMW warrants these parts to be free from defects in material and workmanship. BMW will not accept any liability for damage resulting from installation of parts and accessories not approved by BMW.

BMW cannot test every product made by other manufacturers to verify if it can be used on a BMW safely and without risk to either the vehicle, its operation or its occupants.

Genuine BMW Parts, BMW Accessories and other products approved by BMW, together with professional advice on using these items, are available from all BMW Sports Activity Vehicle Centers.

Installation and operation of non-BMW approved accessories such as alarms, radios, amplifiers, radar detectors, wheels, suspension components, brake dust shields, telephones, including operation of any mobile phone from within the vehicle without using an externally mounted antenna, or transceiver equipment such as CBs, walkie-talkies, ham radios, or similar accessories may cause extensive damage to the vehicle, compromise its safety, interfere with the vehicle's electrical system or affect the validity of the BMW Limited Warranty. Refer to your BMW Sports Activity Vehicle Center for additional information. ◀

 Maintenance, replacement, or repair of the emission control devices and systems may be performed by any automotive repair establishment or individual using any certified automotive part. ◀

California Proposition 65 Warning

California laws require us to issue the following warning:



Engine exhaust and a wide variety of automobile components and parts, including components found in the interior furnishings in a vehicle, contain or emit chemicals known to the State of California to cause cancer and birth defects and reproductive harm. In addition, certain fluids contained in vehicles and certain products of component wear contain or emit chemicals known to the State of California to cause cancer and birth defects or other reproductive harm.

Battery posts, terminals and related accessories contain lead and lead compounds. Wash your hands after handling.

Used engine oil contains chemicals that have caused cancer in laboratory animals. Always protect your skin by washing thoroughly with soap and water. ◀

Service and warranty

We recommend that you read this publication thoroughly.

Your BMW is covered by the following warranties:

- ▷ New Vehicle Limited Warranty
- ▷ Rust Perforation Limited Warranty
- ▷ Federal Emissions System Defect Warranty
- ▷ Federal Emissions Performance Warranty
- ▷ California Emission Control System Limited Warranty

Detailed information about these warranties is listed in the Service and Warranty Information Booklet for US models or in the Warranty and Service Guide Booklet for Canadian models.

Your vehicle has been specifically adapted and designed to meet the particular operating conditions and homologation requirements in your country and continental region in order to deliver the full driving pleasure while the vehicle is operated under those conditions. If you wish to operate your vehicle in another country or region, you may be required to adapt your vehicle to meet different prevailing operating conditions and homologation requirements. You should also be aware of any applicable warranty limitations or exclusions for such country or region. In such case, please contact Customer Relations for further information.

Reporting safety defects

For US customers

The following applies only to vehicles owned and operated in the US.

If you believe that your vehicle has a defect which could cause a crash or could cause injury or death, you should immediately inform the National Highway Traffic Safety Administration, NHTSA, in addition to notifying BMW of North America, LLC, P.O. Box 1227, Westwood, New Jersey 07675-1227, Telephone 1-800-831-1117.

If NHTSA receives similar complaints, it may open an investigation, and if it finds that a safety defect exists in a group of vehicles, it may order a recall and remedy campaign. However, NHTSA cannot become involved in individual problems between you, your dealer, or BMW of North America, LLC.

To contact NHTSA, you may call the Vehicle Safety Hotline toll-free at 1-888-327-4236 (TTY: 1-800-424-9153); go to <http://www.safercar.gov>; or write to: Administrator, NHTSA, 400 Seventh Street, SW., Washington, DC 20590. You can also obtain other information about motor vehicle safety from <http://www.safercar.gov>

For Canadian customers

Canadian customers who wish to report a safety-related defect to Transport Canada, Defect Investigations and Recalls, may call 1-800-333-0510 toll-free from anywhere in Canada or 1-613-993-9851 from the Ottawa region and from other countries, or contact Transport Canada by mail at: Transport Canada, ASFAD, Place de Ville, Tower C, 330 Sparks Street, Ottawa, ON, K1A 0N5. You can also obtain other information about motor vehicle safety from <http://www.tc.gc.ca>





At a glance





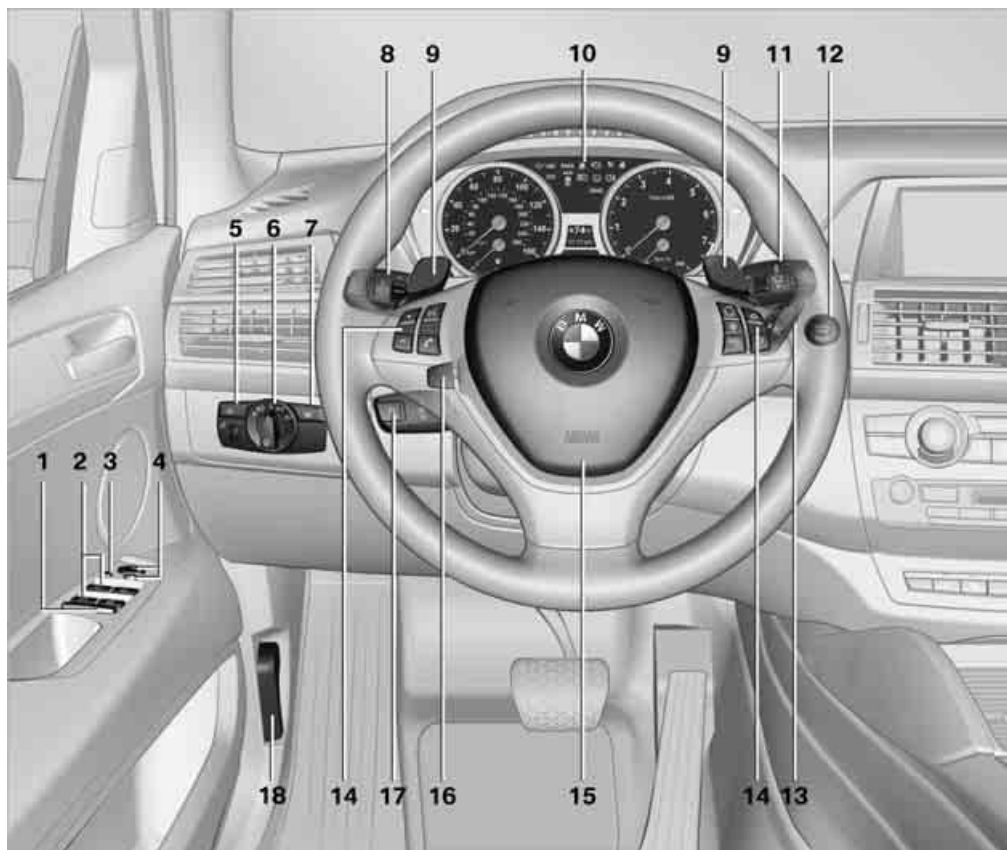











This overview of buttons, switches and displays is intended to familiarize you with your vehicle's operating environment. The section will also assist you in becoming acquainted with the control concepts and options available for operating the various systems.

Cockpit









Around the steering wheel: controls and displays





- 1 Rear window safety switch [38](#)
- 2 Opening and closing windows [37](#)
- 3 Folding exterior mirrors in and out* [52](#)
- 4 Adjusting exterior mirrors [52](#)
Automatic curb monitor* [53](#)
- 5  Instrument lighting [105](#)
-  Fog lamps [105*](#)

- 6  Parking lamps [102](#)
-  Low beams [102](#)
-  Automatic headlamp control* [102](#)
-  Adaptive Head Light* [103](#)
-  High-beam assistant* [104](#)
- 7  Head-Up Display* [100](#)
- 8  Turn signals [67](#)
-  High beams, headlamp flasher [67](#)
-  High-beam assistant* [104](#)
-  Roadside parking lamps* [104](#)
-  Time, date, outside temperature, Check Control [71, 78](#)
-  Computer [73](#)
- 9 BMW X6: upshifting or downshifting with automatic transmission [65](#)
- 10 Instrument panel [12](#)
- 11  Windshield wipers [67](#)
-  Rain sensor [68](#)
-  BMW X5: rear window wiper [68](#)
- 12  Starting/stopping engine and switching ignition on/off [59](#)
- 13 Ignition lock [59](#)

14 Buttons on steering wheel

-  Telephone*:
Accepting and ending calls, start dialing* selected phone number, redialing if no phone number is selected
-  Volume
-  Activating/deactivating voice activation system* [22](#)
-  Changing the radio station
-  Selecting a music track
-  Scrolling through the redial list
-  Next entertainment source
-  Recirculated-air mode, [110](#)
-  Steering wheel heating* [54](#)

15 Horn, entire surface

- 16  Steering wheel adjustment [53](#)
- 17  Cruise control* [69](#)
- 18 Releasing hood [239](#)

Instrument panel

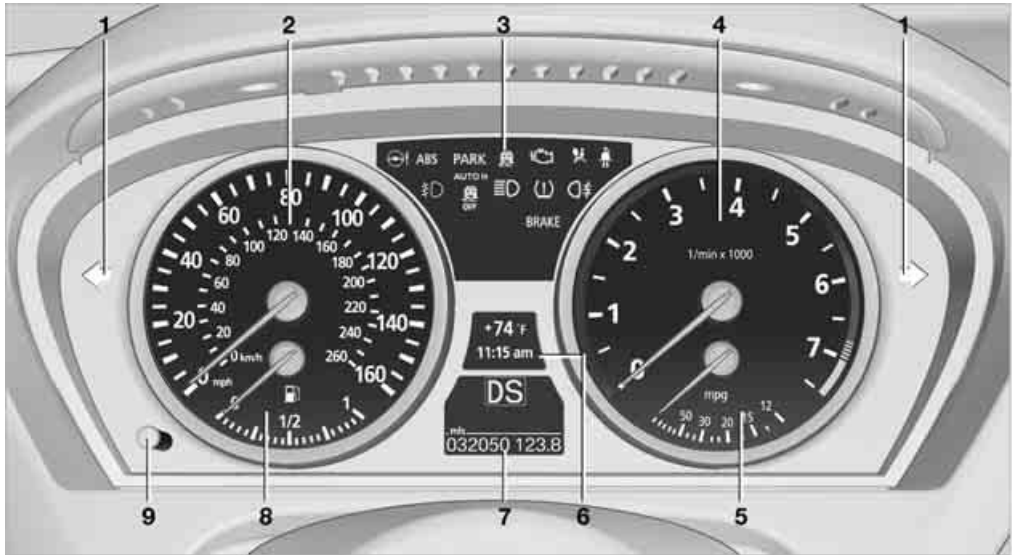

- 1 Indicator lamps for turn signals
- 2 Speedometer
- 3 Indicator and warning lamps [13](#)
- 4 Tachometer [72](#)
- 5 BMW X5: energy control [72](#)
BMW X6: engine oil temperature [72](#) or
energy control [72](#)
- 6 Display for
 - ▷ Clock/date [71](#)
 - ▷ Outside temperature [71](#)
 - ▷ Indicator and warning lamps [77](#)
 - ▷ Speed of cruise control* [69](#)
 - ▷ BMW X5: reserve display for diesel
exhaust fluid [226](#)
- 7 Display for
 - ▷ Odometer and trip odometer [71](#)
 - ▷ Computer [73](#)
 - ▷ Date and remaining travel distance
for service requirements [74](#)
 - ▷ Automatic transmission positions [64](#)
 - ▷ HDC Hill Descent Control [90](#)
 - ▷ High-beam assistant* [104](#)
 - ▷ ▲ There is a Check Control
message [77](#)
 - ▷ Adaptive Drive* [91](#)
- 8 Fuel gauge [73](#)
- 9 Resetting trip odometer [71](#)
Displaying service requirement [71](#)

Indicator and warning lamps

The concept



The indicator and warning lamps can light up in different combinations and colors.

Some lamps are tested for proper function by briefly lighting up during starting of the engine or when the ignition is switched on.

Explanatory text messages

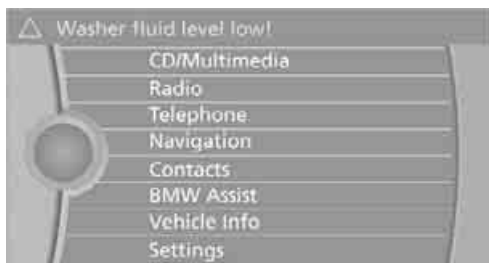

Text messages at the upper edge of the Control Display explain the meaning of the displayed indicator and warning lamps.

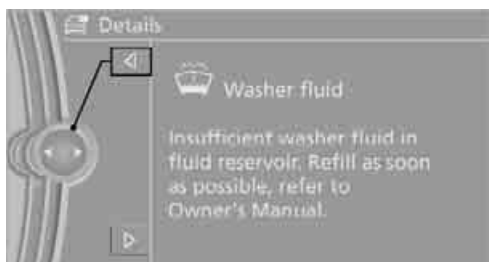







Additional information, e.g. on the cause of a malfunction and on the corresponding need to take action can be displayed via the Check Control, refer to page 77.

In the case of corresponding urgency, this information is displayed immediately when the related lamp lights up.







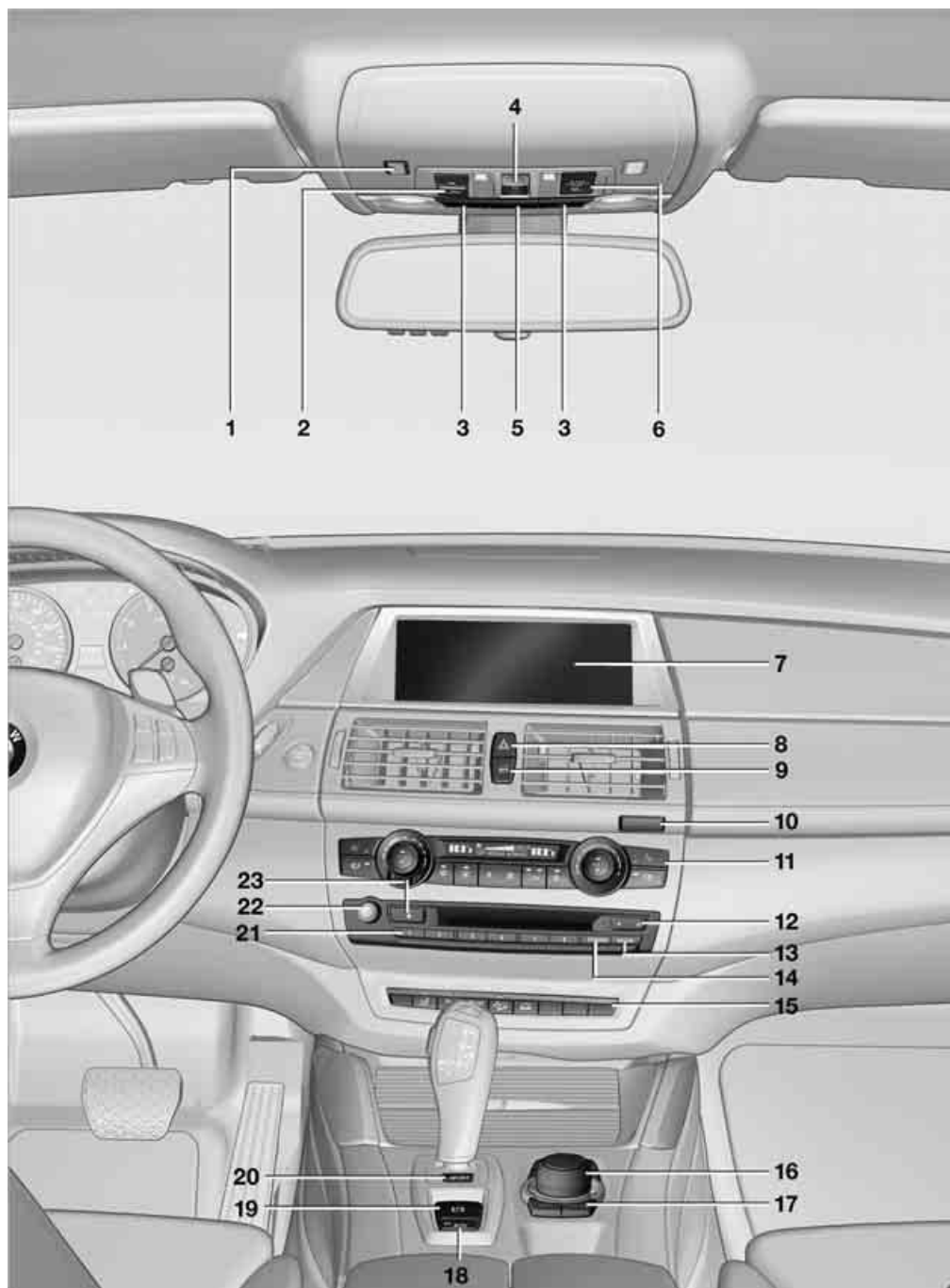

Indicator lamps without text messages





The following indicator lamps indicate that certain functions are activated:

-  With parking brake set [61](#)
-  With parking brake set for Canadian models
-  Fog lamps [105*](#)
-  High beams/headlamp flasher [104](#)
-  Lamp flashes:
DSC or DTC controls the drive and braking forces for maintaining vehicle stability [89](#)
-  Exhaust-gas values [245](#)

Around the center console: controls and displays



- 1 Microphone for hands-free mode for telephone* and for voice activation system* 22
- 2 Initiating an emergency request 261
- 3 Reading lamps 106
- 4 Glass sunroof 38, 40
- 5 Interior lamps 106
- 6 Passenger airbag status lamp 98
- 7 Control Display 16
Displays for menu navigation
- 8 Hazard warning flashers
- 9 Central locking system 27
- 10 Opening glove compartment 118
- 11 Automatic climate control with 2-zone control 108
Automatic climate control with 4-zone control* 112
-  Manual air distribution 110
- AUTO Automatic air distribution and volume 108
-  Cooling function 110
- A  AUC Automatic recirculated-air control 110
- MAX  Maximum cooling 110
-  Air volume 109
Residual heat utilization 110
-  Defrosting windows and removing condensation 109
-  Rear window defroster 109
-  Seat heating* 50
-  Active seat ventilation* 51
- 12 Changing
 - ▷ radio station 160
 - ▷ track 160
- 13 Selecting radio, CD and CD/DVD changer*

- 14 Selecting AM or FM waveband
- 15  Opening liftgate 30, 33
-  Active seat* 52
-  PDC Park Distance Control* 82
Top View* 84
rear view camera* 86
-  DSC Dynamic Stability Control 88
DTC Dynamic Traction Control 89
-  HDC Hill Descent Control 90
- 16 Controller 16
Can be turned, pressed, or moved in four directions
- 17 Buttons on the controller 17
Selecting menus directly
- 18 Automatic Hold 61
- 19 Parking brake 61
- 20 Adaptive Drive* 91
- 21 Programmable memory buttons 20
- 22 Switching Entertainment sound output on/off and adjusting volume 160
- 23 Ejecting audio CD

iDrive combines the functions of a large number of switches. This allows these functions to be operated from a central position. The following section provides an introduction to basic menu

navigation. The control of the individual functions is described in connection with the relevant equipment.

Controls

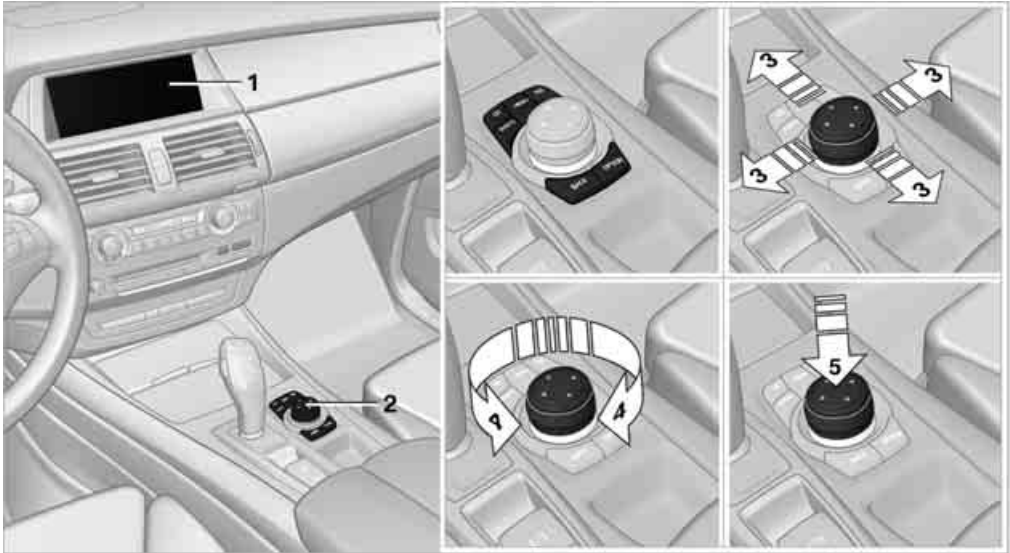

1 Control Display

2 Controller with buttons

You can use the buttons to open the menus directly. The controller can be used to select the menu items and create settings.

- ▷ Move in four directions, arrow **3**
- ▷ Turn, arrow **4**
- ▷ Push, arrow **5**

 To avoid posing an unnecessary hazard due to inattention, both to your own vehicle's occupants and to other road users: never attempt to use the controls or make entries unless traffic and road conditions allow. ◀

Buttons on the controller

| Button | Function |
|--------|-----------------------------|
| MENU | Open the main menu |
| RADIO | Open the Radio menu |
| CD | Open the CD/Multimedia menu |
| NAV | Open the Navigation menu |
| TEL | Open the Telephone menu |
| BACK | Display the previous menu |
| OPTION | Opening the Options menu |

Operating principle

From radio readiness, refer to page 59, the following message is shown on the Control Display:

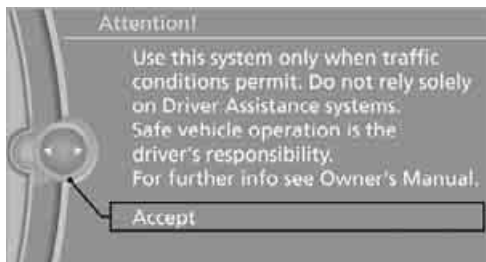

To hide the message:

Press the controller.

The main menu is displayed.

The message is automatically hidden after approx. 10 seconds.

Opening the main menu

Press the **MENU** button.

The main menu is displayed.

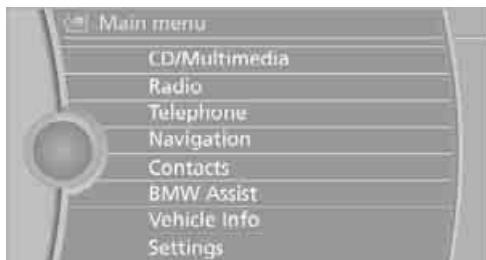

All iDrive functions can be accessed via the main menu.

Selecting a menu item

The menu items shown in white can be selected.

1. Turn the controller until the desired menu item is highlighted.

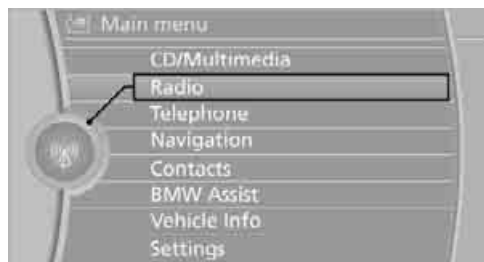

2. Press the controller.

A new menu is displayed or the function is executed.

Menu items in the Owner's Manual

In the Owner's Manual, menu items that can be selected are set in quotation marks, e.g. "Settings".

Changing between panels

After selecting a menu item, e.g. "Radio", a new menu is displayed on a panel. The panels can overlap.

Move the controller to the left or right to change between the panels.

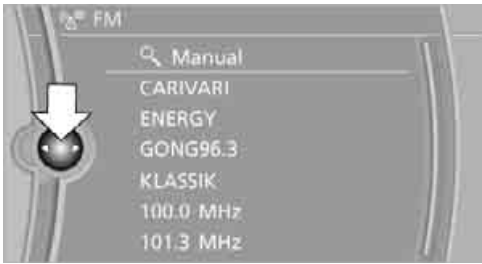

White arrows pointing to the left or right indicate that additional windows can be opened.

Opening the Options menu

Press the **OPTION** button.

The "Options" menu is displayed.

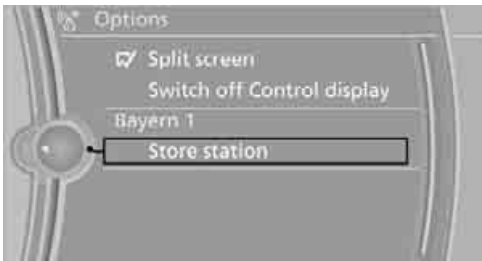

Another possibility: move the controller to the right repeatedly until the "Options" menu appears.

The "Options" menu contains the following:

- ▷ Screen settings, refer to page 19.
- ▷ Control options for the selected menu.

Adjusting settings

1. Select a field.
2. Turn the controller until the desired setting is displayed.

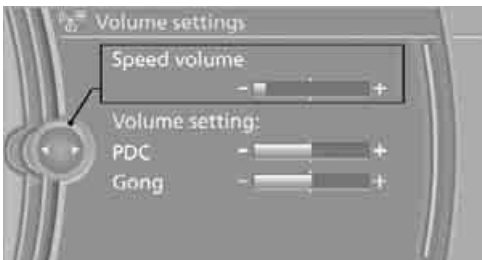

3. Press the controller to confirm the setting.

The scroll bar on the right side indicates whether additional menu items or settings can be selected that are currently not visible. ◀

Example: setting the clock

1. Press the **MENU** button.
The main menu is displayed.
2. Turn the controller until "Settings" is highlighted, and then press the controller.

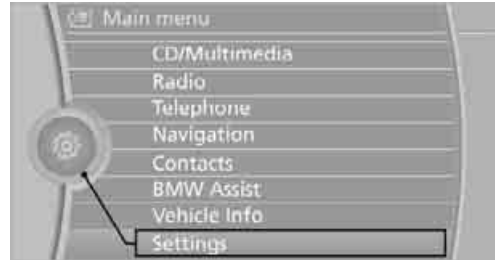

3. Turn the controller until "Time/Date" is highlighted, and then press the controller.



4. Turn the controller until "Time:" is highlighted, and then press the controller.

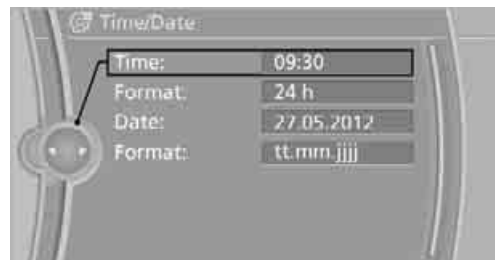

5. Turn the controller to set the hours and press the controller.

- Turn the controller to set the minutes and press the controller.

Status information



- Time
- Display for:
 - ▶ Reception strength of the wireless network, depends on the mobile phone
 - ▶ Incoming, outgoing or missed call
 - ▶ SMS* received
- Display for:
 - ▶ Entertainment: Radio, CD/DVD, external devices, TV*
 - ▶ Telephone*: Name of the mobile phone paired with the vehicle
- Sound output is switched off or display for traffic bulletins*:
 - ▶ "TI": Traffic bulletins are switched on.
 - ▶ No display: Traffic bulletins are switched off.

Other displays:

The status information is temporarily hidden when there are Check Control instructions or during inputs using the voice activation system*.

Switching Control Display off/on

- Press the **OPTION** button.
- "Switch off Control display"

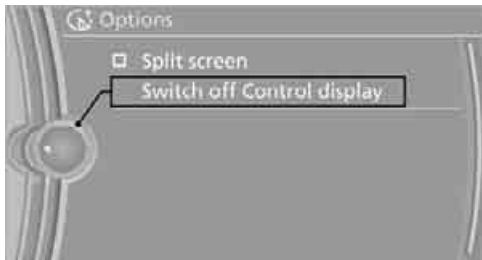

To switch on, press the controller.

Split screen view, Split screen*

Additional information, e.g. from the computer, can be displayed on the right side of the split screen.

On the split screen, this information remains visible even when you change to another menu.

Switching split screen view on and off*

- Press the **OPTION** button.
- "Split screen"

The split screen is activated.

Selecting display for split screen content*

When the split screen is switched on, you can select the content displayed on the screen.

- Move the controller to the right repeatedly until the split screen content is selected.
- Select the display.

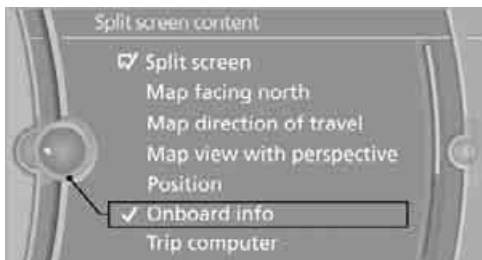

Programmable memory buttons

Certain iDrive functions can be stored on the programmable memory buttons and called up directly, e.g. radio stations, navigation destinations, phone numbers and entry points into the menu.

Storing functions

1. Highlight the function via the iDrive.
2. Press the desired button **1** ... **6** for longer than two seconds.

Sample use of programmable memory buttons

Switch the voice instructions for the navigation on/off.

1. "Navigation"
2. "Map"
3. Select the  symbol using the controller.
4. Press the desired button **1** ... **6** for longer than two seconds.

Running function

Press button **1** ... **6**.

The function is run immediately. This means, for example, that the number is dialed when a phone number is selected.

Displaying button assignment

Touch the button with a finger. Do not wear gloves or use objects.

Displaying short info

Touch button **1** ... **6**.

The button assignment is displayed at the top edge of the screen.





Displaying detailed information

Touch button **1** ... **6** for an extended period.

Letters and numbers



Entering letters and numbers

1. Turn the controller: select the letters or numbers.
2. Select additional letters or numbers if needed.
3. "OK": confirm entry.

| Symbol | Function |
|---|--|
|  | Press the controller: delete one letter or number |
|  | Press the controller for an extended period: delete all letters or numbers |
|  | Enter a blank space |

Switching between letters and numbers

Depending on the menu, you can switch between entering letters and numbers:

| Symbol | Function |
|---|------------------|
|  | Entering letters |
|  | Entering numbers |

Wordmatch concept during navigation

Entry of names and addresses: the selection is narrowed down every time a letter is entered and letters may be added automatically.

Destination search: the entries are continuously compared to the data stored in the vehicle.

- ▷ The only letters offered for entering addresses are those for which data are available.
- ▷ Town/city names can be entered with the spelling used in any of the languages available on the Control Display.

Voice activation system*

The concept

The voice activation system allows you to control operation of various vehicle systems without ever removing your hands from the steering wheel.

Individual menu items on the Control Display can be spoken as commands. This frees you of having to use the controller.



The voice activation system transforms your oral commands into control signals for the selected systems and provides support in the form of instructions or questions.

The voice activation system uses a special microphone located in the area of the interior rearview mirror, refer to page 14.

Precondition



Using iDrive, set the language that applies for the voice activation system in order to enable identification of the spoken commands. To set the language of iDrive, refer to page 81.

Symbols in Owner's Manual

-  ›...‹ Say the specified commands word for word.
-  ››...‹‹ Indicates responses of the voice activation system.

Voice commands

Activating voice command system

- Press the  button on the steering wheel.
 -  This symbol on the Control Display and an acoustic signal tell you that the voice activation system can respond to commands.

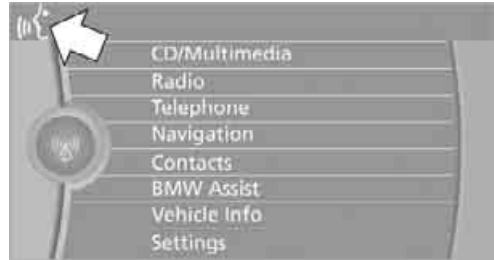

- Say the command.
 - The command is displayed on the Control Display.

 This symbol appears on the Control Display when you can enter additional commands. If no other commands are possible, then operate the equipment via iDrive.

Terminating or canceling voice command system

Press the  button on the steering wheel or

 ›Cancel‹

In dialogs that call for a text of your choice, the procedure can only be canceled using the button on the steering wheel.

Possible commands

The commands available in each case depend on the menu item selected on the Control Display.

To have the available commands read aloud:

 ›Voice commands‹

For example, if "CD/DVD" is selected, the commands for operating CD/Multimedia are read aloud.

Running functions directly with short commands

With short commands you can carry out certain functions directly, regardless of which menu item is selected, refer to page 273.

Example: selecting the track of a CD

1. Switch on Entertainment sound output if necessary.
2. Press the  button on the steering wheel.
3. Select the music track, e.g.:
 - ›C D track 4‹
 - System says:
 - ››Track 4‹‹

Setting the voice dialog

You can set whether the system should use the standard dialog or a shorter variant. In the shorter variant of the voice dialog, the prompts and responses from the system are abbreviated.

1. "Settings"
2. "Language/Units"
3. "Speech mode:"

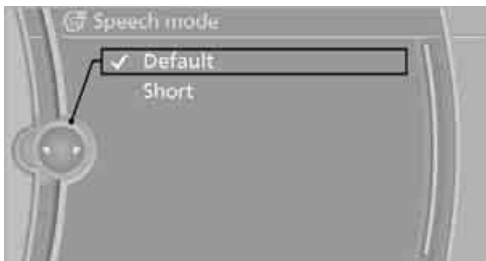

4. Select a setting:
 - ▷ "Default"
 - ▷ "Short"

Notes

 To operate the phone by voice, refer to page 209. ◀

For voice commands, bear in mind the following:

- ▷ Do not use the voice activation system to initiate an Emergency Request. In stressful situations, the voice and vocal pitch can change. This can unnecessarily delay the establishment of a telephone connection.

- ▷ Say the commands and numbers smoothly and at normal volume, avoiding excessive emphases and pauses. This also applies when spelling out and saying a full word during destination entry.
- ▷ When selecting a radio station, use the common pronunciation of the station name.
- ▷ For entries in the voice-activated phone book, only use names in the language of the voice activation system and no abbreviations.
- ▷ Keep doors, windows, and glass sunroof*/panorama glass sunroof* closed in order to avoid unpleasant outside noise.
- ▷ Avoid making other noise in the vehicle while speaking.



A close-up, blue-tinted photograph of a car's interior controls. The image shows a circular dial on the left, a vertical slider or button in the center, and a rectangular control panel on the right. The background is blurred, focusing attention on the foreground controls.

Controls

This chapter is intended to provide you with information for complete control of your vehicle. Its extensive array of features and accessories, both for driving and for your own safety, comfort and convenience, are described here.

Opening and closing

Keys/remote control



Each remote control contains a battery which is automatically charged in the ignition lock while driving. Drive a longer distance with each remote control at least twice a year to keep the battery charged. For comfort access*, the remote control contains a replaceable battery, refer to page 37.

Depending on which remote control is detected by the vehicle during unlocking, different settings are called up and carried out in the vehicle, refer to Personal Profile, page 26.

Information on the required maintenance is also stored in the remote control, refer to Service data in remote control, page 244.

Integrated key



Press button 1 to unlock the key.

The integrated key fits the following locks:

- ▷ Driver's door, refer to page 29
- ▷ Floor panel flap in cargo bay, refer to page 124

New remote controls

To obtain additional or replace lost keys, new remote controls with an integrated key are available at your BMW Sports Activity Vehicle Center.

Personal Profile

The concept

You can set a number of functions of your BMW individually according to your preferences. Personal Profile ensures that most of these settings are stored for the remote control currently in use without you having to do anything. When the vehicle is unlocked, the corresponding remote control is detected and the settings stored for it are called up and carried out.

This means that you will always find your BMW set to your own personal settings even if another person with his/her own remote control and settings has used the vehicle since the last time you drove it. The individual settings are stored for a maximum of four remote controls, for two with comfort access*.

Personal Profile settings

Details on the settings are provided on the specified pages.

- ▷ Behavior of the central locking system when unlocking vehicle, refer to page 28
- ▷ Automatic locking of the vehicle, refer to page 30
- ▷ Displays on Control Display:
 - ▷ Brightness of the Control Display, refer to page 80
 - ▷ Measuring units for consumption, route/distances, temperature, and pressure, refer to page 80
 - ▷ Language on Control Display, refer to page 81

- ▷ 12h/24h clock format, refer to page 80
- ▷ Date format, refer to page 80
- ▷ Lighting settings:
 - ▷ Triple turn signal activation, refer to page 67
 - ▷ Welcome lamps, refer to page 102
 - ▷ Pathway lighting, refer to page 103
 - ▷ Daytime driving lamps*, refer to page 103
 - ▷ High-beam assistant*, refer to page 104
- ▷ PDC Park Distance Control*: optical warning, refer to page 83
- ▷ Top View*: optical warning, refer to page 85
- ▷ Rear view camera*:
 - ▷ Selecting functions, refer to page 86
 - ▷ Type of display, refer to page 87
- ▷ Head-Up Display*: selection, brightness and position of display, refer to page 100
- ▷ Automatic climate control: AUTO program and intensity, cooling function, and automatic recirculated-air control/recirculated-air mode, temperature, air distribution, ventilation temperature, starting on page 108
- ▷ Programmable memory buttons: selecting stored functions, refer to page 20
- ▷ Positions of driver's seat, outside mirrors, and steering wheel*, refer to page 45
- ▷ Adaptive Drive*: selected chassis and suspension tuning, refer to page 91
- ▷ Audio sources: volume and tone settings, refer to page 160
- ▷ Radio:
 - ▷ Display of stored stations, refer to page 165
 - ▷ Switching RDS Radio Data System on/off*, refer to page 164
- ▷ Phone: volume setting, refer to pages 205, 210

Central locking system

The concept

The central locking system functions when the driver's door is closed.

The system simultaneously engages and releases the locks on the following:

- ▷ Doors
- ▷ liftgate
- ▷ Fuel filler door

Operating from outside

- ▷ using the remote control
- ▷ using the door lock
- ▷ with comfort access* using the door handles

The interior lamps and the courtesy lamps* are also switched on and off with the remote control. The alarm system is armed/disarmed at the same time.

You can find more detailed information on the alarm system on page 34.

Operating from inside

Using the button for central locking, refer to page 30. The fuel filler door is not locked.

In an accident of sufficient severity, the central locking system automatically unlocks the vehicle. In addition, the hazard warning flashers and interior lamps come on.

Opening and closing: Using remote control



Persons or animals in a parked vehicle could lock the doors from the inside. Always take along the remote control when leaving the vehicle so that the vehicle can then be opened from the outside. ◀

Unlocking

Press the button. This unlocks the vehicle.

Setting unlocking behavior

You can set whether the first press of the button unlocks only the driver's door or the entire vehicle.

1. "Settings"
2. "Door locks"
3. "Unlock button"

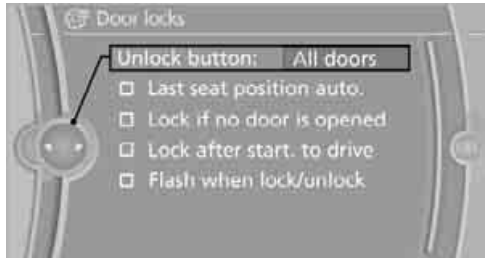

4. Select a menu item:
 - ▷ "All doors"
Press the button once to unlock the entire vehicle.
 - ▷ "Driver's door only"
Press the button once to unlock only the driver's door and the fuel filler door. Press the button twice to unlock the entire vehicle.

5. Press the controller.

The setting is stored for the remote control currently in use.

Comfort opening

Press and hold the button. The windows and the glass sunroof*/panorama glass sunroof* are opened.

Locking

Press the LOCK button.

Do not lock the vehicle from the outside if persons are inside because unlocking from the inside is not possible without special knowledge. ◀

Switching on interior lamps

With vehicle locked:

Press the LOCK button.

You can also use this function to locate your vehicle in parking garages etc.

Panic mode*

You can also trigger the alarm system in case of danger:

Press the button for at least 3 seconds.

Switch off alarm: press any button.

Unlocking liftgate

Press the button for approx. 1 second.

The liftgate will open slightly, regardless of whether it was previously locked or unlocked.

During opening, the liftgate pivots back and up. Ensure that adequate clearance is available before opening.

To prevent accidentally locking yourself out, never lay the remote control in the cargo bay. A previously locked liftgate is also locked again after closing. ◀

If pointed or sharp-edged objects could strike the rear window while driving, be sure to provide protection around all edges. Failure to do so could result in damage to the heating conductors of the rear window. ◀

Confirmation signals

You can activate or deactivate the confirmation signals.

1. "Settings"
2. "Door locks"
3. "Flash when lock/unlock"



4. Press the controller.

Flashing when locking/unlocking the vehicle is switched on.

Malfunctions

The remote control may malfunction due to local radio waves. Should the remote control fail to operate due to interference of this kind, unlock and lock the vehicle using the door lock using a key.

If it is no longer possible to lock the vehicle using the remote control, then the battery is discharged. Use this remote control during an extended drive; this will recharge the battery, refer to page 26.

For US owners only

The transmitter and receiver units comply with part 15 of the FCC/Federal Communication Commission regulations. Operation is governed by the following:

FCC ID:
LX8766S
LX8766E
LX8CAS
LX8CAS2

Compliance statement:

This device complies with part 15 of the FCC Rules. Operation is subject to the following two conditions:

- ▷ This device must not cause harmful interference, and
- ▷ this device must accept any interference received, including interference that may cause undesired operation.

 Any unauthorized modifications or changes to these devices could void the user's authority to operate this equipment. ◀

Opening and closing: Using door lock



Do not lock the vehicle from the outside if persons are inside because unlocking from the inside is not possible without special knowledge. ◀

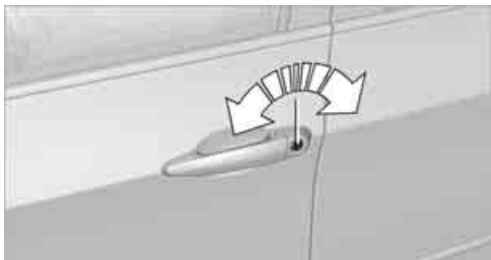

When unlocking

1. Turning the key once unlocks the driver's door and the fuel filler door.
2. Turning the key a second time unlocks the remaining doors and the liftgate.

Convenience operation

You can use the door lock to operate the windows and the glass sunroof*/panorama glass sunroof*.

Turn and hold the key in the positions for unlocking or locking.



Watch during the closing process to be sure that no one is injured. Rotating the key back into the initial position stops the movement. ◀

Manual operation

In the event of an electrical malfunction, you can turn a key all the way to the right or left in the door lock to lock or unlock the driver's door.

Opening and closing: From inside



This button serves to unlock or lock doors and the liftgate, with the front doors closed. It does not activate the anti-theft system. The fuel filler door remains unlocked.

Automatic locking

You can also set the situations in which the vehicle is locked.

1. "Settings"
2. "Door locks"
3. Select the desired function:
 - ▷ "Lock if no door is opened"
The central locking system locks the vehicle after a short time, unless a door has been opened.
 - ▷ "Lock after start. to drive"
The central locking system locks the vehicle when you drive away.



The function is switched on and is stored for the remote control currently in use.

Unlocking and opening

- ▷ Either unlock the doors together with the button for the central locking system and then pull the door handle above the armrest or
- ▷ pull on the door handle of each door twice: the first time unlocks the door, the second time opens it.

Locking

- ▷ Use the central locking button to lock all of the doors simultaneously, or
- ▷ press down the lock button of a door. To prevent you from being locked out, the open driver's door cannot be locked using the lock button.

 Persons or animals left unattended in a parked vehicle can lock the doors from the inside. Always take along the remote control when leaving the vehicle so that the vehicle can then be opened from the outside. ◀

Doors

Automatic soft closing*

To close the doors, merely push them gently. The closing process will then be carried out automatically.

 Make sure that the closing path of the doors is clear; otherwise injuries may result. ◀

BMW X5: liftgate

- ▷ During opening, the liftgate pivots back and up. Ensure that adequate clearance is available before opening. ◀

Opening from inside

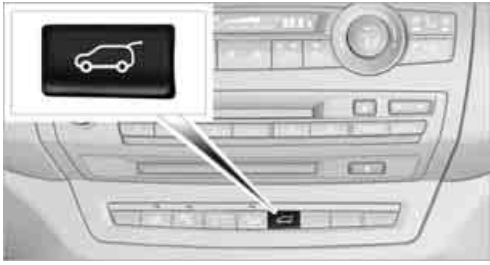

Press the button: the liftgate opens somewhat unless it has been locked.

Opening from outside



Press the button on the liftgate or the  button on the remote control for approx. 1 second: The liftgate opens somewhat. It can be swung upward.

Opening manually

In case of an electrical malfunction:

1. From the cargo bay, press out the handle in the liftgate, refer to arrow, with a screwdriver and pull. The liftgate is unlocked.

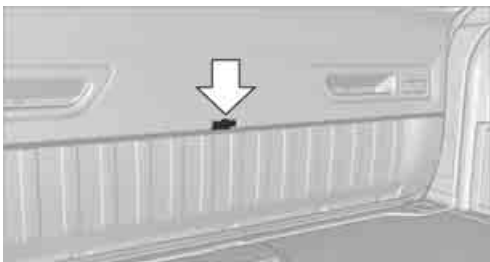

2. Open the liftgate and press in the handle. The liftgate is locked again as soon as it is closed.

Closing

 Make sure that the closing path of the liftgate is clear, otherwise injuries may result. ◀



The handle recesses on the interior trim of the liftgate make it easier to pull down.

 If pointed or sharp-edged objects could strike the rear window while driving, be sure to provide protection around all edges. Failure to do so could result in damage to the heating conductors of the rear window. ◀

Automatic liftgate operation*

Adjusting opening height

You can adjust how far the liftgate is to open.

 When adjusting the opening height, make sure that at least approx. 4 in/10 cm of clearance is available above the liftgate. Otherwise, the ceiling height could be insufficient for the opened liftgate if, for example, the loading state changes. ◀

1. "Settings"
2. "Tailgate"



3. Turn the controller until the desired opening height is selected.

Opening liftgate

The liftgate opens automatically when you:

- ▶ Press the button on the outside of the liftgate when the vehicle is unlocked.





- ▶ Press the button in the center console.



- ▶ Press the  button on the remote control for approx. 1 second.

To stop the opening process:

- ▶ Press the button on the outside of the liftgate.
- ▶ Press and hold the  button on the remote control.
- ▶ Press the button on the inside of the liftgate.
- ▶ Press the button in the center console again.

- ▶  The opening process is interrupted if you set the vehicle in motion. ◀

Closing liftgate

- ▶  Make sure that the closing path of the liftgate is clear, otherwise injuries may result. ◀

Function requirement:
The tailgate is closed.



The liftgate closes automatically when you press the button on the inside of the liftgate.

To stop the closing process:

- ▶ Press the button on the inside of the liftgate.
- ▶ Press the button on the outside of the liftgate.

- ▶  Closing is not canceled when you put the vehicle into motion. ◀

Manually opening or closing

In case of an electrical defect of the automatic liftgate operation function:

1. Manually release the liftgate, refer to page 31.
2. Open or close the liftgate slowly and without making sudden movements.

BMW X5: tailgate

Opening

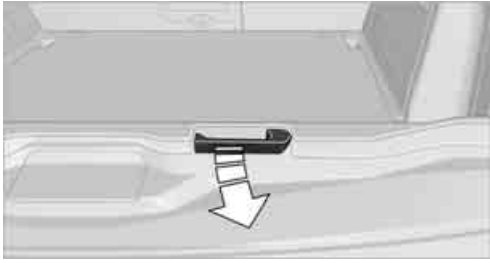

Pull the lever and swing the tailgate downward.

 The open tailgate can support loads of up to 550 lbs./250 kg. ◀

Closing

Fold the tailgate up and press closed.

BMW X6: liftgate

 During opening, the liftgate pivots back and up. Ensure that adequate clearance is available before opening. ◀

Adjusting opening height

You can adjust how far the liftgate is to open.

 When adjusting the opening height, make sure that at least approx. 4 in/10 cm of clearance is available above the liftgate. Otherwise, the ceiling height could be insufficient for the opened liftgate if, for example, the loading state changes. ◀

1. "Settings"
2. "Tailgate"



3. Turn the controller until the desired opening height is selected.

Opening liftgate

The liftgate opens automatically when you:

- ▷ Press the button on the outside of the liftgate when the vehicle is unlocked.





- ▷ Press the button in the center console.



- ▷ Press the  button on the remote control for approx. 1 second.

To stop the opening process:

- ▷ Press the button on the outside of the liftgate.
- ▷ Press and hold the  button on the remote control.
- ▷ Press the button on the inside of the liftgate.
- ▷ Press the button in the center console again.

 The opening process is interrupted if you set the vehicle in motion. ◀

Closing liftgate

! Make sure that the closing path of the liftgate is clear, otherwise injuries may result. ◀



The liftgate closes automatically when you press the button on the inside of the liftgate.

To stop the closing process:

- ▷ Press the button on the inside of the liftgate.
- ▷ Press the button on the outside of the liftgate.

▷ Closing is not canceled when you put the vehicle into motion. ◀

! The liftgate also closes automatically without pressing the button if it is loaded with an additional weight of approx. 11 lbs./5 kg, e.g. snow or ice. ◀

Manually opening or closing

In case of an electrical malfunction:

1. Push out cover **1** on the liftgate with a screwdriver.

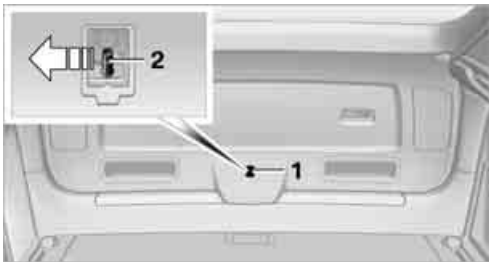

2. Push the catch **2** in the direction of the arrow.
3. Open or close the liftgate slowly and without making sudden movements.

Alarm system

The concept

The vehicle alarm system responds:

- ▷ When a door, the hood, or the liftgate is opened
- ▷ To movements in the vehicle: interior motion sensor, refer to page [35](#)
- ▷ To changes in the vehicle's tilt if someone attempts to steal the wheels or tow the vehicle
- ▷ To interruptions in battery voltage

Unauthorized operations are briefly signaled by the alarm system:

- ▷ with an acoustic alarm
- ▷ by switching on the hazard warning flashers
- ▷ by flashing the high beams

Arming and disarming alarm system

When you lock or unlock the vehicle, either with the remote control or at the door lock, the alarm system is armed or disarmed at the same time.

With the system armed, the liftgate can also be opened using the  button of the remote control, refer to page [28](#). When the liftgate is closed, it is once again locked and monitored.

Switching off alarm

- ▷ Unlock the vehicle using the remote control, refer to page [27](#).
- ▷ Insert the remote control all the way into the ignition lock.

Indicator lamp displays



- ▷ The indicator lamp under the interior rearview mirror flashes continuously: the system is armed.
- ▷ The indicator lamp flashes after locking: the doors, hood, or liftgate are not properly closed. Even if you do not close the alerted area, the system begins to monitor the remaining areas, and the indicator lamp flashes continuously after approx. 10 seconds. However, the interior motion sensor is not activated.
- ▷ The indicator lamp goes out after unlocking: your vehicle has not been disturbed while you were away.
- ▷ The indicator lamp flashes after unlocking until the remote control is inserted into the ignition lock, however for a maximum of approx. 5 minutes: your vehicle has been disturbed while you were away.

Tilt alarm sensor

The tilt of the vehicle is monitored. The alarm system reacts, e.g. in case of an attempted wheel theft or towing.

Interior motion sensor

In order for the interior motion sensor to function properly, the windows and glass sunroof*/panorama glass sunroof* must be completely closed.

Avoiding unintentional alarms

The tilt alarm sensor and interior motion sensor may be switched off at the same time. This prevents unintentional alarms, e.g. in the following situations:

- ▷ In stacking garages
- ▷ When transporting on car-carrying trains, by sea or on a trailer
- ▷ When animals are to remain in the vehicle

Switching off tilt alarm sensor and interior motion sensor

Press the  LOCK button on the remote control again as soon as the vehicle is locked.

The indicator lamp lights up briefly and then flashes continuously. The tilt alarm sensor and the interior motion sensor are switched off until the next time the vehicle is unlocked and subsequently locked again.

Comfort access*

Comfort access enables you to access your vehicle without having to hold the remote control in your hand. It is sufficient to carry the remote control with you, e.g. in your jacket pocket. The vehicle automatically detects the related remote control in the immediate vicinity or in the interior.

Comfort access supports the following functions:

- ▷ Unlocking/locking vehicle
- ▷ Comfort closing
- ▷ Opening liftgate
- ▷ Starting engine

Functional requirements

- ▷ The vehicle can only be unlocked if the vehicle detects that the remote control carried is not located in the vehicle interior.
- ▷ The next unlocking and locking cycle is not possible until after approx. 2 seconds.

- ▷ The engine can only be started if the vehicle detects that the remote control is located in the vehicle.

Comparison with ordinary remote control

You can control the functions mentioned previously with the comfort access or by pressing the buttons on the remote control. Therefore, please familiarize yourself with the information on opening and closing beginning on page 26 beforehand.

The special features when using comfort access are described in the following.

- ▷ Should a short delay occur when opening or closing the windows or the glass sunroof*/panorama glass sunroof*, the system checks whether a remote control is located in the vehicle. Please repeat opening or closing if necessary. ◀

Releasing

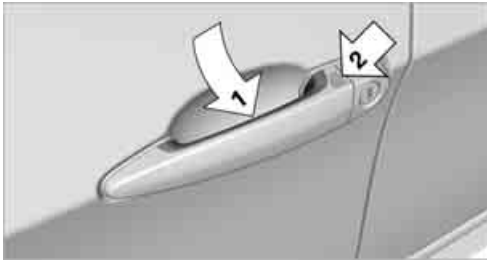

Completely grasp a door handle, arrow 1. This corresponds to pressing the button.

Locking

Touch the area highlighted in the picture, arrow 2, with your finger for approx. 1 second.

This corresponds to pressing the LOCK button.

- ▷ Please make sure that all electronic systems/consumers are switched off before locking to save the battery. ◀

Comfort closing

Hold a finger or the back of a hand on the surface, arrow 2.

The windows and the glass sunroof*/panorama glass sunroof* are closed.

- ⚠ Watch during the closing process to be sure that no one is injured. Removing the hand from the door handle immediately stops the closing process. ◀

Opening liftgate

Press the button on the liftgate.

This corresponds to pressing the button.

- ▷ If a remote control accidentally left in the cargo bay is detected in the locked vehicle after the liftgate is closed, then the liftgate opens again. The hazard warning flashers flash and a signal* sounds. ◀

Switching on radio readiness

By briefly pressing the Start/Stop button, you switch on the radio readiness, refer to page 59.

- ▷ When doing so, do not depress the brake pedal, otherwise the engine will start. ◀

Starting engine

You can start the engine or switch on the ignition if a remote control is located in the interior of the vehicle. It need not be inserted in the ignition lock, refer to page 59.

As long as no remote control is detected in the vehicle, it is only possible to restart the engine within approx. 10 seconds after it is switched off if no door has been opened.

Switching off engine

- ▷ Remote control not in ignition lock: After switching off the engine, the transmission is automatically switched into transmission position P.
- ▷ Remote control in ignition lock: If transmission position N is engaged, the transmission remains in this position after the engine is switched off.

Before driving into a car wash

The vehicle can roll if you proceed according to the following steps:

1. Insert remote control into ignition lock.
2. Depress brake pedal.
3. Engage transmission position N.
4. Release the parking brake.
5. Switch off the engine.
6. Leave the remote control in the ignition lock.

Malfunction

The comfort access function may malfunction due to local radio waves. Then open or close the vehicle with the buttons on the remote control or with a key. To start the engine following this, insert the remote control in the ignition lock.



The warning lamp in the instrument panel lights up when an attempt is made to start the engine: starting the engine is not possible. The remote control is not in the vehicle or has a malfunction. Take along the remote control into the vehicle or have it checked. Insert another remote control into the ignition lock if necessary.



The warning lamp in the instrument panel lights up when the engine is running: the remote control is no longer in the vehicle. After switching off the engine, the engine can only be started again within approx. 10 seconds if no door has been opened.



The indicator lamp in the instrument panel lights up and a message appears on the Control Display: replace the battery of the remote control.

Replacing battery

The remote control for comfort access contains a battery which must be replaced if necessary.

1. Remove integrated key from remote control, refer to page 26.
2. Remove cover.



3. Lay in new battery with positive side facing upward.
4. Press cover closed.



Dispose of used batteries at a collection point or at your BMW Sports Activity Vehicle Center. ◀

Windows



To prevent injuries, exercise care when closing the windows and keep them in your field of vision until they are shut. Always take along the remote control when you leave the vehicle, otherwise children could, for example, operate the windows and injure themselves. ◀

Opening, closing

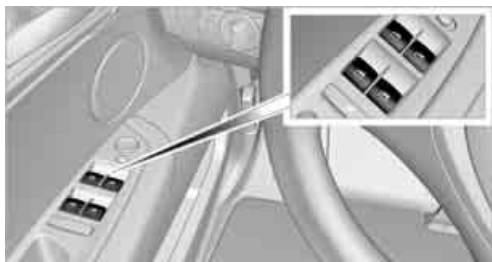

- ▷ Press switch to resistance point: The window continues to open as long as you keep the switch pressed.
- ▷ Press switch beyond resistance point: The window opens automatically. Pressing the switch again stops the opening movement.

You can close the windows in the same manner by pulling the switch.

Separate switches for the rear windows are located in the rear.

For information on using convenience operation at the door lock or with the remote control, refer to page 28 or 29.

For information on comfort closing with comfort access, refer to page 36.

After switching off ignition

You can still operate the windows with the remote control removed or the ignition switched off for approx. 1 minute, as long as neither of the front doors has been opened.

Pinch protection system

If the closing force rises beyond a predefined threshold during closing, the system will stop moving the window prior to lowering it again slightly.

 Despite the pinch protection system, inspect the window's travel path prior to closing it, as the safety system might fail to detect certain kinds of obstructions, such as thin objects, and the window would continue closing.

Do not install any accessories in the range of movement of the windows, otherwise the pinch protection system will be impaired. ◀

Closing without pinch protection system

In case of danger from outside or if, for example, ice on the window prevents normal closing, proceed as follows:

1. Pull the switch beyond the resistance point and hold. The pinch protection system is limited and the window opens slightly if the closing force exceeds a certain value.
2. Pull the switch beyond the resistance point and hold again within approx. 4 seconds. The window closes without the pinch protection system.

Safety switch

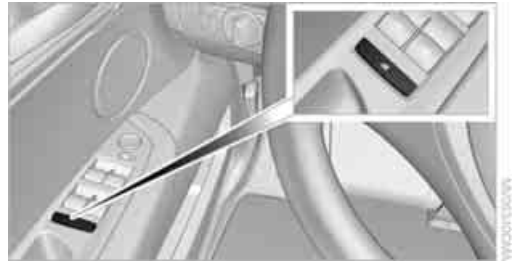

With the safety switch, you can prevent the rear windows from being opened or closed via the switches in the rear passenger area, by children, for example. The LED lights up when this safety feature is activated.

 Always press the safety switch when children ride in the rear, otherwise uncontrolled closing of the windows could lead to injuries. ◀

BMW X5: panorama glass sunroof*

The panorama glass sunroof is ready for operation with the ignition switched on, refer to page 59.

 To prevent injuries, exercise care when closing the panorama glass sunroof and keep it in your field of vision until it is closed. Always take along the remote control when you leave the vehicle, otherwise children could, for example, operate the roof and injure themselves. ◀

Raising, opening, closing



Raising

Press the switch.
The closed sunroof is raised and the sliding visor opens slightly.

⚠ Do not use force to close the sliding visor with the glass sunroof in its raised position, otherwise the mechanism will be damaged. ◀

Opening, closing

Sliding visor

You can move the sliding visor independently with the sunroof closed or raised.

- ▶ Slide the switch back to the resistance point.
The sliding visor opens as long as you keep the switch in this position.
- ▶ Briefly press the switch back beyond the resistance point.
The sliding visor will open automatically. Briefly pressing the switch stops the motion.

You can close the sliding visor in a similar manner by sliding the switch forwards.

Panorama glass sunroof

With the sliding visor open, proceed as described under Sliding visor.

For information on using convenience operation at the door lock or with the remote control, refer to page 28 or 29.

For information on comfort closing with comfort access, refer to page 36.

Opening and closing sunroof and sliding visor together

Briefly press the switch beyond the resistance point twice consecutively.
Briefly pressing the switch stops the motion.

Comfort mode

- ▶ Press the switch twice with the sunroof open:
The sunroof is raised.
- ▶ When the sunroof is raised, briefly press the switch twice in the opening direction:
The sunroof is opened all the way.

Comfort position

In the comfort position, the sunroof is not completely open; this reduces wind noise in the passenger compartment.

Each time the panorama glass sunroof is completely opened or closed, it stops in the comfort position. If desired, continue the motion following this with the switch.

After switching off ignition

You can still operate the roof for approx. 1 minute, as long as no door has been opened.

Pinch protection system

If the panorama glass sunroof or sliding visor encounter resistance when closing from roughly one third of the sunroof opening or when closing from the raised position, the closing action is interrupted and the panorama glass sunroof and sliding visor reopen a little.

⚠ Despite the pinch protection system, inspect the sunroof's travel path prior to closing it, as the safety system might fail to detect certain kinds of obstructions, such as very thin objects, and the sunroof would continue closing. ◀

Closing without pinch protection system

In case of danger from outside, slide the switch forward beyond the resistance point and hold.

The roof closes without the pinch protection system.

Following interruptions in electrical power supply

After a power loss, the sunroof may only respond to the raise command. Then have the system initialized. BMW recommends having this work carried out by your BMW Sports Activity Vehicle Center.

Moving manually*

In the event of an electrical malfunction, you can move the sunroof manually:

1. Remove trim piece. To do so, gently lift the corner of the trim piece with a screwdriver.



2. Using the screwdriver, press in the clamps one after the other, arrows 1, tilt the cover panel down, arrow 2, and remove.

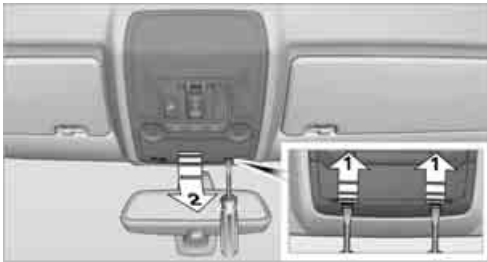

3. Release and disconnect the motor plug. This significantly reduces the effort required for the manual movement.

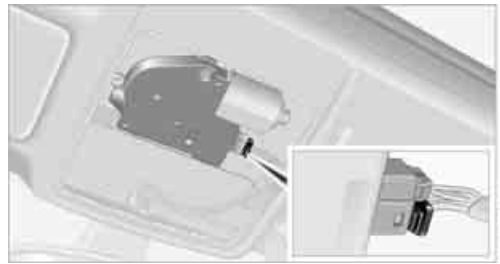

4. Insert the Allen wrench* from the onboard tool kit, refer to page 250, into the opening provided. Move the panorama glass sunroof in the desired direction.



5. Reconnect the plug.
6. Clip the trim piece into the cover panel, arrow 1. Then fold the cover panel forward until it audibly clicks into place, arrow 2.

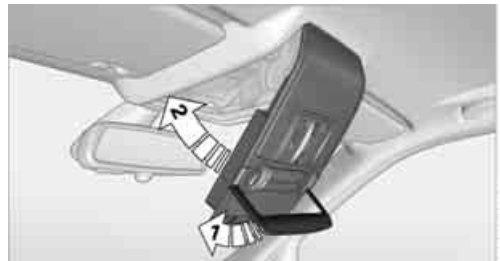

BMW X6: glass sunroof*, electric

The glass sunroof is ready for operation when the ignition is switched on, refer to page 59.

 To prevent injuries, exercise care when closing the glass sunroof and keep it in your field of vision until it is closed. Always take along the remote control when you

leave the vehicle, otherwise children could, for example, operate the roof and injure themselves. ◀



Raising

Press the switch.

The closed glass sunroof is raised and the sliding visor opens slightly.

 Do not use force to close the sliding visor with the glass sunroof in its raised position, otherwise the mechanism will be damaged. ◀

Opening, closing

- ▷ Slide the switch back to the resistance point.
The glass sunroof and the sliding visor open together as long as you continue to hold the switch in this position.
- ▷ Briefly press the switch back beyond the resistance point.
The glass sunroof and the sliding visor open automatically. Briefly pressing the switch stops the motion.

You can close the glass sunroof in a similar manner by sliding the switch forward. The sliding visor remains open and can be closed by hand.

For information on using convenience operation with the remote control or at the door lock, refer to page 28 or 29.

For information on convenience closing with comfort access, refer to page 36.

Automatic opening and closing

Briefly press the switch beyond the resistance point.

The following movements are also automatic:

- ▷ With the sunroof open, press the switch:
The sunroof is opened all the way.
- ▷ With the sunroof raised, briefly press the switch in the opening direction: the sunroof is opened all the way.

Briefly pressing the switch stops the motion.

Comfort position

In the comfort position, the sunroof is not completely open; this reduces wind noise in the passenger compartment.

Each time the glass sunroof is opened or closed all the way, it stops in the comfort position. If you wish, you can continue the motion by actuating the switch.

After switching off ignition

You can still operate the roof for approx. 1 minute, as long as no door has been opened.

Pinch protection system

If the glass sunroof meets with resistance from about the middle of the roof opening when closing or when lowering from the raised position, the closing process is interrupted and the glass sunroof opens all the way.

 Despite the pinch protection system, inspect the sunroof's travel path prior to closing it, as the safety system might fail to detect certain kinds of obstructions, such as very thin objects, and the sunroof would continue closing. ◀

Closing without pinch protection system

When there is danger outside the vehicle, proceed as follows:

1. Slide the switch forward past the resistance point and hold it there. The pinch protection system is limited and the sunroof opens slightly if the closing force exceeds a certain value.

2. Within about 4 seconds, slide the switch forward again beyond the resistance point and hold it there. The roof closes without the pinch protection system.

Following interruptions in electrical power supply

After a power loss, the sunroof may only respond to the raise command. Then have the system initialized. BMW recommends having this work carried out by your BMW Sports Activity Vehicle Center.

Moving manually*

In the event of an electrical malfunction, you can move the sunroof manually:

1. Remove trim piece. To do so, gently lift the corner of the trim piece with a screwdriver.



2. Using the screwdriver, press in the clamps one after the other, arrows 1, tilt the cover panel down, arrow 2, and remove.

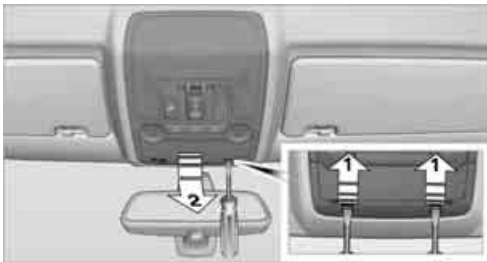

3. Release and disconnect the motor plug. This significantly reduces the effort required for the manual movement.



4. Take the Allen wrench* from its bracket in the onboard tool kit, refer to page 250, and insert it into the opening provided. Move the glass sunroof in the desired direction.



5. Reconnect the plug.
6. Clip the trim piece into the cover panel, arrow 1. Then fold the cover panel forward until it audibly clicks into place, arrow 2.

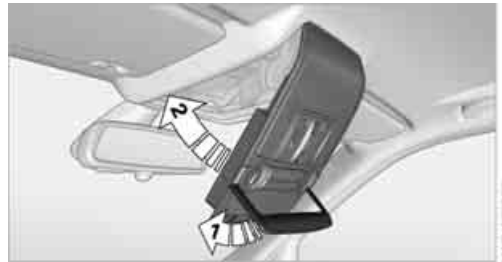

Adjusting

Sitting safely

The ideal sitting position can make a vital contribution to relaxed, fatigue-free driving. In the interaction with the safety belts, the head restraints and the airbags, the seat position plays an important role in an accident. To ensure that the safety systems operate with optimal efficiency, we strongly urge you to observe the instructions contained in the following section.

For additional information on transporting children safely, refer to page 55.

Airbags

 Always maintain an adequate distance between yourself and the airbags. Always hold the steering wheel by its rim with hands at the 9 o'clock and 3 o'clock positions, to minimize the risk of injuries to your hands and arms in the event of airbag deployment.

No one and nothing is to come between the airbags and the seat occupant.

Do not use the cover of the front airbag on the front passenger side as a storage area. Make sure that the front passenger is sitting correctly and does not rest feet or legs on the instrument cluster, otherwise leg injuries can occur if the front airbag is triggered.

Make sure that passengers keep their heads away from the side airbag and do not lean against the cover of the head airbag, otherwise injuries can occur when the airbags are triggered. ◀

Even if you adhere to all the instructions, injuries resulting from contact with airbags cannot be fully excluded, depending on the circumstances. The ignition and inflation noise may provoke a mild hearing loss in extremely sensitive individuals. This effect is usually only temporary.

For airbag locations and additional information on airbags, refer to page 98.

Head restraint

A correctly adjusted head restraint reduces the risk of spinal injury in the event of an accident.

 Adjust the head restraint so that its center is approx. at ear level. Otherwise there is increased danger of injury in the event of an accident. ◀

BMW X5: push the head restraints of the 3rd row seats* into the top position.

Head restraints, refer to page 46.

Height

Adjust the head restraint so that its center is approximately at ear level.

Distance

Adjust the distance so that the head restraint is as close as possible to the back of the head.

Safety belts

Before every drive, make sure that safety belts are being worn at all of the occupied seats. Airbags complement the safety belt as an additional safety device, but they do not represent a substitute.

BMW X5: depending on its equipment, your vehicle has either five or seven seats, which are all provided with a safety belt.

 Never allow more than one person to wear a single safety belt. Never allow infants or small children to ride in a passenger's lap. Make sure that the belt lies low around the hips in the lap area and does not press on the abdomen. The safety belt may not lie across the neck, rub on sharp edges, be routed over solid or breakable objects or be pinched. Wear the safety belt without twisting, snugly across the lap and shoulders, as close to the body as possible. Otherwise the belt can slip over the hips in the lap area in a frontal impact and injure the abdomen. Avoid wearing clothing that prevents the belt from fitting properly and pull the belt in

the upper body area periodically to readjust the tension, in order to avoid a reduction in the restraint of the safety belt.
 If the center safety belt in the rear is used, the larger backrest half must be locked, refer to page 124, otherwise the center safety belt has no restraining action. ◀

Safety belts, refer to page 49.

Seats

Note before adjusting

⚠ Never attempt to adjust or calibrate your seat while the vehicle is moving. The seat could respond with unexpected movement, and the ensuing loss of vehicle control could lead to an accident.

Never adjust manually adjustable seats while the vehicle is moving, as otherwise the restraining effect of these seats during accidents could be reduced.

Also on the passenger side, do not incline the backrest too far to the rear while the vehicle is being driven, otherwise there is a danger in the event of an accident of sliding under the safety belt, eliminating the protection normally provided by the belt. ◀

Also observe the information on damage to safety belts on page 50 and on the height of the head restraints on page 46.

Adjusting manually*

⚠ To ensure that the safety systems continue to provide optimized protection, observe the adjustment instructions on page 43. ◀



Pull the lever and slide the seat to the desired position. After you release the lever, move the seat forward or backward slightly so that it engages fully.

Thigh support*



Pull the lever and adjust the thigh support in the longitudinal direction.

Adjusting electrically

⚠ To ensure that the safety systems continue to provide optimized protection, observe the adjustment instructions on page 43. ◀

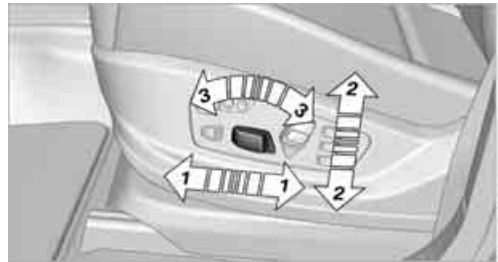

- 1 Longitudinal direction
- 2 Height
- 3 Seat tilt



- 4 Backrest

Differs depending on seat:



- 1 Backrest
- 2 Height

Additional depending on seat:

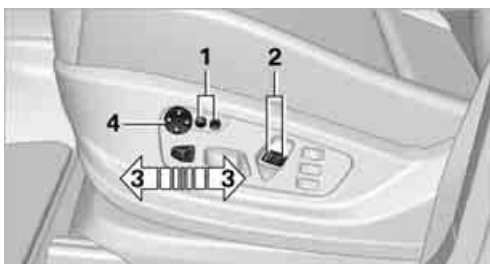

- 1 Backrest width*
- 2 Shoulder support*
- 3 Thigh support*
- 4 Lumbar support*

Backrest width*

The width of the backrest can be changed with the side wings to adjust the side support to your own needs.

Shoulder support*

This also supports the back in the shoulder area, provides a relaxed sitting position and helps relieve stress on the shoulder muscles.

The shoulder support is also used to adjust the distance of the head restraint from the back of the seat occupant's head.

Lumbar support*



You can also adjust the contour of the backrest to obtain additional support in the lumbar region.

The upper hips and spinal column receive supplementary support to help you maintain a relaxed, upright sitting position.

- ▷ Increase or decrease curvature: press front or rear section of switch.
- ▷ Shift curvature up or down: press upper or lower section of switch.

Seat, mirror and steering wheel memory*

You can store and retrieve two different driver's seat and front passenger seat*, exterior mirror-, and steering wheel positions*.

The adjustment of the backrest width and lumbar support is not stored in the memory.

Storing

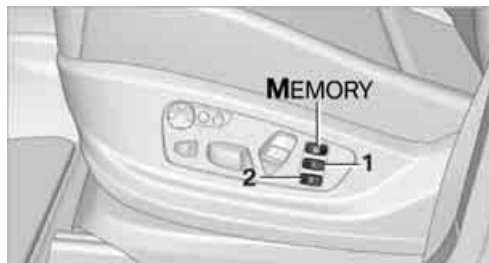

1. Switch on radio readiness or ignition, refer to page 59.
2. Set the desired seat, exterior mirror and steering wheel positions.

- Press the **M** button:
The LED in the button lights up.
- Press the desired memory button **1** or **2**:
the LED goes out.
The positions of the driver's seat, the exterior mirrors, and steering wheel are stored for the remote control currently in use.

Activating

⚠ Do not activate the memory function while the vehicle is moving. There is a risk of accident from unexpected movement of the seat or steering wheel. ◀

Comfort mode

- After unlocking, open the driver's door or switch on radio readiness, refer to page 59.
- Briefly press the desired memory button **1** or **2**.

The adjusting procedure is canceled if you briefly press a seat-adjusting switch or one of the memory buttons.

Safety feature

- Close the driver's door and switch the ignition on or off, refer to page 59.
- Press the desired memory button **1** or **2** and maintain pressure until the adjustment process has been completed.

If the **M** button was pressed inadvertently: press the button again; the LED goes out.

Activating with the remote control

The driver's seat position last set is stored for the remote control currently in use.

You can select whether or not the seat is reset to that position automatically.

⚠ When using this feature, always make sure that the footwell behind the driver's seat is empty and unobstructed. Failure to do so could cause injury to persons or damage to objects behind the seat as a result of a rearward movement of the seat. ◀

The adjusting procedure is canceled if you briefly press a seat-adjusting switch or one of the memory buttons.

Selecting automatic activation

- "Settings"
- "Door locks"
- "Last seat position auto."

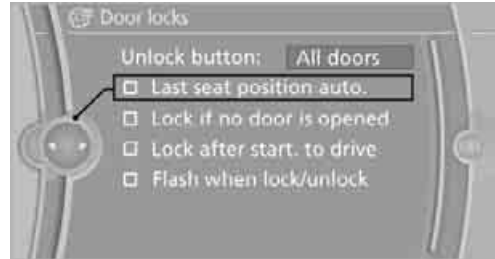

☑ The function for automatically recalling the last seat position is switched on and is stored for the remote control currently in use.

Deactivating automatic recall

Deactivate "Last seat position automatic".

Head restraints

A correctly adjusted head restraint reduces the risk of spinal injury in the event of an accident.

⚠ Adjust the head restraint so that its center is approx. at ear level. Otherwise there is increased danger of injury in the event of an accident. Only remove the head restraints if the respective seat is not occupied. Reinstall the head restraints before transporting passengers, as otherwise the head restraint cannot provide its protective function. ◀

Height

Adjust the head restraint so that its center is approximately at ear level.

Distance

Adjust the distance so that the head restraint is as close as possible to the back of the head.

Active front head restraints

In the event of a rear-end collision of sufficient severity, the active head restraint reduces the distance to the head.

 Do not use seat covers or head restraint covers that could impede the proper functioning of the active head restraint. Otherwise, there is no assurance that the active head restraint will perform its protective function and it is not possible to take advantage of its injury-reducing potential in the event of a rear-end collision.

Have the active head restraints reset after they are triggered in a rear-end collision. Have this work carried out only at a BMW Sports Activity Vehicle Center or at a workshop that works according to BMW repair procedures with correspondingly trained personnel. Otherwise, correct operation of this safety equipment is not guaranteed. ◀

 Removal and installation of the front head restraints should be performed by a BMW Sports Activity Vehicle Center. ◀

Front seats: height adjustment



You can adjust the height of the head restraints electrically.

Front seats: adjusting distance from back of head



- ▷ Forward: pull up.
- ▷ Back: press the button and slide the headrest cushion toward the rear.

 Do not place any objects behind the headrest cushion. Otherwise, you can impair the proper function of the head restraint. ◀

Comfort seat*

You can adjust the distance from the back of the seat occupant's head using the shoulder support, refer to page 45.

Adjusting side extensions

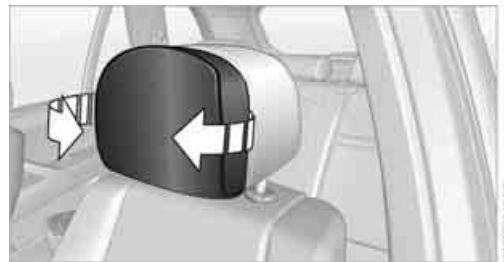

You can fold the side extensions on the head restraint forward for increased lateral support in the resting position.

BMW X5: rear seats and 3rd row seats*, adjusting height

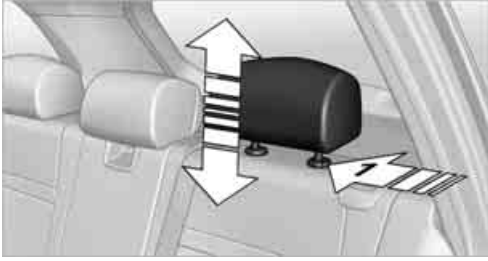

- ▷ To raise: pull up.
- ▷ To lower: press the button, arrow 1, and push the head restraint downward.

In vehicles equipped with 3rd row seats, the height of the middle head restraint is not adjustable.

Removing

1. Pull the head restraint upward to the stop.
2. Press the button, arrow 1, and pull the head restraint all the way out.

BMW X5: rear seats

2nd row seats [Second row seats]

With a divided* row of seats you can adjust both sides individually.

⚠ Never adjust the 2nd row seats while the vehicle is moving, as otherwise the passengers on the 3rd row seats could be injured. Make sure that the locking devices of the 2nd row seats engage properly. Otherwise the restraining effect of the safety belts during an accident could be reduced. ◀

Longitudinal direction*

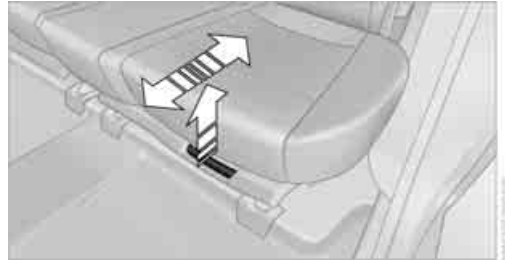

1. Pull the lever and slide the seat into the desired position.
2. Release the lever and move the seat slightly forward or back so that it engages properly.

Backrest*

The backrests can be adjusted in four steps.

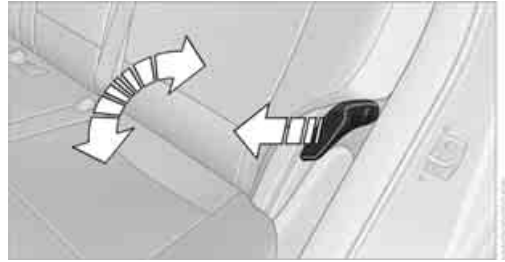

Pull the lever and apply weight to or remove weight from the backrest as needed.

Access to 3rd row seats*



Pull the lever and fold the seat forward.

- ▷ The handle recess on the interior trim of the door pillar makes climbing in easier. ◀

 When folding back the 2nd row seats, make sure that the footwell under the 2nd row seats is clear. Otherwise persons in the 3rd row seats could be injured or objects damaged. ◀

 Warning lamp for 2nd row seats: lights up when the 2nd row seats are not locked. A message also appears on the Control Display.

3rd row seats*

The 3rd row seats are divided and offer space for two persons.

Folding up backrest

Before folding the seats up, remove the roll-up cover, refer to page 122, and if need be, slide the 2nd row seats slightly forward.

1. Pull the lever, refer to arrow. The backrest is unlocked.



2. Fold up and engage the backrest.

 Make sure that the catch engages securely. If it is not properly engaged, transported cargo could enter the passenger compartment during braking or evasive maneuvers and endanger the vehicle occupants. ◀

3. Push the head restraints into the top position.

Folding backrest down

1. Push down the head restraint, refer to page 48.
2. Pull the lever, refer to arrows. The backrests are released.

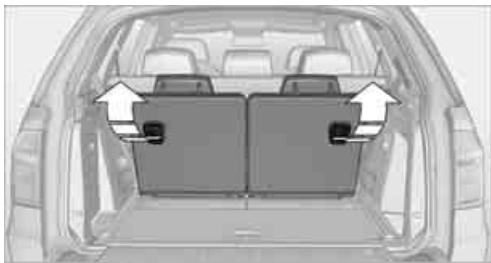

3. Fold the backrest down.

Safety belts

 To ensure that the safety systems continue to provide optimized protection, observe the adjustment instructions on page 43. ◀

Before every drive, make sure that safety belts are being worn at all of the occupied seats. Airbags complement the safety belt as an additional safety device, but they do not represent a substitute.



Fastening

Make sure you hear the latch plate engage in the belt buckle.

Safety belt reminder for driver's seat and passenger seat



The indicator lamp lights up and a signal sounds. A message also appears on the Control Display.

Please check whether the safety belt is correctly fastened.

The safety belt reminder is operative at speeds above approx. 5 mph/8 km/h. It can also be activated if objects are placed on the passenger seat.

Releasing

1. Grasp the belt firmly.
2. Press the red button in the buckle.
3. Guide the belt into its reel.

The shoulder strap's anchorage point will be correct for adult seat occupants of every build if the seat is correctly adjusted, refer to page 44.

BMW X5: the two rear safety belt buckles integrated into the rear seat are for passengers sitting on the left and right. The belt buckle embossed with the word CENTER is intended exclusively for use by passengers riding in the center position.

Damage to safety belts

 In the event of loads caused by accidents or other damage: replace the belt system including the safety belt tensioners and any child restraint devices, and have the belt anchor points checked. Only have this work carried out at a BMW Sports Activity Vehicle Center or at a workshop that works according to BMW repair procedures with correspondingly trained personnel. Otherwise correct operation of this safety equipment is not guaranteed. ◀

Belt-force limiter

The effect of the belt-force limiter on the driver's seat is dependent on the position of the driver's seat.

To maintain the long-term accuracy of this function, the driver's seat must be calibrated if a corresponding message is displayed on the Control Display.

Calibrating driver's seat



The warning lamp lights up. A message also appears on the Control Display. Please calibrate the driver's seat.

1. Move the driver's seat forward until it stops.
2. Move the driver's seat forward again. It briefly moves toward the front in the process.
3. Set the desired seating position again.

The calibration is completed when the message on the Control Display disappears. Should this message continue to be displayed, repeat the calibration. If the message does not disappear even after repeated calibration, have the system checked as soon as possible.



Never carry out calibration while the vehicle is moving, as this can cause accidents. Make sure that no persons or objects become wedged during the calibration process, as this can cause injuries or damage. ◀

Seat heating*

Front



The temperature setting progresses one step through its control sequence each time you press the button. The maximum temperature is supplied when three LEDs are lit.

To switch off: press the button longer.

The temperature is reduced, if need be, down to no heat in order to reduce the load on the battery. The LEDs remain lit.

Rear



Operation similar to front seat heating; without temperature distribution.

Active seat ventilation* and seat heating*

Front

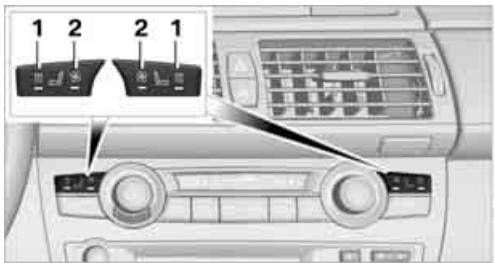

- 1 Seat heating
- 2 Active seat ventilation

Press button **1** or **2** once depending on the temperature or ventilation position. The LED in the respective button lights up.

The temperature and ventilation levels are displayed in bar form on the Control Display. A display of three bars indicates the highest level of seat heating or seat ventilation.

The air quantity is reduced and if need be, the ventilation is switched off in order to reduce the load on the battery. The LEDs remain lit.

To switch off: press button **1** or **2** longer.

Temperature distribution without active seat ventilation

The heat output can be distributed variously in the seat cushion and the backrest.

1. Press the button **1**.
2. Select "Seat heating distribution" and press the controller.



3. Turn the controller to adjust the distribution.
The setting is applied.

Temperature distribution with active seat ventilation

The heat output can be distributed variously in the seat cushion and the backrest.

1. Press button **1**.
2. Select "Seat heating distribution" and press the controller.



3. Turn the controller to adjust the distribution.
The setting is applied.

Heated rear seats

Operation similar to front seat heating; without temperature distribution, refer to page 50.

Active seat*

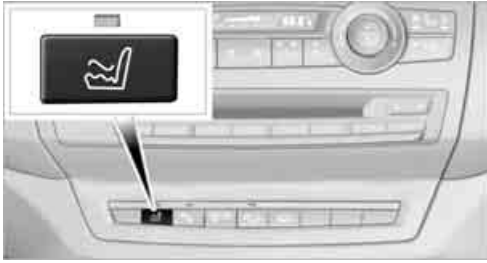

The seat cushion is actively varied by alternately raising and lowering the right and left half of the seat cushion. This reduces muscular tension and fatigue to help prevent lower back pain.

Press the button to switch on; the LED lights up.

The action of the system is reduced and if need be, switched off in order to reduce the load on the battery. The LED remains lit.

If you switch off the active seat, it can take up to 1 minute before the two halves of the seat cushion have returned to their initial position.

Mirrors

Exterior mirrors

⚠ The mirror on the passenger's side is more curved than the driver's mirror. Objects reflected in the mirror are closer than they appear. Do not estimate the distance of following traffic based on what you see in the mirrors; otherwise, there is an increased risk of accident. ◀

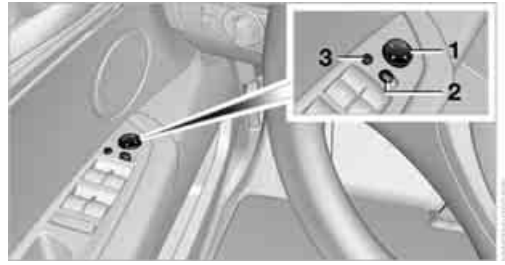

- 1 Adjusting
- 2 Switching to the other mirror or to the automatic curb monitor
- 3 Folding mirrors in and out*

Storing the mirror positions, refer to Seat, mirror and steering wheel memory on page 45.

Adjusting manually

The mirrors can also be adjusted manually: press the edge of the glass.

Folding mirrors in and out*

Pressing button **3** allows you to fold the mirrors in and out again up to a speed of approx.

12 mph/20 km/h. This is advantageous, for example, in car washes, narrow streets or for bringing mirrors that have been manually folded in back into the correct position.

Folded in mirrors fold out again at a speed of approx. 25 mph/40 km/h.

⚠ Before going through a car wash, fold the mirrors in manually, or with button **3**, otherwise they could be damaged, depending on the width of the car wash system. ◀

Automatic heating

Below a certain outdoor temperature, both exterior mirrors are automatically heated when the motor is running or the ignition is switched on.

Tilting down passenger-side exterior mirror – automatic curb monitor*

Activating

1. Slide switch into the driver's side mirror position, arrow 1.

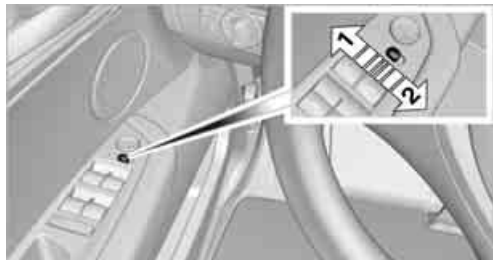

2. Engage transmission position R. The mirror glass tilts downward somewhat on the passenger side. This allows the driver to see the area immediately adjacent to the vehicle – such as a curb – when parking, etc.

Deactivating

Slide switch into the passenger side mirror position, arrow 2.

Interior rearview mirror



To reduce the dazzle effect of following vehicles at night, turn the knob.

Interior and exterior mirrors, automatic dimming feature*

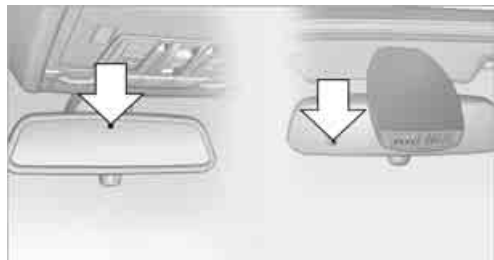

This feature is controlled by two photocells in the interior rearview mirror, one on the front and one on the back.

For trouble-free operation, keep the photocells clean and do not cover the area between the interior rearview mirror and the windshield. Do not attach stickers of any kind to the windshield in front of the mirror, either.

Steering wheel

Adjusting

 Do not adjust the steering wheel while the vehicle is moving. There is a risk of accident as the result of unexpected movement. ◀

Manual adjustment*

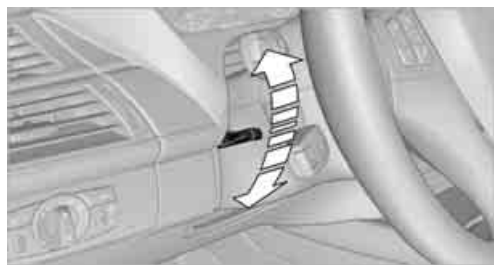

1. Flip the lever down.
2. Adapt the longitudinal direction and height of the steering wheel to the seat position.
3. Return the lever back to its locked position.

Power adjustment*

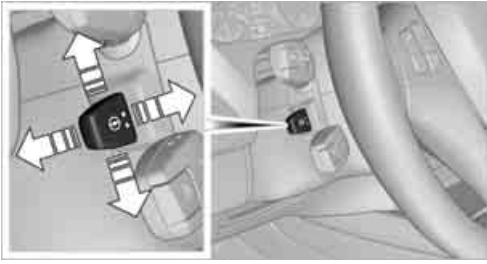

The steering wheel can be adjusted in four directions.

Storing steering wheel positions, refer to Seat, mirror and steering wheel memory on page 45.

Easy entry/exit*

To facilitate entry and exit, the steering wheel temporarily moves into the uppermost position.

Steering wheel heating*



Press the button.

When the steering wheel heater is switched on, the LED in the button lights up.

Transporting children safely

The right place for children

 Do not leave children unattended in the vehicle, otherwise they could endanger themselves and other persons, e.g. by opening the doors. ◀

Children always in rear

Accident research shows that the safest place for children is on the rear seat.

 Children younger than 13 years of age or with a height under 5 ft/150 cm may only be transported on the 2nd row seats in child restraint devices which correspond to the age, weight and height of the child. Otherwise there is an increased danger of injury in an accident. ◀

Children 13 years of age or older must wear a safety belt as soon as a suitable child restraint device can no longer be used due to their age, weight and size.

Exception for front passenger seat

 Should it be necessary to use a child restraint device on the front passenger seat, the front and side airbags on the passenger side must be deactivated. Otherwise, there is an increased risk of injury for the child if the airbags are triggered, even with a child restraint device. ◀

For more information on automatic deactivation of the front passenger airbags, refer to page 98.

Installing child restraint devices

 Follow the child restraint device manufacturer's instructions for selection, installation, and use of child restraint devices. Otherwise, the degree of protection may be reduced. ◀

 BMW X5: for equipment with 3rd row seats*, make sure that the seat of the 2nd row seats on which the child restraint device is mounted is properly locked. Otherwise there is an increased risk of injury for the child in an accident.

Do not mount child restraint devices on the 3rd row seats, as otherwise the protection provided by these child restraint devices may be reduced. ◀

BMW X5: before mounting a child restraint device in the center seat of the 2nd row seats, move the outer seat cushions and backrests into the rearmost positions.

On front passenger seat

 After mounting a child restraint device on the front passenger seat, make sure that the front and side airbags on the front passenger side are deactivated; otherwise, there is an increased risk of injury if the airbags are triggered. ◀

Seat position

Before installing a child restraint device, move the passenger seat into the furthest back and highest* position in order to achieve the best possible safety belt position. Do not change the seat position after this.

Backrest width*

 The backrest width adjustment of the front passenger seat must be completely open. After installing the child's seat, no memory position may be called up; otherwise, the stability of the child's seat on the front passenger seat is reduced. ◀

1. Open backrest width adjustment completely, refer to page 45.
2. Install child's seat.

Child seat security



The rear safety belts

- ▷ BMW X5: all safety belts of the 2nd and 3rd* row seats
- ▷ BMW X6: all safety belts of the 2nd row seats

and the safety belt for the front passenger can be locked to prevent extension in order to permit attachment of child restraint devices.

Locking safety belt

1. Secure the child restraint device with the belt.
2. Pull out the belt webbing completely.
3. Allow the belt webbing to be pulled in and pull taut against the child restraint device. The safety belt is locked.

Unlocking safety belt

1. Open the belt buckle.
2. Remove the child restraint device.
3. Allow the belt webbing to be pulled in completely.

LATCH child restraint fixing system

LATCH: Lower Anchor and Tethers for Children.

- ⚠ Follow the system manufacturer's instructions on installation and use of LATCH child restraint devices; otherwise, their protective function may be reduced. ◀

Before attaching the child's seat, pull the belt away from the region of the child restraint fixing system.

- ⚠ Make sure that the LATCH mounts have properly clicked into place and that the child restraint device is resting snugly against the backrest. Otherwise, the protective action may be reduced. ◀

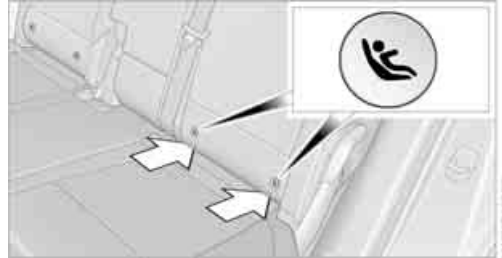

The mounts for the LATCH anchors are located at the points indicated by the arrows.

Child restraint device with tether strap

- ⚠ Only use the top tether mounting points to secure child restraint devices, otherwise the mounting points could be damaged. Do not mount child restraint devices on the 3rd row seats in the BMW X5; otherwise the protection provided by these child restraint devices may be reduced. ◀

BMW X5

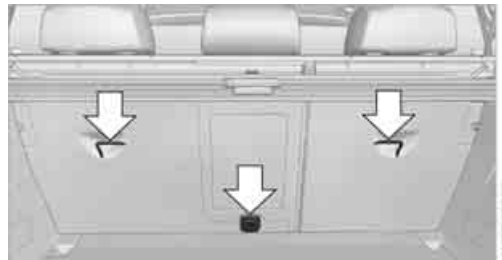

There are three additional mounting points for child restraint devices with a tether strap on the 2nd row seats, refer to arrows. Fold out before using the center mounting point.

BMW X6

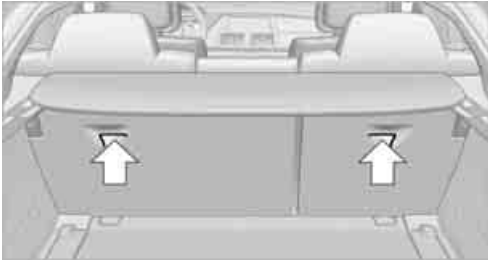

For child restraint devices with tether strap, there are two additional attachment points on the back of the rear seat backrests, refer to arrows.

Placement of tether strap

⚠ Make sure that the tether strap is not routed over sharp edges and does not twist on its way to the attachment point; otherwise, the belt cannot properly secure the child restraint device in the event of an accident. ◀

BMW X5

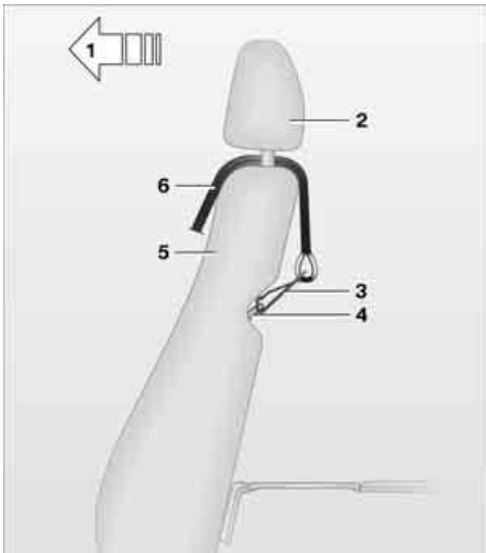

- 1 Direction of travel
- 2 Head restraint
- 3 Tether strap hook
- 4 Mounting point

5 Backrest

6 Tether strap of child restraint device

When using the cargo bay cover, route the tether strap through between the backrest of the 2nd row seats and the cargo bay cover.



BMW X6

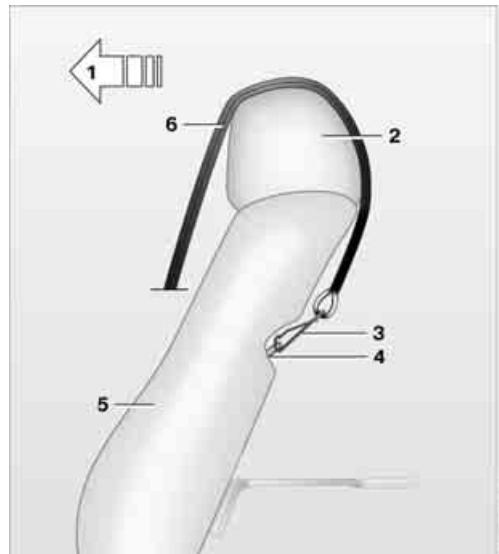

- 1 Direction of travel
- 2 Head restraint
- 3 Tether strap hook
- 4 Mounting point
- 5 Backrest
- 6 Tether strap of child restraint device

When using the cargo bay cover, route the tether strap through between the rear seat backrest and the cargo bay cover.

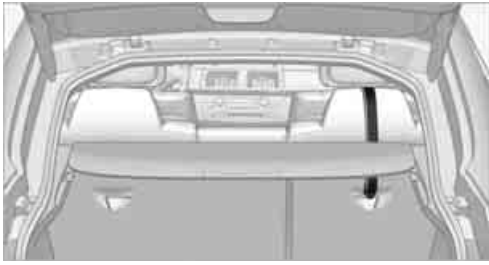

Attaching tether strap to the backrest of the 2nd row seats

BMW X5:

On outer seats:

1. Slide the head restraint upward.
2. Guide the tether strap between the head restraint brackets.
3. Hook in the tether strap on the mounting point with the hook.
4. Slide the head restraint into the bottom position.
5. Pull tether strap taut.

On the center seat when equipped with two rows of seats:

1. Fold the center armrest somewhat toward the front.
2. Guide the tether strap through the opening in the center armrest.

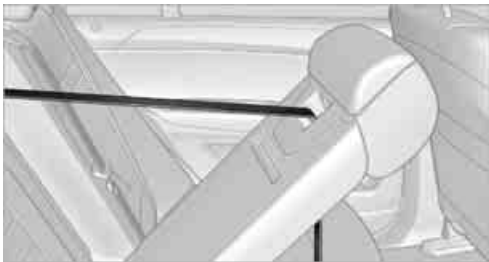

3. Fold back and engage the center armrest.
4. Hook in tether strap on mounting point.
5. Pull tether strap taut.

On the center seat when equipped with three rows of seats:

1. Slide the head restraint upward.
2. Guide the tether strap between the head restraint brackets.
3. Hook in the tether strap on the mounting point with the hook.
4. Slide the head restraint into the bottom position.
5. Pull tether strap taut.

BMW X6:

1. Route tether strap over the middle of the head restraint.
2. Hook in the tether strap on the mounting point with the hook.
3. Pull tether strap taut until it compresses the cushion of the head restraint, thus preventing the tether strap from sliding off.

On trips

Child-safety locks for rear doors



Slide down the safety lever on the rear doors: the door can now be opened from the outside only.

Safety switch for power windows

Always press the safety switch for the power windows, refer to page 38, when children are riding in the rear of the vehicle.

Ignition lock

Inserting remote control into ignition lock



Insert the remote control as far as possible into the ignition lock.
Radio readiness switches on. Some electronic systems/consumers are ready for operation.

Comfort access*

With comfort access, only insert the remote control into the ignition lock in exceptional cases, refer to page 35.

Removing remote control from ignition lock

 Do not pull the remote control out of the ignition lock using force, as otherwise damage may result. ◀

Before removing the remote control, first press it in as far as possible to release the locking device.

The ignition is switched off if it was still switched on.

Start/Stop button



Pressing the Start/Stop button switches the radio readiness or the ignition on and off.

 Pressing the Start/Stop button with the brake pedal depressed starts the engine. ◀

Radio readiness

Some electronic systems/consumers are ready for operation. The time and outside temperature are displayed in the instrument panel.

Radio readiness is automatically switched off:

- ▶ when the remote control is removed from the ignition lock
- ▶ with comfort access* by touching the sensitive surface above the door lock, refer to Locking on page 36

Ignition on

All electronic systems/consumers are ready for operation. The odometer and the trip odometer are displayed in the instrument panel, refer to page 71.

 Please switch off the ignition and the electronic systems/consumers which are not required when the engine is not running to save the battery. ◀

Radio readiness and ignition off

All indicator lamps, warning lamps, and displays in the instrument panel go out.

The ignition switches off automatically* if the driver's door is opened. Pressing the start/stop button again switches the ignition back on.

For example, the ignition is not switched off in the following situations:

- ▷ the brakes are actuated
- ▷ the low beams are switched on

Starting engine

 Do not run the engine in closed rooms, otherwise the inhalation of toxic exhaust gases can cause unconsciousness and death. The exhaust gases contain carbon monoxide, an odorless and colorless, but highly toxic gas. Never leave an unattended vehicle with the engine running, as such a vehicle represents a potential safety hazard.

To prevent the vehicle from rolling, always engage transmission position N or P and set the parking brake before leaving the vehicle with the engine running. ◀

Do not allow the engine to warm up by leaving it running while the vehicle remains stationary. Instead, begin to drive at a moderate engine speed.

 The engine starts when you depress the brake pedal while pressing the Start/Stop button. ◀

 Avoid frequent starting in quick succession or repeated starting attempts in which the engine does not start. Otherwise, the fuel is not burned or inadequately burned and there is a danger of overheating and damaging the catalytic converter. ◀



Remote control in ignition lock or with comfort access in vehicle, refer to page 35.

1. Depress brake pedal.
2. Press the Start/Stop button.

The system responds by automatically engaging the starter for a certain period and automatically disengaging it as soon as the engine starts.

Diesel engine

When the engine is cold and at temperatures below approx. 32 °F / 0 °C the starting process may be somewhat delayed due to automatic preglowing. The preglowing indicator lamp in the instrument panel lights up. A message appears on the Control Display.

Switching off engine

 When leaving the vehicle, always take along the remote control. Set the parking brake firmly when parking; otherwise, the vehicle could roll. ◀

Procedure

1. Engage transmission position P with the vehicle stationary.
2. Press the Start/Stop button.
3. Set the parking brake.
4. Remove the remote control from the ignition lock, refer to page 59.

Before driving into a car wash

The vehicle can roll if you proceed according to the following steps:

1. With comfort access*: insert the remote control into the ignition lock.
2. Depress brake pedal.
3. Engage transmission position N.
4. Release the parking brake or deactivate Automatic Hold.
5. Switch off the engine.

Transmission position P will be engaged:

- ▷ automatically after approx. 30 minutes
- ▷ if you remove the remote control from the ignition lock

Parking brake

The concept

Your BMW is equipped with an electromechanical parking brake.

The parking brake is primarily intended to prevent the vehicle from rolling while parked.

You can use the parking brake in two ways:

- ▷ manually, by pulling and pushing the button
- ▷ automatically, by activating Automatic Hold, refer to page 61

With the engine stopped, the parking brake acts on the rear wheels via an electromechanical system. When the engine is running, the parking brake acts on the disk brakes of the front and rear wheels via the brake hydraulics.

Setting manually



Pull button. The parking brake is set.

PARK The indicator lamp in the instrument panel lights up red. The parking brake is set.

(P) Indicator lamp on Canadian models.

The remote control does not have to be inserted into the ignition lock for the parking brake to be set.

While driving

If exceptional circumstances should make it necessary to set the parking brake while the vehicle is in motion, pull on the button longer. The vehicle continues to brake forcefully for as long as you pull on the button.

PARK The indicator lamp in the instrument panel lights up red, a chime sounds and the brake lamps light up.

(P) Indicator lamp on Canadian models.

As soon as you brake the vehicle almost to a stop, i.e., down to a speed of approx. 2 mph/3 km/h or below, the parking brake remains set.

Releasing manually



Press the button with the brake depressed.

PARK The indicator lamp in the instrument panel goes out.

(P) Indicator lamp on Canadian models.

! When leaving the vehicle, always take along the remote control; this precaution prevents children from releasing the parking brake, for example. ◀

Automatic Hold

The concept

This function assists you as you drive by automatically setting and releasing the parking brake, e.g. when you are stopped at a traffic signal or in stop-and-go traffic.

When Automatic Hold is activated, the vehicle is

automatically held in place when standing. When driving up inclines, the system prevents your vehicle from rolling backward in an undesired way.

After the engine is started, the system can be activated and deactivated at any time the driver's seat is occupied until the next time the engine is switched off.

Activating

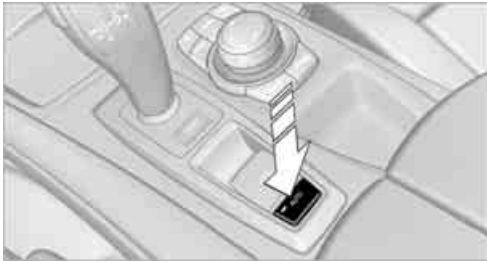

Press the button. The LED in the button lights up and the indication AUTO H appears in the instrument panel. Automatic Hold is activated.

 If the vehicle is being held by Automatic Hold, the indicator light in the instrument panel also lights up in green.

 Indicator lamp on Canadian models.

Deactivating

Press the button again, the LED in the button and the indication AUTO H in the instrument panel go out. Automatic Hold is deactivated.

If the vehicle is being held by Automatic Hold, then press on the brake pedal to deactivate it.

When the parking brake is set manually, refer to page 61, Automatic Hold is automatically deactivated.

Driving

With Automatic Hold activated, the vehicle is automatically prevented from rolling after it comes to a stop.

 The indicator lamp in the instrument panel lights up in green.

 Indicator lamp on Canadian models.

If the transmission is in a drive position, simply press on the gas pedal to begin driving. The brake is automatically released and the indicator lamp goes out.

 Before driving into the car wash, deactivate Automatic Hold; otherwise, the parking brake will be automatically set after stopping and the vehicle can no longer roll. ◀

Parking

If the vehicle is being held by Automatic Hold and you switch off the motor, the parking brake is automatically set.

 The indicator lamp in the instrument panel changes from green to red.

 Indicator lamp on Canadian models.

 The parking brake is not set if you have already switched off the engine while the vehicle is rolling to a stop. Automatic Hold is deactivated. ◀

You can manually release the parking brake even after switching off the motor as long as the remote control remains in the ignition lock, refer to page 61. Use this function in car washes, for example.

 When leaving the vehicle, always take along the remote control; this precaution prevents children from releasing the parking brake, for example. ◀

For your safety

Automatic Hold is automatically deactivated when:

- ▷ the engine is switched off
- ▷ the driver's door is open and the safety belt of the driver is disconnected

- ▷ the vehicle is braked to a stop during driving

PARK In the instrument panel, the indicator lamp changes from green to red and the indication AUTO H goes out.

 Indicator lamp on Canadian models.

Before you start to drive, either release the parking brake manually, refer to page 61, or reactivate Automatic Hold, refer to page 62.

 Before leaving the vehicle with the engine running, shift the selector lever into position P of the automatic transmission and make sure that the parking brake is set. Otherwise, the vehicle may begin to roll. ◀

Malfunction

If the parking brake fails or malfunctions, secure the vehicle against rolling, e.g. with a wheel chock, if you leave the vehicle.

Releasing parking brake manually

In the event of an electrical power loss or electrical malfunction, you can release the parking brake manually.

 Before manually releasing the parking brake and each time you park the vehicle without setting the parking brake, make sure that the automatic transmission is in position P, refer to page 65. Be sure to pay attention to the information in the instrument panel.

In addition, secure the vehicle against rolling, e.g. with a wheel chock. Otherwise there is a danger that the vehicle could roll if parked on a steep slope. ◀

If it becomes necessary to also release the transmission lock of the automatic transmission manually, follow this sequence:

1. If necessary, start by releasing the parking brake manually.
2. Then release the automatic transmission's transmission lock manually, refer to page 66.

Jump starting and towing, refer to information starting on page 262.

Releasing

1. Open the left-hand side panel in the cargo bay.
2. Remove the first-aid kit * and warning triangle* if necessary. Close the bracket of the warning triangle.
3. Insert the releasing tool, contained in the onboard tool kit under the floor panel, refer to page 250, at the releasing point.



4. Firmly pull the releasing tool upward against the mechanical resistance, refer to arrow, until a considerable increase in force is felt and the parking brake is then clearly heard to release.
5. Stow the releasing tool, warning triangle* and first-aid kit* and close the left side panel in the cargo bay.

 Only have a malfunction corrected by the nearest BMW Sports Activity Vehicle Center or a workshop that works in accordance with BMW guidelines and uses appropriately trained personnel. If the parking brake has been released manually in response to a malfunction, only technicians can return it to operation. ◀

 Following manual release, the actual status of the parking brake may deviate from that displayed by the indicator lamp. ◀

Operation after interruptions in power supply

 The parking brake can only be used again if it was manually released due to an interruption in the supply of electrical power. Otherwise the operation of the parking brake is not ensured and there is a danger of the vehicle rolling despite the parking brake being set. ◀

Procedure

1. Switch on the ignition.
2. Press the button with the brake depressed.

PARK The indicator lamp in the instrument panel goes out as soon as the parking brake is ready for operation again.

(P) Indicator lamp on Canadian models.

Any noises which occur are normal. Startup may take several seconds.

Automatic transmission with Steptronic

In addition to fully automatic operation, you can also manually shift with the Steptronic, refer to page 65.

Transmission positions

P R N D M/S + -

⚠ To prevent the vehicle from creeping after you select a driving position, maintain pressure on the brake pedal until you are ready to start. ◀

Displays in instrument panel



P R N D, DS*, S1* through S6*, M1 through M6

The transmission position and the currently engaged gear are displayed.

Engaging transmission position

- ▷ You can only engage transmission positions D, R or N when the engine is running.

- ▷ With the vehicle stationary, depress the brake pedal before shifting out of P or N; otherwise the shift command will not be executed: shiftlock.

⚠ To prevent the vehicle from creeping after you select a driving position, maintain pressure on the brake pedal until you are ready to start. ◀

Shifting into D, R, N

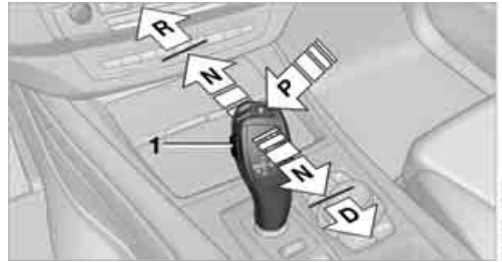

Briefly press the selector lever in the desired direction, beyond a resistance point if necessary. When shifting out of P or into R, simultaneously push the unlock button 1.

The engaged transmission position is displayed on the selector lever.

The selector lever immediately returns to the center position when released.

Engaging P



Press button **P**.

Also observe the additional information on the automatic transmission.

- ▷ The transmission automatically shifts into park if you release the driver's safety belt and open the driver's door with the engine running while in reverse or drive. ◀

R Reverse

Select only with the vehicle stationary.

An interlock prevents inadvertent gearshifts into transmission position R. To release the lock, push the unlock button **1**.

P Park

Select only with the vehicle stationary. The rear wheels are locked.

 P is engaged automatically as soon as you switch off the engine unless N is engaged and on vehicles with comfort access the remote control is inserted in the ignition lock, refer to page 59. ◀



N Neutral

Can, for example, be engaged in automatic car washes. The vehicle can roll.

 N remains engaged even after the engine is switched off whenever you leave the remote control in the ignition lock. This function is used, for example, in a car wash, refer to page 60. After approx. 30 minutes P is automatically engaged. ◀

D Drive, automatic position

Position for normal vehicle operation. All forward gears are available.

Under normal operating conditions, the fuel consumption is lowest when driving in position D.

Kick-down

The kick-down mode provides maximum acceleration.

Press the accelerator pedal beyond the increased resistance at full throttle.

Sport program and manual mode M/S



Press selector lever out of transmission position D toward the left:

The sport program is activated and DS is displayed in the instrument cluster; in the BMW X6, S1 through S6 are displayed. This position is recommended for a performance-oriented driving style.

When the selector lever is pressed forward or back, the manual mode is activated and the Steptronic shifts the gear. The instrument panel shows M1 through M6.

Upshifts and downshifts are executed only when they will result in a plausible combination of engine and vehicle speed; thus, for example, a downshift that would cause the engine to overrev will not be executed by the system. The selected gear is briefly displayed in the instrument panel, followed by the current gear.

To use the automatic function again, press the selector lever to the right into position D.

BMW X6: changing gears using shifting paddles on steering wheel

The shifting paddles make it possible to quickly change gears since both hands can remain on the steering wheel.

- ▶ In automatic mode D, if you shift using the shifting paddles on the steering wheel, then the system switches into manual mode.
- ▶ If, after a certain amount of time, you neither shift with the shifting paddles nor accelerate, then the system switches back into automatic mode D.

 With the transmission position M/S selected, the manual mode remains active. ◀

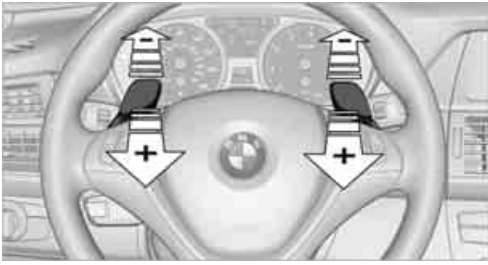

- ▷ Upshifting: pull on one of the shifting paddles, arrows +.
- ▷ Downshifting: press on one of the shifting paddles, arrows -.

Upshifts and downshifts are executed only when they will result in a plausible combination of engine and vehicle speed; thus, for example, a downshift that would cause the engine to overrev will not be executed by the system. The selected gear is briefly displayed in the instrument panel, followed by the current gear.

Manually releasing and engaging transmission lock

 In case of a power failure, e.g. when the battery is drained or disconnected, or an electrical malfunction, the transmission lock must be manually released, as otherwise the rear wheels are blocked and the vehicle cannot be towed. ◀

 Step on the brake when manually releasing the transmission lock; otherwise, there is a danger of the vehicle rolling. ◀

The transmission lock should only be released for towing. Reengage the transmission lock after parking the vehicle at its destination.

If it also becomes necessary to manually release the parking brake, follow this sequence:

1. Secure the vehicle against rolling.
2. Manually release the parking brake, refer to page 63.
3. Manually release the transmission lock of the automatic transmission.

Releasing

1. Slide back the cover of the cup holder and remove the floor mat on the bar between the cup holders, arrow 1.



2. Open the cover in the bottom of the cup holder with the releasing tool from the onboard tool kit, page 250, refer to arrow 2.
3. If necessary, unlock the lock* with the integrated key of the remote control, refer to page 26, and remove it.
4. Insert the releasing tool into the opening, arrow 3.



5. Turn the releasing tool as far as possible, arrow 4, and then press downward and leave it in. The transmission lock is released.

 Engage the transmission lock after parking the vehicle at its destination. Otherwise there is a danger of the vehicle rolling. ◀

Locking



1. Pull out the releasing tool.
The transmission lock is engaged again.
2. If necessary, insert the lock* and lock it.
3. Close the cover in the bottom of the cup holder and lay in the mat again.
4. Close the cover of the cup holder and stow the releasing tool.

Information on jump starting and towing, from page 262.

Turn signals/headlamp flasher/flasher/high beams

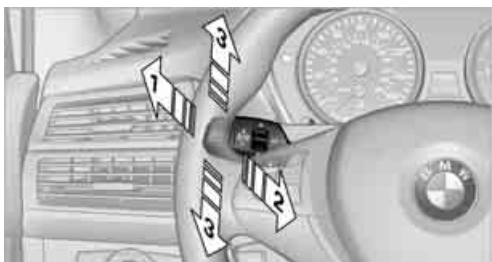

- 1 High beams
- 2 Headlamp flasher
- 3 Turn signals

Using turn signals

Press the lever beyond the resistance point.

To switch off manually, press the lever up to the resistance point.

 Atypically rapid flashing of the indicator lamp indicates that a turn signal bulb needs to be replaced. ◀

Signaling briefly

Press lever to resistance point and hold for as long as you wish to signal.

Triple turn signal activation

Press the lever up to the resistance point. The turn signal flashes three times.

You can activate or deactivate this function.

1. "Settings"
2. "Lighting"
3. "Triple turn signal"

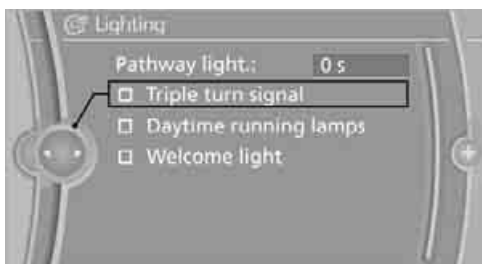

Triple turn signal activation is activated and is stored for the remote control currently in use.

Washer/wiper system

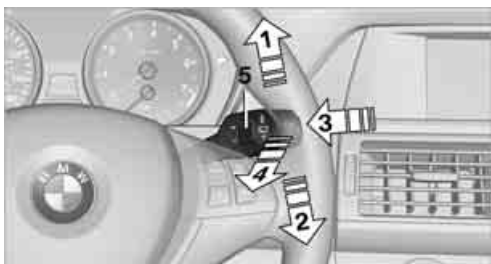

- 1 Switching on wipers
- 2 Switching off wipers or brief wipe
- 3 Activating/deactivating intermittent wipe or rain sensor*
- 4 Cleaning windshield and headlamps*
- 5 Setting interval for intermittent wipe or sensitivity of the rain sensor*

Switching on wipers

Pull the lever upward, arrow 1.

The lever automatically returns to its initial position when released.

Normal wiper speed

Press once.

The system reverts to operation in the intermittent mode with the vehicle stationary.

Fast wiper speed

Press twice or press beyond the resistance point.

The system reverts to normal speed with the vehicle stationary.

Intermittent operation or rain sensor*

With the rain sensor, the wiper operation is controlled automatically as a function of the rain intensity. The rain sensor is located on the windshield, directly in front of the interior rear-view mirror.

Activating intermittent operation or rain sensor



Press the button, arrow 3. The LED in the button lights up.

Setting interval for intermittent wipe or sensitivity of rain sensor

Turn the thumbwheel 5.

Deactivating intermittent operation or rain sensor

Press the button again, arrow 3. The LED goes out.

 Deactivate the rain sensor when passing through an automatic car wash. Failure to do so could result in damage caused by undesired wiper activation. ◀

Cleaning windshield and headlamps*

Pull the lever, arrow 4.

The system sprays washer fluid against the windshield and activates the wipers for a brief period.

When the vehicle lighting system is switched on, the headlamps are also cleaned at regular and appropriate intervals.

 Do not use the washers if there is any danger that the fluid will freeze on the windshield. If you do so, your vision could be obscured. To avoid freezing, use a washer fluid antifreeze, refer to Washer fluid. Do not use washing mechanisms when the washer fluid reservoir is empty, otherwise you will damage the washer pump. ◀

Windshield washer nozzles

Both windshield washer nozzles are automatically heated with the engine running or the ignition switched on.

BMW X5: rear window wiper



- 1 Intermittent mode. When reverse gear is engaged, continuous operation is switched on automatically
- 2 Cleaning the rear window

 Do not use washing mechanisms when the washer fluid reservoir is empty, otherwise you will damage the washer pump. ◀

Washer fluid

! Washer fluid antifreeze is flammable. For this reason, keep it away from ignition sources and store only in the closed original container out of reach of children. Otherwise, there is the danger of bodily injury. Always observe the instructions for use provided on the containers. ◀

Filler neck for washer fluid

! Only add washer fluid with the engine cooled down to exclude contact with hot engine components. Otherwise there is a danger of fire and to personal safety if the fluid is spilled. ◀

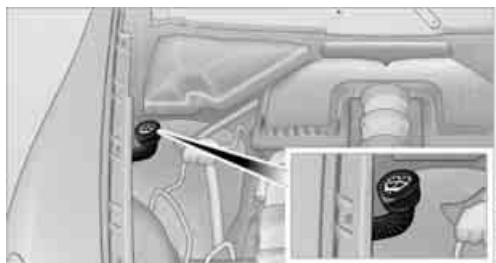

All washer nozzles are supplied from one reservoir.

Fill with water and – if required – with a washer antifreeze, according to manufacturer's recommendations.

▷ In order to maintain the mixture ratio, mix the washer fluid before filling. ◀

Capacity

Approx. 6.3 US quarts/6 liters.

Cruise control*

The concept

The cruise control with a braking function is available for use at speeds of approx. 20 mph/30 km/h and higher. The vehicle stores and maintains the speed that you set using the lever mounted on the steering column. To keep the specified speed constant, the system brakes if

the engine braking effect is not sufficient on a downhill grade.

! Do not use the cruise control under driving conditions that do not permit a constant speed, e.g. when driving on winding roads, in heavy traffic or in poor road conditions such as snow, rain, ice, and loose road surface. Otherwise you could lose control of the vehicle and cause an accident. ◀

One lever for all functions

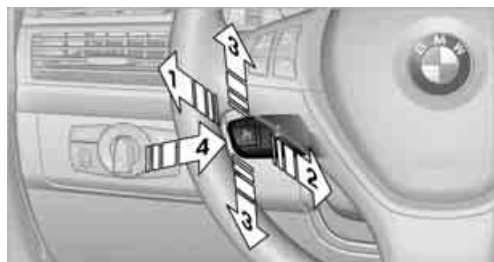

- 1 Storing speed and maintaining or increasing
- 2 Storing speed and maintaining or decreasing
- 3 Deactivating cruise control
- 4 Resuming stored speed

Maintaining current speed

Briefly press, arrow **1**, or briefly pull, arrow **2** lever.

The speed currently being driven is stored and maintained. It is indicated on the speedometer and briefly in the instrument panel.

The controlled speed can drop on uphill grades if the engine output is insufficient. If the engine braking effect is not sufficient on a downhill grade, the system lightly brakes the vehicle.

Increasing speed

Repeatedly press the lever up to or beyond the resistance point, arrow **1**, until the desired speed is set.

- ▷** Each time the lever is pressed to the resistance point, the speed is increased by approx. 1 mph or 1 km/h.

- ▷ Each time the lever is pressed beyond the resistance point, the desired speed increases by a maximum of 5 mph or 10 km/h.

The system stores the setting and maintains the set speed.

Accelerating with lever

Accelerate slightly:

Press the lever up to the resistance point, arrow **1**, until the desired speed is reached.

Accelerate more rapidly:

Press the lever beyond the resistance point, arrow **1**, until the desired speed is reached.

The vehicle accelerates without pressure on the accelerator pedal. The system stores the setting and maintains the set speed.

Reducing speed

Repeatedly pull the lever up to the resistance point or beyond, arrow **2**, until the desired speed is displayed.

- ▷ Each time the lever is pulled up to the resistance point, the desired speed decreases by approx. 1 mph or 1 km/h.
- ▷ Each time the lever is pulled beyond the resistance point, the desired speed is decreased by a maximum of 5 mph or 10 km/h until the minimum speed of 20 mph or 30 km/h is reached.

The system stores the setting and maintains the set speed.

Deactivating cruise control

Briefly press the lever up or down, arrow **3**. The displays in the speedometer go out.

In addition, the system is automatically deactivated:

- ▷ when braking
- ▷ when transmission position N is engaged
- ▷ when DTC is activated or DSC is deactivated
- ▷ when HDC is activated

- ▷ when the parking brake is set
- ▷ when driving stability control systems intervene

Accelerating does not deactivate the cruise control. After releasing the accelerator pedal, the stored speed is reached and maintained again.

Warning lamp



The warning lamp lights up if the cruise control has been deactivated automatically, e.g. by a control intervention of the DSC. A message appears on the Control Display.

Resuming stored speed

Briefly press the button, arrow **4**. The stored speed is resumed and maintained.

With the ignition switched off, the stored speed value is deleted and cannot be resumed again.

Displays in instrument panel



1 Stored desired speed

2 Selected desired speed appears briefly

▷ If --- mph or --- km/h temporarily appears in the instrument panel display, it is possible that the system prerequisites for operation are currently not met. ◀

Malfunction



The warning lamp lights up if the system has failed. A message appears on the Control Display. Detailed information is provided from page [77](#).

Everything under control

Odometer, outside temperature display, clock

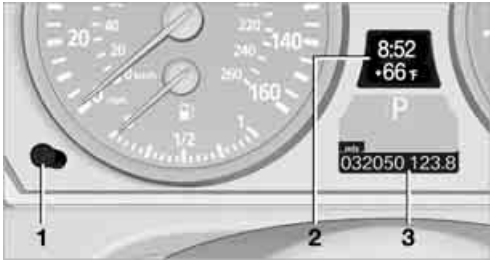

- 1 Knob in the instrument cluster
- 2 Time, outside temperature, and date
- 3 Odometer and trip odometer

Knob in the instrument panel

- ▷ With ignition switched on
Press knob:
Resetting trip odometer
Press the knob for approx. 5 seconds:
Displaying service requirements, refer to page 74
- ▷ With ignition switched off
Press knob:
Briefly displaying time, outside temperature and odometer

Units of measure

To select the respective units of measure, miles or km for the odometer as well as °F or °C for the outside temperature, refer to page 80.

The setting is stored for the remote control currently in use.

Time, date, outside temperature

From radio readiness the outside temperature and the time are displayed.

Setting the time, refer to page 79.

Retrieving date



Press the button on turn signal lever upward; the date appears.

To set the date, refer to page 80.

Pressing the button upward or downward several times changes the display between clock, outside temperature, date, and Check Control messages, refer to page 78.

Outside temperature warning

If the display drops to +37 °F / +3 °C, a signal sounds and a warning lamp lights up. A message appears on the Control Display. There is an increased danger of ice.

 Even at temperatures above +37 °F / +3 °C ice can form. Therefore, drive carefully, e.g. on bridges and sections of road in the shade, otherwise there is an increased accident risk. ◀

Odometer and trip odometer

Resetting trip odometer:
Press knob 1 in the instrument panel with the ignition switched on.

When vehicle is parked

To briefly display the time, outside temperature and mileage after the remote control has been removed from the ignition lock:
Press knob 1 in the instrument panel.

Tachometer



Do not operate the engine with the needle in the red overspeed zone of the gauge, refer to arrow. At high revs in this range, the flow of fuel is interrupted to protect the engine.

Coolant temperature

Should the coolant, and with it the engine become too hot, a warning lamp lights up. In addition, a message appears on the Control Display.

Checking coolant level, refer to page [243](#).

Engine oil temperature*



When the engine is at operating temperature, the engine oil temperature is between approx. 170 °F/80 °C and approx. 250 °F/120 °C.

When the engine oil temperature is too high, a warning lamp lights up in the instrument panel.

Energy control*



Displays the current fuel consumption. This allows you to see whether your current driving style is conducive to fuel economy with minimum exhaust emissions.

Fuel gauge



Fuel tank capacity: approx. 22.5 US gal/ 85 liters. You will find information on refueling on page 224.

If the tilt of the vehicle varies for a longer period, when you are driving in mountainous areas, for example, the indicator may fluctuate slightly.

Reserve

After the reserve quantity has been reached, a message briefly appears on the Control Display; the remaining range is shown in the computer. Below a range of approx. 30 miles/50 km, the message remains on the Control Display.

 Refuel as soon as possible once your cruising range falls below 30 miles/ 50 km, otherwise engine functions are not ensured and damage can occur. ◀

Computer

Displays in instrument panel

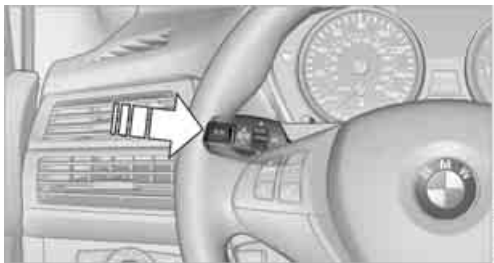

To display the information, press the BC button on the turn signal lever.

The following information is displayed:

- ▶ Cruising range
- ▶ Average speed
- ▶ Average fuel consumption
- ▶ BMW X6: Dynamic Performance Control, refer to page 90

Cruising range

Displays the estimated cruising range available with the remaining fuel. The range is projected based on the driving style over the last 20 miles/ 30 km.

 Refuel as soon as possible once your cruising range falls below 30 miles/ 50 km, otherwise engine functions are not ensured and damage can occur. ◀

Average speed

Periods with the vehicle parked and the engine stopped are not included in the calculations of average speed.

To reset average speed: press the BC button on the turn signal lever for approx. 2 seconds.

Average fuel consumption

The average fuel consumption is calculated for the time during which the engine is running.

To reset average fuel consumption: Press the BC button on the turn signal lever for approx. 2 seconds.

For different routes

You can display the average speed and average consumption for two different routes on the Control Display, refer to the following and to Trip computer*.

Displays on Control Display

You can also access the computer using iDrive.

1. "Vehicle Info"
2. "Onboard info" or "Trip computer"



Displays on the "Onboard info":

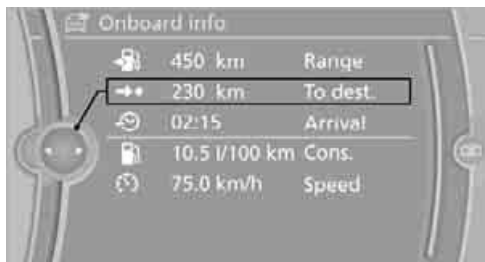

- ▷ Cruising range
- ▷ Distance from destination
- ▷ Estimated time of arrival if:
 - ▷ Entering a distance manually in the computer, see below.
 - ▷ A destination was entered in the navigation system*, refer to page 141.

Displays on the "Trip computer":

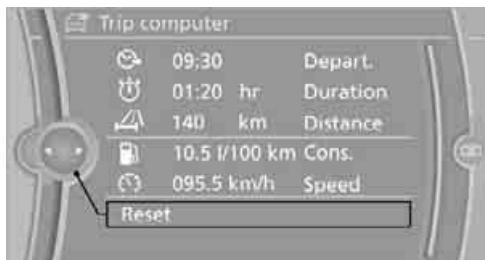

- ▷ Departure time
- ▷ Trip duration
- ▷ Trip distance

Both displays show:

- ▷ The average speed and
- ▷ the average fuel consumption.

Resetting the fuel consumption and speed

You can reset the values for the average speed and average fuel consumption:

1. Select the respective menu item and press the controller.
2. To confirm your selection, press the controller again.

Resetting the Trip computer

You can reset all values:

1. "Vehicle Info"
2. "Trip computer"
3. "Reset"

Service requirements



The remaining driving distance and the date for the next maintenance are displayed briefly with the ignition switched on.

To determine the extent of maintenance required, you can also display the remaining distance or the service date individually in the instrument panel.

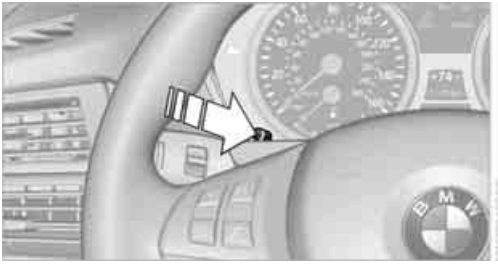

1. With the ignition switched on, press the knob in the instrument panel, refer to page 71, for approx. 5 seconds until the service requirements are displayed.
2. Press the knob repeatedly to display the individual service requirement items.

Displaying service requirements



- 1 Knob for selecting display
- 2 Service requirements
- 3 Engine oil
- 4 Legally mandated inspections*
- 5 Front brake pads
- 6 Rear brake pads
- 7 Brake fluid

The sequence of the displayed maintenance items can vary. First the data for the next maintenance are displayed.

More information

Detailed information on service requirements

More information on the scope of service required can be displayed on the Control Display.

1. "Vehicle Info"
2. "Vehicle status"



3. "Service required"

Required maintenance procedures and legally mandated inspections are displayed.

You can request more detailed information on every entry.

Select the entry and press the controller.

To exit from the menu:

Move the controller to the left.

Symbols

 No service is currently required.

 The deadline for service or a legally mandated inspection is approaching. Please arrange a service appointment.

 The service deadline has already passed.

Entering deadlines for legally mandated inspections*

Make sure the date on the Control Display is set correctly, refer to page 80; otherwise, the effectiveness of CBS Condition Based Service is not ensured.

1. "Vehicle Info"
2. "Vehicle status"
3. "Service required"



4. "§ Vehicle inspection"



5. Open the menu for entering the deadline.
6. "Date:"
7. Create the settings.
8. Press the controller to apply the setting. The year is highlighted.
9. Turn the controller to make the adjustment.
10. Press the controller to apply the setting. The date entry is stored.

To exit from the menu:

Move the controller to the left.

More information on the BMW Maintenance System can be found on page 244.

Automatic Service Notification*

Data regarding the maintenance status or legally mandated inspections of the vehicle are automatically transmitted to your BMW Sports Activity Vehicle Center prior to a service due date.

You can check when your BMW Sports Activity Vehicle Center was notified.

1. "Vehicle Info"
2. "Vehicle status"



3. "Options"
4. "Last Service Request"

Check Control

The concept

The Check Control monitors functions in the vehicle and issues a message if there is a malfunction in the monitored systems. This kind of Check Control message consists of indicator and warning lamps in the instrument cluster, and if necessary an acoustic signal and text messages at the bottom of the Control Display.

Indicator and warning lamps



The indicator and warning lamps can light up in different combinations and colors.



▲ means that a Check Control message has been generated. The symbol continues to be visible even when the Check Control message disappears after a short time. The warning lamps and text messages are stored and can be displayed later, also refer to page 78.

Explanatory text messages

Text messages at the upper edge of the Control Display explain the meaning of the displayed indicator and warning lamps.

For most Check Control messages, you can view more information later, e.g. regarding the cause of a malfunction and how to respond; refer to the information provided below.

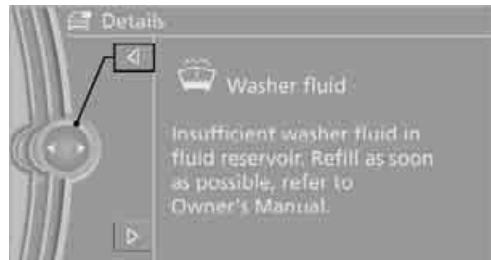

In urgent cases, this information will be shown as soon as the corresponding lamp comes on.

Exit the displayed information:
Move the controller to the left.

Hiding Check Control messages

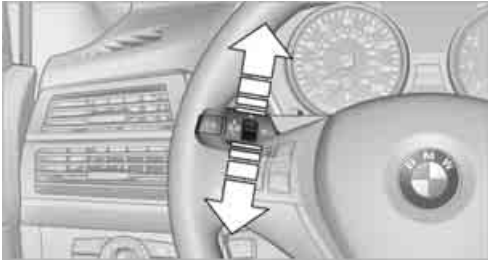

Press the button in the turn signal lever up or down.

Some Check Control messages are displayed until the malfunctions have been rectified. They cannot be hidden. If a number of malfunctions occur simultaneously, they are displayed in succession.

Other messages are automatically hidden after approx. 20 seconds, but remain stored.

Displaying stored Check Control messages



1. Press the button on the turn signal lever downward. "CHECK OK" or the stored Check Control messages appear in the display. "CHECK OK" is shown if no messages are present. Check Control messages are accompanied by text messages on the Control Display.
2. Press the button to display additional messages, the time and outside temperature, or the date.

Displaying stored Check Control messages

1. "Vehicle Info"
2. "Vehicle status"
3. "Check Control"



4. Select the text message.

Speed limit

You can enter a speed and a Check Control message indicates when you have reached this speed. This enables you, for example, to receive warnings if you exceed a speed limit in an urban area.

You are only warned of reaching this speed a second time if your vehicle speed falls below it again by at least 3 mph/5 km/h.

Displaying, setting, or changing speed

1. "Settings"
2. "Speed"
3. "Warning at:"



4. Turn the controller until the desired limit is displayed.
5. Press the controller. The speed limit is stored.

Applying your current speed as limit

1. "Settings"
2. "Speed"
3. "Select current speed"

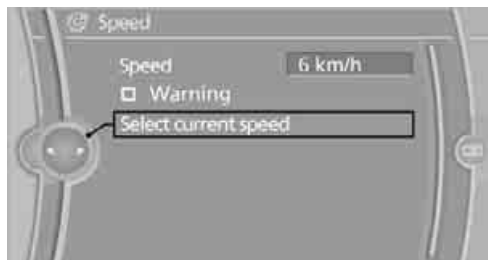

4. Press the controller.

The system applies your current speed as the limit.

Activating/deactivating the limit

1. "Settings"
2. "Speed"
3. "Warning"



4. Press the controller.

The limit warning is switched on.

Settings on Control Display

Setting the time

The settings are stored for the remote control currently in use.

1. Press the **MENU** button.
The main menu is displayed.

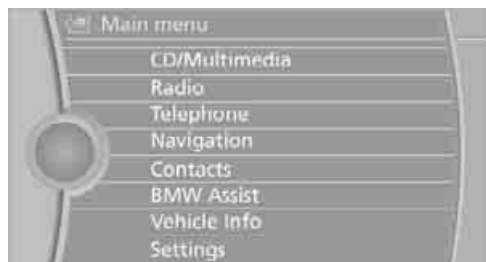

2. "Settings"

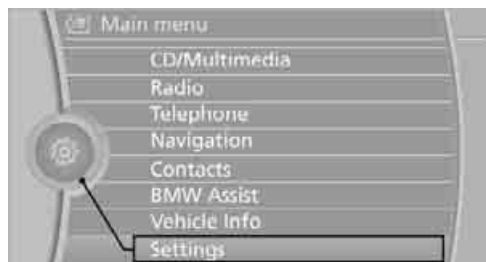

3. "Time/Date"

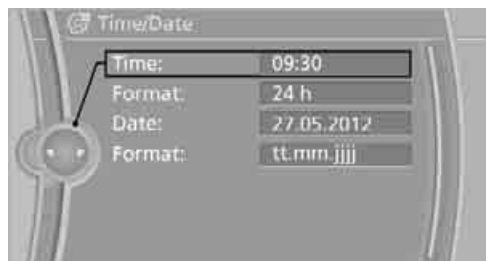

4. "Time:"
5. Turn the controller until the desired hours are displayed, and then press the controller.
6. Turn the controller until the desired minutes are displayed, and then press the controller.

The time is stored.

Setting time format

1. "Settings"
2. "Time/Date"
3. "Format:"
4. Select the desired format and press the controller.

The time format is stored.

Setting date

The settings are stored for the remote control currently in use.

1. "Settings"
2. "Time/Date"
3. "Date:"
4. Turn the controller until the desired day is displayed, and press the controller.
5. Create the necessary settings for the month and year.

The date is stored.

Setting the date format

1. "Settings"
2. "Time/Date"
3. "Format:"



4. Select the desired format.

The date format is stored.

Brightness of Control Display

The brightness is automatically adapted to the ambient lighting conditions. However, you can change the basic setting.

1. "Settings"
2. "Control display"
3. "Brightness"



4. Turn the controller until the desired setting is selected.
5. Press the controller.

The setting is stored for the remote control currently in use. In bright conditions, for example, the brightness control may not be clearly visible.

Setting the units of measure

You can change the units of measure for consumption, distances, temperature and pressure.

1. "Settings"
2. "Language/Units"

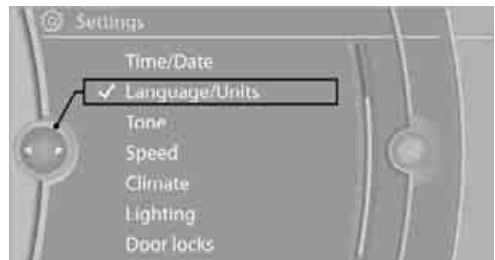

3. Select the desired menu item.
4. Select the desired unit.

The settings are stored for the remote control currently in use.

Language on Control Display

set language

1. "Settings"
2. "Language/Units"
3. "Language:"

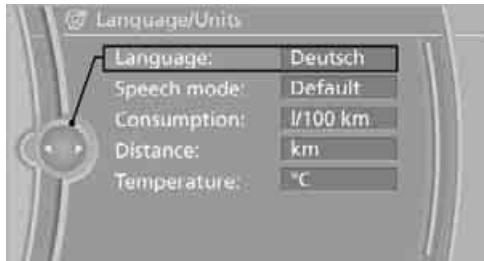

4. Select the desired language.

The setting is stored for the remote control currently in use.

Setting the voice dialog

Switch between a standard dialog and a short dialog.

1. "Settings"
2. "Language/Units"
3. "Speech mode:"
4. Select the desired dialog.

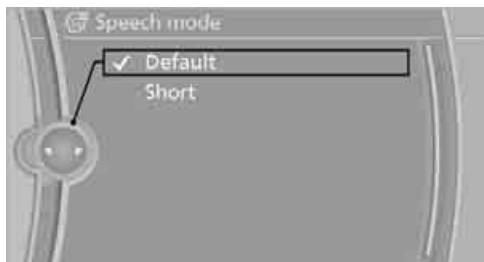

The setting is stored for the remote control currently in use.

Volume of warning tones

You can raise or lower the volume of the warning signals, e.g. the safety belt reminder, in relation to the entertainment sound output. The warning tones have a specified minimum and maximum volume that cannot be dropped below or exceeded.

1. "Settings"
2. "Tone"
3. "Volume settings"

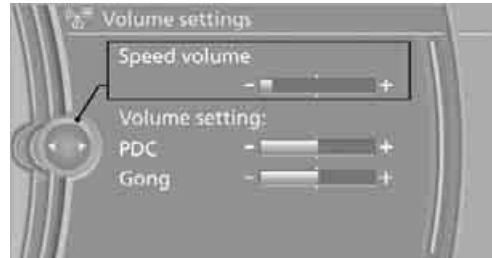

- ▷ "Speed volume": adaptation of the volume as a function of vehicle speed
- ▷ "PDC": volume of the PDC* signal tone in comparison to entertainment sound output
- ▷ "Gong": volume of the signal tone, e.g. for the safety belt reminder, in comparison to entertainment sound output

Technology for comfort, convenience and safety

PDC Park Distance Control*

The concept

In addition to the PDC Park Distance Control, the rear view camera*, refer to page 86, can also be switched on.

PDC assists you during parking. A slow approach to an object in front of or behind your vehicle is announced by:

- ▷ Signal tones
- ▷ Optical displays

Measurement

Ultrasonic sensors in the bumpers carry out the measurement.

Their range is approx. 7 ft/2 m.

The acoustic warning begins:

- ▷ at approx. 24 in/60 cm for the front* sensors and the two rear corner sensors.
- ▷ at approx. 5 ft/1.50 m for the middle sensors in the rear.

System limitations

 PDC cannot replace the personal assessment of the traffic situation. Also make a direct visual check of the traffic situation around the vehicle. Otherwise, there could be a risk of accident, for example due to other road users or objects outside the detection range of PDC.

Loud sources of sound, inside and outside the vehicle, could drown out the PDC signal tone. ◀

 Avoid approaching an object too quickly. Avoid starting off quickly while PDC is not yet activated.

Otherwise, physical circumstances could cause the system to issue a warning late. ◀

Limitations of ultrasonic measurement

The detection of objects can come up against the limitations of physical ultrasonic measurement, for example:

- ▷ when using tow bars and towing hitches
- ▷ in the presence of thin or wedge-shaped objects
- ▷ in the presence of low objects
- ▷ in the presence of objects with corners and sharp edges

Low objects that have already been displayed, e.g. curbs, can disappear again from the detection area of the sensors before or after a continuous tone sounds.

Higher, protruding objects, e.g. ledges, cannot be detected.

False warnings

Under the following conditions, PDC may display a warning even though no obstacle is present in the detection range:

- ▷ in heavy rain
- ▷ when the sensors are heavily soiled or iced-over
- ▷ when the sensors are covered with snow
- ▷ on rough road surfaces
- ▷ in large, rectangular buildings with smooth walls, e.g. underground garages
- ▷ in the presence of heavy exhaust
- ▷ due to the presence of other ultrasonic sources such as street sweepers, steam cleaners, or neon lamps.

Automatic activation

With the engine running or the ignition switched on, shift the selector lever into position R.

Automatic deactivation

The system switches off and the LED goes out:

- ▷ after approx. 165 ft/50 m when driving forward
- ▷ at speeds over approx. 25 mph/35 km/h when driving forward

Switch the system back on as needed.

Switching on/off manually

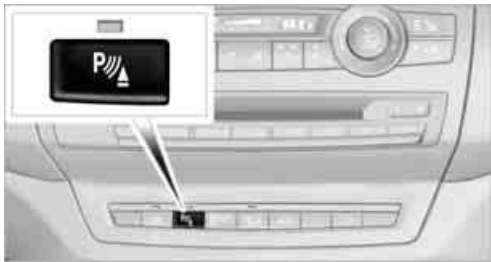

Press the button.

- ▷ On: LED lights up
- ▷ Off: LED goes out

Signal tones

When nearing an object, the position is correspondingly indicated by an interval tone. Thus, an object detected to the left rear of the vehicle will be indicated by a signal tone from the left rear speaker, etc.

The shorter the distance to the object becomes, the shorter the intervals become.

If the distance to the nearest object falls to below roughly 1 ft/30 cm, then a continuous tone sounds.

If objects are present both in front of and behind the vehicle, then an alternating, continuous tone sounds.

An intermittent tone is interrupted after approx. 3 seconds:

- ▷ when the vehicle remains stationary in front of an object that has only been detected by one of the corner sensors
- ▷ when driving parallel to a wall

The signal tone is switched off:

- ▷ when the vehicle is more than approx. 4.0 in/10 cm away from an object
- ▷ when the selector lever is in the P position

Volume

You can adjust the volume of the signal tone, refer to page 81.

The setting is stored for the remote control currently in use.

Optical warning

The approach to an object can be shown on the Control Display. Objects that are farther away are displayed on the Control Display before a signal tone sounds.



The display appears as soon as PDC is activated.

If the last image selected was the rear view camera, this is displayed again. To switch to PDC:

1. Select the "Switch off rear view camera" symbol  on the Control Display.
2. Press the controller.

The setting is stored for the remote control currently in use.

Image on the Control Display

Switching on the rear view camera using iDrive

With PDC activated:

1. Select the "Switch on rear view camera" symbol  .
2. Press the controller.

The image of the rear view camera is displayed. The setting is stored for the remote control currently in use.

Malfunction

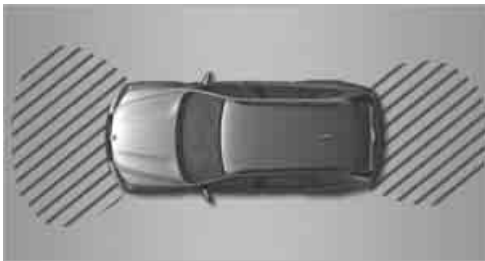

A Check Control message appears in the instrument panel, refer to page 77.

The areas in front of and behind the vehicle appear in shaded form on the Control Display. PDC is malfunctioning. Have the system checked.

In order to assure full functionality:

- ▷ Keep sensors clean and free of ice.
- ▷ Do not spray the sensors with high-pressure cleaners for long periods and keep the spray nozzle at least 12 in/30 cm away from them.

Top View*

The concept

Top View assists you when parking and maneuvering. To accomplish this, the door region and road surface region are shown on the Control Display.

Detection

Detection is carried out by two cameras integrated into the exterior mirror and the rear view camera.

The range is:

- ▷ approx. 7 ft/2 m to the side
- ▷ approx. 7 ft/2 m to the rear

Obstacles up to the height of the exterior mirrors are thus detected in a timely fashion.

System limitations

In the following situations, the function of Top View is limited:

- ▷ when a door is open
- ▷ when the liftgate is open
- ▷ when the exterior mirrors are folded in
- ▷ under poor lighting conditions

The arrows next to the vehicle are displayed in a shaded form on the Control Display and a symbol appears at the corresponding location on the vehicle.

 Also make a direct visual check of the traffic situation around the vehicle. Otherwise, there could be a risk of accident, for example due to other road users or objects outside the image range of the camera. ◀

Automatic activation

With the engine running or the ignition switched on, shift the selector lever into position R.

The images from Top View and PDC are displayed when the system has been switched on using iDrive.

Automatic deactivation

The system switches off and the LED goes out:

- ▷ after approx. 165 ft/50 m when driving forward
- ▷ at speeds over approx. 25 mph/35 km/h when driving forward

Switch the system back on as needed.

Switching on/off manually

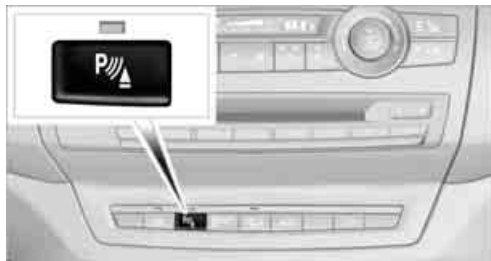

Press the button.

- ▷ On: LED lights up.

- ▷ Off: LED goes out.

If Top View is displayed, switch on the rear view camera using iDrive, refer to page 87.

Optical warning

The approach to an object can be shown on the Control Display.

When the distance to an object is small, the PDC display correspondingly shows a red bar in front of the vehicle.



The display appears as soon as Top View is activated.

If the last image selected was the rear view camera, this is displayed again. To switch to Top View:

1.  Select the "Switch off rear view camera" on the Control Display.
2. Press the controller.

The setting is stored for the remote control currently in use.

Image on the Control Display

Switching on the rear view camera using iDrive

With Top View activated:

1. Select the "Switch on rear view camera" symbol  .
2. Press the controller.

The image of the rear view camera is displayed. The setting is stored for the remote control currently in use.

Brightness

With Top View switched on:

1. Select the  symbol.
2. Turn the controller until the desired setting is displayed and then press the controller.

Contrast

With Top View switched on:

1. Select the  symbol.
2. Turn the controller until the desired setting is displayed and then press the controller.

Displaying turning lines and pathway lines

- ▷ The static, red turning line shows the lateral space required when the wheel is fully turned.
- ▷ The variable, green pathway lines assist you in estimating the amount of lateral space actually required.

The pathway lines depend on the current steering angle and are continuously adapted to movements of the steering wheel.

1. Select the  symbol.
2. Press the controller.

Turning lines and pathway lines are displayed.

Cameras

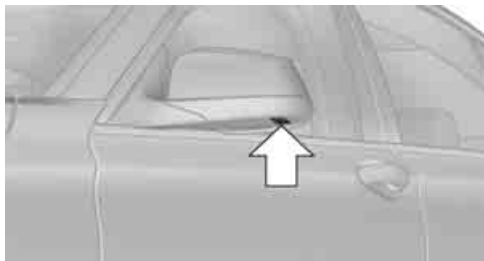

The lenses of the Top View cameras are on the undersides of the exterior mirror housings.

The presence of dirt can impair image quality. Clean the lens with a moist, nonabrasive cloth.

Rear view camera*

The concept

The rear view camera assists you when parking and maneuvering in reverse. To accomplish this, the region behind your vehicle is shown on the Control Display.

System limitations

 Also make a direct visual check of the traffic situation around the vehicle. Otherwise, there could be a risk of accident, for example due to other road users or objects outside the image range of the rear view camera. ◀

 The rear view camera is not able to detect objects at greater heights or protruding objects such as projections from walls. ◀

Automatic activation

With the engine running or the ignition switched on, shift the selector lever into position R.

The image of the rear view camera is displayed when the system has been switched on using iDrive.

Automatic deactivation

The system switches off and the LED goes out:

- ▷ after approx. 33 ft/10 m when driving forward
- ▷ at speeds over approx. 9 mph/15 km/h when driving forward

Switch the system back on as needed.

Switching on/off manually

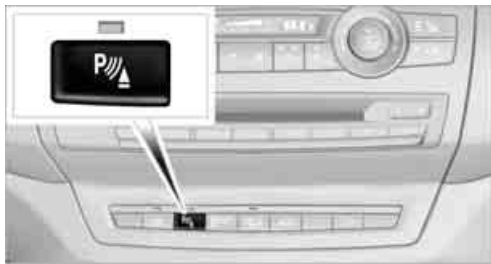

Press the button.

- ▷ On: LED lights up.

- ▷ Off: LED goes out.

If PDC is displayed, switch on the rear view camera using iDrive, refer to page 83.

Assistance functions

Function requirements

- ▷ Rear view camera is switched on.
- ▷ Liftgate is completely closed.

Pathway lines

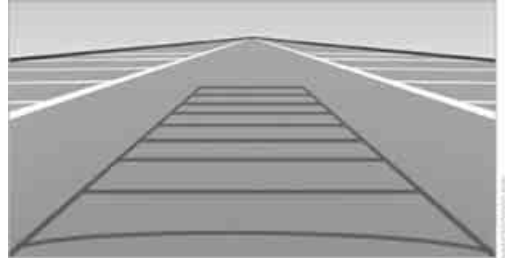

- ▷ Can be displayed in the image of the rear view camera when the transmission is in reverse.
- ▷ Help estimate the required amount of space when parking and maneuvering on a flat road surface.
- ▷ Depend on the current steering angle and are continuously adapted to movements of the steering wheel.

To display parking aid lines using iDrive, refer to page 87.

Turning lines

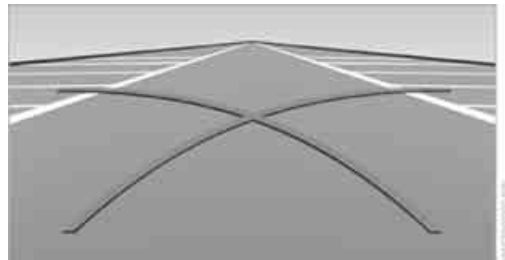

- ▷ Can be displayed in the image of the rear view camera.

- ▷ Show the path of the smallest turning circle on a flat road surface.
- ▷ When the steering wheel is turned, only one turning line is displayed.

To display parking aid lines using iDrive, refer to page 87.

Parking using pathway and turning lines

1. Position the vehicle so that the turning lines lead into the margins of the parking space.

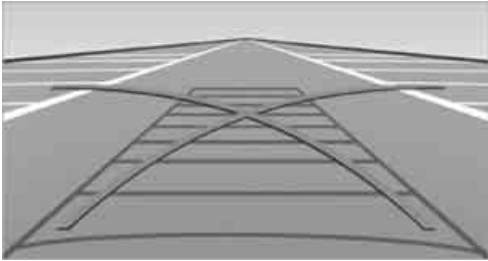

2. Turn the steering wheel so that the pathway lines coincide with the corresponding turning line.

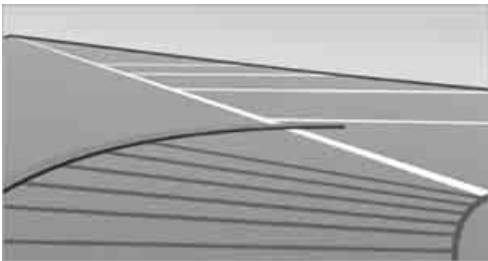

Obstacle marking

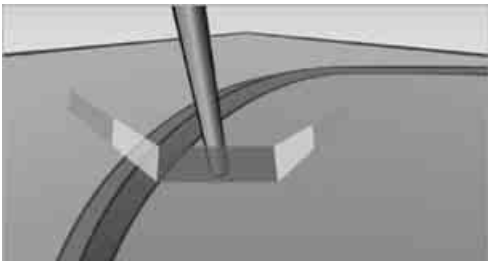

- ▷ Three-dimensionally shaped markings can be displayed in the image of the rear view camera.

Their color gradation corresponds to the markings in PDC. This helps estimate the distance to the object pictured.

To display obstacle marking using iDrive, refer to page 87.

Activating assistance functions

Several assistance functions can be active at the same time.

Displaying parking aid lines

1.  Select the "Parking aid lines" symbol.
2. Press the controller.

Pathway and turning lines are displayed.

Displaying obstacle marking

1.  Select the "Display obstacle marking" symbol.
2. Press the controller.

Three-dimensionally-shaped markings are displayed.

Image on the Control Display

Switching on the rear view camera using iDrive

With PDC activated:

1.  Select the "Switch on rear view camera" symbol.
2. Press the controller.

The image of the rear view camera is displayed. The setting is stored for the remote control currently in use.

Brightness

With the rear view camera switched on:

1. Select the  symbol.
2. Turn the controller until the desired setting is displayed and then press the controller.

Contrast

With the rear view camera switched on:

1. Select the  symbol.
2. Turn the controller until the desired setting is displayed and then press the controller.

Camera



The lens of the rear view camera is under the grasping lip of the liftgate.

The presence of dirt can impair image quality. Clean the lens with a moist, nonabrasive cloth.

Driving stability control systems

Your BMW is equipped with an extended array of systems designed to enhance and maintain vehicle stability under extreme conditions.

ABS Antilock Brake System

ABS prevents locking of the wheels during braking. Safe steering response is maintained even during full braking. Active safety is thus increased.

ABS is operational every time you start the engine. Braking safely, refer to page 132.

CBC Cornering Brake Control

When braking during curves or when braking during a lane change, driving stability and steering response are improved further.

Electronic brake-force distribution

The system controls the brake pressure in the rear wheels to ensure stable braking behavior.

Brake assistant

When you apply the brakes rapidly, this system automatically produces the maximum braking force boost and thus helps to achieve the shortest possible braking distance during full braking. This system exploits all of the benefits provided by ABS.

Do not reduce the pressure on the brake pedal for the duration of the full braking.

DSC Dynamic Stability Control

DSC prevents traction loss in the driving wheels when starting off and accelerating. The system also identifies unstable driving conditions, such as a loss of traction at the rear of the vehicle or sliding of the vehicle in its front wheels. In these cases, DSC helps the vehicle maintain a safe course within physical limits by reducing engine output and through braking actions in the individual wheels.

 The laws of physics cannot be repealed, even with DSC. An appropriate driving style remains the responsibility of the driver. Therefore, do not restrict the additional safety margin with a risky driving style, as otherwise there is a risk of an accident. ◀

Deactivating DSC

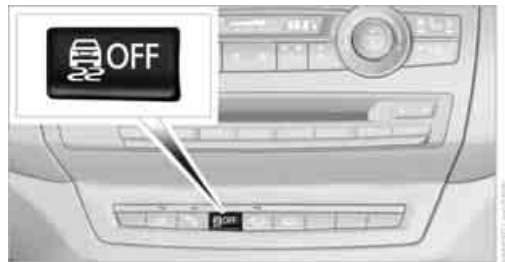

Press and hold the button until the indicator lamp for DSC lights up and DSC OFF appears in the instrument panel, but do not press the button for longer than approx. 10 seconds. DTC Dynamic Traction Control and DSC are deactivated together. Stabilizing interventions are now not carried out.

A message appears on the Control Display. Please note any supplementary information that appears there.

To increase vehicle stability, activate DSC again as soon as possible.

Activating DSC

Press the button: the indicator lamp in the instrument panel goes out.

For better control



The indicator lamp flashes:
DSC is controlling the drive forces and brake forces.



The indicator lamp lights up:
DSC and DTC are malfunctioning.

DSC deactivated:



The indicator lamp lights up and
DSC OFF appears in the instrument
panel.



DSC and DTC deactivated.

DTC Dynamic Traction Control

DTC is a version of DSC in which the drive output is optimized for particular road conditions, e.g. unplowed snow-covered roads. The system assures the maximal drive output, but with reduced driving stability. It is therefore necessary to drive with appropriate caution.

You may find it useful to briefly activate DTC under the following special circumstances:

- ▶ When driving in sand, on snowy inclines, in slush or on unplowed, snow-covered road surfaces

- ▶ When rocking a stuck vehicle free or starting off in deep snow, sand or on loose ground
- ▶ When driving with snow chains*

Activating DTC

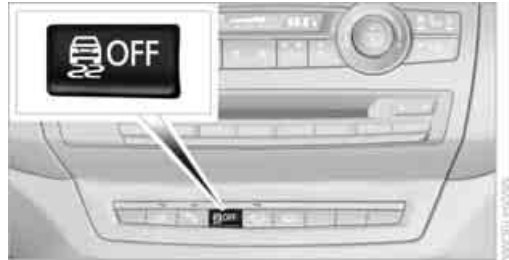

Press the button: the indicator lamp for DSC lights up and TRACTION appears in the instrument panel.

For better control



The indicator lamp flashes:
DTC is controlling the drive forces and brake forces.



The indicator lamp lights up:
DSC and DTC are malfunctioning.

DTC activated:



The indicator lamp lights up and TRAC-
TION appears in the instrument panel.



DTC is activated.

Deactivating DTC

Press the button again: the indicator lamp in the instrument panel goes out.

xDrive

xDrive is the 4-wheel drive system of your BMW. The combined effects of xDrive and DSC further optimize the traction and dynamic driving characteristics. The 4-wheel drive system xDrive variably distributes the drive forces to the front and rear axle depending on the driving situation and prevailing road conditions.

Dynamic Performance Control*

The concept

Dynamic Performance Control optimizes the handling characteristics of your BMW when starting off, cornering, and during evasive maneuvers. To achieve this, the system variably distributes the drive torque of the rear axle to the two rear wheels. This further increases the steering precision and tracking stability of your vehicle.

Display

The Control Display shows how xDrive and Dynamic Performance Control are distributing the drive forces.

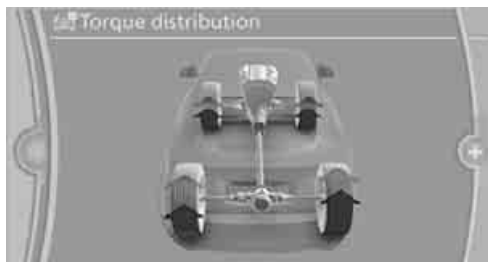

Press the BC button in the turn signal lever, refer to page 73, until the display appears.

The current distribution of drive forces is indicated by arrows pointing to all four wheels.

The highlighted arrows show the drive forces currently present. The longer an arrow is, the greater the drive forces in the associated wheel.

The transparent arrows indicate the maximum value the drive forces over the last 10 seconds.

Malfunction

Malfunctions are displayed via Check Control, refer to page 77.

HDC Hill Descent Control

The concept

HDC is a system for driving downhill in steep terrain. This system reduces vehicle speed on steep downhill gradients, thus allowing you to maintain even better control of your BMW under these conditions. The vehicle moves at approximately walking speed without active intervention from the driver.

HDC is available for activation at vehicle speeds below approx. 22 mph/35 km/h. When driving down steep hills with a speed below approx. 22 mph/35 km/h, the vehicle reduces speed automatically down to approximately walking speed, approx. 5 mph/8 km/h, and then maintains this speed at a constant.

Only use HDC in transmission positions D or R.

Increasing or reducing speed

You can use the accelerator or brakes to vary this automatically controlled speed within a range extending from approx. 4 mph/6 km/h to 15 mph/25 km/h.

You can specify a target speed within the same range by using the lever of the cruise control.

With downhill grade over 10% you can reduce the speed to approx. 3 mph/4 km/h. Pull the lever of the cruise control beyond the resistance point, arrow **3**.



- 1 Increasing speed
- 2 Pull to the resistance point:
Reduce speed to approx. 4 mph/6 km/h

- 3 Pull beyond the resistance point:
With downhill grade over 10%, reduce speed to approx. 3 mph/4 km/h.

Activating HDC

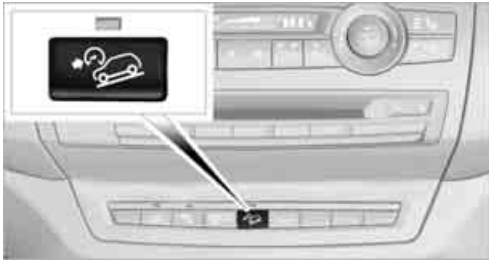

Press the button; the LED lights up.
The HDC display is shown in the instrument panel.

The LED flashes when the brakes are applied automatically.

Deactivating HDC

Press the button again. The LED and the HDC display go out.

HDC is automatically deactivated at speeds over approx. 37 mph/60 km/h.

Displays* in instrument panel



- 1 Display for target speed
- 2 HDC display

Malfunction

HDC is temporarily unavailable in the following situations due to a high brake temperature:

- ▷ The LED in the button and the display HDC go out during HDC operation.

- ▷ The LED in the button and the HDC display do not light up when the button is pressed.

Malfunction of driving stability control systems

- ⚠ When driving on poor roads, avoid using full throttle or pressing the accelerator beyond the kick-down point and also avoid heavy braking. Otherwise, the drive train may be damaged or accidents can occur. ◀

Adaptive Drive*

The concept

Adaptive Drive reduces the body roll which occurs when cornering quickly or during fast evasive maneuvers. In addition, Adaptive Drive reduces the steering angle requirement, improves the running comfort and increases the dynamic driving characteristics of your BMW.

Chassis and suspension tuning

You can choose between two types of chassis and suspension tuning.

- ▷ Normal:
The comfortable basic setting offers optimum comfort when traveling.
- ▷ Sport:
The sporty basic setting offers increased driving agility.

Selecting chassis and suspension tuning



Press the button.

The system switches between the two chassis and suspension tuning settings.

- ▷ Sport:
The LED in the button lights up and SPORT is displayed in the instrument panel.
- ▷ Normal:
The LED in the button goes out.

The selection of the chassis and suspension tuning setting is stored for the remote control currently in use.

Starting assistant

The starting assistant enables you to start off conveniently on slopes. The parking brake is not required for this purpose.

1. Hold the vehicle with the footbrake.
2. Release the footbrake and immediately drive off quickly.

 The starting assistant holds the vehicle for approx. 2 seconds after releasing the footbrake. Depending on the load, the vehicle may also roll back slightly during this time. After releasing the footbrake, immediately start quickly, otherwise the starting assistant no longer holds the vehicle after approx. 2 seconds and it begins to roll back. ◀

Self-leveling suspension*

The concept

The self-leveling suspension on the rear axle assures a continuous ground clearance.

To do so, the height of the vehicle is measured by sensors at both rear wheels.

If the actual height deviates from the defined height, e.g. due to loading of the vehicle, then this difference is compensated for very quickly. In addition, spring motions resulting from cornering or irregularities in the road surface are reduced to a minimum.

The system functions automatically.

Malfunctions

Malfunctions are displayed via Check Control, refer to page 77.

FTM Flat Tire Monitor*

The concept

The Flat Tire Monitor detects a pressure loss in one tire by comparing the speeds of the individual wheels during driving.

In the event of a pressure loss, there is a change in the rolling circumference and therefore the rotation speed of the corresponding wheel. The system detects this change and reports it as a flat tire.

Function requirements

In order to assure the reliable reporting of a flat tire, the system must be initialized for the correct tire inflation pressure.

 The initialization must be repeated after each time the tire inflation pressure is corrected and after every tire or wheel change. ◀

System limits

 The Flat Tire Monitor cannot indicate sudden severe tire damage caused by outside factors and does not detect a natural, even pressure drop in all four tires. ◀

In the following situations, the system could be delayed or malfunction:

- ▷ System has not been initialized
- ▷ Driving on snowy or slippery road surface
- ▷ Sporty driving style: slip in the drive wheels, high lateral acceleration
- ▷ Driving with snow chains*

When you are driving with the compact wheel* the Flat Tire Monitor is unable to function.

Initializing system

 The initialization finishes during driving, which can be interrupted at any time.

When driving resumes, the initialization is continued automatically. Do not initialize the system when driving with snow chains* or with the compact wheel*. ◀

1. "Vehicle Info"
2. "Vehicle status"
3. "Reset"



4. Start the engine – do not drive away.
5. Start the initialization using "Reset".
6. Start to drive.

The initialization finishes during driving. "Status: Flat Tire Monitor active" is displayed again on the Control Display.

Indication of a flat tire

 The warning lamp lights up red. A message appears on the Control Display. In addition, an acoustic signal sounds. There is a flat tire or extensive inflation pressure loss.

If you have deactivated DSC, it will be activated automatically.

1. Cautiously reduce speed to below 50 mph/80 km/h. Avoid sudden braking and steering maneuvers. Do not exceed a speed of 50 mph/80 km/h.

In case of further air loss of the defective wheel, its position will be indicated to you on the Control Display.



If the vehicle is not equipped with run-flat tires as provided at the factory, refer to page 237, do not continue driving. Continuing to drive with a flat tire could cause severe accidents. ◀

2. At the next opportunity, check the air pressure in all four tires.



If the tire inflation pressure in all four tires is correct, the Flat Tire Monitor may not have been initialized. The system must then be initialized. ◀

3. In the event of complete tire pressure loss, 0 psi/0 kPa, you can estimate the possible distance for continued driving on the basis of the following guide values:

- ▷ With a light load:
1 to 2 persons without luggage:
approx. 155 miles/250 km
- ▷ With a medium load:
2 persons, cargo bay full, or
4 persons without luggage:
approx. 95 miles/150 km
- ▷ With a full load:
4 or more persons, cargo bay full:
approx. 30 miles/50 km



Drive cautiously and do not exceed speeds of 50 mph/80 km/h or else you run the risk of causing an accident. In the event of pressure loss, vehicle handling changes. This includes reduced tracking stability in braking, extended braking distance and altered natural steering characteristics.

If unusual vibrations or loud noises occur while the vehicle is being driven, this can indicate final failure of the damaged tire. Reduce speed and stop at a suitable location as soon as possible, otherwise pieces of the tire could become detached and cause an accident. Do not continue driving, but instead contact the BMW Sports Activity Vehicle Center. ◀

Status display

The current status of the Flat Tire Monitor can be displayed on the Control Display, e.g. whether or not the FTM is active.

1. "Vehicle Info"
2. "Vehicle status"
3. "Flat Tire Monitor"



The status is displayed.

TPM Tire Pressure Monitor*

The concept

TPM checks the tire inflation pressure in the four mounted tires. The system reports when the tire inflation pressure has dropped considerably in one or several tires.

Function requirements

In order to assure the reliable reporting of a flat tire, the system must have been reset with the correct tire inflation pressure.

Always use wheels with TPM electronics, otherwise fault-free operation of the system is not ensured.

 Reset the system again after each correction of the tire inflation pressure and after every tire or wheel change. ◀

System limits

 TPM cannot announce sudden serious tire damage caused by external influences. ◀

The system does not function properly if it has not been reset, e.g. a flat tire is reported despite correct tire inflation pressures.

The system is inactive and cannot display a flat tire if a wheel has been mounted without TPM electronics, e.g. a compact wheel*, or if TPM is temporarily interfered with by other systems or devices which use the same radio frequency.

Status display on Control Display

The tire and system status is indicated by the color of the tires.

TPM takes the fact that the tire pressure changes during driving into account. A correction is only required if requested by TPM with the color.

Green

The tire pressure matches the learned set state. "TPM active" is displayed on the Control Display.

One wheel is yellow

Flat tire or a major drop in inflation pressure in the indicated tire. A message appears on the Control Display.

All wheels are yellow

Flat tire or a major drop in inflation pressure in several tires. A message appears on the Control Display.

Gray

The system cannot detect a flat tire.

Reasons for this can be:

- ▷ TPM is being reset
- ▷ Temporary interference due to systems or devices which use the same radio frequency
- ▷ Malfunction

Resetting system

 Reset the system again after each correction of the tire inflation pressure and after every tire or wheel change. ◀

Resetting finishes during driving, which can be interrupted at any time. When driving resumes, resetting is continued automatically.

Do not reset the system when driving with a compact wheel*.

1. "Vehicle Info"
2. "Vehicle status"
3. "Reset TPM"



4. Start the engine – do not drive away.
5. Start the initialization using "Reset TPM".
6. Start to drive.
The tires are shown in gray and "Resetting TPM..." is displayed.

After a few minutes of driving, the set tire inflation pressures in the tires are applied as the set values to be monitored. Resetting finishes during driving. On the Control Display, the tires are shown in green and "Status: TPM active " is displayed again.

 If a flat tire is detected during resetting and applying the tire inflation pressures, all tires are shown in yellow on the Control Display. The message "Low tire!" is shown. ◀

Message with low tire inflation pressure

 The warning lamp lights up yellow. A message appears on the Control Display. In addition, an acoustic signal sounds. There is a flat tire or extensive inflation pressure loss.

1. Cautiously reduce speed to below 50 mph/ 80 km/h. Avoid sudden braking and steering maneuvers. Do not exceed a speed of 50 mph/80 km/h.

 If the vehicle is not equipped with run-flat tires as provided at the factory, refer to page 237, do not continue driving.

Continuing to drive with a flat tire could cause severe accidents. ◀

2. In the event of complete tire pressure loss, 0 psi/0 kPa, you can estimate the possible distance for continued driving on the basis of the following guide values:
 - ▷ With a light load:
1 to 2 persons without luggage:
approx. 155 miles/250 km
 - ▷ With a medium load:
2 persons, cargo bay full, or
4 persons without luggage:
approx. 95 miles/150 km
 - ▷ With a full load:
4 or more persons, cargo bay full:
approx. 30 miles/50 km

 Drive cautiously and do not exceed speeds of 50 mph/80 km/h or else you run the risk of causing an accident. In the event of pressure loss, vehicle handling changes. This includes reduced tracking stability in braking, extended braking distance and altered natural steering characteristics.

If unusual vibrations or loud noises occur while the vehicle is being driven, this can indicate final failure of the damaged tire. Reduce speed and stop at a suitable location as soon as possible, otherwise pieces of the tire could become detached and cause an accident. Do not continue driving, but instead contact the BMW Sports Activity Vehicle Center. ◀

Status display

The current status of the TPM Tire Pressure Monitor can be displayed on the Control Display, e.g. whether or not the TPM is active.

1. "Vehicle Info"
2. "Vehicle status"

3. "Tire Pressure Monitor - TPM"



The status is displayed.

Malfunction



The yellow warning lamp flashes and then lights up continuously. The tires are shown in gray on the Control Display and a message is displayed. No flat tire can be detected.

A message like this is displayed in the following situations:

- ▷ In case of a malfunction:
Have the system checked
- ▷ If a wheel without TPM electronics is mounted, e.g. a compact wheel*
- ▷ If TPM is temporarily interfered with by other systems or devices which use the same radio frequency

Explanation according to the NHTSA/FMVSS 138 Tire Pressure Monitoring Systems

Each tire, including the spare (if provided), should be checked monthly when cold and inflated to the inflation pressure recommended by the vehicle manufacturer on the vehicle placard or tire inflation pressure label. (If your vehicle has tires of a different size than the size indicated on the vehicle placard or tire inflation pressure label, you should determine the proper tire inflation pressure for those tires.)

As an added safety feature, your vehicle has been equipped with a tire pressure monitoring system (TPMS) that illuminates a low tire pressure telltale when one or more of your tires is significantly underinflated. Accordingly, when the low tire pressure telltale illuminates, you

should stop and check your tires as soon as possible, and inflate them to the proper pressure. Driving on a significantly underinflated tire causes the tire to overheat and can lead to tire failure. Underinflation also reduces fuel efficiency and tire tread life, and may affect the vehicle's handling and stopping ability.

Please note that the TPMS is not a substitute for proper tire maintenance, and it is the driver's responsibility to maintain correct tire pressure, even if underinflation has not reached the level to trigger illumination of the TPMS low tire pressure telltale.

Your vehicle has also been equipped with a TPMS malfunction indicator to indicate when the system is not operating properly. The TPMS malfunction indicator is combined with the low tire pressure telltale. When the system detects a malfunction, the telltale will flash for approximately one minute and then remain continuously illuminated. This sequence will continue upon subsequent vehicle startups as long as the malfunction exists. When the malfunction indicator is illuminated, the system may not be able to detect or signal low tire pressure as intended. TPMS malfunctions may occur for a variety of reasons, including the installation of replacement or alternate tires or wheels on the vehicle that prevent the TPMS from functioning properly. Always check the TPMS malfunction telltale after replacing one or more tires or wheels on your vehicle to ensure that the replacement or alternate tires and wheels allow the TPMS to continue to function properly.

Active steering*

The concept

The active steering actively varies the steering angle of the front wheels in relation to the steering wheel movements. In addition, it also varies the steering force required for steering depending on the vehicle's speed.

When you are driving in the low road speed range, e.g. in a town or when parking, the steering angle increases, i.e. the steering becomes

very direct. In the higher speed range, on the other hand, the steering angle is reduced more and more. This improves the handling capability of your BMW over the entire speed range.

In critical situations, the system can make targeted corrections to the steering angle provided by the driver and thus stabilize the vehicle before the driver intervenes.

Malfunction



The warning lamp lights up yellow and a message is shown on the Control Display. The active steering is defective or has been temporarily deactivated. At low speeds, greater steering wheel movements are required, whereas at higher speeds, the vehicle reacts more sensitively to steering wheel movements. The stability-promoting intervention can also be deactivated. Proceed cautiously and drive defensively.

Deactivation

Active steering deactivates in order to carry out an initialization. This deactivation is displayed by means of a message. The initialization can take several minutes.

If the message does not disappear during the current trip, have the system checked.

Defect

In the event of a defect, a corresponding text message is displayed. Have the system checked.

Brake force display*

BMW X5

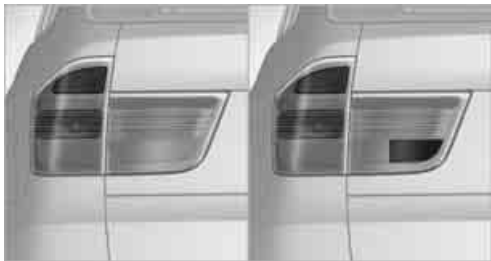

On the left: normal braking.

On the right: heavy braking.

BMW X6

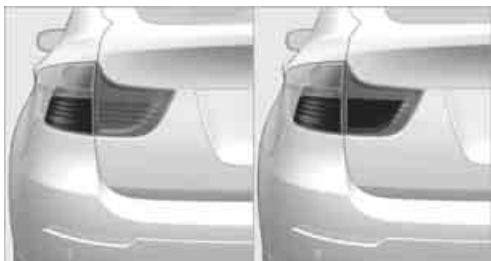

On the left: normal braking.

On the right: heavy braking.

Airbags

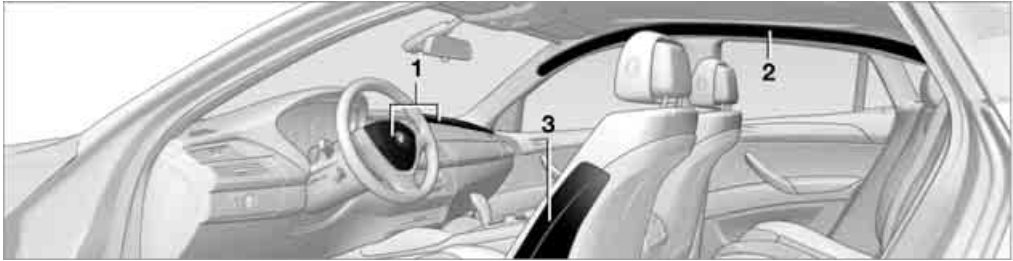

The following airbags are located under the marked covers:

- 1 Front airbags
- 2 Head-level airbags in front and rear
- 3 Side airbags in backrests

Protective action

⚠ To ensure that the safety systems continue to provide optimized protection, observe the adjustment instructions on page 43. ◀

The front airbags help protect the driver and front passenger by responding to frontal impacts in which safety belts alone cannot provide adequate restraint. When needed, the head and side airbags help provide protection in the event of side impact. The relevant side airbag supports the side upper body area. The head air bag supports the head.

The airbags are deliberately not triggered in every impact situation, e.g. less severe accidents or rear-end collisions.

⚠ Do not apply adhesive materials to the cover panels of the airbags, cover them or modify them in any other way.

Keep the instrument cluster and window in the region of the passenger seat free of foreign materials, i.e. do not cover them with adhesive film or covers and do not attach mounts, e.g. for a navigation device or mobile phone to them. Do not install cosmetic covers, seat cushions, or other items on the front seats that are not especially approved for seats with integrated side airbags. Do not hang articles of clothing such as jackets over the backrests.

Do not attempt to remove the airbag restraint system from the vehicle. Do not modify or tamper with either the wiring or the individual components in the airbag system. This includes the upholstery in the center of the steering wheel, on the instrument cluster, the doors, and the roof pillars as well as the sides of the headliner. Do not attempt to remove or dismantle the steering wheel. Do not touch the individual components immediately after the system has been triggered, because there is a danger of burns.

In the event of malfunctions, deactivation, or triggering of the airbag restraint system, have the testing, repair, removal, and disposal of airbag generators executed only by a BMW Sports Activity Vehicle Center or a workshop that works according to BMW repair procedures with correspondingly trained personnel and has the required explosives licenses. Otherwise unprofessional attempts to service the system could lead to failure in an emergency or undesired airbag triggering, either of which could result in personal injury. ◀

Warnings and information on the airbags is also provided on the sun visors.

Automatic deactivation of front passenger airbags

The occupation of the seat is detected by evaluating the impression on the occupied seat surface of the front passenger seat. The front and side airbags on the front passenger side are activated or deactivated accordingly by the system.

▶ The current status of the front passenger airbag, i.e. deactivated or activated, is

indicated by the indicator lamp over the interior rearview mirror, refer to Operating state of front passenger airbags in the following. ◀

 Before transporting a child on the front passenger seat, read the safety information and follow the instructions under Transporting children safely, refer to page 55. When teenagers and adults assume certain sitting positions, this can cause the front and side airbags to deactivate. The indicator lamp for the front passenger airbags lights up when this occurs. In these cases, change the sitting position so that the front passenger airbags are activated and the indicator lamp goes out. If the desired status cannot be produced by changing the sitting position, transport the corresponding person on the rear seat. Do not fit seat covers, seat cushion padding, ball mats or other items onto the front passenger seat unless they are specifically recommended by BMW. Do not lay objects under the seat which could press against the seat from below. Otherwise a correct evaluation of the occupied seat surface cannot be ensured. ◀

Operating state of front passenger airbags



Depending on the vehicle's equipment, the arrangement of the switches and indicator lamps may differ somewhat.

The indicator lamp for the front passenger airbags indicates the operating status of the front and side airbags on the front passenger side depending on the seat occupation. The indicator lamp shows whether the front passenger airbags are activated or deactivated.

- ▶ The indicator lamp lights up when a child in a child restraint device intended for the pur-

pose is properly detected on the seat. The front and side airbags on the front passenger side are not activated.

 Most child's seats are detected by the system. Especially the child's seats required by the NHTSA at the time the vehicle is manufactured. After installing a child's seat, make sure that the indicator lamp for the front passenger airbags lights up. This indicates that the child's seat has been detected and the front passenger airbags are not activated. ◀

- ▶ The indicator lamp does not light up when, for example, a correctly seated person of sufficient height is detected on the seat. The front and side airbags on the front passenger side are activated.
- ▶ The indicator lamp does not light up when the seat is empty. However, the front and side airbags on the front passenger side are not activated.

Operational readiness of airbag system



From radio readiness, refer to page 59, the warning lamp lights up briefly, indicating the operational readiness of the entire airbag system and the safety belt tensioners.

Airbag system malfunction

- ▶ Warning lamp does not light up from radio readiness.
- ▶ Warning lamp lights up continuously.

 Have the airbag system checked immediately in case of a malfunction, otherwise there is a danger that the airbag system may not respond in the expected manner in an accident despite an impact of corresponding intensity. ◀

Head-Up Display*

The concept

With the Head-Up Display important information is projected into the driver's field of view, e.g. navigation instructions. This enables you to take in this information without looking away from the road.



Switching on/off

Press the button.



- 1 Navigation information or Check Control messages
- 2 Cruise control
- 3 Speed

Selecting displays

1. "Settings"
2. "Head-Up display"
3. "Displayed information"
4. Select the desired displays in the Head-Up Display.

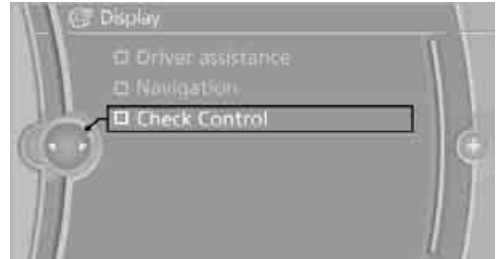

The information is shown on the Head-Up Display.

The settings are stored for the remote control currently in use.

Setting brightness

The brightness of the display is automatically adapted to the ambient lighting conditions. However, you can change the base setting. With the low beams switched on, the brightness can also be adjusted with the thumbwheel of the instrument lighting.

1. "Settings"
2. "Head-Up display"
3. "Brightness"
4. Turn the controller.
The brightness is adjusted.

The setting is stored for the remote control currently in use.

height adjustment

1. "Settings"
2. "Head-Up display"
3. "Height"
4. Turn the controller.
The height is adjusted.

The setting is stored for the remote control currently in use.

Notes

The visibility of the displays in the Head-Up Display is influenced by:

- ▷ Sunglasses with certain polarization filters
- ▷ Certain sitting positions
- ▷ Objects on the cover of the Head-Up Display
- ▷ Wet road surface and unfavorable lighting conditions

If the image is distorted, have the basic setting checked at a BMW Sports Activity Vehicle Center.

Special windshield

The windshield is part of the system. The shape of the windshield complies with the requirements of the Head-Up Display to enable a precise display. A film in the windshield prevents the double images from being displayed.

Windshield replacement should be carried out by a BMW Sports Activity Vehicle Center or a workshop that works according to BMW repair procedures with correspondingly trained personnel.

Care instructions

Important information on this topic is provided on page [249](#).

 Only clean the cover of the Head-Up Display with a soft, lint-free cloth or with a display cleaning cloth, otherwise damage may result. ◀

Lamps

Parking lamps/low beams

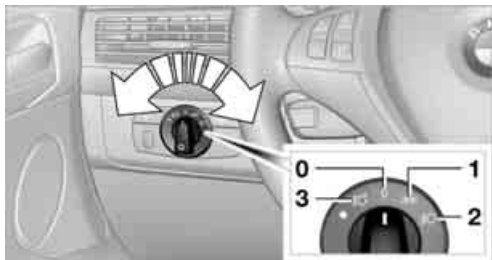

- 0** Lights off and daytime driving lamps*
- 1** Parking lamps and daytime driving lamps*
- 2** Low beams and welcome lamps
- 3** Automatic headlamp control*, daytime driving lamps*, welcome lamps, Adaptive Head Light* and high-beam assistant*

If you open the driver's door with the ignition switched off, the exterior lighting is automatically switched off when the light switch is in position **0**, **2** or **3**.

If necessary, switch on the parking lamps, switch position **1**.

Parking lamps

In switch position **1**, the front, rear and side vehicle lighting is switched on. You can use the parking lamps for parking.

 The parking lamps drain the battery. Do not leave them switched on for long periods of time, otherwise it may no longer be possible to start the engine. It is better to switch on the roadside parking lamps on one side, refer to page [104](#). ◀

Low beams

The low beams light up when the light switch is in position **2** and the ignition is on.

Automatic headlamp control*

In switch position **3**, the system activates the low beams and switches them on or off in

response to changes in ambient light conditions, for instance, in a tunnel, at dawn and dusk and in case of precipitation. Adaptive Head Light* is active. The LED next to the symbol lights up when the low beams are on. You can activate the daytime driving lamps, refer to page [103](#). In the situations named above, the system then automatically switches over to the low beams.

A blue sky with the sun low on the horizon can cause the lights to be switched on.

 The low beams remain switched on independent of the ambient lighting conditions when you switch on the fog lamps*. ◀

 The automatic headlamp control cannot serve as a substitute for your personal judgment in determining when the lamps should be switched on in response to ambient lighting conditions. For example, the sensors cannot detect fog or hazy weather. To avoid safety risks, you should always switch on the low beams manually under these conditions. ◀

Welcome lamps

When parking the vehicle, if you leave the light switch in position **2** or **3**, the parking lamps and the interior lamps light up briefly when the vehicle is unlocked.

Activating/deactivating welcome lamps

1. "Settings"
2. "Lighting"
3. "Welcome light"

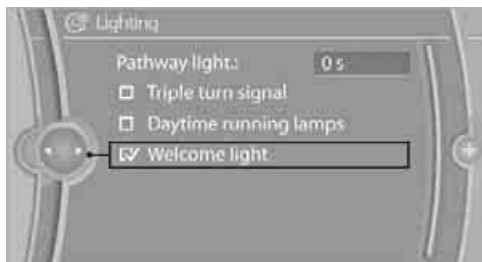

 Welcome lamps are activated and are stored for the remote control currently in use.

Pathway lighting

If you activate the headlamp flasher after switching off the ignition with the lamps switched off, the low beams come on and remain on for a certain time.

Setting the duration or deactivating

1. "Settings"
2. "Lighting"
3. "Pathway light.:"
4. Set a time of duration or 0 s to deactivate the function.



The setting is stored for the remote control currently in use.

Daytime driving lamps*

The daytime driving lamps light up in position **0**, **1** and **3**. If the light switch remains in position **1**, the parking lamps light up after the ignition is switched off.

Activating/deactivating daytime driving lamps

1. "Settings"
2. "Lighting"

3. "Daytime running lamps"



 Daytime driving lamps are activated and are stored for the remote control currently in use.

Adaptive Head Light*

The concept

Adaptive Head Light is a variable headlamp control system that enables better illumination of the road surface. Depending on the steering angle and other parameters, the light from the headlamp follows the course of the road.

In sharp curves, e.g. serpentes, or during turning, up to a speed of approx. 45 mph/70 km/h one of the two fog lamps* is switched on as a turning lamp. This provides improved illumination of the area inside the curve.

Activating Adaptive Head Light

With the ignition switched on, turn the light switch to position **3**, refer to page 102.

The turning lamps are automatically switched on depending on the steering angle or the use of turn signals.

To avoid blinding oncoming traffic, the Adaptive Head Light directs light towards the front passenger side when the vehicle is at a standstill. When driving in reverse, both turning lamps are active.

High beams/ roadside parking lamps

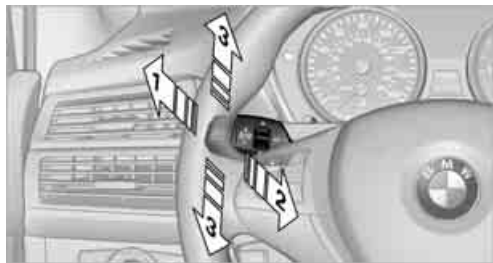

- 1 High beams
- 2 Headlamp flasher
- 3 Roadside parking lamps

Roadside parking lamps, left or right*

You also enjoy the option of lighting up just one side of your vehicle when parking.

Switching on

After parking the vehicle, press the lever up or down beyond the resistance point for approx. 1 second, arrow **3**.

 The roadside parking lamps drain the battery. Do not leave them switched on for long periods of time, otherwise it may no longer be possible to start the engine. ◀

Switching off

Briefly press the lever in the opposite direction up to the resistance point, arrow **3**.

High-beam assistant*

The concept

This system automatically switches the high beams on and off again. The process is controlled by a sensor on the front side of the interior rearview mirror. The Assistant makes sure that the high beams are switched on whenever the traffic situation permits. This relieves you of eyestrain and at the same time offers you the best possible visibility. Naturally, you can inter-

vene at any time and switch the high beams on and off as usual.

Activating system

1. Turn the light switch to position **3**, refer to page 102.
2. With the low beams on, briefly press the turn signal lever toward the high-beam setting.



 The indicator lamp in the instrument panel lights up when the high-beam assistant is activated. The system automatically switches the high beams on and off, reacting not only to oncoming traffic and traffic ahead, but also to sufficient illumination, e.g. in built-up areas.

Switching high beams on and off manually

If you wish or the situation requires it, you can intervene at any time:

- ▷ If the high-beam assistant has switched on the high beams, but you want to use low beams, simply switch them on using the turn signal lever. This deactivates the high-beam assistant. To reactivate the system, briefly press the turn signal lever toward the high-beam position.
- ▷ If the high-beam assistant has switched on the low beams, but you want to use high beams, simply switch them on in the usual way. This deactivates the system and you must switch to low beams manually. To reactivate the system, briefly press the turn signal lever toward the high-beam position.

- ▷ Use the headlamp flasher as usual when the low beams are on.

System limits

⚠ The high-beam assistant cannot replace personal judgment about the use of high beams. In situations that require it, you should therefore switch to low beams manually; failure to do so can constitute a safety hazard. ◀

In the following sample situations, the system will not function or will only function to a limited degree, possibly requiring the driver to react personally:

- ▷ in extremely unfavorable weather conditions such as fog or heavy precipitation
- ▷ when you perceive poorly illuminated road users such as pedestrians, cyclists, horseback riders, carriages, when rail or shipping traffic is close to the road, or at deer crossings
- ▷ in sharp curves, on steep hilltops or dips, when there cross-traffic, or in the presence of half-concealed oncoming traffic on the highway
- ▷ in poorly lit areas and in the presence of highly reflective signs
- ▷ in the low speed range
- ▷ when the windshield in the region of the interior rearview mirror is fogged, dirty, or covered by stickers, decals, etc.
- ▷ when the sensor is dirty. Clean the sensor on the front side of the interior rearview mirror with a cloth moistened with a little glass cleaner.

Switching off using iDrive

1. "Settings"
2. "Lighting"
3. "High beam assistant"



✔ High-beam assistant is activated and is stored for the remote control currently in use.

Fog lamps*



First, switch on the parking lamps or the low beams. The green indicator lamp in the instrument panel lights up whenever the fog lamps are on.

▷ If the automatic headlamp control is activated, the low beams will come on automatically when you switch on the fog lamps. ◀

Instrument lighting



You can control the lighting intensity by using the thumbwheel.

Interior lamps

The interior lamps, footwell lamps*, door entry lighting*, cargo bay lamps, and the courtesy lamps* are controlled automatically.

With the courtesy lamps, LED lights are located in the door handles to illuminate the exterior area before the doors.

 To protect the battery, all lamps in the vehicle are switched off approx. 15 minutes after radio readiness is switched off, refer to Start/Stop button on page 59. ◀

Switching interior lamps on and off manually

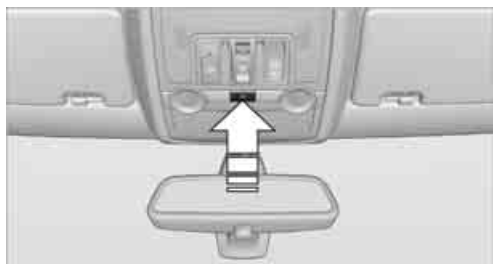

Press the button.

If you wish the interior lamps, footwell lamps, door entry lighting and courtesy lamps to remain switched off all the time, press the button for approx. 3 seconds.

Reading lamps



Reading lamps are provided in the front and rear* adjacent to the interior lamps. Press the button to switch the lamps on and off.

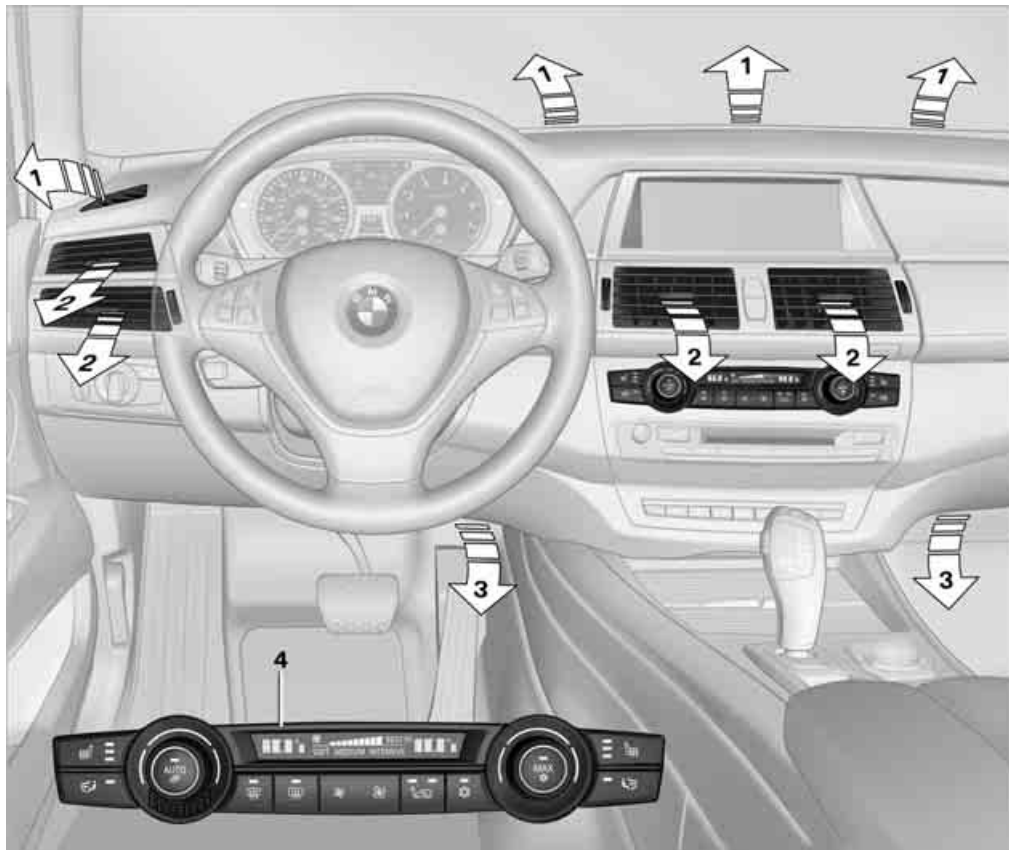

- 1 Air toward the windshield and side windows
- 2 Air for the upper body region, refer to Front ventilation on page [111](#)
- 3 Air to footwell
- 4 Automatic climate control with 2-zone control, refer to page [108](#)
Automatic climate control with 4-zone control, refer to page [112](#)

Automatic climate control with 2-zone control

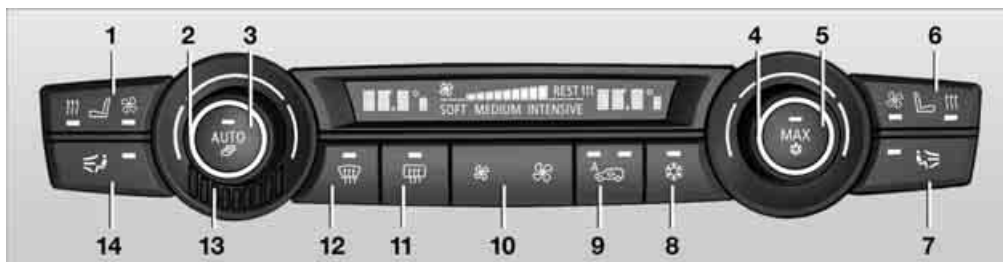

- 1 Seat heating and ventilation, driver's side [51](#)
- 2 Temperature, left side of passenger compartment
- 3 AUTO program
- 4 Temperature, right side of passenger compartment
- 5 Maximum cooling
- 6 Seat heating and ventilation, front passenger side [51](#)
- 7 Passenger side
 - ▷ Air distribution, manual
 - ▷ Accessing setting for ventilation temperature on the Control Display
- 8 Switching cooling function on and off manually
- 9 AUC Automatic recirculated-air control/ recirculated-air mode
- 10 Manual air volume, switching off automatic climate control, residual heat
- 11 Rear window defroster
- 12 Defrosting windows and removing condensation
- 13 Air grill for interior temperature sensor – please keep clear and unobstructed
- 14 Driver's side
 - ▷ Air distribution, manual
 - ▷ Accessing setting for ventilation temperature on the Control Display

The current setting for manual air distribution is displayed on the Control Display.

A congenial climate

The AUTO program offers the optimum air distribution and air volume for virtually all conditions, refer to AUTO program below. Now you only need to select an interior temperature pleasant to you.

The following sections contain more detailed information on the available setting options.

Most settings are stored for the remote control currently in use, also refer to Personal Profile settings on page [26](#).

AUTO program



The AUTO program handles the adjustment of air volume and air distribution to the windshield and side windows, in the direction of the upper body and in the footwell.

It also adapts your instructions for the temperature to outside influences throughout the year.

The cooling is switched on automatically with the AUTO program. At the same time, a condensation sensor controls the program in such a way that window condensation is prevented as much as possible.

Intensity of AUTO program

You can adjust the intensity of the AUTO program by repeatedly pressing the AUTO button. When you press the button on the display of the automatic climate control, the current setting appears on the Control Display.



Select the intensity of the AUTO program:

- ▷ – Low
- ▷ – Medium
- ▷ – High

Temperature



Set the desired temperature individually on the driver's and front passenger side.

The automatic climate control adjusts this temperature as quickly as possible at any time of year, if necessary with the maximum cooling or heating capacity, and then keeps it constant.

In the highest setting you activate the maximum heating capacity, regardless of the outside temperature. And in the lowest setting, the maximum cooling capacity.

When switching between different temperature settings in rapid succession, the automatic climate control does not have sufficient time to adjust the set temperature. ◀

Adapting Ventilation temperature

This function allows you to adapt the interior temperature separately for the driver and passenger when the automatic climate control is switched off.

Use the controller on the Control Display to adjust the ventilation temperature.

To accomplish this, the access the Ventilation temperature setting manually via the buttons for air distribution, refer to page 108, or via iDrive.

1. "Settings"
2. "Climate"
3. Select "Driver ventilation" or "Front passenger ventilation".
4. Turn the controller to adjust the temperature.
 - ▷ Turn toward blue: colder
 - ▷ Turn toward red: warmer



Defrosting windows and removing condensation



Quickly remove ice and condensation from the windshield and front side windows.

To do this, also switch on the cooling function.

Rear window defroster



The rear window defroster switches off automatically after a while. Depending on the vehicle equipment, upper wires are used as an antenna and are not part of the rear window defroster.

Air volume, manual



You can vary the air volume by pressing on the corresponding side. You can reactivate the automatic mode for the air volume with the AUTO button.

Air distribution, manual

You can use various programs to separately direct the emerging airflow to the driver and passenger side of the vehicle interior.

- ▷ Upper body region
- ▷ Upper body region and footwell
- ▷ Footwell
- ▷ Driver's side: also the windshield, side windows, and footwell

Selecting program



Press the button repeatedly until the desired program is shown on the Control Display.

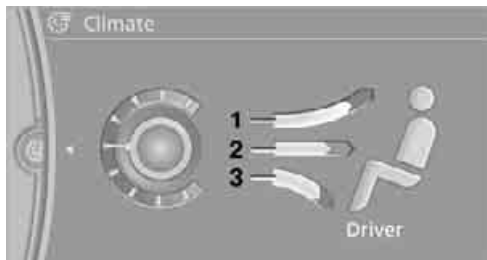

- 1 Air toward the windshield and side windows
- 2 Air for the upper body
- 3 Air to footwell

▶ Pressing the AUTO button cancels the manual air distribution settings. ◀

The automatic mode for the air volume remains effective with manual air distribution.

Switching cooling function on and off



The cooling function cools and dehumidifies the incoming air before also reheating it as required, according to the temperature setting. This function is only available when the engine is running.

The cooling function helps to avoid condensation on the window surfaces or to quickly remove them.

Depending on the weather, the windshield may fog over briefly when the engine is started.

The cooling function is switched on automatically with the AUTO program.

Maximum cooling



Maximally cooled air is obtained as quickly as possible at an outside temperature above approx. 32 °F / 0 °C and with the engine running.

The automatic climate control switches into the recirculated-air mode at the lowest temperature. The maximum air volume flows out of the air vents for the upper body. Therefore, open these vents for maximum cooling.

AUC Automatic recirculated-air control/recirculated-air mode



You can respond to pollutants or unpleasant odors in the immediate environment by suspending the supply of outside air. The system then recirculates the air currently within the vehicle. During AUC operation, a sensor detects pollutants in the outside air and controls the shut-off automatically.

By pressing the button repeatedly, you can request three operating modes:

- ▷ LED off: outside air flows in continuously.
- ▷ Left LED on, AUC mode: the system detects pollutants in the outside air and shuts off the supply as needed.
- ▷ Right LED on, recirculated-air mode: the supply of outside air is permanently shut off.



Should the windows fog up in the recirculated-air mode, press the AUTO button or switch off the recirculated-air mode and increase the air volume if necessary.

The recirculated-air mode should not be used without interruption over an extended period of time, as the air quality inside the vehicle deteriorates continuously. ◀

Residual heat

The heat stored in the engine is used to heat the passenger compartment, e.g. while stopped at a school to pick up a child.

Switching on



Pressing the right side switches on the residual heat utilization when the following conditions are met:

- ▷ up to 15 minutes after switching off the engine
- ▷ with the engine at operating temperature
- ▷ with sufficient battery voltage
- ▷ at an outside temperature below 77 °F / 25 °C

REST appears on the display of the automatic climate control when the residual heat utilization is switched on.

From radio readiness the interior temperature, the air volume and the air distribution can be set.

Switching off

You can select the lowest blower speed by pressing and holding the left side. Pressing again switches off the residual heat utilization. REST disappears from the display of the automatic climate control.

Switching automatic climate control on and off



You can select the lowest blower speed by pressing and holding the left side. Pressing again switches off the automatic climate control.

You switch on the system again by pressing any button of the automatic climate control.

Front ventilation



- 1 Thumbwheels to smoothly open and close air vents
- 2 Levers to change the air vent direction



Do not drop any foreign objects into the air vents, otherwise these could be catapulted outwards and lead to injuries. ◀

Ventilation for cooling

Adjust the air vents to direct the flow of cool air in your direction, for instance, if the interior has become too warm, etc.

Draft-free ventilation

Set the air vents so that the air flows past you and is not directed straight at you.

Ventilation in rear

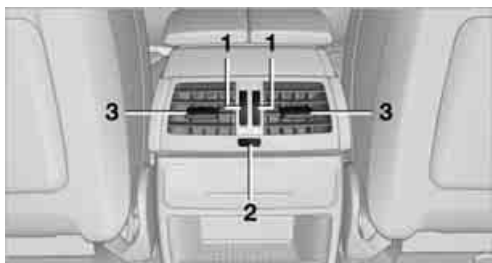

- 1 Thumbwheels to smoothly open and close air vents
- 2 Thumbwheel for adjusting the temperature in the upper body region:
 - ▷ Turn toward blue: colder
 - ▷ Turn toward red: warmer
- 3 Levers to change the air vent direction

BMW X5: heating and ventilation, 3rd row seats

The air in the area of the 3rd row seats can be heated or recirculated. Air vents are located in the storage compartment area between the seats and in the footwell of the 3rd row seats.



1 Thumbwheel:

- ▷ Activating heating and distributing air in footwell:
Turn toward front
- ▷ Distributing air in storage compartment area between seats:
Turn toward rear

2 Button for switching on blower: LED lights up

▶ The heating is not ready for operation without switching on the blower. After the heating is switched off, the blower can be used to recirculate the air within the vehicle, e.g. at high temperatures. To do this, turn the thumbwheel **1** toward the rear and switch on the blower, button **2**. ◀

Microfilter/activated-charcoal filter

The microfilter removes dust and pollen from the incoming air. The activated-charcoal filter provides additional protection by filtering gaseous pollutants from the outside air. This combined filter is changed during maintenance by your BMW Sports Activity Vehicle Center. You can select a display of more detailed information on the Control Display, refer to page 74.

Automatic climate control with 4-zone control*

Front operation

Corresponds to the operation of the automatic climate control with 2-zone control, refer to page 108.

Rear operation

The control unit is located in the center console in the rear.



- 1 Temperature, left rear seating area
- 2 AUTO program
- 3 Display
- 4 Temperature, right rear seating area
- 5 Seat heating, right rear seat
- 6 Air volume, manual
- 7 Seat heating, left rear seat

The current setting for the temperature and the air volume is shown on display **3**.

Activating/deactivating

1. "Settings"
2. "Climate"
3. "Rear climate"

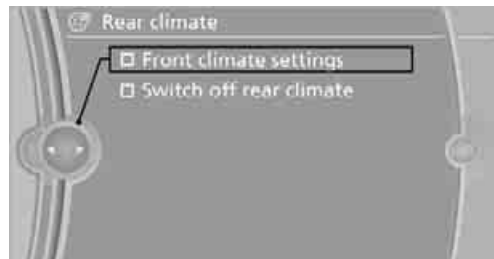

- Select the desired settings and press the controller.

 Function is activated.

 The rear automatic climate control cannot be operated if the front automatic climate control is switched off. With the defrost windows and eliminate condensation function activated, the rear automatic climate control is also not ready for operation. ◀

AUTO program



The AUTO program assumes the adjustment of the air distribution toward the upper body and in the footwell, as well as the air volume for you. It also adapts your instructions for the temperature to outside influences throughout the year.

Temperature



Set the desired temperature individually on the left and right side.

The automatic climate control adjusts this temperature as quickly as possible at any time of year, if necessary with the maximum cooling or heating capacity, and then keeps it constant.

 When switching between different temperature settings in rapid succession, the automatic climate control does not have sufficient time to adjust the set temperature. ◀

Air volume, manual



You can vary the air volume by pressing on the corresponding side. You can reactivate the automatic mode for the air volume with the AUTO button.

Switching off rear automatic climate control



You can select the lowest blower speed by pressing and holding the left side. Pressing again switches off the automatic climate control.

 The automatic climate control can also be switched off with iDrive. To switch on the automatic climate control again, the system must first be reactivated, refer to Activating/deactivating. ◀

You switch on the system again by pressing any button of the rear automatic climate control.

Ventilation in rear

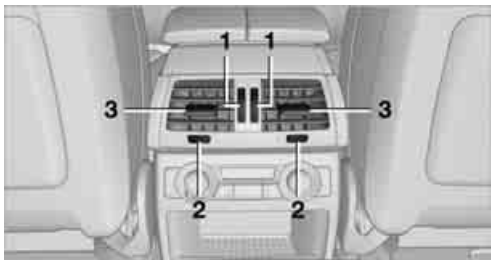

- Thumbwheels to smoothly open and close air vents
- Thumbwheels to adjust temperature in upper body region; can be adjusted separately for left and right:
 - ▶ Turn toward blue: colder
 - ▶ Turn toward red: warmer
- Levers to change the air vent direction

BMW X5

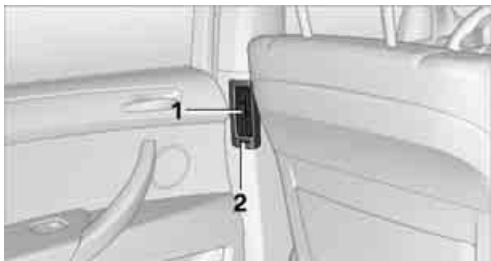

- Levers to change the air vent direction
- Thumbwheel to smoothly open and close air vents

For information on the ventilation of the 3rd row seats, refer to page 112.

Parked-car ventilation*

The concept

The parked-car ventilation blows air into the passenger compartment to lower interior temperatures.

It is ready to use in the parked car mode at any outside temperature.

You can set two different times for the system to start. The parked-car ventilation can also be switched on and off directly. It remains switched on for 30 minutes.

Since the system uses a substantial amount of electrical current, you should refrain from activating it twice in succession without allowing the battery to be recharged in normal operation between use.

The air emerges through the upper body region air vents in the instrument cluster. Therefore, please open the air vents.

The parked-car ventilation is operated via iDrive.

Switching on and off directly

1. "Settings"
2. "Climate"
3. "Activate parked-car vent."

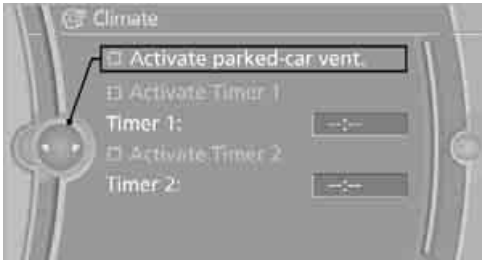

The parked-car ventilation is switched on.

The ☞ symbol on the display of the automatic climate control flashes.

Preselecting activation times

1. "Settings"
2. "Climate"
3. "Activate Timer 1" or "Activate Timer 2"
4. "Timer 1:" or "Timer 2:"

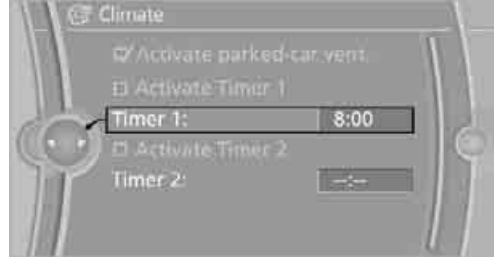

5. Turn the controller: set the hours.
6. Press the controller: the setting is accepted.
7. Turn the controller: set the minutes.
8. Press the controller: the setting is accepted.

The activation time is activated.

The ☞ symbol on the display of the automatic climate control lights up.

The ☞ symbol on the display of the automatic climate control flashes when the parked-car ventilation has switched on.

The parked-car ventilation is only available for activation within the next 24 hours. Then it must be activated again. ◀

Only one activation time can be activated at a time.

Integrated universal remote control*

The concept

The integrated universal remote control can replace as many as three hand-held transmitters for various remote-controlled accessories, such as garage and gate or lighting systems. The integrated universal remote control registers and stores signals from the original hand-held transmitters.

The signal of an original hand-held transmitter can be programmed on one of the three memory buttons **1**. Then with the ignition switched on, this programmed memory button **1** can be used to operate the respective feature. The LED **2** flashes to confirm transmission of the signal.

Should you sell your vehicle one day, be sure to delete the stored programs beforehand for your safety, refer to page **116**.

 To prevent possible damage or injury, before programming or using the integrated universal remote control, always inspect the immediate area to make certain that no people, animals or objects are within the travel range of the device. Also, comply with the safety precautions of the original hand-held transmitter. ◀

Checking compatibility

 If you see this symbol on the packaging or in the manual supplied with the original hand-held transmitter, it is safe to assume that it is compatible with the integrated universal remote control.

 Should you have additional questions, please contact your BMW Sports Activity Vehicle Center or call: 1-800-355-3515. Information is also provided on the Internet at: www.bmwusa.com or www.homelink.com.

HomeLink is a registered trademark of Johnson Controls, Inc. ◀

Programming

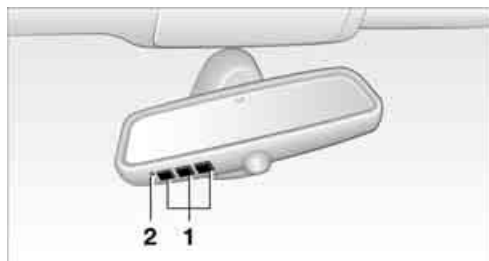

- 1 Memory buttons
- 2 LED

Fixed-code hand-held transmitters

1. Switch on ignition, refer to page **59**.
2. When starting operation for the first time: press the left and right-hand memory button **1** for approx. 20 seconds until the LED **2** flashes quickly. All stored programs are deleted.
3. Hold the original hand-held transmitter at a distance of approx. 4 in/10 cm to 12 in/30 cm from the memory buttons **1**.
 The required distance between the hand-held transmitter and the memory buttons **1** depends on the relevant system of the original hand-held transmitter used. ◀
4. Simultaneously press the transmit button on the original hand-held transmitter and the desired memory button **1** on the integrated universal remote control. The LED **2** flashes slowly at first. As soon as the LED **2** flashes rapidly, release both buttons. If the LED **2** does not flash rapidly after approx. 15 seconds, alter the distance and repeat the step.
5. To program other original hand-held transmitters, repeat steps 3 and 4.

The corresponding memory button **1** is now programmed with the signal of the original hand-held transmitter.

You can operate the device when the engine is running or when the ignition is switched on.

▶ If the device cannot be used after repeated programming, check whether the original hand-held transmitter uses an alternating-code system. To do so, either read the instructions for the original hand-held transmitter or hold down the programmed memory button **1** of the integrated universal remote control. If the LED **2** on the integrated universal remote control flashes rapidly for a short time and then remains lit for approx. 2 seconds, this indicates that the original hand-held transmitter uses an alternating-code system. In the case of an alternating-code system, program the memory buttons **1** as described at Alternating-code hand-held transmitters. ◀

Alternating-code hand-held transmitters

To program the integrated universal remote control, consult the operating instructions for the equipment to be set. You will find information there on the possibilities for synchronization.

When programming hand-held transmitters that employ an alternating code, observe the following supplementary instructions:

▶ Programming will be easier with the aid of a second person. ◀

1. Park your vehicle within the range of the remote-controlled device.
2. Program the integrated universal remote control as described above in the section Fixed-code hand-held transmitters.
3. Locate the button on the receiver of the device to be set, e.g. on the drive unit.
4. Press the button on the receiver of the device to be set. After step 4, you have approx. 30 seconds for step 5.
5. Press the programmed memory button **1** of the integrated universal remote control three times.

The corresponding memory button **1** is now programmed with the signal of the original hand-held transmitter.

▶ Should you have questions, please contact your BMW Sports Activity Vehicle Center. ◀

Deleting all stored programs

Press the left and right-hand memory button **1** for approx. 20 seconds until the LED **2** flashes quickly:

All stored programs are deleted.

Reassigning individual programs

1. Hold the original hand-held transmitter at a distance of approx. 4 in/10 cm to 12 in/30 cm from the memory buttons **1**.
 - ▶ The required distance between the hand-held transmitter and the memory buttons **1** depends on the relevant system of the original hand-held transmitter used. ◀
2. Press the desired memory button **1** of the integrated universal remote control.
3. When the LED **2** flashes slowly after approx. 20 seconds, press the transmit button of the original hand-held transmitter. Release both buttons as soon as the LED **2** flashes rapidly. If the LED **2** does not flash rapidly after approx. 15 seconds, alter the distance and repeat the step.

Digital compass*



- 1 Adjustment button
- 2 Display

The display indicates the cardinal or intercardinal direction in which you are currently driving.

Operating principle

You can run various functions by pressing the adjustment button with a pointed object, e.g. a ball-point pen etc. The following setting options are displayed consecutively, depending on how long the adjustment button is pressed:

- ▷ Press briefly: switch display on/off
- ▷ 3 to 6 seconds: set compass zone
- ▷ 6 to 9 seconds: calibrate compass
- ▷ 9 to 12 seconds: set left/right-hand drive vehicle
- ▷ 12 to 15 seconds: set language

Setting compass zones

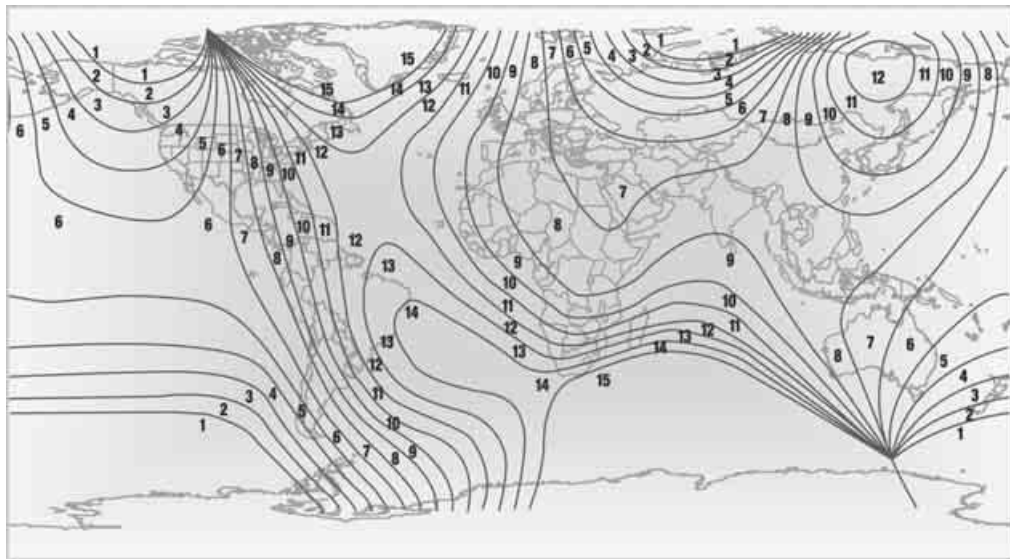

Set the respectively applicable compass zone in your vehicle so that the compass functions properly, refer to the map of the world with compass zones.

To set the compass zones, press the adjustment button for approx. 3-4 seconds. The display indicates the number of the currently set compass zone.

To change the zone setting, briefly press the adjusting button repeatedly until the number of the compass zone that applies to your current position is displayed.

The compass will be operational again after approx. 10 seconds.

Calibrating digital compass

Calibrate the digital compass in the following situations:

- ▷ The wrong cardinal direction appears on the display.
- ▷ The cardinal direction displayed does not change despite a change in the direction of travel.
- ▷ Not all cardinal directions are displayed.

Procedure

1. Make sure that there are no large metal objects or overhead power lines in the vicinity of your vehicle and that you have enough space to drive in a circle.
2. Enter the currently applicable compass zone.
3. Press the adjustment button for approx. 6-7 seconds to display C. Then drive in a complete circle at least once at a maximum speed of 4 mph/7 km/h. If the calibration is successful, display C is replaced with the points of the compass.

Setting right/left-hand drive vehicle

Your digital compass is already set to right or left-hand drive vehicle to match your vehicle at the factory.

Setting language

You can set the language of the display.

Press the adjustment button for approx. 12-13 seconds. Briefly press the adjustment button again to change between English "E" and German "O".

The setting is automatically stored after approx. 10 seconds.

Roller sun blinds for rear side windows*

Pull the loop of the roller sun blind and hook onto bracket.

 Do not open the window with the roller blind raised, as otherwise there is a dan-

ger of damage, and therefore a danger of injuries at higher speeds. ◀

Glove compartment

Opening

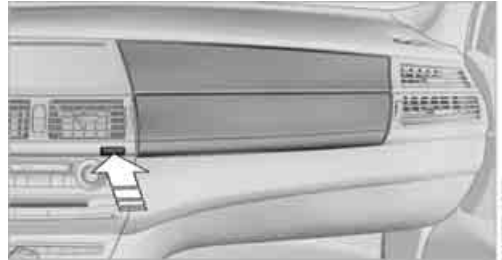

Press the button. The covers open upward and downward and the lighting in the glove compartment switches on.

 To prevent injury in the event of an accident while the vehicle is being driven, close the glove compartment immediately after use. ◀

Closing

Press one of the two covers closed.

USB interface for data transmission



Port for importing and exporting data on USB devices, e.g. music collections, refer to page 178.

Observe the following when connecting:

- ▷ Do not use force when plugging the connector into the USB audio interface.
- ▷ Do not connect devices such as fans or lamps to the USB audio interface.

- ▷ Do not connect USB hard disks.
- ▷ Do not use the USB interface to recharge external devices.

Center armrest front

A storage compartment is located under the armrest between the front seats and, depending on the vehicle's equipment, also a cover for the mobile phone bracket or the snap-in adapter. Also refer to page 202.

Opening cover



Push cover down slightly and press the button. The cover folds upward.

Connection for external audio device

You can connect an external audio device such as a CD or MP3 player and play audio tracks over the vehicle's speaker system:

- ▷ AUX-IN connection, refer to page 183
- ▷ USB audio interface, refer to page 183

Storage compartments

Compartments are located in the doors, in the center console in the front and rear* as well as in the rear console in the X6.

Storage nets* are located on the backrests of the front seats.

⚠ Do not stow hard or sharp-edged objects in the storage nets; otherwise there is an increased risk of injury in the event of an accident. ◀

Clothes hooks

⚠ When hanging clothing on the hooks, ensure that it will not obstruct the driver's vision. Do not hang heavy objects on the hooks. If you do so, they could cause personal injury to occupants during braking or evasive maneuvers. ◀

BMW X5

Clothes hooks are located near the grab handles in the rear.

BMW X6

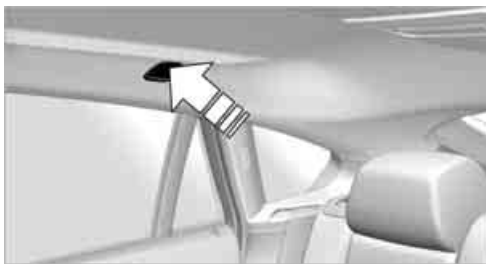

To fold out, press against upper edge.

Cup holders

⚠ Use lightweight, unbreakable containers and do not transport hot beverages; otherwise, there is an increased risk of injury in the event of an accident. Do not force unsuitable containers into the cup holders, as otherwise damage can result. ◀

Front



Slide the cover back.

Rear

BMW X5



Unlock the center armrest with the button in the lower section of the opening and fold down.

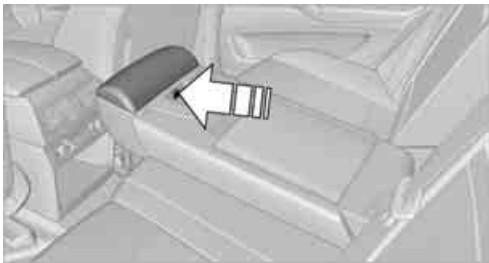

Press the button; the cover folds forward.
With the 3rd row seats*:

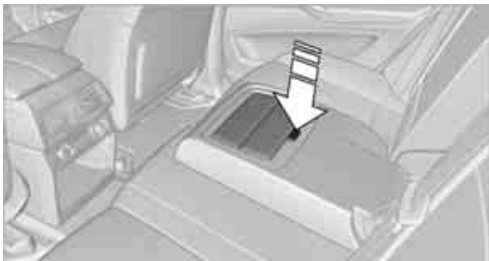

Fold down the center armrest.
Press the button; the cup holders are opened.
The cup holders of the 3rd row seats are located in the center console between the seats.

BMW X6



Slide the cover forward.

 Remove the beverage container before folding the rear seat backrest forward or using the ski bag; otherwise it may cause damage. ◀

Ashtray

Front

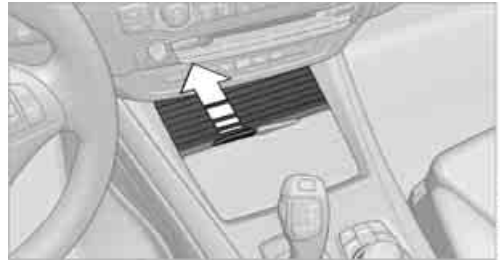

To open the cover, slide it forward.

Rear

BMW X6



Slide the cover back.
Remove the insert to empty.

Lighter

Front



Press in the lighter with the engine running or the ignition switched on.

The lighter can be removed as soon as it pops back out.

⚠ Hold or touch the hot cigarette lighter by the knob only. Holding or touching it in other areas could result in burns.

Always take along the remote control when you leave the vehicle, otherwise children could, for example, use the lighter and burn themselves. ◀

Rear



Refer to Cigarette lighter, front.

Connecting electrical devices

Sockets

With the engine running or the ignition switched on, the cigarette lighter socket can be used as a power outlet for hand flashlights, car vacuum cleaners, etc., with power ratings of up to approx. 200 W at 12 V. Avoid damaging the socket due to inserting plugs of different shapes or sizes. The same is true for all power outlets in the vehicle.

In cargo bay

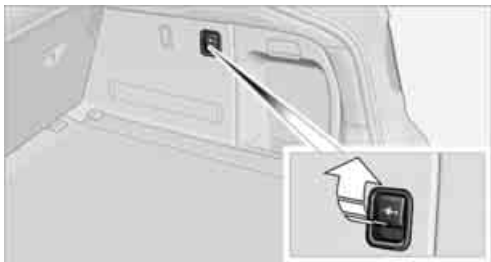

Access to socket:
Fold open the cover.

In rear center console



Depending on your vehicle's equipment package, the socket in the rear is covered with a cap or equipped with a lighter. Refer to Cigarette lighter, front, page 121.

Access to socket:
Remove cap or lighter.

In storage compartment under center armrest

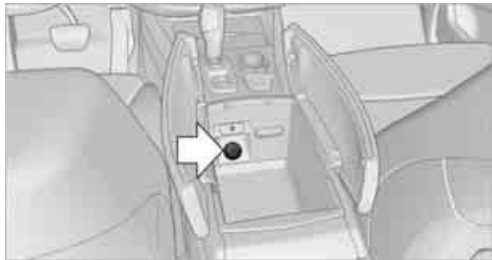

Access to socket*:
Pull off the cover.

BMW X6: in rear console



Slide the cover back.
Access to socket:
Pull off the cover.

Rear center armrest

BMW X6 and BMW X5 with 3rd row seats*



Pull on the loop and fold down the center armrest.

BMW X5 without 3rd row seats*



Unlock the center armrest with the button in the lower section of the opening and fold down.

Cargo bay

BMW X5: roll-up cover

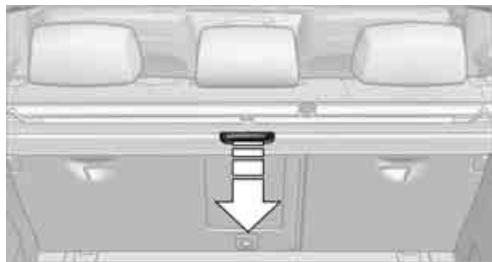

Pull out the roll-up cover and hook it into the brackets.

 Do not place heavy or hard objects on the roll-up cover. If you do so, they may already pose a danger to vehicle occupants during braking or evasive maneuvers.

Do not allow the roll-up cover to snap back, otherwise it can be damaged. ◀

Removing

1. Unlock the case with the button, arrow 1.

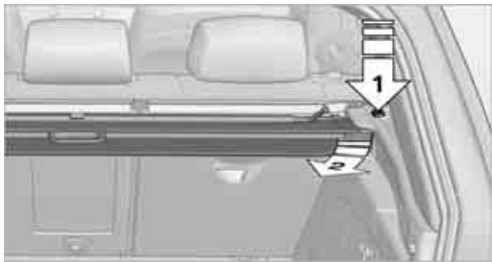

2. Swing the case somewhat to the left, arrow 2, and remove.

Installing

When installing, proceed in the opposite order of removal.



1. Lay on the case on the left-hand side and push it forward, arrow 1.
2. Swing the case toward the inside, refer to arrow 2.
3. Push the case forward at the ends until it engages in the two side brackets.
4. Check whether the case is properly locked in place by pulling it with a sudden movement.

BMW X6: cargo bay cover

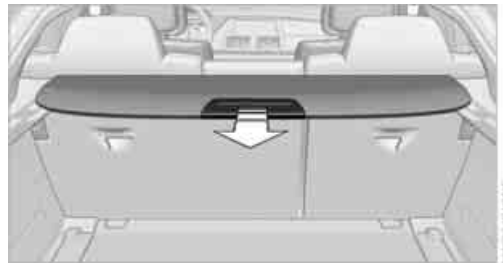

Deploy cargo bay cover by pulling back.

 Do not place heavy or hard objects on the cargo bay cover. If you do so, they may pose a danger to vehicle occupants during braking or evasive maneuvers. ◀

Removing

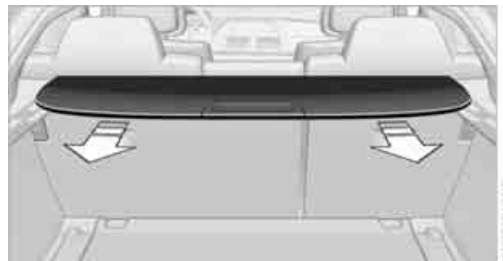

1. Grasp retracted cargo bay cover underneath the upper fold on both sides.
2. Pull the cover back out of the side brackets.
3. Depending on your vehicle's equipment package, you can store the cover under the floor panel in the cargo bay.



Installing

When installing, proceed in the opposite order of removal.

1. Set the cargo bay cover into place on the left and right sides.
2. Lift the back of the cover slightly and slide forward until it snaps into the two side brackets.

Expanding cargo bay

The rear seat backrest is divided. You can fold down both sides separately in order to expand the cargo bay.

 BMW X6: before folding the rear seat backrest forward or using the ski bag, remove beverage containers from the cup holder and close the cup holder. ◀



Reach into the recess and pull toward the front.

 When you fold back the backrest, be sure that the catch engages securely. The red warning indicator disappears in the recess when the catch is engaged. If it is not properly engaged, transported cargo could enter the passenger compartment during braking or evasive maneuvers and endanger the vehicle occupants. ◀

 To ensure that the safety systems continue to provide optimized protection, observe the safety belt information on page 43. ◀

Storage compartments in cargo bay

Depending on the vehicle's equipment, the following storage compartments are provided in the cargo bay.

- ▷ Storage compartments behind the removable side panels on the right and left side of the cargo bay* and under the floor panel flap, storage compartment* right side of cargo bay.
- ▷ Storage tray* under the floor panel flap, capacity approx. 21 US gal/80 liter.
- ▷ Retaining straps* on the left and right side panel for securing small objects.
- ▷ Lashing rail with lashing eyes*. You can secure heavy-duty cargo straps on the lashing eyes. They can be removed at the notches in the rails. To move the lashing eyes, press the button.

 Read and comply with the information enclosed with the heavy-duty cargo straps. ◀

Floor panel flap

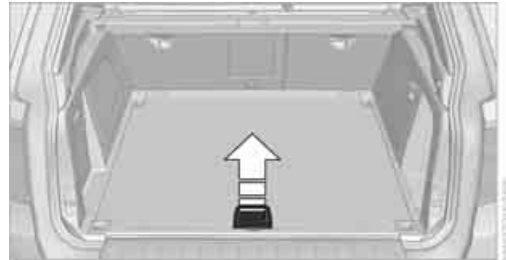

To access the onboard toolkit etc.

To open, swing up the flap by the handle, refer to arrow.

The floor panel flap can be locked*.

Adaptive fixing system*

The adaptive fixing system is used to divide up the cargo bay. It consists of two brackets with a telescopic rail and retaining straps. These are guided into the two rails on the cargo bay floor.

! Before using the adaptive fixing system, fold up and lock the rear seat backrest; otherwise, the cargo could be thrown into the vehicle interior in an accident. ◀

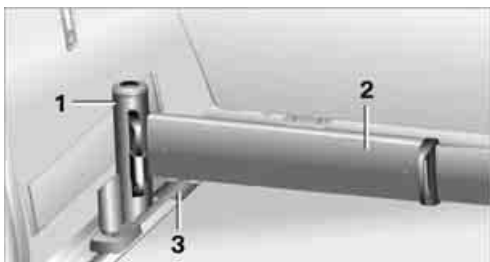

- 1 Brackets
- 2 Telescopic rail
- 3 Notch in the cargo bay rail

Mounting brackets

The two brackets are connected with a telescopic rail.

1. Insert the brackets at the respective notch in the rail on the cargo bay floor.
2. Press down the brackets to push them into the desired position.
3. Check the firm seating of the brackets. They must be clearly heard to engage.

! Do not lay cargo on the brackets, as otherwise they could be unlocked. ◀

Dividing up cargo bay

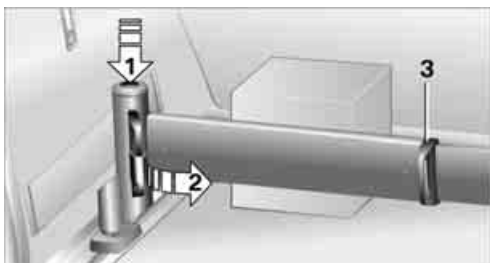

You can position the cargo as follows:

- ▷ between the rear seat backrest and the telescopic rail
- ▷ between the telescopic rail and the retaining strap

Positioning cargo between telescopic rail and retaining strap:

1. Lay the cargo on the telescopic rail. Press the button, arrow 1, and route the retaining strap around the cargo, arrow 2.
2. Hook the retaining strap into the mount 3 on the telescopic rail.
3. Press the button of the bracket, arrow 1. The retaining strap is tensioned.

▷ You can also hook both retaining straps into each other. ◀

When you are finished using the adaptive fixing system, unhook the retaining strap and guide it back into the bracket in order to prevent damage and injury.

Then slide the fastening system toward the front in order to permit the best possible use of the cargo bay.

Removing brackets

Press down the brackets, slide them up to the notches of the rails and remove them.

Depending on your vehicle's equipment package, you can store the adaptive fixing system under the floor panel in the cargo bay.

Ski bag*

The ski bag is designed for safe, clean transport of up to 4 pairs of standard skis or up to 2 snowboards.

With the ski bag you can stow skis with a length of up to 6.9 ft/2.10 m. When skis of 6.9 ft/2.10 m in length are loaded, the ski bag will tend to contract, reducing its overall capacity.

! Before loading the ski bag, fold in the display screen of the DVD system in the rear*, as otherwise the display screen could be damaged. ◀

Loading

1. Fold down the center armrest, press the button and open the cover.

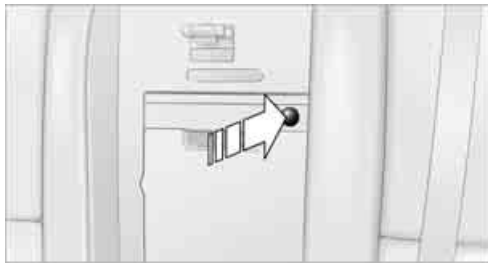

2. Press the button again; the cover in the cargo bay opens. If you press the button firmly the first time, this cover also opens.
3. Extend the ski bag between the front seats and fill it. The zipper facilitates access to the stowed items and drying of the ski bag.
4. BMW X5: insert the latch plate of the ski bag retaining strap into the center safety belt buckle that is marked CENTER.



BMW X6: attach the hook of the ski bag retaining strap to the eyelet on the rear seat backrest.



Only stow clean skis in the ski bag. Wrap sharp edges to prevent damage.

Securing cargo

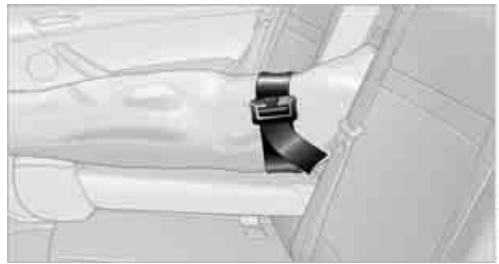

After loading, secure the ski bag and its contents. Tighten the retaining strap on the tensioning buckle for this purpose.

 Secure the ski bag in this way. If you fail to do so, it could endanger occupants during braking or evasive maneuvers. ◀

To store the ski bag, perform the above steps in reverse order.

Removing ski bag

The ski bag can be completely removed, e.g. for faster drying or to allow you to put it to other uses.

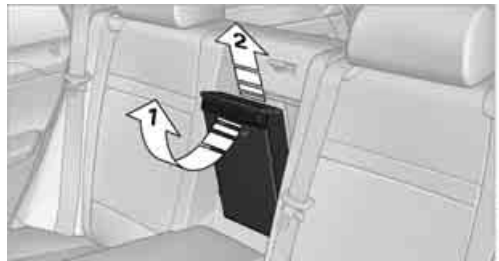

1. Pull the handle toward the front, arrow 1.
2. Take out the ski bag upward, arrow 2.
3. Close the cover in the cargo bay.

 Details on various inserts are available from your BMW Sports Activity Vehicle Center. ◀



Driving tips

This section is designed to provide you with extra support by supplying information useful in dealing with specific driving and operating conditions.

Things to remember when driving

Break-in period

Moving parts need breaking-in time to adjust to each other. To ensure that your vehicle continues to provide optimized economy of operation throughout an extended service life, we request that you devote careful attention to the following section.

Engine and rear axle differential

Always obey all official speed limits.

Up to 1,200 miles/2,000 km

Drive at various engine and vehicle speeds, but do not exceed:

- ▷ Gasoline engine
4,500 rpm or 100 mph/160 km/h
- ▷ Diesel engine
3,500 rpm or 90 mph/150 km/h

Avoid full-throttle operation and use of the transmission's kick-down mode during these initial miles.

From 1,200 miles/2,000 km

The engine and vehicle speed can gradually be increased.

Tires

Due to technical factors associated with their manufacture, tires do not achieve their full traction potential until after an initial break-in period. Therefore, drive reservedly during the first 200 miles/300 km.

Brake system

Brakes require an initial break-in period of approx. 300 miles/500 km to achieve optimized contact and wear patterns between brake pads and rotors. Drive in a reserved manner during this break-in period.

Following part replacement

Observe the break-in instructions again if components mentioned above must be replaced after subsequent driving operation.

Saving fuel

The fuel consumption of your vehicle depends on various factors. Through a few simple steps, your driving style, and regular maintenance, you can have a positive influence on your fuel consumption and environmental impact.

Removing unnecessary cargo

Additional weight increases fuel consumption.

Removing add-on parts after use

Remove unneeded auxiliary mirrors, roof or rear luggage racks after use. Add-on parts attached to the vehicle impede the aerodynamics and increase the fuel consumption.

Closing windows and glass sunroof*/panorama glass sunroof*

An open glass sunroof/panorama glass sunroof or open windows likewise increase the drag coefficient and therefore the fuel consumption.

Checking tire inflation pressures regularly

Check and correct the tire inflation pressure as needed at least twice a month and before long trips.

An insufficient tire inflation pressure increases the rolling resistance and thus increases the fuel consumption and tire wear.

Driving off immediately

Do not allow the engine to warm up by leaving it running while the vehicle remains stationary. Instead, begin to drive at a moderate engine

speed. This is the fastest way for the cold engine to reach its operating temperature.

Thinking ahead when driving

Avoid unnecessary acceleration and braking. To do so, maintain the appropriate distance from the vehicle in front of you. An anticipatory and smooth driving style reduces fuel consumption.

Avoiding high engine speeds

Driving at a low engine speed reduces fuel consumption and minimizes wear.

Taking advantage of coasting

The flow of fuel is interrupted when coasting.

Switching off engine during longer stops

Switch off the engine at longer stops such as traffic signals, railroad crossings, or in traffic congestions. You achieve fuel savings even if the standing time is as short as approx. 4 seconds.

Switching off functions currently not required

Functions such as air conditioning, seat heating, or rear window defrosting consume a lot of energy and require additional fuel. Their influence is particularly pronounced in city traffic and stop & go operation. For this reason, it is a good idea to switch these functions off when they are not really needed.

Having maintenance carried out

Have the vehicle serviced regularly in order to achieve the optimum economy and service life of your vehicle. BMW recommends having the maintenance performed by a BMW Sports Activity Vehicle Center. Also pay attention to the BMW maintenance system, refer to page 244.

General driving notes

Closing liftgate



Operate the vehicle only when the liftgate is completely closed. Otherwise, exhaust fumes could enter into the passenger compartment. ◀

If it is absolutely necessary to drive with the liftgate open:

1. Close all windows as well as the glass sunroof*/panorama glass sunroof*.
2. Increase the air volume of the automatic climate control to a high level, refer to page 109.

Hot exhaust system



As in all vehicles, extremely high temperatures are generated on the exhaust system. Do not remove the heat shields installed adjacent to it, and never apply undercoating to them. When driving, standing at idle and while parking take care to avoid possible contact between the hot exhaust system and any highly flammable materials such as hay, leaves, grass, etc. Such contact could lead to a fire, and with it the risk of serious property damage as well as personal injury. Do not touch hot tailpipes, as otherwise there is a danger of burns. ◀

Diesel particulate filter*

Soot particles are collected in the diesel particulate filter and periodically burned away at high temperatures. This cleaning process lasts a few minutes. You will notice it sometimes by the fact that the engine temporarily runs slightly less smoothly and requires a slightly higher engine speed to deliver the usual power. You may also hear sounds and observe a slight amount of smoke coming from the exhaust up to even a few moments after the engine is switched off.

Hydroplaning

 When driving on wet or slushy roads, reduce road speed. If you do not, a wedge of water can form between tires and road surface. This phenomenon is referred to as hydroplaning, and is characterized by a partial or complete loss of contact between the tires and the road surface, ultimately undermining your ability to steer and brake the vehicle. ◀

The risk of hydroplaning increases as the tread depth of the tires decreases, also refer to Minimum tread depth on page 236.

Driving through water

Maximum water depth:

- ▷ BMW X5 20 in/50 cm
- ▷ BMW X6 17 in/45 cm

 Only drive through water up to the above-mentioned depth at no greater than walking speed; otherwise, the engine, electrical system, and transmission can be damaged. ◀

Braking safely

Your BMW is equipped with ABS as a standard feature. In situations that require it, it is best to brake with full force. Since the vehicle maintains steering responsiveness, you can still avoid possible obstacles with a minimum of steering effort.

Pulsation of the brake pedal, combined with sounds from the hydraulic circuits, indicate that ABS is in its active mode.

 Do not drive with your foot resting on the brake pedal. Even light but consistent pedal pressure can lead to high temperatures, brake wear and possibly even brake failure. ◀

Driving in wet conditions

When roads are wet or there is heavy rain, briefly exert gentle pressure on the brake pedal every few miles. Monitor traffic conditions to ensure that this maneuver does not endanger other road users. The heat generated in this process helps dry the pads and rotors to ensure that full braking efficiency will then be available when you need it.

Hills

 To prevent overheating and the resulting reduced efficiency of the brake system, drive long or steep downhill gradients in the gear in which the least braking is required. Even light but consistent pressure on the brake pedal can lead to high temperatures, brake wear and possibly even brake failure. ◀

The braking effect of the engine can be further increased by downshifting in the manual mode of the automatic transmission, if necessary into first gear, refer to page 65. This prevents an excessive strain on the brakes.

 Do not drive in idle or with the engine stopped, otherwise there will be no engine braking action or support of the braking force and steering. Never allow floor mats, carpets or any other objects to protrude into the area of movement of the pedals and impair their operation. ◀

Corrosion on brake rotors

When the vehicle is driven only occasionally, during extended periods when the vehicle is not used at all, and in operating conditions where brake applications are less frequent, there is an increased tendency for corrosion to form on rotors, while contaminants accumulate on the brake pads. This occurs because the minimum pressure which must be exerted by the pads during brake applications to clean the rotors is not reached.

Should corrosion form on the brake rotors, the brakes will tend to respond with a pulsating effect that even extended application will fail to cure.

When vehicle is parked

Condensation forms in the automatic climate control system during operation, and then exits under the vehicle. Traces of condensed water under the vehicle are therefore normal.

Loading

 To avoid loading the tires beyond their approved carrying capacity, never overload the vehicle. Overloading can lead to overheating and increases the rate at which damage develops inside the tires. The ultimate result can assume the form of a sudden blow-out. ◀

 Make sure that no fluids leak in the cargo bay; otherwise the vehicle could be damaged. ◀

Determining loading limit



1. Locate the following statement on your vehicle's placard*:

 The combined weight of occupants and cargo should never exceed **YYY lbs.** or **XXX kg.** Otherwise, this could damage the vehicle and produce unstable vehicle operating conditions. ◀

2. Determine the combined weight of the driver and passengers that will be riding in your vehicle.
3. Subtract the combined weight of the driver and passengers from **YYY lbs.** or **XXX kg.**
4. The resulting figure equals the available amount of cargo and luggage load capacity. For example, if the **YYY** amount equals 1,400 lbs. and there will be five 150 lbs. passengers in your vehicle, the amount of available cargo and luggage load capacity is 650 lbs.:
1,400 lbs. minus 750 lbs. = 650 lbs.

5. Determine the combined weight of luggage and cargo being loaded on the vehicle. That weight may not safely exceed the available cargo and luggage load capacity calculated in step 4.
6. If your vehicle will be towing a trailer, part of the load from your trailer will be transferred to your vehicle. Consult the manual for transporting a trailer to determine how this may reduce the available cargo and luggage load capacity of your vehicle.

Load

BMW X5:

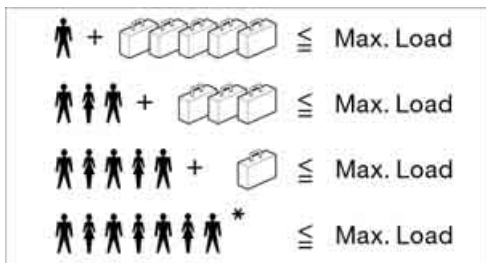

BMW X6:

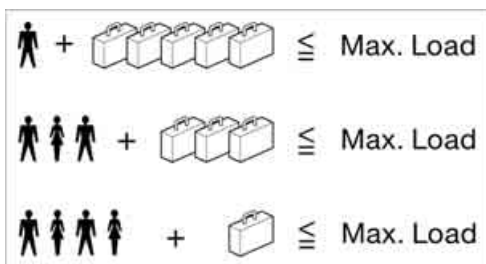

The permissible load is the total of the weight of occupants and cargo/luggage. The greater the weight of occupants, the less cargo/luggage can be transported.

Stowing cargo

BMW X5

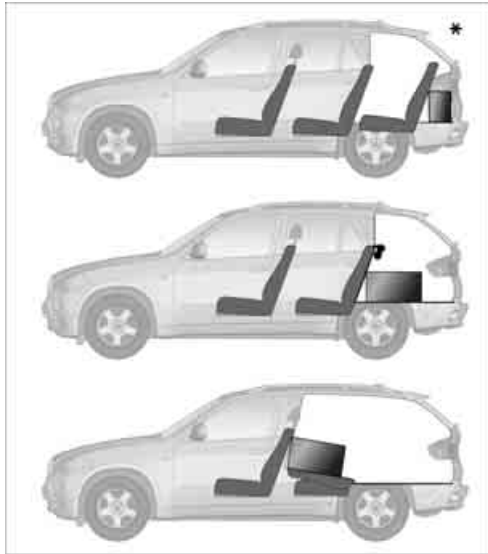

BMW X6

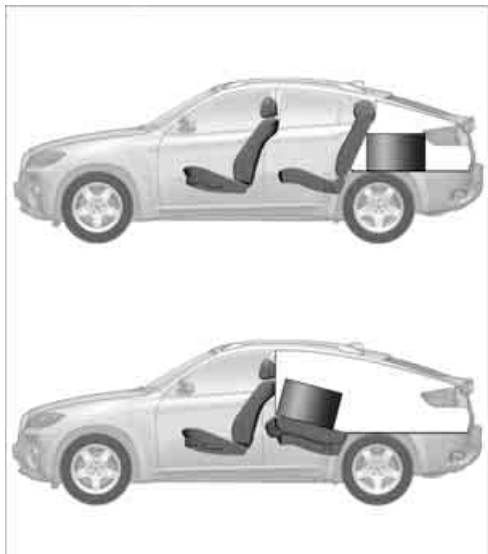

- ▷ Load heavy cargo as far forward and as low as possible, placing it directly behind the backrest.
- ▷ Cover sharp edges and corners.

- ▷ When transporting very heavy cargo with unoccupied rear seats, insert the safety belts, the outer safety belts in the BMW X5, into the buckles on the opposite sides.
- ▷ Do not pile objects higher than the top edge of the backrest.
- ▷ Wrap sharp-edged or pointed objects which could strike the rear window while driving.

Securing cargo

BMW X5

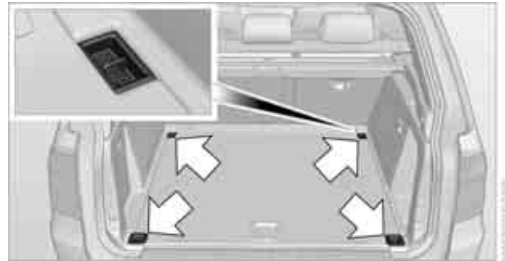

BMW X6

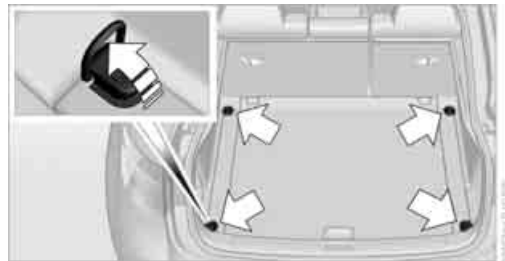

- ▷ Use the luggage net*, retaining straps*, or securing straps to hold down small and lightweight luggage and cargo.
 - ▷ For larger and heavier pieces, heavy-duty cargo straps* are available from your BMW Sports Activity Vehicle Center. Four lashing eyes* mounted in the cargo bay are used to secure these heavy-duty cargo straps, refer to illustrations.
 - ▷ Observe the special instructions supplied with the heavy-duty cargo straps.
-  Position and secure the cargo as described above, so that it cannot endan-

ger the car's occupants, for example if sudden braking or evasive maneuvers are necessary. Never exceed either the approved gross vehicle weight or either of the approved axle weights, refer to page 271, as excessive loads can pose a safety hazard, and may also place you in violation of traffic safety laws.

You should never transport unsecured heavy or hard objects in the passenger compartment, as they could fly around and pose a safety hazard to the vehicle's occupants during abrupt braking or evasive maneuvers.

Use only the lashing eyes pictured to fasten the heavy-duty cargo straps. Do not secure cargo with the attachment points for the top tether, refer to page 56; otherwise they could be damaged. ◀

Roof-mounted luggage rack*

A special rack system is available as an option for your BMW. Please comply with the precautions included with the installation instructions.

Loading roof-mounted luggage rack

Because roof racks raise the vehicle's center of gravity when loaded, they have a major effect on its handling and steering response. You should therefore always remember not to exceed the approved roof load capacity, the approved gross vehicle weight or the axle weights when loading the rack.

You can find the specified weights under Weights on page 271.

The load on the roof must be evenly distributed and must not extend outward beyond the limits of the loading surface. Always stow the heaviest pieces on the bottom. Be sure that adequate clearance is maintained for raising the glass sunroof*/panorama glass sunroof* and that objects do not project into the opening path of the liftgate.

Secure roof-mounted cargo correctly and securely to prevent it from shifting or falling off during the trip.

Drive smoothly. Avoid sudden acceleration and braking maneuvers. Take corners gently.

Driving on poor roads

Your BMW is at home on all roads and surfaces. It combines a 4-wheel drive system with the advantages of a normal passenger car.



Do not drive on unpaved terrain, as otherwise the vehicle may be damaged. ◀

When you are driving on poor roads, there are a few points which you should strictly observe for your own safety, for that of your passengers, and for the safety of the vehicle:

- ▷ Familiarize yourself with the vehicle before driving off and avoid taking risks at all costs.
 - ▷ Adapt your driving speed to the road conditions. The steeper and rougher the road surface is, the lower the speed should be.
 - ▷ If you want to drive on very steep uphill or downhill gradients, make sure beforehand that the engine oil and coolant levels are near the MAX mark, refer to page 240. BMW X5: you can operate your vehicle on uphill and downhill gradients with a maximum slope of 50%.
 - ▷ On very steep downhill slopes, use Hill Descent Control HDC, refer to page 90. BMW X5: it is possible to start off on inclines of up to 33%. The permissible body roll is 50%.
 - ▷ While driving, watch carefully for obstacles such as rocks or holes. Try to avoid these obstacles whenever possible.
 - ▷ Make sure that the undercarriage does not touch the ground, for example on crests and bumpy roads. The ground clearance of the vehicle is a maximum of approx. 8 in/20 cm. Please note that the ground clearance can vary depending on loading and the driving conditions of the vehicle.
 - ▷ Only drive through road surface water up to a maximum water depth of
 - ▷ BMW X5 20 in/50 cm
 - ▷ BMW X6 17 in/45 cm
- and only drive at walking speed; do not remain stationary.

- ▷ After driving through water at low speed, lightly press the brake pedal several times to dry the brakes and to prevent the braking effect from being reduced by wetness.
- ▷ Depending on the condition of the surface, it may be practical to briefly activate DTC, refer to DTC Dynamic Traction Control on page 89.
- ▷ If the drive wheels spin on one side, depress the accelerator pedal sufficiently so that the driving stability control systems can distribute the drive forces to the individual wheels.

Please note the following points after driving on poor roads to maintain the driving safety of your BMW:

- ▷ Clean the coarsest dirt from the body.
- ▷ Clean mud, snow, ice etc. from the wheels and tires and check the tires for damage.



Navigation

This chapter describes how you can enter destinations and specify your route so that your navigation system guides you reliably to your destination.

Navigation system*

General information

With the help of satellites, the navigation system is able to ascertain the precise position of the vehicle and guide you reliably to any destination you enter.

Navigation data are stored in the vehicle and can be updated.

⚠ Enter data only with the vehicle stationary, and always give priority to the applicable traffic regulations in the event of any contradiction between traffic and road conditions and the instructions issued by the navigation system. Failure to take to this precaution can place you in violation of the law and put vehicle occupants and other road users in danger. ◀

Updating the navigation data

General information

Navigation data and an activation code can be obtained from your BMW Sports Activity Vehicle Center.

Updating the data can take several hours, depending on the volume of data.

- ▷ The data are updated as you drive.
- ▷ The updating process continues automatically when you resume driving.
- ▷ All functions remain available as you drive.
- ▷ Data are stored on the hard drive or in the internal memory.
- ▷ After the updating process is complete, the system restarts.
- ▷ The medium with the navigation data can be removed after the update.

Updating the navigation data

Inserting navigation DVD

1. Insert navigation DVDs into the DVD player with the printed side up.
2. Follow the instructions on the Control Display.
3. Enter the activation code of the navigation DVDs and switch DVDs if necessary.

Removing navigation DVD

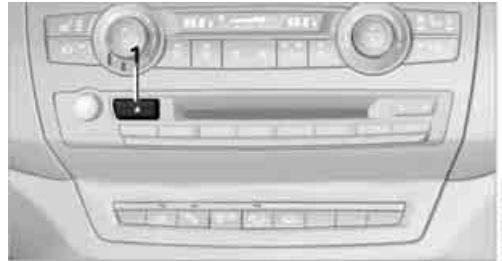

1. Press the **⏏** button **1**.
The DVD emerges slightly from the drive.
2. Remove the DVD.

If the DVD is not ejected from the drive, it is possible that it is blocked. In this case a message is also shown on the Control Display.

Displaying information on the version

1. "Navigation"
2. Open "Options".
3. "Navigation system version":
Information on the data version is displayed.

Destination entry

In entering your destination you can select from among the following options:

- ▷ Entering a destination manually, see below
- ▷ Selecting destination from address book, refer to page 143
- ▷ Last destinations, refer to page 144
- ▷ Special destinations, refer to page 144
- ▷ Entering a destination on the map, refer to page 146
- ▷ Selecting home address, refer to page 144
- ▷ Entering destination via voice*, refer to page 147

You can also store a navigation destination on the programmable memory buttons, refer to page 20.

 Enter data only with the vehicle stationary, and always give priority to the applicable traffic regulations in the event of any contradiction between traffic and road conditions and the instructions issued by the navigation system. If you do not observe this precaution, you can endanger the vehicle occupants and other road users. ◀

Entering a destination manually

The system's word-matching principle makes it easier for you to enter the names of streets or towns, refer to page 149. This allows you to enter different spellings and completes your entry automatically, so that stored names can be called up quickly.

1. Press the **MENU** button.
2. "Navigation"

3. "Enter address"



The system also supports you with the following features:

- ▷ If you do not enter a street, the system will guide you to the downtown area of a town or city.
- ▷ You can skip the entry of country and town/city if the current entries should be retained for your new destination.

Entering a state/province

1. "Navigation"
2. "Enter address"
3. Select "State/Province" or the displayed state/province.

Entering a town/city

1. Select "Town/City/Postal Code" or the displayed town/city, or select letters.

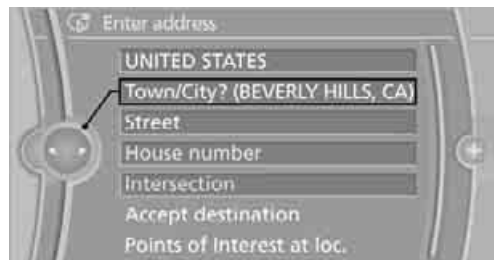

Delete letters, if necessary:

- ▷ To delete individual letters:
Turn the controller to select **⬅**, and then press the controller.
- ▷ To delete all letters:
Turn the controller to select **⬅**, and then press the controller for an extended period.
- ▷ To enter spaces:
Select the **□** symbol.

The list gradually grows smaller each time you enter a new letter.

2. Move the controller to the right.
3. Select the name of the town/city from the list. The three destinations stored last are displayed.

If there are several towns/cities with the same name:

1. Change to the list of town/city names.
2. Highlight the town/city: a preview map is displayed.
3. Select the town/city.

Entering the postal code

1. Select "Town/City/Postal Code" or the displayed town/city.
2. Select the 1@+ symbol.
3. Select the digits.
4. Change to the list of postal codes and towns/cities.
5. Highlight postal code: a preview map is displayed.
6. Select the postal code.

Entering street and intersection

1. Select "Street" or the displayed street.
2. Enter a street and intersection as you would the town/city.

After the street you can also enter the intersection or the house number.

If there are several streets with the same name:

1. Change to the list of street names.
2. Highlight the street: a preview map is displayed.
3. Select the street.

Entering a street without a destination town/city

You can also enter a street without entering a town/city of destination. In this case all streets of the entered country are offered for selection. The related town/city is displayed after the street name.

If a town/city has already been entered, you can undo this entry. This may be practical if the desired street does not exist in the entered destination, because, for example, it belongs to another part of the town/city.

1. "Navigation"
2. "Enter address"
3. Select "Street" or the displayed street.
4. Change to the list of street names.
5. "In" the state/province currently displayed.

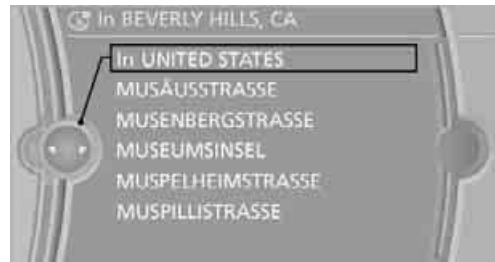

6. Select the letters.
7. Change to the list of street names.
8. Highlight the street: a preview map is displayed.
9. Select the street.

Entering house number

You can enter any house number stored in the navigation data for the street.

1. "House number"
2. Select the digits.

3. Change to the list of house numbers.
4. Select a house number or range of house numbers.

Selection after destination entry

- ▷ "Accept destination"
Destination guidance starts immediately.
- ▷ "Route preference"
refer to page 150.
- ▷ "Points of Interest at loc."
refer to page 144.

If a new town/city is selected during destination guidance, the current destination guidance is terminated.

Address book

To create contacts, refer to page 213.

Selecting a destination from the address book

1. "Navigation"
2. "Address book"

Contacts with addresses are displayed if these addresses have been checked as destinations.

If the contacts with addresses are not displayed by the mobile phone, then they must first be checked as destinations, refer to page 214.

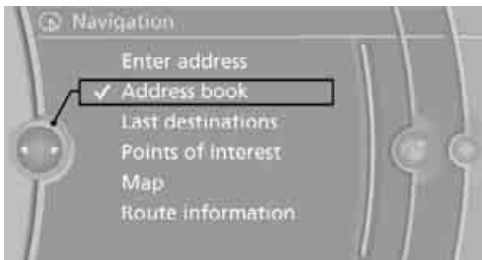

3. Select a contact from the list or, if necessary, using "A-Z search".
4. If necessary, select "Business address" or "Home address".

Storing a destination in the address book

Store the destination in the address book after entering the destination.

1. Open "Options".
2. "Store as new contact" or "Add to existing contact".

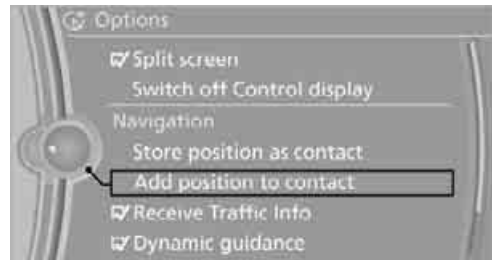

3. Select an existing contact, if available.
4. Select "Business address" or "Home address".
5. Enter "Last name" and, if necessary, "First name".
6. "Store in vehicle"

Storing the position

Your current position can be stored in the address book.

1. "Navigation"
2. Open "Options".
3. "Store position as contact" or "Add position to contact".



4. Depending on the selection, select an existing contact from the list or the type of address and enter the last and first name.
5. "Store in vehicle"

Editing or deleting an address

1. "Navigation"
2. "Address book"
3. Highlight the entry.
4. Open "Options".
5. "Edit in Contacts" or "Delete entry".

Using home address as destination

The home address must be stored as a destination. Refer to Specifying a contact as the home address, page 213.

1. "Navigation"
2. "Address book"
3. "Home"

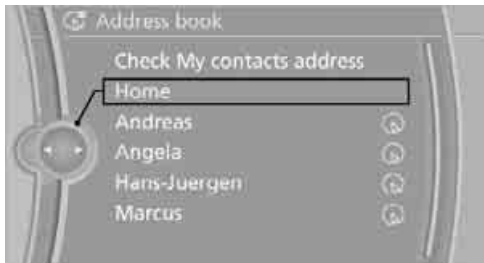

Destination guidance is started.

Last destinations

The last destinations are stored automatically. These destinations can be called up and used as a destination for destination guidance.

Accessing last destinations

1. "Navigation"
2. "Last destinations"

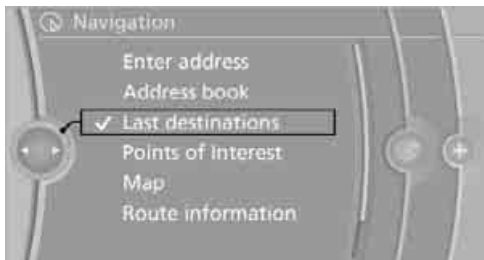

3. Select the destination.
Destination guidance is started.

Editing a destination

Destinations can be edited, for example, to change the house number of an existing entry.

1. "Navigation"
2. "Last destinations"
3. Highlight the destination.
4. Open "Options".
5. "Edit destination"

Deleting the last destinations

1. "Navigation"
2. "Last destinations"
3. Highlight the destination.
4. Open "Options".
5. "Delete entry" or "Delete all last destinations".

Special destinations

You can search for a special destination, e.g. a hotel or place of interest, and start destination guidance to the corresponding location.

The search can be narrowed by entering the location and type of special destination.

 The scope of information provided depends on the particular set of navigation data you are using. ◀

Accessing search for special destinations

1. "Navigation"
2. "Points of Interest"

Special destination location

Search for a special destination according to its location relative to a locality or route.

1. "Search area"



2. Select the location where the system is to search for the special destination:
 - ▷ "At current location"
 - ▷ "At destination"
 - ▷ "At a different destination"
 - ▷ "Along route"

Special destination category

1. "Category"
2. Select "All" or a specific category, e.g. hotels or restaurants.

Category details

For some special destinations, it is possible to display additional details that are recorded in the navigation data, e.g. restaurant type: Italian.
"Category details"

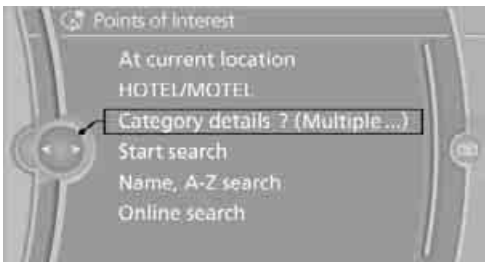

Starting the search for special destinations

1. "Start search" after the criteria have been defined.
2. A list of the special destinations is displayed.
 - ▷ Special destinations "At current location" are listed according to their distance from the current location and are displayed with a directional arrow pointing to the destination.
 - ▷ Destinations of the selected category are displayed in the map display as symbols. The display depends on the map scale and the category.
 - ▷ Special destinations "At destination", "At a different destination", "Along route" are listed according to their distance from the location where the search is being performed.
3. Highlight the special destination: the destination is displayed in the preview map.
4. Select the special destination.
5. Select the  symbol: "Start guidance".
6. If a phone number is available, a connection can be established, if desired.

Destination entry using BMW Assist*

The concierge service, refer to page 216, selects a desired address and transmits it for direct adoption into the navigation system.

1. "Navigation"
2. Open "Options".
3. Open "BMW Assist dest. entry".

Entering special destinations by name

1. "Navigation"
2. "Points of Interest"
3. "Name, A-Z search"
4. Enter the letters.
Depending on the distance, the search may take some time. The list can contain a maximum of 100 entries.

5. Change to the list of special destinations.
6. Highlight the special destination. The destination is displayed in the preview map.
7. Select the special destination.
8. Select the  symbol: "Start guidance".

Displaying special destinations in the map

To display symbols of the special destinations in the map:

1. "Navigation"
2. "Map"
3. Open "Options".
4. "Display Points of Interest"

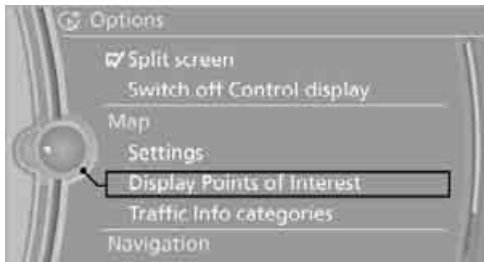

5. Select the settings.

Importing special destinations

1. "Navigation"
2. "Points of Interest"
3. Open "Options".
4. "Import (USB)" via the USB interface in the glove compartment or "Import (BMW Search)"**

Deleting special destinations

1. "Navigation"
2. "Points of Interest"
3. Open "Options".
4. "Delete my Points of Interest"
5. "Yes"

Entering the destination via map

If you only know the location of the town or street, you can enter the destination using the map.

Accessing map

1. "Navigation"
2. "Map"

A map section is displayed on the Control Display. The map shows the current position of the vehicle.

Selecting the destination

1. Select the  symbol. The interactive map is started.



2. Select the destination with the cross-hairs.
 - ▷ Changing scale: turn the controller.
 - ▷ Moving map: move the controller in the corresponding direction.
 - ▷ Shifting map diagonally: move the controller in the corresponding direction and turn the controller.
3. Press the controller to display other menu items.
4. If you wish, select the  symbol: "Start guidance".

Specifying the street

If the system does not detect any street, then a street name in the vicinity or the coordinates of the destination are displayed.

Interactive map

In the interactive map, the scale can be adjusted and the visible map section can be shifted. In addition, pressing the controller makes further functions available:



- ▶ Select the  symbol: "Start guidance".
- ▶ "Exit interactive map"
- ▶ Map display
- ▶ "Display destination"
The map section around the destination is displayed.
- ▶ "Display current location"
The map section around your current location is displayed.
- ▶ "Find points of interest", refer to page 144.

Entering destination via voice*

General information



You can enter a desired destination with the voice activation system. When entering the destination, it is possible to change between voice command and iDrive at any time. Reactivate the voice command system for this purpose if necessary.

 You can use ›Voice commands‹ to have the possible commands read aloud to you. ◀

Speaking the entry aloud

- ▶ Countries, towns/cities, streets, and intersections can be either spoken aloud as an entire words or spelled in the system language, refer to page 22.
- ▶ Town/city, street, and house number can also be spoken aloud in one sentence.
- ▶ Spell the entry if the language of the area is different from the system language.
- ▶ Speak the letters smoothly and avoid excessive emphasis and pauses.



Entering an address

1. Press the  button on the steering wheel.
-  2. ›Enter address‹
3. Wait for the system prompt.
4. Say the desired address in the suggested form.
5. Continue entering as prompted by the system.
6. If necessary, say the parts of the address individually, e.g. town/city.

Entering a town/city

The town/city can be spelled or entered as an entire word*.

 The entry possibilities depend on the particular navigation data as well as the country and language settings. ◀

-  1. ›City‹ or ›Spell city‹.
2. Wait for the system prompt for the town/city.
3. Say the name of the town/city or if necessary, spell at least the first three letters.
Depending on the entry, up to 20 towns/cities are suggested.
-  4. Select city/town:
 - ▶ Choose selected city/town: ›Yes‹
 - ▶ Select other city/town: ›New entry‹
 - ▶ Select an entry, e.g. ›Entry 2‹
 - ▶ Spell the entry: ›Spell city‹

 Similar-sounding towns/cities that cannot be differentiated by the system are compiled in a separate list and displayed as a town/city followed by three dots. If necessary, select this entry with ›Yes‹. Then select the desired city/town in this list. ◀

The town/city can also be selected from the list using iDrive: turn the controller until the desired town/city is displayed and press the controller.

Entering a street or intersection

The street or intersection is entered in the same way as the town/city.

Entering house number

You can enter house numbers up to the number 999:

1. ›House number‹
2. Say the house number.
3. ›Yes‹ to confirm the house number and start destination guidance.

Starting destination guidance

 ›Start guidance‹

Destination guidance starts immediately.

Saving destination

The destination is added to the destination list and is displayed in the list of last destinations.

Trip planner

The trip planner can be used to plan a trip with several legs to different destinations.

New trip

Various intermediate destinations can be entered for a trip.

1. "Navigation"
2. "Map"
3. Select the  symbol: "Guidance"

4. "Enter new destination"

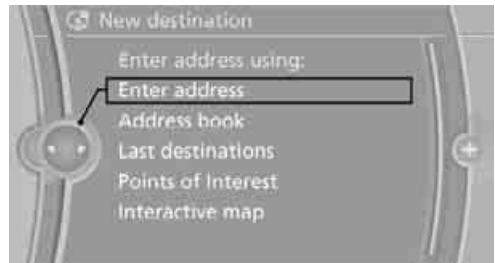

5. "Enter address"

Entering intermediate destinations

A maximum of 30 intermediate destinations can be entered for one trip.

1. "Enter new destination"
2. "Enter address using:"
3. Select the type of destination entry and enter the intermediate destination.

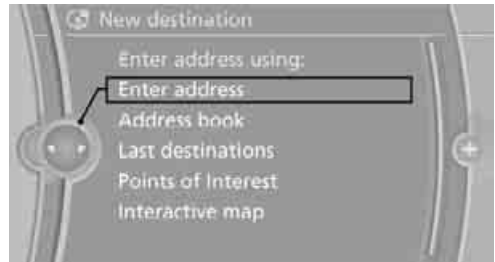

4. Select the location where the intermediate destination is to be inserted: "Reposition dest. in the trip".
5. If applicable, select "Add as another dest.".

Starting the trip

After all of the intermediate destinations are entered, access a stored trip directly "Accept destination" or via "Stored trips".

Storing a trip

Up to 30 planned trips can be stored in the trip list.

1. Open "Options".
2. "Store trip"
3. Enter the letters.

The trip is stored in the trip list under the entered name.

Changing trips

These functions are not available for imported trips.

Changing the trip direction

Intermediate destinations are displayed in reverse order in the list.

1. "Map"
2. "Guidance"
3. "Reverse order of trip dest."

Options for intermediate destinations

1. "Destination in the trip"
2. Select an intermediate destination.
3. Select option:
 - ▷ Shift the intermediate destination in the list:
"Reposition dest. in the trip"
 - ▷ Delete intermediate destination:
"Delete dest. in the trip"

Deleting a trip

1. "Stored trips"
2. Select the desired trip.
3. Open "Options".
4. "Delete all trips" or "Delete trip".

Word-matching principle

The system supports the word matching principle to make it easier for you to enter the names of streets or towns/cities. The system runs ongoing checks, comparing your destination entries with the data stored in the vehicle as the basis for instant response. The user benefits include:

- ▷ Names of specific locations can also vary from the official versions if you are using a spelling that is customary in another country.

Example:

Instead of "München", you can also enter the English spelling "Munich" or the Italian spelling "Monaco".

- ▷ When you are entering the names of towns/cities and streets the system will complete them automatically as soon as enough letters are available to ensure unambiguous identification.
- ▷ The system offers only those letters for selection of name entries that are stored in the vehicle. The system will not accept non-existent names and addresses.

Destination guidance

Starting destination guidance

1. "Navigation"
2. "Enter address"
3. Select the destination.
4. "Accept destination"

When the route has been calculated, it is displayed in the map on the Control Display.

Terminating destination guidance

1. "Navigation"
2. "Map"
3. Select the  symbol.
4. "Stop guidance"

Continuing destination guidance

If the destination was not reached at the end of the last trip, the system asks whether it should continue destination guidance.

Select "Resume guidance" or "Stop guidance".

Route criteria

General information

You can influence the calculated route by choosing certain route criteria. You can change the route criteria as often as you like while entering the destination and whenever the destination guidance is active.

The route is planned according to fixed rules. The road type is taken into account, e.g. whether it is a highway or a winding road. As a result, the routes recommended by the navigation system may not always be the same ones

that you would choose based on personal experience.

The settings are stored for the remote control currently in use.

Changing route criteria

1. "Navigation"
2. "Map"
3. "Route preference"
4. Selecting a criterion:
 - ▷ "Fast route": a route that is time-optimized by combining the shortest possible distance and route segments that can be driven quickly
 - ▷ "Efficient route": an optimized combination of the fastest possible route with a short route
 - ▷ "Short route": short distance without taking time into account
 - ▷ "Alternative routes": suggestions of other alternative routes with destination guidance running

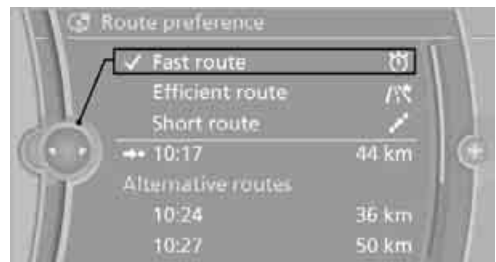

5. Select additional route criteria, if desired. Where possible, the selected criteria will be avoided on the route.
 - ▷ Avoid highways where possible: "Avoid highways"
 - ▷ Avoid toll roads where possible: "Avoid toll roads"
 - ▷ Avoid ferries where possible: "Avoid ferries"

The setting applies to the current route and to the planning of future routes.

Dynamic destination guidance

"Dynamic guidance" is switched on: The route is automatically changed in the event of traffic obstructions. The system does not point out traffic obstructions along the original route.

Depending on the type of road and the nature and length of the traffic obstruction, the route can also be calculated so that you travel through the traffic obstruction.

1. "Navigation"
2. Open "Options".
3. "Dynamic guidance"

 If the "Avoid highways", "Avoid toll roads" or "Avoid ferries" route criteria are selected, route calculation may take considerably longer. ◀

Route

General information

Depending on the equipment in your vehicle, various views of the route are available during destination guidance.

- ▶ Map display
- ▶ Arrow display
- ▶ Display of the streets and towns/cities on the route

Displaying a list of the streets or towns/cities on the route

When destination guidance is started, a list of the streets and towns/cities on the route is displayed. The driving distances and traffic bulletins are displayed for each route section.

- ▶ Display a list of the streets and towns/cities on the route.
- ▶ Display the traffic bulletins and the driving distance for each route section.

1. "Navigation"
2. "Route information"
3. Highlight a section.

The section is displayed in the preview map.

Bypassing a section of the route

During destination guidance, you can revise the navigation system's route recommendations to avoid particular stretches of road. Enter the number of miles/kilometers that you want to travel before returning to the original route.

1. "Navigation"
2. "Route information"
3. "New route for:"

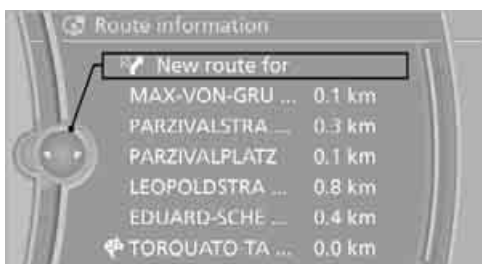

4. Turn the controller: enter the desired mileage.
5. Press the controller.

If the route section should no longer be bypassed: "Remove blocking".

Gas station recommendations

The vehicle calculates the range and recommends several gas stations along the route.



1. "Navigation"
2. "Route information"
3. "Recommended refuel"
A list of filling stations is displayed.
4. Select a gas station.
5. Select the  symbol to start destination guidance.

Destination guidance via voice instructions

Switching voice instructions on/off

Voice instructions can be switched on or off during destination guidance.

1. "Navigation"
2. "Map"
3. Select the  symbol.

| Symbol | Meaning |
|---|---------------------------------|
|  | Voice instructions switched on |
|  | Voice instructions switched off |

For rapid access, the feature can be stored on a programmable memory button, refer to page 20.

Repeating a voice instruction

1. "Navigation"
2. "Map"
3.  Highlight the symbol.
4. Press the controller twice.

Adjusting the volume of voice instructions*

The volume can be adjusted only while a voice instruction is being issued.

1. Repeat the last voice instruction, if necessary.
2. Turn the knob during the voice instruction to select the desired volume.

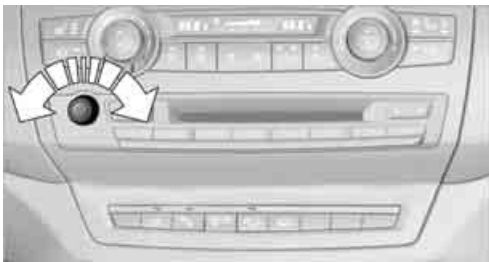

The setting is stored for the remote control currently in use.

Map display









Displaying map view

You can have your current position displayed on a map. After starting the destination guidance, the planned route is shown on the map.

1. "Navigation"
2. "Map"



The following functions are directly available in the map display:

| Symbol | Function |
|---|--|
|  | Displaying the destination and starting/terminating destination guidance |
|  | Switching voice instructions on/off |
|  | Changing route criteria or selecting route alternatives |
|  | Special destinations |
|  | Displaying traffic bulletins |
|  | Interactive map |
|  | Map display |
|  | Changing scale |

Information in the map display:

- ▷ Time, entertainment source, sound output, map orientation
- ▷ Distance from destination, estimated time of arrival, if destination guidance is active.
- ▷ Any traffic obstructions are highlighted in color.

Viewing the map

1. Select the  symbol.
2. Select a setting:
 - ▷ "View facing north"
 - ▷ "View in dir. of travel"
 - ▷ "Perspective view"
 - ▷ "Arrow display"
3. Press the controller.

Changing map scale

- ⊕ Select interactive map.
- ▷ Moving map: move the controller in the corresponding direction.
- ▷ Shifting map diagonally: move the controller in the corresponding direction and turn the controller.

Changing scale

1. Select the  symbol.
2. Turn the controller to change the scale.

Automatic scaling of the map

In the map display facing north, turn the controller in any direction until AUTO is displayed as the map scale.

The map shows the entire range from your location to the destination.

Settings for the map display

The map appears on the Control Display.

1. Open "Options".
2. "Settings"
3. Set the optimum map view.
 - ▷ "Day/night mode"
Select according to lighting conditions and make adjustments. This setting is disregarded when the traffic info map is activated.
 - ▷ "Satellite images"
Satellite images* are displayed, depending on availability and resolution.
 - ▷ "Perspective view in 3D"
Shows a three-dimensional depiction.

Prominent landmarks contained in the navigation data are displayed on the map in 3D.

- ▷ "Traffic Info map"

Split screen settings

The map settings for the split screen can be created separately from the main screen.

1. Open "Options".
2. "Split screen"
3. Select the settings:
 - ▷ "Arrow display"
 - ▷ "View facing north"
 - ▷ "View in dir. of travel"
 - ▷ "Perspective view"
 - ▷ "Exit ramp view"

Changing scale

1. Move the controller to the right until the split screen is selected.
2. Turn the controller.

Traffic information*

You can display the traffic bulletins from radio stations that broadcast the TMC (Traffic Message Channel) of a traffic information service. This information from the traffic information service is continuously updated on the basis of measurement data from traffic control centers and information on traffic congestion. During destination guidance, traffic bulletins that are relevant to areas along the route are automatically displayed and taken into account in the route planning. You can open all traffic bulletins manually using iDrive.

The traffic bulletins are shown in the map display.

Real Time Traffic Information End-User Provisions

Certain BMW models equipped with navigation have the capability to display real-time traffic information. If your system has this capability

the following additional terms and conditions apply:

An End-User shall no longer have the right to use the Traffic Data in the event that the End-User is in material breach of the terms and conditions contained herein.

A. Total Traffic Network, a division of Clear Channel Broadcasting, Inc. ("Total Traffic Network") holds the rights to the traffic incident data and RDS-TMC network through which it is delivered. You may not modify, copy, scan or use any other method to reproduce, duplicate, republish, transmit or distribute in any way any portion of traffic incident data. You agree to indemnify, defend and hold harmless BMW of North America, LLC. ("BMW NA") and Total Traffic Network, Inrix, Inc. (and their affiliates) against any and all claims, damages, costs or other expenses that arise directly or indirectly out of (a) your unauthorized use of the traffic incident data or the RDS-TMC network, (b) your violation of this directive and/or (c) any unauthorized or unlawful activities by you in connection herewith.

B. Total Traffic Network traffic data is informational only. User assumes all risk of use. Total Traffic Network, BMW NA, and their suppliers make no representations about content, traffic and road conditions, route usability, or speed.

C. The licensed material is provided to license "as is," and "where is." Total Traffic Network, including, but not limited to, any and all third party providers of any of the licensed material, expressly disclaims, to the fullest extent permitted by law, all warranties or representations with respect to the licensed material (including, without limitation, that the licensed material will be error-free, will operate without interruption or that the traffic data will be accurate), express, implied or statutory, including, without limitation, the implied warranties of merchantability, non-infringement fitness for a particular purpose, or those arising from a course of dealing or usage of trade.

D. Neither Total Traffic Network, Inrix, Inc. nor BMW NA will be liable to you for any indirect, special, consequential, exemplary, or incidental

damages (including, without limitation, lost revenues, anticipated revenues, or profits relating to the same) arising from any claim relating directly or indirectly to use of the traffic data, and even if Total Traffic Network, Inrix, Inc. or BMW NA is aware of the possibility of such damages. These limitations apply to all claims, including, without limitation, claims in contract and tort (such as negligence, product liability and strict liability). Some states do not allow the exclusion or limitation of incidental or consequential damages, so those particular limitations may not apply to you.

Activating/deactivating reception

1. "Navigation"
2. Open "Options".
3. Activate/deactivate "Receive Traffic Info".

In many metropolitan areas you can receive traffic information broadcast by radio stations. The traffic conditions are monitored by traffic control centers and the traffic information is updated periodically.

During destination guidance, the traffic bulletins relevant to your planned route are automatically shown. Whether destination guidance is active or not, you can have the traffic information displayed in the map view or in the traffic info list.

Traffic bulletins in a list

A list of the traffic bulletins can be opened via the menu or map display.

Opening traffic bulletins

1. "Navigation"
2. "Map"
3. Move the controller to the left.
4. Select the  symbol.
5. "Traffic Info"
First, the traffic bulletins on the planned route are displayed. The traffic bulletins are sorted in the order of their distance from the current vehicle position.
6. Select a traffic bulletin.

Additional information can be displayed for some traffic bulletins:

1. Select the  symbol.
2. Additional information is displayed.
3. To exit from the menu:
Move the controller to the left.

Traffic bulletins in the map

When the traffic info map is activated, the picture on the Control Display is switched to a grayscale. This permits an optimized depiction of traffic information. The day/night mode is disregarded in this setting.

1. "Navigation"
2. "Map"
3. Open "Options".
4. "Settings"
5. Activate "Traffic Info map":
The map is optimized to display traffic information. Symbols for the special destinations are no longer displayed.

Symbols in map view

The symbols of traffic obstructions are displayed differently, depending on the scale of the map and location of the traffic obstruction in relation to the route.



- ▷ Smaller map scale, e.g. 1 mile/2 km: white sign with the traffic obstruction symbol
- ▷ Larger map scale, e.g. 50 miles/100 km: white sign with an arrow in the relevant direction

Additional information in the map display

Depending on the map scale, the length, direction, and effects of a traffic obstruction are depicted by traffic symbols in the map or by bars along the planned route.

Filtering of traffic bulletins

You can filter which traffic bulletins are to be displayed by the system:

1. "Navigation"
2. "Traffic Info"
3. Open "Options".
4. "Traffic Info categories"
5. Select the desired category.

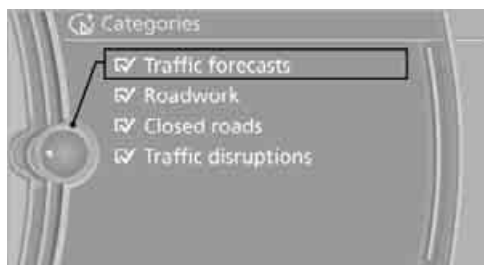

Traffic bulletins of the selected category are displayed.

- ▷ Traffic bulletins on incidents along the route are always displayed.
- ▷ For your own safety, traffic bulletins that notify you of potentially dangerous situations, such as wrong-way drivers, cannot be hidden.

Traffic bulletins during destination guidance

System response will vary depending on whether or not "Dynamic guidance" is selected. Information on sources of great danger, such as wrong-way drivers, is displayed regardless of the setting.

Traffic obstructions

The system calculates the optimized route, taking into consideration traffic obstructions and road types.

Selecting a detour

You can set whether individual traffic obstructions or all of them are taken into account in the route planning.

1. "Navigation"
2. "Traffic Info"
3. Select the traffic obstruction that is to be taken into consideration.
4. "Activate detour"

Taking into consideration all traffic obstructions

1. "Navigation"
2. "Traffic Info"
First, the traffic bulletins on the planned route are displayed. The traffic bulletins are sorted in the order of their distance from the current vehicle position.
3. Select "Recomm. detour", if necessary.
"Dynamic guidance" is automatically activated.

What to do if ...

What to do if ...

- ▷ the current position cannot be displayed?
The position is in an unrecognized region, in a poor reception area, or the system is in the process of determining the position. Reception is best when you have an unobstructed view to the sky.
- ▷ the destination guidance does not accept an address without the street name?
A downtown area cannot be determined for the town or city that has been entered. Input any street in the selected town/city and start destination guidance.
- ▷ the destination guidance does not accept a destination?
The destination data is not contained in the navigation data. Select a destination that is as close as possible to the original.
- ▷ the letters for a destination cannot be selected during destination entry?
Stored data do not contain the data of the destination. Select a destination that is as close as possible to the original.
- ▷ the map view is displayed in grayscale?
When the traffic info map is activated, the picture on the Control Display is switched to a grayscale. This permits an optimized depiction of traffic information.
- ▷ Voice instructions are no longer issued before intersections during destination guidance?
The area has not been fully recorded yet, or you have left the recommended route and the system requires a few seconds to calculate a new route suggestion.





Entertainment

Operation of the radio and CD as well as their tone settings are described in this chapter.

On/off and tone

The following audio and video sources share the same control elements and adjustments:

- ▷ Radio
- ▷ CD/DVD player
- ▷ CD/DVD changer*
- ▷ Video
- ▷ External devices, e.g. MP3 player

Controls

The audio and video sources can be controlled using:

- ▷ Buttons near the CD/DVD player
- ▷ iDrive
- ▷ Buttons on the steering wheel, refer to page 11
- ▷ Programmable memory buttons, refer to page 20
- ▷ Voice activation system

Buttons near the CD/DVD player

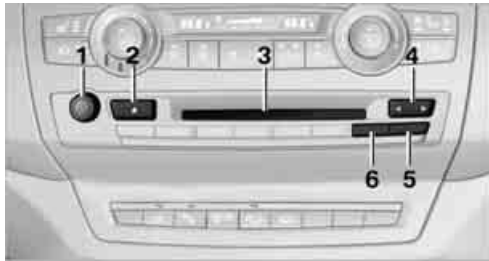

- 1** Sound output for entertainment on/off, volume
 - ▷ Press: switch on/off
When you switch on the unit, the last set radio station or track is played.
 - ▷ Turn: adjust volume
- 2**  Ejecting CD/DVD
- 3** CD/DVD drive

- 4**  Station scan/track search
 - ▷ Change the radio station
 - ▷ Select track for CD/DVD player and CD/DVD changer and certain multimedia devices
- 5** **MODE:** change the audio and video sources
- 6** **FM/AM:** change the radio station wave-band

Switching on/off

To switch the Entertainment sound output on and off:

Press button **1** next to the CD/DVD player.

 This symbol on the Control Display indicates that sound output is switched off.

The sound output is available for approx. 20 minutes after the ignition was switched off. Switch on the sound output again for this purpose.

Adjusting volume

Turn button **1** next to the CD/DVD player until the desired volume is obtained.

You can also adjust the volume with buttons on the steering wheel, refer to page 11.

The setting is stored for the remote control currently in use.

Tone control

You can alter various tone settings, e.g. treble and bass or the speed-dependent volume increase.

The tone settings are set for all audio sources at once.

The settings are stored for the remote control currently in use.

Treble, bass, balance, fader

- ▷ "Balance": left/right volume distribution
- ▷ "Fader": front/rear volume distribution

Adjustments

1. "CD/Multimedia", "Radio" or "Settings".
2. "Tone"



3. Select the desired tone setting.



4. To adjust: turn the controller.
5. To store: press the controller.

Equalizer*

You can set individual sound frequency ranges.

1. "CD/Multimedia", "Radio" or "Settings".
2. "Tone"
3. "Equalizer"

4. Select the desired setting.

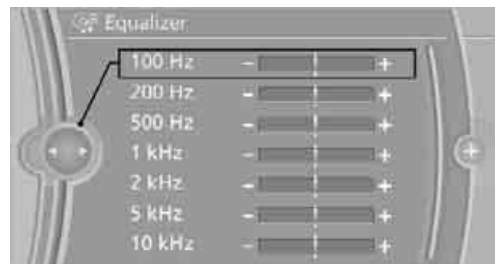

5. To adjust: turn the controller.
6. To store: press the controller.

Multichannel playback, surround*

You can choose between stereo and multichannel playback, surround.

1. "CD/Multimedia", "Radio" or "Settings".
2. "Tone"
3. "Surround"

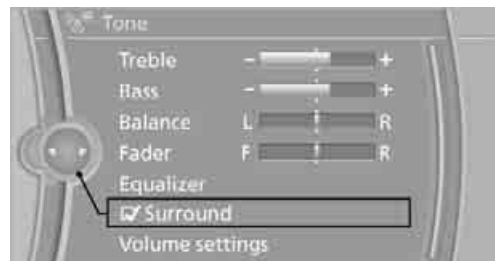

Multichannel playback, surround, is simulated when playing back an audio track in stereo.

Surround is automatically activated or deactivated, depending on the audio track selected.

Volume

- ▷ "Speed volume": adaptation of the volume as a function of vehicle speed
- ▷ "PDC"*: volume of the PDC signal tone in comparison to entertainment sound output
- ▷ "Gong": volume of the signal tone, e.g. for the safety belt reminder, in comparison to entertainment sound output

Adjustments

1. "CD/Multimedia", "Radio" or "Settings".
2. "Tone"
3. "Volume settings"
4. Select the desired volume setting.

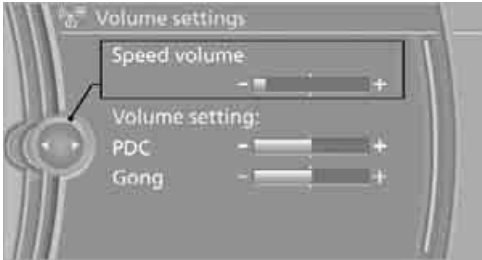

5. To adjust: turn the controller.
6. To store: press the controller.

Resetting tone settings

You can reset all tone settings to the default setting.

1. "CD/Multimedia", "Radio" or "Settings".
2. "Tone"
3. "Reset"

Radio

Your radio is designed for reception of the following stations:

- ▷ FM and AM
- ▷ HD Radio*
- ▷ Weather Radio*
- ▷ satellite radio*

Selecting a station



Press the button if the sound output is switched off.

1. "Radio"

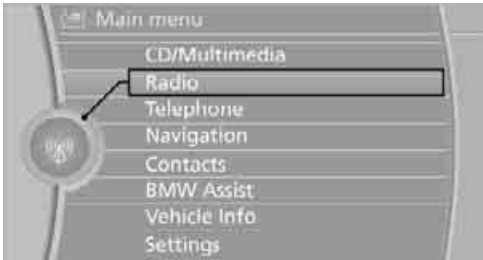

2. "FM" or "AM"

3. Select the desired station.



Changing stations

Turn the controller and press it

or

press the ◀ ▶ button for the corresponding direction

or

press the buttons on the steering wheel, refer to page 11.

Selecting frequency manually

In "Manual", you can set stations that are being received in addition to those being displayed.

1. "Radio"
2. "FM" or "AM"
3. "Manual"
4. In the "AM" band, select from among "AM"*, "AM", and "AM".
5. Call up the frequency.



6. To store the station: press the controller.

Storing stations

Using iDrive

1. "Radio"
2. "FM" or "AM"
3. Select the desired station.



4. Press the controller again.
5. Select the desired memory location.
The station is stored.

The stations are stored for the remote control currently in use.

Using programmable memory buttons

You can store a station on the programmable memory buttons, refer to page 20.

1. Select a station.
2.  Press the desired button for a longer period.

Radio Data System RDS*

In the FM frequency range, additional information is transmitted via RDS. If the reception conditions are good, the station names are shown on the Control Display. If the reception is weak or disrupted, it can take some time before the station names are displayed.

Switching RDS on/off

1. "Radio"
2. "FM"
3. Open "Options".

4. "RDS"

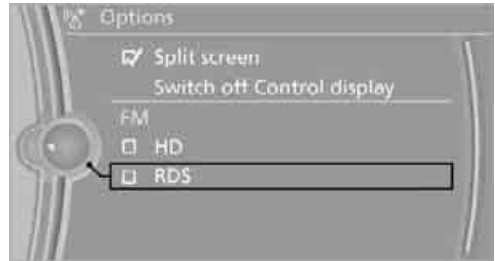

The setting is stored for the remote control currently in use.

HD Radio*

Many radio stations transmit analog and digital signals. If a digital radio network is available, these stations can be received digitally and thus with improved sound quality.

License conditions

HD Radio™ technology is manufactured under U.S. and Foreign Patents licensed from iBiquity Digital Corp. HD Radio™ and the HD and HD Radio logos are proprietary trademarks of iBiquity Digital Corp.

Activating/deactivating digital radio reception

1. "Radio"
2. "FM" or "AM"
3. Open "Options".
4. "HD Radio"

The setting is stored for the remote control currently in use.

 This symbol is displayed when a station is being received digitally.

In areas in which the station is not continuously received in digital mode, playback switches between analog and digital reception. Any time shift between these two broadcasts can lead to repetitions or interruptions in the output. In this case, switch off digital radio reception.

Displaying additional information

Some stations broadcast additional information on the current track, such as the name of the artist.

1. Select the desired station.
2. Open "Options".
3. "Station info"

Selecting a substation

1. Select the desired station.
2. Press the controller.
3. Select the substation.

Stored stations

It is possible to store up to 40 stations.

Selecting a station

1. "Radio"
2. "Presets"
3. Call up the desired station.

Storing a station

The station currently selected is stored.

1. "Radio"
2. "Presets"
3. "Store station"



4. Select the desired memory location.

The list of stored stations is stored for the remote control currently in use.

You can also store the stations on the programmable memory buttons, refer to page 20.

Deleting a station

1. "Radio"
2. "Presets"
3. Select the desired station.
4. Open "Options".
5. "Delete entry"

Weather Radio*

Weather Radio is a service of the National Oceanic and Atmospheric Administration (NOAA) of the US Department of Trade. Weather reports are repeated every 4 to 6 minutes and are routinely updated every 1 to 3 hours, more frequently as needed. Most stations operate 24 hours a day. In case of a storm, the National Weather Service interrupts the routine weather news and transmits special warning messages instead. If you have a question about NOAA Weather Radio, please contact the nearest office of the National Weather Service. Details are also provided on the Internet at www.nws.noaa.gov.

Accessing weather news flashes

Operating via iDrive:

1. Switch on radio.
2. "Weather band"
3. Selecting desired channel.







The station for weather news flashes may be unavailable in some regions.

Satellite radio*

General information

The channels are offered in fixed packages. Packages must be activated by telephone.

Navigation bar

| Symbol | Function |
|---|--|
|  | Changing list view |
|  | Selecting category |
|  | Entering channel directly |
|  | Time shift |
|  | Accessing favorites, selecting the My Favorites category |
|  | Managing favorites |
|  | Traffic Jump |

The functions of the symbols of the navigation bar can also be stored on the programmable memory buttons, refer to page 20.

Managing subscription

Clear reception is required for activating and deactivating channels. Reception is best when you have an unobstructed view to the sky. The channel name is displayed in the status line.

Activating channels

The category Unsubscribed Channels includes all channels that are not activated.

1. "Radio"
2. "Satellite radio"
3.  "Categories"



4. Select the category Unsubscribed Channels.
5. Select desired channel. The telephone number and electronic serial number, ESN, are displayed.
6. Dial the telephone number to have the channels activated.

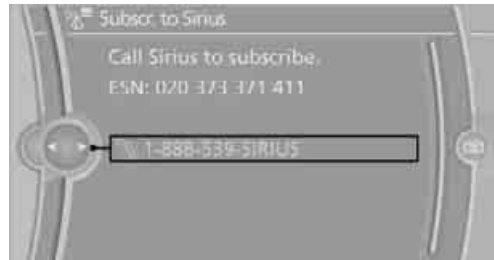

This telephone number can also be used to deactivate the channels once more.

Deactivating channels

1. "Radio"
2. "Satellite radio"
3. Open "Options".
4. "Manage subscription"



The telephone number and electronic serial number, ESN, are displayed.

5. Call Sirius to deactivate the channels.

Selecting channels

You can only listen to activated channels.

The selected channel is stored for the remote control currently in use.

Using iDrive

1. "Radio"
2. "Satellite radio"
3. Select "All Channels" or the desired category.
4. Select desired channel.

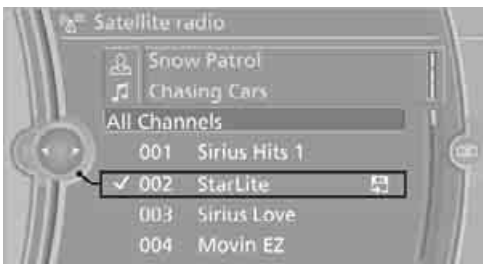

Using the button near the CD/DVD player

Press the  button for the corresponding direction.

The next channel is selected.

Using direct channel entry

1. "Radio"
2. "Satellite radio"

3.  "Select channel"

4. Turn the controller until the desired channel is displayed and press the controller.

Storing channel

1. "Radio"
2. "Satellite radio"
3. Select "All Channels" or the desired category.
4. Select desired channel.
5. Press the controller again.
6. Press the controller again in order to confirm selection of the highlighted channel.



7. Select the desired memory location.



The channels are stored for the remote control currently in use.

You can also store the channels on the programmable memory buttons, refer to page. 20.

Change list view

The list view changes each time the first symbol on the navigation bar is pressed.

Information about the channel is displayed.

| Symbol | Function |
|---|--------------|
|  | Channel name |
|  | Artist |
|  | Track |

Select category

1. "Radio"
2. "Satellite radio"
3.  "Categories"
4. Select the desired category.

Time shift

Approximately one hour of the channel currently being listened to is temporarily stored in a cache memory. The signal must be available. The stored audio track can be played back at a different time from the live broadcast. If the cache memory is full, then the older tracks are recorded over. The cache memory is deleted if a new channel is selected.





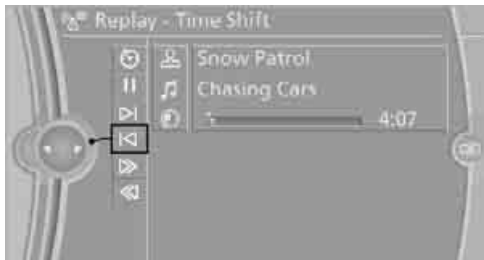

Accessing Time shift

1. "Radio"
2. "Satellite radio"
3. Open "Options".
4.  "Replay - Time Shift"
A new window appears in the display.



- ▷ The red arrow indicates the current playback position.
- ▷ The time difference from the live broadcast is displayed next to the cache memory bar.
- ▷ During a live broadcast, "live" is displayed next to the cache memory bar.

Time shift menu

| Symbol | Function |
|---|----------------------|
|  | Go to live broadcast |
|  | Playback/pause |
|  | Next track |
|  | Previous track |
|  | Fast forward |
|  | Reverse |

Storing favorites

Up to 30 favorites can be stored in the favorites list. Possible favorites include artist, track, game, league, and team.

Storing artist, track, or game

Only current broadcasts can be stored as favorites. The channel information must be available.

1. "Radio"
2. "Satellite radio"
3. Select "All Channels" or the desired category.
4. Select desired channel.
5. Press the controller again.
6. Select artist, track, or game.

Storing league or team

Leagues or teams can be added to the favorites from a selection list.

1. "Radio"
2. "Satellite radio"
3.  "Manage favorites"
4. "Add sports information"



5. Select the desired league.
6. Select "Add all teams" or a desired team.

Accessing favorites

If an activated favorite is being played, then the message "Playing favorite!" appears for approx. 20 seconds.

Select **☆☆** "Favorites" while the message is being displayed.



The displayed favorite will be played.

If it receives no notification, the system switches into the My Favorites category. All of the favorites currently being broadcast can be selected from a list.

Managing favorites

Activating/deactivating favorites

Favorites can be activated or deactivated globally and individually.

1. "Satellite radio"
2. **☆☆** "Manage favorites"
3. Select "Activate alert" or desired favorites.

The setting is stored for the remote control currently in use.

Deleting favorites

1. "Satellite radio"
2. **☆☆** "Manage favorites"
3. Highlight the favorites you wish to delete.
4. Open "Options".
5. "Delete entry"

Traffic Jump

Traffic and weather information for a selected region are broadcast at intervals of a few minutes.

Selecting region

1. "Radio"
2. "Satellite radio"
3. Open "Options".
4. "Set Jump"
5. Select the desired region.

The region is stored for the remote control currently in use.

Activating/deactivating Jump

1. "Radio"
2. "Satellite radio"
3. **↻** "Jump to:"

As soon as information about the selected region becomes available, it is broadcast.

A new panel appears in the display.

Cancel Traffic Jump: "Cancel".

| Symbol | Meaning |
|----------|---|
| ↻ | Information will be broadcast soon. |
| ↻ | Information is currently being broadcast. |

Select one of the symbols to deactivate Traffic Jump.

Automatic update

About twice a year, Sirius carries out an update of the names and positions of the channels. The update occurs automatically and can take several minutes.

Notes

- ▷ Under some circumstances, reception may not be possible, e.g. under certain environmental or topographical conditions. The satellite radio has no influence on this.
- ▷ The signal may not be available in tunnels or underground garages or near trees, mountains, or other powerful sources of radio interference.

CD/DVD player and CD/DVD changer*

CD/DVD playback



Inserting CD/DVD

Push the CD/DVD into the drive with the labeled side facing upward. The CD/DVD is automatically pulled in.

Playback starts automatically if the sound output is on. CDs/DVDs with compressed audio files can take a few minutes to read, depending on their directory structure.

Playable formats

CD/DVD player

- ▶ DVD: DVD-ROM, DVD-R, DVD+R, DVD-RW, DVD+RW, DVD-R DL, DVD+R DL, DVD audio (video part only), DVD video
- ▶ CD: CD-ROM, CD-R, CD-RW, CD-DA, VCD, SVCD
- ▶ Compressed audio files: MP3, WMA, AAC

CD changer*

- ▶ CD: CD-ROM, CD-R, CD-RW, CD-DA

DVD changer*

- ▶ DVD: DVD-ROM, DVD-R, DVD+R, DVD-RW, DVD+RW, DVD-R DL, DVD+R DL, DVD audio (video part only), DVD video, CD: CD-ROM, CD-R, CD-RW, CD-DA, VCD, SVCD

Starting playback

Using iDrive

Fill and insert CD/DVD magazine, refer to page 175.

To start playback if a CD is already located in the player or changer:

1. "CD/Multimedia"

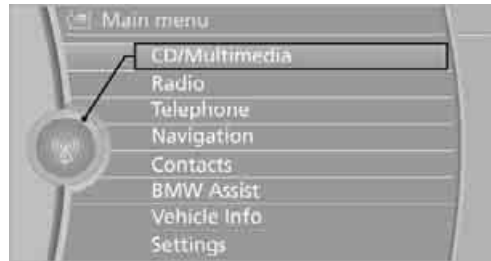

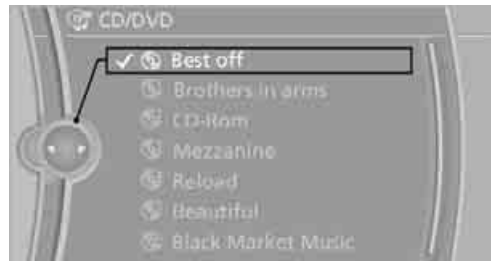

2. "CD/DVD"
3. Select the desired CD or DVD:



Ejecting CD/DVD

Press the  button next to the CD/DVD player. The CD/DVD emerges slightly from the drive.

| Symbol | Function |
|---|----------------|
|  | CD/DVD player |
|  | CD/DVD changer |

Audio playback

Selecting a track

Press the  button for the corresponding direction repeatedly until you reach the desired track.

Audio CDs

1. "CD/Multimedia"
2. "CD/DVD"
3. Select the desired CD or DVD.
4. Select the desired track to begin playback.



CDs/DVDs with compressed audio files*

It is possible that not all of the characters on the CD/DVD will be correctly displayed, depending on the data.

1. "CD/Multimedia"
2. "CD/DVD"
3. Select the desired CD or DVD.
4. Select the directory, if necessary.
To change to a higher level directory: move the controller to the left.



5. Select the track and press the controller.



Displaying information about the track*

If information about a track has been stored, it is displayed automatically:



- ▷ Artist
- ▷ Album title
- ▷ Track number on the CD/DVD
- ▷ Track file name

Random play sequence

The tracks of the current CD/DVD are played once in a random sequence.

1. "CD/Multimedia"
2. "CD/DVD"
3. Select the desired CD or DVD.
4. Open "Options".

5. "Random"

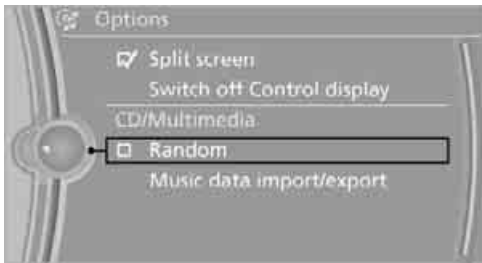

CDs/DVDs with compressed audio files: the directories and the tracks contained therein are played back in random sequence.

Random mode is switched off when the audio source is changed or the ignition is switched off.

Fast forward/reverse

Press and hold the  button for the corresponding direction.

Automatic replay*

Selected tracks, directories, or CDs/DVDs are automatically replayed.

Video playback*

Country codes

Only DVDs with the code of the home region can be played back; also refer to the information on your DVD.

| Code | Region |
|------|---|
| 1 | USA, Canada |
| 2 | Japan, Europe, Middle East, South Africa |
| 3 | Southeast Asia |
| 4 | Australia, Central and South America, New Zealand |
| 5 | Northwest Asia, North Africa |
| 6 | China |
| 0 | All regions |

Starting playback

For your own safety, the video image is only displayed up to a speed of approx. 2 mph/3 km/h; in certain country-specific equipment configurations, the video image will only display if the hand brake is engaged.

DVD video

1. "CD/Multimedia"
2. "CD/DVD"
3. Select a DVD with video content.
4.  "DVD menu"



5. Start the DVD via the DVD menu.

VCD/SVCD

1. "CD/Multimedia"
2. "CD/DVD"
3. Select a CD/DVD with video content.
4.  "Select track"











5. Select the desired track.
The CD/DVD starts to play.

Video menu

To open the Video menu:

1. Turn the controller during playback.
2. Press the controller when "Back" is displayed.

The Video menu is displayed:

| Symbol | Function |
|---|---------------------------------|
|  | Open the DVD menu* |
|  | Starting playback |
|  | Pause |
|  | Stop |
|  | Next chapter/next track |
|  | Previous chapter/previous track |
|  | Fast forward |
|  | Reverse |

In fast forward/reverse: the speed increases every time the controller is pressed. To stop, start playback.

DVD menu

1. If necessary, turn the controller to open the video menu.
2.  "DVD menu"
The DVD menu is displayed. The display depends on the contents of the DVD.
- ▶ To select menu items: move and press the controller.
- ▶ To change to the Video menu: turn the controller and select "Back".

Settings for DVD/VCD

For some DVDs, settings can only be made via the DVD menu; refer also to the information on your DVD.

Language*

1. Turn the controller during playback.
2. Open "Options".
3. "Audio/language"



4. Select the desired language.

The languages that are available depend on the DVD.

Subtitles*

Subtitles can be selected if they are contained on the DVD.

1. Turn the controller during playback.
2. Open "Options".
3. "Subtitles"
4. Select the desired language or "Do not display subtitles".



Brightness, contrast, color

1. Turn the controller during playback.
2. Open "Options".
3. "Display settings"

- "Brightness", "Contrast" or "Color"

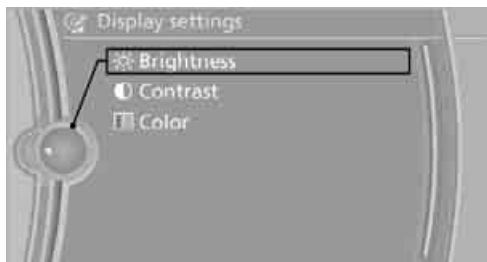

- Turn the controller until the desired setting is displayed and then press the controller.

Zoom

Display the video image on the full screen.

- Turn the controller during playback.
- Open "Options".
- "Additional options"
- "Zoom mode"

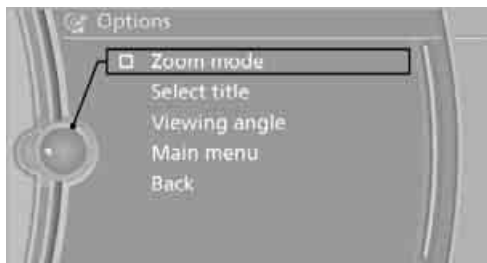

Selecting title

DVD video:

- Turn the controller during playback.
- Open "Options".
- "Additional options"
- "Select title"
- Select the desired track.

VCD/SVCD:

- [?] "Select track"
- Select the desired track.

Camera angle*

The camera angle depends on the DVD.

- Turn the controller during playback.
- Open "Options".
- "Additional options"
- "Viewing angle"
- Select the desired camera angle.

Opening the main menu, back

These functions are not contained on every DVD. Therefore, they may not be available for use.

CD/DVD changer*



The BMW CD/DVD changer for six CDs/DVDs is accommodated in the glove compartment.

Controls and displays

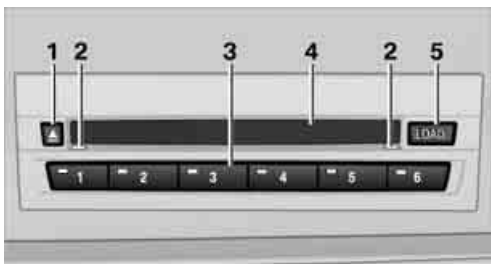

- Emptying CD/DVD compartments
- LEDs under the CD/DVD slot flash when CDs/DVDs can be inserted.
- Buttons for CD/DVD compartments
The LED lights up when a CD/DVD is in the compartment.
- CD/DVD slot
- Loading CD/DVD compartments

Loading CD/DVD changer

1. Press the **LOAD** button.
The LED on the first empty compartment flashes.
2. Select another CD/DVD compartment if so desired:
Press the **1 ... 6** button.
3. When the LEDs **2** under the CD/DVD slot flash, insert a single CD/DVD into the middle.
The CD/DVD is automatically pulled in and placed into the selected CD/DVD compartment.
 Only insert CD/DVD if the LEDs **2** under the CD/DVD slot are flashing; otherwise, you may damage the CD/DVD or the CD/DVD changer.
Do not push on the CDs/DVDs; they may jam and no longer eject properly. ◀
4. To load additional CD/DVD compartments:
Repeat steps 1 to 3.

Filling empty CD/DVD compartments

1. Hold down the **LOAD** button.
The LEDs on the empty CD/DVD compartments flash.
2. When the LEDs **2** under the CD/DVD slot flash, insert a single CD/DVD into the middle.
The CD/DVD is automatically pulled in and placed into the first empty CD/DVD compartment.
 Only insert CD/DVD if the LEDs **2** under the CD/DVD slot are flashing; otherwise, you may damage the CD/DVD or the CD/DVD changer.
Do not push on the CDs/DVDs; they may jam and no longer eject properly. ◀
3. Wait until the CD/DVD has been pulled in.
4. To load additional CD/DVD compartments:
Repeat steps 2 and 3.

After filling, it can take a few minutes to read the CDs/DVDs.

Removing CDs/DVDs individually

1. Press the **EJECT** button.
2. Press the **1 ... 6** button to select the CD/DVD compartment.
The CD/DVD is slid a short distance out from the CD/DVD changer.
3. Remove the CD/DVD.

 If the CD is not removed, it will be pulled back in again after approx. 10 seconds. ◀

Removing all CDs/DVDs

1. Hold down the **EJECT** button.
The CDs/DVDs will be slid out a short distance out from the CD/DVD changer, in sequence.
2. Remove the CDs/DVDs.

Notes

 BMW CD/DVD players and changers are officially designated Class 1 laser products. Do not operate if the cover is damaged, otherwise severe eye damage can result. Do not use self-recorded CDs/DVDs with labels applied as these can become detached during playback due to heat buildup and can cause irreparable damage to the device. Only use round CDs/DVDs with a standard diameter of 4.7 in/12 cm and do not play CDs/DVDs with an adapter, e.g. CD singles, as otherwise the CD/DVD or the adapter may jam and no longer eject properly. Do not use a combined CD/DVD, e.g. DVD^{Plus}, otherwise the CD/DVD may jam and no longer eject properly. ◀

General malfunctions

BMW CD/DVD changers and players have been optimized for performance in vehicles. In some instances they may be more sensitive to faulty CDs/DVDs than stationary devices would be.

If a CD/DVD cannot be played, first check whether it has been inserted correctly.

Humidity

High levels of humidity can lead to condensation on the CD/DVD or the laser's scan lens and temporarily prevent playback.

Malfunctions with individual CDs/DVDs

If malfunctions occur only with particular CDs/DVDs, this can be due to one of the following causes:

Self-recorded CDs/DVDs

Possible reasons for malfunctions with self-recorded CDs/DVDs are, e.g., inconsistent data-creation or recording processes, or poor quality or high age of the CD/DVD blank.

Only label CDs/DVDs on the upper side with a pen intended for this purpose.

Damage

Avoid fingerprints, dust, scratches and moisture.

Store CDs/DVDs in a sleeve.

Do not subject CDs/DVDs to temperatures above 122 °F /50 °C, nor to high humidity levels or direct sunlight.

CDs/DVDs with copy protection

CDs/DVDs are often provided with a copy protection feature by the manufacturer. This can mean that some CDs/DVDs cannot be played or can only be played to a limited extent.

MACROVISION

This product contains copyrighted technology that is based on multiple registered U.S. patents and the intellectual property of the Macrovision Corporation and other manufacturers. Use of this copyrighted material must be approved by Macrovision. Unless otherwise agreed with Macrovision, media with this protection may only be used for private purposes. The copying of this technology is strictly forbidden.

Music collection

Music, storing

The music tracks from CDs, DVDs and USB devices can be stored in the music collection in the vehicle and played from there.

- ▷ Audio CD: tracks are converted into a compressed audio format when they are stored. If available, information on the album, such as the artist, is stored as well.
- ▷ CD/DVD or USB device with compressed audio files: the entire content of the CD/DVD or the USB device is stored in the vehicle as an album. After storing, the tracks and directories can be deleted individually. Files are only stored in the WMA, MP3, and AAC formats.
Tracks with DRM copy protection can be stored in the vehicle but cannot be played back.

 Regularly back up the music data; otherwise, it could be lost if there is a fault on the hard disk. ◀

 Music recognition technology and related data are provided by Gracenote®. Gracenote® is the industry standard in music recognition technology and related content delivery. For more information, please visit www.gracenote.com.

CD and music-related data from Gracenote, Inc., copyright © 2000-2009 Gracenote. Gracenote Software, copyright 2000-2009 Gracenote. This product and service may practice one or more of the following U.S. Patents: 5,987,525, 6,061,680, 6,154,773, 6,161,132, 6,230,192, 6,230,207, 6,240,459, and 6,330,593 as well as other granted or pending patents. Some services supplied under license from Open Globe, Inc. for U.S. Patent: 6,304,523.

Gracenote and CDDb are registered trademarks of Gracenote. The Gracenote logo and logotype and the "Powered by Gracenote" logo are trademarks of Gracenote.

Storing CDs/DVDs

CDs/DVDs can only be stored by the CD/DVD player.

1. Insert a CD/DVD into the CD/DVD player.
2. "CD/Multimedia"
3. "CD/DVD"
4. Select the  symbol for the CD/DVD player.
5. "Store in vehicle"



The music collection is displayed. The tracks are stored and played back in sequence from the music collection.

Observe the following during the storage process:

Do not switch back to the CD/DVD player and do not remove the CD/DVD from the CD/DVD player, otherwise the storage process will be interrupted.

You can switch to the other audio sources without interrupting the storage process. Tracks from the current CD/DVD can also be called up, if they have been stored already.

Interrupting storage

1. "CD/Multimedia"
2. "CD/DVD"

3. "Storing..."

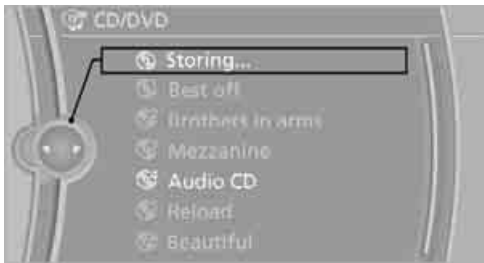

4. "Cancel storing"

The storage process is interrupted and can be continued at any time.

Continuing the storage process

1. "CD/Multimedia"
2. "CD/DVD"
3. Select the  symbol for the CD/DVD player.
4. "Continue storing"

Storage of the CD continues at the beginning of the track at which storage was interrupted.

Album information

During storage, information such as the name of the artist is stored with the track, if this information is available in the vehicle database or on the CD.

Storing from a USB device

To store music, a suitable device must be connected to the USB interface in the glove compartment.

- ▷ Suitable devices: USB mass storage devices, such as USB flash drives or MP3 players with a USB interface.
- ▷ Unsuitable devices: USB hard disks, USB hubs, USB memory card readers with multiple inserts, Apple iPod/iPhone.

 Music from a USB device can be stored only via the USB interface in the glove compartment. ◀

1. Connect the USB device to the USB interface in the glove compartment.
2. "CD/Multimedia"
3. "Music collection"
4. Open "Options".
5. "Music data import/export"
6. "Import music (USB)"



Playing music

Music search

All tracks for which additional information has been stored can be accessed by the music search. Tracks without additional information can be called up via the corresponding album.

1. "CD/Multimedia"
2. "Music collection"
3. "Music search"



- Select the desired category.



- To select the desired entry:
 - ▶ Open "A-Z search" and enter the desired entry.
 - or
 - ▶ Select the desired entry from the list.
- Select additional categories if desired. The tracks found are listed in alphabetical order. Not all categories need to be selected. For example, to search for all tracks by a certain artist, select that artist only. All of the tracks by that artist are then displayed.
- "Start play"

Restarting the music search

"New search"

Current playback

The list of tracks that was generated last by the music search or the album selected last.

- "Current playback"



- Select the desired track, if necessary.

Top 50

List of the 50 most frequently played tracks.

- "CD/Multimedia"
- "Music collection"
- "Top 50"
- Select the desired track, if necessary.

Albums

All stored albums, listed in order of their storage dates. Symbols indicate the format.

| Symbol | Format |
|--------|------------------------|
| | Audio CD |
| | Compressed audio files |

- "CD/Multimedia"
- "Music collection"
- Select the desired album.



Depending on the album, the tracks or the subdirectories of the album are displayed. The first track is played automatically, if possible.

- To select tracks, change directories if needed. To go up one level in the directory, move the controller to the left.

Random play sequence

All tracks of the selection are played back in random order.

- "CD/Multimedia"
- "Music collection"
- Open "Options".

4. "Random"



Managing music

Albums

Renaming an album

The name of the album, if available, is automatically entered when the album is stored. If the name is unknown, it can be changed later.

An album cannot be renamed while a track from that album is being played.

1. "CD/Multimedia"
2. "Music collection"
3. Highlight the album.
4. Open "Options".
5. "Rename album"



6. Select the letters individually.

Deleting an album

An album cannot be deleted while a track from the album is being played.

1. "CD/Multimedia"
2. "Music collection"
3. Highlight the album.

4. Open "Options".
5. "Delete album"

Deleting a directory or track

A track cannot be deleted while it is being played.

A directory cannot be deleted while a track from the directory is being played.

1. "CD/Multimedia"
2. "Music collection"
3. Highlight the directory or track.
4. Open "Options".
5. "Delete folder" or "Delete track".

Free memory capacity

Display the free memory capacity in the music collection.

1. "CD/Multimedia"
2. "Music collection"
3. Open "Options".
4. "Free memory"

Music collection

Backing up the music collection

The entire music collection can be stored on a USB medium. Make sure there is enough free memory capacity on the USB device.

Depending on the number of tracks, backing up the music collection may take several hours. Therefore, it is best to perform the backup during a long trip.

1. Start the engine.
2. Connect the USB device to the USB interface in the glove compartment.
3. "CD/Multimedia"
4. "Music collection"
5. Open "Options".

6. "Music data import/export"

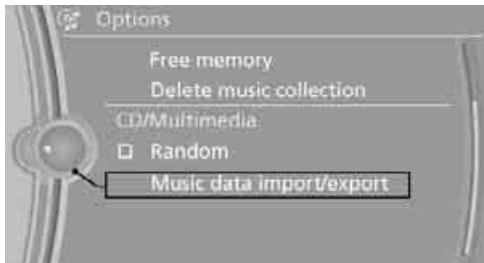

7. "Backup music on USB"



Restoring the music collection in the vehicle

 When storing from the USB device, the music collection existing in the vehicle is replaced. ◀

1. "CD/Multimedia"
2. "Music collection"
3. Open "Options".
4. "Music data import/export"
5. "Restore music from USB"

Deleting the music collection

1. "CD/Multimedia"
2. "Music collection"
3. Open "Options".
4. "Delete music collection"

External devices

AUX-IN connection

You can connect an external audio device, e.g. an MP3 player, and play the sound via the vehicle speakers. The sound can be adjusted via iDrive.

Connecting



Open the lid of the center armrest.

Connection for audio playback:
TRS connector 1/8 in/3.5 mm

To play audio tracks through the vehicle's speaker system, connect the headphone or line-out port of the device with the AUX-IN connection.

Starting audio playback

Connect the audio device, switch it on and select a track. Operate the system on the audio device.

Using iDrive

1. "CD/Multimedia"
2.  "AUX front"

Adjusting volume

The volume of the sound output depends on the audio device. If this volume differs markedly from the volume of the other audio sources, it is advisable to adjust the volumes.

1. "CD/Multimedia"
2. Then say "External devices" if applicable.
3.  "AUX front"

4. "Volume"

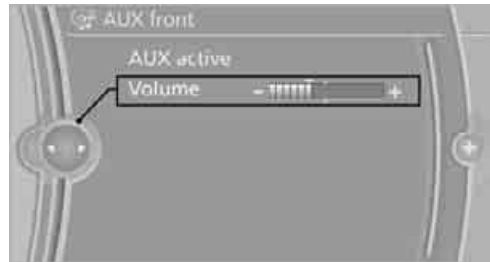

5. To adjust: turn the controller.
6. To store: press the controller.

USB-audio interface*/ extended connectivity of music player in mobile phone*

It is possible to connect external audio devices/mobile phones. They can be operated using iDrive. Sound is output on the vehicle loudspeakers.

Options for connecting external devices

- ▷ Connection via USB audio interface: Apple iPod/iPhone, USB devices, e.g. MP3 players, USB memory sticks, or mobile phones that are supported by the USB audio interface.
- ▷ Connection via snap-in adapter*, refer to page 212, when equipped with expanded connection of the music player in the mobile phone: Apple iPhone/mobile phones. Playback is possible only if no audio device/mobile phone is connected to the USB-audio interface.

Due to the vast array of audio devices/mobile phones on the market, it is not possible to assure that every audio device/mobile phone can be operated via the vehicle.

Ask your BMW Sports Activity Vehicle Center,

which audio devices/mobile phones are compatible.

Audio files

Standard audio formats, e.g. MP3, WMA, WAV (PCM) and AAC, and playlists in the M3U format can be played.

Connecting via USB-audio interface

Open the lid of the center armrest.

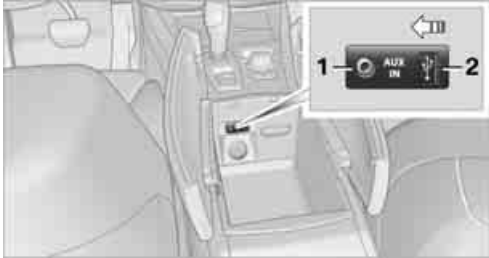

- 1 AUX-IN connection for audio playback: TRS connector 1/8 in/3.5 mm
- 2 USB interface

Apple iPod/iPhone

Use the special cable adapter for Apple iPods/iPhones, which you can obtain from your BMW Sports Activity Vehicle Center. The cable adapter is required for a proper connection.

Connect the Apple iPod/iPhone to the AUX-IN connection and USB interface **1** using the cable adapter for Apple iPod/iPhone.

The menu structure of the Apple iPod/iPhone is supported by the USB audio interface.

USB device

 When connecting the device use a flexible adapter cable, to protect the USB interface and your USB device against physical damage. ◀

Connect the USB device to connector **2**, using a flexible adapter cable.

When the device is connected for the first time, the information on all tracks (e.g. artist, type of music) and the playlists are transferred from the USB device to the vehicle. This process can

take some time. The time required is dependent on the USB device and on the number of tracks.

During transmission, the tracks can be accessed via the file directory.

Information from up to four USB devices can be stored in the vehicle, or a total of about 16,000 tracks.

If a fifth USB device is connected or if more than 16,000 tracks are stored, information on existing tracks may be deleted.

 Music tracks with integrated Digital Rights Management (DRM) cannot be played. ◀

Starting audio playback

If the audio device has a device name, this will be displayed if possible.

1. "CD/Multimedia"
2. "External devices"
3. Select the  symbol.
The name of the audio device may appear.



The playback starts with the first track. If an Apple iPhone is connected via the snap-in adapter while an audio device is connected to the AUX-IN connection at the same time, the audio signal of the AUX-IN connection will be played.

Information about the track

If information about a track has been stored, it is displayed automatically:

- ▷ Artist
- ▷ Album title
- ▷ Number of tracks
- ▷ Track file name

Track search

You can access the tracks via the playback lists and information. With USB devices you can also access the tracks via the file directory.

Selection is possible via:

- ▷ Playback lists
- ▷ Information: type of music, artist, album, title
- ▷ Additionally for USB devices: file directory, composer

Track titles are displayed if they have been stored in the Latin alphabet.

Starting the track search

1. "CD/Multimedia"
2. "External devices"
3. Select the  symbol.
The name of the audio device may appear.
4. Select the desired category, "Genre", "Artist".



All entries are displayed in a list. The "A-Z search" can be used to find specific entries.

- ▷ Open "A-Z search" and enter the desired entry.
 - ▷ Select the desired entry from the list.
5. Select additional categories if desired.
The tracks found are listed. Not all categories need to be selected. For example, to search for all tracks by a certain artist, select that artist only. All of the tracks by that artist are then displayed.
 6. "Start play"

Restarting a track search

"New search"

Playback lists

To open playback lists.

1. "CD/Multimedia"
2. "External devices"
3. Select the  symbol.
4. "Playlists"

Current playback

List of tracks currently being played.

1. "CD/Multimedia"
2. "External devices"
3. Select the  symbol.
4. "Current playback"

Random play sequence

You can play the tracks in the selected list in random order, e.g. all tracks of a single artist.

1. "CD/Multimedia"
2. "External devices"
3. Open "Options".
4. "Random"

Fast forward/reverse

Press and hold the  button for the corresponding direction.

Notes

 Do not subject the audio device to extreme environmental conditions, e.g. extremely high temperatures, refer to the operating manual of the audio device. Otherwise the audio device may be damaged, impairing driving safety while driving. ◀

Depending on the configuration of the audio files, e.g. bit rates greater than 256 Kbit/s, proper playback cannot always be ensured.

Information on connection

- ▷ The connected audio device is supplied with a current of max. 500 mA, if the device supports this. Therefore, do not connect the device to the power socket in the vehicle.
- ▷ Do not use force when plugging the connector into the USB interface.
- ▷ Do not connect any devices, e.g. fans or lamps, to the USB audio interface.
- ▷ Do not connect USB hard disks.
- ▷ Do not use the USB audio interface to recharge external devices.

DVD system in rear*

With the DVD system in the rear you can play CDs and DVDs with audio, video and image data. The DVD system can also play data from attached external audio and video devices. Audio output is possible both via headphones and via the vehicle speakers.

You can control the DVD system using the buttons on the CD-/DVD player or using the remote control.

 You operate some functions using the remote control. ◀

Enabling DVD system

The DVD system can be enabled via iDrive.

1. "Settings"
2. "Allow rear control"
3. "Rear DVD system active"



 DVD-System is enabled.

Controls

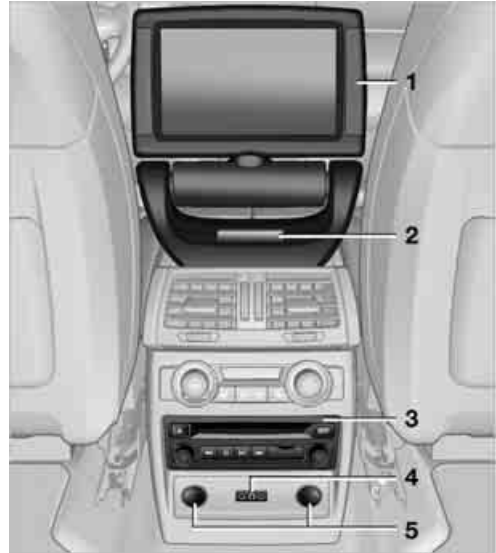

- 1 Display screen
- 2 Infrared interface for headphones
- 3 CD/DVD player
- 4 Headphone connection:
Jack 1/8 in/3.5 mm
- 5 12 V sockets, refer to page 121

Folding in display screen

When using the ski bag or when transporting bulky pieces of luggage, the display screen should be folded in, as otherwise it may be damaged.

 When the screen is folded down, do not open the lid of the center arm rest or rest your arm on the screen; otherwise, you may damage the screen. ◀



1. Turn display screen, arrow 1.
The display screen switches off.
2. Fold in display screen, arrow 2.
The display screen is folded out in the reverse order.

CD/DVD player

Controls

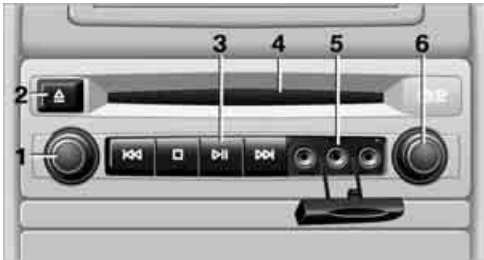

- 1 Press: switching the DVD system on and off
Rotate: left headset volume and vehicle volume
- 2 Ejecting CD/DVD
- 3 Start track
 Stop
 Playback, pause, freeze-frame
 Next track
- 4 CD/DVD slot
- 5 Connection for external device: RCA jacks
- 6 Press: switching the DVD system on and off
Rotate: right headset volume and vehicle volume

Connecting headphones

You can connect headphones with a phone jack 1/8 in/3.5 mm or operate them using the infrared interface.

To enable optimal use of the infrared interface, use infrared headphones that comply with the IEC 61603-2 standard.

- ▶ Compatible infrared headphones and information about supported headphones are available at your BMW Sports Activity Vehicle Center.

When using infrared headphones, it is important not to interrupt the infrared connection between the headphones and the infrared interface, refer to page 187. This means that no obstacle should come between the two and that the cover of the infrared interface should not be covered or scratched. Unfavorable lighting conditions such as glare from outside can interfere with reception. ◀

Remote control

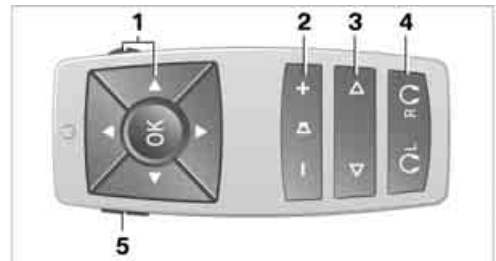

- 1 Menu navigation
- 2 Volume for headphones with jack plug
- 3 Changing track or chapter during CD-, DVD- or AUX playback, fast forward/rewind
- 4 Headphones right/left
- 5 Open start menu for DVD system

Menu navigation

You can use the thumbwheel and buttons 1 to navigate through the menus.

- ▶ Turn the thumbwheel:
To select a menu item.

- ▷ Press the arrow buttons:
To switch between windows.
- ▷ Press the **OK** button:
To activate the menu item.

The transmission time of the remote control is limited in accordance with legal guidelines. A function can be repeated by pressing or turning the appropriate button or knob.

Changing batteries



1. Press the detent and remove the cover.
2. Change the batteries. The type and installation position are marked on the bottom of the battery compartment.
3. Close the cover.

 Return old batteries to a collection point or to your BMW Sports Activity Vehicle Center. ◀

Setting the language of the DVD system

1. Select a CD/DVD track.
2. Press the **OK** button.
3. Select "Tone".
4. Press the **OK** button.
5. Switch to the top window.
6. Select "Language".
7. Press the **OK** button.
8. Select the desired language.
9. Press the **OK** button.

Sound output via speakers

In addition to the headphones, you can also play the sound via the vehicle speakers.

1. "CD/Multimedia"
2. "External devices"
3. "AUX/rear"

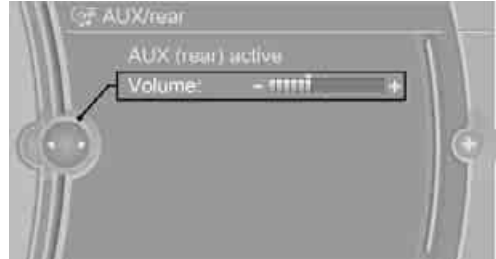

Switching DVD system on/off

Press the button on the CD-/DVD player or under the desired screen.

The DVD system switches on automatically when a CD or DVD is inserted.

Playing CD/DVD

Use the following menu items to access data from a CD/DVD:

- ▷ Video data via "DVD"
- ▷ Audio data via "CD"
- ▷ Pictures via "Photo".



Playing videos from CDs/ DVDs

Country codes of DVDs

Your DVD player only plays DVDs with the coding of your home region, e.g. Europe = 2. The country codes supported by your DVD are contained in the information on your DVD.

An overview of the coding zones:

| Code | Region |
|------|---|
| 1 | USA, Canada |
| 2 | Japan, Europe, Middle East, South Africa |
| 3 | Southeast Asia |
| 4 | Australia, Central and South America, New Zealand |
| 5 | Northwest Asia, North Africa |
| 6 | China |

 DVDs with the code 0 can be played on all devices. ◀

Starting playback

1. Push the CD/DVD into the drive with the labeled side facing upward. The CD/DVD is automatically pulled in.
 - ▷ Playback begins automatically after a few seconds.
 - ▷ If it does not: Select "DVD". Press the  button.
2. If the DVD control or the DVD-specific menu is displayed when a DVD is inserted, use the remote control buttons for menu navigation to select the desired option.

Or:

Press the  button on the CD/DVD player.

You can control the playback with the buttons on the CD/DVD player or the DVD control.

 Video-CDs, VCDs, and Super-Video-CDs, i.e. SVCDs, can only be played if they do not have a DVD-specific menu. ◀

Ejecting CD/DVD

Press the  button on the CD/DVD player. The DVD emerges slightly from the drive.



DVD control









With the DVD control, you can select the title and chapter, open the DVD-specific menu and operate functions such as Language, Fast forward and Reverse or Freeze frame.

A DVD can briefly deactivate functions of the DVD control, under certain circumstances while the entire DVD is being played. It is not possible to operate the DVD control under these circumstances. In this case, try to make the selection using the DVD-specific menu.

1. Press the  button on the remote control during playback.



2. Press the  buttons on the remote control or turn the thumbwheel to select the desired function.
3. Press the  button.

| Symbol | Function |
|---|--------------------------------------|
|  | Exit DVD control |
| "SET" | Settings for playing DVD |
|  | Starting playback |
|  | Stop playback |
|  | Activate and deactivate freeze frame |
|   | Skipping chapter |
|   | Fast forward/reverse |
| "Menu" | Open DVD-specific menu |





The DVD control disappears again after a short time if you have not selected a function.

Or:

Press the  button on the remote control to exit the DVD control.



Fast forward/reverse

Forward/reverse with DVD control

1. Press the  button on the remote control during playback.
2. Select the  symbol.
3. Press the  button.
4. Press the  button several times to increase the fast forward/reverse speed.

The DVD playback will be distorted.

To cancel fast forward/reverse:

1. Select the  symbol.
2. Press the  button.

Or:

Press the  button on the CD/DVD player.

The DVD will start play at the point selected.

Forward/reverse with remote control



Press and hold the  button until you reach the desired point.

Or:

1. During playback, turn the thumbwheel. Fast forward/reverse is interrupted.
2. Continue to turn the thumbwheel. The speed is increased.
3. Press the  button on the CD/DVD player. Fast forward/reverse is interrupted. The DVD will start play at the point selected.

Skipping chapter

You can change to the next or previous chapter during playback.

1. Press the  button on the remote control during playback.
2. Select the  symbol.
3. Press the  button repeatedly, continuing until you reach the desired chapter.



Or:

Press the  button on the left or right on the remote control repeatedly until you reach the desired chapter.



Freeze frame

1. Press the  button on the remote control during playback.



2. Select the  symbol.
3. Press the  button.

To continue playback:

1. Select the  or  symbol.
2. Press the  button.

As an alternative, you can also stop and continue playback with the  button on the CD/DVD player.



Making settings for DVD

1. Press the  button during playback.



2. Make the settings with the remote control:
 - ▷ "Video settings":
 - ▷ "Brightness", "Color" and "Contrast" of the screen
 - ▷ After switching to the top window, you can change other settings. "Language":

The system language of the DVD system
 "Display": background brightness of screen.



- ▷ "Tone":
 - ▷ "Treble / Bass" and "Balance": Separately adjustable for the left and right-hand headphones and the infrared headphones.
 - ▷ "Reset": The settings are reset to the default value.
- ▷ "DVD format":
 - ▷ "Standard"
 - ▷ "Zoom": full-screen playback
- ▷ "Language": Language of the DVD playback. The language advances one setting each time the menu item is selected.
- ▷ "Subtitles": Language of subtitles or turn off subtitles
- ▷ "Title": Selecting individual tracks on the DVD
- ▷ "Angle of view": Camera angle
Notes or symbols that appear during the playback of a film generally point out different camera angles. These are usually only briefly available.
- ▷ "Menu": Call up the DVD-specific menu.
- ▷ "Return": Exit menu or:
Press the   buttons on the remote control.

Many DVDs offer dialogs and subtitles in various languages or scene descriptions for the hearing impaired. These functions are stored on the DVD.

 With some DVDs, it is only possible to select language, subtitles, camera angle, or title by using the DVD-specific menu. Consult the information accompanying your DVD. ◀





Opening the DVD-specific menu

Additional functions may be available on DVDs. It is thus possible, for example, to select from among several possible actions or to access information about the film.



1. Press the  button on the remote control during playback.
2. Select "Menu".
3. Press the .

 On some DVDs, you can use "Main menu" and "Title" to access additional menus in which you can select magazine segments about the music scene, for example. ◀

To make a selection:

1. Select the  symbol.
2. Press the  button until the desired function is selected.
3. Select the  arrow.
4. Press the .

To return to the start menu:

1. Select the  arrow.
2. Press the .

 You can also select language, subtitles, camera angle, or title in the DVD-specific menu.

Consult the information accompanying your DVD. ◀

Compressed video files

Playback

1. Select the directory if necessary.



2. Press the .

3. Select a track.



4. Press the **OK** button.
5. Select "Play".
6. Press the **OK** button.

To change the directory:

1. Select the directory.



2. Press the **OK** button.

Playback functions

1. Select a track.
2. Press the **OK** button.
3. Select a menu item:
 - ▷ "Pause":
Stop and continue playback.
 - ▷ "Repeat track":
Repeat selected track.
 - ▷ "Repeat directory":
Repeat the tracks in the current directory.
4. Press the **OK** button.

Playing audio tracks from CD/DVD

Starting playback

Push the CD/DVD into the drive with the labeled side facing upward. The CD/DVD is automatically pulled in.

- ▷ Playback begins automatically after a few seconds.
- ▷ If it does not:
Select "CD".
Press the **OK** button.

CDs/DVDs with compressed audio files, refer to page 194, can take approx. 1 minute to read, depending on their directory structure.

To play back audio tracks from a DVD, refer to Compressed audio files page 194.

To start playback if a CD is already in the drive:

1. Open the start menu with the remote control.
2. Select "CD".
3. Press the **OK** button.

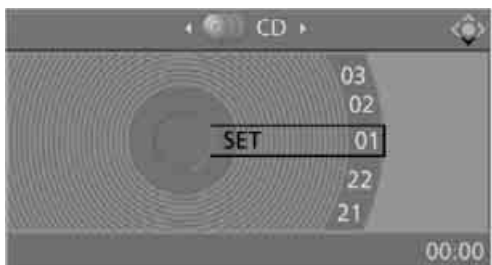

As an alternative, you can also control the playback with the buttons on the CD/DVD player.

To eject CD/DVD:

Press the **EJECT** button on the CD/DVD player.

Selecting a track

Buttons on CD/DVD player

Press the **SKIP** **REPEAT** button for the corresponding direction repeatedly until you reach the desired track.

Playback begins at the start of the track.

Using the remote control

Press the ◀ ▶ button for the corresponding direction repeatedly or turn the thumbwheel until you reach the desired track. Playback begins at the start of the track.

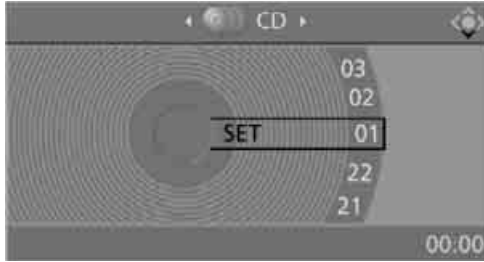

Settings and playback functions for audio CDs

1. Select "SET".
2. Press the OK button.

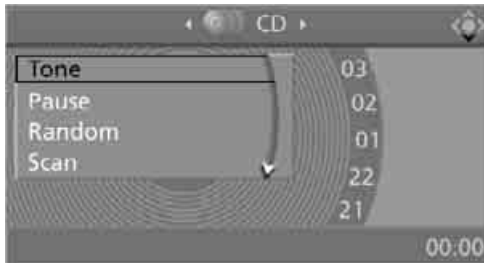

3. Make the settings with the remote control:
 - ▷ "Tone":
 - ▷ "Treble / Bass" and "Balance": separately adjustable for the left and right headphones and infrared headphones.
 - ▷ "Reset": The settings are reset to the default value.
 - ▷ "Pause": Stop and continue playback.
 - ▷ "Random": The tracks of the CD are played back once in random sequence.
 - ▷ "Scan": Brief samples of all tracks on the CD are automatically played one after another.

- ▷ "Repeat": Repeat the current track. Select again to end.

To exit from the menu:

Press the ▶ ◀ buttons on the remote control.

Fast forward/reverse

Buttons on the CD/DVD player:

Press and hold the ⏮ ⏭ button for the corresponding direction.

Compressed audio files

Playback

1. Select the directory if necessary.



2. Press the OK button.
3. Select a track.

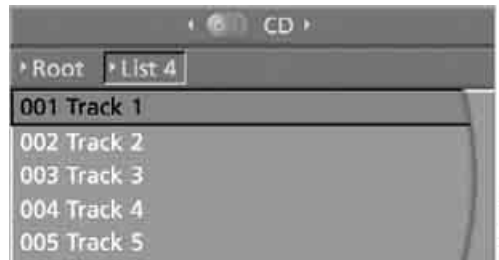

4. Press the OK button.
5. Select "Play".
6. Press the OK button.

To change the directory:

1. Select the directory.



2. Press the **OK** button.

Settings and playback functions for compressed audio files

1. Select a track.
2. Press the **OK** button.
3. Make the settings with the remote control:
 - ▷ "Tone":
 - ▷ "Treble / Bass" and "Balance": Separately adjustable for the left and right-hand headphones and the infrared headphones.
 - ▷ "Reset": The settings are reset to the default value.
 - ▷ "Pause": Stop and continue playback.
 - ▷ "Scan directory": Briefly sample the tracks in the current directory.
 - ▷ "Scan all": Briefly sample all tracks.
 - ▷ "Random directory": Play the tracks in the current directory in a random sequence.
 - ▷ "Random all": Play all tracks in a random sequence.
 - ▷ "Repeat track": Repeat the selected track.
 - ▷ "Repeat directory": Repeat the tracks in the current directory.

- ▷ "Details": Display any stored information on the current track.

To exit from the menu:

Press the **Back** buttons on the remote control.

Displaying images from CD/DVD

1. Push the CD/DVD into the drive with the labeled side facing upward. The CD/DVD is automatically pulled in.
2. Open the start menu with the remote control.
3. Select "Photo".
4. Press the **OK** button.

Displaying overview

1. Select the subdirectory if necessary.
2. Select "Overview".

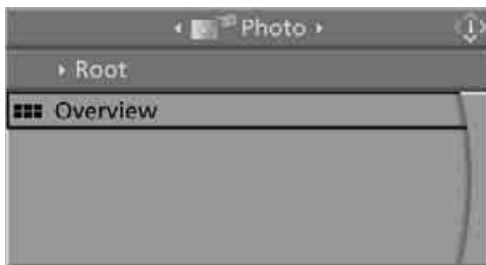

3. Press the **OK** button.

It may take some time until the overview is completely displayed.

 If a symbol appears instead of an image, the image cannot be displayed in the overview. ◀

Displaying images

1. Use the buttons or the thumbwheel of the remote control to select an image.
2. Press the **OK** button.



3. Displaying images:

- ▷ Scroll using the menu navigation buttons of the remote control
- ▷ Show slide show:
Turn the thumbwheel to adjust how long each image is displayed.
Stop slide show:
Select "Stop"

Adjusting

1. Press the **VIEW** button.



2. Select a menu item:

| Symbol | Function |
|--------|--|
| | Return to the photo menu |
| "SET" | Adjust the screen "Display". "Language": after switching to the top window, you can change the system language. |
| | Start slide show |

| Symbol | Function |
|------------|---|
| | Display first/last picture of the current directory |
| | Rotate image by 90° |
| "Overview" | Change to image overview |

3. Press the **OK** button.

Ending display

1. Press the **VIEW** button.
2. Select the symbol.
3. Press the **OK** button.

Ejecting CD/DVD

Press the **EJECT** button on the CD/DVD player.

Information on CD/DVD player

Safety notes

The BMW CD/DVD player is a Class 1 laser product. Do not operate if the cover is damaged; otherwise, severe eye damage can result. ◀

Suitable media

Do not use self-recorded CDs/DVDs with labels applied as these can become detached during playback due to heat buildup and can cause irreparable damage to the device.

Only use round CDs/DVDs with a standard diameter of 4.7 in/12 cm.

Do not play CDs/DVDs using an adapter, e.g. CD singles; otherwise, the CD may jam and no longer eject properly.

Do not use combined CD/DVDs, e.g. DVD^{Plus} or hybrid discs; otherwise, the CD/DVD may jam and no longer eject properly. ◀

The CD/DVD player can play the following media:

- ▷ Video DVD
- ▷ CD-DA (Audio CD)

- ▷ CDs/DVDs with compressed image data
- ▷ CDs/DVDs with compressed audio data
- ▷ CDs/DVDs with compressed video data

The DVD player does not support DVD audio. However, many audio DVDs available in stores also contain a video track in the DVD Video format in addition to the audio track. These DVDs can be played back by the DVD player. Refer to the information on your DVD to determine whether your audio DVD contains an additional video track. Depending on the authoring used, it is possible that not all functions are available during playback.

Dual-sided DVDs available from retail suppliers are coated on both sides and bear no markings. This means both sides are information carriers. To play the information on the other side, turn over the DVD.

Supported formats

Depending on the compression method used, not all files of the specified formats can be opened.

Images

JPEG/JPG

With very large image files, it can take longer for the images to be displayed.

Compressed audio files

- ▷ MP3
- ▷ WMA
- ▷ OGG
- ▷ AAC

Compressed video files

- ▷ SVCD
- ▷ MPEG1
- ▷ MPEG2
- ▷ MPEG4/DivX

Digital Rights Management (DRM)

In some cases, it may not be possible to play CDs/DVDs with integrated Digital Rights Management (DRM).

General malfunctions

The BMW CD/DVD player is optimized for operation in the vehicle. It may react more sensitively to defective CDs/DVDs than devices intended for stationary use.

If a CD/DVD cannot be played, first check whether it has been inserted correctly.



Make sure that no foreign objects or liquids get into the CD/DVD slot; otherwise, the CD/DVD player will be damaged. ◀

Humidity

High levels of humidity can lead to condensation on the CD/DVD or the laser's scan lens and temporarily prevent playback.

Malfunctions with individual CDs/DVDs

If malfunctions occur only with particular CDs/DVDs, this can be due to one of the following causes.

Copied or self-recorded CDs/DVDs

Possible reasons for malfunctions with copied or self-recorded CDs/DVDs may include inconsistent data-creation or recording processes, or poor quality or significant aging of the CD/DVD blank.

Only label CDs/DVDs on the upper side with a pen intended for this purpose.

Damaged CDs/DVDs

Avoid fingerprints, dust, scratches and moisture.

Store CDs/DVDs in a sleeve.

Do not subject CDs/DVDs to temperatures above 122 °F /50 °C or to high humidity levels or direct sunlight.

CDs/DVDs with copy protection

CDs/DVDs are often provided with a copy protection feature by the manufacturer. As a result,

some CDs/DVDs cannot be played, can only be played to a limited degree, or cause the system to switch off. In this case, wait a short while and then switch the system back on again. Then remove the CD/DVD from the drive.

CDs/DVDs with compressed audio files

If the language set for the CD/DVD player does not match the language of the music track, the music tracks may be displayed incorrectly.

Care instructions

More information about this can be found under Care, starting on page 246.

External device

Connecting

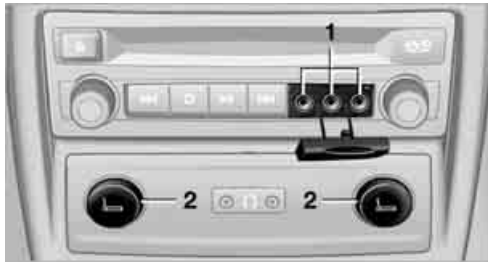

- 1 Connections for audio/video cables:
Watch the colors of the sockets when connecting.
Yellow socket: video
White socket: audio left
Red socket: audio right
- 2 Power supply for external device: socket with removable cap, also refer to page 121.

Playback

1. Switch on the external device and start the playback.
2. Open the start menu with the remote control.
3. Select "AUX".

4. Press the **OK** button.



For devices without a video signal, e.g. MP3 players, "No video signal" appears in the display. The sound is nevertheless played.

Settings for external devices

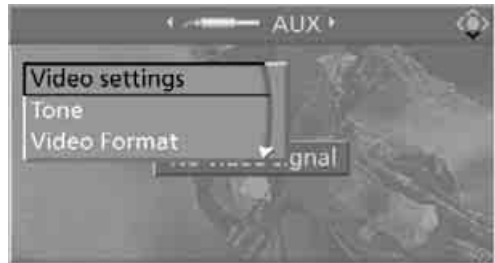

1. Press the **OK** button during playback.



2. Make the settings with the remote control:
 - ▷ "Video settings":
 - ▷ "Brightness", "Color" and "Contrast" of video playback
 - ▷ "NTSC color":
The color can be adjusted on an external device with the NTSC standard.
 - ▷ "Standard":
The DVD system can be adapted to external devices with different TV standards; to do so, consult the instruction manual of the external device.
 - ▷ "Reset":
The settings are reset to the default value.

- ▷ "Tone":
 - ▷ "Treble / Bass" and "Balance":
Separately adjustable for the left and right-hand headphones and the infrared headphones.
 - ▷ "Reset":
Your settings are reset.
 - ▷ After switching to the top window, you can change other settings.
"Audio": adjust the volume of the external device to the volume of the CD/DVD player.
"Language":
the system language of the DVD system
"Display":
background brightness of screen.
- ▷ "Video Format":
 - ▷ "Standard"
 - ▷ "Zoom": full-screen playback

To exit from the menu:

Press the   buttons on the remote control.



Communications

This chapter summarizes how to operate your mobile phone using iDrive or voice control and how to use BMW Assist or BMW TeleServices.

Telephone*

The concept

Your BMW is equipped with a full preparation package mobile phone. After pairing a suitable mobile phone with the vehicle once, you can operate the mobile phone using iDrive, the buttons on the steering wheel, or voice commands*.

Once a mobile phone has been paired with your vehicle, it is automatically recognized as soon as it is inside the vehicle while the engine is running or the ignition is switched on. The pairing data of up to four mobile phones can be stored simultaneously. If several mobile phones are detected simultaneously, the respective last mobile phone paired can be operated via the vehicle.

Using a phone in your vehicle

Using snap-in adapter*

The so-called snap-in adapter, a mobile phone cradle, enables the battery to be charged and the mobile phone to be connected to the external antenna of your vehicle. This ensures improved network reception and a consistent voice reproduction quality. Ask your BMW Sports Activity Vehicle Center which mobile phones snap-in adapters are offered for.

For your safety

A car phone makes life more convenient in many ways, and can even save lives in an emergency. While you should consult your mobile phone's separate operating instructions for a detailed description of safety precautions and information, we request that you direct your particular attention to the following:



Only make entries when the traffic situation allows you to do so. Do not hold the mobile phone in your hand while you are driving; use the hands-free system instead. If you do not observe this precaution, your being dis-

tracted can endanger vehicle occupants and other road users. ◀

Suitable mobile phones

Please ask your BMW Sports Activity Vehicle Center which mobile phones with Bluetooth interface are supported by the mobile phone preparation package and which mobile phones are compatible with the snap-in adapter. By virtue of their particular software versions, these mobile phones support the functions described in this Owner's Manual. Malfunctions can occur with other mobile phones.

Operating options

You can operate the mobile phone using:

- ▷ Buttons on the steering wheel, refer to page 11
- ▷ iDrive, refer to page 16
- ▷ Voice commands*, refer to page 209
- ▷ Programmable memory buttons, refer to page 20

Avoid operating a mobile phone detected by the vehicle with the keypad of the mobile phone, otherwise malfunctions can occur.

Commissioning

Pairing mobile phone in vehicle

The following prerequisites must be met:

- ▷ Compatible mobile phone: the mobile phone is supported by the full mobile phone preparation package. Information on this subject is also provided on the Internet at: www.bmw.com/bluetooth
- ▷ The mobile phone is ready to operate.
- ▷ Bluetooth has been activated in the vehicle, refer to page 204, and on the mobile phone.

- ▷ Depending on the mobile phone, certain settings may be necessary on the mobile phone, e.g. via the following menu items:
 - ▷ Bluetooth activated
 - ▷ Connection must be allowed without requiring further confirmation
 - ▷ Reconnect
- ▷ Depending on the mobile phone model, the setting energy saving mode can, for example, result in vehicle failing to detect the paired mobile phone.
- ▷ For pairing purposes, define any 4 to 16-digit number as a Bluetooth passkey, e.g. 25081107. A long and complex number offers the best protection against unauthorized access. This Bluetooth passkey is no longer required following successful pairing.
- ▷ The ignition is switched on.

⚠ Only pair the mobile phone with the vehicle stationary, otherwise the passengers and other road users can be endangered due to a lack of attentiveness on the part of the driver. ◀

Switching on ignition

1. Insert the remote control as far as possible into the ignition lock.
2. Switch on ignition without operating the brake or clutch or pressing the start/stop button.

Preparation via iDrive

3. "Telephone"
4. "Bluetooth"
5. "Add new phone"



The Bluetooth name of the vehicle is displayed.

Preparation with mobile phone

6. Further steps must be carried out with the mobile phone and vary depending on the model. Please refer to your mobile phone's operating instructions, e.g. under the topics of Searching for a Bluetooth device, Linking or Pairing.

The Bluetooth name of the vehicle appears on the mobile phone display.
7. Select the Bluetooth name of the vehicle on the mobile phone display.

Pairing

Depending on your mobile phone, you will first be requested consecutively via the display of your mobile phone or iDrive to enter the Bluetooth passkey you specified.

8. Enter the Bluetooth passkey.

Depending on the mobile phone, approx. 30 seconds are available for entering the Bluetooth passkey on the mobile phone and on the Control Display.

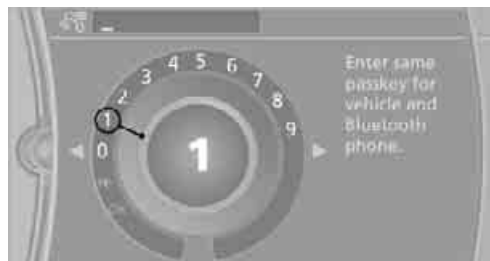

If pairing was successful, the mobile phone appears at the top of the list of mobile phones.

As soon as a mobile phone is detected by the vehicle, the phone book entries stored on the SIM card or on your mobile phone are transmitted to your vehicle. This transmission is dependent on your mobile phone, refer to the operating instructions of your mobile phone if necessary, and can take several minutes.

If not all phone book entries are displayed:

- ▷ Transfer all phone book entries from the SIM card to the mobile phone if necessary.

- ▷ It may not be possible to display phone book entries with special characters.

Checking if pairing is unsuccessful

- ▷ Is the mobile phone supported by the mobile phone preparation package? Information on this subject is also provided on the Internet at: www.bmw.com/bluetooth
- ▷ Do the Bluetooth passkeys on the mobile phone and the vehicle match? The same Bluetooth passkey must be entered both on the mobile phone display and via iDrive.
- ▷ Have you required longer than 30 seconds to enter the Bluetooth passkey? Then repeat the pairing procedure.
- ▷ Only a limited number of devices can be connected to the mobile phone. Delete the connection to other devices if necessary.
- ▷ The mobile phone no longer reacts? Switch the mobile phone off and then on again or disconnect the power supply.

Connecting a particular mobile phone

If more than one mobile phone is detected by the vehicle, the mobile phone at the top of the list is connected. A different mobile phone can be connected by selecting it.

1. "Telephone"
2. "Bluetooth"
3. Select the desired mobile phone.



Unpairing mobile phone from vehicle

1. Switch off the mobile phone.
2. "Telephone"
3. "Bluetooth"

4. Highlight the mobile phone that is to be unpaired.
5. Open "Options".
6. "Remove phone from list"



The unpaired mobile phone is deleted from the list.

The phone book entries and the lists of stored phone numbers are also deleted.

Activating/deactivating Bluetooth link

▷ Bluetooth technology is not approved in all countries. Observe the applicable local regulations. Temporarily deactivate the Bluetooth link between the vehicle and the mobile phone if necessary.

If the Bluetooth link is deactivated, you cannot operate your mobile phone via the vehicle and other devices with a Bluetooth interface can be used via the mobile phone, e.g. a laptop computer. ◀

To temporarily deactivate the Bluetooth link between the vehicle and your mobile phone:

1. "Telephone"
2. Open "Options".
3. "Bluetooth"

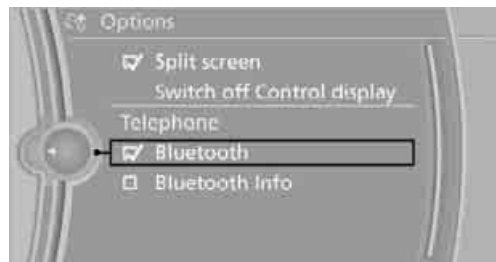

Adjusting volume

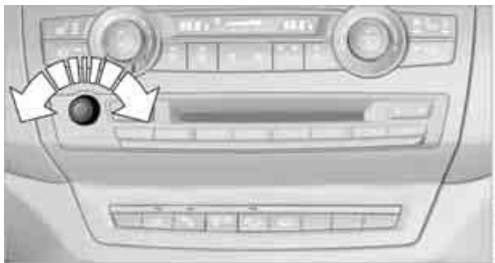

Turn the knob during a call to select the desired volume.

This volume for the hands-free system is maintained, even if the other audio sources are set to minimum volume.

The setting is stored for the remote control currently in use.

Operation via iDrive

You can operate the following functions via iDrive:

- ▶ Accepting/refusing a call
- ▶ dialing phone numbers
- ▶ Dialing phone numbers from the phone book
- ▶ Selecting stored phone numbers, e.g. from the list of received calls
- ▶ Ending a call

When the ignition is switched off or in radio readiness, e.g. after taking the remote control out of the ignition switch, you can continue an ongoing call via the hands-free system for several minutes.

Speech quality

If the person you are talking to is having difficulties understanding you, this may be due to excessive background noise. The full preparation package mobile phone can compensate for these noises to a certain extent. To optimize the speech quality during a call, we recommend that you:

- ▶ Reduce background noise, e.g. by closing the windows, reducing air flow from the automatic climate control or pointing the open front air vents downward.
- ▶ Reduce the volume of the hands-free system.

Requirements

- ▶ The pairing data of the mobile phone are stored in the vehicle and the mobile phone is ready to operate.
- ▶ The engine is running or the ignition is switched on.
- ▶ The mobile phone is detected by the vehicle.

Receiving calls

If you have the phone number of the caller stored in the phone book and the phone number has been transmitted, the name of the entry is displayed.

Accepting a call

Press the  button on the steering wheel or "Accept"

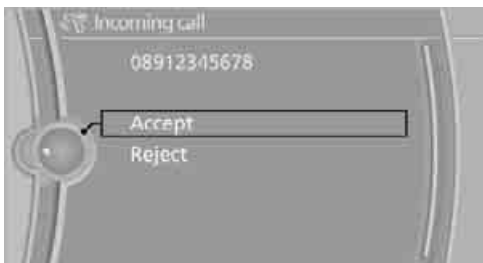

Rejecting a call

"Reject"
The caller is diverted to your mailbox if it has been activated.

Ending a call

Press the  button on the steering wheel or

1. "Telephone"
2. "Active calls"
3. Select an active call.

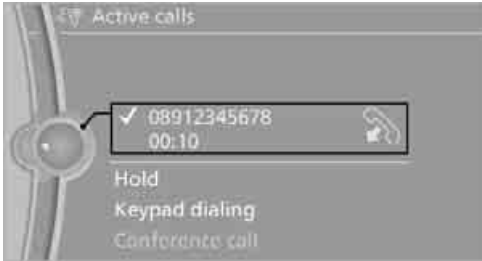

Dialing phone numbers

1. "Telephone"
2. "Dial number"
3. Select the digits individually.
4.  Select this symbol to establish the connection



or
press the  button on the steering wheel.

For your phone number to be displayed to the person you are calling, the display of phone numbers must be enabled by your service provider.

Calls with multiple parties

You can switch between calls and combine two calls to a single conference call. These functions must be supported by the mobile phone and the service provider.

Accepting a call while speaking to another party

This function may need to be enabled by the service provider, and the mobile phone may have to be set up accordingly.

If a second call comes in during an active call, you will hear a call waiting signal.

"Accept"

The call is accepted and the existing call is put on hold.

Establishing a second call

Establish another call during an active call.

1. "Telephone"
2. "Active calls"
3. "Hold"

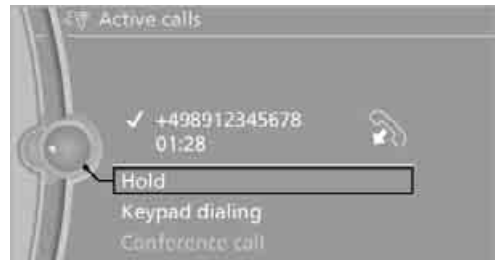

The existing call is put on hold.

4. Dial the new phone number or select it from a list.

Switching between two calls, toggling

- ▷ Active call: indicated by a red handset
- ▷ Call on hold: indicated by a green handset

To switch to the call on hold, select this handset.

Establishing a conference call

Two calls can be connected to a single telephone conference call.

1. Establish two calls.
2. "Conference call"



When terminating a conference call, both calls are ended.



Phone book

The phone book accesses the contacts* and shows all contacts for which a phone number has been stored. The entries can be selected to make a call.

1. "Telephone"
2. "Phone book"

All contacts with a phone number are displayed. A symbol indicates the storage location of the contacts.



| Symbol | Storage location |
|---|--|
| No symbol | In the vehicle; the address has not been checked as a destination. |
|  | In the vehicle; the address has been checked as a destination. |
|  | Mobile phone |

Calling a contact

1. Select the desired contact.
A connection is established immediately if calling contacts with one phone number.
For contacts with several phone numbers:
2. Select the desired phone number.
The connection is established.

Editing a contact

The entries in the contacts can be changed. When a contact from the mobile phone is changed, the changes are not stored on the mobile phone. A copy of the entry is stored in the vehicle.

1. Highlight the contact.
2. Open "Options".
3. "Edit entry"

The contact can be edited.

Redialing

The eight phone numbers dialed last are stored.

Dialing the number using iDrive

1. "Telephone"
2. "Redial"

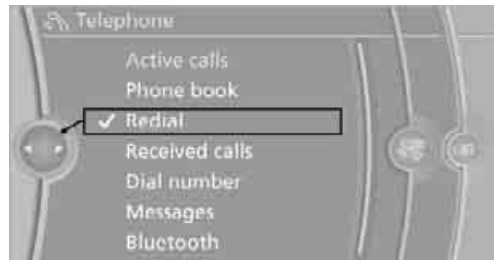

3. Select the desired entry.
The connection is established.

Deleting entries

1. Highlight the entry.
2. Open "Options".
3. "Delete entry" or "Delete list".

Saving an entry in the contacts

1. Highlight the entry.
2. Open "Options".
3. "Store as new contact" or "Add to existing contact".
4. Select the type of number: "Home", "Business" or "Mobile".
5. Complete the entries if necessary.
6. "Store in vehicle"

Received calls

The 20 calls that were last received are displayed.

1. "Telephone"
2. "Store contact"



Dialing a number

Select an entry.

The connection is established.

Deleting entries

1. Highlight the entry.
2. Open "Options".
3. "Delete entry" or "Delete list".

Saving an entry in the contacts

1. Highlight the entry.
2. Open "Options".
3. "Store as new contact" or "Add to existing contact".
4. Select the type of number: "Home", "Business" or "Mobile".
5. Complete the entries if necessary.
6. "Store contact"

Messages

Various types of messages can be displayed:

- ▷ SMS
 - Whether or not SMS are displayed depends on whether transmission to the vehicle is supported by the mobile phone. SMS may not be supported by the service provider, or the function may need to be enabled separately.
- ▷ My Info messages from the BMW Assist portal.
- ▷ Messages from BMW Concierge service

Displaying messages

1. "Telephone"
2. "Messages"

A symbol identifies the type of message.

3. Select the desired message.

SMS

To call the sender of an SMS:

1. Select the desired message.
2. Open "Options".
3. "Call sender"

To store the sender in the contacts:

1. Select the desired message.
2. Open "Options".
3. "Store as new contact" or "Add to existing contact".

My Info

Replying:

Sending a predefined reply.

1. Select the desired message.
2. Open "Options".
3. "Answer"

To start destination guidance:

1. Select the message that contains the desired destination.
2. "Start guidance" or "Add as another dest."

To dial the number in the message:

1. Select the message that contains the desired number.
2.  "Call"

Messages from the concierge service

To use the address in destination guidance*:

1. Select the message.
2.  "Start guidance" or "Add as another dest.".



3. Start destination guidance, if necessary.

To dial a phone number:

1. Select the message.
2.  "Call"

To save an address:

1. Select the message.
2. Open "Options".
3. "Store contact in vehicle"

Deleting messages

1. Select the message to be deleted.
2. Open "Options".
3. "Delete message"

Changing between mobile phone and hands-free system

From mobile phone to hands-free system*

You can continue calls begun outside the Bluetooth range of the vehicle via the handsfree system when the engine is running or the ignition is switched on. Depending on your mobile phone,

the system automatically switches over to the handsfree mode.

For mobile phones that do not automatically switch over to the handsfree mode:

Depending on the mobile phone model used, the conversation can be continued via the hands-free system if necessary. Refer to the display on your mobile phone and/or your mobile phone's operating instructions.

From handsfree system to mobile phone

When you telephone via the handsfree system, you can also continue the call via the mobile phone if necessary, depending on the mobile phone model. Act according to what is shown on the mobile phone display, refer to the operating instructions of your mobile phone.

Alternatively, you can deactivate the Bluetooth link, refer to page 204.

Depending on your mobile phone model, poor reception of the wireless communications network can result in the system changing from the hands-free system to the mobile phone.

Operation by voice*

The concept

You can operate your mobile phone without having to remove your hands from the steering wheel. When making your entries, you will be supported by announcements or questions in many cases.

The same prerequisites as for operation via iDrive apply, refer to page 205.

Voice commands

Activating system

1. Briefly press the  button on the steering wheel.
An acoustic signal indicates that you can say commands.
2. Say the command.

Ending/canceling operation by voice commands

Press the  button on the steering wheel or

 ›Cancel‹.

In dialogs where text is spoken, e.g. a name rather than a command, canceling is only possible using the button on the steering wheel.

Having possible commands read aloud

The system understands default commands that must be spoken word for word.

Example: dialing phone numbers

To start the dialog:

press the  button on the steering wheel.

| You say | The voice control answers |
|---------------------|--|
| ›Dial number‹ | ››Please say the number‹‹ |
| e.g. ›123 456 7890‹ | Depending on equipment: ››123 456 7890. Continue?‹‹ |
| ›Dialing‹ | ››Dialing number‹‹ |

Adjusting the volume of the instructions

You can adjust the volume for the instructions from the system:

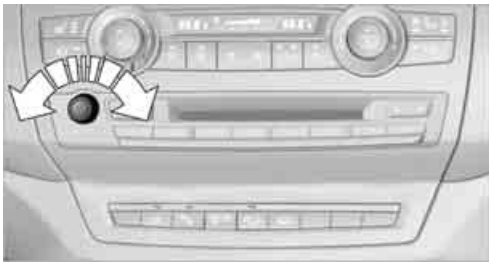

Turn the button during an instruction.

This volume for the instructions is maintained, even if the other audio sources are set to minimum volume.

The setting is stored for the remote control currently in use.

You can have the possible commands spoken by the system at any point:

 ›Voice commands‹.

Using alternative commands

There are often a number of commands to run a function, e.g.:

 ›Dial number‹ or ›Choose name‹.

The system recognizes digits from zero to nine.

You can say each digit individually or group them into a sequence to accelerate the input.

Calling

Dialing phone numbers

1. ›Dial number‹.
2. Say the phone number.
For telephone calls abroad, say ›Plus‹ and then the country code.
3. ›Dialing‹.

The connection to the desired subscriber is established.

Correcting phone number

After the last spoken sequence of digits has been repeated by the system, you can delete this sequence of digits.

 ›Correct number‹.
The digits are deleted.

The command ›Correct number‹ can be repeated as often as you like.

Deleting phone number

 ›Delete‹.

All digits entered up to this point are deleted.

Voice phone book

Operating by voice command requires a personal voice phone book.

The entries must be entered using voice commands and are separate from the memory in the mobile phone. In this case, it is not possible to use voice command either to call phone numbers stored in the mobile phone or to store new numbers. Up to 50 entries can be set up. An entry always consists of a name and phone number.

Creating and editing a voice phone book

Store entry:

An entry always consists of a name and phone number.

-  1. ›Save name‹.
2. Speak the name.
The spoken length of the names in the phone book must not exceed approx. 2 seconds.
3. Say the phone number after being prompted to do so by the system.
4. To store the phone number:
›Save‹.

Delete entry:

You can delete any entry from the voice phone book.

-  1. ›Delete name‹.
The dialog for deleting an entry is opened.
2. Say the name when prompted.
3. Confirm the query with ›Yes‹.

Delete all entries:

›Delete phonebook‹ deletes all entries in the phone book.

-  1. ›Delete phonebook‹.
The dialog for deleting phone book is opened.
2. Confirm the query with ›Yes‹.
3. Confirm the query again with ›Yes‹.

Have entries read aloud and select:

You can have all the entries of your voice phone book read aloud in the order of input and select a certain entry to establish a connection:

-  1. ›Read phonebook‹.
The dialog for reading phone book is opened.
2. ›Dial number‹, when the desired entry is read aloud.

Selecting an entry

The connection to the phone number of the selected entry is established.

-  1. ›Choose name‹.
The dialog for selecting an entry is opened.
2. Say the name when prompted.
3. Confirm the query with ›Yes‹.

Redialing

To redial the phone number dialed last:

 ›Redial‹

Notes

Important for voice commands

For voice commands, keep the following in mind:

- ▷ Issue the commands smoothly and at normal volume, avoiding excessive emphases and pauses.
- ▷ Keep the doors, windows and glass sunroof closed to prevent interference from ambient noise.
- ▷ Avoid making other noise in the vehicle while speaking.

Inserting/removing the snap-in adapter*

1. Press button 1 and remove the cover.

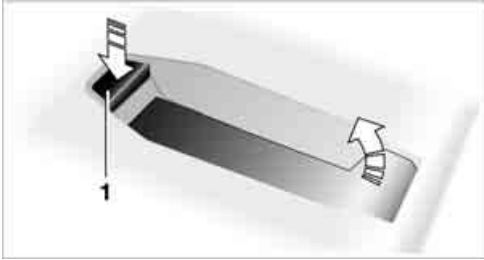

2. Insert the snap-in adapter in the front and press it downward until it engages.



To remove the snap-in adapter:
Press button 1.

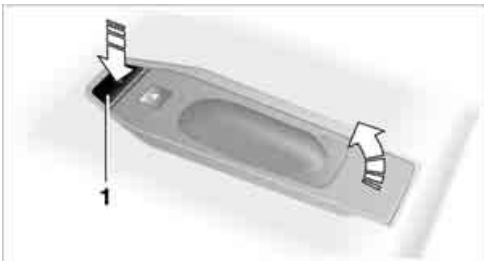

Inserting mobile phone

1. Remove the protective cap from the mobile phone's antenna connector if necessary, so that the mobile phone can engage in the snap-in adapter.
2. Push the mobile phone with the buttons facing upward toward the electrical connections and press down until it engages.

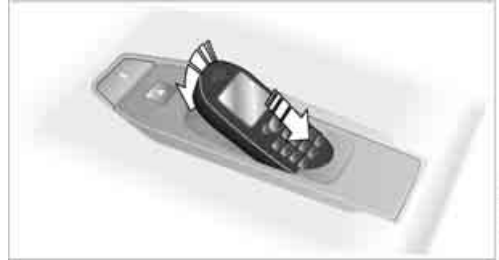

The mobile phone's battery is charged as soon as the vehicle is in radio readiness or the steering is unlocked.

 To conserve vehicle battery power, you should avoid using the mobile phone when the ignition is switched off. ◀

Removing mobile phone

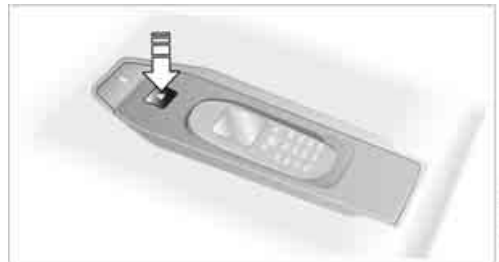

Press the button.

Contacts*

You can create and edit contacts. The contacts of the mobile phone* are also displayed. The addresses can be used as destinations for navigation and the phone numbers can be dialed.

New contact

1. "Contacts"
2. "New contact"



3. If the entry fields are still filled with previous entries, select "Delete input fields".
4. To fill in the entry fields:
Select the symbol next to the entry field.



5. Enter the text.



If the vehicle is equipped with a navigation system, it is only possible to enter addresses that are contained in the navigation data in the vehicle. This ensures that destination guidance is possible for all addresses. ◀

6. "Store contact in vehicle"

Specifying a contact as home address

A contact can be stored as a home address. It is placed at the top of "My contacts".

1. "Contacts"
2. "New contact"
3. To fill in the entry fields:
Select the symbol next to the entry field.
4. Open "Options".
5. "Store as home address"



When the home address is deleted, only the content of the home address entry is deleted and not the entry itself.

My contacts



A list of all contacts in the vehicle and on the mobile phone*.

Displaying contacts

"My contacts"

All contacts are listed in alphabetical order. Depending on the number of contacts, an A-Z

search is offered. A symbol indicates the storage location of the contacts:

| Symbol | Storage location |
|-----------|--|
| No symbol | In the vehicle; the address has not been checked as a destination. |
| Ⓐ | In the vehicle; the address has been checked as a destination. |
| 📱 | Mobile phone* |

Displaying the detailed view*

Select the desired contact.

All fields that have been filled in for that contact are displayed.

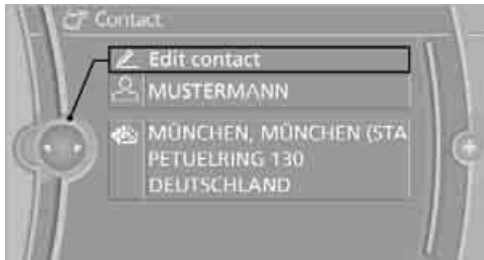

Selecting a contact as navigation destination

1. "My contacts"
2. Select the desired contact.
3. Select the desired address.

Contacts from the mobile phone may contain addresses that do not match the navigation data contained in the vehicle and thus cannot be used for destination guidance. In this case: Manually correct the address.

Checking a destination address

An address that is to be used for destination guidance must match the navigation data contained in the vehicle. An address that is stored on the mobile phone can be corrected to match the navigation data.

1. Select the desired contact.
2. Open "Options".

3. "Check as destination"
4. Correct and store the address, if necessary.

After an address has been corrected, the contact can be stored in the vehicle. The address is not changed on the mobile phone.

Dialing phone numbers

1. "My contacts"
2. Select the desired contact.
3. Select the desired phone number.

The connection is established.

Editing a contact

1. "My contacts"
2. Select the desired contact.
3. "Edit contact"

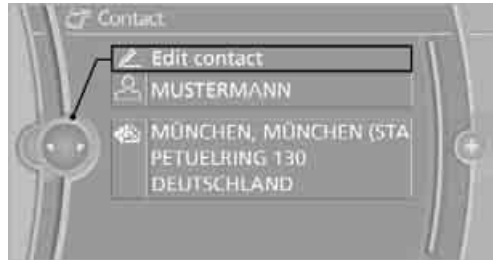

4. Change the entries.
5. "Store contact in "My contacts" ""

If a contact from the mobile phone is edited, the changes are not stored on the mobile phone. A copy of the entry is stored in the vehicle, and only this copy is displayed.

Deleting contacts

Only contacts that are stored in the vehicle are deleted. The contacts on the mobile phone cannot be deleted.

1. "My contacts"
2. Highlight the contact.
3. Open "Options".
4. "Delete contact" or "Delete all contacts".

BMW Assist*

BMW Assist provides a number of different services. For example, the position data of the vehicle can be transmitted to the BMW Assist Response Center when an Emergency Request* is sent.

Many BMW Assist services depend on the individually agreed contract.

After your contract has expired, the BMW Assist system will be deactivated by the BMW Assist Response Center without you having to visit a BMW Sports Activity Vehicle Center. After the BMW Assist system has been deactivated, no BMW Assist service will be available. The BMW Assist system can be reactivated by a BMW Sports Activity Vehicle Center after a new contract has been signed.

Requirements

- ▶ The installed BMW Assist system is logged in on a wireless communications network. This network must be capable of transmitting the services.
- ▶ To transmit position data, the vehicle must be able to determine the current position.
- ▶ To activate and update BMW Assist, a GPS signal must be available.
- ▶ The BMW Assist service contract was signed with your BMW Sports Activity Vehicle Center or with the BMW Assist Response Center. Enabling must have been completed.
- ▶ BMW Assist is activated.

Services offered

- ▶ **Emergency Request:** when you press the SOS button, a connection to the BMW Assist Response Center is established. The BMW Assist Response Center then speaks with you and takes further steps to help you.

- ▶ **Automatic Collision Notification:** under certain conditions, a connection is established to the BMW Assist Response Center after a serious accident. If possible, the BMW Assist Response Center then speaks with you and takes further steps to help you.
- ▶ **Enhanced Roadside Assistance:** BMW Roadside Assistance* can be contacted if assistance is needed in the event of a breakdown. If possible, the vehicle and position data are transmitted in the process.
- ▶ **Customer Relations:** connection to Customer Relations for information on all aspects of your vehicle.
- ▶ **TeleServices:** data on your vehicle's service status or required inspections are transmitted to your BMW Sports Activity Vehicle Center, either automatically before a service due date or when you request a BMW service appointment.
- ▶ **Remote Door Unlock:** the BMW Assist Response Center provides assistance if, for example, the remote control is not available and the vehicle needs to be opened.
- ▶ **Stolen Vehicle Recovery:** after you report to the police that your vehicle was stolen, the BMW Assist Response Center can determine its position.
- ▶ In addition, the optional Convenience Plan offers a concierge service and information on route planning, the traffic situation and weather. Using Critical Calling, a limited number of calls can be made via the BMW Assist Response Center, for example if the mobile phone is not available or discharged. Press the SOS button to contact the BMW Assist Response Center.
- ▶ You can also access the BMW Assist concierge service via the Internet.

TeleServices*

TeleServices supports communication with your BMW Sports Activity Vehicle Center.

- ▷ Data on the vehicle's service requirements can be sent directly to the BMW Sports Activity Vehicle Center. In this way, the BMW Sports Activity Vehicle Center can plan its work in advance. This shortens the duration of the service appointment.
- ▷ In the event of a breakdown, data on the vehicle's condition can be sent directly to Roadside Assistance*.
- ▷ The offer varies by country.
- ▷ Connection may incur charges.
- ▷ Services may be restricted abroad.

Requirements

- ▷ BMW Assist is activated.
- ▷ Wireless reception is available.
- ▷ The engine is running.

Concierge service*

When you call the BMW Assist Concierge service, you can obtain information about, for example, restaurants, emergency pharmacy services, gas stations or hotels, as well as receive the corresponding telephone numbers and addresses.

You can then dial a phone number directly or use an address for destination guidance*.

Starting the concierge service

1. "BMW Assist"
2. "Concierge"



3. "Start service"

A voice connection is established to the BMW Concierge service.

You are connected to an employee of the BMW Concierge service to obtain the required information. You can then have the phone number and address sent to you and, for example, use it for destination guidance in the navigation system. Many hotels can be booked directly through the BMW concierge service. When an information message is received, a list of the received messages is displayed automatically.

Messages

SMS, BMW Concierge service messages and My Info messages from the BMW Assist portal are listed here, refer to Messages on page 208.

Roadside assistance

You can call BMW Roadside Assistance* should you require help in the event of a breakdown.

Starting Roadside Assistance

Vehicle not equipped with BMW Assist or TeleServices

1. "BMW Assist"
2. "Roadside Assistance"



The Roadside Assistance number is displayed.

3. Select the number. If a mobile phone* is paired, a connection is established to BMW Roadside Assistance.

Vehicle equipped with BMW Assist or TeleServices

1. "BMW Assist"
2. "Roadside Assistance"
3. "Start service"

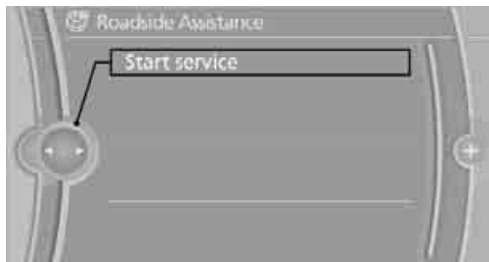

Teleservice Diagnosis*

Teleservice Diagnosis enables the wireless transmission of detailed vehicle data that are important for vehicle diagnosis. Teleservice Diagnosis can be started after a prompt by Roadside Assistance and termination of the voice connection.

Teleservice Help*

Teleservice Help enables an in-depth diagnosis of the vehicle by Roadside Assistance via wireless transmission. Teleservice Help can be started after a prompt by Roadside Assistance and termination of the voice connection.

Starting Teleservice Help

1. Park the vehicle in a safe place.
2. Set the parking brake.
3. The engine is running.
4. "TeleService Help"

After completion of Teleservice Help, a voice connection is established to Roadside Assistance.

Activating BMW Assist*

If the services included in a valid BMW Assist subscription are not displayed, they may need to be activated.

1. Make sure that the vehicle can determine its current position. Reception is usually best when you have an unobstructed view to the sky.
2. Switch on the ignition.
3. "Activate BMW Assist"

Activation may take several minutes. If another menu is opened, activation continues running in the background.

BMW Search*

BMW Search is an Internet portal that makes available a number of services for use in the vehicle, e.g. information on restaurants on your route, your own address book or an e-mail account.

BMW Search is always displayed across the full screen.

Requirements

- ▷ Subscription to the optional Convenience Plan.
- ▷ The vehicle is located within wireless network coverage.
- ▷ The date setting on the Control Display is current.

Starting BMW Search

1. "BMW Assist"
2. "BMW Search"



3. Select "OK", if necessary.

The BMW Search start page is displayed.

Using BMW Search

To select and display content:

- ▷ Turn the controller to highlight an element.
- ▷ Press the controller to display an element.

Opening start page

1. Open "Options".
2. "Home"

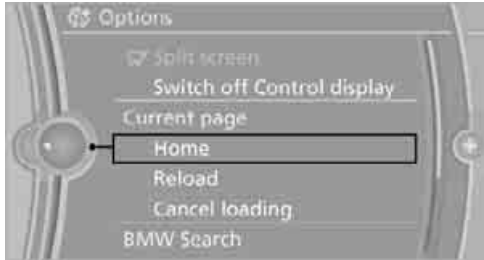

Loading a new page

1. Open "Options".
2. "Reload"

Canceling

1. Open "Options".
2. "Cancel loading"

Pairing

To display e-mails, contacts from BMW Search or other personal data, you need to log in.

1. "BMW Assist"
2. "BMW Search"
3. Open "Options".
4. "User identification"

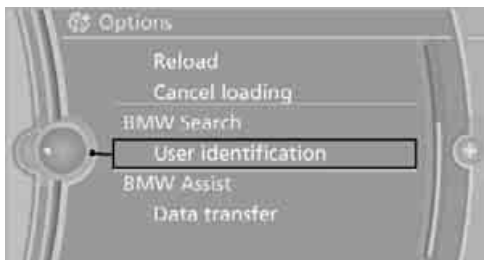

5. "User name:"



6. Enter the user name and select "OK".
7. "Password:"
8. Enter the password and select "OK".
9. "OK"

Automatically logging in

You are logged in automatically when BMW Search is opened.

"Logon automatically"

Logging off

1. "BMW Assist"
2. "BMW Search"
3. Open "Options".
4. "User logoff"

Activating TeleServices*

If the services are not displayed, they may need to be activated.

1. "BMW Assist"
2. "Activate TeleService"

Customer Relations

Contact Customer Relations for information on all aspects of your vehicle.

Vehicle equipped with BMW Assist or BMW TeleServices

1. "BMW Assist"
2. "Customer Relations"
3. "Start service"

A voice connection is established to Customer Relations.

Vehicle not equipped with BMW Assist or BMW TeleServices

1. "BMW Assist"
2. "Customer Relations"

The Customer Relations phone number is displayed. If the vehicle is equipped with the mobile phone preparation package, a voice connection is established.



Service Request*

You can send a request to your BMW Sports Activity Vehicle Center to arrange a service appointment. The Teleservice data is transmitted during a Service Request. Your BMW Sports Activity Vehicle Center will contact you.

Starting a Service Request

1. "BMW Assist"
2. "Service Request"

3. "Start service"



Automatic Service Request*

The Teleservice data necessary for servicing the vehicle are automatically sent to your BMW Sports Activity Vehicle Center prior to the service deadline. The center will contact you and a service appointment can be arranged.

You can check when the BMW Sports Activity Vehicle Center was notified.

1. "Vehicle Info"
2. "Vehicle status"



3. Open "Options".
4. "Last Service Request"

BMW Sports Activity Vehicle Center*

Address and contact data of the BMW Sports Activity Vehicle Center.

1. "BMW Assist"
2. "Your BMW center"

Data transfer*

The status of the data transfer is displayed.

1. "BMW Assist"
2. Open "Options".
3. "Data transfer"

Service status*

Display of all services available in the vehicle.

1. "BMW Assist"
2. "Service status"
3. "Available services"

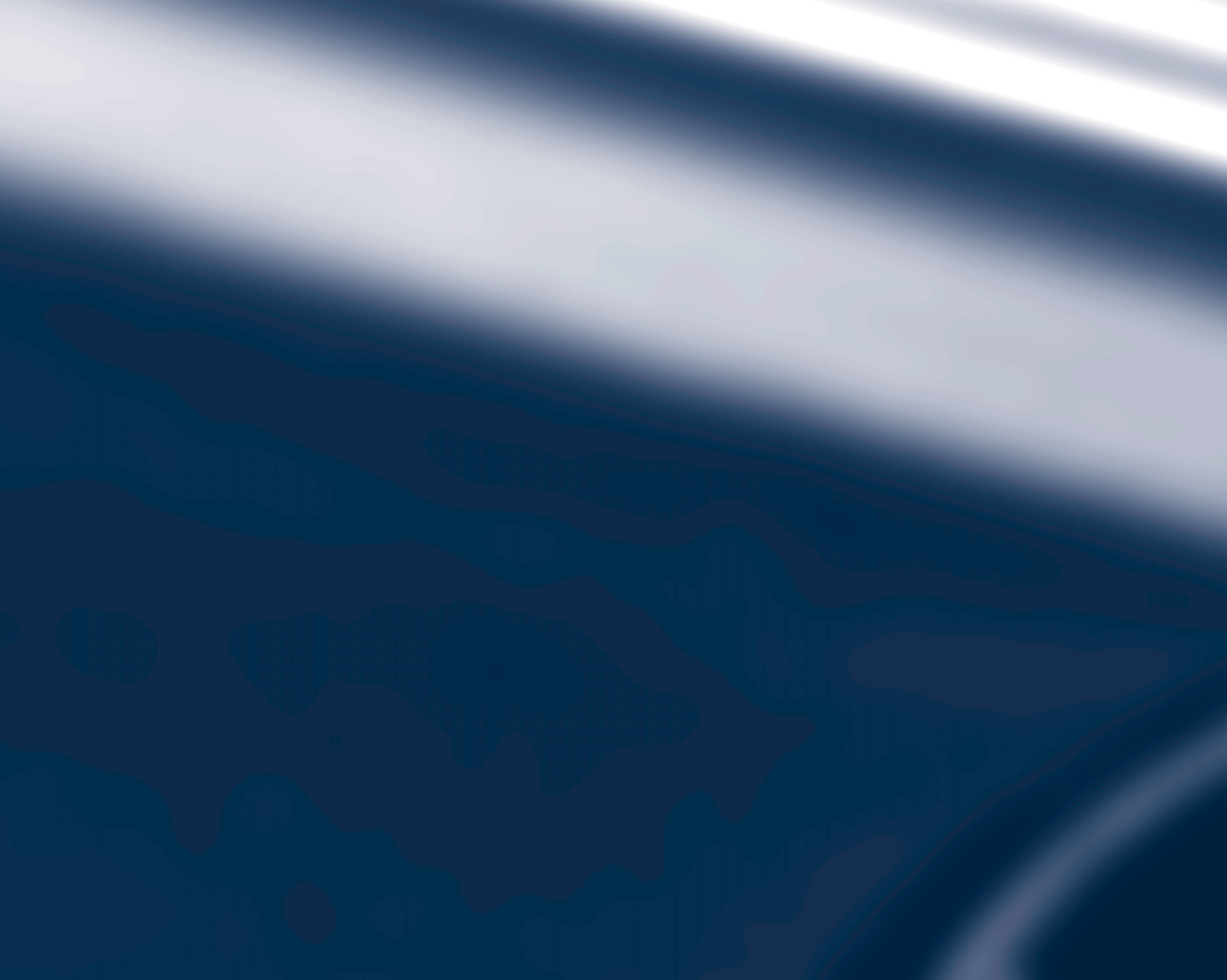



Mobility

This section helps you maintain your mobility by supplying important information on vital topics including fuels and lubricants, wheels and tires, service, maintenance and roadside assistance.

Refueling

⚠ Switch off the engine before refueling. When handling fuel, always observe all applicable precautionary measures and regulations. Never transport reserve fuel containers in the vehicle. These could become leaky and cause an explosion or a fire in an accident. ◀

Fuel filler door

Opening

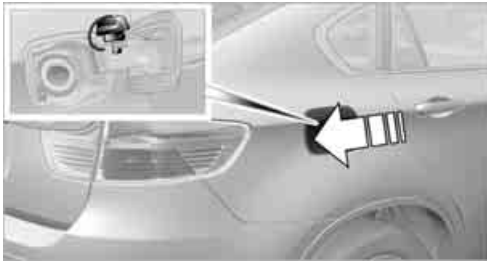

1. Open the fuel filler door. To do this, briefly press the lower edge.
2. Turn the fuel filler cap counterclockwise.
3. Place the fuel filler cap in the bracket attached to the fuel filler door.

Closing

Fit the cap and turn it clockwise until you clearly hear a click.

⚠ Do not crush the band attached to the cap; otherwise, the cap may not properly seal and fuel vapors can escape. ◀

A message* is displayed if the cap is loose or missing.

Releasing manually

If an electrical malfunction should occur, you can unlock the fuel filler door manually.

1. Open the right-hand side panel in the cargo bay.
2. Pull the knob with the gas pump symbol.

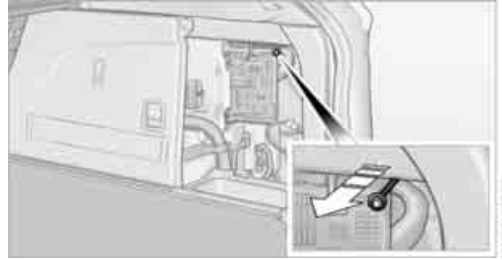

Observe the following when refueling

⚠ When handling fuels, follow the safety precautions posted at the filling station. Otherwise, there is a danger of personal injury or property damage. ◀

When refueling, insert the filler nozzle completely into the filler pipe. Avoid raising the filler nozzle during refueling, otherwise this leads to

- ▷ premature pump shutoff
- ▷ a reduced efficiency of the fuel-vapor recovery system

The fuel tank is full when the filler nozzle clicks off the first time.

Fuel tank capacity

Approx. 22.5 US gal/85 liters, including the reserve capacity of approx. 2.1 US gal/8 liters
 X5 xDrive48i: approx. 2.6 US gal/10 liters reserve
 X6 xDrive50i: approx. 3.2 US gal/12 liters reserve

⚠ Refuel as soon as possible once your cruising range falls below 30 miles/50 km, otherwise engine functions are not ensured and damage can occur. ◀

Fuel specifications

Gasoline engine: required fuel

 Do not use leaded gasoline, otherwise damage to the catalytic converter will result.

Do not use E85, i.e. fuel that consists of 85% ethanol, or Flex Fuel, otherwise permanent damage to the engine and the fuel supply system will result. ◀

Super Premium Gasoline/AKI 91

This gasoline is highly recommended.

However, you may also use gasoline with less AKI. The minimum AKI Rating is:

- ▷ BMW X5: 87
- ▷ BMW X6: 89

If you use gasoline with this minimum AKI Rating, the engine may produce knocking sounds when starting at high outside temperatures. This has no effect on the engine life.

 Do not use gasoline below the specified minimum quality, otherwise engine damage can result. ◀

Use high-quality brands

Field experience has indicated significant differences in fuel quality: volatility, composition, additives, etc., among gasolines offered for sale in the United States and Canada. Fuels containing up to and including 10% ethanol or other oxygenates with up to 2.8% oxygen by weight, that is, 15% MTBE or 3% methanol plus an equivalent amount of co-solvent, will not void the applicable warranties with respect to defects in materials or workmanship.

 The use of poor-quality fuels may result in drivability, starting and stalling problems especially under certain environmental conditions such as high ambient temperature and high altitude.

Should you encounter drivability problems which you suspect could be related to the fuel you are using, we recommend that you respond by switching to a recognized high-quality brand

such as gasoline that is advertised as Top Tier Detergent Gasoline.

Failure to comply with these recommendations may also result in unscheduled maintenance. ◀

BMW X5 with BMW Advanced Diesel: required fuel

Ultra-Low Sulfur Diesel

The engine of your BMW is designed for diesel with a low sulfur content:

Ultra-low sulfur diesel ASTM D 975-07a.

 Only refuel with ultra-low sulfur diesel. The percentage of biodiesel in the fuel must not exceed 5%, referred to as B5. Do not refuel with gasoline. If the vehicle has been refueled with incorrect fuel such as gasoline, do not start the engine; otherwise, there is a danger of engine damage. ◀

After incorrect refueling, contact a BMW Sports Activity Vehicle Center.

 The fuel filling neck is designed for refueling with diesel nozzles.

If the nozzle cannot be inserted into the fuel filler pipe of your BMW, please check to make sure that you are refueling with a diesel fuel pump and whether this is equipped with a diesel nozzle. ◀

 In the event the ultra-low sulfur diesel nozzle cannot be fully inserted into the fuel filler neck, please contact BMW Roadside Assistance for instructions on how to add fuel. For more information on BMW Roadside Assistance, refer to page 262. ◀

Winter diesel

In order to assure the operational reliability of the diesel engine, during cold seasons, please refuel with winter diesel, which is sold at filling stations during this time of year. The standard fuel filter heating prevents the supply of fuel from stalling during driving.

 Do not mix in any additives or gasoline; otherwise, there is the risk of engine damage. ◀

BMW X5 with BMW Advanced Diesel

The concept

BMW Advanced Diesel reduces nitrogen oxides in the diesel exhaust of your vehicle by injecting the reducing agent diesel exhaust fluid into the exhaust line. In the catalytic converter, a chemical reaction occurs that minimizes nitrogen oxides.

In order to be able to start the engine in the usual way, there must be a sufficient supply of diesel exhaust fluid in the separate reservoir.

System heating

In order to bring the system to operating temperature after a cold start of the engine, the automatic transmission shifts into the next higher gear at a later point.

Reserve display

A display in the instrument panel informs you about the remaining distance can be covered with the amount of fuel currently in the tank.



The reserve display appears approx. 1,000 miles/1,600 km before the end of the tank.

 As soon as the reserve display has appeared in the instrument panel, have the diesel exhaust fluid refilled to prevent the engine from being unable to restart. ◀

Diesel exhaust fluid at minimum



Even with a display of -- mls, the engine will continue to run, provided that it is not switched off, and all other operating requirements are met, e.g. sufficient fuel.

 Do not drive until the displayed remaining distance runs out. Otherwise, it may not be possible to restart the engine. ◀

Incorrect fueling



The warning lamp lights up:
The reservoir has been filled with an incorrect fluid.

Please contact your BMW Sports Activity Vehicle Center.

Having diesel exhaust fluid refilled

Your BMW Sports Activity Vehicle Center refills the diesel exhaust fluid as part of the regular maintenance. If you adhere to this maintenance schedule, it is usually not necessary to refill any fluids between the maintenance dates.

Under certain circumstances, e.g. due to a particularly sporty driving style or operation of the vehicle at high altitudes, it may be necessary to refill fluids between maintenance dates.

As soon as the reserve display has appeared in the instrument panel, have the diesel exhaust fluid refilled to prevent the engine from being unable to restart.

You can have the fluid refilled by a BMW Sports Activity Vehicle Center.

Diesel exhaust fluid at low temperatures



Due to its physical properties, it may be necessary to replenish the level of diesel

exhaust fluid at temperatures below +23 °F / -5 °C even between the regular maintenance intervals.

If the fluid needs to be refilled, this will be indicated with the reserve display in the instrument panel, refer to page 226. ◀

Only refill the diesel exhaust fluid yourself in exceptional circumstances

In order to get your vehicle to reach the nearest BMW Sports Activity Vehicle Center, you may refill the diesel exhaust fluid yourself, making sure to heed the warning notices.

 Do not allow diesel exhaust fluid to come into contact with you. This can lead to skin and eye irritation. Wear protective goggles and gloves as needed. Follow the safety instructions on the bottle.

When opening the bottle or reservoir, pungent smelling vapors can escape. Before refilling, close the vehicle completely so that the vapors do not get into the interior of the vehicle. When handling diesel exhaust fluid in enclosed spaces, make sure to have sufficient ventilation. After handling diesel exhaust fluid, wash hands thoroughly. Failure to do so may lead to irritation, e.g. due to inadvertent contact with the eyes.

If eye irritation occurs, immediately rinse eyes with ample water and contact a doctor if necessary.

If diesel exhaust fluid comes into contact with surfaces of your vehicle, rinse the affected surfaces with water or else damage may occur. Keep diesel exhaust fluid out of reach of children. ◀

Suitable diesel exhaust fluid

- ▶ Preferred: BMW Diesel Exhaust Fluid. This bottle and its special adapter permit convenient refilling with diesel exhaust fluid.
 - ▶ Alternative: NOx reduction agent AUS 32
- You can get diesel exhaust fluid at your BMW Sports Activity Vehicle Center.

Refilling quantity

Refilling quantity at the start of the reserve display: approx. 0,75 US gal/2.7 liters reserve

Open reservoir for diesel exhaust fluid

1. Open hood, refer to page 239.
2. Fit releasing tool from onboard tool kit, refer to page 250 into place and open the lock, refer to arrow.

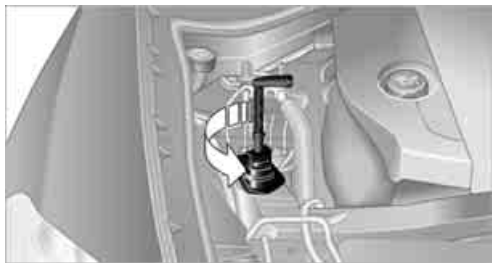

Refilling BMW diesel exhaust fluid

1. Set bottle into place and rotate until it comes into contact with the stop, refer to arrow.

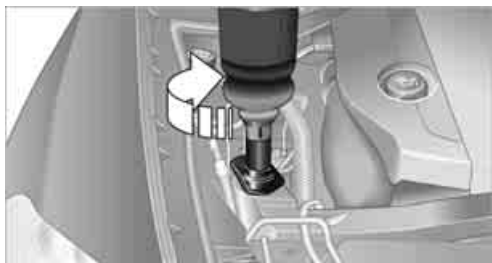

2. Press bottle down, refer to arrow. The reservoir of the vehicle is filled.

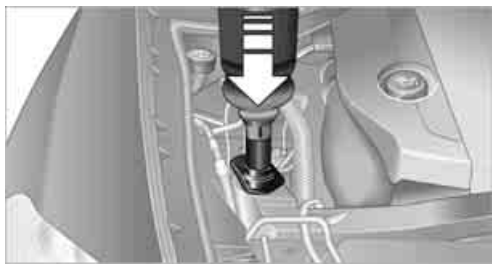

- The reservoir is full when the fill level in the bottle stops changing. It is not possible to overfill.
Pull bottle back, refer to arrow, and unscrew it.

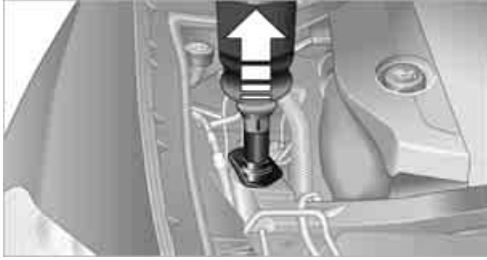

Closing reservoir

After the reservoir is filled, close it again with the releasing tool.

After refilling diesel exhaust fluid

Incorrect fluid

 After refilling with the incorrect fluid, e.g. antifreeze for windshield wiper fluid, do not start the engine because this could result in a fire hazard. ◀

Contact your BMW Sports Activity Vehicle Center.

Bottle disposal

 You can have bottles for diesel exhaust fluid properly disposed of at your BMW Sports Activity Vehicle Center. Only dispose of empty bottles in your household garbage if the local legal regulations permit it. ◀

Reserve display



After refilling, the reserve continues to appear after the engine is restarted. After the vehicle has been driven for a few more minutes, this display will disappear.

Wheels and tires

Tire inflation pressure

Information for your safety

The condition of the tires and the maintenance of the specified tire pressure are crucial not only to the tire's service life, but also to driving comfort and most importantly, driving safety.

Checking pressure

Only check tire inflation pressure when the tires are cold. This means after a maximum of 1.25 miles/2 km driving or when the vehicle has been parked for at least 2 hours. When tires are warm, the tire inflation pressure increases.

 Check the tire inflation pressure regularly and correct it as needed, even on the compact tire*: at least twice a month and before starting long trips. If you fail to observe this precaution, you may be driving on tires with incorrect tire pressures, a condition that can not only compromise your vehicle's driving stability, but also lead to tire damage and the risk of an accident. Do not drive with depressurized, i.e. flat tires, except run-flat tires. A flat tire will seriously impair your vehicle's handling and braking response. Attempts to drive on a flat tire can lead to a loss of control over the vehicle. ◀

 After correcting the tire inflation pressure, reinitialize the Flat Tire Monitor, refer to page 93, or reset the Tire Pressure Monitor, refer to page 94. ◀

Pressure specifications

The tables below provide all the correct inflation pressures for the specified tire sizes at ambient temperature.

 The inflation pressures apply to the tire sizes and tire brands respectively approved and recommended by BMW; a list of these is available from your BMW Sports Activity Vehicle Center. ◀

For correct identification of the right tire inflation pressure for your tires, observe the following:

- ▷ Tire sizes of your vehicle
- ▷ Load conditions
- ▷ Maximum allowable driving speed

Tire inflation pressures for speeds up to 100 mph/160 km/h

For normal driving up to 100 mph/160 km/h, adjust pressures to the respective tire inflation pressures listed on the following pages in the column Traveling speeds up to max. of 100 mph/160 km/h to achieve optimum driving comfort.

These pressure specifications can be found on the door post when you open the driver's door.





 The permissible top speed for these tire inflation pressures is 100 mph/160 km/h. Do not exceed this speed, otherwise tire damage and accidents may result. ◀

Tire inflation pressures for speeds above 100 mph/160 km/h



 In order to drive at maximum speeds in excess of 100 mph/160 km/h, please observe, and, if necessary, adjust tire pressures for speeds exceeding 100 mph/160 km/h from the relevant table on the following pages. Otherwise tire damage and accidents could occur. ◀

Observe all national and local maximum speed limits, otherwise violations of the law could occur.

Tire inflation pressures X5 xDrive30i/X5 xDrive48i/X5 xDrive35d with two rows of seats

| Tire size | Pressure specifications in psi/kPa | | | |
|--|---|--------|--|--------|
| | Traveling speeds up to a max. of 100 mph/160 km/h | | Traveling speeds including those exceeding 100 mph/160 km/h | |
| All pressure specifications in the table are indicated in psi/kilopascal with cold tires. Cold = ambient temperature |  | |  | |
| | Compact wheel*: | | | |
| T 155/90 D 18 113 M | 60/420 | 60/420 | 60/420 | 60/420 |
| T 155/80 R 19 114 M | | | | |
| without sport package: | | | | |
| 255/55 R 18 109 H M+S XL | 32/220 | 35/240 | 35/240 | 41/280 |
| 255/50 R 19 107 H M+S XL | 32/220 | 36/250 | 35/240 | 41/280 |
| Front: 255/50 R 19 107 V XL | 32/220 | - | 35/240 | - |
| Rear: 285/45 R 19 111 V XL | - | 32/220 | - | 36/250 |
| Front: 275/40 R 20 106 W XL | 33/230 | - | 35/240 | - |
| Rear: 315/35 R 20 110 W XL | - | 33/230 | - | 36/250 |
| Front: 285/35 R 21 105 W XL | 33/230 | - | 36/250 | - |
| Rear: 325/30 R 21 108 W XL | - | 36/250 | - | 39/270 |
| with sport package: | | | | |
| 255/55 R 18 109 H M+S XL | 32/220 | 35/240 | 35/240 | 41/280 |
| 255/50 R 19 107 H M+S XL | 32/220 | 36/250 | 35/240 | 41/280 |
| Front: 255/50 R 19 107 V XL | 32/220 | - | 39/270 | - |
| Rear: 285/45 R 19 111 V XL | - | 32/220 | - | 41/280 |
| Front: 275/40 R 20 106 W XL | 33/230 | - | 38/260 | - |
| Rear: 315/35 R 20 110 W XL | - | 33/230 | - | 39/270 |
| Front: 285/35 R 21 105 W XL | 33/230 | - | 38/260 | - |
| Rear: 325/30 R 21 108 W XL | - | 36/250 | - | 42/290 |
| More details on the permissible load and weights can be found on page 271 . | | | | |

Tire inflation pressures X5 xDrive30i/X5 xDrive48i/X5 xDrive35d with two rows of seats

| Tire size | Pressure specifications in psi/kPa | | | |
|--|---|--|--|--|
| | Traveling speeds up to a max. of 100 mph/160 km/h | | Traveling speeds including those exceeding 100 mph/160 km/h | |
| All pressure specifications in the table are indicated in psi/kilopascal with cold tires. Cold = ambient temperature |  | |  | |

without sport package:



| | | | | |
|-----------------------------|--------|--------|--------|--------|
| 255/55 R 18 109 H M+S XL | 33/230 | 41/280 | 38/260 | 45/310 |
| 255/50 R 19 107 H M+S XL | 36/250 | 44/300 | 41/280 | 48/330 |
| Front: 255/50 R 19 107 V XL | 32/220 | - | 35/240 | - |
| Rear: 285/45 R 19 111 V XL | - | 38/260 | - | 42/290 |
| Front: 275/40 R 20 106 W XL | 33/230 | - | 35/240 | - |
| Rear: 315/35 R 20 110 W XL | - | 39/270 | - | 42/290 |
| Front: 285/35 R 21 105 W XL | 35/240 | - | 38/260 | - |
| Rear: 325/30 R 21 108 W XL | - | 42/290 | - | 45/310 |

with sport package:

| | | | | |
|-----------------------------|--------|--------|--------|--------|
| 255/55 R 18 109 H M+S XL | 33/230 | 41/280 | 38/260 | 45/310 |
| 255/50 R 19 107 H M+S XL | 36/250 | 44/300 | 41/280 | 48/330 |
| Front: 255/50 R 19 107 V XL | 32/220 | - | 41/280 | - |
| Rear: 285/45 R 19 111 V XL | - | 38/260 | - | 48/330 |
| Front: 275/40 R 20 106 W XL | 33/230 | - | 41/280 | - |
| Rear: 315/35 R 20 110 W XL | - | 39/270 | - | 48/330 |
| Front: 285/35 R 21 105 W XL | 35/240 | - | 42/290 | - |
| Rear: 325/30 R 21 108 W XL | - | 42/290 | - | 49/340 |



More details on the permissible load and weights can be found on page [271](#).

Tire inflation pressure X6 xDrive35i

| Tire size | Pressure specifications in psi/kPa | | | |
|--|---|--------|---|--------|
| | Traveling speeds up to a max. of 100 mph/160 km/h | | Traveling speeds including those exceeding 100 mph/160 km/h | |
| <p>All pressure specifications in the table are indicated in psi/kilopascal with cold tires. Cold = ambient temperature</p>   | | | | |
| | 255/50 R 19 107 H M+S XL | 32/220 | 35/240 | 36/250 |
| 255/50 R 19 107 V M+S XL | | | | |
| Front: 255/50 R 19 107 V XL | 32/220 | - | 36/250 | - |
| Rear: 285/45 R 19 111 V XL | - | 32/220 | - | 38/260 |
| Front: 275/40 R 20 106 W XL | 32/220 | - | 36/250 | - |
| Rear: 315/35 R 20 110 W XL | - | 32/220 | - | 36/250 |
| Front: 285/35 R 21 105 W XL | 32/220 | - | 38/260 | - |
| Rear: 325/30 R 21 108 W XL | - | 33/230 | - | 39/270 |
| Compact wheel*: | | | | |
| T 155/90 D 18 113 M | 60/420 | 60/420 | 60/420 | 60/420 |
| T 155/80 R 19 114 M | | | | |

More details on the permissible load and weights can be found on page [271](#).

Tire inflation pressures for X6 xDrive50i

| Tire size | Pressure specifications in psi/kPa | | | |
|--|---|--------|--|--------|
| | Traveling speeds up to a max. of 100 mph/160 km/h | | Traveling speeds including those exceeding 100 mph/160 km/h | |
| All pressure specifications in the table are indicated in psi/kilopascal with cold tires. Cold = ambient temperature |  | |  | |
| | 255/50 R 19 107 H M+S XL | 33/230 | 33/230 | 41/280 |
| 255/50 R 19 107 V M+S XL | | | | |
| Front: 255/50 R 19 107 W XL | 36/250 | - | 42/290 | - |
| Rear: 285/45 R 19 111 W XL | - | 36/250 | - | 42/290 |
| Front: 275/40 R 20 106 W XL | 36/250 | - | 44/300 | - |
| Rear: 315/35 R 20 110 W XL | - | 36/250 | - | 44/300 |
| Front: 285/35 R 21 105 W XL | 36/250 | - | 45/310 | - |
| Rear: 325/30 R 21 108 W XL | - | 36/250 | - | 45/310 |
| Compact wheel*: | | | | |
| T 155/90 D 18 113 M | 60/420 | 60/420 | 60/420 | 60/420 |
| T 155/80 R 19 114 M | | | | |

More details on the permissible load and weights can be found on page [271](#).

Tire identification marks

Knowledge of the labeling on the side of the tire makes it easier to identify and choose the right tires.

Tire size

e.g. 255/55 R 18 109 H

Nominal width in mm ————|
 Aspect ratio in % ————|
 Belted construction – radial ————|
 Rim diameter in inches ————|
 Carrying capacity ID-code ————|
 (not in ZR tires)
 Speed code letter ————|
 (in ZR tires before the R)

Speed letter

Q = up to 100 mph (160 km/h)

T = up to 118 mph (190 km/h)

H = up to 131 mph (210 km/h)

V = up to 150 mph (240 km/h)

W = up to 167 mph (270 km/h)

Y = up to 186 mph (300 km/h)

Tire Identification Number

Tires with DOT codes meet the guidelines of the US Department of Transportation.

DOT code:

e.g. DOT xxxx xxx 0809

Manufacturer code
for tire make ————|
 Tire size and tire design ————|
 Tire age ————|

Tire age

The manufacturing date of tires is contained in the tire coding: DOT ... 0809 indicates that the tire was manufactured in week 8 of 2009.

BMW recommends that you replace all tires after 6 years at most, even if some tires may last for 10 years.

Uniform Tire Quality Grading

Quality grades can be found where applicable on the tire sidewall between tread shoulder and maximum section width. For example:

Tread wear 200 Traction AA

Temperature A

DOT Quality Grades

Tread wear

Traction AA A B C

Temperature A B C



All passenger car tires must conform to Federal Safety Requirements in addition to these grades. ◀

Tread wear

The tread wear grade is a comparative rating based on the wear rate of the tire when tested under controlled conditions on a specified government test course. For example, a tire graded 150 would wear one and one-half (1 ½) times as well on the government course as a tire graded 100. The relative performance of tires depends upon the actual conditions of their use, however, and may depart significantly from the norm due to variations in driving habits, service practices and differences in road characteristics and climate.

Traction

The traction grades, from highest to lowest, are AA, A, B, and C.

Those grades represent the tire's ability to stop on wet pavement as measured under controlled conditions on specified government test surfaces of asphalt and concrete. A tire marked C may have poor traction performance.



The traction grade assigned to this tire is based on straight-ahead braking traction tests, and does not include acceleration, cornering, hydroplaning, or peak traction characteristics. ◀

Temperature

The temperature grades are A, the highest, B, and C, representing the tire's resistance to the generation of heat and its ability to dissipate heat when tested under controlled conditions on a specified indoor laboratory test wheel. Sustained high temperature can cause the material of the tire to degenerate and reduce tire life, and excessive temperature can lead to sudden tire failure. The grade C corresponds to a level of performance which all passenger car tires must meet under the Federal Motor Vehicle Safety Standard No. 109. Grades B and A represent higher levels of performance on the laboratory test wheel than the minimum required by law.

 The temperature grade for this tire is established for a tire that is properly inflated and not overloaded. Excessive speed, underinflation, or excessive loading, either separately or in combination, can cause heat buildup and possible tire failure. ◀

RSC – run-flat tires

You will recognize run-flat tires by a circular symbol containing the letters RSC on the side of the tire, refer to page [237](#).

M+S

Winter and all-season tires. These have better winter properties than summer tires.

XL

Indicates specially reinforced tires.

Tire condition

Inspect your tires frequently for tread wear, signs of damage and for foreign objects lodged in the tread. Check the tread depth.

Minimum tread depth

The tread depth should not drop below 0.12 in/ 3 mm, although, for example, European legislation only specifies a minimum tread depth of

0.063 in/1.6 mm. At tread depths below 0.12 in/ 3 mm there is an increased risk of high-speed hydroplaning, even when only small amounts of water are present on the road surface. When winter tires wear down past a tread depth of 0.16 in/4 mm, they become perceptibly less suitable for winter conditions. For the sake of safety, new tires should be installed.

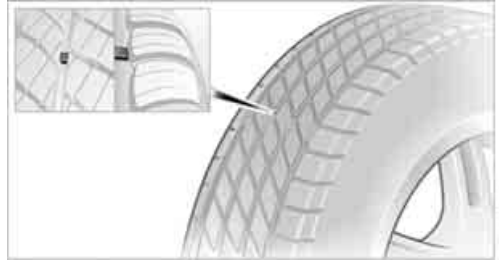

Wear indicators at the tread-groove base are distributed over the tire's circumference and are marked on the side of the tire with TWI – Tread Wear Indicator. If the tire tread has been driven down to the wear indicators, a tread depth of 0.063 in/1.6 mm has been reached.

Wheel/tire damage

Please note that low-profile tires cause wheels, tires and suspension parts to be more susceptible to road hazards and consequential damages.

Unusual vibrations encountered during normal vehicle operation can indicate tire failure or some other vehicle defect. This can, for example, be caused by driving over curbs. These kinds of problems may also be signaled by other changes in vehicle response, such as a strong tendency to pull to the left or right.

 In these cases, reduce speed immediately and have wheels and tires thoroughly checked. To do so, drive carefully to the nearest BMW Sports Activity Vehicle Center or tire shop that works according to BMW repair procedures with correspondingly trained personnel. If necessary, have the vehicle towed there. Otherwise, tire damage can be extremely dangerous to vehicle occupants and other road users. ◀

Run-flat tires



You will recognize run-flat tires by the circular symbol containing the letters RSC on the side of the tire.

Run-flat tires consist of partially self-contained tires and special rims. The sidewall reinforcement ensures that the tire retains some residual safety in the event of pressure drop and driving remains possible to a restricted degree.

To continue driving with a damaged tire:

- ▶ With Flat Tire Monitor, refer to Indication of a flat tire page [93](#)
- ▶ With Tire Pressure Monitor, refer to Message with low tire inflation pressure page [95](#)

New wheels and tires

 Have new wheels and tires installed only by your BMW Sports Activity Vehicle Center or a tire shop that works according to BMW repair procedures with correspondingly trained personnel. If this work is not carried out properly, there is a danger of subsequent damage and related safety hazards. Make sure that the new wheels are balanced. ◀

Retreaded tires

 BMW does not recommend that you use retreaded tires, as driving safety may be impaired. The causes for this include the possibly different tire casing structures and the often wide variations in their age, which can result in a limited service life. ◀

The right wheels and tires

When mounting new tires or changing over from summer to winter tires and vice versa, mount Run-Flat Tires for your own safety. Your BMW Sports Activity Vehicle Center will be happy to advise you.

 BMW recommends that you use only wheel and tire combinations that BMW has tested and approved for your particular vehicle. Variations in factors such as manufacturing tolerances mean that even wheels and tires with identical official size ratings could actually have different dimensions than the approved units – these differences could lead to body contact, and with it the risk of severe accidents. If non-approved wheels and tires are used, BMW cannot evaluate their suitability, and therefore cannot be held liable for driving safety. ◀

 When changing to larger wheels and tires, it may be necessary to make changes to the wheelwell trim piece, as otherwise road users could be endangered or the vehicle could be damaged. Only have this work carried out by a BMW Sports Activity Vehicle Center or a workshop that works in accordance with BMW guidelines and uses appropriately trained personnel. ◀

You can ask your BMW Sports Activity Vehicle Center for the correct wheel/tire combination.

The correct wheel/tire combination also affects various systems whose function would otherwise be impaired, e.g. ABS, DSC, xDrive, Dynamic Performance Control in the BMW X6, or Flat Tire Monitor.

To maintain good handling and vehicle response, use only tires of a single tread configuration from a single manufacturer. Following tire damage, have the original wheel and tire combination remounted on the vehicle as soon as possible.

Wheels with electronics for TPM Tire Pressure Monitor

When mounting new tires or changing from summer to winter tires or vice versa, only use wheels with TPM electronics, otherwise the Tire Pressure Monitor cannot detect a flat tire, refer to page 94. Your BMW Sports Activity Vehicle Center will be happy to advise you on this subject.

Recommended tire brands

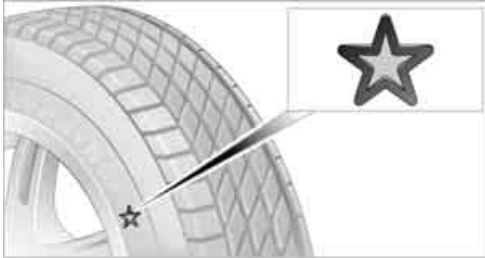

Certain tire makes are recommended by BMW depending on the tire size. You can recognize these from the clearly visible BMW marking on the tire sidewall.

When used properly, these tires comply with the most demanding standards for safety and vehicle response.

Special characteristics of winter tires

BMW recommends using winter tires for operation on winter road or at temperatures below +45 °F / +7 °C. Although all-season M+S tires provide better winter traction than summer tires, they generally fail to provide the same levels of cold-weather performance as winter tires.

Paying attention to speed

 Always observe the maximum permissible speed for the winter tires, otherwise tire damage may occur, which can result in accidents. ◀

Storage

Store wheels and tires in a cool, dry place with as little exposure to light as possible. Always protect tires against all contact with oil, grease and fuels. Do not exceed the maximum tire inflation pressure indicated on the side wall of the tire.

Rotating wheels between axles

 Even with tires of the same size, BMW recommends that you not rotate the front tires to the rear or vice versa as this can negatively affect handling characteristics. When the vehicle is equipped with different tires sizes*, rotating tires from one axle to the other is not permitted. ◀

Snow chains*

BMW only tests certain fine-link snow chains, classifies them as road-safe and recommends them. Your BMW Sports Activity Vehicle Center can provide you with this information.

BMW X5: use is only permitted in pairs on the rear wheels with tires of the size:

- ▷ 255/55 R 18
- ▷ 255/50 R 19

BMW X6: it is only permissible to use snow chains in pairs, on the 255/50 R 19 rear wheels.

Observe the manufacturer's instructions when mounting snow chains. Do not exceed a speed of 30 mph/50 km/h with the chains mounted.

 After mounting snow chains, do not initialize the Flat Tire Monitor*, as otherwise incorrect displays can occur.

When you are driving with snow chains, it can be beneficial to activate DTC briefly, refer to page 89. ◀

Under the hood

 Never attempt to perform any service or repair operations on your vehicle without the required professional technical training. If you do not know what repair procedures to follow, have work on your vehicle done only by your BMW Sports Activity Vehicle Center or a workshop that works according to BMW repair procedures with correspondingly trained personnel. If this work is not carried out properly, there is a danger of subsequent damage and related safety hazards. ◀

Hood

Releasing

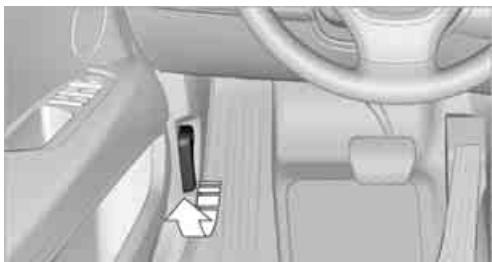

Pull lever.

Opening



Press the release handle and open the hood.

Closing



Close the hood from a height of approx. 16 in/ 40 cm with momentum. It must be clearly heard to engage.

 Make sure that the closing path of the hood is clear, otherwise injuries may result.

If you see any signs that the hood is not completely closed while driving your vehicle, you should stop at once and close it securely. ◀

Engine compartment

BMW X5

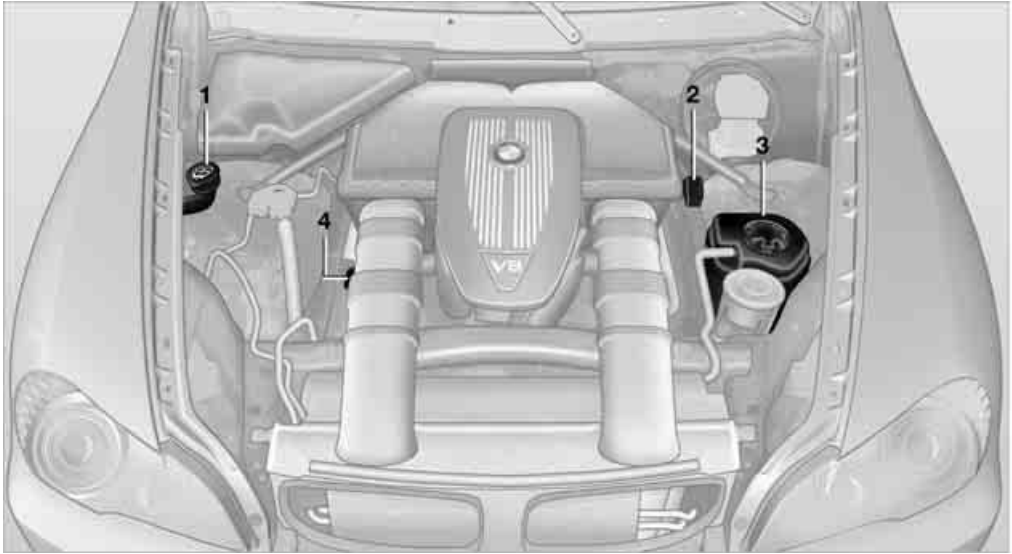

- 1 Filler neck for washer fluid of the headlamp and windshield cleaning systems, refer to page [69](#)
- 2 Starting-aid terminal, refer to page [262](#)
- 3 Expansion tank for coolant, refer to page [243](#)
- 4 Filler neck for engine oil, refer to Adding engine oil on page [242](#)

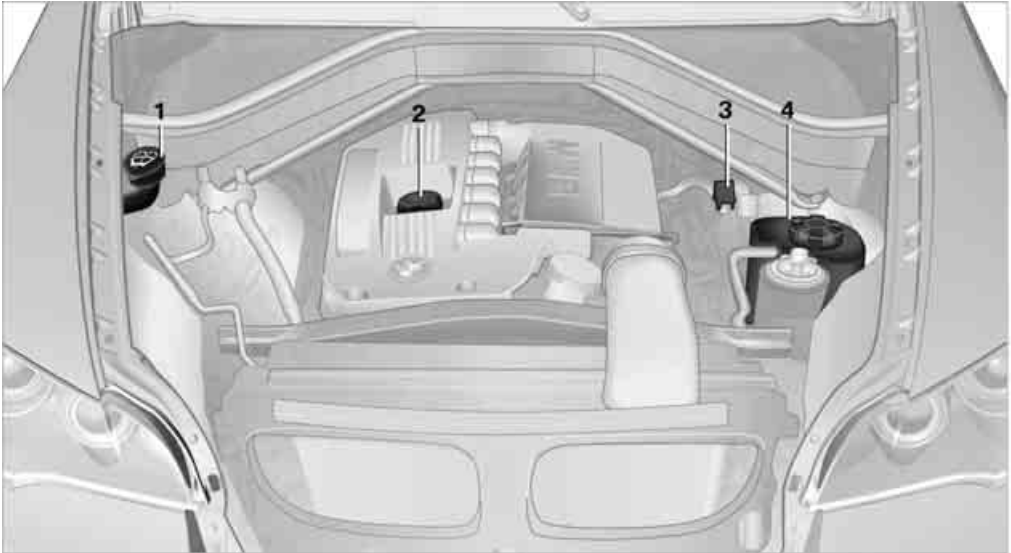

- 1 Filler neck for washer fluid of the headlamp and windshield cleaning systems, refer to page 69
- 2 Filler neck for engine oil, refer to Adding engine oil on page 242
- 3 Starting-aid terminal, refer to page 262
- 4 Expansion tank for coolant, refer to page 243

Engine oil

The engine oil consumption is dependent on driving style and driving conditions.

Checking engine oil level

Your vehicle is equipped with an electronic oil level check.

The condition for the most accurate indication of the oil level possible is measurement with the engine at operating temperature, i.e. following an uninterrupted drive of at least 6 miles/10 km. You can display the oil level while driving or when stopped on a level surface with the engine running.

- 1. "Vehicle Info"
- 2. "Vehicle status"



3. "Engine oil level"



Possible messages

- ▷ "Engine oil level OK"
- ▷ "Measuring engine oil level...":
This process can take approx. 3 minutes when stopped on a level surface and approx. 5 minutes while driving.
- ▷ "Engine oil level below minimum. Add 1 quart!":
At the next opportunity, add 1 US quart/liter of engine oil.



If the oil level displayed is below minimum, add engine oil immediately. Failure to do so may lead to engine damage. ◀

- ▷ "Engine oil level too high! Have this checked.":



Have the vehicle checked immediately, otherwise engine damage may result if too much oil has been added. ◀

- ▷ "Measurement inactive. Have this checked.":
Do not add engine oil. Before continuing to drive, note the recalculated remaining mileage until the next oil change service, refer to Service requirements on page 74. Have the system checked as soon as possible.

Adding engine oil

BMW X5

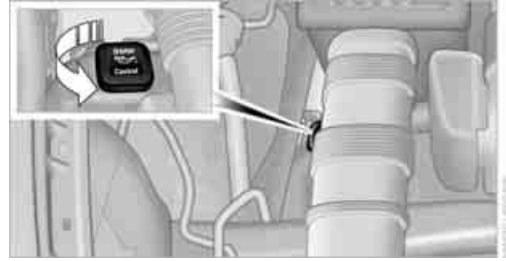

BMW X6

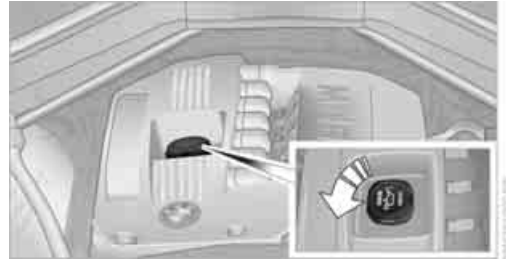

Do not add 1 US quart/liter of oil until a corresponding message is shown on the Control Display.



Add oil within the next 125 miles/200 km, otherwise the engine could be damaged. ◀



Continuous exposure to used oil has caused cancer in laboratory testing. For this reason, any skin areas that come into contact with oil should be thoroughly washed with soap and water. Keep oil, grease etc. out of reach of children and observe the warnings on the containers to prevent health risks. ◀

Oil change

Only have an oil change carried out by a BMW Sports Activity Vehicle Center or a workshop that works in accordance with BMW guidelines and uses appropriately trained personnel.

Approved engine oils

The quality of the engine oil selected has critical significance for the operation and service life of an engine. BMW continuously approves specific oils after confirming their suitability for use in its vehicles with extensive testing.

 Your BMW Sports Activity Vehicle Center will be happy to answer more detailed questions about approved oils. ◀

You can also call BMW of North America at 1-800-831-1117 or visit the website at www.bmwusa.com to obtain this information.

 Do not use oil additives, as these may result in engine damage. ◀

Alternative oil grades

If none of the approved oils is available at a given time, you can also use smaller quantities of other oils between oil changes. The packaging must include one of the following indications of oil specifications.

Gasoline engines

- ▶ Preferred: BMW Longlife-01, BMW Longlife-01 FE
- ▶ Alternative: BMW Longlife-98, API SM or higher

Diesel engines

- ▶ BMW Longlife-04

Viscosity grades

Viscosity is a measure of an oil's flow rating and is specified in SAE grades.

The choice of the right SAE grade is based on the climatic conditions in the region in which you normally drive your BMW.

 Approved oils belong to the SAE classifications 0W-40, 0W-30, 5W-40 and 5W-30. ◀

These oils can be used for driving at all outside temperatures.

BMW recommends 

Coolant

 Do not add coolant to the cooling system when the engine is hot. Escaping coolant can cause burns. ◀

Coolant is composed of equal parts water and a coolant additive. Not all commercially available additives are suitable for your BMW. Your BMW Sports Activity Vehicle Center can recommend suitable additives.

 Only use suitable additives, otherwise engine damage may result. The additives present a health hazard; observe the instructions on the containers. ◀

 Comply with the appropriate environmental protection regulations when disposing of coolant additives. ◀

Checking coolant level

1. Do not open the hood until the engine has cooled down.
2. Turn the cap of the expansion tank counterclockwise to allow any accumulated pressure to escape, then continue turning to open.
3. The coolant level is correct when the coolant level is between the MIN and MAX marks, refer to the diagram adjacent to the filler neck.
4. If the coolant is low, slowly add coolant up to the specified level; do not overfill.
5. Turn the cap until there is an audible click.
6. Have the reason for the coolant loss eliminated as soon as possible.

Maintenance

BMW maintenance system



The BMW maintenance system supports the preservation of the traffic and operating safety of your BMW. The service schedule also includes operations related to the vehicle's comfort and convenience features, such as replacement of the filters for the inside air. The ultimate objective is to ensure economical maintenance by providing the ideal service for your vehicle.

Should the day come when you decide to sell your BMW, a complete dealer service history will prove to be an asset of inestimable value.

CBS Condition Based Service

Sensors and special algorithms take the different driving conditions of your BMW into account. Condition Based Service uses this to determine the current and future service requirements. By letting you define a service and maintenance regimen that reflects your own individual requirements, the system builds the basis for trouble-free driving.

You can set the Control Display to show remaining distances and times of selected maintenance intervals and legally mandated deadlines, refer to page 74:

- ▷ Engine oil
- ▷ Brake pads, front and rear separately
- ▷ Brake fluid
- ▷ Vehicle check

- ▷ Legally mandated inspections depending on local regulations

Service data in remote control

Your vehicle stores the information required for maintenance continuously in the remote control during driving. After accessing the data stored in the remote control, your BMW Service Advisor can suggest precisely the right array of service procedures for your own individual vehicle. You should therefore hand over the remote control you last used to drive to the BMW Service Advisor when you take your vehicle in for service.

- ⚠ Make sure the date is set correctly, refer to page 80, otherwise the effectiveness of CBS Condition Based Service is not ensured. ◀

Service and Warranty Information Booklet for US models and Warranty and Service Guide Booklet for Canadian models

Please consult your Service and Warranty Information Booklet for US models and Warranty and Service Guide Booklet for Canadian models for additional information on service requirements.

- ▶ BMW recommends that you have service and repair operations performed at your BMW Sports Activity Vehicle Center. Take the time to ensure that these service procedures are confirmed by entries in your vehicle's Service and Warranty Information Booklet for US models and Warranty and Service Guide Booklet for Canadian models. These entries verify that your vehicle has received the specified regular maintenance. ◀

Socket for OBD Onboard Diagnostics interface

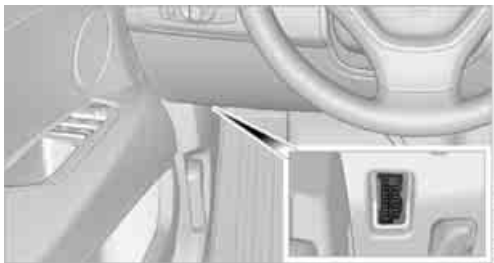

Components which are decisive for the exhaust-gas composition can be checked via the OBD socket with a device.

This socket is located to the left on the driver's side, on the underside of the instrument cluster under a cover.

Exhaust-gas values



The warning lamp lights up:

The vehicle is producing an elevated amount of exhaust emissions. Continued driving is possible. Have the vehicle checked as soon as possible.

The lamp flashes under certain conditions. This is a sign of excessive misfiring of the engine. In this case, you should reduce your speed and proceed to the nearest BMW Sports Activity Vehicle Center. Heavy engine misfiring causes serious damage to the emission-relevant components, especially the catalytic converter, within a short time.



The warning lamp lights up if the fuel cap has not been properly tightened and the OBD system detects the escape of fuel vapors. Check that the fuel cap is correctly seated and tighten it until you hear a clearly audible click.

Data recorders

Your vehicle may be equipped with one or several measuring and diagnosis modules, or with a device for recording or transmitting certain vehicle data or information. If you have also subscribed to BMW Assist, certain vehicle data can be transmitted or recorded to enable corresponding services.

Care

Car-care products

For the cleaning and care of your vehicle, BMW recommends using only products that BMW has approved for this purpose.

Regular cleaning and care make a significant contribution to retaining your BMW's value.

The BMW Sports Activity Vehicle Center will be happy to consult you on products and services for the cleaning and care of your BMW.

 Genuine BMW Care Products are materials tested, laboratory tested, and tested in actual use. They offer optimum care and protection for your vehicle. ◀

 Do not use cleaners that contain alcohol or solvents; they can damage your vehicle. ◀

 Cleaning agents can contain substances that are dangerous or pose health risks. You should therefore heed the warnings and hazard indications on the packaging. Open the doors or windows on your vehicle whenever cleaning the interior. Make sure there is sufficient ventilation in enclosed spaces. Use only products that are formulated for vehicle cleaning. ◀

Exterior care

Washing your vehicle

 In the winter months, it is especially important to ensure that the vehicle is washed on a regular basis. Otherwise, significant soiling and road salt can cause damage to the vehicle. ◀

 After washing the vehicle, apply the brakes briefly to dry them. Failure to do so may lead to a reduction in braking efficiency and also to corrosion of the brake rotors. ◀

Car washes

Give preference to cloth car washes.

Before driving into the car wash, make sure that it is suitable for your BMW. Pay attention to the following points:

- ▷ Dimensions of your vehicle, refer to page 269.
- ▷ If necessary, fold in exterior mirrors, refer to page 52.
- ▷ Maximum permissible tire width.

 Avoid car washes with guide rail heights over 4 in/10 cm, otherwise there is danger of damaging chassis parts. ◀

Preparations for driving into the car wash:

- ▷ Deactivate rain sensor* to prevent unwanted wiper activation.
- ▷ BMW X5: deactivate rear window wiper and protect it from damage. Take appropriate protective measures; inquiring with the car wash operator as needed.
- ▷ Remove add-on parts such as spoilers or phone antennas if they risk being damaged.

Before driving into the car wash, observe the following so that the vehicle is able to roll:

1. Insert the remote control into the ignition lock, even with comfort access.
2. Shift into transmission position N.
3. Release the parking brake.
4. Deactivate Automatic Hold, refer to page 62.
5. Switch off the engine.
6. Leave the remote control in the ignition lock so that the vehicle can roll.

Mixed tires*

 Before driving into a car wash, make sure that the vehicle width is not too large for the car wash, as otherwise the vehicle and the car wash could be damaged. ◀

Steam cleaners/high-pressure cleaning jets

 When using steam cleaners or high-pressure cleaning jets, make sure to maintain a sufficient distance and stay below a maximum temperature of 140 °F /60 °C. Insufficient distance or excessive pressure or temperature can damage parts of the vehicle or can result in water penetration. Follow the operating instructions for the high-pressure cleaning jets. ◀

 Do not spray the sensors and cameras, e.g. of Park Distance Control, Top View, or rear view camera, with high-pressure cleaners for long periods and keep the spray nozzle at least 12 in/30 cm away from them. ◀

Hand washing

When washing the vehicle by hand, use plenty of water and car washing shampoo. Clean the vehicle with gentle pressure using a sponge or a washing brush.

 Before cleaning the windshield, deactivate the rain sensor or switch off the ignition to prevent unwanted wiper operation. ◀

 Follow local guidelines for washing vehicles by hand. ◀

Headlamps

Do not rub dry and never use abrasives or strong solvents to clean the covers.

Loosen dirt, e.g. insects, with shampoo or insect remover and wash away with plenty of water.

Use a window de-icer to remove accumulated ice and snow, not a scraper.

Windows

Use a glass cleaner to clean the inside and outside surfaces of the windows and the glass surfaces of the mirrors.

 Do not use quartz-containing cleansers to clean glass surfaces of the mirrors. ◀

Caring for the vehicle finish

Regular care helps your vehicle retain its value and protects the paint from the long-term effects of aggressive substances.

Regionally occurring environmental factors can affect and damage vehicle finish. It is therefore important to tailor the frequency and extent of your car care accordingly.

Immediately remove particularly aggressive substances such as spilled fuel, oil, grease, brake fluid, tree resin, or bird droppings; otherwise, they may damage your paint.

Repairing paint damage

 Repair stone damage or scratches immediately, depending on the severity of the damage, to prevent the formation of rust. ◀

BMW recommends having paint damage professionally repaired using Genuine BMW finish materials in accordance with factory guidelines.

Waxing

Sealant is required when water no longer beads on the clean surface of the paint. Use only products that contain carnauba wax or synthetic wax to seal your finish.

Rubber gaskets

Treat only with water or a rubber care product.

 To avoid noise or damage, do not use products that contain silicone to care for rubber gaskets. ◀

Chrome components

Particularly after exposure to road salt, thoroughly cleanse parts like the radiator grille, door handles, or window frames with plenty of water with shampoo added to it. For additional treatment, use chrome polish.

Alloy wheels

Depending on your system, braking can generate dust, which settles on the light-alloy wheels. Remove this dust regularly with acid-free wheel cleaner.

 Do not use aggressive, acid-containing, strongly alkaline, or coarse cleansers and do not use steam cleaners at temperatures greater than 140 °F /60 °C; otherwise you may damage your vehicle. ◀

Aluminum running boards

A rust film on the aluminum running boards can be removed with a special cleaning agent.

Outside sensors/cameras

 Make sure that sensors and cameras outside the vehicle, e.g. Park Distance Control, Top View, or rear view camera, are kept clean and free of ice in order to assure full functionality. ◀

Interior care

Upholstery materials/cloth-covered paneling

Clean regularly with a vacuum cleaner in order to remove surface dirt.

In the event of more serious soiling such as beverage stains, use a soft sponge or a lint-free microfiber cloth in combination with suitable interior cleaners. Follow the instructions on the packaging.

 Clean upholstery material over a large area extending out to the seams. Avoid intense friction. ◀

 Open Velcro fasteners on pants or other items of clothing can cause damage to the seat covering. Make sure that the Velcro fasteners are closed. ◀

Leather/leather-covered paneling

 The leather used by BMW is a high quality natural product. Slight patterns in the grain are part of the typical properties of a natural leather. ◀

Dust and dirt from the road chafe in pores and folds and result in considerable wear and cause the leather surface to become prematurely brittle. We therefore suggest that you clean the

leather with a dust cloth or vacuum cleaner at regular intervals.

Particularly with light-colored leather, make sure to clean it regularly since it has a greater tendency to become soiled.

Treat the leather twice a year with a leather lotion since dirt and grease harm the protective layer of the leather.

Carpets/cargo bay

Floor carpets and floor mats can be vacuumed or cleaned with interior cleaner when they are more heavily soiled.

Floor mats can be removed for cleaning. When inserting into place, make sure that the seat rails do not protrude over the floor mats; otherwise floor mats can be damaged.

Fluff on new floor mats is a result of the production process and can be removed by repeated vacuuming.

Plastic components inside

- ▷ Vinyl upholstery surfaces
- ▷ Lamp lenses
- ▷ Cover glass of instrument cluster
- ▷ Matt parts

should be cleaned with water and, if necessary, solvent-free plastic cleaner.

Fine wooden components

Use a damp cloth to clean fine wooden trim panels and components. Follow up by drying with a soft cloth.

Safety belts

Soiled seatbelt straps hinder the reeling, thus reducing safety.

 Do not use chemical cleansers as they can destroy the webbing. ◀

Inside sensors/cameras

Clean inside sensors and cameras, such as those of the high-beam assistant, using a lint-free cloth moistened with glass cleaner.

Displays

Clean displays like the radio or the instrument cluster using a display-cleaning cloth or a soft, nonabrasive lint-free cloth.

 Avoid using excessive pressure when cleaning displays; otherwise, you could damage them. ◀

 Never use chemical-based cleansers or household scouring products. Keep all liquids away from the equipment. Otherwise surfaces or electrical components could be attacked or damaged. ◀

CD/DVD-player

 Do not use cleaning CDs; they can damage parts of the player. ◀

Storing your vehicle

When storing your vehicle for longer than three months, please seek the advice of your BMW Sports Activity Vehicle Center or a workshop that works in accordance with BMW guidelines.

Replacing components

Onboard toolkit

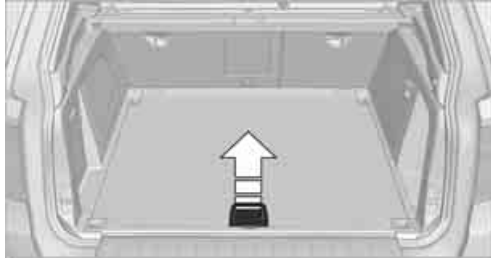

The onboard toolkit is located in the cargo bay under the floor panel.

BMW X5: rear

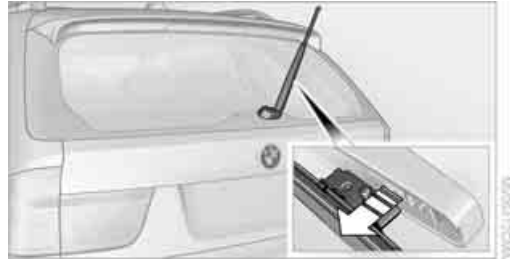

1. Lift off the wiper arm completely and pull off the wiper blade, refer to arrow.
2. Mount the new wiper blade and press on until it is heard to engage.

Replacing wiper blades

Front

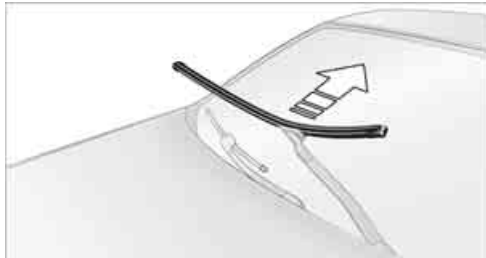

1. Fold down the wiper arm.
2. Swing the wiper blade upward.
3. Remove the wiper blade toward the windshield, refer to arrow.

Lamps and bulbs

Lamps and bulbs make an essential contribution to vehicle safety. You must be duly diligent in replacing them. BMW recommends having your BMW Sports Activity Vehicle Center perform any work that you do not feel competent to perform yourself or that is not described here.

- ⚠ Never touch the glass of new bulbs with your bare fingers, as even minute amounts of contamination will burn into the bulb's surface and reduce its service life. Use a clean cloth, napkin, etc., or hold the bulb by its metal socket. ◀

A replacement bulb set is available from your BMW Sports Activity Vehicle Center.

- ⚠ Only replace bulbs when cool, as otherwise you may be burned. ◀

- ⚠ Whenever you perform any work on the electrical system, turn off the systems/consumers involved to prevent short circuits from occurring. To avoid possible injury or equipment damage when replacing bulbs, observe any instructions provided by the bulb manufacturer. ◀

When performing care and maintenance on the headlamps, please observe the information on page 247.

 For bulbs for which replacement is not described and for checking and adjusting headlamp aim, please contact your BMW Sports Activity Vehicle Center. ◀

Light-emitting diodes LEDs

Light-emitting diodes installed behind translucent lenses serve as the light source for many of the controls and displays in your vehicle. These light-emitting diodes, which operate using a concept similar to that applied in conventional lasers, are officially designated as Class 1 light-emitting diodes.

 Do not remove the covers, and never stare into the unfiltered light for several hours, as irritation of the retina could result. ◀

BMW X5: changing lamps

Xenon lamps

These bulbs have a very long service life and the probability of a failure is very low. If a lamp should nevertheless fail, you can continue driving cautiously with fog lamps* provided that this is permitted by the country-specific laws.

 Have work on the xenon light unit including changing the bulb carried out only by your BMW Sports Activity Vehicle Center or a workshop that works according to BMW repair procedures with correspondingly trained personnel. Due to the high voltage present in the system, there is a danger of fatal injuries when work is carried out improperly. ◀

Halogen bulbs: Parking lamps and roadside parking lamps, daytime driving lamps

35-Watt bulb, H8

 The bulb is pressurized. Therefore, wear safety glasses and protective gloves. Otherwise there is a danger of injuries if the bulb is accidentally damaged during replacement. ◀

1. Turn the cover to the left and remove.

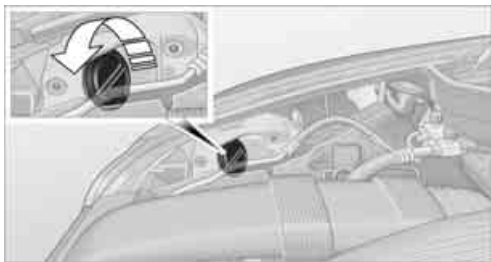

2. Turn the bulbs to the left, pull off the connector and replace.
3. Install in the reverse order.

Turn signals, front

24-Watt bulb, PY24W

1. Unscrew bulb holder with bulb to the left, refer to arrow, and replace.

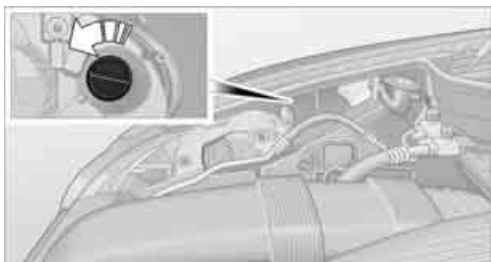

2. Install in the reverse order.

Side marker lamps, rear

To replace, please go to a BMW Sports Activity Vehicle Center or a workshop that works according to BMW repair procedures with correspondingly trained personnel.

Tail lamps

- ▷ Turn signals, brake lamps: 21-watt bulb, P21W
- ▷ Backup lamps and brake force display: 16-watt bulb, W16W
- ▷ Rear lamp: LED technology.
In case of a defect, please go to a BMW Sports Activity Vehicle Center or a workshop that works according to BMW repair

procedures with correspondingly trained personnel.

Arrangement of tail lamps

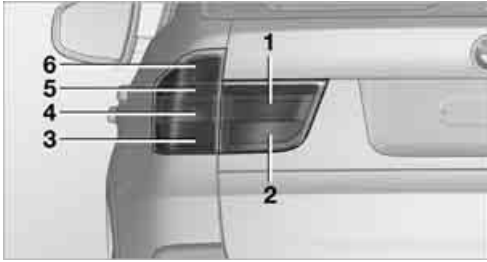

- 1 Rear lamp
- 2 Brake force display
- 3 Turn signal
- 4 Brake lamp/rear lamp/side marker lamp
- 5 Backup lamp
- 6 Brake lamp

Brake lamps

1. Open the side panel in the cargo bay.
2. Remove the first-aid kit* and warning triangle* if necessary. Fold up the insulation.
3. Rotate the relevant bulb socket to the left and remove.

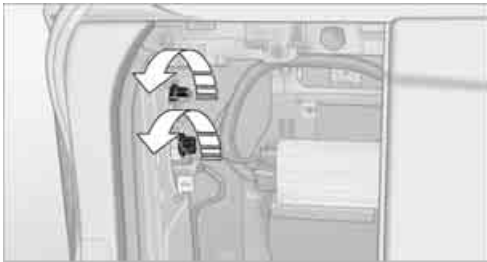

4. Remove the upper bulb for replacement. Apply gentle pressure to the lower bulb while turning it to the left for removal and replacement.
5. Remount the side panel.

Turn signal

1. Open the side panel in the cargo bay.
2. Remove the first-aid kit* and warning triangle* if necessary. Fold up the insulation.
3. Rotate the bulb socket to the left and remove.



4. Apply gentle pressure to the bulb while turning it to the left for removal and replacement.
5. Remount the side panel.

Backup lamp

1. Open the side panel in the cargo bay.
2. Remove the first-aid kit* and warning triangle* if necessary. Fold up the insulation.
3. Rotate the bulb socket to the left and remove.

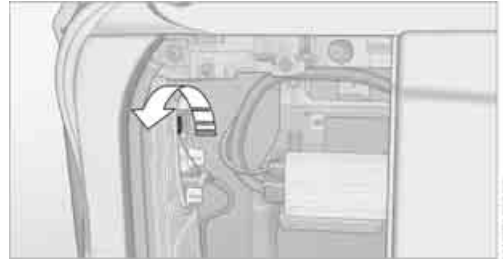

4. Remove the bulb for replacement.
5. Remount the side panel.

Brake force display

1. Carefully remove the cover in the liftgate panel with a screwdriver.

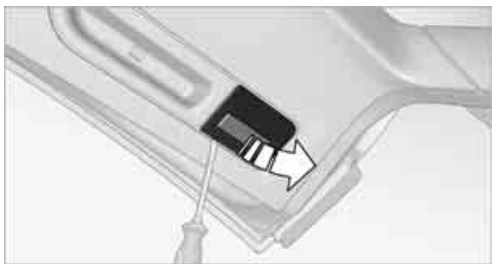

2. Rotate the bulb socket to the left and remove.



3. Apply gentle pressure to the bulb while turning it to the left for removal and replacement.
4. Insert the bulb socket in the liftgate and engage it.
5. Before installing the cap, unclip the cargo bay lamp. Then lay the cap on its upper side and close it, refer to arrow.



6. Position the cargo bay lamp and clip it in, refer to arrow.

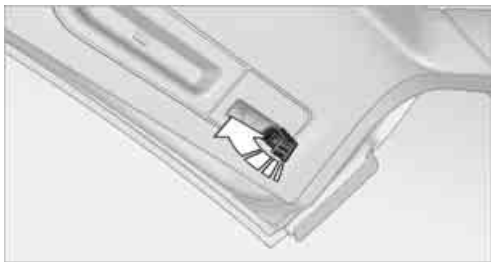

License plate lamp

5-watt bulb, C11 12W

1. Slide the lamp to the right with a screwdriver, refer to arrow 1.



2. Remove the lamp, arrow 2.
3. Replace the bulb.
4. Reinstall the lamp.

Center brake lamp

This lamp uses LED technology for operation. In case of a defect, please go to a BMW Sports Activity Vehicle Center or a workshop that works according to BMW repair procedures with correspondingly trained personnel.

BMW X6: changing lamps

Xenon lamps

These bulbs have a very long service life and the probability of a failure is very low. If a lamp should nevertheless fail, you can continue driving cautiously with fog lamps* provided that this is permitted by the country-specific laws.

⚠ Have work on the xenon light unit including changing the bulb carried out only by your BMW Sports Activity Vehicle Center or a workshop that works according to BMW repair procedures with correspondingly trained personnel. Due to the high voltage present in the system, there is a danger of fatal injuries when work is carried out improperly. ◀

Parking lamps and roadside parking lamps, daytime driving lamps

35-Watt bulb, H8

⚠ The bulb is pressurized. Therefore, wear safety glasses and protective gloves. Otherwise there is a danger of injuries if the bulb is accidentally damaged during replacement. ◀

1. Turn the cover to the left and remove.



2. Left side of vehicle:
Rotate the bulb holder to the right, refer to arrow, and remove.
Right side of vehicle:
Rotate the bulb holder to the left and remove.



3. Disconnect plug and replace bulb.
4. Install in the reverse order.

Side marker lamps

5-Watt bulb, WY5W XLL

1. Rotate the bulb holder to the left and remove.

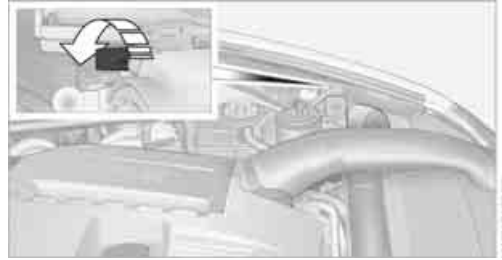

2. Pull the bulb out of the bulb holder and replace.
3. Install in the reverse order.

Turn signals, front

24-Watt bulb, PY24W

1. Rotate bulb holder to the left and remove it along with the bulb.



2. Rotate the bulb to the right along with the socket and replace.
3. Install in the reverse order.

Tail lamps

- ▷ Turn signals, backup lamps: 21-watt bulb, H21W
- ▷ Brake lamps, brake force display: 21-watt bulb, P21W
- ▷ Rear lamp: LED technology.

In case of a defect, please go to a BMW Sports Activity Vehicle Center or a workshop that works according to BMW repair

procedures with correspondingly trained personnel.

Arrangement of tail lamps



- 1 Brake force display/rear lamps
- 2 Brake lamp/rear lamp
- 3 Backup lamp
- 4 Turn signal

Brake lamps

1. Open the side panel in the cargo bay.
2. Remove the first-aid kit* and warning triangle* if necessary.
3. Rotate the relevant bulb socket to the left and remove.

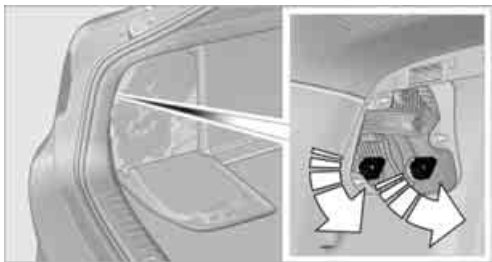

4. Apply gentle pressure to the bulb while turning it to the left for removal and replacement.
5. Install in the reverse order.

Turn signal

1. Open the side panel in the cargo bay.
2. Remove the first-aid kit* and warning triangle* if necessary.

3. Remove bulb holder along with bulb and replace.

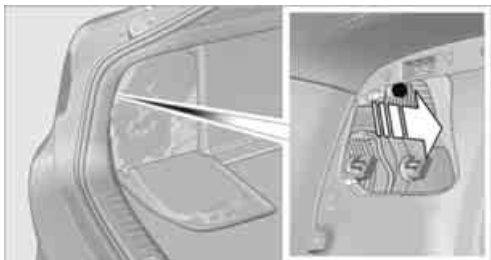

4. Install in the reverse order.

Backup lamp

1. Open the side panel in the cargo bay.
2. Remove the first-aid kit* and warning triangle* if necessary.
3. Remove bulb holder along with bulb and replace.

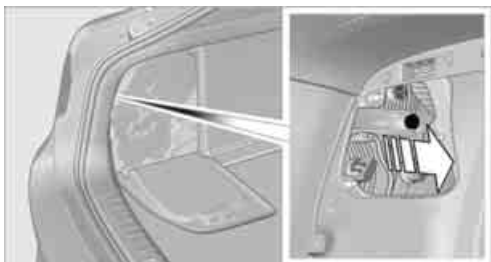

4. Install in the reverse order.

Brake force display

1. Carefully remove the cover in the liftgate panel with a screwdriver.

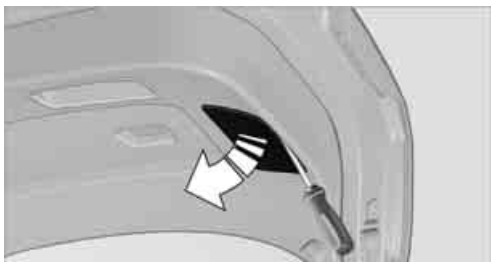

2. Rotate the bulb socket to the left and remove.

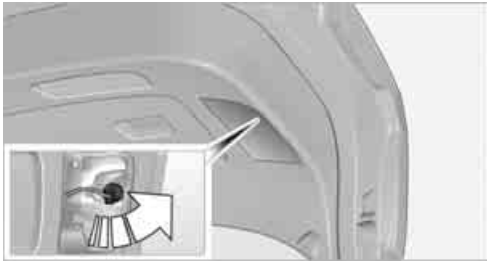

3. Apply gentle pressure to the bulb while turning it to the left for removal and replacement.
4. Insert the bulb socket in the liftgate and engage it.
5. Replace the cover.

License plate lamp

5-Watt bulb, C5W

1. Slide the lamp to the right with a screwdriver, refer to arrow 1.



2. Remove the lamp, arrow 2.
3. Replace the bulb.
4. Reinstall the lamp.

Center brake lamp

This lamp uses LED technology for operation. In case of a defect, please go to a BMW Sports Activity Vehicle Center or a workshop that works according to BMW repair procedures with correspondingly trained personnel.

Changing wheels

Your BMW is equipped with run-flat tires as standard. As a result, it is not necessary to change the wheel immediately in the case of air loss in the event of a breakdown.

To continue driving with a damaged tire:

- ▷ With Flat Tire Monitor, refer to Indication of a flat tire page 93
- ▷ With Tire Pressure Monitor, refer to Message with low tire inflation pressure page 95

You will recognize run-flat tires by a circular symbol containing the letters RSC on the side of the tire, refer to Run-flat tires, page 237.

When mounting new tires, or changing from summer to winter tires or vice versa, use run-flat tires for your own safety. No spare tire is available in case of a flat tire. Your BMW Sports Activity Vehicle Center will be happy to advise you. Also refer to New wheels and tires, page 237.

 BMW X6: do not rotate the front wheels to the rear or vice versa, as otherwise the handling characteristics will be negatively affected. ◀

 Suitable tools for changing tires are available as accessories at your BMW Sports Activity Vehicle Center. ◀

Jacking points for vehicle jack

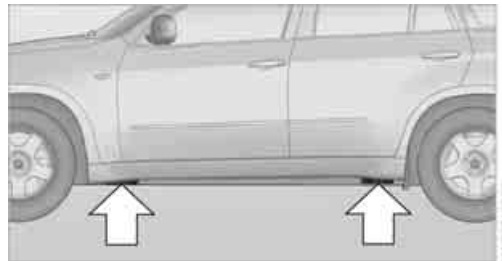

The jacking points for the vehicle jack are located in the positions shown.

Compact wheel*

 Safety precautions in the event of a flat tire or wheel change: park the vehicle as far as possible from passing traffic and on solid

ground. Switch on the hazard warning flashers. Set the parking brake and engage transmission position P.

Have all vehicle occupants get out of the vehicle and ensure that they remain outside the immediate area in a safe place, such as behind a guardrail.

If a warning triangle* or portable hazard warning lamp* is required, set it up on the roadside at an appropriate distance from the rear of the vehicle. Comply with all safety guidelines and regulations.

Change the wheel only on a level, firm surface which is not slippery. The vehicle or the jack could slip to the side if you attempt to raise the vehicle on a soft or slippery surface such as snow, ice, tiles, etc.

Position the jack on a firm support surface.

Do not use a wooden block or similar object as a support base for the jack, as this would prevent it from extending to its full support height and reduce its load-carrying capacity.

To avoid serious or fatal injury: never lie under the vehicle, and never start the engine while it is supported by the jack. ◀

What you will need

To avoid rattling noises later on, note the positions of the tools before removing them, then return them to their initial positions after completing work.

The tools are located in the mount under the floor panel flap.

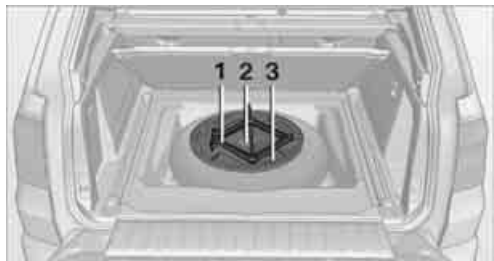

- 1 Vehicle jack*
- 2 Vehicle jack crank*
- 3 Lug wrench*

Removing compact wheel

The compact wheel is located in the cargo bay under the floor panel.



1. Remove the tool mount.
2. Unscrew the wing nut 1.
3. Remove the washer 2 laterally.
4. Remove the compact wheel.

Preparing wheel change

1. Observe the safety precautions above.
2. Loosen the lug bolts a half turn.

Jacking up vehicle

1. Position the vehicle jack at the jacking point closest to the wheel so that the entire surface of the jack base rests on the ground perpendicularly beneath the jacking point.



The vehicle jack is designed for changing wheels only. Do not attempt to raise another vehicle model with it or to raise any load of any kind. To do so could cause accidents and personal injury. ◀

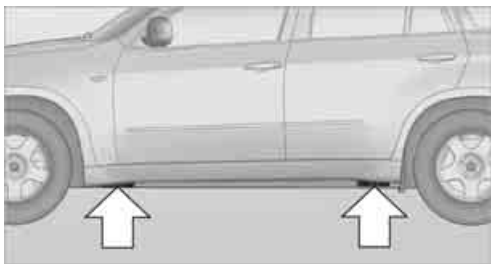

2. Guide the jack head into the rectangular recess of the jacking point when cranking up, refer to illustration detail.



3. Jack the vehicle up until the wheel you are changing is raised from the ground.

Mounting a wheel

1. Unscrew the lug bolts and remove the wheel.
2. Remove accumulations of mud or dirt from the mounting surfaces of the wheel and hub. Also clean the lug bolts.
3. Position the new wheel or compact wheel. Secure the wheel by screwing at least two lug bolts into opposite bolt holes. When you mount wheels other than Genuine BMW light-alloy wheels, different lug bolts may also be required.
4. Screw in the remaining lug bolts. Tighten all the bolts securely in a diagonal pattern.
5. Lower the vehicle and remove the jack from beneath the vehicle.

After mounting

1. Tighten the lug bolts in a diagonal pattern.



To ensure safety, always have the lug bolts checked with a calibrated torque wrench as soon as possible to ensure that they are tightened to the specified torque. Otherwise, incorrectly tightened lug bolts are a hidden safety risk. The tightening torque is 101 lb ft/140 Nm. ◀

2. Stow the defective wheel in the cargo bay.



The defective wheel cannot be stored under the floor panel flap due to its size. ◀

3. Check and correct the tire inflation pressure at the earliest opportunity.



Protect valve stems with valve screw caps against dirt and contamination. Dirt in valve stems is a frequent source of gradual air loss. ◀

4. Initialize the Flat Tire Monitor, refer to page 93, or reset the Tire Pressure Monitor, refer to page 94.
5. Replace the damaged tire as soon as possible and have the new wheel/tire balanced.

Driving with compact wheel



Drive reservedly and do not exceed a speed of 50 mph/80 km/h. Otherwise, changes in the driving characteristics could result, for example reduced track stability on braking, extended braking distance, and altered self-steering characteristics in the limit range. In conjunction with winter tires, these characteristics are more pronounced. ◀



Only one compact wheel may be mounted. Restore the wheels and tires to their original size as quickly as possible. Failure to do so is a safety risk. ◀

Vehicle battery

Battery care

The battery is 100% maintenance-free, i.e., the electrolyte will last for the life of the battery when the vehicle is operated in a temperate climate. Your BMW Sports Activity Vehicle Center will be glad to advise in all matters concerning the battery.

Charging battery

Only charge the battery in the vehicle via the terminals in the engine compartment with the engine switched off. Connections, refer to Jump starting on page 262.

Disposal



Have old batteries disposed of following replacement at your BMW Sports Activity

Vehicle Center or bring them to a collection point. Maintain the battery in an upright position for transport and storage. Always restrain the battery to prevent it from tipping over during transport. ◀

Power failure

Following a temporary power failure, e.g. due to a discharged battery, the use of some equipment will be restricted, requiring its reinitialization. In the same way, individual settings are lost and must be updated again:

- ▷ Seat, mirror and steering wheel memory
The positions must be stored again, refer to page 45.
- ▷ Time and Date
The values must be updated again, refer to pages 79, 80.
- ▷ Radio
Radio stations must be stored again, refer to page 164.
- ▷ Navigation system
You must wait until the system becomes functional again, refer to page 157.
- ▷ Glass sunroof/panorama glass sunroof
It may only be possible to raise the glass sunroof/panorama glass sunroof. The system must be initialized, refer to page 42.
- ▷ Digital compass
The system must be calibrated, refer to page 118.
- ▷ Active steering
The system automatically initializes for a short time as you drive. During this time, the system is deactivated, refer to page 97.
- ▷ xDrive
The system automatically initializes as you drive. During this time, indicator lamps light up. If the lamps do not disappear during the current trip, have the system checked.

▷ Before removing the vehicle from storage, consult your BMW Sports Activity Vehicle Center. ◀

Fuses

 Never attempt to repair a blown fuse and do not replace a defective fuse with a substitute of another color or amperage rating, as this could lead to a circuit overload, ultimately resulting in a fire in the vehicle. ◀

A pair of plastic tweezers and instructions for fuse allocation is stored with the fuses in the cargo bay.

Spare fuses can be obtained from your BMW Sports Activity Vehicle.

In interior

The fuses are located in the front passenger footwell on the underside of the instrument cluster.

1. Unscrew screws, refer to arrows, of footwell trim panel.



2. Lay the trim panel in the footwell.
3. Unscrew the screw, arrow 1, and fold down the fuse carrier, arrow 2.

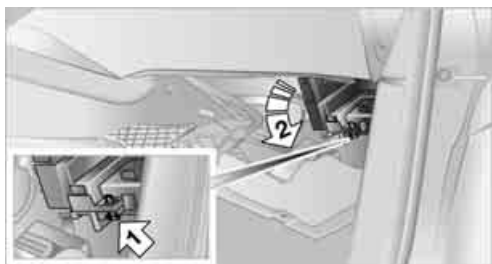

4. Replace the fuse concerned.
5. Installation is carried out in the reverse order of removal. Ensure correct and secure attachment of the footwell trim panel in the process.

In cargo bay

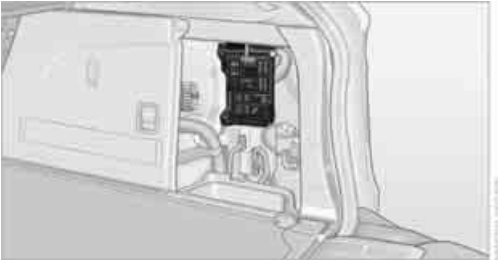

Open the right-hand side panel in the cargo bay.

Giving and receiving assistance

Emergency request

Conditions for an emergency request:

- ▶ Full preparation package mobile phone.
With this equipment, an emergency request is still possible when no mobile phone is paired in the vehicle.
- ▶ BMW Assist is activated.
Activating BMW Assist, refer to page 215.
- ▶ Radio readiness is switched on.
- ▶ The BMW Assist system is logged in on a wireless communications network.
- ▶ The emergency request system is operable.

When the contract of participation with BMW Assist expires, the BMW Assist system can be deactivated by a BMW Sports Activity Vehicle Center without having to visit a workshop. Once the BMW Assist system has been deactivated, emergency requests are not possible. The BMW Assist system be reactivated by a BMW Sports Activity Vehicle Center after signing a new contract.

Initiating an emergency request

1. Briefly press protective cover to open.
Depending on the vehicle's equipment, the arrangement of the switches and indicator lamps may differ somewhat.



2. Press the SOS button until the LED in the button lights up.

As soon as the voice connection to the BMW Assist Response Center has been established, the LED flashes.

When the emergency request is received at the BMW Assist Response Center, the BMW Assist Response Center contacts you and takes further steps to help you. Even if you are unable to answer, the BMW Assist Response Center can take further steps to help you under certain conditions.

If conditions allow, remain in the vehicle until the connection has been established. You will then be able to provide a detailed description of the situation.

Information for determining the required rescue measures is transmitted to the BMW Assist Response Center, e.g. the current position of your vehicle, if this can be determined.

If the LED flashes, but you are unable to hear the BMW Assist Response Center through the hands-free system, this could indicate, for instance, that the hands-free system is no longer operational. The BMW Assist Response Center may still be able to hear you, however.

Under certain conditions, an emergency request is automatically initiated immediately after a severe accident. An automatic collision notification is not affected by the button being pressed.

 For technical reasons, the emergency request cannot be guaranteed under unfavorable conditions. ◀

Warning triangle*

The warning triangle is located in the cargo bay.

First-aid kit*

Some of the articles contained in the first-aid kit have a limited service life. Therefore, check the expiration dates of the contents regularly and replace the contents concerned in good time if necessary.

The first-aid kit is stored in the cargo bay, depending on the vehicle's equipment,

- ▷ on the right in a storage tray or
- ▷ behind the left side panel

Roadside Assistance*

The BMW Roadside Assistance offers you assistance in the event of a breakdown around the clock, including on weekends and public holidays.

The phone numbers of the Roadside Assistance in your home country can be found in the Contact brochure.

With BMW Assist or BMW TeleServices, you can contact BMW Roadside Assistance directly via iDrive to request assistance in the event of a breakdown, refer to page 216.

Jump starting

When your battery is discharged, you can use two jumper cables to start your BMW with power from the battery in a second vehicle. You can also use the same method to help start another vehicle. Use only jumper cables with fully-insulated clamp handles.

⚠ To avoid the risk of potentially fatal injury, always avoid all contact with electrical components while the engine is running. Carefully adhere to the following sequence, both to prevent damage to one or both vehicles, and to guard against possible personal injuries. ◀

Preparation

1. Check whether the battery of the other vehicle has a voltage of 12 Volts and approximately the same capacitance in Ah. This information can be found on the battery.
2. Switch off the engine of the assisting vehicle.
3. Switch off any electrical systems and components in both vehicles.

⚠ There must not be any contact between the bodies of the two vehicles, otherwise there is a danger of shorting. ◀

Connecting jumper cables

⚠ To avoid personal injury from sparks, follow this sequence when connecting jumper cables. ◀

On your BMW the so-called starting-aid terminal in the engine compartment acts as the battery positive terminal, also refer to the engine compartment overview on page 240. The cover cap is marked with +.

1. Fold open the cover of the BMW starting-aid terminal. To do so, pull the tab.

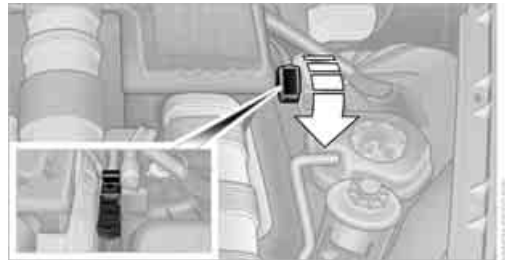

2. Attach one end of the jumper cable plus/+ to the positive terminal of the battery or a starting-aid terminal of the vehicle providing assistance.
3. Attach the second end of the cable to the positive terminal of the battery or to a starting-aid terminal of the vehicle to be started.
4. Attach one end of the jumper cable minus/- to the negative terminal of the battery or to an engine or body ground of the assisting vehicle.

Your BMW has a special nut as body ground or negative pole.



5. Attach the second end of the cable to the negative terminal of the battery or to the engine or body ground of the vehicle to be started.

Starting engine

1. Start the engine on the assisting vehicle and allow it to run at idle for several minutes at slightly increased speed.
2. Start the engine on the other vehicle in the usual way.
If the first starting attempt is not successful, wait a few minutes before another attempt in order to allow the discharged battery to recharge.
3. Let the engines run for a few minutes.
4. Disconnect the jumper cables by reversing the connection sequence.

Check the battery and recharge if necessary.

 Never use spray fluids to start the engine. ◀

Tow-starting and towing

 Observe applicable laws and regulations for tow-starting and towing. ◀

 Do not transport any passengers other than the driver in a vehicle that is being towed. ◀

Using a tow fitting

The screw-on tow-fitting must always be carried in the vehicle. It can be screwed in at the front or rear of the BMW.

It is located in the toolkit under the floor panel flap in the cargo bay, refer to page 250.

 Use only the tow fitting provided with the vehicle and screw it all the way in. Use the tow fitting for towing only on roads. Avoid lateral loading of the tow fitting, e.g. do not lift the vehicle by the tow fitting. Otherwise damage to the tow fitting and the vehicle can occur. ◀

Access to screw thread

Cover panel on left and right side of bumper: press on the arrow symbol on the cover panel.

Front

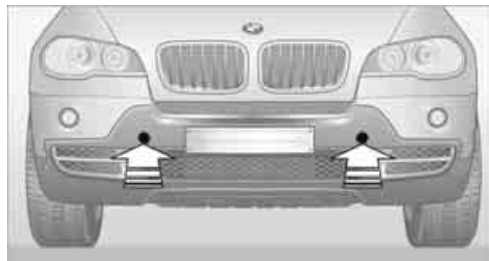

Rear



Being towed

 Make sure that the ignition is switched on, refer to page 59, otherwise the low beams, tail lamps, turn signals and windshield wipers would not be available. When the engine is stopped, there is no power assist. This then requires increased effort for braking and steering. Active steering is deactivated and larger steering wheel movements are required. ◀

Switch on the hazard warning flashers depending on the local regulations. If the electrical sys-

tem fails, mark the vehicle to be towed, e.g. with a sign or warning triangle in the rear window.

⚠ Before towing, manually unlock the transmission lock, refer to page 66; failure to do so can result in damage to the transmission. ◀

⚠ Do not exceed a towing speed of 45 mph/70 km/h and a towing distance of 90 miles/150 km, otherwise the automatic transmission may be damaged. ◀

Towing methods

⚠ Do not lift vehicle by tow fitting or body and chassis parts, otherwise damage may result. ◀

In some countries, towing with tow bars or ropes in public traffic is not permitted. Familiarize yourself with the regulations on towing in the respective country.

With tow bar

⚠ The towing vehicle may not be lighter than the vehicle to be towed, otherwise it will not be possible to reliably control vehicle response. ◀

The tow fittings used should be on the same side on both vehicles. Should it prove impossible to avoid mounting the tow bar at an offset angle, observe the following:

- ▷ Clearance and maneuvering capability will be sharply limited during cornering.
- ▷ When mounted at an angle, the tow bar will exert lateral forces, tending to push the vehicle sideways.

⚠ Only attach the tow bar to the tow fittings, as attachment to other vehicle parts can lead to damage. ◀

With tow rope

When starting off in the towing vehicle, make sure that the tow rope is taut.

⚠ To avoid jerking and the associated stresses on vehicle components when towing, always use nylon ropes or nylon straps. Only attach tow ropes to the tow fittings, as

attachment to other vehicle parts can lead to damage. ◀

With tow truck

⚠ Do not tow your BMW with the front or rear axle raised individually; otherwise, the wheels may lock and the transfer case may be damaged. ◀

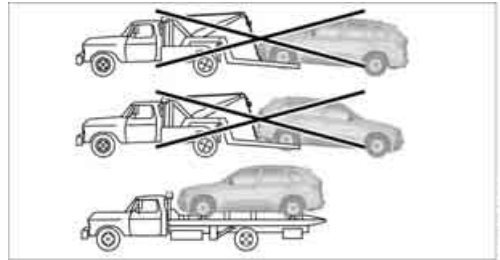

Have the BMW transported only on a flatbed surface.

Tow-starting

The engine cannot be started by tow-starting. Start the engine by jump starting it, refer to page 262.

Have the cause of the starting difficulties eliminated.



Reference

This chapter contains the technical data, the short commands of the voice activation system, and the index that will direct you as quickly as possible to the information you are looking for.

Technical data

Engine data

| BMW X5 | | X5 xDrive30i | X5 xDrive48i | X5 xDrive35d |
|------------------|-----------------------|--------------|--------------|--------------|
| Displacement | cu in/cm ³ | 182.8/2,996 | 292.9/4,799 | 182.6/2,993 |
| No. of cylinders | | 6 | 8 | 6 |
| Maximum output | hp | 260 | 350 | 265 |
| at engine speed | rpm | 6,600 | 6,300 | 4,200 |
| Maximum torque | lb ft/Nm | 225/305 | 350/475 | 425/580 |
| at engine speed | rpm | 2,750 | 3,400-3,800 | 1,750-2,250 |

| BMW X6 | | X6 xDrive35i | X6 xDrive50i |
|------------------|-----------------------|--------------|--------------|
| Displacement | cu in/cm ³ | 181.8/2,979 | 268.2/4,395 |
| No. of cylinders | | 6 | 8 |
| Maximum output | hp | 300 | 400 |
| at engine speed | rpm | 5,800-6,250 | 5,500-6,400 |
| Maximum torque | lb ft/Nm | 300/407 | 450/610 |
| at engine speed | rpm | 1,400-5,000 | 1,750-4,500 |

Dimensions

BMW X5

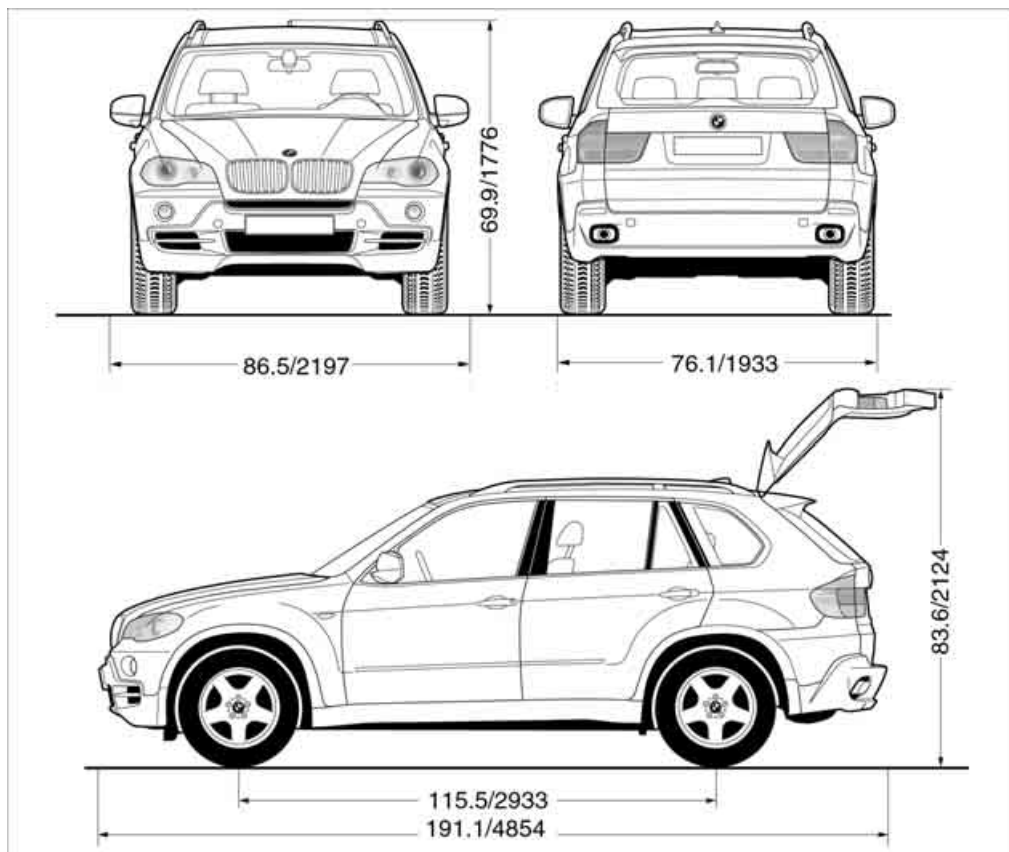

All dimensions given in inches/mm.

Smallest turning circle diam.: 42.0 ft/12.8 m

With mixed tires* the vehicle width may exceed the specified dimension.

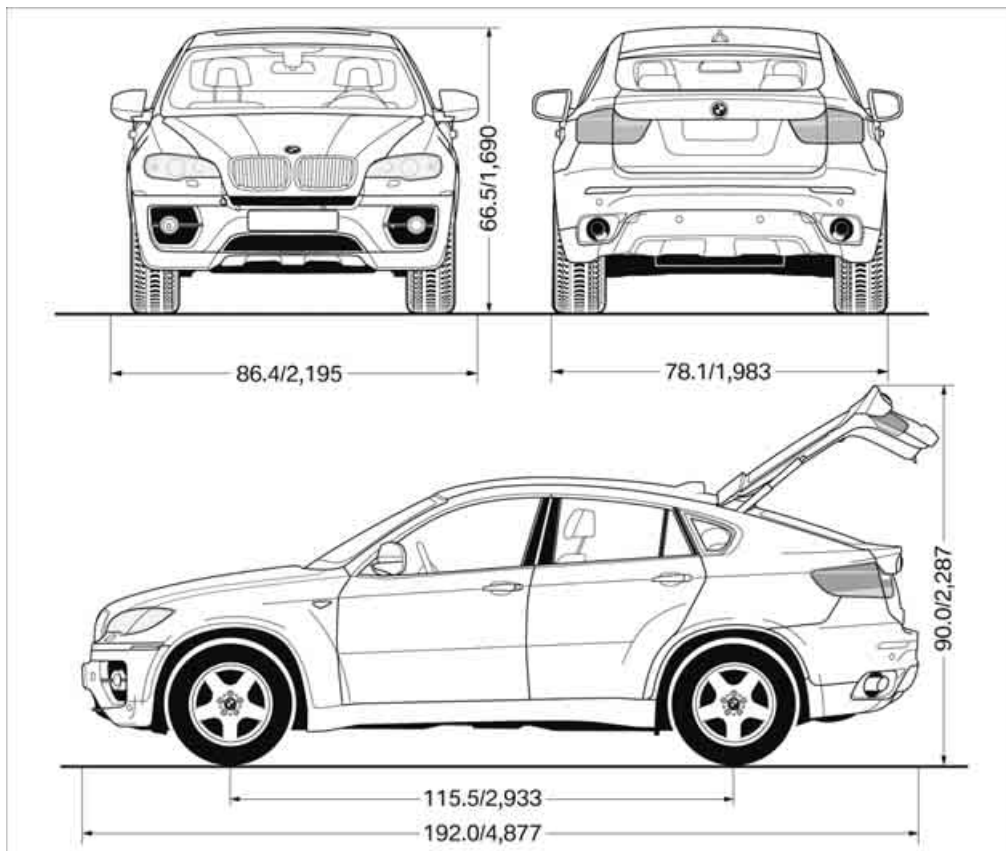

All dimensions given in inches/mm.

Smallest turning circle diam.: 42.0 ft/12.8 m

Height with roof rack*: 66.9 in/1,699 mm

With mixed tires* the vehicle width may exceed the specified dimension.

Weights

| BMW X5 | | X5 xDrive30i | X5 xDrive48i | X5 xDrive35d |
|-------------------------------|---------|-------------------------|-------------------------|-------------------------|
| Approved gross vehicle weight | lbs./kg | 6,327/2,870 | 6,537/2,965 | 6,614/3,000 |
| without 3rd row seats | lbs./kg | 6,008/2,725 | 6,173/2,800 | 6,294/2,855 |
| Load | lbs./kg | 1,290/585 | 1,290/585 | 1,290/585 |
| without 3rd row seats | lbs./kg | 1,102/500 | 1,102/500 | 1,102/500 |
| Approved front axle weight | lbs./kg | 2,767/1,255 | 3,020/1,370 | 3,064/1,390 |
| without 3rd row seats | lbs./kg | 2,778/1,260 | 3,020/1,370 | 3,064/1,390 |
| Approved rear axle weight | lbs./kg | 3,803/1,725 | 3,869/1,755 | 3,858/1,750 |
| without 3rd row seats | lbs./kg | 3,395/1,540 | 3,395/1,540 | 3,395/1,540 |
| Approved roof load capacity | lbs./kg | 220/100 | 220/100 | 220/100 |
| Cargo bay capacity | cu ft/l | 21.9-61.8/ 620-1,750 | 21.9-61.8/ 620-1,750 | 21.9-61.8/ 620-1,750 |

Never exceed either the approved axle loads or the gross vehicle weight.

| BMW X6 | | X6 xDrive35i | X6 xDrive50i |
|-------------------------------|---------|-------------------------|-------------------------|
| Approved gross vehicle weight | lbs./kg | 6,085/2,760 | 6,294/2,855 |
| Load | lbs./kg | 937/425 | 937/425 |
| Approved front axle weight | lbs./kg | 2,910/1,320 | 3,175/1,440 |
| Approved rear axle weight | lbs./kg | 3,241/1,470 | 3,219/1,460 |
| Approved roof load capacity | lbs./kg | 220/100 | 220/100 |
| Cargo bay capacity | cu ft/l | 25.6-59.7/ 570-1,450 | 25.6-59.7/ 570-1,450 |

Never exceed either the approved axle loads or the gross vehicle weight.

Capacities

| BMW X5 | | | Notes |
|--|------------------|-----------------|---|
| Fuel tank of that reserve | US gal/liters | approx. 22.5/85 | Fuel grade: page 225 |
| X5 xDrive30i, X5 xDrive35d | US gal/liters | approx. 2.1/8 | |
| X5 xDrive48i | US gal/liters | approx. 2.6/10 | |
| Windshield washer with headlamp washer system | US quarts/liters | approx. 6.9/6.5 | For more details: page 69 |

| BMW X6 | | | Notes |
|--|------------------|-----------------|---|
| Fuel tank of that reserve | US gal/liters | approx. 22.5/85 | Fuel grade: page 225 |
| X6 xDrive35i | US gal/liters | approx. 2.1/8 | |
| X6 xDrive50i | US gal/liters | approx. 3.2/12 | |
| Windshield washer with headlamp washer system | US quarts/liters | approx. 6.9/6.5 | For more details: page 69 |

Short commands of voice activation system*

With short commands you can carry out certain functions directly, regardless of which menu

item is selected. Here are the important short commands for the voice activation system.

Useful short commands

| Function | Command |
|------------------------------|--------------------|
| Accessing a music collection | ›Music collection‹ |
| Accessing tone control | ›Tone‹ |
| Accessing settings | ›Settings‹ |
| Accessing the computer | ›Onboard info‹ |
| Accessing contacts* | ›Contacts‹ |
| Displaying the phone book* | ›Phonebook‹ |
| Accessing BMW Assist* | ›B M W Assist‹ |
| Retrieving home address* | ›Home address‹ |
| Selecting destination entry* | ›Enter address‹ |

CD/Multimedia

CD/DVD drive

| Function | Command |
|---|---------------------------------------|
| Playing a CD | ›C D on‹ |
| Selecting a CD | ›Select C D‹ |
| Selecting a CD and track | ›C D ... track ...‹ e.g. CD 3 track 5 |
| Selecting a track | ›C D track ...‹ e.g. track 5 |
| Opening the CD and Multimedia menu | ›C D and multimedia‹ |
| CD and DVD* | ›C D and D V D‹ |
| Displaying entertainment details in split screen* | ›Entertainment details‹ |

Music collection

| Function | Command |
|------------------------------|-----------------------|
| Displaying current playback | ›Current playback‹ |
| Accessing a music collection | ›Music collection‹ |
| Playing a music collection | ›Music collection on‹ |

| Function | Command |
|--|-----------------|
| Searching for music; opening the menu | ›Music search‹ |
| Selecting a genre | ›Select genre‹ |
| Selecting an artist | ›Select artist‹ |
| Selecting an album | ›Select album‹ |
| Selecting a track | ›Select track‹ |
| Selecting track directly* | ›Track ...‹ |
| Starting playback | ›Start play‹ |
| Playing back the most frequently played tracks | ›Top fifty‹ |

External devices

| Function | Command |
|----------------------------|--------------------|
| Selecting external devices | ›External devices‹ |
| AUX front | ›AUX front‹ |

Tone control

| Function | Command |
|------------------------|---------|
| Accessing tone control | ›Tone‹ |

Radio

FM

| Function | Command |
|-------------------------------|-----------------------------|
| Selecting the radio | ›Radio‹ |
| Selecting FM stations | ›F M‹ |
| Selecting manual search | ›Manual search‹ |
| Selecting the frequency range | ›Select frequency‹ |
| Selecting a station | ›Select station‹ e.g. W-PLJ |

AM

| Function | Command |
|-------------------------|-----------------|
| Selecting AM stations | ›A M‹ |
| Selecting manual search | ›Manual search‹ |

Satellite radio

| Function | Command |
|-------------------------------------|--|
| Selecting the satellite radio | ›Satellite radio‹ |
| Switching on the satellite radio | ›Satellite radio on‹ |
| Selecting a satellite radio channel | ›Satellite radio channel ...‹ e.g. channel 2 |

Stored stations

| Function | Command |
|----------------------------|------------------------------------|
| Selecting stored stations | ›Presets‹ |
| Choosing a stored station | ›Select preset‹ |
| Selecting a stored station | ›Preset ...‹ e.g. stored station 2 |

Telephone

| Function | Command |
|---------------------------------|------------------|
| Opening the Telephone menu | ›Telephone‹ |
| Displaying the phone book | ›Phonebook‹ |
| Redialing | ›Redial‹ |
| Displaying accepted calls | ›Received calls‹ |
| Dialing a phone number | ›Dial number‹ |
| Displaying the list of messages | ›Messages‹ |
| Displaying Bluetooth devices | ›Bluetooth‹ |

Navigation

General information

| Function | Command |
|-------------------------------------|--------------------------------|
| Navigation menu | ›Navigation‹ |
| Selecting destination entry | ›Enter address‹ |
| Entering an address | ›Enter address‹ |
| Selecting destination guidance | ›Guidance‹ |
| Starting destination guidance | ›Start guidance‹ |
| Ending destination guidance | ›Stop guidance‹ |
| Retrieving home address | ›Home address‹ |
| Selecting route criteria | ›Route preference‹ |
| Selecting route | ›Route information‹ |
| Switching on the voice instructions | ›Switch on voice instructions‹ |

| Function | Command |
|--------------------------------------|---------------------------------|
| Repeating a voice instruction | ›Repeat voice instructions‹ |
| Switching off the voice instructions | ›Switch off voice instructions‹ |
| Displaying the address book | ›Address book‹ |
| Displaying the last destinations | ›Last destinations‹ |
| Accessing traffic bulletins | ›Traffic Info‹ |
| Special destinations | ›Points of interest‹ |

Map

| Function | Command |
|--------------------------------|------------------------------|
| Displaying the map | ›Map‹ |
| Map facing north | ›Map facing north‹ |
| Map in the direction of travel | ›Map in direction of travel‹ |
| Perspective map | ›Map perspective view‹ |
| Automatic scaling of the map* | ›Map with automatic scaling‹ |
| Changing the scale | ›Map scale‹ |

Split screen settings*

| Function | Command |
|---|---|
| Split screen | ›Switch on splitscreen‹ |
| Switching off the split screen | ›Turn off split screen‹ |
| Adapting the split screen | ›Split screen content‹ |
| Split screen current position | ›Split screen current position‹ |
| Split screen map facing north | ›Split screen map facing north‹ |
| Split screen direction of travel | ›Split screen map in direction of travel‹ |
| Split screen perspective | ›Split screen perspective‹ |
| Automatically scaling the split screen | ›Split screen automatic scaling‹ |
| Split screen enlarged intersection zoom | ›Splitscreen Exit ramp view‹ |
| Highlighting split screen traffic info | ›Split screen, Traffic Info map‹ |
| Split screen, computer | ›Split screen on board info‹ |
| Split screen, trip computer | ›Splitscreen trip computer‹ |

Destination guidance with intermediate destinations

| Function | Command |
|----------------------------|-----------------|
| Entering a new destination | ›Enter address‹ |
| Trip list | ›Stored trips‹ |

Contacts

| Function | Command |
|--------------------|---------------|
| Accessing contacts | ›Contacts‹ |
| My contacts | ›My contacts‹ |
| New contact | ›New contact‹ |

BMW Assist

| Function | Command |
|-------------------------|----------------|
| Accessing BMW Assist* | ›B M W Assist‹ |
| Accessing the Internet* | ›Internet‹ |

Vehicle information

| Function | Command |
|-------------------------------|------------------|
| Accessing the computer | ›Onboard info‹ |
| Accessing the trip computer | ›Trip computer‹ |
| Accessing vehicle information | ›Vehicle info‹ |
| Accessing vehicle status | ›Vehicle status‹ |

Settings

Vehicle

| Function | Command |
|--------------------------------------|----------------------|
| Opening the main menu | ›Main menu‹ |
| Selecting the settings | ›Settings‹ |
| Accessing options | ›Options‹ |
| Settings on the Control Display | ›Control display‹ |
| Accessing time and date settings | ›Time and date‹ |
| Accessing language and unit settings | ›Language and units‹ |
| Accessing speed limit settings | ›Speed‹ |
| Activating lighting | ›Lighting‹ |
| Selecting the door lock | ›Door locks‹ |

Equipment

| Function | Command |
|--------------------------------|----------------------|
| Selecting the air conditioning | ›Climate‹ |
| Activating Head-Up Display*: | ›head up display‹ |
| Enabling rear control* | ›Allow rear control‹ |

Everything from A to Z

Index

A

- ABS Antilock Brake System **88**
- Accessories **5**
- Access to 3rd row seats **48**
- Acoustic signal, refer to Check Control **77**
- Activated-charcoal filter **112**
- Active seat **52**
- Active seat ventilation **51**
- Active steering **96**
 - malfunction **97**
 - warning lamp **97**
- Adaptive brake lamp, brake force display **97**
- Adaptive Drive **91**
- Adaptive fixing system **124**
- Adaptive Head Light **103**
- Address for navigation, entering **141, 147**
- Adjusting confirmation signals for locking and unlocking **28**
- Adjusting opening height **31, 33**
- Adjusting temperature with expanded-scope automatic climate control **109**
- Adjusting the tone during audio operation, refer to Tone control **160**
- Adjusting thigh support **44, 45**
- Airbags **98**
 - sitting safely **43**
 - warning lamp **99**
- Air distribution
 - automatic **108, 113**
 - manual **110**
- Air recirculation **110**
 - AUC Automatic recirculated-air control **110**
 - recirculated-air mode **110**
- Air vents **107**
 - refer to Ventilation **111**
- Air vents of automatic climate control **107**
- Air volume **109, 113**
- AKI, refer to Fuel specifications **225**
- Alarm system **34**
 - avoiding unintentional alarms **35**
 - interior motion sensor **35**
 - switching off alarm **34**
 - switching off tilt alarm sensor and interior motion sensor **35**
 - tilt alarm sensor **35**
- Albums of music collection **180**
- Alloy wheels **247**
- All-season tires, refer to Winter tires **238**
- All-wheel drive, refer to xDrive **90**
- Alterations, technical, refer to For your own safety **5**
- AM, waveband **163**
- Antenna for mobile phone **202**
- Antifreeze
 - coolant **243**
 - washer fluid **69**
- Antilock Brake System ABS **88**
- Anti-theft system
 - refer to Alarm system **34**
 - refer to Central locking system **27**
- Approved axle weights, refer to Weights **271**
- Approved engine oils **243**
- Approved gross vehicle weight, refer to Weights **271**
- Armrest, refer to Center armrest, front **119**
- Around the center console **14**
- Around the steering wheel **10**
- Arrival time, refer to Computer **74**
- Ashtray
 - front **120**
 - rear **120**
- Assist, refer to separate operating instructions
- Assistance systems, refer to Driving stability control systems **88**
- AUC Automatic recirculated-air control **110**
- Audio **160**
 - controls **160**
 - switching on/off **160**
 - tone control **160**
 - volume **160**
- Audio CDs, DVD system in rear **193**
- Audio device, external **119**
- Automatic
 - air distribution **108, 113**
 - air volume **108, 113**
 - headlamp control **102**
 - liftgate operation **31**
 - steering wheel adjustment, refer to Easy entry/exit **54**
- Automatically switching high-beams on and off, refer to High-beam assistant **104**
- Automatic car washes **246**
- Automatic climate control
 - automatic air distribution **108, 113**
 - in rear **112**
 - switching off **111, 113**
 - ventilation in rear **111**
 - with 2-zone control **108**
 - with 4-zone control **112**

Automatic climate control in rear
 – activating on Control Display [112](#)
 – deactivating on Control Display [112](#)
 Automatic closing of doors, refer to Automatic soft closing [30](#)
 Automatic curb monitor [53](#)
 Automatic garage door opener [115](#)
 Automatic headlamps, refer to High-beam assistant [104](#)
 Automatic Hold [61](#)
 – activating [62](#)
 – deactivating [62](#)
 – parking [62](#)
 Automatic lighting
 – refer to Automatic headlamp control [102](#)
 – refer to Daytime driving lamps [103](#)
 – refer to Interior lamps [106](#)
 – refer to Pathway lighting [103](#)
 Automatic low-beams, refer to High-beam assistant [104](#)
 Automatic recirculated-air control AUC [110](#)
 Automatic Service Request [219](#)
 Automatic soft closing [30](#)
 Automatic transmission with Steptronic [64](#)
 – deactivating selector lever interlock [65](#)
 – kick-down [65](#)
 – manually releasing transmission lock [66](#)
 – tow-starting [264](#)
 – with comfort access [36](#)
 AUTO program for automatic climate control [108](#), [113](#)
 AUX-IN connection [119](#), [183](#)
 Average fuel consumption [73](#)
 – setting units [80](#)
 Average speed, refer to Computer [73](#)

Avoiding highways for navigation [150](#)
 Avoiding unintentional alarms [35](#)
 Axle weights, refer to Weights [271](#)

B

Backrest contour, refer to Lumbar support [45](#)
 Backrests, refer to Seats [44](#)
 Backrest width adjustment [45](#)
 Backup lamps, replacing bulbs [251](#), [254](#)
 Band-aids, refer to First-aid kit [262](#)
 Base plate for telephone or mobile phone, refer to Snap-in adapter [212](#)
 Bass, tone setting [160](#)
 Battery
 – charging [258](#)
 – jump starting [262](#)
 – power failure [259](#)
 – refer to Vehicle battery [258](#)
 Battery disposal
 – remote control with comfort access [37](#)
 – vehicle battery [258](#)
 Battery for mobile phone [212](#)
 Battery replacement
 – remote control for DVD system in rear [189](#)
 – remote control with comfort access [37](#)
 Being towed [263](#)
 Belts, refer to Safety belts [49](#)
 Beverage holder, refer to Cup holders [119](#)
 Blower, refer to Air volume [109](#), [113](#)
 Bluetooth, activating/deactivating [204](#)
 BMW Advanced Diesel [226](#)
 BMW Assist [215](#)
 – activating [217](#)
 BMW homepage [4](#)

BMW maintenance system [244](#)
 BMW Search [217](#)
 BMW Sports Activity Vehicle Center [219](#)
 BMW TeleServices [216](#)
 BMW website [4](#)
 Bottle holder, refer to Cup holders [119](#)
 Brake assistant [88](#)
 Brake force display [97](#)
 Brake lamps
 – brake force display [97](#)
 – replacing bulbs [251](#), [254](#)
 Brake rotors [132](#)
 Brakes
 – ABS Antilock Brake System [88](#)
 – brake assistant [88](#)
 – brake force display [97](#)
 – breaking-in [130](#)
 – CBC Cornering Brake Control [88](#)
 – electronic brake-force distribution [88](#)
 – parking brake [61](#)
 – refer to Braking safely [132](#)
 – warning lamp [13](#)
 Brake system [130](#)
 – brake pads [130](#)
 – breaking-in [130](#)
 – disk brakes [132](#)
 Braking safely [132](#)
 Breakdown, Flat Tire Monitor [92](#)
 Breakdown services, refer to Roadside Assistance [262](#)
 Breaking-in brake pads [130](#)
 Breaking-in rear axle differential [130](#)
 Break-in period [130](#)
 Brightness
 – of Control Display [80](#)
 – on Head-Up Display [100](#)
 Button for starting engine [59](#)
 Buttons on steering wheel [11](#)

C

- Calibrating driver's seat [50](#)
- California Proposition [65](#)
 - Warning [6](#)
- Call
 - accepting [205](#)
 - ending [205](#)
 - rejecting [205](#)
- Calling, refer to Phone numbers, dialing [206](#)
- Calling, refer to telephone operating instructions
- Camera
 - refer to Rear view camera [86](#)
 - refer to Top View [84](#)
- Can holder, refer to Cup holders [119](#)
- Capacities [272](#)
- Capacity of cargo bay [271](#)
- Car battery, refer to Vehicle battery [258](#)
- Care [246](#)
 - car-care products [246](#)
 - carpets [248](#)
 - car washes [246](#)
 - CD/DVD-player [249](#)
 - chrome components [247](#)
 - displays [249](#)
 - exterior [246](#)
 - fine wooden components [248](#)
 - hand washing [247](#)
 - headlamps [247](#)
 - high-pressure cleaning jets [247](#)
 - interior [248](#)
 - leather [248](#)
 - light-alloy wheels [247](#)
 - paint [247](#)
 - plastic components [248](#)
 - rubber gaskets [247](#)
 - running boards [248](#)
 - safety belts [248](#)
 - sensors and cameras [248](#)
 - upholstery materials and cloth-covered paneling [248](#)
 - windows [247](#)
- Cargo
 - refer to Loading [133](#)
 - securing [134](#)
 - securing with ski bag [126](#)
- Cargo area, refer to Cargo bay [122](#)
- Cargo area cover, refer to Roll-up cover [122](#)
- Cargo bay
 - capacity [271](#)
 - emergency actuation, refer to Manually opening or closing [34](#)
 - emergency operation, refer to Opening manually [31](#)
 - expanding [124](#)
 - opening [33](#)
 - opening/closing, refer to Liftgate [30, 33](#)
 - opening/closing, refer to Tailgate [33](#)
 - opening from inside [31](#)
 - opening from outside [31](#)
 - opening with remote control [28](#)
- Cargo bay cover, refer to Roll-up cover [122](#)
- Caring for the vehicle finish [247](#)
- Car key, refer to Keys/remote control [26](#)
- Car phone
 - installation location, refer to Center armrest, front [119](#)
 - refer to separate operating instructions
 - refer to Telephone [202](#)
- Car radio, refer to Radio [163](#)
- Car wash [246](#)
 - before driving in [60](#)
 - with comfort access [37](#)
- Catalytic converter, refer to Hot exhaust system [131](#)
- CBC Cornering Brake Control [88](#)
- CBS Condition Based Service [244](#)
- CD
 - audio playback [172](#)
 - refer to Playing audio tracks, DVD system in rear [193](#)
- CD-/DVD player in rear [188](#)
- CD changer [171](#)
 - controls [160](#)
 - fast forward/reverse [173](#)
 - random play sequence [172](#)
 - selecting a track [172](#)
 - switching on/off [160](#)
 - tone control [160](#)
 - volume [160](#)
- CD player [171](#)
 - controls [160](#)
 - fast forward/reverse [173](#)
 - random play sequence [172](#)
 - selecting a track [172](#)
 - switching on/off [160](#)
 - tone control [160](#)
 - volume [160](#)
- Cell phone, refer to Mobile phone
- Center armrest
 - front [119](#)
 - rear [122](#)
- Center brake lamp [253, 256](#)
- Center console [14](#)
- Central locking system [27](#)
 - comfort access [35](#)
 - from inside vehicle [30](#)
- Changes, technical
 - refer to For your own safety [5](#)
 - refer to Parts and accessories [5](#)
- Changing gears using shift paddles [65](#)
- Changing language on Control Display [81](#)
- Changing tires [237](#)
- Changing trips [149](#)
- Changing units of measure on Control Display [80](#)
- Changing wheels [256](#)
- Check Control [77](#)
- Checking the air pressure, refer to Tire inflation pressure [229](#)

- Children, transporting **55**
 - Child restraint devices **55**
 - Child restraint fixing system LATCH **56**
 - Child-safety locks **58**
 - Child seats **55**
 - Chime, refer to Check Control **77**
 - Cigarette lighter, refer to Lighter **121**
 - Cleaning your BMW, refer to Care **246**
 - Clock **71**
 - 12h/24h mode **80**
 - setting time **79**
 - Closing
 - from inside **30**
 - using remote control **27**
 - Closing fuel filler cap **224**
 - Clothes hooks **119**
 - Cockpit **10**
 - Cold start, refer to Starting engine **60**
 - Comfort access **35**
 - observe in car wash **37**
 - replacing battery **37**
 - Comfort area, refer to Around the center console **14**
 - Comfort start, refer to Starting engine **60**
 - Compact wheel
 - inflation pressure **231**
 - wheel change **256**
 - Compartment for remote control, refer to Ignition lock **59**
 - Compartments, refer to Storage compartments **119**
 - Compass, digital **116**
 - Computer **73**
 - displays in instrument panel **73**
 - displays on Control Display **74**
 - Concierge service **216**
 - Condition Based Service CBS **244**
 - Connecting car vacuum cleaner, refer to Connecting electrical devices **121**
 - Connecting headphones **188**
 - Consumption, refer to Average fuel consumption **73**
 - Consumption indicator, energy control **72**
 - Consumption statistics, refer to Average fuel consumption **73**
 - Contacts, creating **213**
 - Control Center, refer to iDrive **16**
 - Control Display, refer to iDrive **16**
 - setting brightness **80**
 - switching on/off **19**
 - Controller, refer to iDrive **16**
 - Controls, refer to Cockpit **10**
 - Controls DVD system in rear **187**
 - Convenience operation
 - glass sunroof **28, 29**
 - glass sunroof with comfort access **36**
 - windows **28, 29**
 - windows with comfort access **36**
 - with comfort access **36**
 - Coolant **243**
 - checking level **243**
 - temperature **72**
 - Cooling, maximum **110**
 - Cornering Brake Control CBC **88**
 - Country codes DVD **173**
 - Country information from BMW Online **157**
 - Courtesy lamps, refer to Interior lamps **106**
 - Cradle for telephone or mobile phone **119**
 - Criteria for route **150**
 - Cruise control **69**
 - Cruising range **73**
 - Cup holders **119**
 - Current playback
 - external devices **185**
 - of music collection **180**
 - Customer Relations **218**
 - Cylinders, refer to Engine data **268**
- ## D
- Data **268**
 - capacities **272**
 - dimensions **269**
 - engine **268**
 - technical data **268**
 - weights **271**
 - Data transfer **220**
 - Date **71**
 - display format **80**
 - retrieving **71**
 - setting **80**
 - Daytime driving lamps **103**
 - Defrosting windows **109**
 - Defrosting windows and removing condensation **109**
 - Defrost position, refer to Defrosting windows **109**
 - Deleting a trip **149**
 - Deleting special destinations **146**
 - Destination, entering by town/city name **141**
 - Destination address, entering **141, 147**
 - Destination entry using BMW Assist **145**
 - Destination for navigation
 - entering **141**
 - entering by voice **147**
 - entering via map **146**
 - Destination guidance **150**
 - bypassing a route section **151**
 - changing specified route **150**
 - continuing **150**
 - starting **150**
 - voice instructions **152**
 - volume of voice instructions **152**

Diesel exhaust fluid
 – at low temperatures [226](#)
 – at minimum [226](#)
 – refilling yourself [227](#)
 Diesel particulate filter [131](#)
 Digital clock [71](#)
 Digital compass [116](#)
 Digital radio, refer to HD
 Radio [164](#)
 Dimensions [269](#)
 Directional indicators, refer to
 Turn signals [67](#)
 Direction announcements,
 refer to Voice
 instructions [152](#)
 Direction instructions, refer to
 Voice instructions [152](#)
 Directory for navigation, refer
 to Address book [143](#)
 Displacement, refer to Engine
 data [268](#)
 Display, refer to iDrive [16](#)
 Displaying images [195](#)
 Displaying special
 destinations [146](#)
 Display lighting, refer to
 Instrument lighting [105](#)
 Displays, refer to Instrument
 panel [12](#)
 Displays on the windshield,
 refer to Head-Up
 Display [100](#)
 Disposal
 – battery of remote control
 with comfort access [37](#)
 – battery of the remote
 control, DVD system in
 rear [189](#)
 – vehicle battery [258](#)
 Distance, refer to
 Computer [74](#)
 Distance to destination, refer
 to Computer [74](#)
 Distance warning, refer to
 PDC Park Distance
 Control [82](#)
 Door entry lighting [106](#)

Door key, refer to Keys/
 remote control [26](#)
 Door lock [29](#)
 Door locking, confirmation
 signals [28](#)
 Doors
 – manual operation [29](#)
 – remote control [27](#)
 DOT Quality Grades [235](#)
 Downhill driving assistance,
 refer to HDC [90](#)
 Draft-free ventilation [111](#)
 Drinks holder, refer to Cup
 holders [119](#)
 Driver's seat, calibrating [50](#)
 Driving lamps, refer to Parking
 lamps/low beams [102](#)
 Driving on poor roads [135](#)
 Driving stability control
 systems [88](#)
 Driving through water [132](#)
 Driving tips, refer to General
 driving notes [130](#)
 Dry air, refer to Cooling
 function [110](#)
 Drying the air, refer to Cooling
 function [110](#)
 DSC Dynamic Stability
 Control [88](#)
 – indicator lamp [13](#), [89](#)
 DSC OFF, refer to Dynamic
 Stability Control [88](#)
 DTC Dynamic Traction
 Control [89](#)
 – activating [89](#)
 – indicator lamp [89](#)
 DVD
 – country codes [173](#)
 – settings [174](#)
 – video playback [173](#)
 DVD changer, refer to CD
 changer [171](#)
 DVD menu [174](#)
 DVD player, refer to CD
 player [171](#)

DVD system in rear [187](#)
 – CD/DVD player [188](#)
 – connecting headphones [188](#)
 – controls [187](#)
 – displaying images from CD/
 DVD [195](#)
 – DVD country codes [190](#)
 – external device [198](#)
 – information on CD/DVD
 player [196](#)
 – playing audio tracks from
 CD/DVD [193](#)
 – playing video from CD/
 DVD [190](#)
 – remote control [188](#)
 – switching on/off [189](#)
 DVD video [173](#)
 Dynamic Performance
 Control [90](#)
 Dynamic Stability Control
 DSC [88](#)
 Dynamic Traction, refer to
 Dynamic Traction
 Control [89](#)
 Dynamic Traction Control
 DTC [89](#)

E

Easy entry/exit [54](#)
 Eject button, refer to Buttons
 on the CD/DVD player [160](#)
 Electrical malfunction
 – automatic transmission with
 Steptronic [66](#)
 – door lock [29](#)
 – driver's door [29](#)
 – fuel filler door [224](#)
 – glass sunroof, electric [42](#)
 – liftgate [31](#)
 – panorama glass sunroof [40](#)
 – parking brake [63](#)
 Electric seat [44](#)
 Electronic brake-force
 distribution [88](#)
 Electronic oil level check [241](#)

- Emergency operation, refer to
 - Manual operation
 - door lock [29](#)
 - driver's door [29](#)
 - fuel filler door [224](#)
 - liftgate [31](#)
 - transmission lock, automatic transmission [66](#)
 - Emergency request [261](#)
 - Emergency services, refer to
 - Roadside Assistance [262](#)
 - Engine
 - breaking-in [130](#)
 - data [268](#)
 - oil temperature [72](#)
 - overheated, refer to Coolant temperature [72](#)
 - speed [268](#)
 - starting [60](#)
 - starting, with comfort access [36](#)
 - switching off [60](#)
 - Engine compartment [240](#)
 - Engine coolant [243](#)
 - Engine oil
 - adding [242](#)
 - additives, refer to Approved engine oils [243](#)
 - approved engine oil [243](#)
 - checking oil level [241](#)
 - electronic oil level check [241](#)
 - temperature [72](#)
 - Engine oil temperature [72](#)
 - Engine output, refer to Engine data [268](#)
 - Engine overheating, refer to
 - Coolant temperature [72](#)
 - Engine speed [268](#)
 - Engine starting, refer to
 - Starting engine [60](#)
 - Entering special destinations by name [145](#)
 - Entertainment sound output on/off [160](#)
 - Entry map for destination [146](#)
 - Equalizer, tone setting [161](#)
 - ESP Electronic Stability Program, refer to DSC Dynamic Stability Control [88](#)
 - Event Data Recorders [245](#)
 - Exhaust system, refer to Hot exhaust system [131](#)
 - Extended connectivity of the music player in the mobile phone [183](#)
 - Exterior mirrors [52](#)
 - adjusting [52](#)
 - automatic dimming feature [53](#)
 - automatic heating [52](#)
 - folding in and out [52](#)
 - tilting down passenger-side exterior mirror [53](#)
 - External audio device [119](#)
 - Eye for tow-starting and towing, refer to Tow fitting [263](#)
- ## F
- Failure messages, refer to
 - Check Control [77](#)
 - False alarm, refer to Avoiding unintentional alarms [35](#)
 - Fastening safety belts, refer to
 - Safety belts [49](#)
 - warning lamp [50](#)
 - Fastest route for navigation [150](#)
 - Fast forward
 - CD changer [173](#)
 - CD player [173](#)
 - Fault displays, refer to Check Control [77](#)
 - Filler neck for washer fluid [69](#)
 - First aid, refer to First-aid kit [262](#)
 - First-aid kit [262](#)
 - Fixing system, adaptive [124](#)
 - Flashing during locking/unlocking, refer to Setting confirmation signals [28](#)
 - Flat tire
 - changing wheels [256](#)
 - compact wheel [256](#)
 - Flat Tire Monitor [92](#)
 - run-flat tires [93](#), [95](#), [237](#)
 - TPM Tire Pressure Monitor [94](#)
 - Flat Tire Monitor FTM [92](#)
 - Fluid reservoir, refer to Filler neck for washer fluid [69](#)
 - FM, waveband [163](#)
 - Fog lamps [105](#)
 - indicator lamp [13](#), [105](#)
 - Folding display screen open/closed, DVD system in rear [187](#)
 - Folding rear seat backrest [124](#)
 - Footbrake, refer to Braking safely [132](#)
 - Footwell lamps [106](#)
 - For your own safety [5](#)
 - 4-wheel drive system, refer to xDrive [90](#)
 - Free memory capacity, music collection [181](#)
 - Front airbags [98](#)
 - Front passenger airbags [98](#)
 - deactivating [98](#)
 - refer to Exception of front passenger seat [55](#)
 - Front seat adjustment [44](#)
 - FTM Flat Tire Monitor [92](#)
 - false alarms [92](#)
 - indicating a flat tire [93](#)
 - initializing the system [93](#)
 - snow chains [238](#)
 - system limits [92](#)
 - warning lamp [93](#)
 - Fuel [225](#)
 - capacity [272](#)
 - display [73](#)
 - high-quality brands [225](#)
 - quality [225](#)
 - saving [130](#)
 - specifications [225](#)
 - Fuel clock, refer to Fuel gauge [73](#)

Fuel consumption display, computer, average fuel consumption [73](#)
Fuel display, refer to Fuel gauge [73](#)
Fuel filler door [224](#)
– closing [224](#)
– opening [224](#)
– releasing manually [224](#)
Fuses [259](#)

G

Garage door opener, refer to Integrated universal remote control [115](#)
Gasoline, refer to Required fuel [225](#)
Gasoline display, refer to Fuel gauge [73](#)
Gearshifts, automatic transmission with Steptronic [65](#)
General driving notes [130](#), [131](#)
Glass sunroof
– convenience operation from outside [29](#)
– convenience operation with comfort access [36](#)
– remote control [28](#)
Glass sunroof, electric [40](#)
– moving manually [42](#)
– opening, closing [41](#)
– power interruption [42](#)
– raising [41](#)
Glove compartment [118](#)
– lighting [118](#)
GPS navigation, refer to Navigation system [140](#)
Grills, refer to Ventilation [111](#)
Grills of the automatic climate control [107](#)
Gross vehicle weight, refer to Weights [271](#)
Guided Tours [149](#)

H

Handbrake, refer to Parking brake [61](#)
– Automatic Hold [61](#)
Hands-free system, refer to Microphone [14](#)
Hand washing [247](#)
Having diesel exhaust fluid refilled [226](#)
Hazard warning flashers [15](#)
HDC Hill Descent Control [90](#)
HD Radio [164](#)
Head airbags [98](#)
Headlamp control, automatic [102](#)
Headlamp flasher [67](#)
Headlamps [102](#)
– cleaning, refer to Washer/wiper system [67](#)
– replacing bulbs [250](#)
Head Light, refer to Adaptive Head Light [103](#)
Head restraints [46](#)
– sitting safely [43](#)
Head-Up Display [100](#)
Heated
– mirrors [52](#)
– rear window [109](#)
– seats [50](#), [51](#)
– steering wheel [54](#)
Heating [107](#)
– exterior mirrors [52](#)
– interior [107](#)
– rear window [109](#)
– residual heat [110](#)
– seats [50](#), [51](#)
– steering wheel [54](#)
Heating with engine switched off, refer to Residual heat [110](#)
Heavy cargo, refer to Securing cargo [134](#)
Height
– on Head-Up Display [100](#)
– refer to Dimensions [269](#)
Height adjustment
– seats [44](#)
– steering wheel [53](#)

High-beam assistant [104](#)
High beams [67](#), [104](#)
– automatically switching on and off, refer to High-beam assistant [104](#)
– headlamp flasher [67](#)
– indicator lamp [13](#)
High-pressure cleaning jets [247](#)
High water, refer to Driving through water [132](#)
Highway, refer to Route criteria [150](#)
Hill Descent Control HDC [90](#)
Hills [132](#)
Holder for cups [119](#)
Homepage [4](#)
Hood [239](#)
Horn [10](#)
Hot exhaust system [131](#)
Hydraulic brake assistant, refer to Brake assistant [88](#)
Hydroplaning [132](#)

I

IBOC, refer to HD Radio [164](#)
Ice, refer to Outside temperature warning [71](#)
Ice warning, refer to Outside temperature warning [71](#)
Identification, tire [238](#)
Identification mark, run-flat tires [237](#)
iDrive [16](#)
– changing language [81](#)
– changing settings [79](#)
– changing units of measure and display type [80](#)
– controller [16](#)
– controls [16](#)
– main menu [17](#)
– setting brightness [80](#)
– setting date [80](#)
– setting time [79](#)
– status information [19](#)
Ignition [59](#)
– switched off [59](#)
– switched on [59](#)

Ignition key, refer to Keys/
remote control [26](#)

Ignition key position 1, refer to
Radio readiness [59](#)

Ignition key position 2, refer to
Ignition on [59](#)

Ignition lock [59](#)

- starting engine with comfort
access [36](#)

Importing special
destinations [146](#)

Importing trips [149](#)

Indicator/warning lamps [13](#)

- active steering [97](#)
- airbags [99](#)
- DSC [13](#), [89](#)
- DTC [89](#)
- fasten safety belt [50](#)
- Flat Tire Monitor [93](#)
- fog lamps [13](#)
- TPM Tire Pressure
Monitor [95](#)

Individual settings, refer to
Personal Profile [26](#)

Inflation pressure, refer to Tire
inflation pressure [229](#)

Inflation pressure monitoring

- refer to FTM Flat Tire
Monitor [92](#)
- refer to TPM Tire Pressure
Monitor [94](#)

Initializing

- Flat Tire Monitor [93](#)
- radio, refer to Station,
storing [164](#)
- refer to Power failure [259](#)
- refer to Setting date [80](#)
- refer to Setting time [79](#)
- seat, mirror and steering
wheel memory [45](#)

Installation location, mobile
phone [119](#)

Instructions for navigation
system, refer to Voice
instructions [152](#)

Instrument cluster

- refer to Cockpit [10](#)
- refer to Instrument panel [12](#)

Instrument illumination, refer
to Instrument lighting [105](#)

Instrument lighting [105](#)

Instrument panel [12](#)

- refer to Cockpit [10](#)

Integrated key [26](#)

Integrated universal remote
control [115](#)

Interactive map [147](#)

Interior lamps [106](#)

- switching on with remote
control [28](#)

Interior motion sensor [35](#)

- switching off [35](#)

Interior rearview mirror [53](#)

- automatic dimming
feature [53](#)
- compass [116](#)

Intermittent mode of the
wipers [68](#)

Intersection, entering,
navigation [142](#)

iPod, connecting, refer to
AUX-IN connection [183](#)

iPod, connecting, refer to
USB-audio interface [183](#)

J

Jacking points [257](#)

Joystick

- refer to iDrive [16](#)
- refer to Selector lever,
selecting transmission
positions [64](#)

Jump starting [262](#)

K

Keyless-Go, refer to Comfort
access [35](#)

Keyless opening and closing,
refer to Comfort access [35](#)

Key Memory, refer to Personal
Profile [26](#)

Keys [26](#)

- key-related settings, refer to
Personal Profile [26](#)

Kick-down, automatic
transmission with
Steptronic [65](#)

Knock control [225](#)

L

Lamps

- refer to High-beam
assistant [104](#)
- refer to Parking lamps/low
beams [102](#)

Lamps and bulbs [250](#)

Lashing eyes, refer to
Securing cargo [134](#)

Last destinations [144](#)

LATCH child restraint fixing
system [56](#)

Leather care [248](#)

LEDs light-emitting
diodes [251](#)

Length, refer to
Dimensions [269](#)

License plate lamp, replacing
bulbs [253](#), [256](#)

Liftgate [30](#), [33](#)

- adjusting opening
height [31](#), [33](#)
- automatic operation [31](#)
- closing [31](#), [34](#)
- locking and unlocking from
inside [30](#)
- manually opening or
closing [34](#)
- opening from inside [31](#)
- opening from outside [31](#)
- opening manually [31](#)

Light-emitting diodes
LEDs [251](#)

Lighter [121](#)

Lighter socket [121](#)

Lighting

- instruments [105](#)
- lamps and bulbs [250](#)
- of the vehicle, refer to
Lamps [102](#)

Light switch [102](#)

Load [133](#)

Loading [133](#)
 – securing cargo [134](#)
 – stowing cargo [134](#)
 – vehicle [133](#)
 Load securing equipment,
 refer to Securing cargo [134](#)
 Lock buttons in the doors,
 refer to Locking [30](#)
 Locking
 – from inside [30](#)
 – setting confirmation
 signals [28](#)
 – using remote control [27](#)
 – without key, refer to Comfort
 access [35](#)
 Locking and unlocking doors
 – from inside [30](#)
 – setting confirmation
 signals [28](#)
 Locking without key, refer to
 Comfort access [35](#)
 Low beams [102](#)
 – automatic [102](#)
 Lower back support, refer to
 Lumbar support [45](#)
 Low-sulfur diesel [225](#)
 Lug bolts [257](#)
 – tightening torque, refer to
 After mounting [258](#)
 – wrench [257](#)
 Luggage compartment
 capacity, refer to Cargo bay
 capacity [271](#)
 Luggage rack, refer to Roof-
 mounted luggage rack [135](#)
 Lumbar support [45](#)
 LW, waveband [163](#)

M

M+S tires, refer to Winter
 tires [238](#)
 Main menu, iDrive [17](#)

Maintenance
 – refer to Service and
 Warranty Information
 Booklet for US models [244](#)
 – refer to Service
 requirements [74](#)
 – refer to Warranty and
 Service Guide Booklet for
 Canadian models [244](#)
 Maintenance system [244](#)
 Malfunction
 – door lock [29](#)
 – driver's door [29](#)
 – fuel filler door [224](#)
 – glass sunroof, electric [42](#)
 – liftgate [31](#)
 – panorama glass sunroof [40](#)
 – parking brake [63](#)
 Malfunction warnings, refer to
 Check Control [77](#)
 Manual air distribution [110](#)
 Manually releasing
 transmission lock [66](#)
 Manual mode, automatic
 transmission with
 Steptronic [65](#)
 Manual operation
 – door lock [29](#)
 – driver's door [29](#)
 – fuel filler door [224](#)
 – transmission lock, automatic
 transmission [66](#)
 Map display [152](#)
 Map for navigation
 – changing scale [153](#)
 – entering destination [146](#)
 Master key, refer to Keys/
 remote control [26](#)
 Maximum cooling [110](#)
 Maximum speed
 – for winter tires [238](#)
 – with compact wheel [258](#)
 Memory, refer to Seat, mirror
 and steering wheel
 memory [45](#)
 Menus, refer to iDrive [16](#)
 Messages [208](#)
 Microfilter [112](#)

Microphone
 – for mobile phone [14](#)
 – for telephone [14](#)
 – for voice activation
 system [14](#)
 Mirror dimming feature [53](#)
 Mirrors [52](#)
 – automatic curb monitor [53](#)
 – exterior mirrors [52](#)
 – folding in and out [52](#)
 – heating [52](#)
 – interior rearview mirror [53](#)
 – memory, refer to Seat, mirror
 and steering wheel
 memory [45](#)
 Mobile phone
 – adjusting volume [205](#)
 – connecting, refer to Mobile
 phone, pairing [202](#)
 – installation location, refer to
 Center armrest, front [119](#)
 – operation via iDrive [205](#)
 – pairing [202](#)
 – refer to separate operating
 instructions
 – refer to Telephone [202](#)
 Monitor, refer to iDrive [16](#)
 Monitoring tire pressure, refer
 to FTM Flat Tire Monitor [92](#)
 MP3 player, connecting
 – refer to AUX-IN
 connection [183](#)
 – refer to USB-audio
 interface [183](#)
 Multifunction steering wheel,
 refer to Buttons on steering
 wheel [11](#)
 Multifunction switch
 – refer to Turn signals/
 headlamp flasher/high
 beams [67](#)
 – refer to Washer/wiper
 system [67](#)
 Music
 – managing [181](#)
 – playing [179](#)
 – storing [178](#)
 Music collection [178](#)
 – backup [181](#)

Music player
 – connecting, refer to USB-
 audio interface **183**
 Music player, connecting
 – refer to AUX-IN
 connection **183**
 Music search **179**
 My Info **208**

N

Navigation data **140**
 Navigation destination
 – entering manually **141**
 – home address **144**
 Navigation instructions, refer
 to Switching voice
 instructions on/off **152**
 Navigation system **140**
 – address book **143**
 – bypassing a route
 section **151**
 – continuing destination
 guidance **150**
 – destination entry **141**
 – entering a destination by
 voice **147**
 – entering a destination
 manually **141**
 – questions about system **157**
 – route list **151**
 – selecting destination via
 map **146**
 – selecting route criteria **150**
 – special destinations **144**
 – starting destination
 guidance **150**
 – terminating destination
 guidance **150**
 – trip planner **148**
 – voice instructions **152**
 – volume adjustment **152**
 Neck support, refer to Head
 restraints **46**
 New remote control **26**
 New wheels and tires **237**
 North-facing map **152**

Nozzles, refer to Windshield
 washer nozzles **68**
 Nylon rope, refer to Tow-
 starting and towing **263**

O

OBD socket **245**
 Octane ratings, refer to Fuel
 specifications **225**
 Odometer **71**
 Oil
 – additives, refer to Approved
 engine oils **243**
 – approved engine oils **243**
 – consumption, refer to
 Checking engine oil
 level **241**
 – level **241**
 – refilling, refer to Adding
 engine oil **242**
 Oil change interval, refer to
 Service requirements **74**
 Onboard computer, refer to
 iDrive **16**
 Onboard toolkit **250**
 Opening and closing
 – comfort access **35**
 – from inside **30**
 – panorama glass sunroof **39**
 – using remote control **27**
 – using the door lock **29**
 Opening liftgate **33**
 Operation on poor roads **135**
 Options, selecting for
 navigation **150**
 Orientation menu, refer to
 Main menu **17**
 Output, refer to Engine
 data **268**
 Outside air, refer to AUC
 Automatic recirculated-air
 control **110**
 Outside temperature
 display **71**
 – changing unit of measure **80**
 Outside temperature
 warning **71**
 Overview, radio control **160**

P

Panic mode **28**
 Panorama glass sunroof **38**
 – moving manually **40**
 – power failure **40**
 – raising, opening, closing **39**
 Park Distance Control PDC **82**
 Parked-car ventilation **114**
 – preselecting activation
 times **114**
 – switching on and off
 directly **114**
 Parking, vehicle **60**
 Parking aid
 – refer to PDC Park Distance
 Control **82**
 – refer to Rear view camera **86**
 Parking assistance
 – refer to PDC Park Distance
 Control **82**
 – refer to Top View **84**
 Parking brake **61**
 – Automatic Hold **61**
 – indicator lamp **13**
 – releasing manually **61**
 – releasing manually in case of
 an electrical malfunction **63**
 – setting manually **61**
 Parking lamps **102**
 Parking with Automatic
 Hold **62**
 Particulate filter, refer to
 Diesel particulate filter **131**
 Parts and accessories **5**
 Passenger-side exterior
 mirror, tilting down **53**
 Pathway lighting **103**
 Paying attention to speed **238**
 PDC Park Distance Control **82**
 Personal Profile **26**
 Phone book **205**
 Phone numbers, dialing **206**
 Pinch protection system
 – glass sunroof, electric **41**
 – panorama glass sunroof **39**
 – power windows **38**
 Plasters, refer to First-aid
 kit **262**

Playing videos, DVD system in rear [190](#)
 Plug-in unit for remote control, refer to Ignition lock [59](#)
 Postal code, entering for navigation [142](#)
 Power failure [259](#)
 Power steering-wheel adjustment [54](#)
 Power windows, refer to Windows [37](#)
 Preglowing, refer to Diesel engine [60](#)
 Preselecting activation times of parked-car ventilation [114](#)
 Pressure, tires [229](#)
 Pressure monitoring of tires, refer to TPM Tire Pressure Monitor [94](#)
 Protective function, refer to Pinch protection system
 – glass sunroof, electric [41](#)
 – panorama glass sunroof [39](#)
 – windows [38](#)

R

Radio
 – controls [160](#)
 – HD Radio [164](#)
 – satellite radio [166](#)
 – selecting waveband [163](#)
 – storing stations [164](#)
 – switching on/off [160](#)
 – tone control [160](#)
 – volume [160](#)
 – Weather band, refer to Weather reports [165](#)
 Radio key, refer to Keys/remote control [26](#)
 Radio position, refer to Radio readiness [59](#)
 Radio readiness [59](#)
 – switched off [59](#)
 – switched on [59](#)
 – with comfort access [36](#)

Rain sensor [68](#)
 Reading lamps [106](#)
 Rear automatic climate control
 – air flow [113](#)
 – switching off [113](#)
 Rear entertainment, refer to DVD system in rear [187](#)
 Rear fog lamps, indicator lamp [13](#)
 Rear lamps, refer to Tail lamps [251, 254](#)
 – replacing bulbs [251, 254](#)
 Rear seat backrest, folding [124](#)
 Rear seats
 – adjusting [48](#)
 – adjusting head restraints [48](#)
 – folding over backrest [124](#)
 – head restraint adjustment [48](#)
 – heating [51](#)
 Rear socket [121](#)
 Rear ventilation [111](#)
 – automatic climate control in rear [112](#)
 – 3rd row seats [112](#)
 Rear view camera [86](#)
 – cleaning [88](#)
 – displays on Control Display [87](#)
 – driver assistance functions [86](#)
 – switching off [86](#)
 – switching on [86](#)
 Rearview mirror [52](#)
 Rear window
 – heating [109](#)
 – replacing wiper blade [250](#)
 – windshield wiper [68, 246](#)
 Rear window safety switch [38](#)
 Rear window wiper, replacing wiper blade [250](#)
 Reception
 – quality [164](#)
 – radio station [164](#)
 Reception level of mobile phone, refer to Status information [19](#)

Recirculated-air mode [110](#)
 – air recirculation [110](#)
 – AUC Automatic recirculated-air control [110](#)
 Reclining seat, refer to Seats [44](#)
 Reflectors, refer to Tail lamps [251, 254](#)
 Refueling [224](#)
 Releasing
 – hood [239](#)
 – refer to Unlocking [36](#)
 Remaining distance, refer to Cruising range [73](#)
 Remaining distance to destination, refer to Computer [74](#)
 Remote control [26](#)
 – comfort access [35](#)
 – garage door opener [115](#)
 – liftgate [28](#)
 – malfunction [29, 37](#)
 – replacing battery [37](#)
 Remote control, DVD system in rear [188](#)
 – battery replacement [189](#)
 Removing condensation on the windows [109](#)
 Replacement fuses [259](#)
 Replacement of tires [237](#)
 – changing wheels [256](#)
 – new wheels and tires [237](#)
 Replacing bulbs, refer to Lamps and bulbs [250](#)
 Replacing wheels/tires, refer to New wheels and tires [237](#)
 Replacing wiper blades [250](#)
 Reporting an accident, refer to Initiating an emergency request [261](#)
 Reporting safety defects [7](#)
 Reserve warning, refer to Fuel gauge [73](#)
 Reset, refer to Resetting tone settings [162](#)
 Residual heat [110](#)

- Restraint systems
 - for children [55](#)
 - refer to Safety belts [49](#)
 - Retreaded tires [237](#)
 - Reverse
 - CD changer [173](#)
 - CD player [173](#)
 - Reverse gear, automatic transmission with
 - Steptronic [65](#)
 - Road map [152](#)
 - Roadside Assistance [262](#)
 - Roadside assistance [216](#)
 - Roadside parking lamps [104](#)
 - Roller blinds, refer to Roller sun blinds [118](#)
 - Roller sun blinds [118](#)
 - Roll-up cover [122](#)
 - roll-up cover [122](#)
 - Roof load capacity [271](#)
 - Roof-mounted luggage rack [135](#)
 - Rope, refer to Tow-starting and towing [263](#)
 - Rotary pushbutton, refer to iDrive [16](#)
 - Route [150](#), [151](#)
 - bypassing sections [151](#)
 - changing [150](#), [151](#)
 - changing criteria [150](#)
 - displaying map view [152](#)
 - displaying streets or towns/cities [151](#)
 - selecting [150](#)
 - Route instructions, refer to Destination guidance through voice instructions [152](#)
 - Route map, refer to Map display [152](#)
 - Route section, changing [151](#)
 - Route selection [150](#)
 - RSC Runflat System
 - Component, refer to Run-flat tires [237](#)
 - Runflat System Component
 - RSC, refer to Run-Flat Tires [237](#)
 - Run-flat tires [237](#)
 - continuing driving with a damaged tire [93](#), [95](#)
 - flat tire [93](#), [95](#)
 - new wheels and tires [237](#)
 - tire inflation pressure [93](#), [95](#), [229](#)
 - tire replacement [237](#)
- ## S
- Safety [5](#)
 - Safety belts [49](#)
 - damage [50](#)
 - sitting safely [43](#)
 - warning lamp [50](#)
 - Safety belt tensioners
 - refer to Airbags [98](#)
 - refer to Safety belts [49](#)
 - Safety systems
 - ABS Antilock Brake System [88](#)
 - airbags [98](#)
 - driving stability control systems [88](#)
 - DSC Dynamic Stability Control [88](#)
 - safety belts [49](#)
 - Safety tires, refer to Run-flat tires [237](#)
 - Satellite radio [166](#)
 - Screen, refer to iDrive [16](#)
 - Screw thread for tow fitting [263](#)
 - SDARS, refer to Satellite radio [166](#)
 - Seat heating [50](#), [51](#)
 - Seats [44](#)
 - adjusting [44](#)
 - adjusting electrically [44](#)
 - adjusting manually [44](#)
 - backrest width [45](#)
 - heating [50](#), [51](#)
 - in rear [48](#)
 - lumbar support [45](#)
 - memory, refer to Seat, mirror and steering wheel memory [45](#)
 - 2nd row seats [48](#)
 - shoulder support [45](#)
 - sitting safely [43](#)
 - storing the setting [45](#)
 - thigh support [44](#), [45](#)
 - 3rd row seats [49](#)
 - ventilation, refer to Active seat ventilation and Seat heating [51](#)
 - 2nd row seats [48](#)
 - Securing load
 - refer to Securing cargo [134](#)
 - with ski bag, refer to Securing cargo [126](#)
 - Selecting new scale for navigation [153](#)
 - Selector lever, automatic transmission with
 - Steptronic [64](#)
 - Selector lever lock, refer to Reverse gear [65](#)
 - Self-leveling suspension [92](#)
 - Service, refer to Roadside Assistance [262](#)
 - Service and Warranty Information Booklet for US models [244](#)
 - Service interval indicator, refer to Service requirements [74](#)
 - Service Request [219](#)
 - Service requirements [74](#)
 - also refer to CBS Condition Based Service [244](#)
 - Service status [220](#)

Settings
– changing on Control Display 79
– clock, 12h/24h mode 80
– configuring, refer to Personal Profile 26
– DVD 174
– language 81
Settings for the map display 153
Setting speed limit 78
Setting time, refer to Preselecting activation times 114
Shifting, automatic transmission with Steptronic 65
Shift paddles 65
Short commands of voice activation system 273
Short route in navigation, refer to Selecting route 150
Shoulder support 45
Shuffled, refer to Random
– CD changer 172
– CD player 172
Side airbags 98
Side marker lamps, replacing bulbs 251
Signal horn, refer to Horn 10
Sitting safely 43
– with airbags 43
– with head restraint 43
– with safety belts 43
Ski bag 125
Slide show, refer to Displaying images 195
Sliding/tilt sunroof
– refer to Glass sunroof, electric 40
– refer to Panorama glass sunroof 38
Slope assistant, refer to Starting assistant 92
Smokers' package, refer to Ashtray 120
SMS 208

Snap-in adapter
– inserting/removing 212
– use 202
Snow chains 238
Socket for Onboard Diagnostics interface 245
Socket for remote control, refer to Ignition lock 59
Sockets, refer to Connecting electrical devices 121
Soft closure aid, refer to Automatic soft closing 30
Soot particle filter, refer to Diesel particulate filter 131
SOS, refer to Initiating an emergency request 261
Spare fuses 259
Spare remote control 26
Spare wheel
– refer to Changing wheels 256
– refer to Compact wheel 256
Special destinations 144
Special oils, refer to Approved engine oils 243
Specified oil grades, refer to Approved engine oils 243
Speed
– with compact wheel 258
– with winter tires 238
Speed limit warning, refer to Speed limit 78
Speedometer 12
Speed Volume 161
Split screen, refer to Control Display, switching on/off 19
Split screen content, refer to Display for split screen content, selecting 19
Sport program, automatic transmission with Steptronic 65
Stability control, refer to Driving stability control systems 88
Start/Stop button 59
Starting, refer to Starting engine 60

Starting assistance, refer to Jump starting 262
Starting assistant 92
Starting difficulties, jump starting 262
Starting off on slopes, refer to Starting assistant 92
State/province, for navigation 141
Station selection, radio 163
Status of this Owner's Manual at time of printing 5
Steam cleaners 247
Steering wheel
– adjusting 53
– automatic adjustment, refer to Steering wheel memory 45
– buttons on steering wheel 11
– easy entry/exit 54
– heating 54
– memory 45
Steering with variable ratio, refer to Active steering 96
Steptronic, refer to Sport program and manual mode M/S 65
Storage compartments 119
Storing a trip 148
Storing sitting position, refer to Seat, mirror and steering wheel memory 45
Storing tires 238
Storing vehicle 249
Storing your vehicle 249
Street, entering, navigation 142
Summer tires, refer to Wheels and tires 229
SVCD 173
SW, waveband 163
Switches, refer to Cockpit 10
Switching cooling function on and off 110
Switching off engine 60

Switching on

- audio [160](#)
- CD changer [160](#)
- CD player [160](#)
- radio [160](#)

Swiveling headlamps, refer to

Adaptive Head Light [103](#)

Symbols [4](#)

- indicator/warning lamps [13](#)
- status information [19](#)
- traffic information with navigation system [153](#)

T

Tachometer [72](#)

Tailgate [33](#)

Tail lamps [251](#), [254](#)

- replacing bulbs [251](#), [254](#)

Tank contents, refer to

Capacities [272](#)

Target cursor for navigation [146](#)

Technical alterations, refer to

For your own safety [5](#)

Technical data [268](#)

Telephone [202](#)

- refer to separate operating instructions

Teleservice Diagnosis [217](#)

Teleservice Help [217](#)

TeleServices, activating [218](#)

Temperature

- adjusting with automatic climate control [109](#), [113](#)
- changing units of measure [80](#)
- refer to Coolant temperature [72](#)

Temperature display

- outside temperature [71](#)
- setting units [80](#)
- temperature warning [71](#)
- temperature warning [71](#)

Tempomat, refer to Cruise control [69](#)

The individual vehicle [5](#)

Third brake lamp, refer to

Center brake lamp [253](#), [256](#)

3rd row seats [49](#)

Tightening torque of the lug bolts, refer to After mounting [258](#)

Tilt alarm sensor, switching off [35](#)

Tilting down passenger-side exterior mirror [53](#)

Timer, refer to Preselecting activation times [114](#)

Tire inflation pressure monitoring, refer to Flat Tire Monitor [92](#)

Tire inflation pressures [229](#)

- checking [229](#)

Tire Pressure Monitor

TPM [94](#)

Tire Quality Grading [235](#)

Tires

- age [235](#)
- air loss [93](#), [95](#)
- breaking-in [130](#)
- changing [237](#)
- condition [236](#)
- damage [236](#)
- flat tire, refer to Changing wheels [256](#)
- inflation pressure [229](#)
- inflation pressure monitoring, refer to FTM Flat Tire Monitor [92](#)
- new wheels and tires [237](#)
- pressure loss [93](#), [95](#)
- pressure monitoring, refer to TPM Tire Pressure Monitor [94](#)
- replacing [256](#)
- retreaded tires [237](#)
- run-flat tires [237](#)
- size [235](#)
- tread [236](#)
- wear indicators [236](#)
- wheel/tire combination [237](#)
- winter tires [238](#)

TMC station, refer to Traffic information [153](#)

Tone

- control [160](#)
- middle setting [162](#)

Tone on locking/unlocking [28](#)

Tools, refer to Onboard toolkit [250](#)

Top 50 of music collection [180](#)

Top View [84](#)

Torque

- engine [268](#)
- lug bolts, refer to After mounting [258](#)

Tow fitting [263](#)

Towing [263](#)

Town/city, for navigation [141](#)

Tow-starting [263](#), [264](#)

TPM Tire Pressure Monitor [94](#)

- resetting system [94](#)

- system limits [94](#)

- warning lamp [95](#)

Track, selecting on CD [172](#)

TRACTION, refer to DTC [89](#)

Traction-assist feature, refer to DSC Dynamic Stability Control [88](#)

Traction control, refer to DSC Dynamic Stability Control [88](#)

Traffic bulletins

- categories [155](#)
- filtering [155](#)

Traffic bulletins for navigation [153](#)

- in map display [155](#)

Traffic congestion

- displaying traffic information [153](#)
- refer to Route, bypassing sections [151](#)

Traffic information for navigation during destination guidance [155](#)

Transmission

- automatic transmission with Steptronic [64](#)
- manually releasing transmission lock on automatic transmission with Steptronic [66](#)

Transmission positions, refer to Automatic transmission with Steptronic [64](#)
Transporting children safely [55](#)
Transport securing device, refer to Securing cargo [134](#)
Tread depth, refer to Minimum tread depth [236](#)
Trip-distance counter, refer to Trip odometer [71](#)
Trip odometer [71](#)
Turning circle, refer to Dimensions [269](#)
Turn signals [67](#)
– indicator lamp [12](#)
– replacing bulbs [251](#), [254](#)

U

Uniform Tire Quality Grading/UTQR [235](#)
Units
– average fuel consumption [80](#)
– temperature [80](#)
Universal garage-door opener, refer to Integrated universal remote control [115](#)
Universal remote control [115](#)
Unlocking
– from inside [30](#)
– liftgate [28](#)
– setting behavior [28](#)
– using remote control [27](#)
– without key, refer to Comfort access [35](#)
Unlocking and locking doors using remote control [27](#)
Unlocking without key, refer to Comfort access [35](#)
Updating the navigation data [140](#)
USB audio interface [183](#)
Used batteries
– refer to Disposal [258](#)
– refer to Replacing battery [37](#)

V

Valve screw caps, refer to After mounting [258](#)
VCD [173](#)
Vehicle
– battery [258](#)
– breaking-in [130](#)
– loading [133](#)
– measurements, refer to Dimensions [269](#)
– parking [60](#)
– storing [249](#)
– weights [271](#)
Vehicle care, refer to Care [246](#)
Vehicle jack [257](#)
– jacking points [257](#)
Ventilation [111](#)
– draft-free [111](#)
– in the rear [111](#)
– rear automatic climate control [113](#)
– 3rd row seats [112](#)
– while stationary [114](#)
Vent outlets of automatic climate control [107](#)
Vents, refer to Ventilation [111](#)
Video menu [174](#)
Video playback [173](#)
Voice, refer to Destination guidance through voice instructions [152](#)
Voice activation system [22](#)
– short commands [273](#)
Voice instructions for navigation system [152](#)
– repeating [152](#)
– switching on/off [152](#)
– volume [152](#)
Volume [160](#)
– audio sources [160](#)
– mobile phone [205](#)
– voice instructions [152](#)
Volume balance, tone setting [161](#)
Volume of warning tones [81](#)

W

Warning lamps, refer to Indicator and warning lamps [13](#)
Warning messages, refer to Check Control [77](#)
Warning tone, volume [81](#)
Warning triangle [261](#)
Warranty and Service Guide Booklet for Canadian models [244](#)
Washer/wiper system [67](#)
– rain sensor [68](#)
– washer fluid [69](#)
– windshield washer nozzles [68](#)
Washer fluid [69](#)
– capacity of the reservoir [69](#)
Water on roads, refer to Driving through water [132](#)
Water penetration [247](#)
Waveband for radio [163](#)
Wear indicators in tires, refer to Minimum tread depth [236](#)
Weather reports [165](#)
Website [4](#)
Weights [271](#)
Wheel/tire combination, refer to New wheels and tires [237](#)
Wheel/tire damage [236](#)
Wheelbase, refer to Dimensions [269](#)
Wheels and tires [229](#)
Width, refer to Dimensions [269](#)
Windows [37](#)
– convenience operation [28](#)
– convenience operation from outside [29](#)
– convenience operation with comfort access [36](#)
– opening, closing [37](#)
– pinch protection system [38](#)
– safety switch [38](#)

Windshield

- cleaning, refer to Washer/wiper system [67](#)
- defrosting, refer to Defrosting windows [109](#)
- displays, refer to Head-Up Display [100](#)

Windshield washer system

- refer to Washer/wiper system [67](#)
- windshield washer nozzles [68](#)

Windshield wipers, refer to Washer/wiper system [67](#)

- replacing wiper blades [250](#)

Winter diesel [225](#)

Winter tires [238](#)

- storage [238](#)

Word matching principle for navigation [149](#)

Working in the engine compartment [239](#)

Wrenches/screwdrivers, refer to Onboard toolkit [250](#)

X

xDrive [90](#)

Xenon lamps [251](#), [253](#)

- bulb changing [251](#), [253](#)

More about BMW

bmwusa.com



The Ultimate
Driving Machine

01 41 2 602 756 ue

