

***FIT***

**HONDA**  
The Power of Dreams

**2019**  
**OWNER'S MANUAL**

## WARNING

### California Proposition 65 Warning

Operating, servicing and maintaining a passenger vehicle or off-highway motor vehicle can expose you to chemicals including engine exhaust, carbon monoxide, phthalates, and lead, which are known to the State of California to cause cancer and birth defects or other reproductive harm. To minimize exposure, avoid breathing exhaust, do not idle the engine except as necessary, service your vehicle in a well-ventilated area and wear gloves or wash your hands frequently when servicing your vehicle. For more information go to [www.P65Warnings.ca.gov/passenger-vehicle](http://www.P65Warnings.ca.gov/passenger-vehicle).

## Event Data Recorders

### **This vehicle is equipped with an event data recorder (EDR).**

The main purpose of an EDR is to record, in certain crash or near crash-like situations, such as an air bag deployment or hitting a road obstacle, data that will assist in understanding how a vehicle's systems performed. **The EDR is designed to record data related to vehicle dynamics and safety systems for a short period of time, typically 30 seconds or less. The EDR in this vehicle is designed to record such data as:**

- **How various systems in your vehicle were operating;**
- **Whether or not the driver and passenger safety belts were buckled/fastened;**

- **How far (if at all) the driver was depressing the accelerator and/or brake pedal; and,**
- **How fast the vehicle was traveling.**

These data can help provide a better understanding of the circumstances in which crashes and injuries occur. NOTE: EDR data are recorded by your vehicle only if a non-trivial crash situation occurs; no data are recorded by the EDR under normal driving conditions and no personal data (e.g., name, gender, age, and crash location) are recorded. However, other parties, such as law enforcement, could combine the EDR data with the type of personally identifying data routinely acquired during a crash investigation.

To read data recorded by an EDR, special equipment is required, and access to the vehicle or the EDR is needed. In addition to the vehicle manufacturer, other parties, such as law enforcement, that have the special equipment, can read the information if they have access to the vehicle or the EDR.

The data belongs to the vehicle owner and may not be accessed by anyone else except as legally required or with the permission of the vehicle owner.

## Service Diagnostic Recorders

This vehicle is equipped with service-related devices that record information about powertrain performance. The data can be used to verify emissions law requirements and/or help technicians diagnose and solve service problems. It may also be combined with data from other sources for research purposes, but it remains confidential. Some diagnostic and maintenance information is uploaded to Honda upon vehicle start up.



## California Perchlorate Contamination Prevention Act

The airbags, seat belt tensioners, and CR type batteries in this vehicle may contain perchlorate materials - special handling may apply. See [www.dtsc.ca.gov/hazardouswaste/perchlorate/](http://www.dtsc.ca.gov/hazardouswaste/perchlorate/)

As you read this manual, you will find information that is preceded by a **NOTICE** symbol. This information is intended to help you avoid damage to your vehicle, other property, or the environment.

## Software End User License Agreement

Your vehicle comes equipped with software, which is governed by the End User License Agreement in Owner's Manual, and which contains a binding arbitration clause. Please refer to the End User License Agreement for the terms and conditions governing your use of the installed software, as well as the applications, services, functions, and content provided through the software. Your use of the installed software will serve as your consent to the terms and conditions of the End User License Agreement. You may opt out within 30 days of your initial use of the Software by sending a signed, written notice to HONDA at American Honda Motor Co., Inc. Honda Automobile Customer Services Mail Stop 100-5E-8A, 1919 Torrance Blvd. Torrance, CA 90501-2746.

## Privacy Notice

This vehicle may share location and usage information. To manage this setting, visit [www.hondalink.com/vehicle-data-choices](http://www.hondalink.com/vehicle-data-choices).

## A Few Words About Safety

---

Your safety, and the safety of others, is very important. And operating this vehicle safely is an important responsibility.

To help you make informed decisions about safety, we have provided operating procedures and other information on labels and in this manual. This information alerts you to potential hazards that could hurt you or others.

Of course, it is not practical or possible to warn you about all the hazards associated with operating or maintaining your vehicle. You must use your own good judgment.

You will find this important safety information in a variety of forms, including:

- **Safety Labels** - on the vehicle.
- **Safety Messages** - preceded by a safety alert symbol  and one of three signal words: **DANGER**, **WARNING**, or **CAUTION**.

These signal words mean:

 **DANGER**

You **WILL** be **KILLED** or **SERIOUSLY HURT** if you don't follow instructions.

 **WARNING**

You **CAN** be **KILLED** or **SERIOUSLY HURT** if you don't follow instructions.

 **CAUTION**

You **CAN** be **HURT** if you don't follow instructions.

- **Safety Headings** - such as Important Safety Precautions.
- **Safety Section** - such as Safe Driving.
- **Instructions** - how to use this vehicle correctly and safely.

This entire book is filled with important safety information - please read it carefully.

This owner's manual should be considered a permanent part of the vehicle and should remain with the vehicle when it is sold.

This owner's manual covers all models of your vehicle. You may find descriptions of equipment and features that are not on your particular model.

Images throughout this owner's manual (including the front cover) represent features and equipment that are available on some, but not all, models. Your particular model may not have some of these features.

This owner's manual is for vehicles sold in the United States and Canada.

The information and specifications included in this publication were in effect at the time of approval for printing. Honda Motor Co., Ltd. reserves the right, however, to discontinue or change specifications or design at any time without notice and without incurring any obligation.

## ➤ Safe Driving P. 31

For Safe Driving P. 32      Seat Belts P. 36      Airbags P. 46

## ➤ Instrument Panel P. 75

Indicators P. 76      Gauges and Displays P. 103

## ➤ Controls P. 121

Clock P. 122      Locking and Unlocking the Doors P. 124  
Opening and Closing the Windows P. 151  
Operating the Switches Around the Steering Wheel P. 154  
Interior Lights/Interior Convenience Items P. 187

## ➤ Features P. 205

Audio System P. 206      Audio System Basic Operation P. 212, 233  
Customized Features P. 321, 328      *Bluetooth*® HandsFreeLink® P. 343, 368

## ➤ Driving P. 399

Before Driving P. 400      Towing a Trailer P. 405  
Multi-View Rear Camera P. 481

## ➤ Maintenance P. 487

Before Performing Maintenance P. 488      Maintenance Minder™ P. 491  
Checking and Maintaining Wiper Blades P. 518  
Heating and Cooling System\*/Climate Control System\* Maintenance P. 536

## ➤ Handling the Unexpected P. 543

Tools P. 544      If a Tire Goes Flat P. 545  
Overheating P. 558      Indicator, Coming On/Blinking P. 560      Fuses P. 564

## ➤ Information P. 573

Specifications P. 574      Identification Numbers P. 576  
Emissions Testing P. 580      Warranty Coverages P. 582

# Contents

Child Safety P. 60

Exhaust Gas Hazard P. 73

Safety Labels P. 74

Opening and Closing the Tailgate P. 145

Opening and Closing the Moonroof\* P. 153

Adjusting the Mirrors P. 174

Heating and Cooling System\* P. 197

Security System P. 148

Adjusting the Seats P. 175

Climate Control System\* P. 200

Audio Error Messages P. 312

General Information on the Audio System P. 317

When Driving P. 409

Refueling P. 483

Braking P. 468

Fuel Economy and CO<sub>2</sub> Emissions P. 486

Parking Your Vehicle P. 480

Maintenance Under the Hood P. 499

Checking and Maintaining Tires P. 522

Cleaning P. 537

Replacing Light Bulbs P. 511

Battery P. 532

Accessories and Modifications P. 542

Remote Transmitter Care P. 534

Engine Does Not Start P. 552

Emergency Towing P. 569

Jump Starting P. 555

When You Cannot Open the Tailgate P. 570

Shift Lever Does Not Move P. 557

Devices that Emit Radio Waves P. 577

Authorized Manuals P. 584

Reporting Safety Defects P. 579

Customer Service Information P. 585

Quick Reference Guide P. 4

Safe Driving P. 31

Instrument Panel P. 75

Controls P. 121

Features P. 205

Driving P. 399

Maintenance P. 487

Handling the Unexpected P. 543

Information P. 573

Index P. 587

# Visual Index

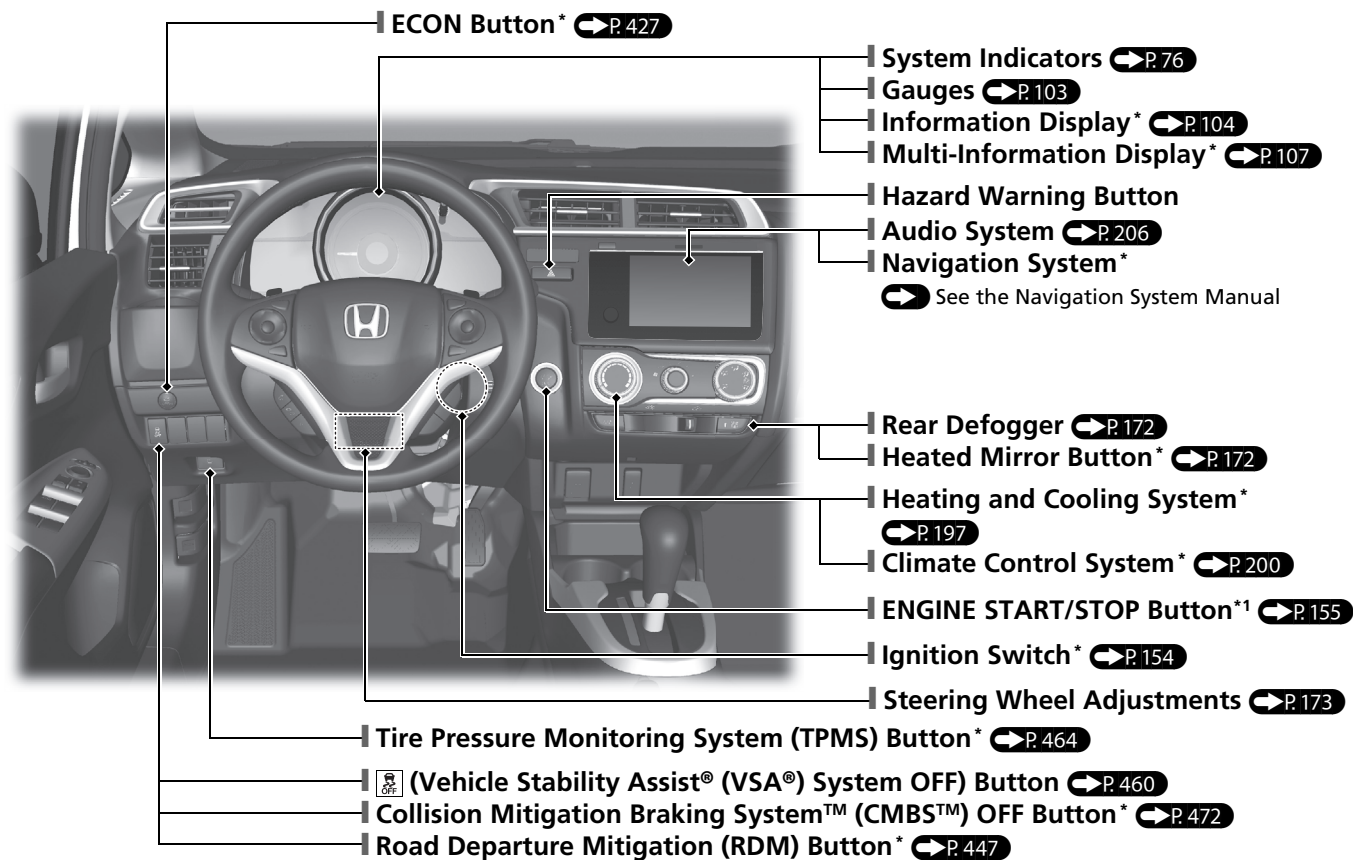

\*1: Models with the smart entry system have an **ENGINE START/STOP** button instead of an ignition switch.

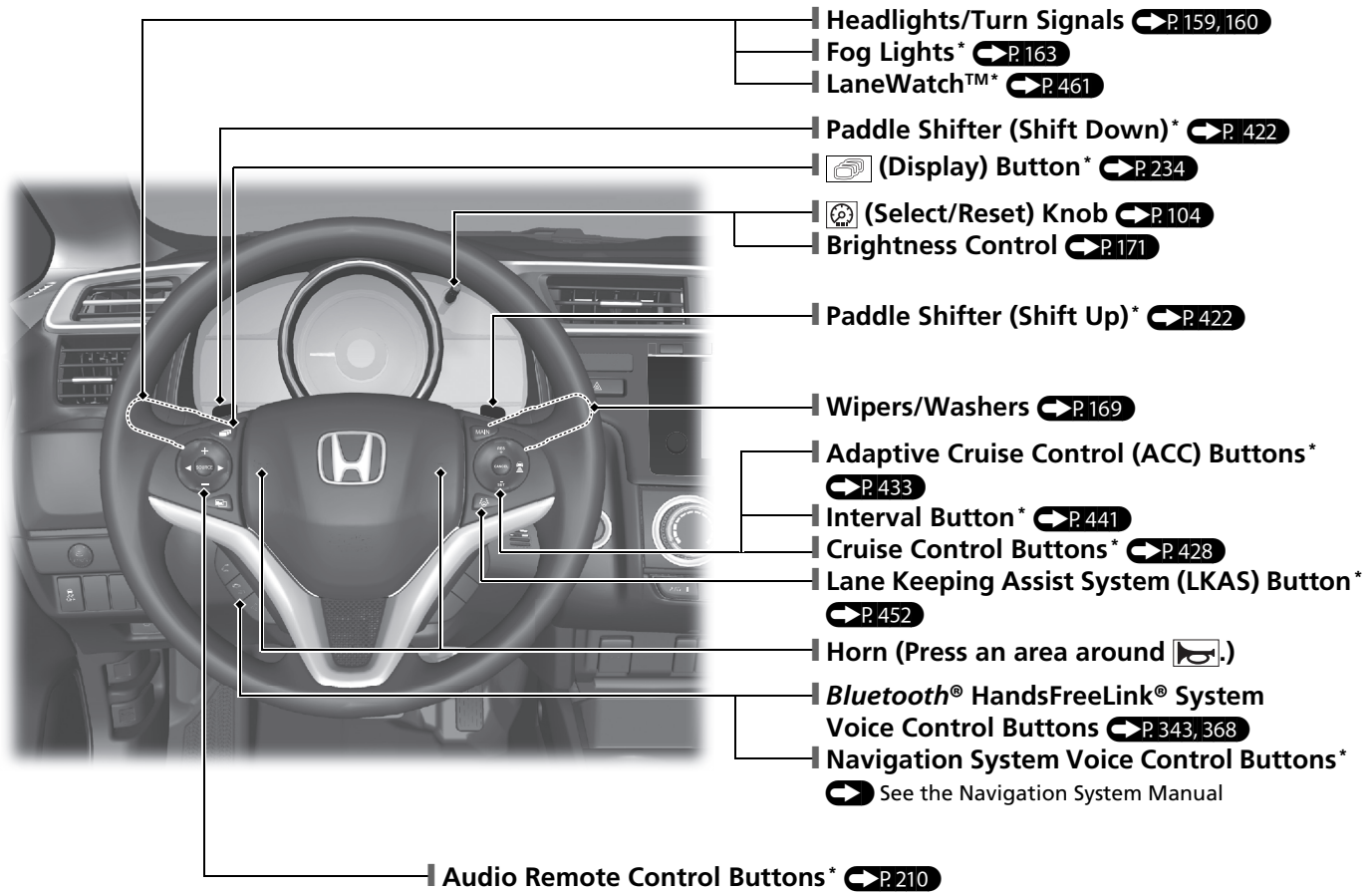

# Visual Index

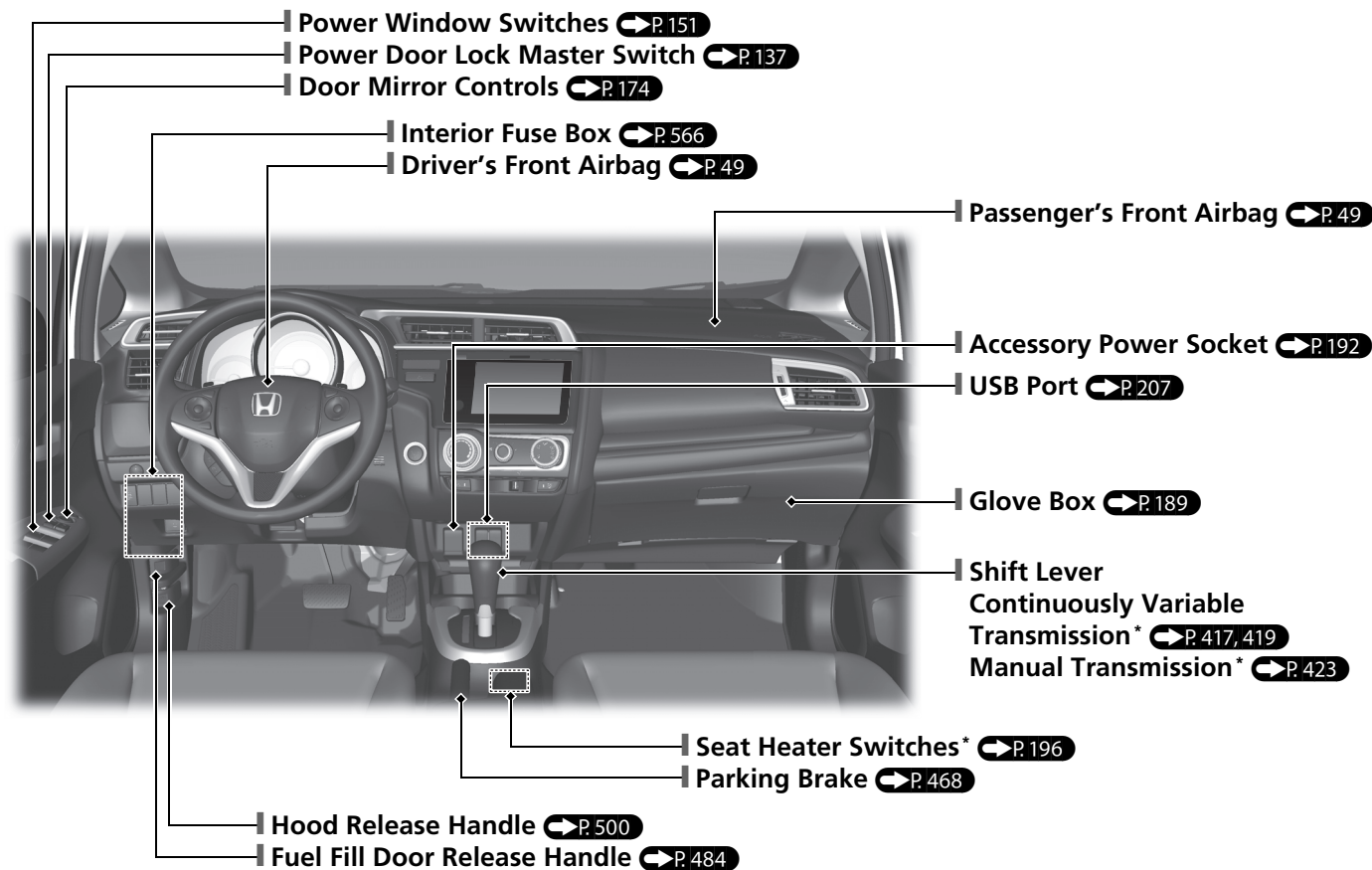

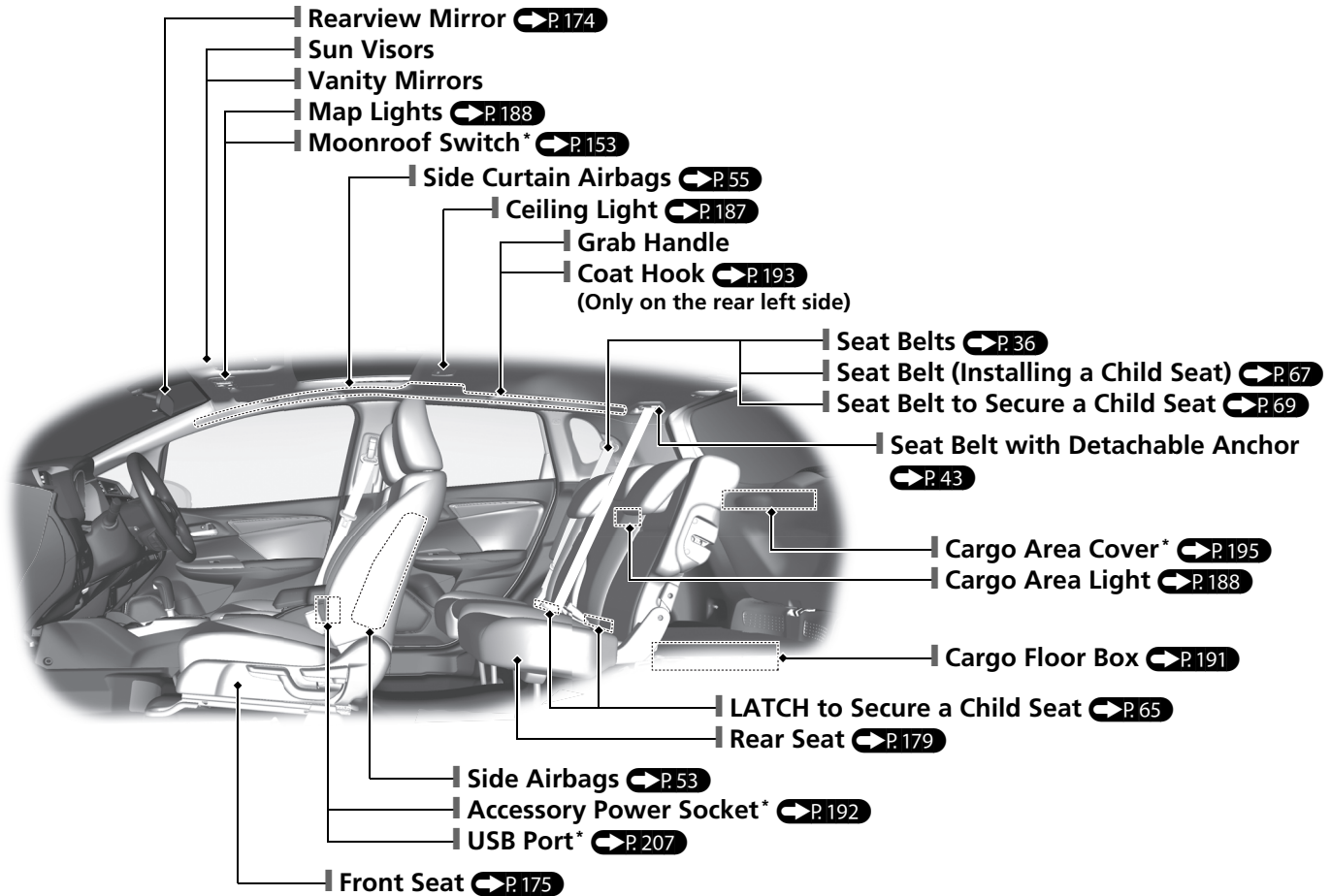

# Visual Index

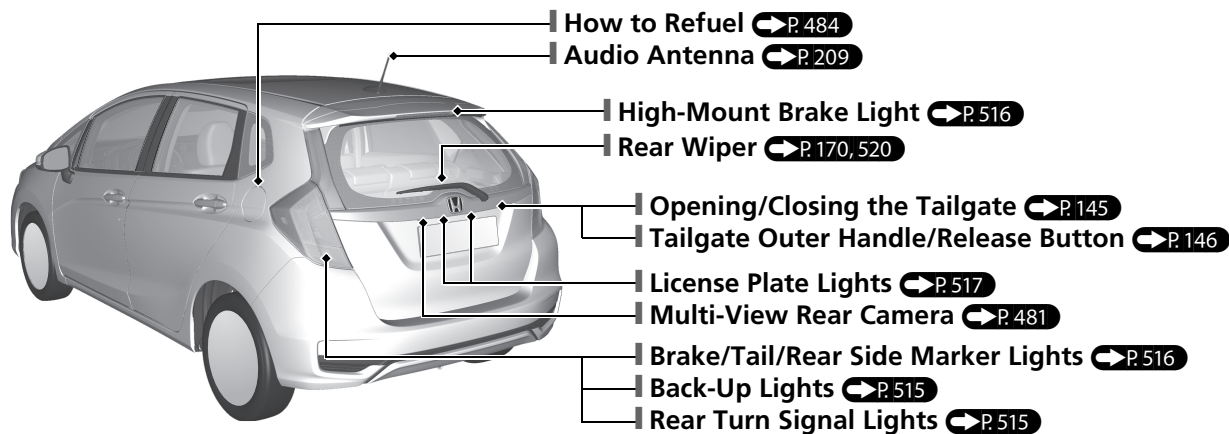
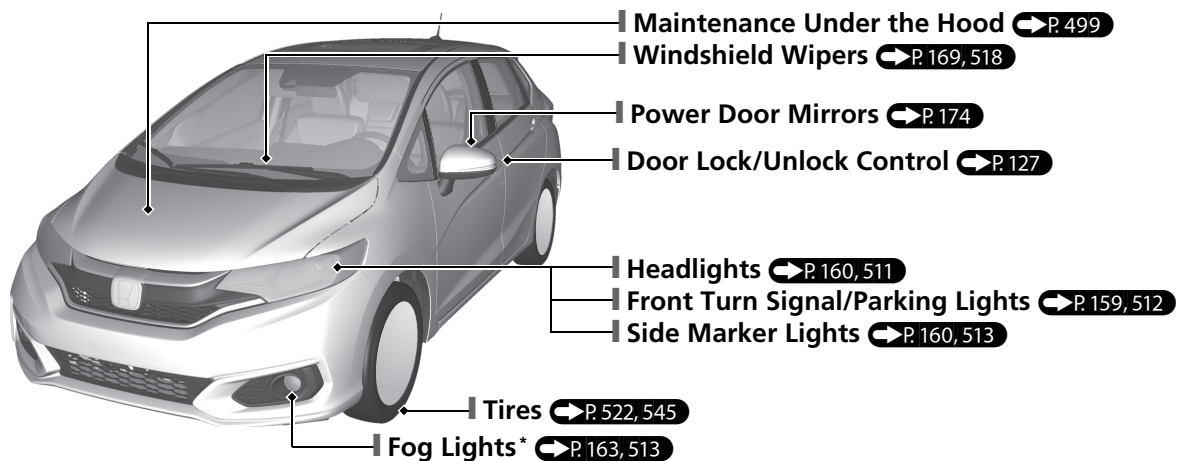



# Eco Assist<sup>®</sup> System

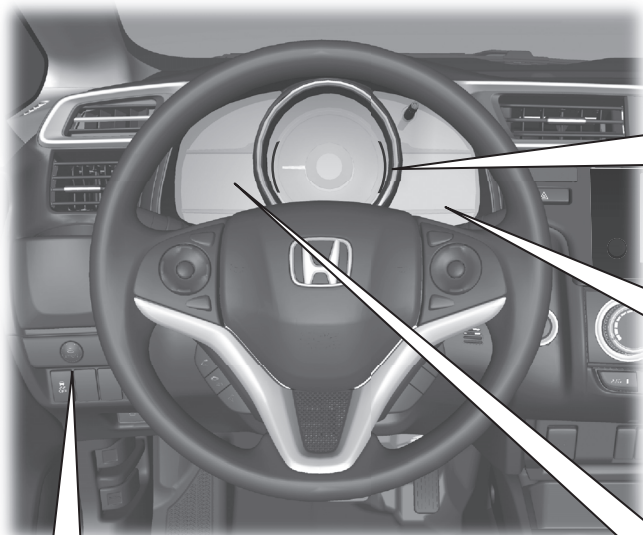

## Ambient Meter

- The color of the ambient meter changes to green to indicate that the vehicle is being driven in a fuel efficient manner.

### Models with multi-information display



The message is displayed for a few seconds when the ECON button is pressed.



## ECON Button\* P.427

Helps maximize fuel economy.



## ECON Mode Indicator\* P.85

Comes on when the ECON button is pressed.

# Safe Driving [↔ P. 31](#)

## Airbags [↔ P. 46](#)

- Your vehicle is fitted with airbags to help protect you and your passengers during a moderate-to-severe collision.

## Child Safety [↔ P. 60](#)

- All children 12 and younger should be seated in the rear seat.
- Smaller children should be properly restrained in a forward-facing child seat.
- Infants must be properly restrained in a rear-facing child seat.

## Exhaust Gas Hazard [↔ P. 73](#)

- Your vehicle emits dangerous exhaust gases that contain carbon monoxide. Do not run the engine in confined spaces where carbon monoxide gas can accumulate.

## Seat Belts [↔ P. 36](#)

- Fasten your seat belt and sit upright well back in the seat.
- Check that your passengers are wearing their seat belts correctly.

## Before Driving Checklist [↔ P. 400](#)

- Before driving, check that the front seats, head restraints, steering wheel, and mirrors have been properly adjusted.

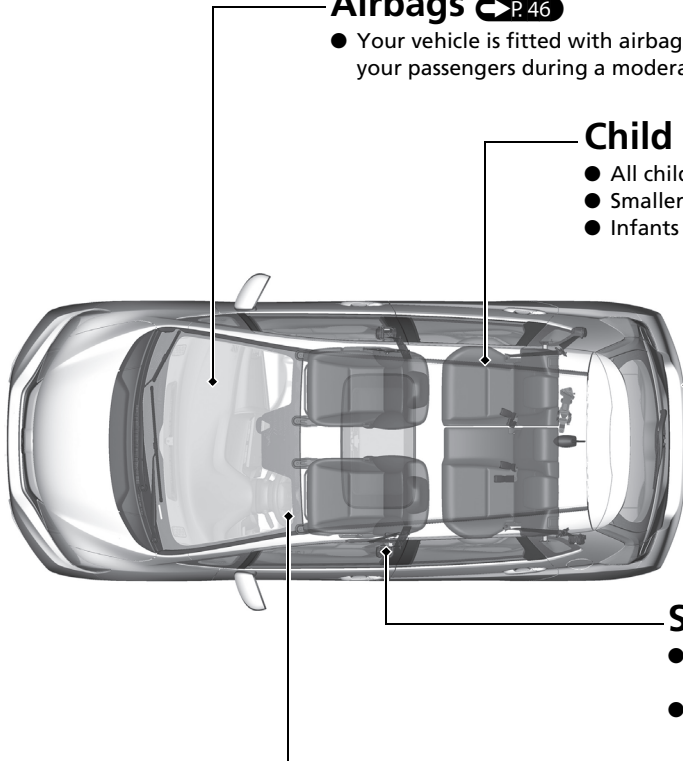



Fasten your lap belt as low as possible.

# Instrument Panel P.75









Gauges  P.103 / Information Display\*  P.104 Multi-Information Display\*  P.107 / System Indicators  P.76

Models with information display

## Lights Indicators



-  Fog Light Indicator\*
-  High Beam Indicator
-  Lights On Indicator

## System Indicators

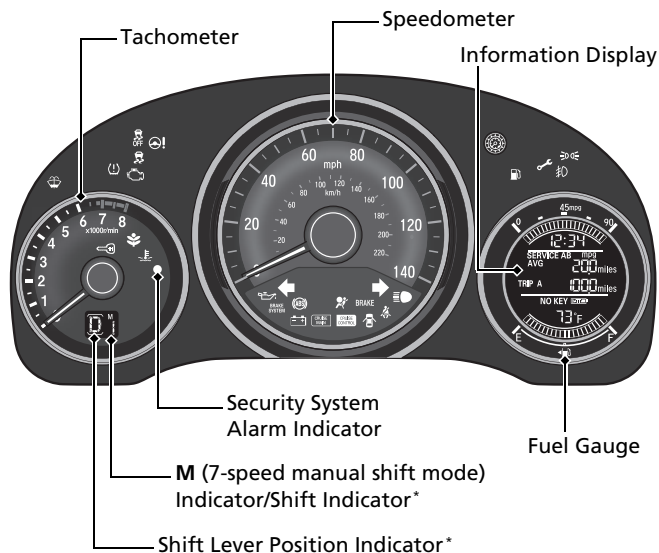

-  Malfunction Indicator Lamp
-  Charging System Indicator
-  Low Oil Pressure Indicator
-  High Temperature Indicator (Red)
-  Low Temperature Indicator (Blue)
-  Vehicle Stability Assist® (VSA®) System Indicator
-  VSA® OFF Indicator
-  Electric Power Steering (EPS) System Indicator











## System Indicators

-  Maintenance Minder Indicator
-  Turn Signal and Hazard Warning Indicators
-  ECON Mode Indicator\*

## System Indicators















-  **CRUISE MAIN** Indicator\*
-  **CRUISE CONTROL** Indicator\*
-  **U.S. models only**  
Low Tire Pressure/TPMS Indicator

## System Indicators

-  Supplemental Restraint System Indicator
-  Immobilizer System Indicator
-  Seat Belt Reminder Indicator
-  Door and Tailgate Open Indicator
-  Washer Level Indicator\*
-  **(ABS)**  
Anti-lock Brake System (ABS) Indicator
-  **BRAKE**  
U.S.  
**(P)**  
Canada  
Parking Brake and Brake System Indicator (Red)
-  **BRAKE**  
SYSTEM  
U.S.  
**(B)**  
Canada  
Brake System Indicator (Amber)
-  Low Fuel Indicator



\* Not available on all models

### System Indicators

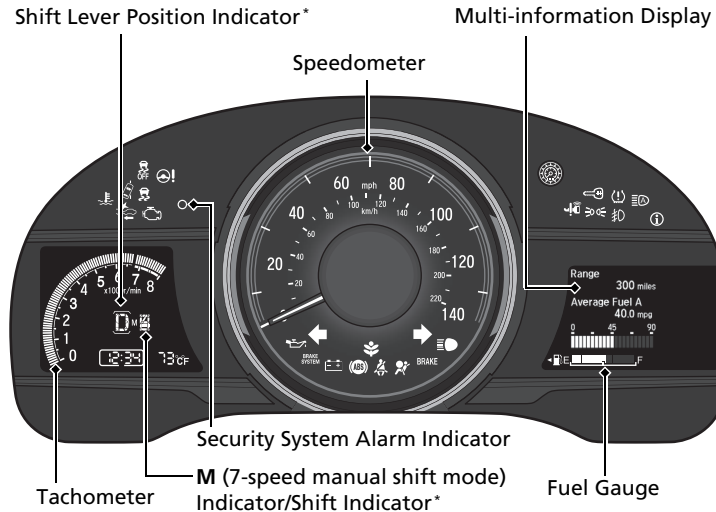



-  Malfunction Indicator Lamp
-  Low Oil Pressure Indicator
-  Charging System Indicator
-  Anti-lock Brake System (ABS) Indicator
-  Vehicle Stability Assist® (VSA®) System Indicator
-  VSA® OFF Indicator
-  High Temperature Indicator (Red)
-  Low Temperature Indicator (Blue)
-  Smart Entry System Indicator\*
-  ECON Mode Indicator\*
-  **BRAKE**  
U.S. Parking Brake and Brake System Indicator (Red)
-  **BRAKE**  
U.S. Canada Parking Brake and Brake System Indicator (Red)
-  **BRAKE**  
U.S. Brake System Indicator (Amber)
-  **BRAKE**  
U.S. Canada Brake System Indicator (Amber)











### System Indicators

-  System Message Indicator
-  **U.S. models only**  
Low Tire Pressure/TPMS Indicator
-  **UP**  
**DOWN** Shift Up / Down Indicator\*

### Lights Indicators

-  Lights On Indicator
-  High Beam Indicator
-  Fog Light Indicator\*
-  Auto High-Beam Indicator

### System Indicators

-  Turn Signal and Hazard Warning Indicators
-  Electric Power Steering (EPS) System Indicator
-  Immobilizer System Indicator
-  Seat Belt Reminder Indicator
-  Supplemental Restraint System Indicator
-  **ACC**  
Adaptive Cruise Control (ACC) Indicator (Amber/Green)
-  Road Departure Mitigation (RDM) Indicator
-  Collision Mitigation Braking System™ (CMBS™) Indicator
-  **LKAS**  
Lane Keeping Assist System (LKAS) Indicator (Amber/Green)

# Controls P.121

## Clock P.122

### Models with navigation system

The navigation system receives signals from GPS satellites, updating the clock automatically.

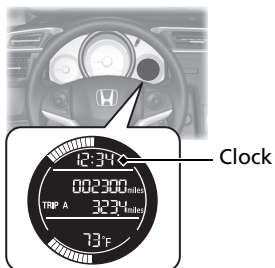

### Models without navigation system



The clock in the information display is automatically updated along with the audio system's clock display.





### Models with display audio system



- 1 Select the  (HOME) icon, then select **Settings**.
- 2 Select **System, Clock/Info**, then **Clock Adjustment**.
- 3 Touch the  /  icon to adjust the numbers up or down.
- 4 Select **OK**.

### Models with color audio system



- 1 Press and hold the **MENU/CLOCK** button.
- 2 Rotate  to change hour, then press .
- 3 Rotate  to change minute, then press .
- 4 Select **SET**, then press .

These indications are used to show how to operate the **LIST/SELECT** (List/Selector) knob.

- Rotate  to select.
- Press  to enter.

## Engine START/STOP Button\* P. 155

Press the button to change the vehicle's power mode.

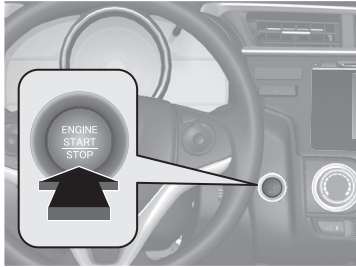

## Turn Signals P. 159

Turn Signal Control Lever

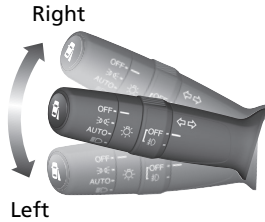

## Lights P. 160

U.S. models

Light Control Switches

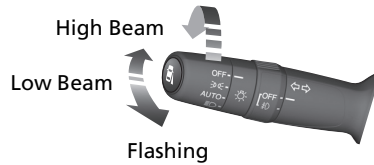

Canadian models

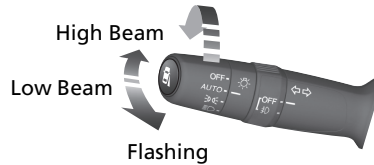



## Wipers and Washers

 P. 169

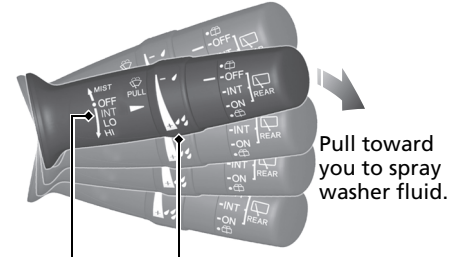
Wiper/Washer Control Lever



Adjustment Ring\*  
 Lower speed, fewer sweeps  
 High speed, more sweeps

**MIST**  
**OFF**

**INT:** Low speed with intermittent  
**LO:** Low speed wipe  
**HI:** High speed wipe

## Steering Wheel P.173

- To adjust, pull the adjustment lever towards you, adjust to the desired position, then lock the lever back in place.

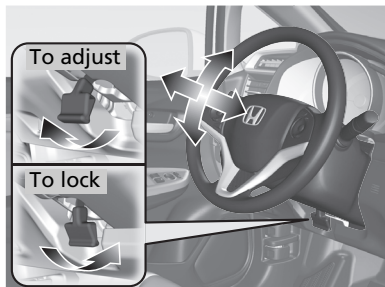

## Unlocking the Front Doors from the Inside

 P.136

- Pull either front door inner handle to unlock and open it in one motion.

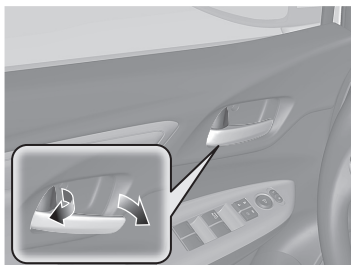

- Unlocking and opening the driver's door from the inner handle unlocks all the other doors.

## Tailgate P.145

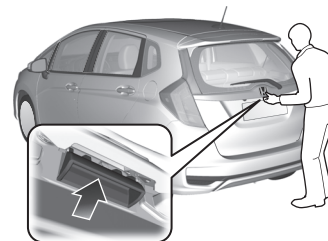

**Models without smart entry system**

- With all the doors unlocked, pull the tailgate outer handle, and lift up to open it.

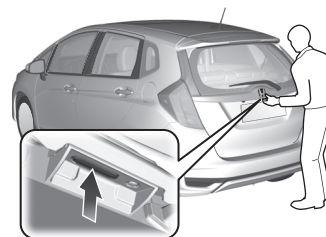

**Models with smart entry system**

- With all the doors unlocked, push the tailgate release button on the tailgate to open it.
- Press the tailgate release button to unlock and open the tailgate when you carry the smart entry remote.

## Power Door Mirrors

➔ P.174

- With the ignition switch in ON **II**\*1, move the selector switch to L or R.
- Push the appropriate edge of the adjustment switch to adjust the mirror.

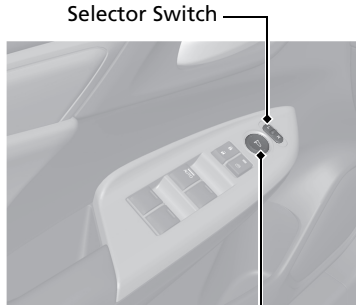

Adjustment Switch

\*1: Models with the smart entry system have an **ENGINE START/STOP** button instead of an ignition switch.

## Power Windows ➔ P.151

- With the ignition switch in ON **II**\*1, open and close the power windows.
- If the power window lock button is in the off position, each passenger's window can be opened and closed with its own switch.
- If the power window lock button is in the on position (indicator on), each passenger's window switch is disabled.

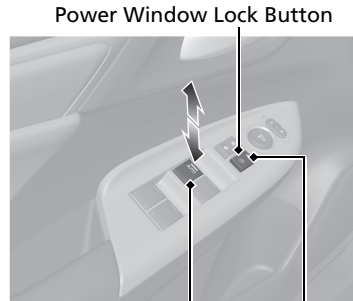







Window Switch

Indicator



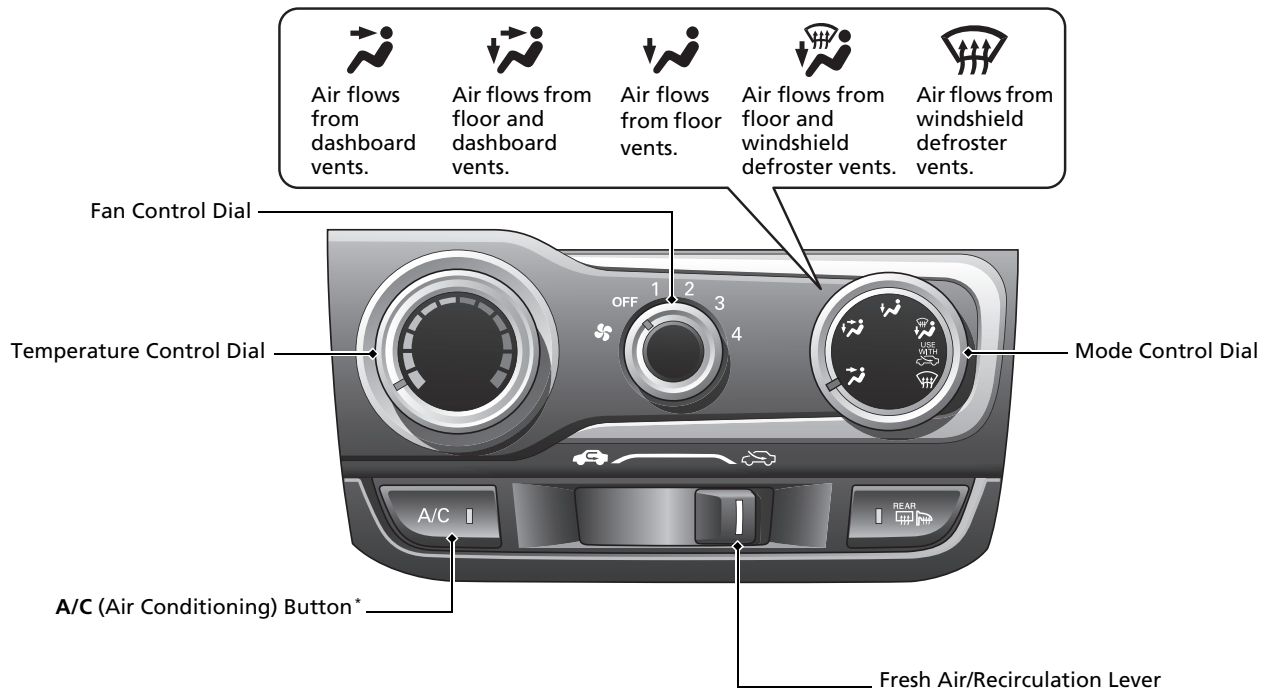

## Heating and Cooling System\*

- Rotate the fan control dial to adjust the fan speed.
- Rotate the mode control dial ( /  /  /  / ) to select the vents air flows from.
- Rotate the temperature control dial to adjust the temperature.
- Rotate the fan control dial to **OFF** to turn the system off.
- Rotate the mode control dial to  to defrost the windshield.



# Climate Control System\*

- Select the **AUTO** icon to activate the climate control system.
- Select the  icon to turn the system on or off.
- Select the  icon to defrost the windshield.

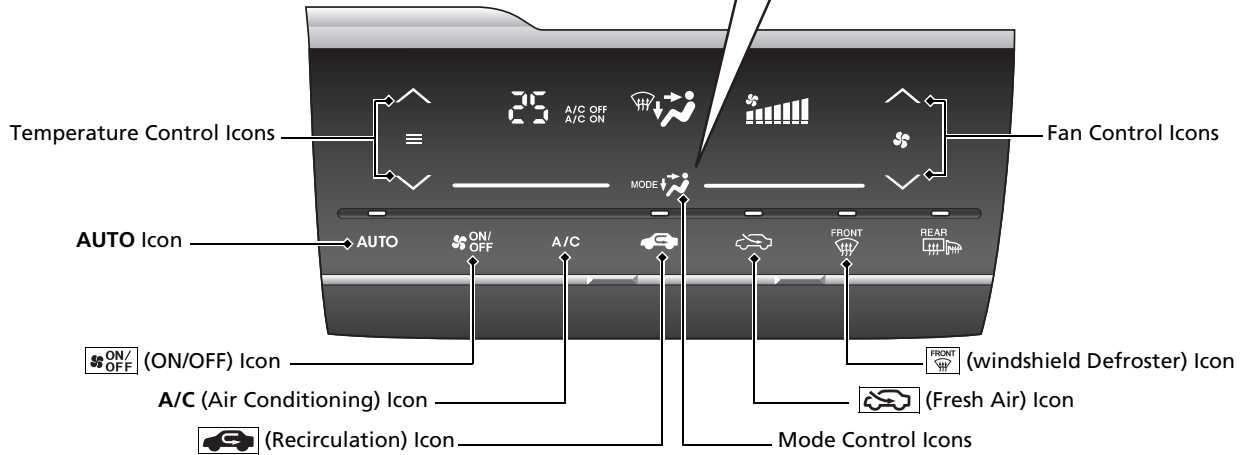
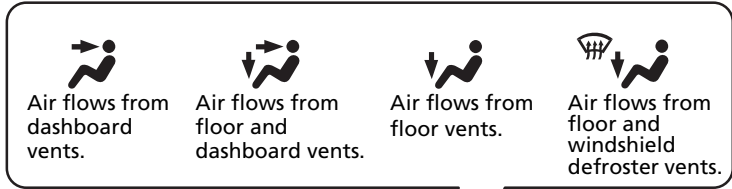

# Features ➔ P.205

## Audio Remote Controls\*

➔ P.210

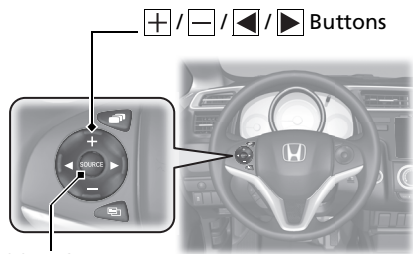

**SOURCE Button**

- **+ / - Button**

Press to adjust the volume up/down.

- **SOURCE Button**

**Models with color audio system**

Press to change the audio mode: FM/AM/CD/USB/iPod/Bluetooth® Audio.

**Models with display audio system**

Press to change the audio mode: FM/AM/SiriusXM®/USB/iPod/Bluetooth® Audio/Pandora®/Apps/Apple CarPlay™/Android Auto™.

- **◀ / ▶ Button**

Radio: Press to change the preset station.  
Press and hold to select the next or previous strong station.

CD\*/USB device:

Press to skip to the beginning of the next song or return to the beginning of the current song.  
Press and hold to change a folder.

# Audio System ➔ P.206

For navigation system operation ➔ See the Navigation System Manual

**Models with color audio system**

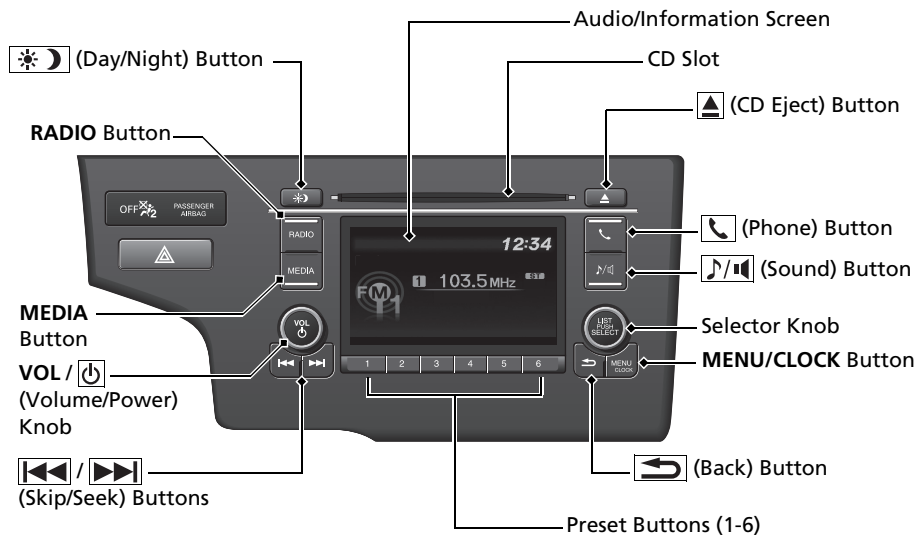

Models with display audio system

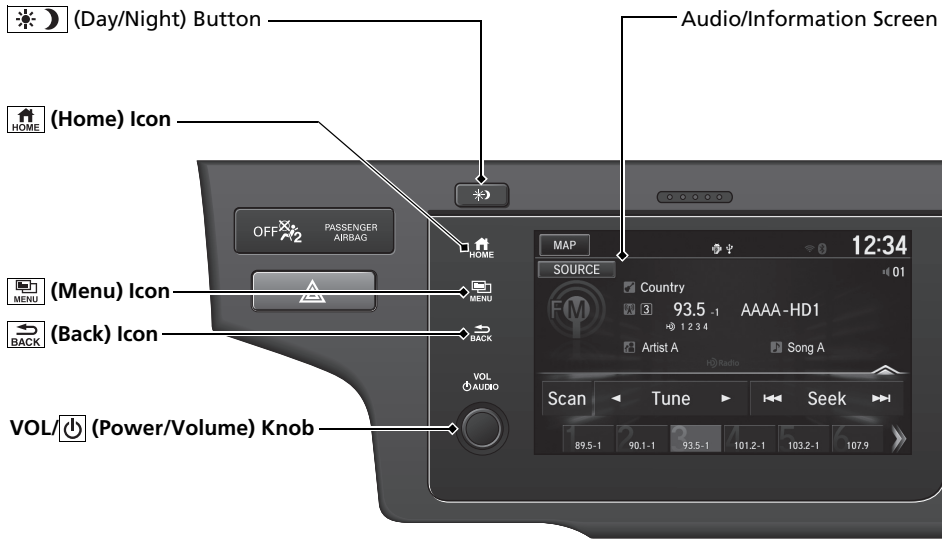

# Driving ➔ P. 399

## Manual Transmission\* ➔ P. 423

## Continuously Variable Transmission\*

➔ P. 417, 419

- Shift to **P** and depress the brake pedal when starting the engine.

### Shifting

Models with paddle shifters

Models without paddle shifters

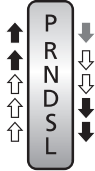

Depress the brake pedal and press the release button to move out of **P**.  
Move the shift lever without pressing the release button.  
Press the release button to move the shift lever.

**P** **Park**  
Turn off or start the engine. Transmission is locked.

**R** **Reverse**  
Used when reversing.

**N** **Neutral**  
Transmission is not locked.

**D** **Drive**  
Normal driving.  
On models with paddle shifters, 7-speed mode can be used temporarily.

Models with paddle shifters

**S** **Drive (S)**  
7-speed manual shift mode can be used.

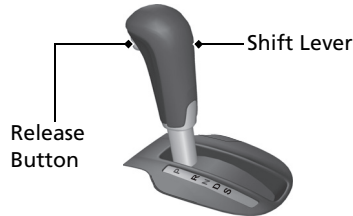

Models without paddle shifters

**S** **Drive (S)**

- Better acceleration
- Used to increase engine braking
- Used when going up or down hills

**L** **Low**

- Used to further increase engine braking
- Used when going up or down hills

### 7-Speed Manual Shift Mode\* ➔ P. 421

- Allows you to manually shift the transmission up or down without removing your hands from the steering wheel.

**When the shift lever is in **S****

- Pulling a paddle shifter changes the mode from continuously variable transmission to 7-speed manual shift mode.
- The **M** indicator and the selected speed number are displayed in the shift indicator.

**When the shift lever is in **D****

- Pulling a paddle shifter temporarily changes the mode from continuously variable transmission to 7-speed manual shift mode. The selected speed number is displayed in the shift indicator.

**M** Indicator

Shift Down Paddle Shifter

Shift Up Paddle Shifter



Shift Indicator

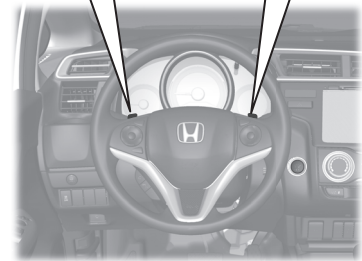
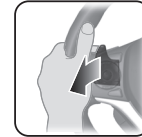

\* Not available on all models

## VSA® On and Off P.460

- The Vehicle Stability Assist® (VSA®) system helps stabilize the vehicle during cornering, and helps maintain traction while accelerating on loose or slippery road surfaces.
- VSA® comes on automatically every time you start the engine.
- To partially disable VSA functionality/features, press and hold button until you hear a beep.

## Cruise Control\* P.428

- Cruise control allows you to maintain a set speed without keeping your foot on the accelerator pedal.
- To use cruise control, press the **CRUISE** button, then press the **-/SET** button once you have achieved the desired speed (above 25 mph or 40 km/h).

## CMBS™ On and Off\*

### P.475

- When a possible collision is likely unavoidable, the CMBS™ can help you to reduce the vehicle speed and the severity of the collision.
- To turn the CMBS™ on or off, press and hold the button until you hear a beep.

U.S. models only

## Tire Pressure Monitoring System (TPMS) P.463

- Detects a change in tire conditions and overall dimensions due to decrease in tire pressures.
- TPMS is turned on automatically every time you start the engine.
- A calibration procedure must be performed when certain conditions arise.

## Refueling P.483

**Fuel recommendation: Unleaded gasoline, pump octane number 87 or higher**

**Fuel tank capacity: 10.6 US gal (40 L)**

- 1** Pull the fuel fill door release handle.

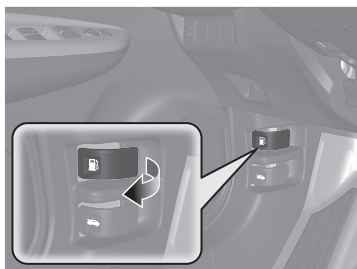

- 2** Turn the fuel fill cap slowly to remove the cap.

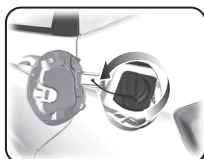

- 3** Place the cap in the holder on the fuel fill door.



- 4** After refueling, screw the cap back on until it clicks at least once.

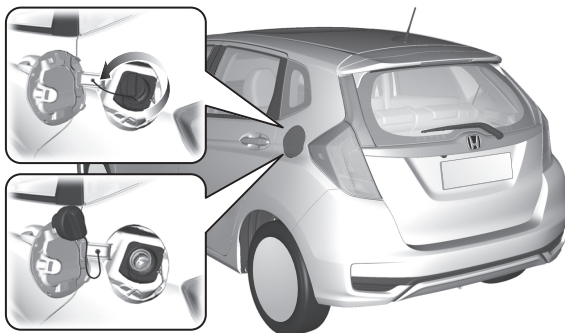

# Honda Sensing<sup>®</sup> \*

Honda Sensing<sup>®</sup> is a driver support system which employs the use of two distinctly different kinds of sensors, a radar sensor located at in the front grille and a front sensor camera mounted to the interior side of the windshield, behind the rearview mirror.

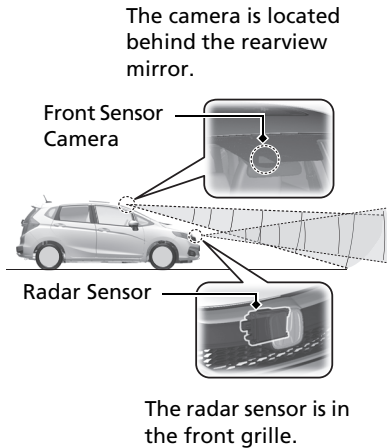

## Adaptive Cruise Control (ACC) P. 433

Helps maintain a constant vehicle speed and a set following-interval behind a vehicle detected ahead of yours, without you having to keep your foot on the brake or the accelerator.

## Road Departure Mitigation (RDM) System P. 447

Alerts and helps to assist you when the system detects a possibility of your vehicle unintentionally crossing over detected lane markings and/or leaving the roadway altogether.

## Lane Keeping Assist System (LKAS) P. 452

Provides steering input to help keep the vehicle in the middle of a detected lane and provides tactile and visual alerts if the vehicle is detected drifting out of its lane.

## Collision Mitigation Braking System<sup>™</sup> (CMBS<sup>™</sup>) P. 472

Can assist you when there is a possibility of your vehicle colliding with a vehicle or a pedestrian detected in front of yours. The CMBS<sup>™</sup> is designed to alert you when a potential collision is determined, as well as to reduce your vehicle speed to help minimize collision severity when a collision is deemed unavoidable.



# Maintenance ➔ P.487

## Under the Hood ➔ P.499

- Check engine oil, engine coolant, and window washer fluid. Add when necessary.
- Check brake/clutch\* fluid
- Check the battery condition monthly.

- 1** Pull the hood release handle under the corner of the dashboard.

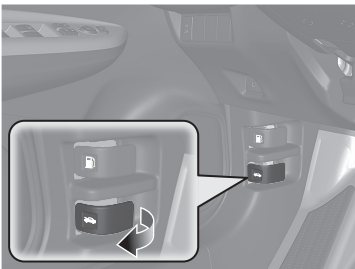

- 2** Locate the hood latch lever, push it to the side, and then raise the hood. Once you have raised the hood slightly, you can release the lever.

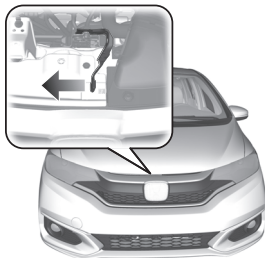

- 3** When finished, close the hood and make sure it is firmly locked in place.

## Wiper Blades ➔ P.518

- Replace blades if they leave streaks across the windshield.

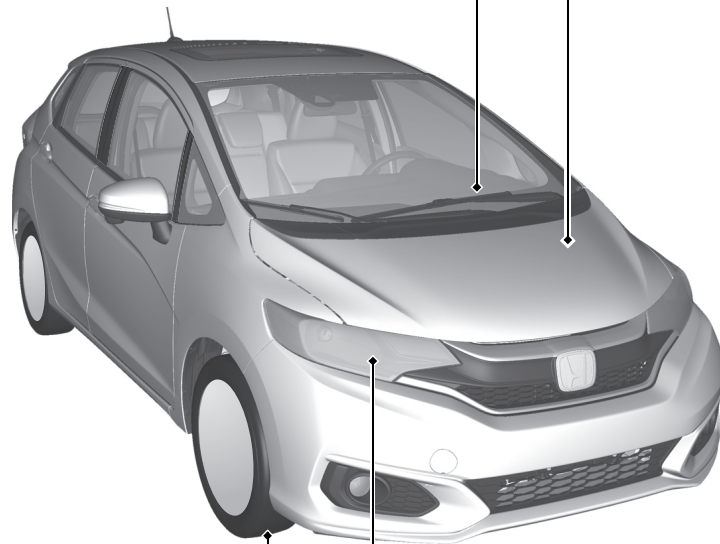

## Tires ➔ P.522

- Inspect tires and wheels regularly.
- Check tire pressures regularly.
- Install snow tires for winter driving.

## Lights ➔ P.511

- Inspect all lights regularly.

# Handling the Unexpected ➔ P.543

## Flat Tire ➔ P.545

- Park in a safe location and replace the flat tire with the compact spare tire in the cargo area.



## Engine Won't Start ➔ P.552

- If the battery is dead, jump start using a booster battery.

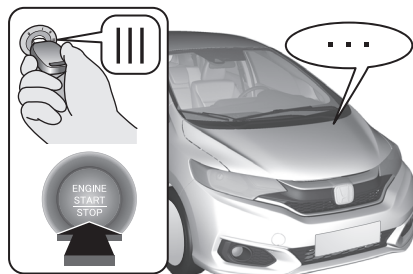

## Overheating ➔ P.558

- Park in a safe location. If you do not see steam under the hood, open the hood, and let the engine cool down.



## Indicators Come On

➔ P.560

- Identify the indicator and consult the owner's manual.

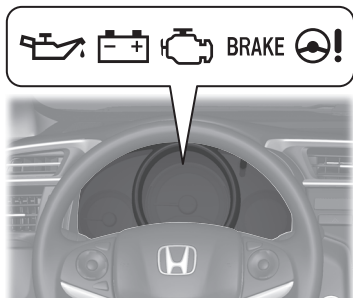

## Blown Fuse ➔ P.564

- Check for a blown fuse if an electrical device does not operate.

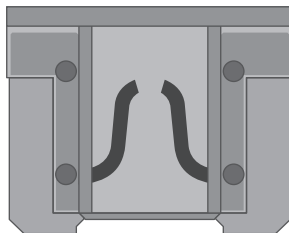

## Emergency Towing ➔ P.569

- Call a professional towing service if you need to tow your vehicle.



# What to Do If

**Q** U.S. models with manual transmission  
Canadian models  
The ignition switch does not turn from **0** to **I**\*1.  
Why?

**A**

- The steering wheel may be locked.

Models without smart entry system

- Try to turn the steering wheel left and right while turning the ignition key.

Models with smart entry system

- Move the steering wheel left and right after pressing the **ENGINE START/STOP**.

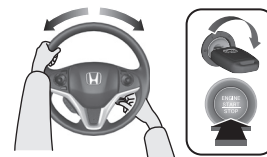

**Q** Continuously variable transmission models without smart entry system  
The ignition switch does not turn from **I** to **0** and I cannot remove the key.  
Why?

**A** The shift lever should be moved to **P**.



Continuously variable transmission models with smart entry system

The power mode does not change from **ACCESSORY** to **VEHICLE OFF (LOCK)**.  
Why?

**Q** Why does the brake pedal pulsate slightly when applying the brakes?

**A** This can occur when the ABS activates and does not indicate a problem. Apply firm, steady pressure on the brake pedal. Never pump the brake pedal.

➤ Anti-lock Brake System (ABS) ➔ P. 470

\*1: Models with the smart entry system have an **ENGINE START/STOP** button instead of an ignition switch.

**Q** The rear door cannot be opened from inside the vehicle. Why?

**A** Check if the childproof lock is in the lock position. If so, open the rear door with the outside door handle. To cancel this function, push the lever to the unlock position.

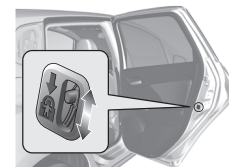

**Q** Why do the doors lock after I unlocked the doors?

**A** If you do not open the doors within 30 seconds, the doors are relocked automatically for security.

**Q** Why does the beeper sound when I open the driver's door?

**A** The beeper sounds when:

- The exterior lights are left on.

**Models without smart entry system**

- The key is left in the ignition switch.

**Models with smart entry system**

- The power mode is in ACCESSORY.

**Q** Why does a beeper sound when I walk away from the vehicle after I close the door?

**A** The beeper sounds if you move outside the walk away auto door lock operating range before the door completely closes.

➤ Locking the vehicle (Walk away auto lock) ➔ P. 128

**Q** Why does the beeper sound when I start driving?

**A** The beeper sounds when:

- Driver and/or front passenger are not wearing their seat belts.
- The parking brake lever is not fully released.



**Why do I hear a screeching sound when I apply the brake pedal?**



The brake pads may need to be replaced. Have your vehicle inspected by a dealer.



**U.S. models only**

**I'm seeing an amber indicator of a tire with an exclamation point. What is that?**



The Tire Pressure Monitoring System (TPMS) needs attention. If you recently inflated or changed a tire, you have to recalibrate the system.

➤ Tire Pressure Monitoring System (TPMS) ➡ **P. 463**



# Safe Driving

You can find many safety recommendations throughout this chapter, and throughout this manual.

## **For Safe Driving**

Important Safety Precautions .....	32
Your Vehicle's Safety Features.....	34

## **Seat Belts**

About Your Seat Belts.....	36
Fastening a Seat Belt.....	40
Seat Belt Inspection.....	45

## **Airbags**

Airbag System Components.....	46
Types of Airbags .....	49
Front Airbags (SRS) .....	49
Side Airbags.....	53

Side Curtain Airbags .....	55
Airbag System Indicators.....	57
Airbag Care .....	59

## **Child Safety**

Protecting Child Passengers .....	60
Safety of Infants and Small Children ....	62
Safety of Larger Children .....	71

## **Exhaust Gas Hazard**

Carbon Monoxide Gas.....	73
--------------------------	----

## **Safety Labels**

Label Locations .....	74
-----------------------	----

The following pages explain your vehicle's safety features and how to use them properly. The safety precautions below are ones that we consider to be among the most important.

## Important Safety Precautions

### ■ Always wear your seat belt

A seat belt is your best protection in all types of collisions. Airbags are designed to supplement seat belts, not replace them. So even though your vehicle is equipped with airbags, make sure you and your passengers always wear your seat belts, and wear them properly.

### ■ Restrain all children

Children ages 12 and under should ride properly restrained in a back seat, not the front seat. Infants and small children should be restrained in a child seat. Larger children should use a booster seat and a lap/shoulder seat belt until they can use the belt properly without a booster seat.

### ■ Be aware of airbag hazards

While airbags can save lives, they can cause serious or fatal injuries to occupants who sit too close to them, or are not properly restrained. Infants, young children, and short adults are at the greatest risk. Be sure to follow all instructions and warnings in this manual.

### ■ Don't drink and drive

Alcohol and driving don't mix. Even one drink can reduce your ability to respond to changing conditions, and your reaction time gets worse with every additional drink. So don't drink and drive, and don't let your friends drink and drive, either.

### ⓘ Important Safety Precautions

Some states, provinces and territories prohibit the use of cell phones other than hands-free devices by the driver while driving.



**■ Pay appropriate attention to the task of driving safely**

Engaging in cell phone conversation or other activities that keep you from paying close attention to the road, other vehicles, and pedestrians could lead to a crash. Remember, situations can change quickly, and only you can decide when it is safe to divert some attention away from driving.

**■ Control your speed**

Excessive speed is a major factor in crash injuries and deaths. Generally, the higher the speed, the greater the risk, but serious injuries can also occur at lower speeds. Never drive faster than is safe for current conditions, regardless of the maximum speed posted.

**■ Keep your vehicle in safe condition**

Having a tire blowout or a mechanical failure can be extremely hazardous. To reduce the possibility of such problems, check your tire pressures and condition frequently, and perform all regularly scheduled maintenance.

**■ Do not leave children unattended in the vehicle**

Children left unattended in the vehicle may be injured if they activate one or more of the vehicle controls. They may also cause the vehicle to move, resulting in a crash in which the children and/or another person(s) can be injured or killed. Also, depending on the ambient temperature, the temperature of the interior may reach extreme levels, which can result in injury or death. Even if the climate control system is on, never leave children in the vehicle unattended as the climate control system can shut off at any time.

## Your Vehicle's Safety Features

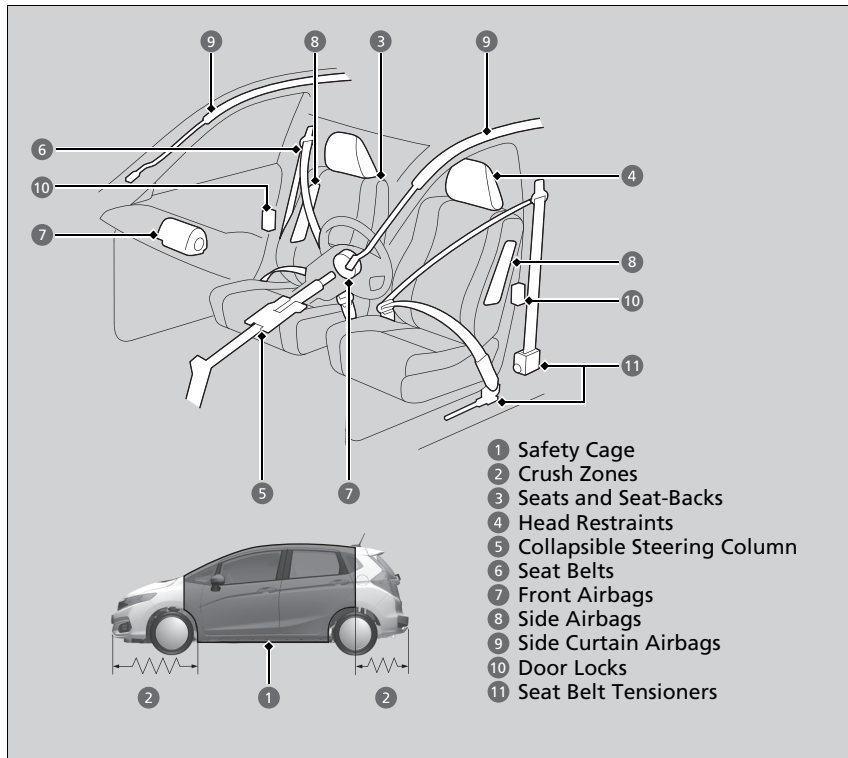

The following checklist will help you take an active role in protecting yourself and your passengers.

### ►► Your Vehicle's Safety Features

Your vehicle is equipped with many features that work together help to protect you and your passengers during a crash.

Some features do not require any action on your part. These include a strong steel framework that forms a safety cage around the passenger compartment, front and rear crush zones, a collapsible steering column, and tensioners that tighten the front seat belts in a sufficient crash.

However, you and your passengers cannot take full advantage of these features unless you remain seated in the correct position and always wear your seat belts. In fact, some safety features can contribute to injuries if they are not used properly.

## Safety Checklist

For the safety of you and your passengers, make a habit of checking these items each time before you drive.

- After everyone has entered the vehicle, be sure all doors and the tailgate are closed and locked. Locking the doors and the tailgate helps prevent an occupant from being ejected and an outsider from unexpectedly opening a door or the tailgate.
  - **Locking/Unlocking the Doors from the Inside** P. 135
- Adjust your seat to a position suitable for driving. Be sure the front seats are adjusted as far to the rear as possible while allowing the driver to control the vehicle. Sitting too close to a front airbag can result in serious or fatal injury in a crash.
  - **Adjusting the Seats** P. 175
- Adjust head restraints to the proper position. Head restraints are most effective when the center of the head restraint aligns with the center of your head. Taller persons should adjust their head restraint to the highest position.
  - **Adjusting the front head restraint positions** P. 182
- Always wear your seat belt, and make sure you wear it properly. Confirm that any passengers are properly belted as well.
  - **Fastening a Seat Belt** P. 40
- Protect children by using seat belts or child seats according to a child's age, height and weight.
  - **Child Safety** P. 60

\* Not available on all models

### ➤ Safety Checklist

#### Models without multi-information display

If the door and tailgate open indicator is on, a door and/or the tailgate is not completely closed. Close all doors and the tailgate tightly until the indicator goes off.

➤ **Door and Tailgate Open Indicator\*** P. 82



#### Models with multi-information display

If the door and/or tailgate open message appears on the multi-information display (MID), a door and/or the tailgate is not completely closed. Close all doors and the tailgate tightly until the message disappears.

➤ **Multi-Information Display Warning and Information Messages\*** P. 92

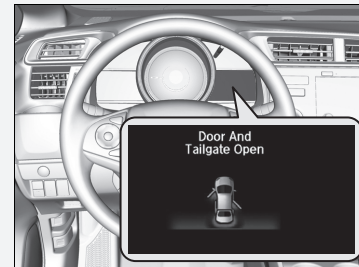

## About Your Seat Belts

Seat belts are the single most effective safety device because they keep you connected to the vehicle so that you can take advantage of many built-in safety features. They also help keep you from being thrown against the inside of the vehicle, against any passengers, or out of the vehicle. When worn properly, seat belts also keep your body properly positioned in a crash so that you can take full advantage of the additional protection provided by the airbags.

In addition, seat belts help protect you in almost every type of crash, including:

- frontal impacts
- side impacts
- rear impacts
- rollovers

### ■ Lap/shoulder seat belts

All five seating positions are equipped with lap/shoulder seat belts with emergency locking retractors. In normal driving the retractor lets you move freely while keeping some tension on the belt. During a collision or sudden stop the retractor locks to restrain your body. The front passenger's and rear seat belts also have a lockable retractor for use with child seats.

➤ **Installing a Child Seat with a Lap/Shoulder Seat Belt** P. 67

### ➤ About Your Seat Belts

## **WARNING**

**Not wearing a seat belt properly increases the chance of serious injury or death in a crash, even though your vehicle has airbags.**

**Be sure you and your passengers always wear seat belts and wear them properly.**

If a rear seat passenger moves around and extends the seat belt, the lockable retractor may activate. If this happens, release the retractor by unfastening the seat belt and allow the belt to retract completely. Then refasten the belt.

If you extend the seat belt too quickly, it will lock in place. If this happens, slightly retract the seat belt, then extend it slowly.

Seat belts cannot completely protect you in every crash. But in most cases, seat belts can reduce your risk of serious injury.

Most states and all Canadian provinces and territories require you to wear seat belts.

**■ Proper use of seat belts**

Follow these guidelines for proper use:

- All occupants should sit upright, well back in the seat, and remain in that position for the duration of the trip. Slouching and leaning reduce the effectiveness of the belt and can increase the chance of serious injury in a crash.
- Never place the shoulder part of a lap/shoulder seat belt under your arm or behind your back. This could cause very serious injuries in a crash.
- Two people should never use the same seat belt. If they do, they could be very seriously injured in a crash.
- Do not put any accessories on the seat belts. Devices intended to improve comfort or reposition the shoulder part of a seat belt can reduce the protective capability and increase the chance of serious injury in a crash.

## Seat Belt Reminder

Models without multi-information display



The seat belt system includes an indicator on the instrument panel to remind the driver or a front passenger or both to fasten their seat belts.

If the ignition switch is turned to ON  $\square$ \*1 and a seat belt is not fastened, a beeper will sound and the indicator will blink. After a few seconds, the beeper will stop and the indicator will come on and remain illuminated until the seat belt is fastened.

The beeper will periodically sound and the indicator will blink while the vehicle is moving until the seat belt is fastened.

Models with multi-information display

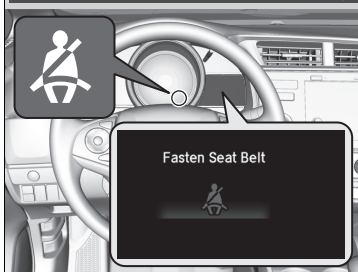

## Seat Belt Reminder

The indicator will also come on if a front passenger does not fasten their seat belt within six seconds after the ignition switch is turned to ON  $\square$ \*1.

When no one is sitting in the front passenger's seat, the indicator will not come on and the beeper will not sound.

The indicator also may not come on and the beeper may not sound when the occupant is not heavy enough to trigger the weight sensor. Such occupants (e.g., infants and smaller children) should be moved to a rear seat as a deploying front airbag likely will injure or kill them.

**Protecting Child Passengers P. 60**

\*1: Models with the smart entry system have an **ENGINE START/STOP** button instead of an ignition switch.

## Automatic Seat Belt Tensioners

The front seats are equipped with automatic seat belt tensioners to enhance safety.

The tensioners automatically tighten the front seat belts during a moderate-to-severe frontal collision, sometimes even if the collision is not severe enough to inflate the front airbags.

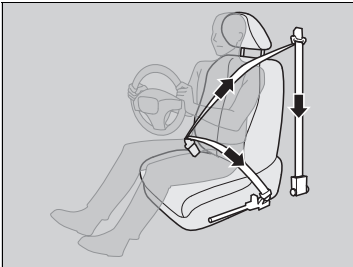

### Automatic Seat Belt Tensioners

The seat belt tensioners can only operate once. If a tensioner is activated, the SRS indicator will come on. Have a dealer replace the tensioner and thoroughly inspect the seat belt system as it may not offer protection in a subsequent crash.

During a moderate-to-severe side impact, the tensioner on that side of the vehicle also activates.

## Fastening a Seat Belt

After adjusting a front seat to the proper position, and while sitting upright and well back in the seat:

➤ **Adjusting the Seats** P. 175

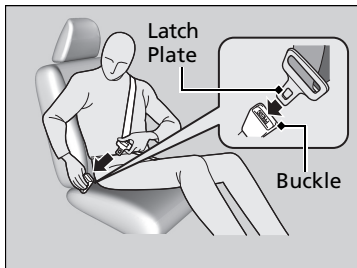
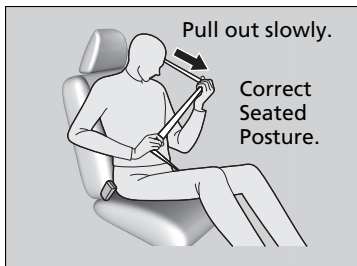

1. Pull the seat belt out slowly.

2. Insert the latch plate into the buckle, then tug on the belt to make sure the buckle is secure.

▶ Make sure that the belt is not twisted or caught on anything.

### Fastening a Seat Belt

No one should sit in a seat with an inoperative seat belt or one that does not appear to be working correctly. Using a seat belt that is not working properly may not protect the occupant in a crash. Have a dealer check the belt as soon as possible.





3. Position the lap part of the belt as low as possible across your hips, then pull up on the shoulder part of the belt so the lap part fits snugly. This lets your strong pelvic bones take the force of a crash and reduces the chance of internal injuries.
4. If necessary, pull up on the belt again to remove any slack, then check that the belt rests across the center of your chest and over your shoulder. This spreads the forces of a crash over the strongest bones in your upper body.

#### Fastening a Seat Belt

### **⚠ WARNING**

Improperly positioning the seat belts can cause serious injury or death in a crash.

**Make sure all seat belts are properly positioned before driving.**

To release the belt, push the red **PRESS** button and then guide the belt by hand until it has retracted completely.

When exiting the vehicle, be sure the belt is properly stowed so that it will not get caught in the closing door.

Never insert any foreign objects into the buckle or retractor mechanism.

## ■ Adjusting the Shoulder Anchor

The front seats have adjustable shoulder anchors to accommodate taller and shorter occupants.

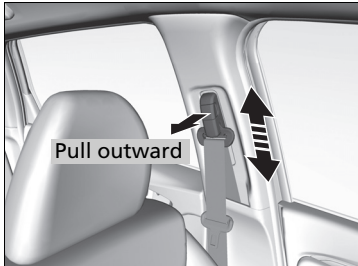

1. Move the anchor up and down while pulling the release outward.
2. Position the anchor so that the belt rests across the center of your chest and over your shoulder.

## ▣ Adjusting the Shoulder Anchor

The shoulder anchor height can be adjusted to four levels. If the belt contacts your neck, lower the height one level at a time.

After an adjustment, make sure that the shoulder anchor position is secure.

## Seat Belt with Detachable Anchor

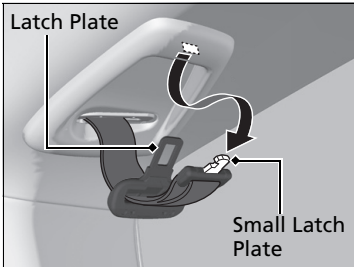

1. Pull out the seat belt's small latch plate and the latch plate from each holding slot in the ceiling.

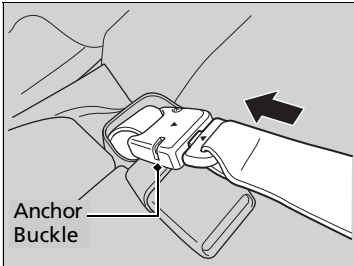

2. Line up the triangle marks on the small latch plate and anchor buckle. Make sure the seat belt is not twisted. Attach the belt to the anchor buckle.

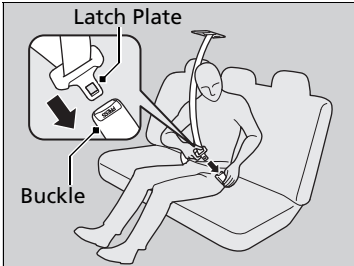

3. Insert the latch plate into the buckle. Properly fasten the seat belt the same way you fasten the lap/shoulder seat belt.

## Seat Belt with Detachable Anchor

### **WARNING**

Using the seat belt with the detachable anchor unlatched increases the chance of serious injury or death in a crash.

Before using the seat belt, make sure the detachable anchor is correctly latched.

To unlatch the detachable anchor, insert the latch plate into the slot on the side of the anchor buckle.

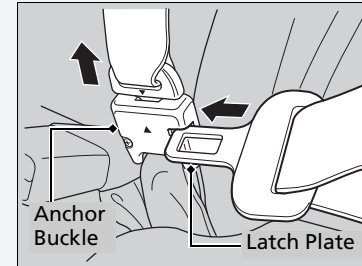

## ■ Advice for Pregnant Women

If you are pregnant, the best way to protect yourself and your unborn child when driving or riding in a vehicle is to always wear a seat belt and keep the lap part of the belt as low as possible across the hips.



## ▣ Advice for Pregnant Women

Each time you have a checkup, ask your doctor if it is okay for you to drive.

To reduce the risk of injuries to both you and your unborn child that can be caused by an inflating front airbag:

- When driving, sit upright and adjust the seat as far back as possible while allowing full control of the vehicle.
- When sitting in the front passenger's seat, adjust the seat as far back as possible.

## Seat Belt Inspection

Regularly check the condition of your seat belts as follows:

- Pull each belt out fully, and look for frays, cuts, burns, and wear.
- Check that the latch plates and buckles work smoothly and the belts retract easily.
  - ▶ If a belt does not retract easily, cleaning the belt may correct the problem. Only use a mild soap and warm water. Do not use bleach or cleaning solvents. Make sure the belt is completely dry before allowing it to retract.

Any belt that is not in good condition or working properly will not provide proper protection and should be replaced as soon as possible.

A belt that has been worn during a crash may not provide the same level of protection in a subsequent crash. Have your seat belts inspected by a dealer after any collision.

### ▶▶ Seat Belt Inspection

#### **WARNING**

Not checking or maintaining seat belts can result in serious injury or death if the seat belts do not work properly when needed.

Check your seat belts regularly and have any problem corrected as soon as possible.

## Airbag System Components

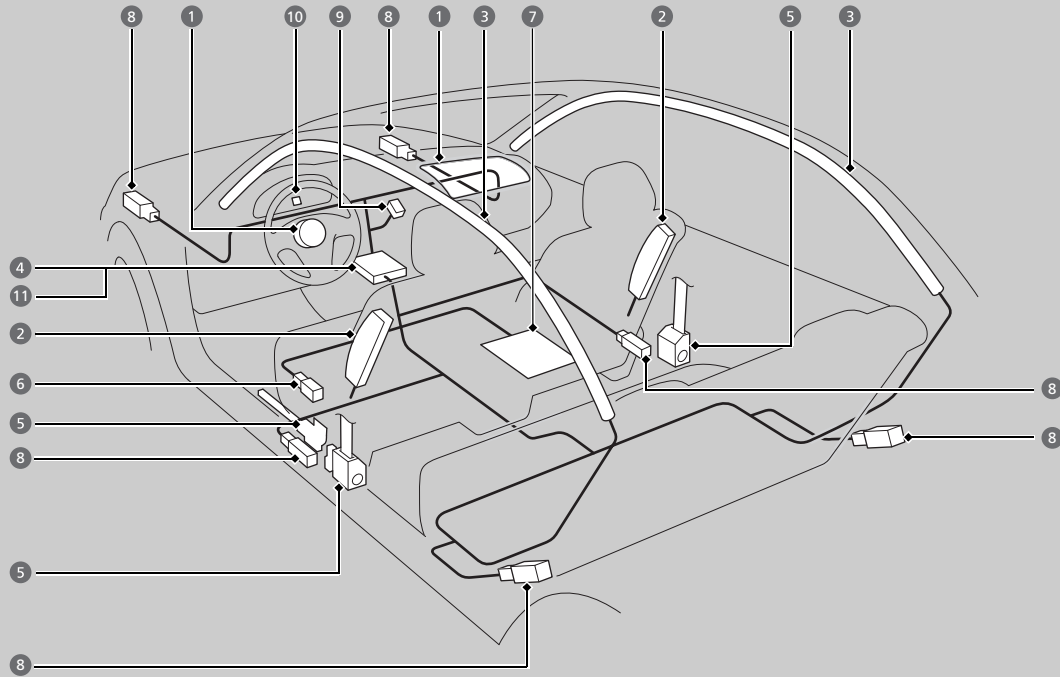

The front, front side, and side curtain airbags are deployed according to the direction and severity of impact. Both side curtain airbags are deployed in a rollover. The airbag system includes:

- 1 Two SRS (Supplemental Restraint System) front airbags. The driver's airbag is stored in the center of the steering wheel; the front passenger's airbag is stored in the dashboard. Both are marked **SRS AIRBAG**.
- 2 Two side airbags, one for the driver and one for a front passenger. The airbags are stored in the outer edges of the seat-backs. Both are marked **SIDE AIRBAG**.
- 3 Two side curtain airbags, one for each side of the vehicle. The airbags are stored in the ceiling, above the side windows. The front and rear pillars are marked **SIDE CURTAIN AIRBAG**.
- 4 An electronic control unit that, when the ignition switch is ON **II**\*<sup>1</sup>, continually monitors information about the various impact sensors, seat and buckle sensors, rollover sensor, airbag activators, seat belt tensioners, and other vehicle information. During a crash event the unit can record such information.
- 5 Automatic front seat belt tensioners. In addition, the driver's and front passenger's seat belt buckles incorporate sensors that detect whether or not the belts are fastened.
- 6 A driver's seat position sensor. This sensor determines the optimal force at which the airbag will deploy in a crash.
- 7 Weight sensors in the front passenger's seat. The front passenger's airbag will be turned off if the weight on the seat is approximately 65 lbs (29 kg) or less (the weight of an infant or small child).
- 8 Impact sensors that can detect a moderate-to-severe front or side impact.
- 9 An indicator on the dashboard that alerts you that the front passenger's front airbag has been turned off.
- 10 An indicator on the instrument panel that alerts you to a possible problem with your airbag system or seat belt tensioners.
- 11 A rollover sensor that can detect if your vehicle is about to roll over and signal the control unit to deploy both side curtain airbags.

\*1: Models with the smart entry system have an **ENGINE START/STOP** button instead of an ignition switch.

## ■ Important facts about your airbags

Airbags can pose serious hazards. To do their job, airbags must inflate with tremendous force. So, while airbags help save lives, they can cause burns, bruises, and other minor injuries, sometimes even fatal ones if occupants are not wearing their seat belts properly and sitting correctly.

**What you should do:** Always wear your seat belt properly, and sit upright and as far back from the steering wheel as possible while allowing full control of the vehicle. A front passenger should move their seat as far back from the dashboard as possible.

Remember, however, that no safety system can prevent all injuries or deaths that can occur in a severe crash, even when seat belts are properly worn and the airbags deploy.

**Do not place hard or sharp objects between yourself and a front airbag.**

Carrying hard or sharp objects on your lap, or driving with a pipe or other sharp object in your mouth, can result in injuries if your front airbag inflates.

**Do not attach or place objects on the front airbag covers.** Objects on the covers marked **SRS AIRBAG** could interfere with the proper operation of the airbags or be propelled inside the vehicle and hurt someone if the airbags inflate.

## ▣ Important facts about your airbags

Do not attempt to deactivate your airbags. Together, airbags and seat belts provide the best protection.

When driving, keep hands and arms out of the deployment path of the front airbag by holding each side of the steering wheel. Do not cross an arm over the airbag cover.



## Types of Airbags

Your vehicle is equipped with three types of airbags:

- **Front airbags:** Airbags in front of the driver's and front passenger's seats.
- **Side airbags:** Airbags in the driver's and front passenger's seat-backs.
- **Side curtain airbags:** Airbags above the side windows.

Each is discussed in the following pages.

## Front Airbags (SRS)

The front SRS airbags inflate in a moderate-to-severe frontal collision to help protect the head and chest of the driver and/or front passenger.

**SRS** (Supplemental Restraint System) indicates that the airbags are designed to supplement seat belts, not replace them. Seat belts are the occupant's primary restraint system.

### Housing Locations

The front airbags are housed in the center of the steering wheel for the driver, and in the dashboard for the front passenger. Both airbags are marked **SRS AIRBAG**.

### Types of Airbags

The airbags can inflate whenever the ignition switch is in ON \*1.

After an airbag inflates in a crash, you may see a small amount of smoke. This is from the combustion process of the inflator material and is not harmful. People with respiratory problems may experience some temporary discomfort. If this occurs, get out of the vehicle as soon as it is safe to do so.

### Front Airbags (SRS)

During a frontal crash severe enough to cause one or both front airbags to deploy, the airbags can inflate at different rates, depending on the severity of the crash, whether or not the seat belts are latched, and/or other factors. Frontal airbags are designed to supplement the seat belts to help reduce the likelihood of head and chest injuries in frontal crashes.

\*1: Models with the smart entry system have an **ENGINE START/STOP** button instead of an ignition switch.

## ■ Operation

Front airbags are designed to inflate during moderate-to-severe frontal collisions. When the vehicle decelerates suddenly, the sensors send information to the control unit which signals one or both front airbags to inflate.

A frontal collision can be either head-on or angled between two vehicles, or when a vehicle crashes into a stationary object, such as a concrete wall.

## ■ How the Front Airbags Work

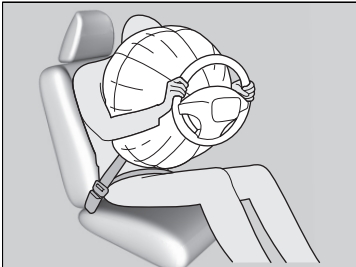

While your seat belt restrains your torso, the front airbag provides supplemental protection for your head and chest.

The front airbags deflate immediately so that they won't interfere with the driver's visibility or the ability to steer or operate other controls.

The total time for inflation and deflation is so fast that most occupants are not aware that the airbags deployed until they see them lying in front of them.

## ✎ How the Front Airbags Work

Although the driver's and front passenger's airbags normally inflate within a split second of each other, it is possible for only one airbag to deploy. This can happen if the severity of a collision is at the margin, or threshold, that determines whether or not the airbags will deploy. In such cases, the seat belt will provide sufficient protection, and the supplemental protection offered by the airbag would be minimal.

### ■ When front airbags should not deploy

**Minor frontal crashes:** Front airbags were designed to supplement seat belts and help to save lives, not to prevent minor scrapes, or even broken bones that might occur during a less than moderate-to-severe frontal crash.

**Side impacts:** Front airbags can provide protection when a sudden deceleration causes a driver or front passenger to move towards the front of the vehicle. Side airbags and side curtain airbags have been specifically designed to help reduce the severity of injuries that can occur during a moderate-to-severe side impact which can cause the driver or passenger to move towards the side of the vehicle.

**Rear impacts:** Head restraints and seat belts are your best protection during a rear impact. Front airbags cannot provide any significant protection and are not designed to deploy in such collisions.

**Rollovers:** In a rollover, your best form of protection is a seat belt or, if your vehicle is equipped with a rollover sensor, both a seat belt and a side curtain airbag. Front airbags, however, are not designed to deploy in a rollover as they would provide little if any protection.

### ■ When front airbags deploy with little or no visible damage

Because the airbag system senses sudden deceleration, a strong impact to the vehicle framework or suspension might cause one or more of the airbags to deploy. Examples include running into a curb, the edge of a hole, or other low fixed object that causes a sudden deceleration in the vehicle chassis. Since the impact is underneath the vehicle, damage may not be readily apparent.

### ■ When front airbags may not deploy, even though exterior damage appears severe

Since crushable body parts absorb crash energy during an impact, the amount of visible damage does not always indicate proper airbag operation. In fact, some collisions can result in severe damage but no airbag deployment because the airbags would not have been needed or would not have provided protection even if they had deployed.

## Advanced Airbags

The airbags have advanced features to help reduce the likelihood of airbag related injuries to smaller occupants.

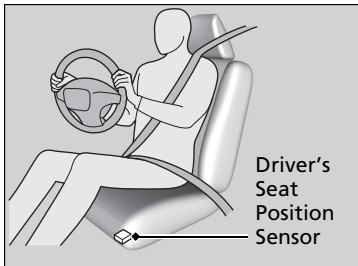

The driver's advanced airbag system includes a seat position sensor.

Based on information from this sensor and the severity of the impact, the advanced airbag system determines the optimal deployment of the driver's airbag.

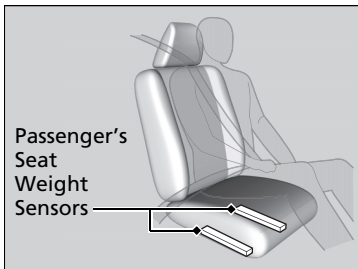

The front passenger's advanced airbag system has weight sensors.

We advise against allowing a child age 12 or under to ride in the front passenger's seat. However, **if you do allow a child age 12 or under to ride in the front passenger's seat**, note that the system will automatically turn off the front passenger's airbag if the sensors detect that the child is approximately 65 lbs (29 kg) or less.

## Advanced Airbags

If there is a problem with the driver's seat position sensor, the SRS indicator will come on, and in the event of a crash, the airbag will deploy (regardless of the driver's seating position) with a force corresponding to the severity of the impact.

For the advanced airbags to work properly:

- Do not spill any liquid on or under the seats.
- Do not put any object under the passenger's seat.
- Make sure any objects are positioned properly on the floor. Improperly positioned objects can interfere with the advanced airbag sensors.
- All occupants should sit upright and wear their seat belts properly.
- Do not cover the passenger's side dashboard with a cloth, towel, cover, etc.

▶ **Passenger Front Airbag Off Indicator**  
P. 58

## Side Airbags

The side airbags help protect the torso and pelvis of the driver or a front passenger during a moderate-to-severe side impact.

### Housing Locations

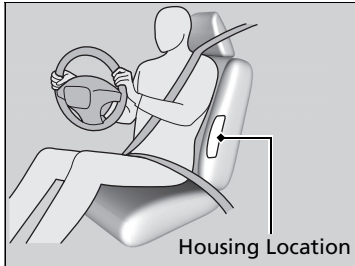

The side airbags are housed in the outside edge of the driver's and passenger's seat-backs.

Both are marked **SIDE AIRBAG**.

### Operation

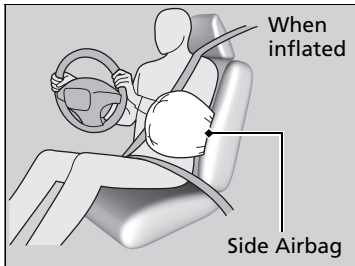

When the sensors detect a moderate-to-severe side impact, the control unit signals the side airbag on the impact side to immediately inflate.

### Side Airbags

Make sure you and your front seat passenger always sit upright. Leaning into the path of a side airbag can prevent the airbag from deploying properly and increases your risk of serious injury.

Do not attach accessories on or near the side airbags. They can interfere with the proper operation of the airbags, or hurt someone if an airbag inflates.

Do not cover or replace the front seat-back covers without consulting a dealer. Improperly replacing or covering front seat-back covers can prevent your side airbags from properly deploying during a side impact.

■ **When a side airbag deploys with little or no visible damage**

Because the airbag system senses sudden acceleration, a strong impact to the side of the vehicle's framework can cause a side airbag to deploy. In such cases, there may be little or no damage, but the side impact sensors detected a severe enough impact to deploy the airbag.

■ **When a side airbag may not deploy, even though visible damage appears severe**

It is possible for a side airbag to not deploy during an impact that results in apparently severe damage. This can occur when the point of impact was toward the far front or rear of the vehicle, or when the vehicle's crushable body parts absorbed most of the crash energy. In either case, the side airbag would not have been needed nor provided protection even if it had deployed.

## Side Curtain Airbags

The side curtain airbags help protect the heads of the driver and passengers in the outer seating positions during a moderate-to-severe side impact. The side curtain airbags equipped in this vehicle are also designed to help reduce the likelihood of partial and complete ejection of vehicle occupants through side windows in crashes, particularly rollover crashes.

### ■ Housing Locations

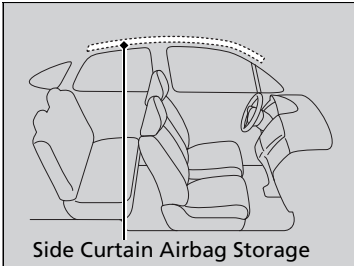

The side curtain airbags are located in the ceiling above the side windows on both sides of the vehicle.

### ▶▶ Side Curtain Airbags

If the SRS control unit senses that your vehicle is about to rollover, it immediately deploys both side curtain airbags and activates both front seat belt tensioners.

If the impact is on the passenger's side, the passenger's side curtain airbag deploys even if there are no occupants on that side of the vehicle.

## ■ Operation

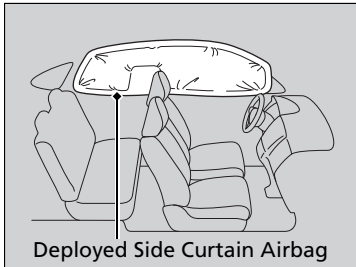

The side curtain airbag is designed to deploy in a rollover or a moderate-to-severe side impact.

### ■ When side curtain airbags deploy in a frontal collision

One or both side curtain airbags may also inflate in a moderate-to-severe angled frontal collision.

## ▶ Side Curtain Airbags

To get the best protection from the side curtain airbags, occupants should wear their seat belts properly and sit upright and well back in their seats.

Do not attach any objects to the side windows or roof pillars as they can interfere with the proper operation of the side curtain airbags.



## Airbag System Indicators

If a problem occurs in the airbag system, the SRS indicator will come on and a message appears on the multi-information display\*.

### Supplemental Restraint System (SRS) Indicator

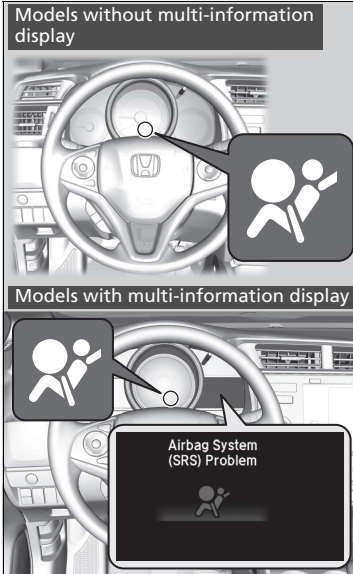

#### ■ When the ignition switch is turned on **ON II**\*1

The indicator comes on for a few seconds, then goes off. This tells you the system is working properly.

If the indicator comes on at any other time, or does not come on at all, have the system checked by a dealer as soon as possible. If you don't, your airbags and seat belt tensioners may not work properly when they are needed.

\*1: Models with the smart entry system have an **ENGINE START/STOP** button instead of an ignition switch.

\* Not available on all models

*Continued*

### Supplemental Restraint System (SRS) Indicator

#### **WARNING**

Ignoring the SRS indicator can result in serious injury or death if the airbag systems or tensioners do not work properly.

Have your vehicle checked by a dealer as soon as possible if the SRS indicator alerts you to a possible problem.

## ■ Passenger Front Airbag Off Indicator

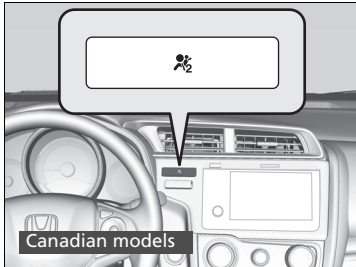
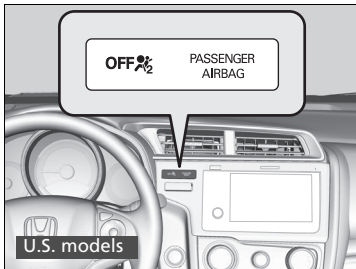

### ■ When the passenger airbag off indicator comes on

The indicator comes on to alert you that the passenger's front airbag has been turned off. This occurs when the front passenger's weight sensors detect 65 lbs (29 kg) or less, the weight of an infant or small child, on the seat.

Children **age 12 or under** should always ride properly restrained in a back seat.

➤ **Child Safety** P. 60

Objects placed on the seat can also cause the indicator to come on.

If the front passenger seat is empty, the passenger's front airbag will not deploy and the indicator will not come on.

## ☒ Supplemental Restraint System (SRS) Indicator

If the indicator comes on with no front passenger and no objects on the passenger's seat, or with an adult riding there, something may be interfering with the weight sensors, such as:

- An object hanging on the seat or in the seat-back pocket.
- A child seat or other object pressing against the rear of the seat-back.
- A rear passenger pushing or pulling on the back of the front passenger's seat.
- The front seat or seat-back is forced back against an object on the seat or floor behind it.
- An object placed under the front passenger's seat.

If none of these conditions exist, have your vehicle checked by a dealer as soon as possible.

The passenger airbag off indicator may come on and go off repeatedly if the total weight on the seat is near the airbag cutoff threshold.

## Airbag Care

---

You do not need to, and should not, perform any maintenance on or replace any airbag system components yourself. However, you should have your vehicle inspected by a dealer in the following situations:

### ■ When the airbags have deployed

If an airbag has inflated, the control unit and other related parts must be replaced. Similarly, once an automatic seat belt tensioner has been activated, it must be replaced.

### ■ When the vehicle has been in a moderate-to-severe collision

Even if the airbags did not inflate, have your dealer inspect the following: the driver's seat position sensor, weight sensors in the passenger's seat, front seat belt tensioners, and each seat belt that was worn during the crash.

### ■ Do not remove or modify a front seat without consulting a dealer

This would likely disable or affect the proper operation of the driver's seat position sensor or the weight sensors in the passenger's seat. If it is necessary to remove or modify a front seat to accommodate a person with disabilities, contact a Honda dealer, or for U.S. vehicles, American Honda Automobile Customer Service at 1-800-999-1009 and for Canadian vehicles, Honda Canada Customer Relations at 1-888-9-HONDA-9.

#### ✘ Airbag Care

We recommend against the use of salvaged airbag system components, including the airbag, tensioners, sensors, and control unit.

## Protecting Child Passengers

Each year, many children are injured or killed in vehicle crashes because they are either unrestrained or not properly restrained. In fact, vehicle crashes are the number one cause of death of children ages 12 and under.

To reduce the number of child deaths and injuries, every state, Canadian province and territory requires that infants and children be properly restrained when they ride in a vehicle.

**Children should sit properly restrained in a rear seat.** This is because:

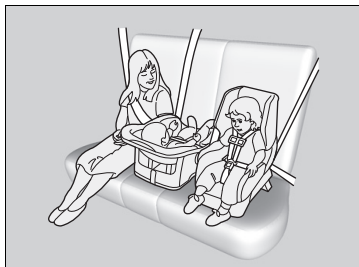

- An inflating front or side airbag can injure or kill a child sitting in the front seat.
- A child in the front seat is more likely to interfere with the driver's ability to safely control the vehicle.
- Statistics show that children of all sizes and ages are safer when they are properly restrained in a rear seat.

### Protecting Child Passengers

#### **WARNING**

**Children who are unrestrained or improperly restrained can be seriously injured or killed in a crash.**

**Any child too small for a seat belt should be properly restrained in a child seat. A larger child should be properly restrained with a seat belt, using a booster seat if necessary.**

The National Highway Traffic Safety Administration and Transport Canada recommend that all children ages 12 and under be properly restrained in a rear seat. Some states or provinces/territories have laws restricting where children may ride.

- Any child who is too small to wear a seat belt correctly must be restrained in an approved child seat that is properly secured to the vehicle using either seat belt or the lower anchors of the LATCH system.
- Never hold a child on your lap because it is impossible to protect them in the event of a collision.
- Never put a seat belt over yourself and a child. During a crash, the belt would likely press deep into the child and cause serious or fatal injuries.
- Never let two children use the same seat belt. Both children could be very seriously injured in a crash.
- Do not allow children to operate the doors, windows or seat adjustments.
- Do not leave children in the vehicle unattended, especially in hot weather when the inside of the vehicle can get hot enough to kill them. They could also activate vehicle controls causing it to move unexpectedly.

## ▶▶ Protecting Child Passengers

**⚠ WARNING**

Allowing a child to play with a seat belt or wrap one around their neck can result in serious injury or death.

**Instruct children not to play with any seat belt and make sure any unused seat belt a child can reach is buckled, fully retracted, and locked.**

To deactivate a lockable retractor, release the buckle and allow the seat belt to wind up all the way.

To remind you of the passenger's front airbag hazards and child safety, your vehicle has warning labels on the dashboard (U.S. models) and on the front visors. Please read and follow the instructions on these labels.

▶▶ **Safety Labels** P. 74

## Safety of Infants and Small Children

### ■ Protecting Infants

An infant must be properly restrained in a rear-facing, reclining child seat until the infant reaches the seat manufacturer's weight or height limit for the seat, and the infant is at least one year old. Many experts recommend use of a rear-facing seat for a child up to two years old if the child's height and weight are appropriate for a rear-facing seat.

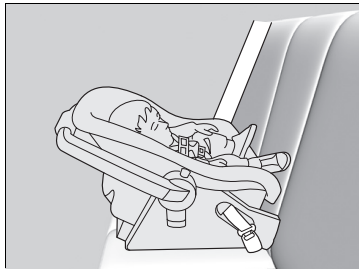

### ■ Positioning a rear-facing child seat

Child seats must be placed and secured in a rear seating position.

When properly installed, a rear-facing child seat may prevent the driver or a front passenger from moving their seat all the way back, or from locking their seat-back in the desired position. Make sure that there is no contact between the child seat and the seat in front of it.

It can also interfere with proper operation of the passenger's advanced front airbag system.

➤ **Airbags** P. 46

If this occurs, we recommend that you install the child seat directly behind the front passenger's seat, move the seat as far forward as needed, and leave it unoccupied. Or, you may wish to get a smaller rear-facing child seat.

### ▶▶ Protecting Infants

## ⚠ WARNING

Placing a rear-facing child seat in the front seat can result in serious injury or death during a crash.

Always place a rear-facing child seat in the rear seat, not the front.

Many experts recommend use of a rear-facing seat for a child up to two years old if the child's height and weight are appropriate for a rear-facing seat.

Rear-facing child seats should never be installed in a forward facing position.

Always refer to the child seat manufacturer's instructions before installation.

Do not allow a front seat to rest against a child seat installed in a rear seating position:  
The weight sensor in the front seat may not correctly detect the actual weight of the occupant.

## ■ Protecting Smaller Children

If a child is at least one year old and has exceeded the weight and height limitations of a rearward facing child seat, the child should be properly restrained in a firmly secured forward facing child seat until they exceed the weight and height limitations for the forward facing child seat.

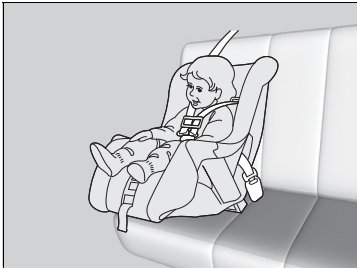

### ■ Forward-facing child seat placement

We strongly recommend placing a forward-facing child seat in a rear seating position.

Placing a forward-facing child seat in the front seat can be hazardous, even with advanced front airbags that automatically turn the passenger's front airbag off. A rear seat is the safest place for a child.

## ⌘ Protecting Smaller Children

### ⚠ WARNING

Placing a forward-facing child seat in the front seat can result in serious injury or death if the front airbag inflates.

If you must place a forward-facing child seat in front, move the vehicle seat as far back as possible, and properly restrain the child.

Educate yourself about the laws and regulations regarding child seat use where you are driving, and follow the child seat manufacturer's instructions.

## ■ Selecting a Child Seat

Most child seats are LATCH-compatible (Lower Anchors and Tethers for Children). Some have a rigid-type connector, while others have a flexible-type connector. Both are equally easy to use. Some existing and previously owned child seats can only be installed using the seat belt. Whichever type you choose, follow the child seat manufacturer's use and care instructions as well as the instructions in this manual. Proper installation is key to maximizing your child's safety.

In seating positions and vehicles not equipped with LATCH, a LATCH compatible child seat can be installed using the seat belt and a top tether for added security. This is because all child seats are required to be designed so that they can be secured with a lap belt or the lap part of a lap/shoulder belt. In addition, the child seat manufacturer may advise that a seat belt be used to attach a LATCH-compatible seat once a child reaches a specified weight. Please read the child seat owner's manual for proper installation instructions.

### ■ Important consideration when selecting a child seat

Make sure the child seat meets the following three requirements:

- The child seat is the correct type and size for the child.
- The child seat is the correct type for the seating position.
- The child seat is compliant with Federal Motor Vehicle Safety Standard 213 or Canadian Motor Vehicle Safety Standard 213.

## ▶▶ Selecting a Child Seat

Installation of a LATCH-compatible child seat is simple.

LATCH-compatible child seats have been developed to simplify the installation process and reduce the likelihood of injuries caused by incorrect installation.



## ■ Installing a LATCH-Compatible Child Seat

A LATCH-compatible child seat can be installed in either of the two outer rear seats. A child seat is attached to the lower anchors with either the rigid or flexible type of connectors.



1. Locate the lower anchors under the marks.
2. Raise the head restraint to its highest position.

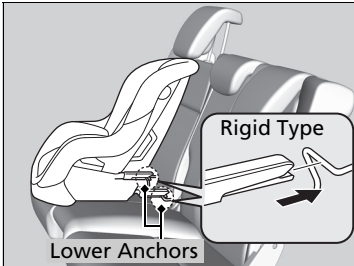

3. Place the child seat on the vehicle seat, then attach the child seat to the lower anchors according to the instructions that came with the child seat.
  - ▶ When installing the child seat, make sure that the lower anchors are not obstructed by the seat belt or any other object.

## ▶▶ Installing a LATCH-Compatible Child Seat

### ⚠ WARNING

**Never attach two child seats to the same anchor. In a collision, one anchor may not be strong enough to hold two child seat attachments and may break, causing serious injury or death.**

For your child's safety, when using a child seat installed using the LATCH system, make sure that the child seat is properly secured to the vehicle. A child seat that is not properly secured will not adequately protect a child in a crash and may cause injury to the child or other vehicle occupants.

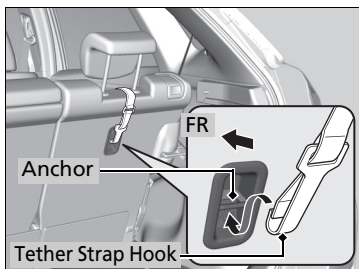
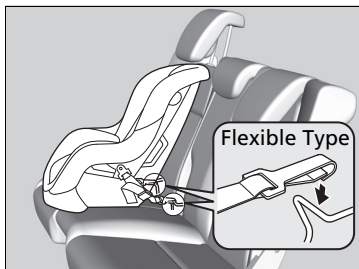

4. Remove the cargo area cover\*.
  - ▶ **Cargo Area Cover\*** P. 195
5. Route the tether strap between the head restraint legs, and secure the tether strap hook onto the anchor. Make sure the strap is not twisted.
6. Tighten the tether strap as instructed by the child seat manufacturer.
7. Make sure the child seat is firmly secured by rocking it forward and back and side to side; little movement should be felt.
8. Make sure any unused seat belt that a child can reach is buckled, the lockable retractor is activated, and the belt is fully retracted and locked.
9. Reinstall the cargo area cover.

▶▶ Installing a LATCH-Compatible Child Seat

**⚠ WARNING**

Do not use the lower inner anchors of the outer rear seats to secure a LATCH-compatible child seat to the rear center seat, unless the manufacturer's instructions for that system permit the use of inner anchors with the stated spacing.

**Installing a LATCH-compatible child seat in the rear center seat**

Each outer rear seat is equipped with a pair of lower anchors which are used to secure a LATCH-compatible child seat. The rear center seat, however, is not equipped with anchors of any kind.

The inner and outer anchors are spaced apart at a standard distance of 11 inches (280 mm). The distance between the two inner anchors is 14.1 inches (357.8 mm).

LATCH-compatible restraint systems that are fitted with rigid-type attachments cannot be installed in the rear center seat. However, a system fitted with flexible-type attachments can be installed in the center seat, provided that the manufacturer's instructions for that system permit the use of the inner anchors with the stated spacing.

Before seating a child, make sure that the system is properly attached to both the lower anchors and tether anchors.

## ■ Installing a Child Seat with a Lap/Shoulder Seat Belt

A child seat can be installed with a lap/shoulder belt in any rear seat or, if absolutely necessary, the front passenger seat.

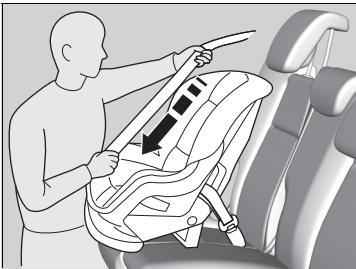

1. Raise the head restraint to its highest position.
2. Place the child seat on the vehicle seat.
3. Route the seat belt through the child seat according to the seat manufacturer's instructions, and insert the latch plate into the buckle.
  - ▶ Insert the latch plate fully until it clicks.
4. Slowly pull the shoulder part of the belt all the way out until it stops. This activates the lockable retractor.
5. Let the seat belt completely wind up into the retractor, then try to pull it out to make sure the retractor is locked.
  - ▶ If you are able to pull the shoulder belt out, the lockable retractor is not activated. Pull the seat belt all the way out, and repeat steps 4 – 5.

### ⊠ Installing a Child Seat with a Lap/Shoulder Seat Belt

A child seat that is not properly secured will not adequately protect a child in a crash and may cause injury to the child or other vehicle occupants.

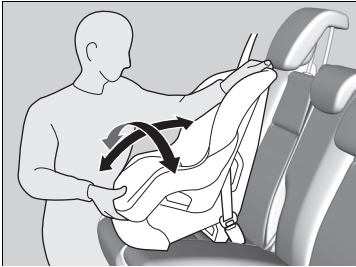

**6.** Grab the shoulder part of the seat belt near the buckle, and pull up to remove any slack from the lap part of the belt.

▶ When doing this, place your weight on the child seat and push it into the vehicle seat.

**7.** Make sure the child seat is firmly secured by rocking it forward and back and side to side; less than one inch of movement should occur near the seat belt.

**8.** Make sure any unused seat belt that a child can reach is buckled, the lockable retractor is activated, and the belt is fully retracted and locked.

▶▶ Installing a Child Seat with a Lap/Shoulder Seat Belt

To deactivate a lockable retractor, release the buckle and allow the seat belt to wind up all the way.

## ■ Adding Security with a Tether

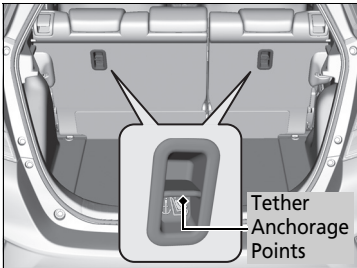

A tether anchorage point is provided behind each rear seating position. If you have a child restraint system that comes with a tether but can be installed with a seat belt, the tether may be used for additional security.



## ▣ Adding Security with a Tether

Always use a tether for forward facing child seats when using the seat belt or lower anchors.

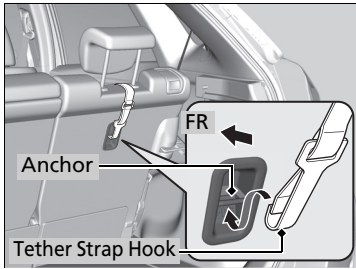

### ■ Using an outer anchor

1. Remove the cargo area cover\*.  
    ❑ **Cargo Area Cover\*** P. 195
2. Put the outer head restraint to its upper most position, then route the tether strap between the head restraint legs, and secure the tether strap hook onto the anchor. Make sure the strap is not twisted.
3. Secure the tether strap hook to the anchorage.
4. Tighten the tether strap as instructed by the child seat manufacturer.
5. Reinstall the luggage area cover.

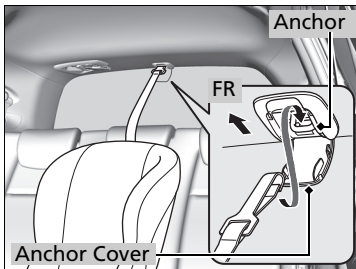

### ■ Using the center anchor

1. Lower the head restraint to its lowest position.
2. Open the anchor cover.
3. Route the tether strap over the head restraint. Make sure the strap is not twisted.
4. Secure the tether strap hook to the anchor.
5. Tighten the tether strap as instructed by the child seat manufacturer.

## Safety of Larger Children

### ■ Protecting Larger Children

The following pages give instructions on how to check proper seat belt fit, what kind of booster seat to use if one is needed, and important precautions for a child who must sit in front.

### ■ Checking Seat Belt Fit

When a child is too big for a child seat, secure the child in a rear seat using the lap/shoulder seat belt. Have the child sit upright and all the way back, then answer the following questions.



#### ■ Checklist

- Do the child's knees bend comfortably over the edge of the seat?
- Does the shoulder belt cross between the child's neck and arm?
- Is the lap part of the seat belt as low as possible, touching the child's thighs?
- Will the child be able to stay seated like this for the whole trip?

If you answer yes to all these questions, the child is ready to wear the lap/shoulder seat belt correctly. If you answer no to any question, the child needs to ride on a booster seat until the seat belt fits properly without a booster seat.

### ▶▶ Safety of Larger Children

## ⚠ WARNING

Allowing a child age 12 or under to sit in front can result in injury or death if the passenger's front airbag inflates.

If a larger child must ride in front, move the vehicle seat as far to the rear as possible, have the child sit up properly and wear the seat belt properly, using a booster seat if needed.

## ■ Booster Seats



If a lap/shoulder seat belt cannot be used properly, position the child in a booster seat in the rear seat. For the child's safety, check that the child meets the booster seat manufacturer's recommendations.

## ■ Protecting Larger Children-Final Checks

Your vehicle has a rear seat where children can be properly restrained. If you ever have to carry a group of children, and a child must ride in front:

- Make sure you read and fully understand the instructions and safety information in this manual.
- Move the front passenger seat as far back as possible.
- Have the child sit upright and well back in the seat.
- Check that the seat belt is properly positioned so that the child is secure in the seat.

## ■ Monitoring child passengers

We strongly recommend that you keep an eye on child passengers. Even older, more mature children sometimes need to be reminded to fasten their seat belts and sit up properly.

## ▣ Booster Seats

When installing a booster seat, make sure to read the instructions that came with it, and install the seat accordingly.

There are high- and low-type booster seats. Choose a booster seat that allows the child to wear the seat belt correctly.

Some U.S. states and Canadian provinces and territories require children to use a booster seat until they reach a given age or weight (e.g. 6 years or 60 lbs). Be sure to check current laws in the state or province, or territory where you intend to drive.



## Carbon Monoxide Gas

The engine exhaust from this vehicle contains carbon monoxide, a colorless, odorless, and highly toxic gas. As long as you properly maintain your vehicle, carbon monoxide gas will not get into the interior.

### ■ Have the exhaust system inspected for leaks whenever

- The exhaust system is making an unusual noise.
- The exhaust system may have been damaged.
- The vehicle is raised for an oil change.

When you operate a vehicle with the tailgate open, airflow can pull exhaust gas into the interior and create a hazardous condition. If you must drive with the tailgate open, open all the windows and set the heating and cooling system\*/climate control system\* as shown below.

1. Select the fresh air mode.
2. Select the  mode.
3. Set the fan speed to high.
4. Set the temperature control to a comfortable setting.

Adjust the heating and cooling system\*/climate control system\* in the same manner if you sit in your parked vehicle with the engine running.

### Carbon Monoxide Gas

## ⚠ WARNING

Carbon monoxide gas is toxic. Breathing it can cause unconsciousness and even kill you.

Avoid any enclosed areas or activities that expose you to carbon monoxide.

An enclosed area such as a garage can quickly fill up with carbon monoxide gas. Do not run the engine with the garage door closed. Even when the garage door is open, drive out of the garage immediately after starting the engine.

\* Not available on all models

## Label Locations

These labels are in the locations shown. They warn you of potential hazards that can cause serious injury or death. Read these labels carefully.

If a label comes off or becomes hard to read (except for the U.S. dashboard label which may be removed by the owner), contact a dealer for a replacement.

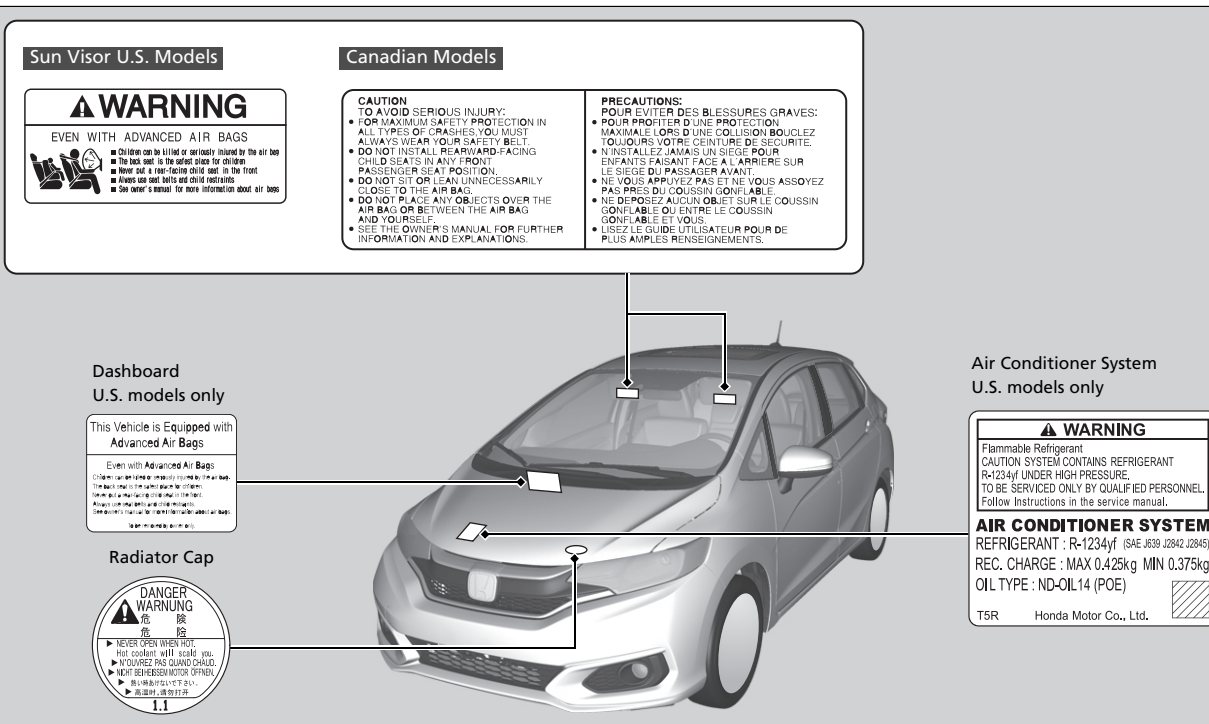





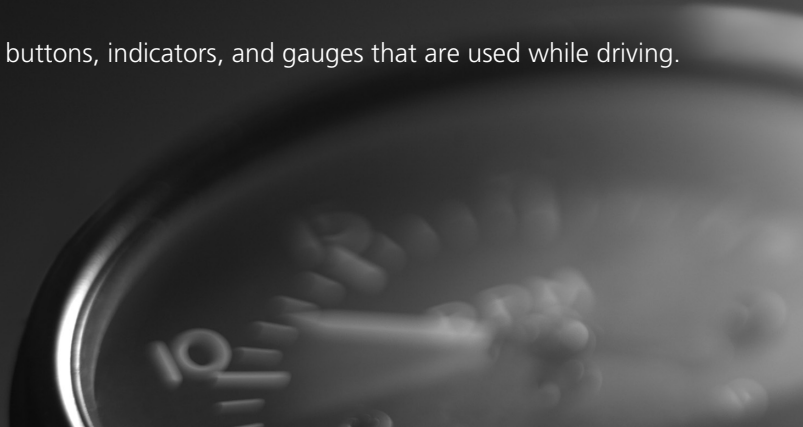



# Instrument Panel

This chapter describes the buttons, indicators, and gauges that are used while driving.



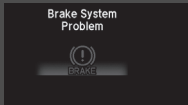



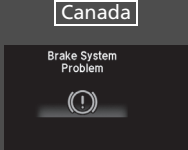

<b>Indicators</b> .....	76
Information Display Warning and Information Messages* .....	91
Multi-Information Display Warning and Information Messages* .....	92
<b>Gauges and Displays</b>	
Gauges .....	103
Information Display* .....	104
Multi-Information Display* .....	107

\* Not available on all models



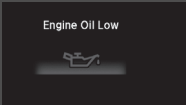



Indicator	Name	On/Blinking	Explanation	Message*
 <p>U.S. <b>BRAKE</b> Canada (Red)</p>	Parking Brake and Brake System Indicator (Red)	<ul style="list-style-type: none"> <li>Comes on for a few seconds when you turn the ignition switch to ON *1, then goes off if the parking brake has been released.</li> <li>Comes on when the parking brake is applied, and goes off when it is released.</li> <li>Comes on when the brake fluid level is low.</li> <li>Comes on if there is a problem with the brake system.</li> <li>The beeper sounds and the indicator comes on if you drive with the parking brake not fully released.</li> </ul>	<ul style="list-style-type: none"> <li><b>Comes on while driving</b> - Make sure the parking brake is released. Check the brake fluid level.                             <ul style="list-style-type: none"> <li>➤ <b>What to do when the indicator comes on while driving</b> P. 562</li> </ul> </li> <li><b>Comes on along with the ABS indicator</b> - Have your vehicle checked by a dealer.                             <ul style="list-style-type: none"> <li>➤ <b>If the Brake System Indicator (Red) Comes On</b> P. 562</li> </ul> </li> </ul>	  
 <p>U.S. <b>BRAKE SYSTEM</b> Canada (Amber)</p>	Brake System Indicator (Amber)	<ul style="list-style-type: none"> <li>Comes on for a few seconds when you turn the ignition switch to ON *1, then goes off.</li> <li>Comes on if there is a problem with a system related to braking other than the conventional brake system.</li> </ul>	<ul style="list-style-type: none"> <li><b>Stays on constantly</b> - Have your vehicle checked by a dealer.</li> </ul>	 

\*1: Models with the smart entry system have an **ENGINE START/STOP** button instead of an ignition switch.



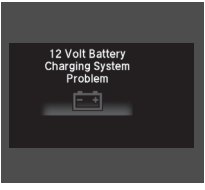

\* Not available on all models

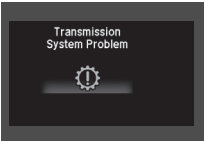
Indicator	Name	On/Blinking	Explanation	Message*
	Low Oil Pressure Indicator	<ul style="list-style-type: none"> <li>• Comes on when you turn the ignition switch to ON *1, and goes off when the engine starts.</li> <li>• Comes on when the engine oil pressure is low.</li> </ul>	<ul style="list-style-type: none"> <li>• <b>Comes on while driving</b> - Immediately stop in a safe place.                             <ul style="list-style-type: none"> <li>➤ <b>If the Low Oil Pressure Indicator Comes On</b> P. 560</li> </ul> </li> </ul>	
	Malfunction Indicator Lamp	<ul style="list-style-type: none"> <li>• Comes on when you turn the ignition switch to ON *1, and goes off either when the engine starts or after several seconds if the engine did not start. If "readiness codes" have not been set, it blinks five times before it goes off.</li> <li>• Comes on if there is a problem with the emissions control system.</li> <li>• Blinks when a misfire in the engine's cylinders is detected.</li> </ul>	<ul style="list-style-type: none"> <li>• Readiness codes are part of the on board diagnostics for the emissions control systems.                             <ul style="list-style-type: none"> <li>➤ <b>Testing of Readiness Codes</b> P. 580</li> </ul> </li> <li>• <b>Comes on while driving</b> - Have your vehicle checked by a dealer.</li> <li>• <b>Blinks while driving</b> - Stop in a safe place where there are no flammable objects. Stop the engine for 10 minutes or more, and wait for it to cool down. Then, take your vehicle to a dealer.                             <ul style="list-style-type: none"> <li>➤ <b>If the Malfunction Indicator Lamp Comes On or Blinks</b> P. 561</li> </ul> </li> </ul>	

\*1: Models with the smart entry system have an **ENGINE START/STOP** button instead of an ignition switch.









Indicator	Name	On/Blinking	Explanation	Message *
	Charging System Indicator	<ul style="list-style-type: none"> <li>Comes on when you turn the ignition switch to ON *<sup>1</sup>, and goes off when the engine starts.</li> <li>Comes on when the battery is not charging.</li> </ul>	<ul style="list-style-type: none"> <li><b>Comes on while driving</b> - Turn off the heating and cooling system*/climate control system* and rear defogger in order to reduce electricity consumption.                             <ul style="list-style-type: none"> <li>☒ <b>If the Charging System Indicator Comes On</b> P. 560</li> </ul> </li> </ul>	
	Shift Lever Position Indicator*	<ul style="list-style-type: none"> <li>Indicates the current shift lever position.</li> </ul>	<ul style="list-style-type: none"> <li>☒ <b>Shifting</b> P. 417, 419</li> </ul>	
	Transmission Indicator*	<ul style="list-style-type: none"> <li>Blinks if the transmission system has a problem.</li> </ul>	<ul style="list-style-type: none"> <li><b>Blinks while driving</b> - Avoid sudden starts and acceleration and have your vehicle checked by a dealer immediately.</li> </ul>	

\*1: Models with the smart entry system have an **ENGINE START/STOP** button instead of an ignition switch.

Indicator	Name	On/Blinking	Explanation	Message*
	<p><b>M</b> (7-speed manual shift mode) Indicator/Shift Indicator*</p>	<ul style="list-style-type: none"> <li>Comes on when 7-speed manual shift mode is applied.</li> </ul>	<p>► <b>7-Speed Manual Shift Mode</b> P. 421</p>	<p>—</p>
	<p>Seat Belt Reminder Indicator</p>	<ul style="list-style-type: none"> <li>Comes on and the beeper sounds if you are not wearing a seat belt when you turn the ignition switch to ON *1.</li> <li>If the front passenger is not wearing a seat belt, the indicator comes on a few seconds later.</li> <li>Blinks while driving if either you or the front passenger has not fastened a seat belt. The beeper sounds and the indicator blinks at regular intervals.</li> </ul>	<ul style="list-style-type: none"> <li>The beeper stops and the indicator goes off when you and the front passenger fasten their seat belts.</li> <li><b>Stays on after you or the front passenger has fastened the seat belt</b> - A detection error may have occurred in the sensor. Have your vehicle checked by a dealer.</li> </ul> <p>► <b>Seat Belt Reminder</b> P. 38</p>	 



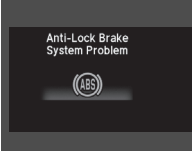

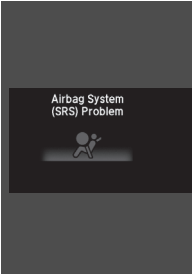



\*1: Models with the smart entry system have an **ENGINE START/STOP** button instead of an ignition switch.

\* Not available on all models







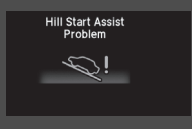

Indicator	Name	On/Blinking	Explanation	Message *
	Low Fuel Indicator*	<ul style="list-style-type: none"> <li>Comes on when the fuel reserve is running low (approximately 1.59 U.S. gal./6.0 Liter left).</li> <li>Blinks if there is a problem with the fuel gauge.</li> </ul>	<ul style="list-style-type: none"> <li><b>Comes on</b> - Refuel your vehicle as soon as possible.</li> <li><b>Blinks</b> - Have your vehicle checked by a dealer.</li> </ul>	 
	Anti-lock Brake System (ABS) Indicator	<ul style="list-style-type: none"> <li>Comes on for a few seconds when you turn the ignition switch to ON *1, then goes off.</li> <li>If it comes on at any other time, there is a problem with the ABS.</li> </ul>	<ul style="list-style-type: none"> <li><b>Stays on constantly</b> - Have your vehicle checked by a dealer. With this indicator on, your vehicle still has normal braking ability but no anti-lock function.   <b>Anti-lock Brake System (ABS)</b> P. 470</li> </ul>	
	Supplemental Restraint System Indicator	<ul style="list-style-type: none"> <li>Comes on for a few seconds when you turn the ignition switch to ON *1, then goes off.</li> <li>Comes on if a problem with any of the following is detected:                             <ul style="list-style-type: none"> <li>Supplemental restraint system</li> <li>Side airbag system</li> <li>Side curtain airbag system</li> <li>Seat belt tensioner</li> </ul> </li> </ul>	<ul style="list-style-type: none"> <li><b>Stays on constantly or does not come on at all</b> - Have your vehicle checked by a dealer.</li> </ul>	

\*1: Models with the smart entry system have an **ENGINE START/STOP** button instead of an ignition switch.







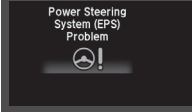

Indicator	Name	On/Blinking	Explanation	Message*
	High Temperature Indicator (Red)	<ul style="list-style-type: none"> <li>Comes on for a few seconds when you turn the ignition switch to ON <b>II</b>*1, then goes off.</li> <li>Blinks when the engine coolant temperature goes up, and stays on if the temperature continues to rise.</li> </ul>	<ul style="list-style-type: none"> <li>Goes off, then comes on blue when the engine coolant temperature is low.</li> <li><b>Blinks while driving</b> - Drive slowly to prevent overheating.</li> <li><b>Stays on while driving</b> - Immediately stop in a safe place and allow the engine to cool.   <b>Overheating</b> P. 558</li> </ul>	 
	Low Temperature Indicator (Blue)	<ul style="list-style-type: none"> <li>Comes on when the engine coolant temperature is low.</li> </ul>	<ul style="list-style-type: none"> <li>If the indicator stays on after the engine has reached normal operating temperature, there may be a problem with the temperature sensors. Have your vehicle inspected by a dealer.</li> </ul>	
	Vehicle Stability Assist® (VSA®) System Indicator	<ul style="list-style-type: none"> <li>Comes on for a few seconds when you turn the ignition switch to ON <b>II</b>*1, then goes off.</li> <li>Blinks when VSA® is active.</li> <li>Comes on if there is a problem with the VSA® system or hill start assist system.</li> </ul>	<ul style="list-style-type: none"> <li><b>Stays on constantly</b> - Have your vehicle checked by a dealer.   <b>Vehicle Stability Assist® (VSA®), aka Electronic Stability Control (ESC), System</b> P. 459</li> </ul>	 

\*1: Models with the smart entry system have an **ENGINE START/STOP** button instead of an ignition switch.





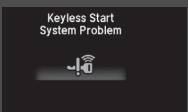





Indicator	Name	On/Blinking	Explanation	Message *
	Vehicle Stability Assist® (VSA®) <b>OFF</b> Indicator	<ul style="list-style-type: none"> <li>Comes on for a few seconds when you turn the ignition switch to ON *<sup>1</sup>, then goes off.</li> <li>Comes on when you deactivate VSA®.</li> </ul>	<ul style="list-style-type: none"> <li> <b>VSA® On and Off</b> P. 460</li> </ul>	—
	Door and Tailgate Open Indicator*	<ul style="list-style-type: none"> <li>Comes on for a few seconds if you turn the ignition switch to ON *<sup>1</sup>, then goes off.</li> <li>Comes on if any door or the tailgate is not completely closed.</li> <li>The beeper sounds and the indicator comes on if any door or the tailgate is opened while driving.</li> </ul>	<ul style="list-style-type: none"> <li>Goes off when all doors and the tailgate are closed.</li> </ul>	—
	Electric Power Steering (EPS) System Indicator	<ul style="list-style-type: none"> <li>Comes on when you turn the ignition switch to ON *<sup>1</sup>, and goes off when the engine starts.</li> <li>Comes on if there is a problem with the EPS system.</li> </ul>	<ul style="list-style-type: none"> <li><b>Stays on constantly or does not come on at all</b> - Have your vehicle checked by a dealer.</li> <li> <b>If the Electric Power Steering (EPS) System Indicator Comes On</b> P. 562</li> </ul>	

\*1:Models with the smart entry system have an **ENGINE START/STOP** button instead of an ignition switch.









Indicator	Name	On/Blinking	Explanation	Message*
	Low Tire Pressure/TPMS Indicator	<ul style="list-style-type: none"> <li>• Comes on for a few seconds when you turn the ignition switch to ON <sup>*1</sup>, then goes off.</li> <li>• May come on briefly if the ignition switch is turned to ON <sup>*1</sup> and the vehicle is not moved within 45 seconds, to indicate the calibration process is not yet complete.</li> <li>• Comes on and stays on when:                             <ul style="list-style-type: none"> <li>- One or more tires' pressures are determined to be significantly low.</li> <li>- The system has not been calibrated.</li> </ul> </li> </ul>	<ul style="list-style-type: none"> <li>• <b>Comes on while driving</b> - Stop in a safe place, check tire pressures, and inflate the tire(s) if necessary.</li> <li>• <b>Stays on after the tires are inflated to the recommended pressures</b> - The system needs to be calibrated.                             <ul style="list-style-type: none"> <li>➤ <b>TPMS Calibration</b> P. 463</li> </ul> </li> </ul>	
		<ul style="list-style-type: none"> <li>• Blinks for about one minute, and then stays on if there is a problem with the TPMS, or when a compact spare tire is temporarily installed.</li> </ul>	<ul style="list-style-type: none"> <li>• <b>Blinks and remains on</b> - Have your vehicle checked by a dealer. If the vehicle is fitted with a compact spare, get your regular tire repaired or replaced and put back on your vehicle as soon as you can.</li> </ul>	
	Smart Entry System Indicator*	<ul style="list-style-type: none"> <li>• Comes on for a few seconds when you change the power mode to ON.</li> <li>• Comes on as soon as a problem is detected in the smart entry system or push button starting system.</li> </ul>	<ul style="list-style-type: none"> <li>• <b>Stays on constantly or does not come on at all</b> - Have your vehicle checked by a dealer.</li> </ul>	

\*1: Models with the smart entry system have an **ENGINE START/STOP** button instead of an ignition switch.





\* Not available on all models





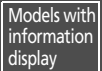

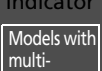
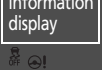

Indicator	Name	On/Blinking	Explanation	Message*
	System Message Indicator*	<ul style="list-style-type: none"> <li>Comes on for a few seconds when you turn the ignition switch to ON *<sup>1</sup>, then goes off.</li> <li>Comes on along with a beep when a problem is detected. A system message on the driver information interface appears at the same time.</li> </ul>	<ul style="list-style-type: none"> <li>While the indicator is on, press the /  (information) button to see the message again.</li> <li>Refer to the Indicators information in this chapter when a system message appears on the multi-information display. Take the appropriate action for the message.</li> <li>The multi-information display does not return to the normal screen unless the warning is canceled, or the /  button is pressed.</li> </ul>	—
	Turn Signal and Hazard Warning Indicators	<ul style="list-style-type: none"> <li>The turn signal indicators blink when you operate the turn signal lever.</li> <li>If you press the hazard warning button, both indicators and all turn signals blink at the same time.</li> </ul>	<ul style="list-style-type: none"> <li><b>Does not blink or blinks rapidly</b> - A turn signal light bulb has blown. Change the bulb immediately.   <b>Replacing Light Bulbs</b> P. 512, 515</li> </ul>	—
	High Beam Indicator	<ul style="list-style-type: none"> <li>Comes on when the high beam headlights are on.</li> </ul>	—	—
	Lights On Indicator	<ul style="list-style-type: none"> <li>Comes on whenever the light switch is on, or in <b>AUTO</b>* when the exterior lights are on.</li> </ul>	<ul style="list-style-type: none"> <li>If you remove the key from the ignition switch*, or set the power mode* to VEHICLE OFF (LOCK) while the exterior lights are on, a chime sounds when the driver's door is opened.</li> </ul>	—

\*1: Models with the smart entry system have an **ENGINE START/STOP** button instead of an ignition switch.







Indicator	Name	On/Blinking	Explanation	Message*
	Fog Light Indicator*	<ul style="list-style-type: none"> <li>Comes on when the fog lights are on.</li> </ul>	—	—
	Immobilizer System Indicator	<ul style="list-style-type: none"> <li>Comes on briefly when you turn the ignition switch to ON <sup>*1</sup>, then goes off.</li> <li>Comes on if the immobilizer system cannot recognize the key information.</li> </ul>	<ul style="list-style-type: none"> <li><b>Blinks -</b> <ul style="list-style-type: none"> <li><b>Models without smart entry system</b> You cannot start the engine. Turn the ignition switch to LOCK , pull the key out, and then insert the key and turn it to ON  again.</li> <li><b>Models with smart entry system</b> You cannot start the engine. Set the power mode to VEHICLE OFF (LOCK), then select the ON mode again.</li> </ul> </li> <li><b>Repeatedly blinks</b> - The system may be malfunctioning. Have the vehicle checked by a dealer.</li> <li>Do not attempt to alter this system or add other devices to it. Electrical problems can occur.</li> </ul>	—
	ECON Mode Indicator*	<ul style="list-style-type: none"> <li>Comes on for a few seconds when you turn the ignition switch to ON <sup>*1</sup>, then goes off.</li> <li>Comes on when you press the ECON button.</li> </ul>	 <b>ECON Button*</b> P. 427	

\*1: Models with the smart entry system have an **ENGINE START/STOP** button instead of an ignition switch.

Indicator	Name	On/Blinking	Explanation	Message *
 <p>Models with information display</p>  <p>Indicator</p>  <p>Models with multi-information display</p>  <p>Indicator</p>	<p>Security System Alarm Indicator</p>	<ul style="list-style-type: none"> <li>Blinks when the security system alarm has been set.</li> </ul>	<p>➤ <b>Security System Alarm</b> P. 148</p>	<p>—</p>
	<p><b>CRUISE MAIN</b> Indicator*</p>	<ul style="list-style-type: none"> <li>Comes on when you press the <b>CRUISE</b> button.</li> </ul>	<p>➤ <b>Cruise Control*</b> P. 428</p>	<p>—</p>
	<p><b>CRUISE CONTROL</b> Indicator*</p>	<ul style="list-style-type: none"> <li>Comes on if you have set a speed for cruise control.</li> </ul>	<p>➤ <b>Cruise Control*</b> P. 428</p>	<p>—</p>



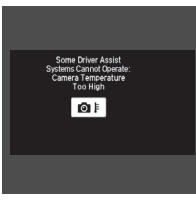

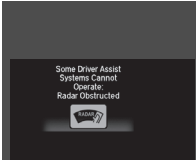



Indicator	Name	On/Blinking	Explanation	Message*
	Shift Up Indicator*	<ul style="list-style-type: none"> <li>• Comes on briefly when you turn the ignition switch to ON *<sup>1</sup>.</li> <li>• Comes on when shifting up is recommended.</li> </ul>	<ul style="list-style-type: none"> <li>▶ <b>Shift Up/Down Indicators*</b> P. 426</li> </ul>	—
	Shift Down Indicator*	<ul style="list-style-type: none"> <li>• Comes on briefly when you turn the ignition switch to ON *<sup>1</sup>.</li> <li>• Comes on when shifting down is recommended.</li> </ul>		
	Washer Level Indicator*	<ul style="list-style-type: none"> <li>• Comes on when the washer fluid is low.</li> </ul>	<ul style="list-style-type: none"> <li>• Refill washer fluid.</li> <li>▶ <b>Refilling Window Washer Fluid</b> P. 510</li> </ul>	—
	Maintenance Minder Indicator*	<ul style="list-style-type: none"> <li>• Comes on when the scheduled maintenance is due soon.</li> </ul>	<ul style="list-style-type: none"> <li>▶ <b>Maintenance Minder™</b> P. 491</li> </ul>	—
	Auto High-Beam Indicator*	<ul style="list-style-type: none"> <li>• Comes on for a few seconds when you turn the ignition switch to ON *<sup>1</sup>, then goes off.</li> <li>• Comes on when all the operating conditions of the auto high-beam are met.</li> </ul>	<ul style="list-style-type: none"> <li>▶ <b>Auto High-Beam*</b> P. 164</li> </ul>	—

\*1: Models with the smart entry system have an **ENGINE START/STOP** button instead of an ignition switch.











Indicator	Name	On/Blinking	Explanation	Message *
	Road Departure Mitigation (RDM) Indicator*	<ul style="list-style-type: none"> <li>• Comes on for a few seconds when you turn the ignition switch to ON *1, then goes off.</li> <li>• Comes on if there is a problem with the RDM system.</li> </ul>	<ul style="list-style-type: none"> <li>• <b>Stays on constantly</b> - Have your vehicle checked by a dealer.</li> </ul>	
		<ul style="list-style-type: none"> <li>• Comes on when the RDM system shuts itself off.</li> </ul>	<ul style="list-style-type: none"> <li>• <b>Stays on</b> - The temperature inside the camera is too high. Use the climate control system to cool down the camera. The system activates when the temperature inside the camera cools down.   <b>Front Sensor Camera*</b> P. 431</li> </ul>	
		<ul style="list-style-type: none"> <li>• Comes on if anything covers the radar sensor cover and prevents the sensor from detecting a vehicle in front.</li> <li>• May come on when driving in bad weather (rain, snow, fog, etc.)</li> <li>• LKAS has been automatically canceled.</li> </ul>	<ul style="list-style-type: none"> <li>• <b>Stays on</b> - The area around the camera is blocked by dirt, mud, etc. Stop your vehicle in a safe place, and wipe it off with a soft cloth.</li> <li>• Have your vehicle checked by a dealer if the indicator and message come back on after you cleaned the area around the camera.   <b>Front Sensor Camera*</b> P. 431</li> </ul>	 

\*1: Models with the smart entry system have an **ENGINE START/STOP** button instead of an ignition switch.



Indicator	Name	On/Blinking	Explanation	Message*
<b>ACC</b>	Adaptive Cruise Control ( <b>ACC</b> ) Indicator (Amber)*	<ul style="list-style-type: none"> <li>Comes on for a few seconds when you turn the ignition switch to ON *1, then goes off.</li> <li>Comes on if there is a problem with ACC.</li> </ul>	<ul style="list-style-type: none"> <li><b>Comes on while driving</b> - Have your vehicle checked by a dealer.</li> </ul>	
<b>ACC</b>	Adaptive Cruise Control ( <b>ACC</b> ) Indicator (Green)*	<ul style="list-style-type: none"> <li>Comes on when you press the <b>MAIN</b> button.</li> </ul>	<ul style="list-style-type: none"> <li> <b>Adaptive Cruise Control (ACC)*</b> P. 433</li> </ul>	
<b>LKAS</b>	Lane Keeping Assist System ( <b>LKAS</b> ) Indicator (Amber)*	<ul style="list-style-type: none"> <li>Comes on for a few seconds when you turn the ignition switch to ON *1, then goes off.</li> <li>Comes on if there is a problem with the LKAS.</li> </ul>	<ul style="list-style-type: none"> <li><b>Stays on constantly</b> - Have your vehicle checked by a dealer.</li> </ul>	
<b>LKAS</b>	Lane Keeping Assist System ( <b>LKAS</b> ) Indicator (Green)*	<ul style="list-style-type: none"> <li>Comes on when you press the <b>MAIN</b> button.</li> </ul>	<ul style="list-style-type: none"> <li> <b>Lane Keeping Assist System (LKAS)*</b> P. 452</li> </ul>	

\*1: Models with the smart entry system have an **ENGINE START/STOP** button instead of an ignition switch.

Indicator	Name	On/Blinking	Explanation	Message *
	Collision Mitigation Braking System™ (CMBS™) Indicator*	<ul style="list-style-type: none"> <li>• Comes on for a few seconds when you turn the ignition switch to ON *<sup>1</sup>, then goes off.</li> <li>• Comes on when you deactivate the CMBS™. A multi-information display message appears for five seconds.</li> <li>• Comes on if there is a problem with the CMBS™.</li> </ul>	<ul style="list-style-type: none"> <li>• <b>Stays on constantly without the CMBS™ off</b> - Have your vehicle checked by a dealer.   <b>Collision Mitigation Braking System™ (CMBS™)</b>* P. 472</li> </ul>	 
		<ul style="list-style-type: none"> <li>• Comes on when the CMBS™ system shuts itself off.</li> </ul>	<ul style="list-style-type: none"> <li>• <b>Stays on</b> - The area around the camera is blocked by dirt, mud, etc. Stop your vehicle in a safe place, and wipe it off with a soft cloth.   <b>Front Sensor Camera</b>* P. 431</li> </ul>	
			<ul style="list-style-type: none"> <li>• When the radar sensor gets dirty, stop your vehicle in a safe place, and wipe off dirt using a soft cloth.</li> <li>• Have your vehicle checked by a dealer if the message does not disappear even after you clean the sensor cover.   <b>Collision Mitigation Braking System™ (CMBS™)</b>* P. 472</li> </ul>	
			<ul style="list-style-type: none"> <li>• <b>Stays on</b> - The temperature inside the camera is too high. Use the climate control system to cool down the camera. The system activates when the temperature inside the camera cools down.   <b>Front Sensor Camera</b>* P. 431</li> </ul>	

\*1: Models with the smart entry system have an **ENGINE START/STOP** button instead of an ignition switch.

## Information Display Warning and Information Messages\*



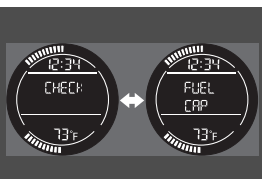
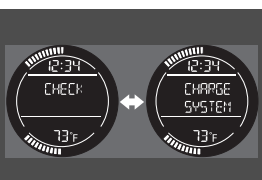





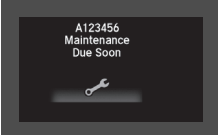

The following messages appear only on the information display.

Message	Condition	Explanation
	<ul style="list-style-type: none"> <li>• Appears when the fuel fill cap is loose or is not installed.</li> </ul>	<p>➔ <b>Check/Tighten Fuel Cap Message</b> P. 561</p>
	<ul style="list-style-type: none"> <li>• Appears when there is a problem with the sensor on the battery.</li> </ul>	<ul style="list-style-type: none"> <li>• <b>Stays on constantly</b> - Have your vehicle checked by a dealer.</li> </ul>

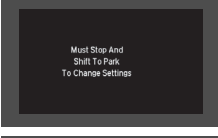

\* Not available on all models

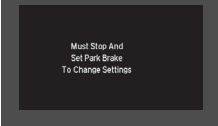
## Multi-Information Display Warning and Information Messages\*



The following messages appear only on the multi-information display. Press the  (information) button to see the message again with the system message indicator on.

Message	Condition	Explanation
	<ul style="list-style-type: none"> <li>Appears when the fuel fill cap is loose or is not installed.</li> </ul>	 <b>Check/Tighten Fuel Cap Message</b> P. 561
	<ul style="list-style-type: none"> <li>Appears when the scheduled maintenance is due soon.               <ul style="list-style-type: none"> <li>▶ Consequently, <b>Maintenance Due Now</b> and <b>Maintenance Past Due</b> follow.</li> </ul> </li> </ul>	 <b>Maintenance Minder Messages on the Multi-Information Display</b> P. 496
	<ul style="list-style-type: none"> <li>Appears when the engine coolant temperature gets abnormally high.</li> </ul>	 <b>Overheating</b> P. 558
	<p><b>Continuously variable transmission models</b></p> <ul style="list-style-type: none"> <li>Appears while you are customizing the settings and the shift lever is moved out of <b>P</b>.</li> </ul>	 <b>Customized Features</b> P. 111
	<p><b>Manual transmission models</b></p> <ul style="list-style-type: none"> <li>Appears while you are customizing the settings and the parking brake is released.</li> </ul>	 <b>Customized Features</b> P. 111

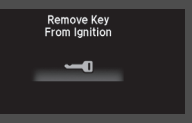
**Models without smart entry system**

Message	Condition	Explanation
	<ul style="list-style-type: none"> <li>Appears when the ignition key is turned to ACCESSORY <b>I</b> from ON <b>II</b>. (The driver's door is closed.)</li> </ul>	—
	<ul style="list-style-type: none"> <li>Appears when you open the driver's door while the ignition key is in ACCESSORY <b>I</b>.</li> </ul>	<ul style="list-style-type: none"> <li>Turn the ignition switch to LOCK <b>0</b>, then remove the key.</li> </ul>
	<ul style="list-style-type: none"> <li>Appears when you open the driver's door while the ignition key is in LOCK <b>0</b>.</li> </ul>	<ul style="list-style-type: none"> <li>Remove the key from the ignition switch.</li> </ul>



**Models with smart entry system**



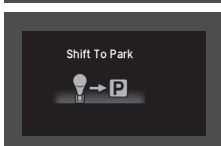
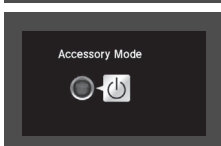
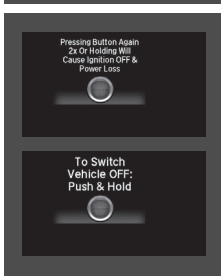

Message	Condition	Explanation
 	<ul style="list-style-type: none"> <li>Appears after you unlock and open the driver's door.</li> </ul>	<p><b>➤ Starting the Engine P. 411</b></p>

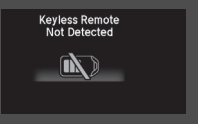
Models with smart entry system

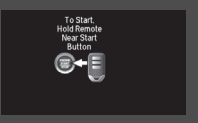

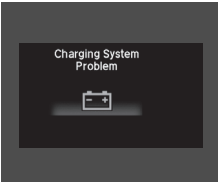

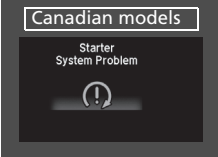
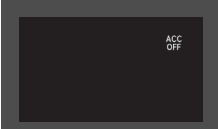
Message	Condition	Explanation
	<ul style="list-style-type: none"> <li>Appears when the steering wheel is locked.</li> </ul>	<ul style="list-style-type: none"> <li>Move the steering wheel left and right while pressing the <b>ENGINE START/STOP</b> button.</li> </ul>
	<ul style="list-style-type: none"> <li>Appears if you push the <b>ENGINE START/STOP</b> button to turn the engine off without the shift lever in <b>P</b>.</li> </ul>	<ul style="list-style-type: none"> <li>Move the shift lever to <b>P</b>. The power mode changes to VEHICLE OFF.</li> </ul>
	<ul style="list-style-type: none"> <li>Appears when the power mode is in ACCESSORY.</li> </ul>	<p style="text-align: center;">—</p>
	<ul style="list-style-type: none"> <li>Appears when you set the power mode to ON while driving.</li> </ul>	<p style="text-align: center;">➤ <b>Emergency Engine Stop</b> P. 554</p>

Models with smart entry system



Message	Condition	Explanation
	<ul style="list-style-type: none"> <li>Appears after the driver's door is opened when the power mode is in ACCESSORY.</li> </ul>	<ul style="list-style-type: none"> <li>Press the <b>ENGINE START/STOP</b> button twice with your foot off the brake pedal and clutch pedal (manual transmission only), to change the power mode to VEHICLE OFF (LOCK).</li> </ul>
	<ul style="list-style-type: none"> <li>Appears when you close the door with the power mode in ON without the smart entry remote inside the vehicle.</li> </ul>	<ul style="list-style-type: none"> <li>Goes off when you bring the smart entry remote back inside the vehicle and close the door.                             <ul style="list-style-type: none"> <li>➤ <b>Smart Entry Remote Reminder</b> P. 157</li> </ul> </li> </ul>
	<ul style="list-style-type: none"> <li>Appears when the smart entry remote battery becomes weak.</li> </ul>	<ul style="list-style-type: none"> <li>Replace the battery as soon as possible.                             <ul style="list-style-type: none"> <li>➤ <b>Replacing the Button Battery</b> P. 534</li> </ul> </li> </ul>
	<ul style="list-style-type: none"> <li>Appears if the smart entry remote battery is too weak to start the engine or the key is not within operating range to start the engine. A beeper sounds six times.</li> </ul>	<ul style="list-style-type: none"> <li>Bring the smart entry remote in front of the <b>ENGINE START/STOP</b> button to be touched with.                             <ul style="list-style-type: none"> <li>➤ <b>If the Smart Entry Remote Battery is Weak</b> P. 553</li> </ul> </li> </ul>



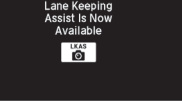

Message	Condition	Explanation
 <p>Charging System Problem</p>	<ul style="list-style-type: none"> <li>• Appears when there is a problem with the sensor on the battery.</li> <li>• Appears when the battery is not charging.</li> </ul>	<ul style="list-style-type: none"> <li>• Have your vehicle checked by a dealer.                             <ul style="list-style-type: none"> <li>➤ <b>Checking the Battery</b> P. 532</li> </ul> </li> <li>• <b>Appears along with the battery charging system indicator</b> - Turn off the climate control system and rear defogger to reduce electricity consumption.                             <ul style="list-style-type: none"> <li>➤ <b>If the Charging System Indicator Comes On</b> P. 560</li> </ul> </li> </ul>
<div style="border: 1px solid black; padding: 2px; margin-bottom: 5px;">U.S. models</div>  <p>Starter System Problem</p> <p>STARTER SYSTEM</p> <div style="border: 1px solid black; padding: 2px; margin-top: 5px;">Canadian models</div>  <p>Starter System Problem</p> <p>!</p>	<ul style="list-style-type: none"> <li>• Appears when the starter system has a problem.</li> </ul>	<ul style="list-style-type: none"> <li>• As a temporary measure, press and hold the <b>ENGINE START/STOP</b> button for up to 15 seconds while pressing the brake pedal and clutch pedal (manual transmission only), and manually start the engine. Have your vehicle checked by a dealer.</li> </ul>
 <p>ACC OFF</p>	<ul style="list-style-type: none"> <li>• Appears for about three seconds when ACC has been automatically canceled.</li> </ul>	<ul style="list-style-type: none"> <li>• You can resume the set speed after the condition that caused ACC to cancel improves. Press the <b>RES/+</b> button.                             <ul style="list-style-type: none"> <li>➤ <b>Adaptive Cruise Control (ACC)*</b> P. 433</li> </ul> </li> </ul>
 <p>BRAKE</p>	<ul style="list-style-type: none"> <li>• Flashes when the system senses a likely collision with a vehicle in front of you.</li> </ul>	<ul style="list-style-type: none"> <li>• Take appropriate action to prevent a collision (apply the brakes, change lanes, etc.).                             <ul style="list-style-type: none"> <li>➤ <b>Adaptive Cruise Control (ACC)*</b> P. 433</li> <li>➤ <b>Collision Mitigation Braking System™ (CMBS™)*</b> P. 472</li> </ul> </li> </ul>





Message	Condition	Explanation
	<ul style="list-style-type: none"> <li>• Appears if anything covers the radar sensor cover and prevents the sensor from detecting a vehicle in front.</li> <li>• May appear when driving in bad weather (rain, snow, fog, etc.).</li> </ul>	<ul style="list-style-type: none"> <li>• When the radar sensor gets dirty, stop your vehicle in a safe place, and wipe off dirt using a soft cloth.</li> <li>• Have your vehicle checked by a dealer if the message does not disappear even after you clean the sensor cover.</li> </ul> <p>➤ <b>Adaptive Cruise Control (ACC)</b>* P. 433</p>
	<ul style="list-style-type: none"> <li>• Appears when the area around the camera is blocked by dirt, mud, etc. Stop your vehicle in a safe place, and wipe it off with a soft cloth.</li> <li>• May appear when driving in bad weather (rain, snow, fog, etc.).</li> </ul>	<ul style="list-style-type: none"> <li>• Have your vehicle checked by a dealer if the message appears again after you cleaned the area around the camera.</li> </ul>
	<ul style="list-style-type: none"> <li>• Appears if the temperature inside the camera is too high.</li> <li>• ACC/LKAS has been automatically canceled.</li> </ul>	<ul style="list-style-type: none"> <li>• Use the climate control system to cool down the camera.</li> <li>• <b>Goes off</b> - The camera has been cooled down. Pressing the <b>MAIN/LKAS</b> button can resume the system.</li> </ul> <p>➤ <b>Front Sensor Camera</b>* P. 431</p> <p>➤ <b>Adaptive Cruise Control (ACC)</b>* P. 433</p> <p>➤ <b>Lane Keeping Assist System (LKAS)</b>* P. 452</p>
	<ul style="list-style-type: none"> <li>• Appears when the LKAS is in operation, or the LKAS button is pressed, but there is a problem with a system related to the LKAS. The LKAS cancels automatically. The beeper sounds simultaneously.</li> </ul>	<ul style="list-style-type: none"> <li>• If any other system indicators come on, such as the VSA®, ABS and brake system, take appropriate action.</li> </ul> <p>➤ <b>Indicators</b> P. 76</p>
	<ul style="list-style-type: none"> <li>• Appears when the camera has been cooled down and LKAS is available.</li> </ul>	<ul style="list-style-type: none"> <li>• Pressing the <b>MAIN/LKAS</b> button can resume the system.</li> </ul> <p>➤ <b>Front Sensor Camera</b>* P. 431</p>

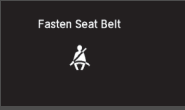



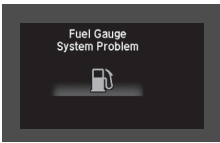
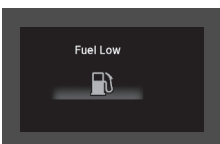

\* Not available on all models

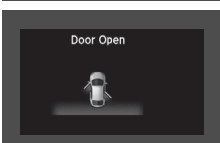
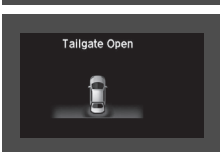
Message	Condition	Explanation
	<p><b>Lane Keeping Assist System (LKAS)</b></p> <ul style="list-style-type: none"> <li>• Appears when the vehicle is driving out of a detected line. The steering wheel vibrates rapidly.</li> </ul> <p><b>Road Departure Mitigation (RDM) System</b></p> <ul style="list-style-type: none"> <li>• Appears when the vehicle is driving out of a detected line.</li> </ul> <p><b>When you selected Warning Only</b></p> <ul style="list-style-type: none"> <li>- The steering wheel vibrates rapidly when the vehicle is drifting out of a detected line.</li> </ul> <p><b>When you selected Narrow, Normal or Wide</b></p> <ul style="list-style-type: none"> <li>- The steering wheel vibrates rapidly when the vehicle is drifting out of a detected line. The system also steers the vehicle to help you remain within your driving lane.</li> </ul>	<ul style="list-style-type: none"> <li>• Keep the vehicle within the lane you are driving. <ul style="list-style-type: none"> <li>➤ <b>Lane Keeping Assist System (LKAS)*</b> P. 452</li> </ul> </li> <li>• Keep the vehicle within the lane you are driving. <ul style="list-style-type: none"> <li>➤ <b>Road Departure Mitigation (RDM) System*</b> P. 447</li> </ul> </li> <li>• You can change the setting for the road departure mitigation system. <b>Narrow, Normal, Wide,</b> and <b>Warning Only</b> can be selected. <ul style="list-style-type: none"> <li>➤ <b>Customized Features</b> P. 111</li> </ul> </li> </ul>
	<p><b>Road Departure Mitigation (RDM) System</b></p> <p><b>When you selected Narrow</b></p> <ul style="list-style-type: none"> <li>• Appears when the vehicle is likely to drive out of a detected line.</li> <li>- The system steers the vehicle to help you remain within your driving lane.</li> </ul>	<p>—</p>
	<ul style="list-style-type: none"> <li>• Blinks when you fail to steer the vehicle. The beeper sounds simultaneously.</li> </ul>	<ul style="list-style-type: none"> <li>• Operate the steering wheel to resume the LKAS.</li> </ul>

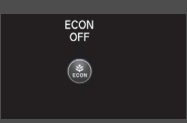
Message	Condition	Explanation
	<ul style="list-style-type: none"> <li>• Appears if the temperature inside the camera is too high.</li> <li>• The LKAS has been automatically canceled.</li> </ul>	<ul style="list-style-type: none"> <li>• Use the climate control system to cool down the camera.</li> <li>• <b>Goes off</b> - The camera has been cooled down. Pressing the <b>LKAS</b> button can resume the system.                             <ul style="list-style-type: none"> <li>➤ <b>Front Sensor Camera</b>* P. 431</li> <li>➤ <b>Lane Keeping Assist System (LKAS)</b>* P. 452</li> </ul> </li> </ul>
	<ul style="list-style-type: none"> <li>• Appears once if the outside temperature is below 3°C while the ignition switch is in ON *1.</li> </ul>	<p style="text-align: center;">—</p>
	<ul style="list-style-type: none"> <li>• Appears if not wearing a seat belt when you turn the ignition switch to ON *1.</li> </ul>	<ul style="list-style-type: none"> <li>• Goes off after you or the front passenger or both of you have fastened your seat belts.</li> </ul>

\*1:Models with the smart entry system have an **ENGINE START/STOP** button instead of an ignition switch.

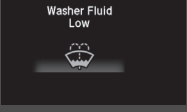
Message	Condition	Explanation
 <p>Fuel Gauge System Problem</p>	<ul style="list-style-type: none"> <li>• Appears if there is a problem with the fuel gauge.</li> </ul>	<ul style="list-style-type: none"> <li>• <b>Blinks</b> - Have your vehicle checked by a dealer.</li> </ul>
 <p>Fuel Low</p>	<ul style="list-style-type: none"> <li>• Appears when the fuel reserve is running low (approximately 1.59 U.S. gal./6.0 Liter left).</li> </ul>	<ul style="list-style-type: none"> <li>• <b>Appears</b> - Refuel your vehicle as soon as possible.   <b>Fuel Gauge</b> P. 110</li> </ul>
 <p>Door Open</p>	<ul style="list-style-type: none"> <li>• Appears if any door is not completely closed.</li> <li>• The beeper sounds and the message appears on if any door or the tailgate is opened while driving.</li> </ul>	<ul style="list-style-type: none"> <li>• Goes off when all doors are closed.</li> </ul>
 <p>Tailgate Open</p>	<ul style="list-style-type: none"> <li>• Appears if the tailgate is not completely closed.</li> </ul>	<ul style="list-style-type: none"> <li>• Goes off when the tailgate is closed.</li> </ul>

Message	Condition	Explanation
	<ul style="list-style-type: none"> <li>Appears if any door or the tailgate is not completely closed.</li> </ul>	<ul style="list-style-type: none"> <li>Goes off when all doors and the tailgate are closed.</li> </ul>
	<ul style="list-style-type: none"> <li>Appears when ECON mode is turned off by pressing ECON button.</li> </ul>	<ul style="list-style-type: none"> <li> <b>ECON Button</b>* P. 427</li> </ul>
	<ul style="list-style-type: none"> <li>Appears when approaching a intersection during route guidance.</li> </ul>	<ul style="list-style-type: none"> <li> <b>Refer to the Navigation System Manual</b></li> </ul>
<div style="border: 1px solid black; padding: 2px; width: fit-content;">Canadian models</div> 	<ul style="list-style-type: none"> <li>Appears when the washer fluid is low.</li> </ul>	<ul style="list-style-type: none"> <li>Refill the washer fluid.</li> <li> <b>Refilling Window Washer Fluid</b> P. 510</li> </ul>

\* Not available on all models

Models with auto high-beam

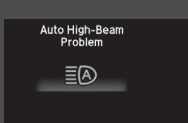
Message	Condition	Explanation
 The image shows a dark rectangular icon for a warning message. At the top, it says "Auto High-Beam Problem" in white text. Below the text is a white icon consisting of three horizontal lines on the left and a circle with a diagonal line through it on the right, representing a headlight.	<ul style="list-style-type: none"><li>• Appears when there is a problem with the auto high-beam.</li></ul>	<ul style="list-style-type: none"><li>• Manually operate the headlight switch.</li><li>• If you are driving with the high beam headlights when this happens, the headlights are changed to low beams.</li></ul>

## Gauges

Gauges include the speedometer, tachometer and related indicators. They are displayed when the ignition switch is in ON \*1.

### ■ Speedometer

Displays your driving speed in mph and km/h.

### ■ Tachometer

Shows the number of engine revolutions per minute.

### ■ Outside Temperature\*

Shows the outside temperature in Fahrenheit (U.S.) or Celsius (Canada).

#### ■ Adjusting the outside temperature display

Adjust the temperature reading up to  $\pm 5^{\circ}\text{F}$  or  $\pm 3^{\circ}\text{C}$  if the temperature reading seems incorrect.

\*1: Models with the smart entry system have an **ENGINE START/STOP** button instead of an ignition switch.

\* Not available on all models

### Outside Temperature\*

The temperature sensor is in the front bumper. Road heat and exhaust from another vehicle can affect the temperature reading when your vehicle speed is less than 19 mph (30 km/h).

It may take several minutes for the display to be updated after the temperature reading has stabilized.

Use the multi-information display's customized features to correct the temperature.

 **Customized Features** P. 111

## Information Display\*

The information display shows the fuel gauge, odometer, trip meter, engine oil life and maintenance service item codes, and other gauges.

### Switching the Display

#### Models with display audio system

Some of the items on the information display also appear on the audio/information screen. They also change along with the information display changes while the fuel consumption is shown.

### Switching the Display

Press the  (select/reset) knob to change the display.

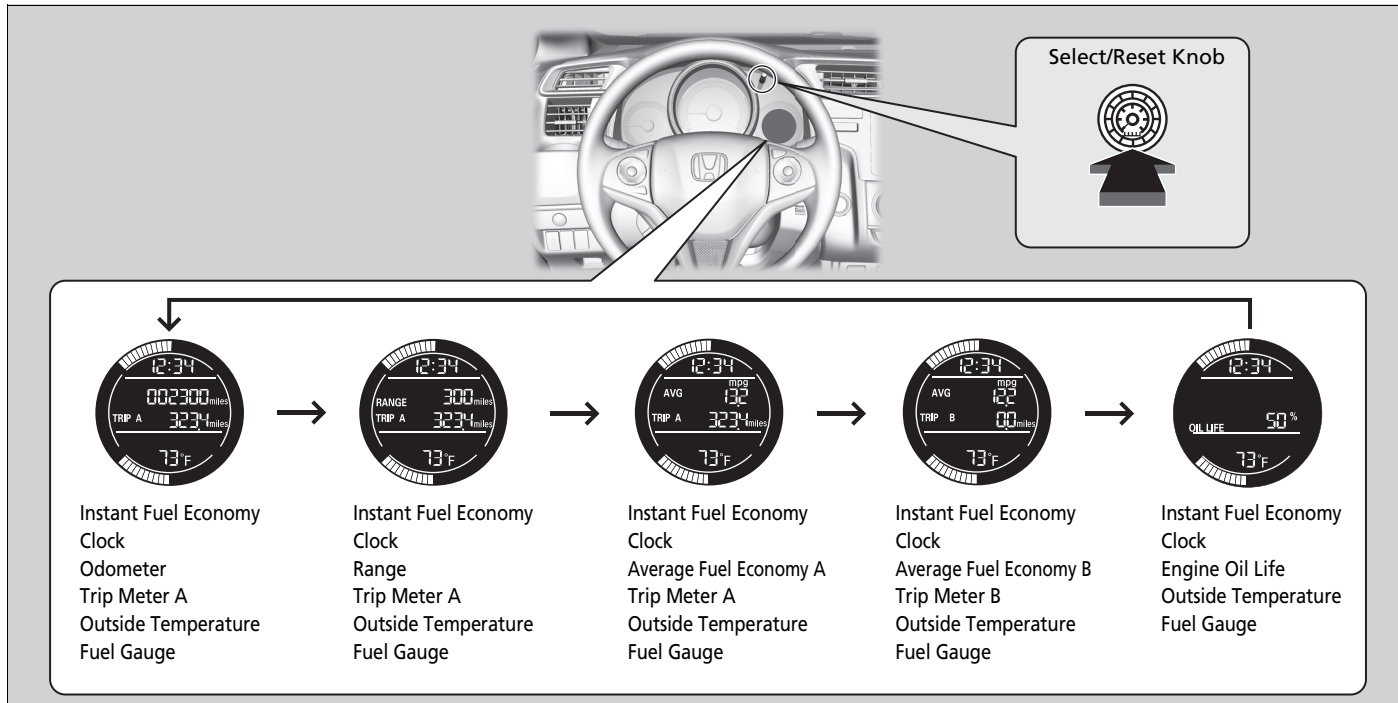



## ■ Instant Fuel Economy

Shows the instant fuel economy as a bar graph in mpg (U.S.) or l/100 km (Canada).

## ■ Odometer

Shows the total number of miles (U.S.) or kilometers (Canada) that your vehicle has accumulated.

## ■ Trip Meter

Shows the total number of miles (U.S.) or kilometers (Canada) driven since the last reset. TRIP A and B can be used to measure two separate trips.

## ■ Resetting a trip meter

To reset a trip meter, display it, then press and hold the  (select/reset) knob. The trip meter is reset to **0.0**.

## ■ Range

Shows the estimated distance you can travel on the remaining fuel. This distance is estimated from the fuel economy of your previous trips.

## ■ Average Fuel Economy

Shows the estimated average fuel economy of each trip meter in mpg (U.S.) or l/100 km (Canada). The display is updated at set intervals. When a trip meter is reset, the average fuel economy is also reset.

### ☒ Trip Meter



Switch between trip meter A and trip meter B by pressing the  (select/reset) knob.

## ■ Outside Temperature\*

Shows the outside temperature in Fahrenheit (U.S.) or Celsius (Canada).

### ■ Adjusting the outside temperature indicator

Adjust the temperature reading up to  $\pm 5^{\circ}\text{F}$  or  $\pm 3^{\circ}\text{C}$  if the temperature reading seems incorrect.

1. Turn the ignition switch to ON .
2. Press and hold the  (select/reset) knob for 10 seconds or more while the outside temperature is shown on the information display.
  - The information display goes into temperature adjustment mode. The display starts showing from  $-5^{\circ}\text{F}$  to  $+5^{\circ}\text{F}$  (U.S.) or  $-3^{\circ}\text{C}$  to  $+3^{\circ}\text{C}$  (Canada).
3. Release the  (select/reset) knob when the right adjustment amount is shown.
  - The adjustment is complete.

## ■ Engine Oil Life and Maintenance Items

Shows the remaining oil life and Maintenance Minder™.

 **Maintenance Minder™** P. 491

## ■ Fuel Gauge

Displays the amount of fuel left in the fuel tank.

## » Outside Temperature\*

The temperature sensor is in the front bumper. Road heat and exhaust from another vehicle can affect the temperature reading when your vehicle speed is less than 19 mph (30 km/h).

It may take several minutes for the display to be updated after the temperature reading has stabilized.

When the engine oil life is shown on the information display, you cannot adjust the outside temperature. Push the  (select/reset) knob to select the other display.

## » Fuel Gauge

### NOTICE

You should refuel when the reading approaches . Running out of fuel can cause the engine to misfire, damaging the catalytic converter.

The actual amount of remaining fuel may differ from the fuel gauge reading.



## Multi-Information Display \*

The multi-information display shows the odometer, trip meter, outside temperature indicator, and other gauges.

It also displays important messages such as warnings and other helpful information.

### Switching the Display

#### Main displays

Press the / (information) button to change the display.

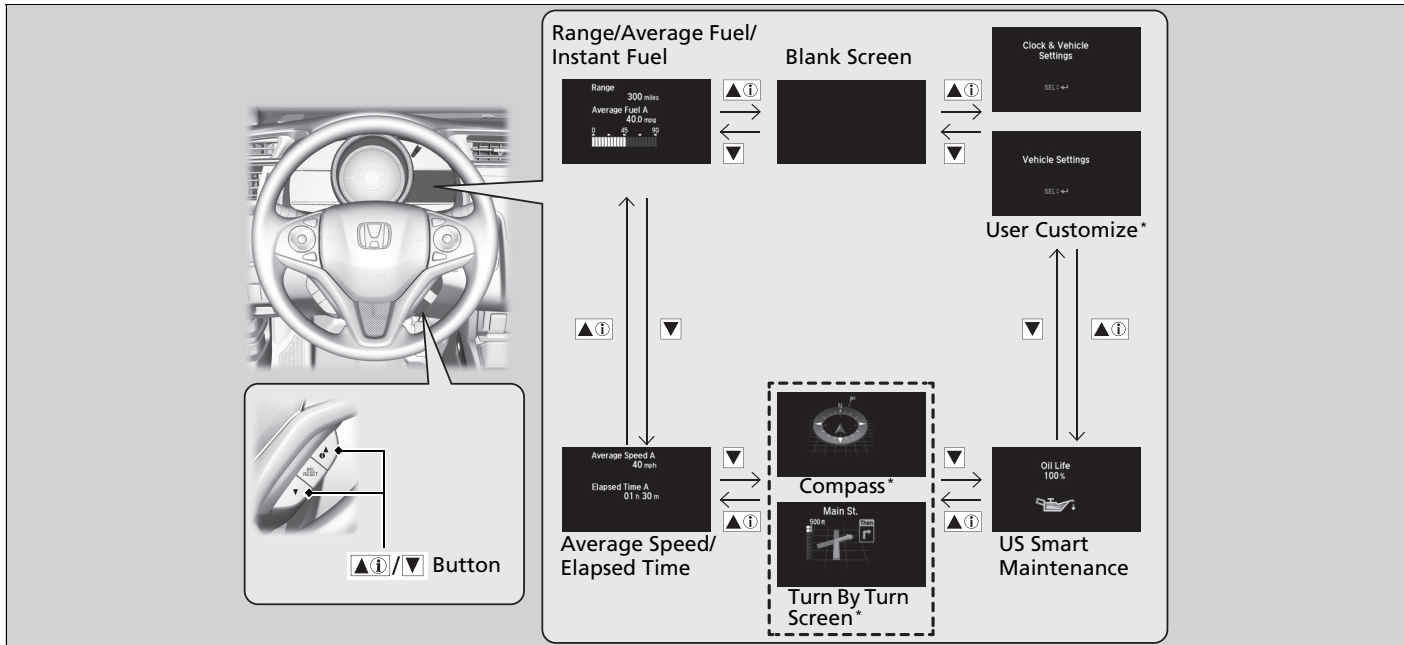

\* Not available on all models

### ■ Lower displays

Press the **SEL/RESET** button to change the display.

Instrument Panel

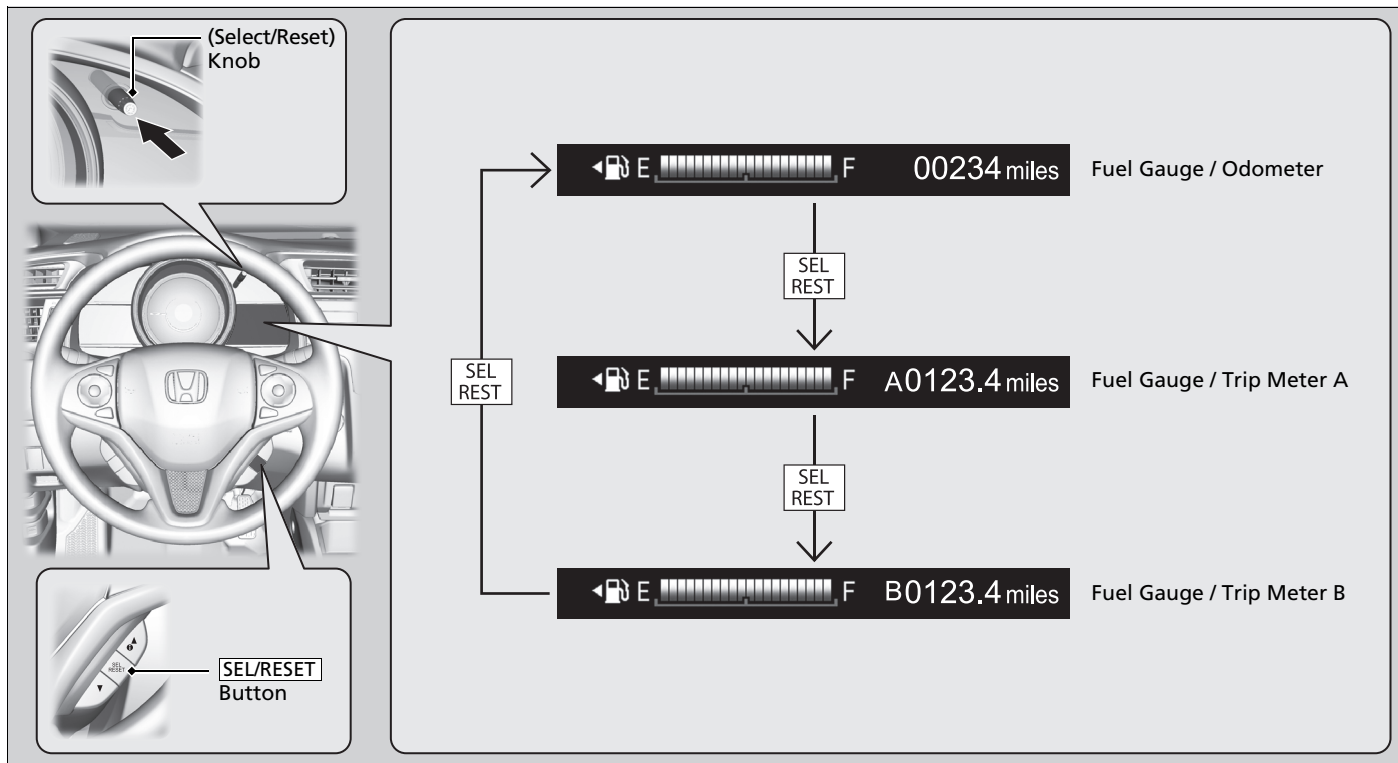

## ■ Odometer

Shows the total number of miles (U.S.) or kilometers (Canada) that your vehicle has accumulated.

## ■ Trip Meter

Shows the total number of miles (U.S.) or kilometers (Canada) driven since the last reset. Meters A and B can be used to measure two separate trips.

### ■ Resetting a trip meter

To reset a trip meter, display it, then press and hold the **SEL/RESET** button. The trip meter is reset to **0.0**.

## ■ Average Fuel Economy

Shows the estimated average fuel economy of each trip meter in mpg (U.S.) or l/100 km (Canada). The display is updated at set intervals. When a trip meter is reset, the average fuel economy is also reset.

## ■ Range

Shows the estimated distance you can travel on the remaining fuel. This distance is estimated from the fuel economy of your previous trips.

## ■ Elapsed Time

Shows the time elapsed since Trip A or Trip B was reset.

### ⌘ Trip Meter

Switch between trip meter A and trip meter B by pressing the **SEL/RESET** button.

### ⌘ Average Fuel Economy

You can change when to reset the average fuel economy.

➤ **Customized Features** P. 111

### ⌘ Elapsed Time

You can change when to reset the elapsed time.

➤ **Customized Features** P. 111

## ■ Average Speed

Shows the average speed in mph (U.S.) or km/h (Canada) since Trip A or Trip B was reset.

## ■ Instant Fuel Economy

Shows the instant fuel economy as a bar graph in mpg (U.S.) or l/100 km (Canada).

## ■ Engine Oil Life

Shows the remaining oil life and Maintenance Minder™.

➤ **Maintenance Minder™** P. 491

## ■ Turn-by-Turn Directions\*

Shows you turn-by-turn driving directions to your destination linked with the navigation system.

➤ **Refer to the Navigation System Manual**

## ■ Fuel Gauge

Displays the amount of fuel left in the fuel tank.

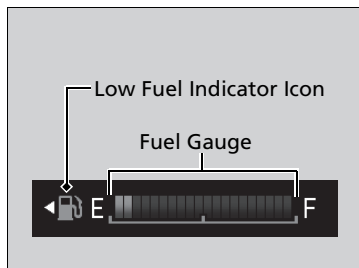

### ■ Fuel Low warning

When the remaining fuel is running low, the display color will change to orange and warns you to refuel as soon as possible.

The icon will start to blink when the fuel gauge is malfunctioning.

➤ **Multi-Information Display Warning and Information Messages\*** P. 92

## ▶▶ Average Speed

You can change when to reset the average speed.

➤ **Customized Features** P. 111

## ▶▶ Turn-by-Turn Directions\*

You can select whether the turn-by-turn display comes on during the route guidance.

➤ **Customized Features** P. 111

## ▶▶ Fuel Gauge

### NOTICE

You should refuel when the reading approaches **E**. Running out of fuel can cause the engine to misfire, damaging the catalytic converter.

The actual amount of remaining fuel may differ from the fuel gauge reading.

## ■ Customized Features

Use the multi-information display to customize certain features.

### ■ How to customize

Select the Vehicle Settings screen by pressing the /▼ button while the ignition switch is in ON \*1, the vehicle is at a complete stop, and the shift lever is in (continuously variable transmission), and the parking brake is set (manual transmission). Press the **SEL/RESET** button to enter the customizing mode.

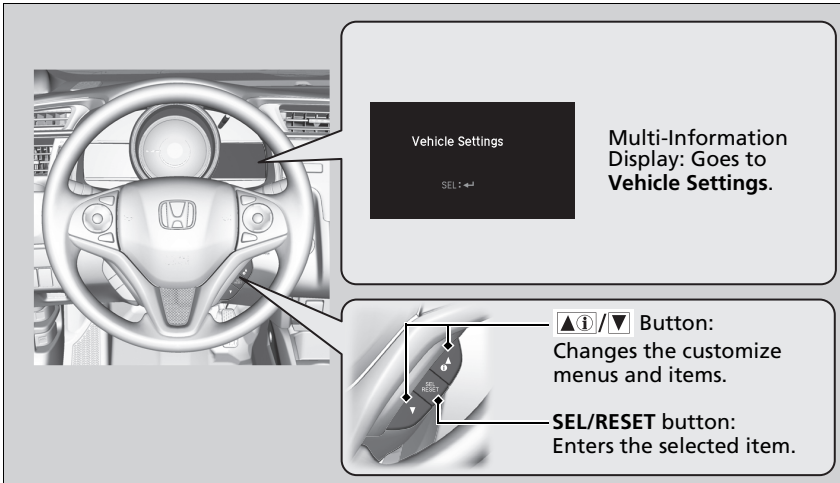

### ▶ Customized Features

To customize other features, press the /▼ button.

▶ **List of customizable options** P. 114

▶ **Example of customization settings** P. 118

When you customize settings:

**Continuously variable transmission models**

Shift to .

**Manual transmission models**

Set the parking brake.

\*1: Models with the smart entry system have an **ENGINE START/STOP** button instead of an ignition switch.

\* Not available on all models

■ **Customization flow**

Press the ▲i/▼ button.

Instrument Panel

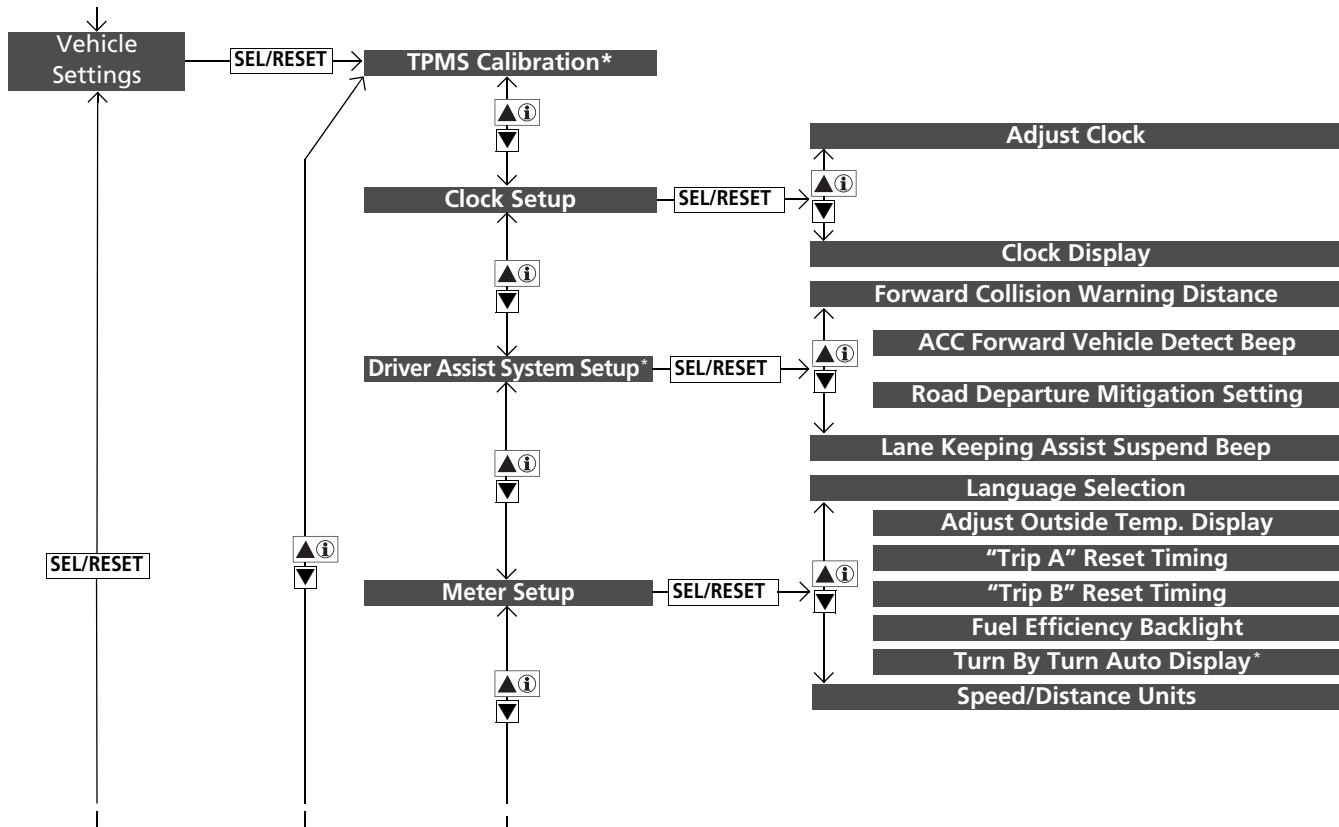



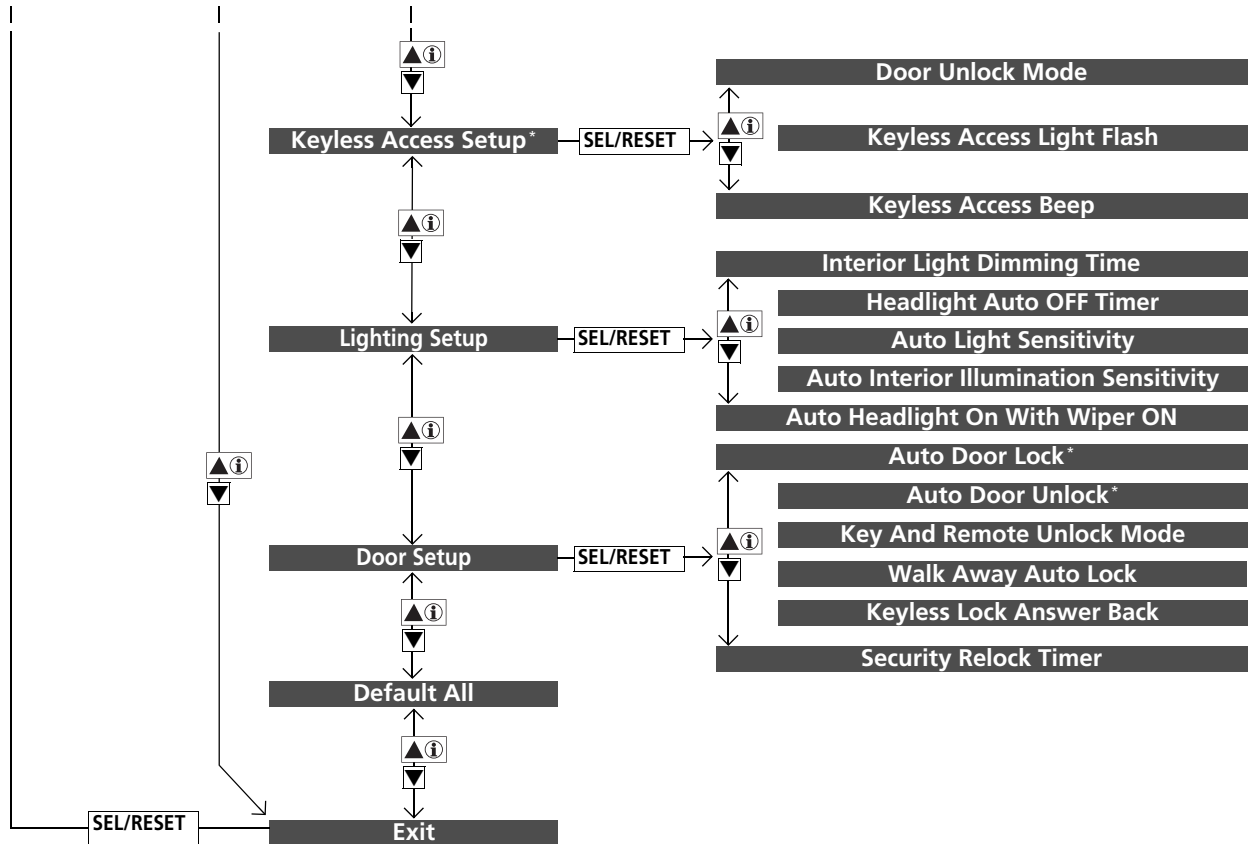

Instrument Panel

\* Not available on all models

■ List of customizable options

Setup Group	Customizable Features	Description	Selectable Settings
<b>TPMS Calibration*</b>	—	Calibrates the TPMS.	<b>Cancel/Calibrate</b>
<b>Clock Setup</b>	<b>Adjust Clock</b>	Adjusts the clock.	<b>hour (00 - 23)/minute (00 - 59)</b>
	<b>Clock Display</b>	Changes setting of the clock display.	<b>24h/12h<sup>*1</sup>/OFF</b>
<b>Driver Assist System Setup*</b>	<b>Forward Collision Warning Distance</b>	Changes at which distance the CMBST <sup>™</sup> alerts.	<b>Long/Normal<sup>*1</sup>/Short</b>
	<b>ACC Forward Vehicle Detect Beep</b>	Causes the system to beep when the system detects a vehicle, or when the vehicle goes out of ACC range.	<b>ON/OFF<sup>*1</sup></b>
	<b>Road Departure Mitigation Setting</b>	Changes the setting for the road departure mitigation system.	<b>Narrow/Normal<sup>*1</sup>/Wide/Warning Only</b>
	<b>Lane Keeping Assist Suspend Beep</b>	Causes the system to beep when the LKAS is suspended.	<b>ON/OFF<sup>*1</sup></b>

\*1: Default Setting

Setup Group	Customizable Features	Description	Selectable Settings
<b>Meter Setup</b>	<b>Language Selection</b>	Changes the displayed language.	<b>English<sup>*1</sup>/Français/Español</b>
	<b>Adjust Outside Temp. Display</b>	Adjusts the temperature reading by a few degrees.	<b>-5°F ~ ±0°F<sup>*1</sup> ~ +5°F (U.S.) -3°C ~ ±0°C<sup>*1</sup> ~ +3°C (Canada)</b>
	<b>“Trip A” Reset Timing</b>	Changes the setting of how to reset trip meter A, average fuel economy A, average speed A, and elapsed time A.	<b>When Refueled/IGN OFF/ Manually Reset<sup>*1</sup></b>
	<b>“Trip B” Reset Timing</b>	Changes the setting of how to reset trip meter B, average fuel economy B, average speed B, and elapsed time B.	<b>When Refueled/IGN OFF/ Manually Reset<sup>*1</sup></b>
	<b>Fuel Efficiency Backlight</b>	Turns the ambient meter feature on and off.	<b>ON<sup>*1</sup>/OFF</b>
	<b>Turn By Turn Auto Display*</b>	Selects whether the turn-by-turn display comes on during the route guidance.	<b>ON<sup>*1</sup>/OFF</b>
	<b>Speed/Distance Units</b>	Selects the trip computer units.	<b>mph-miles<sup>*1</sup>/km/h-km (U.S.) mph-miles/km/h-km<sup>*1</sup> (Canada)</b>
<b>Keyless Access Setup*</b>	<b>Door Unlock Mode</b>	Changes which doors unlock when you grab the driver’s door handle.	<b>Driver Door Only/All Doors</b>
	<b>Keyless Access Light Flash</b>	Causes some exterior lights to flash when you unlock/lock the doors.	<b>ON<sup>*1</sup>/OFF</b>
	<b>Keyless Access Beep</b>	Causes the beeper to sound when you unlock/lock the doors.	<b>ON<sup>*1</sup>/OFF</b>

\*1: Default Setting

\* Not available on all models

Setup Group	Customizable Features	Description	Selectable Settings
<b>Lighting Setup</b>	<b>Interior Light Dimming Time</b>	Changes the length of time the interior lights stay on after you close the doors.	<b>60sec/30sec*<sup>1</sup>/15sec</b>
	<b>Headlight Auto OFF Timer</b>	Changes the length of time the exterior lights stay on after you close the driver's door.	<b>60sec/30sec/15sec*<sup>1</sup>/0sec</b>
	<b>Auto Light Sensitivity</b>	Changes the timing for the headlights to come on.	<b>Max/High/Mid*<sup>1</sup>/Low/Min</b>
	<b>Auto Interior Illumination Sensitivity</b>	Changes the sensitivity of the brightness of the instrument panel when the headlight switch is in the AUTO position.	<b>Max/High/Mid*<sup>1</sup>/Low/Min</b>
	<b>Auto Headlight ON With Wiper ON</b>	Changes the sensitivity of the brightness of the instrument panel when the headlight switch is in the AUTO position.	<b>ON*<sup>1</sup>/OFF</b>

\*1: Default Setting

Setup Group	Customizable Features	Description	Selectable Settings
<b>Door Setup</b>	<b>Auto Door Lock</b>	Changes the setting for when the doors automatically lock.	<b>With Vehicle Speed<sup>*1</sup>/ Shift From <span style="border: 1px solid black; padding: 0 2px;">P</span><sup>*</sup>/OFF</b>
	<b>Auto Door Unlock</b>	Changes the setting for when the doors automatically unlock.	<b>All Doors When Driver's Door Opens<sup>*1</sup>/ All Doors When Shifted To Park<sup>*</sup>/ All Doors When Ignition Switched OFF/ OFF</b>
	<b>Key And Remote Unlock Mode</b>	Sets up either the driver's door or all doors to unlock on the first operation of the remote or built-in key.	<b>Driver Door<sup>*1</sup>/All Doors</b>
	<b>Walk Away Auto Lock</b>	Changes the settings for the auto lock function when you walk away from the vehicle.	<b>ON/OFF<sup>*1</sup></b>
	<b>Keyless Lock Answer Back</b>	LOCK/UNLOCK- The exterior lights flash. LOCK (2nd push)- The beeper sounds.	<b>ON<sup>*1</sup>/OFF</b>
	<b>Security Relock Timer</b>	Changes the time it takes for the doors to relock and the security system to set after you unlock the vehicle without opening any door.	<b>90sec/60sec/30sec<sup>*1</sup></b>
<b>Default All</b>	—	Cancels/Resets all the customized settings as default.	<b>Cancel/Set</b>

\*1: Default Setting

\* Not available on all models

### ■ Example of customization settings

The steps for changing the “**Trip A**” **Reset Timing** setting to **When Refueled** are shown below. The default setting for “**Trip A**” **Reset Timing** is **Manually Reset**.

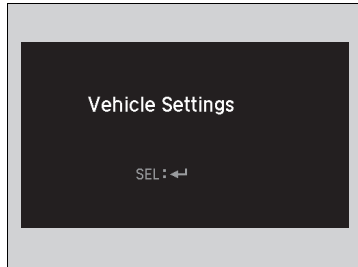

1. Press the  button until Vehicle Settings appears on the display, then press the **SEL/RESET** button.

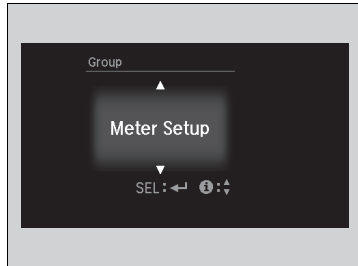

2. Press the  button until **Meter Setup** appears on the display.
3. Press the **SEL/RESET** button.

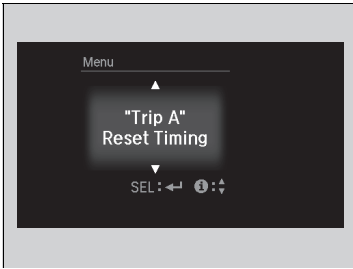

4. Press the **▲ ⓘ / ▼** button until **"Trip A" Reset Timing** appears on the display, then press the **SEL/RESET** button.

▶ The display switches to the customization setup screen, where you can select **When Refueled**, **IGN OFF**, **Manually Reset**, or **Exit**.

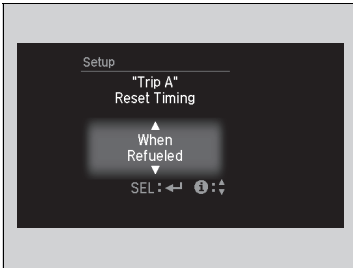

5. Press the **▲ ⓘ / ▼** button and select **When Refueled**, then press the **SEL/RESET** button.

▶ The **When Refueled Setup** screen appears, then the display returns to the customization menu screen.

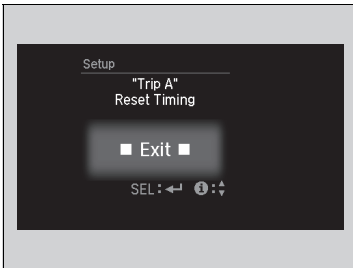

6. Press the **▲ ⓘ / ▼** button until **Exit** appears on the display, then press the **SEL/RESET** button.

7. Repeat Step 6 until you return to the normal screen.





# Controls

This chapter explains how to operate the various controls necessary for driving.



<b>Clock</b> .....	122
<b>Locking and Unlocking the Doors</b>	
Key Types and Functions .....	124
Low Smart Entry Remote Signal Strength* .....	126
Locking/Unlocking the Doors from the Outside.....	127
Locking/Unlocking the Doors from the Inside.....	135
Childproof Door Locks .....	138
Auto Door Locking/Unlocking* .....	139
<b>Opening and Closing the Tailgate</b> .....	145
<b>Security System</b> .....	148
Immobilizer System .....	148
Security System Alarm.....	148
<b>Opening and Closing the Windows</b> .....	151
<b>Opening and Closing the Moonroof*</b> .....	153

<b>Operating the Switches Around the Steering Wheel</b>	
<b>Models without smart entry system</b>	
Ignition Switch.....	154
<b>Models with smart entry system</b>	
ENGINE START/STOP Button .....	155
Ignition Switch and Power Mode Comparison ...	158
Turn Signals.....	159
Light Switches .....	160
Fog Lights* .....	163
Auto High-Beam* .....	164
Daytime Running Lights.....	168
Wipers and Washers.....	169
Brightness Control.....	171
Rear Defogger/Heated Door Mirror* Button .....	172

Adjusting the Steering Wheel .....	173
<b>Adjusting the Mirrors</b> .....	174
Interior Rearview Mirror .....	174
Power Door Mirrors .....	174
<b>Adjusting the Seats</b> .....	175
Front Seats .....	175
Rear Seats .....	179
<b>Interior Lights/Interior Convenience Items</b> .....	187
Interior Lights .....	187
Interior Convenience Items .....	189
<b>Heating and Cooling System*</b> .....	197
Using Vents, Heating and A/C* .....	197
<b>Climate Control System*</b> .....	200
Using Automatic Climate Control .....	200
Automatic Climate Control Sensors .....	204

\* Not available on all models

## Adjusting the Clock



### Models without navigation system

You can adjust the time in the clock display with the ignition switch is in ON \*1.

### Adjusting the Time

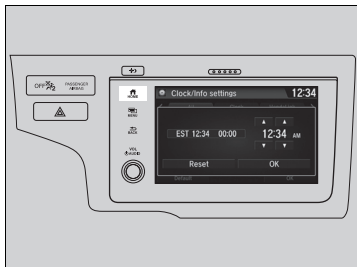
#### Display audio system\*



1. Select the  (**HOME**) icon, then select **Settings**.
2. Select **Clock/Info**, then **Clock Adjustment**.
3. Adjust the hours and minutes by selecting /.
4. Select **OK** to set the time.

### Adjusting the Time

The clock in the information display is automatically adjusted along with the audio system's clock display.

#### Models with navigation system

The clock is automatically updated through the navigation system, so the time does not need to be adjusted.

#### Models without navigation system

You can customize the clock display to show the 12 hour clock or 24 hour clock.

 **Customized Features** P. 321, 328

You can turn the clock display on and off.





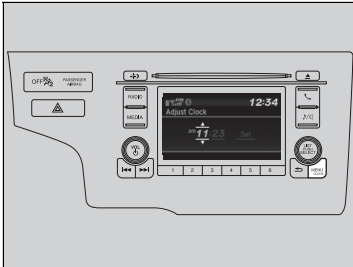

 **Customized Features** P. 328

\*1 : Models with the smart entry system have an **ENGINE START/STOP** button instead of an ignition switch.

\* Not available on all models

## ■ Color audio system\*



1. Press and hold the **MENU/CLOCK** button.  
▶ **Adjust Clock** is selected.
2. Rotate  to change hour, then press .
3. Rotate  to change minute, then press .
4. To enter the selection, rotate  and select **Set**, then press .



### ☒ Color audio system\*

These indications are used to show how to operate the **LIST/SELECT** (List/Selector) knob.

Rotate  to select.

Press  to enter.

You can also select **Adjust/Clock** by pressing the **MENU/CLOCK** button.

Rotate  to select **Adjust/Clock**, then press .

\* Not available on all models

## Key Types and Functions

This vehicle comes with the following keys:

Smart Entry Remote\*



### Models with smart entry system

Use the smart entry remote to start and stop the engine, and to lock and unlock all the doors and tailgate. You can also use the smart entry system to lock and unlock the doors and tailgate.

Ignition Key with Remote Transmitter\*



### Models without smart entry system

Use the keys to start and stop the engine, and to lock and unlock all the doors, and tailgate. You can also use the remote transmitter to lock and unlock the doors, and tailgate.

Ignition Keys\*



### Key Types and Functions

All the keys have an immobilizer system. The immobilizer system helps to protect against vehicle theft.

#### Immobilizer System P. 148

Follow the advice below to prevent damage to the keys:

- Do not leave the keys in direct sunlight, or in locations with high temperature or high humidity.
- Do not drop the keys or set heavy objects on them.
- Keep the keys away from liquids, dust and sand.
- Do not take the keys apart except for replacing the battery.

If the circuits in the keys are damaged, the engine may not start, and the remote transmitter/smart entry system\* may not work.

If the keys do not work properly, have them inspected by a dealer.

### ■ Built-in Key\*

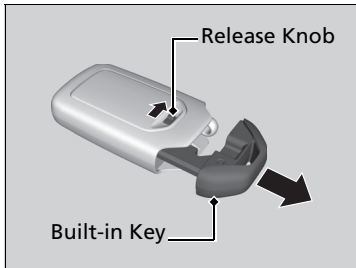

The built-in key can be used to lock/unlock the doors when the smart entry remote battery becomes weak and the power door lock/unlock operation is disabled.

To remove the built-in key, slide the release knob and then pull out the key. To reinstall the built-in key, push the built-in key into the smart entry remote until it clicks.

### ■ Key Number Tag

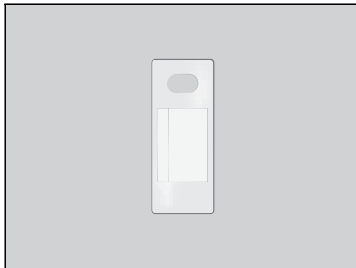

Contains a number that you will need if you purchase a replacement key.

### ☒ Key Number Tag

Keep the key number tag separate from the key in a safe place outside of your vehicle. If you wish to purchase an additional key, contact a dealer.

If you lose your key and you cannot start the engine, contact a dealer.

\* Not available on all models

## Low Smart Entry Remote Signal Strength \*

The vehicle transmits radio waves to locate the smart entry remote when locking/unlocking the doors and tailgate, or to start the engine.

In the following cases, locking/unlocking the doors and tailgate, or starting the engine may be inhibited or operation may be unstable:

- Strong radio waves are being transmitted by nearby equipment.
- You are carrying the smart entry remote together with telecommunications equipment, laptop computers, cell phones, or wireless devices.
- A metallic object is touching or covering the smart entry remote.

### ☒ Low Smart Entry Remote Signal Strength \*

Communication between the smart entry remote and the vehicle consumes the smart entry remote's battery.

Battery life is about two years, but this varies depending on regularity of use.

The battery is consumed whenever the smart entry remote is receiving strong radio waves. Avoid placing it near electrical appliances such as televisions and personal computers.

## Locking/Unlocking the Doors from the Outside

### ■ Using the Smart Entry with Push Button Start System \*

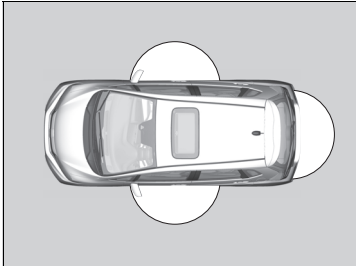

When you carry the smart entry remote, you can lock/unlock the doors and the tailgate. You can lock/unlock the doors and the tailgate within a radius of about 32 inches (80 cm) of the outside door handle or tailgate release button.

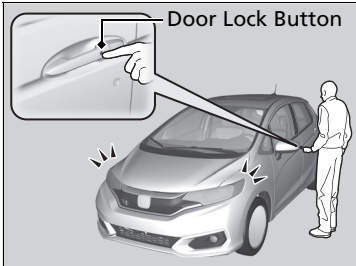

### ■ Locking the doors and tailgate

Press the door lock button on the front door or the tailgate.

- ▶ Some exterior lights flash; the beeper sounds; all the doors and tailgate lock; and the security system sets.

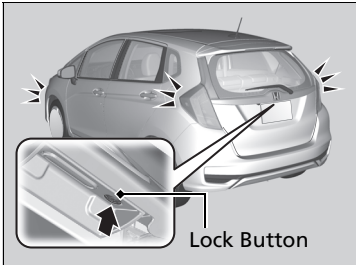

### ☒ Locking/Unlocking the Doors from the Outside

If the interior light switch is in the door activated position, the interior lights come on when you press the unlock button.  
No doors opened: The lights fade out after 30 seconds.  
Doors relocked with the remote transmitter: The lights go off immediately.

### ☒ Using the Smart Entry with Push Button Start System \*

If you do not open a door or the tailgate within 30 seconds of unlocking the vehicle with the smart entry system, the doors will automatically relock. You can lock or unlock doors using the smart entry system only when the power mode is in VEHICLE OFF.

- Do not leave the smart entry remote in the vehicle when you get out. Carry it with you.
- Even if you are not carrying the smart entry remote, you can lock/unlock the doors and tailgate while someone else with the remote is within range.
- The door may be unlocked if the door handle is covered with water in heavy rain or in a car wash if the smart entry remote is within range.
- If you grip a door handle wearing gloves, the door sensor may be slow to respond or may not respond by unlocking the doors.
- After locking the door, you have up to 2 seconds during which you can pull the door handle to confirm whether the door is locked. If you need to unlock the door immediately after locking it, wait at least 2 seconds before gripping the handle, otherwise the door will not unlock.
- The door might not open if you pull it immediately after gripping the door handle. Grip the handle again and confirm that the door is unlocked before pulling the handle.
- Even within the 32 inches (80 cm) radius, you may not be able to lock/unlock the doors and the tailgate with the smart entry remote if it is above or below the outside handle.
- The smart entry remote may not operate if it is too close to the door and door glass.

\* Not available on all models

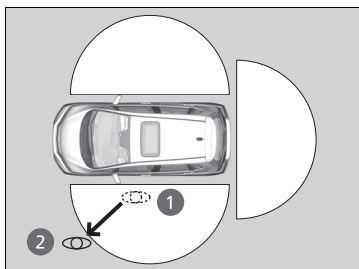
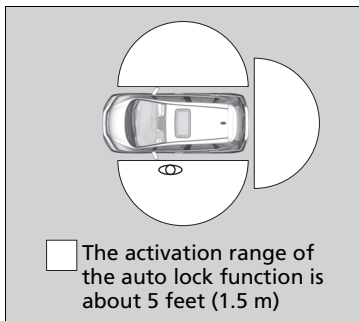

### ■ Locking the vehicle (Walk away auto lock)

When you walk away from the vehicle while carrying the smart entry remote, the doors will automatically lock.

The auto lock function activates when all doors and tailgate are closed, and the smart entry remote is within about 5 feet (1.5 m) radius of the outside door handle.

Exit vehicle while carrying smart entry remote and close door(s).

1. While within about 5 feet (1.5 m) radius of the vehicle.
  - ▶ The beeper sounds; the auto lock function will be activated.
2. Carry the smart entry remote beyond about 5 feet (1.5 m) from the vehicle and remain outside this range for 2 or more seconds.
  - ▶ Some exterior lights flash; the beeper sounds; all doors and tailgate will then lock.

### ▣ Locking the vehicle (Walk away auto lock)

The auto lock function is set to OFF as the factory default setting. The auto lock function can be set to ON using the audio/information screen or MID. If you set the auto lock function to ON using the audio/information screen or the MID, only the remote transmitter that was used to unlock the driver's door prior to the setting change can activate auto lock.

#### ▶ Customization flow P. 112

After the auto lock function has been activated, when you stay within the locking/unlocking operation range, the indicator on the smart entry remote will continue to flash until the doors are locked.

When you stay beside the vehicle within the operation range, the doors will automatically lock approximately 30 seconds after the auto lock function activating beeper sounds.

When you open a door after the auto lock function activating beeper sounds, the auto lock function will be delayed until all doors and tailgate are closed.

When all doors and tailgate have been closed and the smart entry remote is inside the vehicle, or if the smart entry remote is not detected within about 5 feet (1.5 m) of the vehicle, auto lock function will not be activated.

When all doors and tailgate have been closed, the warning beeper will sounds to indicate that the smart entry remote is not detected within the operation range.



To temporarily deactivate the function:

1. Set the power mode to OFF.
2. Open the driver's door.
3. Using the master door lock switch, operate the lock as follows:  
Lock → Unlock → Lock → Unlock.  
▶ The beeper sounds and the function is deactivated.

To restore the function:

- Set the power mode to ON.
- Lock the vehicle without using the auto lock function
- Walk away at least more than about 5 feet (1.5 m) away from the vehicle while carrying the smart entry remote.

#### ⌘ Locking the vehicle (Walk away auto lock)

The auto lock function does not operate when any of the following conditions are met.

- The smart entry remote is inside the vehicle.
- A door or the hood is not closed.
- The power mode is set to any mode other than OFF.
- The smart entry remote is not located within a radius of about 5 feet (1.5 m) from the vehicle when you get out of the vehicle and close the doors.

#### **Auto lock function operation stop beeper**

After the auto lock function has been activated, the auto lock operation stop beeper sounds for approximately two seconds in the following cases.

- The smart entry remote is put inside the vehicle through a window.
- You are located too close to the vehicle.

If the warning beeper sounds, check that you are carrying the smart entry remote. Then, open/close a door and confirm the auto lock activation beeper sounds once.

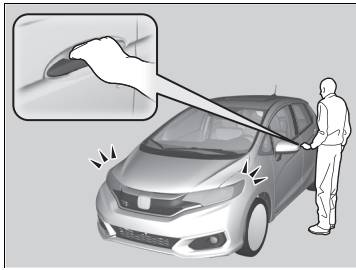

### ■ Unlocking the doors and tailgate

Grab the driver's door handle:

- ▶ The driver's door unlocks.
- ▶ Some exterior lights flash twice and the beeper sounds twice.

Grab the front passenger's door handle:

- ▶ All the doors and the tailgate unlock.
- ▶ Some exterior lights flash twice and the beeper sounds twice.

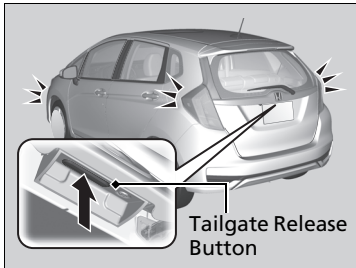

Press the tailgate release button:

- ▶ All the doors and the tailgate unlock.
- ▶ Some exterior lights flash twice and the beeper sounds twice.

### ▣ Using the Tailgate Outer Handle/Release Button P. 146

### ▣ Using the Smart Entry with Push Button Start System \*

The light flash, beep and door unlock mode settings can be customized using the multi-information display.

▣ **Customized Features** P. 111

## ■ Using the Remote Transmitter

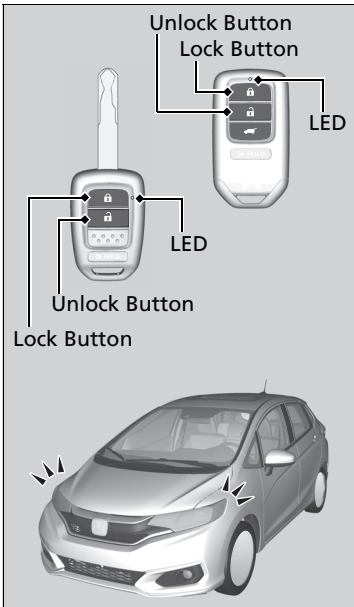

### ■ Locking the doors and tailgate

Press the lock button.

#### Once:

- ▶ Some exterior lights flash, all the doors and tailgate lock, and the security system sets.

#### Twice (within five seconds after the first push):

- ▶ A beeper sounds and verifies the security system is set.

### ▣ Using the Remote Transmitter

If you do not open a door within 30 seconds of unlocking the vehicle with the remote transmitter, the doors will automatically relock.

The remote will not lock the vehicle when a door or the tailgate is open.

The remote transmitter uses low-power signals, so the operating range may vary depending on the surroundings.

#### Models without smart entry system

The remote transmitter will not work when the key is in the ignition switch.

#### Models with smart entry system

You can lock or unlock doors using the remote transmitter or smart entry system only when the power mode is in VEHICLE OFF.

## ■ Unlocking the doors and tailgate

Press the unlock button.

### Once:

- ▶ Some exterior lights flash twice, and the driver's door unlocks.

### Twice:

- ▶ The remaining doors and tailgate unlock.

## » Using the Remote Transmitter

If the distance at which the remote transmitter works varies, the battery is probably low.  
If the LED does not come on when you press a button, the battery is dead.

➤ **Replacing the Button Battery** P. 534

### Models with multi-information display

You can customize the door lock mode and keyless lock acknowledgement setting.

➤ **Customized Features** P. 111

## ■ Locking/Unlocking the Doors Using a Key

If the smart entry remote battery\*, remote transmitter\* or the vehicle battery is dead, use the key instead of the smart entry remote\* or remote transmitter\*.

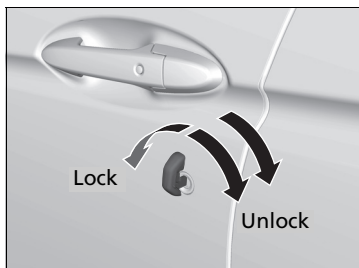

Fully insert the key and turn it.

## ▣ Locking/Unlocking the Doors Using a Key

When you lock the driver's door with a key, all the other doors and tailgate lock at the same time. When unlocking, the driver's door unlocks first. Turn the key a second time within a few seconds to unlock the remaining doors and the tailgate.

### ▣ Models with multi-information display

You can customize the door unlock mode setting.

➤ **Customized Features** P. 111

\* Not available on all models

## ■ Locking a Door Without Using a Key

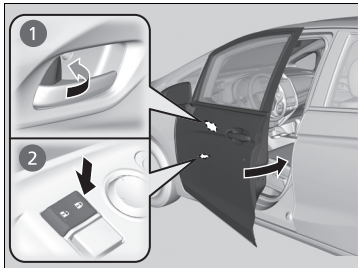

### ■ Locking the driver's door

Push the lock tab forward ① or push the master door lock switch in the lock direction ②, and close the door.

### ■ Locking the passengers' doors

Push the lock tab forward and close the door.

### ■ Lockout prevention system

#### Models without smart entry system

The doors and the tailgate cannot be locked when the key is in the ignition switch.

#### Models with smart entry system

The doors and the tailgate cannot be locked when the smart entry remote is inside the vehicle.

### ▶ Locking a Door Without Using a Key

When you lock the driver's door, all the other doors and tailgate lock at the same time.

Make sure you have the key in your hand when you lock the driver's door, any of the other doors or the tailgate, otherwise you may end up locking the key inside the vehicle.

## Locking/Unlocking the Doors from the Inside

### ■ Using the Lock Tab

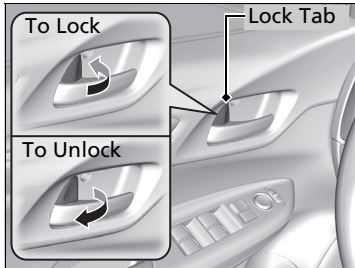

#### ■ Locking a door

Push the lock tab forward.

#### ■ Unlocking a door

Pull the lock tab rearward.

### ☒ Using the Lock Tab

When you lock the door using the lock tab on the driver's door, all the other doors and the tailgate lock at the same time.

When you unlock the door using the lock tab on the driver's door, only the driver's door will unlock.

*Continued*

## ■ Unlocking Using the Front Door Inner Handle

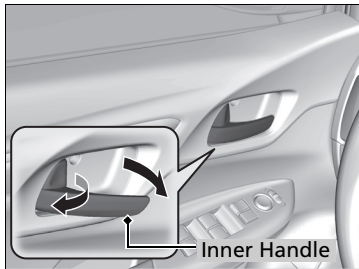

Pull the front door inner handle.

- ▶ The door unlocks and opens in one motion.

Unlocking and opening the driver's door from the inner handle unlocks all the other doors.

To avoid all the doors to be unlocked, use the lock tab on the driver's door to unlock, then lock again before opening the door. This setting works for one time only.

### Models with auto door locking/unlocking

- ▶ If you do not want all the doors to be unlocked all the time, customize the **Auto Door Unlock** setting to **Off** using the master door lock switch, multi-information display\*, or audio/information screen\*.
  - ▶ **Auto Door Locking/Unlocking\*** P. 139

## ▶▶ Unlocking Using the Front Door Inner Handle

The front door inner handles are designed to allow front seat occupants to open the door in one motion. However this feature requires that front seat occupants never pull a front door inner handle while the vehicle is in motion.

Children should always ride in a rear seat where childproof door locks are provided.

▶ **Childproof Door Locks** P. 138



## ■ Using the Master Door Lock Switch

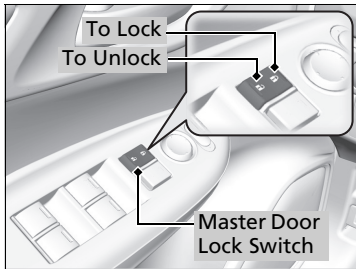

Press the master door lock switch in as shown to lock or unlock all doors and the tailgate.

## ☒ Using the Master Door Lock Switch

When you lock/unlock the driver's door using the master door lock switch, all the other doors and the tailgate lock/unlock at the same time.

## Childproof Door Locks

The childproof door locks prevent the rear doors from being opened from the inside regardless of the position of the lock tab.

### ■ Setting the Childproof Door Locks

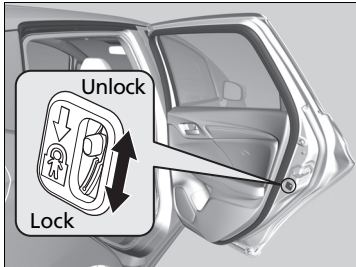

Slide the lever in the rear door to the lock position, and close the door.

### ■ When opening the door

Open the door using the outside door handle.

### ☒ Childproof Door Locks

To open the door from the inside when the childproof door lock is on, put the lock tab in the unlock position, lower the rear window, put your hand out of the window, and pull the outside door handle.

## Auto Door Locking/Unlocking\*

Your vehicle locks or unlocks all doors automatically when a certain condition is met.

### ■ Auto Door Locking

#### ■ Drive lock mode

All doors lock when the vehicle's speed reaches about 10 mph (15 km/h).

### ■ Auto Door Unlocking

#### ■ Driver's door open mode

All doors unlock when the driver's door is opened.

### ⌘ Auto Door Locking/Unlocking\*

You can turn off or change to another auto door locking/unlocking setting using the master door lock switch.

#### ➤ Customizing the Auto Door Locking/Unlocking Setting\* P. 140

### Models with multi-information display

You can turn off or change to another auto door locking/unlocking setting using the multi-information display.

#### ➤ Customized Features P. 111

\* Not available on all models

## Customizing the Auto Door Locking/Unlocking Setting \*

You can customize the auto door locking/unlocking setting to your liking using the master door lock switch.

### List of the Auto Door Locking/Unlocking Customizable Options

#### ■ Auto door locking

Mode	Description
<b>Drive Lock Mode</b> * <sup>1</sup>	All doors lock when the vehicle's speed reaches about 10 mph (15 km/h).
<b>Off</b>	The auto door locking is deactivated all the time.

#### ■ Auto door unlocking

Mode	Description
<b>Driver's Door Open Unlock Mode</b> * <sup>1</sup>	All doors unlock when the driver's door is opened.
<b>Park Unlock Mode</b> <small>Continuously variable transmission models</small>	All doors unlock when the transmission is put into <b>P</b> with the brake pedal depressed.
<b>Off</b>	The auto door unlocking is deactivated all the time.

\*1: Default setting

## ■ Customizing Flow for Auto Door Locking Options

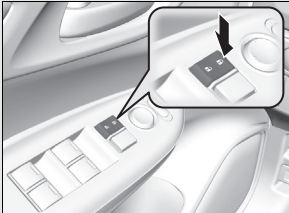
Steps	Drive Lock Mode*1	Off
1	Apply the parking brake. Continuously variable transmission models Move the shift lever to <b>P</b> .	
2	The driver's door must be closed at this stage.	Open the driver's door.
3	Turn the ignition switch to ON <b>II</b> *2. Push the <b>ENGINE START/STOP</b> button twice without depressing the brake pedal*3.	
4	Continuously variable transmission models Move the shift lever out of <b>P</b> with the brake pedal depressed.	—
5	Press and hold the front of the master door lock switch on the driver's door. You will hear a click more than five seconds elapsed. Release the switch.	
6	Continuously variable transmission models Move the shift lever to <b>P</b> .	—

\*1: Default setting

\*2: Models without smart entry system

\*3: Models with smart entry system

Steps	Drive Lock Mode*1	Off
7	<p>Turn the ignition switch to OFF <input type="checkbox"/> within 20 seconds*2.</p> <p>Push the <b>ENGINE START/STOP</b> button once without depressing the brake pedal*3.</p> <ul style="list-style-type: none"><li>▶ Customization is completed.</li><li>▶ All doors unlock and all turn signals blink three times.</li></ul>	

\*1 : Default setting

\*2 : Models without smart entry system

\*3 : Models with smart entry system

## Customizing Flow for Auto Door Unlocking Options

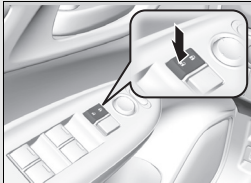
Steps	Driver Door Open Unlock Mode**1	Continuously variable transmission models Park Unlock Mode	Off
1	Apply the parking brake. Continuously variable transmission models Move the shift lever to <b>P</b> .		
2	The driver's door must be closed at this stage.		Open the driver's door.
3	Continuously variable transmission models Move the shift lever out of <b>P</b> with the brake pedal depressed.		—
4	Turn the ignition switch to ON <b>II</b> *2. Push the <b>ENGINE START/STOP</b> button twice without depressing the brake pedal*3.		
5	Press and hold the rear of the master door lock switch on the driver's door. You will hear a click more than five seconds elapsed. Release the switch.		
			
6	Continuously variable transmission models Move the shift lever to <b>P</b> .		—

\*1: Default setting

\*2: Models without smart entry system

\*3: Models with smart entry system

Steps	Driver Door Open Unlock Mode*1	Continuously variable transmission models Park Unlock Mode	Off
7	Turn the ignition switch to OFF [0] within 20 seconds*2. Push the <b>ENGINE START/STOP</b> button once without depressing the brake pedal*3. <ul style="list-style-type: none"> <li>▶ Customization is completed.</li> <li>▶ All doors lock and all turn signals blink three times.</li> </ul>		

\*1: Default setting

\*2: Models without smart entry system

\*3: Models with smart entry system



## Precautions for Opening/Closing the Tailgate

Always make sure individuals and objects are clear of the tailgate before opening or closing it.

- Open the tailgate all the way.
  - ▶ If it is not fully opened, the tailgate may begin to close under its own weight.
- Be careful when it is windy. The wind may cause the tailgate to close.

Keep the tailgate closed while driving to:

- ▶ Avoid possible damage.
- ▶ Prevent exhaust gas from leaking into the vehicle.
  - 📖 **Carbon Monoxide Gas** P. 73

### ⚠️ Precautions for Opening/Closing the Tailgate

#### **⚠️ WARNING**

**Anyone caught in the path of a tailgate that is being opened or closed can be seriously injured.**

**Make sure that all people are clear of the tailgate before opening or closing it.**

Be careful not to hit your head on the tailgate or to put your hands between the tailgate and the cargo area when closing the tailgate.

When you are storing or picking up luggage from the cargo area while the engine is idling, do not stand in front of the exhaust pipe. You may get burned.

Do not allow any passenger in the cargo space. They may get hurt during hard braking, a sudden acceleration, or a crash.

## Using the Tailgate Outer Handle/Release Button



### Models with smart entry system

When all the doors are unlocked, the tailgate is unlocked. Press the tailgate release button and lift open the tailgate.

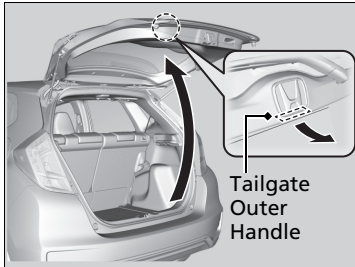

### Models without smart entry system

When all the doors are unlocked, the tailgate is unlocked.

Pull up the tailgate outer handle and lift open the tailgate.

### ►► Using the Tailgate Outer Handle/Release Button

#### Models with smart entry system

- Do not leave the smart entry remote in the vehicle when you get out. Carry it with you.
- A person who is not carrying the smart entry remote can unlock the tailgate if a person who is carrying it is within range.
- Do not leave the smart entry remote inside the cargo area and close the tailgate.

If you are carrying the smart entry remote, you do not have to unlock the tailgate before opening it.



To close the tailgate, grab the inner handle, pull the tailgate down, and push it closed from outside.

## Using the Remote Transmitter

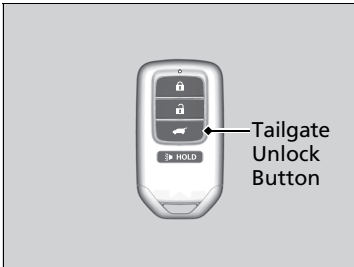

Press the tailgate unlock button to unlock the tailgate.

## Immobilizer System

The immobilizer system prevents a key that has not been pre-registered from starting the engine. Each key contains electronic transmitters that use electronic signals to verify the key.

Pay attention to the following when inserting the key into the ignition switch or pressing the **ENGINE START/STOP** button:

- Do not allow objects that emit strong radio waves near the ignition switch or the **ENGINE START/STOP** button.
- Make sure the key is not covered by or touching a metal object.
- Do not bring a key from another vehicle's immobilizer system near the ignition switch or the **ENGINE START/STOP** button.

Do not put the key near magnetic items. Electronic device, such as televisions and audio systems emit strong magnetic fields. Note that even a key chain can become magnetic.

## Security System Alarm

The security system alarm activates when the tailgate, hood or doors are forcibly opened. The alarm does not go off if the tailgate or doors are opened with the key, remote transmitter or smart entry system\*.

However, the alarm goes off when a door is opened with the key, then the shift lever is moved out of **P** (continuously variable transmission models) or the hood is opened before the ignition switch is turned to ON **II**\*1.

### ■ When the security system alarm activates

The horn sounds intermittently and all of the exterior lights flash.

\*1: Models with the smart entry system have an **ENGINE START/STOP** button instead of an ignition switch.

\* Not available on all models

### Immobilizer System

#### NOTICE

Leaving the key in the vehicle can result in theft or accidental movement of the vehicle. Always take the ignition key with you whenever you leave the vehicle unattended.

Do not alter the system or add other devices to it. Doing so may damage the system and make your vehicle inoperable.

### Security System Alarm

Do not alter the system or add other devices to it. Doing so may damage the system and make your vehicle inoperable.

The security alarm continues for a maximum of two minutes until the security system deactivates.

### ■ To deactivate the security system alarm

Unlock the vehicle using the key, remote transmitter, smart entry system\*, or turn the ignition switch to ON **II**\*1. The system, along with the horn and flashing lights, is deactivated.

### ■ Setting the security system alarm

The security system alarm automatically sets when the following conditions have been met:

- The ignition switch is in LOCK **0**\*1, and the key has been removed from the ignition switch.
- The hood is closed.
- All doors and the tailgate are locked from outside with the key, remote transmitter, or smart entry system.

### ■ When the security system alarm sets

The security system alarm indicator in the instrument panel blinks. When the blinking interval changes after about 15 seconds, the security system alarm is set.

### ■ To cancel the security system alarm

The security system alarm is canceled when the vehicle is unlocked using the key, remote transmitter, smart entry system\*, or the ignition switch is turned to ON **II**\*1. The security system alarm indicator goes off at the same time.

\*1: Models with the smart entry system have an **ENGINE START/STOP** button instead of an ignition switch.

\* Not available on all models

*Continued*

#### ☒ Security System Alarm

Do not set the security system alarm when someone is in the vehicle or a window is open. The system can accidentally activate when:

- Unlocking the door with the lock tab.
- Opening the hood with the hood release handle.

#### Continuously variable transmission models

- Moving the shift lever out of **P**.

If the battery goes dead after you have set the security system alarm, the security alarm may go off once the battery is recharged or replaced.

If this occurs, deactivate the security system alarm by unlocking a door using the key, remote transmitter, or smart entry system\*.

## ■ Panic Mode

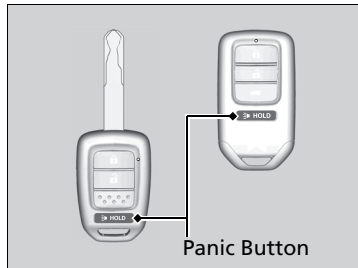

### ■ The panic button on the remote transmitter

If you press the panic button for approximately one second, the following will occur for about 30 seconds:

- The horn sounds.
- Some exterior lights flash.

### ■ Canceling panic mode

Press any button on the remote transmitter, or turn the ignition switch to ON \*1.

\*1: Models with the smart entry system have an **ENGINE START/STOP** button instead of an ignition switch.

## Opening/Closing the Power Windows

The power windows can be opened and closed when the ignition switch is in ON **II**\*1, using the switches on the doors.

The driver's side switches can be used to open and close all of the windows.

The power window lock button on the driver's side must be switched off (not pushed in, indicator off) to open and close the windows from anywhere other than the driver's seat.

When the power window lock button is pushed in, the indicator comes on and you can only operate the driver's window. Turn the power window lock button on if a child is in the vehicle.

### Opening/Closing Windows with Auto-Open/Close Function\*

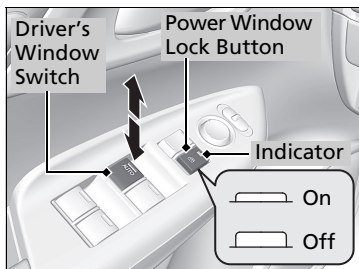

#### Manual operation

**To open:** Push the switch down lightly, and hold it until the desired position is reached.

**To close:** Pull the switch up lightly, and hold it until the desired position is reached.

#### Automatic operation

**To open:** Push the switch down firmly.

**To close:** Pull the switch up firmly.

The window opens or closes completely. To stop the window at any time, push or pull the switch briefly.

\*1: Models with the smart entry system have an **ENGINE START/STOP** button instead of an ignition switch.

\* Not available on all models

Continued

### Opening/Closing the Power Windows

## WARNING

Closing a power window on someone's hands or fingers can cause serious injury.

Make sure your passengers are away from the windows before closing them.

#### Models with auto-open/close function

The power windows can be operated for up to 10 minutes after you turn the ignition switch to LOCK **0**\*1. Opening either front door cancels this function.

#### Auto Reverse\*

If a power window senses resistance when closing automatically, it will stop closing and reverse direction.

The driver's window auto reverse function is disabled when you continuously pull up the switch.

The auto reverse function stops sensing when the window is almost closed to ensure that it fully closes.

## ■ Opening/Closing Windows without Auto-Open/Close Function

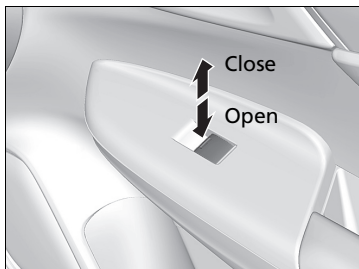

**To open:** Push the switch down.

**To close:** Pull the switch up.

Release the switch when the window reaches the desired position.



## ■ Opening/Closing the Moonroof

You can only operate the moonroof when the ignition switch is in ON \*<sup>1</sup>. Use the switch in the front of the ceiling to open and close the moonroof.

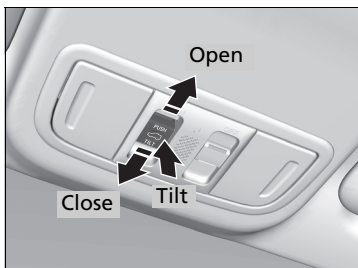

### ■ Automatic operation

**To open:** Pull the switch back firmly.

**To close:** Push the switch forward firmly.

The moonroof will automatically open or close all the way. To stop the moonroof midway, push the switch briefly.

### ■ Manual operation

**To open:** Pull the switch back lightly, and hold it until the desired position is reached.

**To close:** Push the switch forward lightly, and hold it until the desired position is reached.

### ■ Tilting the moonroof up

**To tilt:** Push on the center of the moonroof switch.

**To close:** Push the switch forward firmly, then release.

## ☒ Opening and Closing the Moonroof\*

### ⚠ WARNING

Opening or closing the moonroof on someone's hands or fingers can cause serious injury.

Make sure all hands and fingers are clear of the moonroof before opening or closing it.

### NOTICE

Opening the moonroof in below freezing temperature or when it is covered with snow or ice can damage the moonroof panel or motor.

The power moonroof can be operated for up to 10 minutes after you turn the ignition switch to LOCK \*<sup>1</sup>. Opening either front door cancels this function.

When resistance is detected, the auto reverse function causes the moonroof to change directions, then stop. Auto reverse stops sensing when the moonroof is almost closed to ensure that it fully closes. Make sure that all objects, including fingers, are clear of the moonroof.

\*1: Models with the smart entry system have an **ENGINE START/STOP** button instead of an ignition switch.

\* Not available on all models

# Operating the Switches Around the Steering Wheel

Models without smart entry system

## Ignition Switch

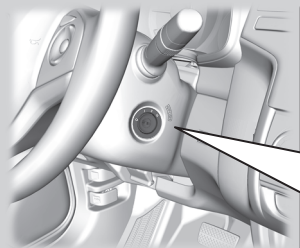

- 0** LOCK: Insert and remove the key in this position.
- I** ACCESSORY: Operate the audio system and other accessories in this position.
- II** ON: This is the position when driving.
- III** START: This position is for starting the engine. The switch returns to ON **II** when you let go of the key.

### Ignition Switch

Manual transmission models

## **⚠** WARNING

Removing the key from the ignition switch while driving locks the steering. This can cause you to lose control of the vehicle.

Remove the key from the ignition switch only when parked.

Continuously variable transmission models

You cannot take the key out unless the shift lever is in **P**.

All models

If you open the driver's door when the key is in LOCK **0** or ACCESSORY **I**, a warning buzzer will sound to remind you to take the key out.

If the key won't turn from LOCK **0** to ACCESSORY **I**, turn the key while moving the steering wheel left and right. The steering wheel will unlock, allowing the key to turn.

Models with smart entry system

## ENGINE START/STOP Button

### Changing the Power Mode

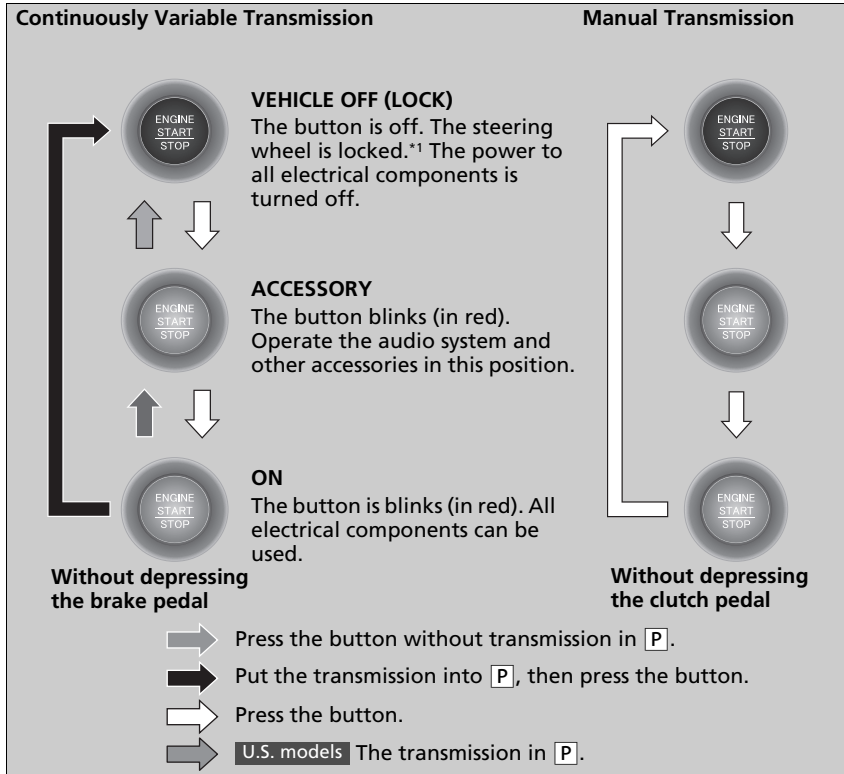

\*1: Except U.S. models with continuously variable transmission

### ENGINE START/STOP Button

#### ENGINE START/STOP Button Operating Range

You can start the engine when the smart entry remote is inside the vehicle.

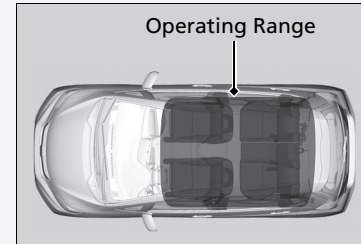

The engine may also run if the smart entry remote is close to the door or window, even if it is outside the vehicle.

ON mode:

The button is on (in red), if the engine is running.

If the battery of the keyless remote is getting low, the engine may not start when you push the **ENGINE START/STOP** button. If the engine does not start, refer to the following link.

➤ **If the Smart Entry Remote Battery is Weak**  
P. 553

## ■ Automatic Power Off

If you leave the vehicle for 30 to 60 minutes with the transmission in **P**<sup>\*1</sup> and the power mode in ACCESSORY, the vehicle automatically goes into the mode similar to VEHICLE OFF (LOCK) to avoid draining the battery.

### Except U.S. models with continuously variable transmission

When in this mode:

The steering wheel does not lock.

You cannot lock or unlock doors with the remote transmitter or the smart entry system.

Press the **ENGINE START/STOP** button three times to switch the mode to VEHICLE OFF (LOCK).

## ▶▶ ENGINE START/STOP Button

Do not leave the power mode in ACCESSORY or ON when you get out.

### Except U.S. models with continuously variable transmission

If the power mode does not change from VEHICLE OFF to ACCESSORY, press the **ENGINE START/STOP** button while moving the steering wheel left and right. The steering wheel will unlock, allowing the mode to change.

\*1: Continuously variable transmission models

## ■ Power Mode Reminder

If you open the driver's door when the power mode is set to ACCESSORY, a warning beep sounds.

## ■ Smart Entry Remote Reminder



Warning buzzers may sound from inside and/or outside the vehicle to remind you that the smart entry remote is out of the vehicle. If the buzzer continues even after the remote is put back inside, place it to be within its operational range.

### ■ When the power mode is in ON

If the smart entry remote is taken out of the vehicle, and the driver's door is closed, a warning buzzer sounds from both inside and outside the vehicle. A warning message on the information display notifies the driver inside that the remote is outside of the vehicle.

### ■ When the power mode is in ACCESSORY

If the smart entry remote is taken out of the vehicle, and all the doors are closed, a warning buzzer sounds from outside the vehicle.

## ▣ Smart Entry Remote Reminder









When the smart entry remote is within the system's operational range, and the driver's door is closed, the warning function cancels.

If the smart entry remote is taken out of the vehicle after the engine has been started, you can no longer change the **ENGINE START/STOP** button mode or restart the engine. Always make sure if the remote is in your vehicle when you operate the **ENGINE START/STOP** button.

Removing the smart entry remote from the vehicle through a window does not activate the warning buzzer.

Do not put the smart entry remote on the dashboard or in the glove box. It may cause the warning buzzer to go off. Under some other conditions that can prevent the vehicle from locating the remote, the warning buzzer may also go off even if the remote is within the system's operational range.

## Ignition Switch and Power Mode Comparison

Ignition Switch Position	LOCK 0 (with/without the key) 	ACCESSORY I 	ON II 	START III 
Without Smart Entry System	<ul style="list-style-type: none"> <li>• Engine is turned off and power is shut down.</li> <li>• The steering wheel is locked.</li> <li>• No electrical components can be used.</li> </ul>	<ul style="list-style-type: none"> <li>• Engine is turned off.</li> <li>• Some electrical components such as the audio system and the accessory power socket can be operated.</li> </ul>	<ul style="list-style-type: none"> <li>• Normal key position while driving.</li> <li>• All electrical components can be used.</li> </ul>	<ul style="list-style-type: none"> <li>• Use this position to start the engine.</li> <li>• The ignition switch returns to ON II when you release the key.</li> </ul>
Power Mode	VEHICLE OFF (LOCK) 	ACCESSORY 	ON   Button is: Blinking On	START 
With Smart Entry System and <b>ENGINE START/STOP</b> Button	Button-Off <ul style="list-style-type: none"> <li>• Engine is turned off and power is shut down.</li> <li>• The steering wheel is locked*1.</li> <li>• No electrical components can be used.</li> </ul>	Button-Blinking in red <ul style="list-style-type: none"> <li>• Engine is turned off.</li> <li>• Some electrical components such as the audio system and the accessory power socket can be operated.</li> </ul>	Button-Blinking in red (engine is turned off) On in red (engine is running) <ul style="list-style-type: none"> <li>• All electrical components can be used.</li> </ul>	Button-On in red <ul style="list-style-type: none"> <li>• The mode automatically returns to ON after the engine starts.</li> </ul>

\*1 : Except U.S. models with continuously variable transmission

## Turn Signals

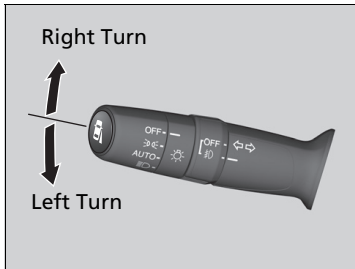

The turn signals can be used when the ignition switch is in ON \*1.

### ■ One-touch turn signal

When you lightly push up or down and release the turn signal lever, the exterior turn signals and turn signal indicator blink three times.

This feature can be used when signaling for a lane change.

\*1: Models with the smart entry system have an **ENGINE START/STOP** button instead of an ignition switch.

## Light Switches

### Manual Operation

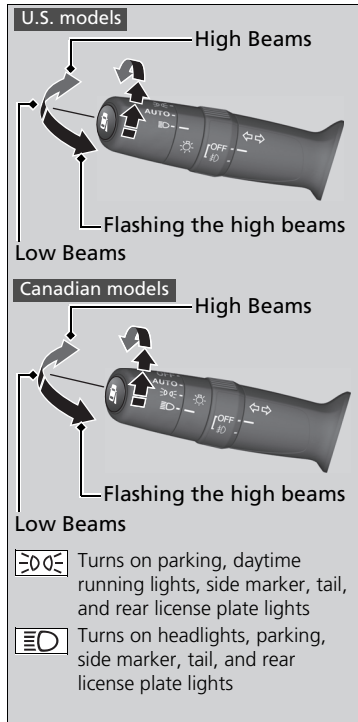

Rotating the light switch turns the lights on and off, regardless of the position of the ignition switch\*<sup>1</sup>.

#### ■ High beams

Push the lever forward until you hear a click.

#### ■ Low beams

When in high beams, pull the lever back to return to low beams.

#### ■ Flashing the high beams

Pull the lever back, and release it.

#### Canadian models

#### ■ Lights off

Turn the lever to **OFF** either when:

- The shift lever is in **P**\*<sup>2</sup>
- The parking brake is applied.

To turn the lights on again, turn the lever to **OFF** to cancel the lights off mode. Even if you do not cancel the lights off mode, the lights come on automatically when:

- The shift lever is moved out of **P**\*<sup>2</sup>.
- The parking brake is released.
- The vehicle starts to move.

\*1: Models with the smart entry system have an **ENGINE START/STOP** button instead of an ignition switch.

\*2: Continuously variable transmission models

### ▶▶ Light Switches

#### Models without smart entry system

If you remove the key from the ignition switch while the lights are on, a chime sounds when the driver's door is opened.

#### Models with smart entry system

If you leave the power mode in VEHICLE OFF (LOCK) while the lights are on, a chime sounds when the driver's door is opened.

#### All models

Do not leave the lights on when the engine is off because it will cause the battery to discharge.

If you sense that the level of the headlights is abnormal, have your vehicle inspected by a dealer.



## Automatic Operation (automatic lighting control)\*

U.S. models



Automatic lighting control can be used when the ignition switch is in ON \*1.

When the light switch is in **AUTO**, the headlights and other exterior lights will switch on and off automatically depending on the ambient brightness.

Canadian models

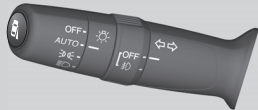

## Automatic Operation (automatic lighting control)\*

We recommend that you turn on the lights manually when driving at night, in a dense fog, or in dark areas such as long tunnels or parking facilities.

The light sensor is in the location shown below. Do not cover this light sensor with anything; otherwise, the automatic lighting system may not work properly.

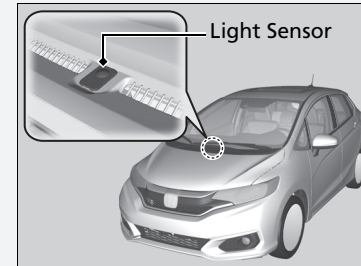

\*1: Models with the smart entry system have an **ENGINE START/STOP** button instead of an ignition switch.

\* Not available on all models

Continued

## ■ Headlight Integration with Wipers\*

The headlights automatically come on when the wipers are used several times within a certain number of intervals with the headlight switch in **AUTO**. The headlights automatically go off a few minutes later if the wipers are stopped.

## ■ Automatic Lighting Off Feature

The headlights, all other exterior lights, and the instrument panel lights turn off 15 seconds after you remove the key or set the power mode to VEHICLE OFF (LOCK), take the remote with you, and close the driver's door.

If you turn the ignition switch to LOCK **0**\*1 with the headlight switch on, but do not open the door, the lights turn off after 10 minutes (3 minutes, if the switch is in the **AUTO** position).

The lights turn on again when you unlock or open the driver's door. If you unlock the door, but do not open it within 15 seconds, the lights go off. If you open the driver's door, you will hear a lights on reminder chime.

\*1 : Models with the smart entry system have an **ENGINE START/STOP** button instead of an ignition switch.

\* Not available on all models

## ▣ Headlight Integration with Wipers\*

This feature activates while the headlights are off in **AUTO**. The instrument panel brightness does not change when the headlights come on.

At dark ambient light levels, the automatic lighting control feature turns on the headlights, regardless of the number of wiper sweeps.

## Fog Lights\*

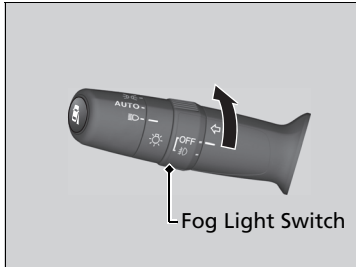

When the low beam headlights are on, turn the fog light switch on to use the fog lights.

\* Not available on all models

## Auto High-Beam\*

Using a camera mounted to the inside of the windshield, this system detects light sources ahead of the vehicle. Depending on the light source, the system automatically switches the headlights to high beam for optimal visibility at night.

### The system operates when:

- The headlight switch is in **AUTO**.
- The lever is in the low beam position.
- The low beams are on and the system recognizes that you are driving at night.
- The vehicle speed is above 45mph (72km/h).

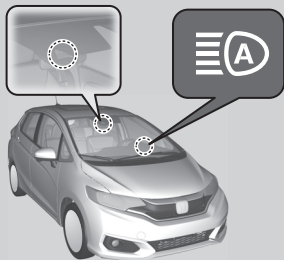

### How it works

When the camera detects lights coming from a preceding or oncoming vehicle, the headlights remain in low beam.

When the camera detects no lights coming from a preceding or oncoming vehicle, the headlights change to high beam.

The view angle or distance that the camera can detect lights ahead differs depending on conditions, such as the brightness of the lights and the weather.

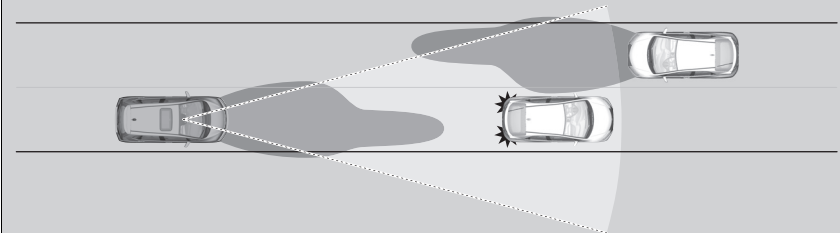

### Auto High-Beam\*

The auto high-beam determines when to change the headlight beams by responding to the brightness of the lights ahead of your vehicle. In the following cases, the system may not respond to the lights properly:

- The brightness of the lights from the preceding or oncoming vehicle is intense or poor.
- Visibility is poor due to the weather (rain, snow, fog, windshield frost, etc.).
- Other light sources, such as streetlights and electric billboards are illuminating the road ahead.
- The brightness level of the road ahead constantly changes.
- The road is bumpy or with many curves.
- A vehicle cuts in front of you, or a vehicle in front of you is not in the preceding or oncoming direction.
- Your vehicle is tilted with a heavy load in the rear.

If you find the timing of beam changes inconvenient for driving, change the headlight beams manually.

If you do not want the system to be activated at any time when the headlight switch is in **AUTO**, consult a dealer.

## Operating the System

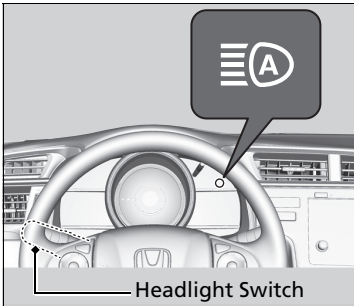

To activate the system, turn the headlight switch to **AUTO** and then set the headlights to low beam. The auto high-beam indicator will come on.

☞ **Light Switches** P. 160

The high beams remain on unless:

- You have been driving below 30mph (48km/h) for an extended amount of time.
- The speed of the vehicle drops below 15mph (24km/h).
- The windshield wipers have been running for more than a few seconds.
- You enter a well lit location.

The high beams come back on once the condition that caused them to turn off no longer exists.

## Operating the System

For the auto high-beam to work properly:

- Do not place an object that reflects light on the dashboard.
- Keep the windshield around the camera clean. When cleaning the windshield, be careful not to apply the windshield cleanser to the camera lens.
- Do not attach an object, sticker or film to the area around the camera.
- Do not touch the camera lens.

If the camera receives a strong impact, or repairing of the area near the camera is required, consult a dealer.

If the **Some Driver Assist Systems Cannot Operate: Camera Temperature Too High** message appears:

- Use the heating and cooling system\*/climate control system\* to cool down the interior and, if necessary, also use defroster mode with the air flow directed towards the camera.
- Start driving the vehicle to lower the windshield temperature, which cools down the area around the camera.

If needed, you can temporarily turn the high beams off manually. Turn on the high beams by pushing the lever forward until you hear a click, or flash the high beams once by pulling the lever toward you. To turn the high beams back on, repeat one of the procedures.

If you want the auto high-beam operation to resume at once, pull and hold the lever towards you for a few seconds.

#### ⌘ Operating the System

If the **Auto High-Beam Cannot Operate: Clean Windshield** message appears:

- Park your vehicle in a safe place, and clean the windshield. If the message does not disappear after you have cleaned the windshield and driven for a while, have your vehicle checked by a dealer.

## Disabling or Re-enabling the System

U.S. models

AUTO Position

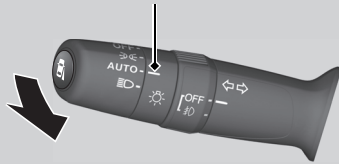

Canadian models

AUTO Position

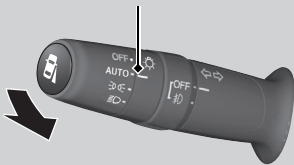

Disable or re-enable the system when the vehicle is parked and the ignition switch is in ON **II**\*<sup>1</sup> and the light switch is in the **AUTO** position.

**Disabling the system:** Pull the light switch lever towards you and hold it for at least 40 seconds. The auto high-beam indicator in the meter will blink twice.

**Re-enabling the system:** Pull the light switch lever towards you and hold it for at least 30 seconds. The auto high-beam indicator in the meter will blink once.

### Disabling or Re-enabling the System



The auto high-beam is in the previously selected disabled or re-enabled setting each time you start the engine.

\*1: Models with the keyless access system have an **ENGINE START/STOP** button instead of an ignition switch.

## Daytime Running Lights

---

The high beam headlights come on slightly dimmer than normal when the following conditions have been met:

- The ignition switch is in ON \*1.
- The headlight switch is OFF, or in AUTO or .
- The parking brake is released.

The high beam headlights return to original brightness once the headlight switch is turned on.

The lights remain on even if you set the parking brake. Turning off the ignition switch or setting the power mode to VEHICLE OFF will turn off the daytime running lights.

The daytime running lights are off once the headlight switch is turned on, or when the head light switch is in AUTO and it is getting darker outside.

\*1: Models with the smart entry system have an **ENGINE START/STOP** button instead of an ignition switch.



## Wipers and Washers

### ■ Windshield Wiper/Washer

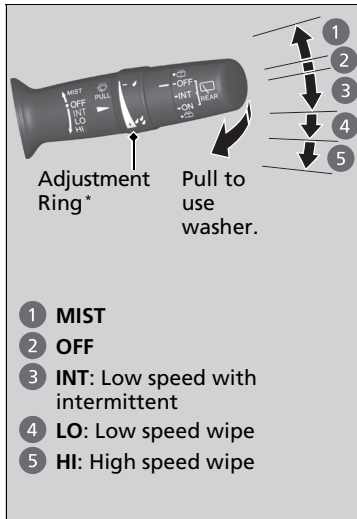

The windshield wipers and washers can be used when the ignition switch is in ON \*1.

#### ■ MIST

The wipers run at high speed until you release the lever.

#### ■ Wiper switch (OFF, INT, LO, HI)

Change the wiper switch setting according to the amount of rain.

#### ■ Washer

Sprays while you pull the lever toward you. When you release the lever for more than one second, the spray stops, the wipers sweep two or three more times to clear the windshield, then stop.

#### ■ Adjusting wiper operation\*

Turn the adjustment ring to adjust the wiper operation.

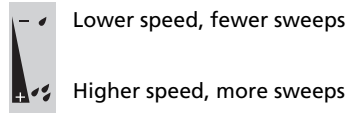

\*1: Models with the smart entry system have an **ENGINE START/STOP** button instead of an ignition switch.

\* Not available on all models

*Continued*

### ▶▶ Wipers and Washers

#### NOTICE

Do not use the wipers when the windshield is dry. The windshield will get scratched, or the rubber blades will get damaged.

#### NOTICE

In cold weather, the blades may freeze to the windshield. Operating the wipers in this condition may damage the wipers. Use the defogger to warm the windshield, then turn the wipers on.

#### Models with adjustment ring

If the vehicle speeds up while the wipers are operating intermittently, the length of the wipe interval shortens. When the vehicle speeds up, the wiper operation's shortest delay setting and the LO setting become the same.

#### All models

Turn the washers off if no washer fluid comes out. The pump may get damaged.

## ■ Rear Wiper/Washer



The rear wiper and washer can be used when the ignition switch is in ON \*1.

### ■ Wiper switch (OFF, INT, ON)

Change the wiper switch setting according to the amount of rain.

### ■ Washer

Sprays while you rotate the switch to this position.

Hold it to activate the wiper and to spray the washer. Once released, it stops operating after a few more sweeps.

### ■ Operating in reverse

When you shift the transmission to with the windshield wipers activated, the rear wiper operates automatically as follows even if its switch is off.

Front Wiper Position	Rear Wiper Operation
INT (Intermittent)	Intermittent
LO (Low speed wipe) HI (High speed wipe)	Continuous

## ▣ Wipers and Washers

If the wiper stops operating due to an obstacle such as the build-up of snow, park the vehicle in a safe place.



Rotate the wiper switch to **OFF**, and turn the ignition switch to ACCESSORY or LOCK \*1, then remove the obstacle.

The wiper motor may stop motor operation temporarily to prevent an overload. Wiper operation will return to normal within a few minutes, once the circuit has returned to normal.

\*1: Models with the smart entry system have an **ENGINE START/STOP** button instead of an ignition switch.

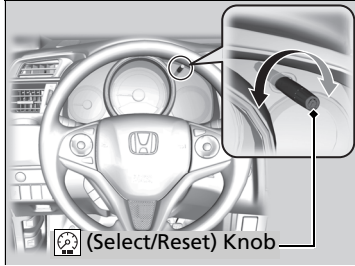
## Brightness Control



When the parking lights are turned on and the ignition switch is in ON \*1, you can use the  (select/reset) knob to adjust instrument panel brightness.

**Brighten:** Turn the knob to the right.

**Dim:** Turn the knob to the left.

You will hear a beep when the brightness reaches minimum or maximum. Several seconds after you have adjusted the brightness, you will be returned to the previous screen.

### ■ Brightness level indicator

The brightness level is shown on the display while you are adjusting it.

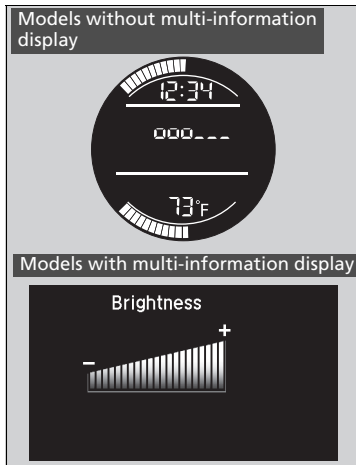

\*1: Models with the smart entry system have an **ENGINE START/STOP** button instead of an ignition switch.

### ☒ Brightness Control

Instrument panel brightness varies, depending on whether the exterior lights are on or off. The instrument panel dims to reduce glare when they are on.

To cancel the reduced instrument panel brightness when the exterior lights are on, turn the  knob to the right until the brightness display is up to max, the beeper sounds.

The brightness can be set differently for when the exterior lights are on, and when they are off.

## Rear Defogger/Heated Door Mirror\* Button

Models with heating and cooling system

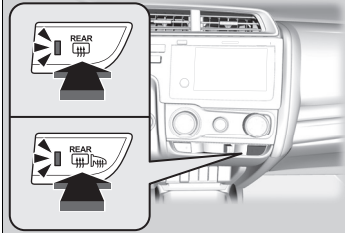

Models with climate control system

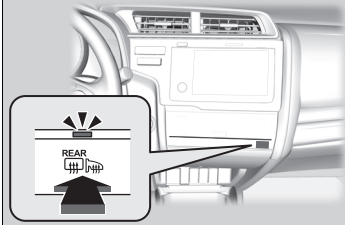

Press the rear defogger and heated door mirror button or touch the icon to defog the rear window and mirrors when the ignition switch is in ON \*1.

Models with climate control system

The rear defogger and heated door mirror automatically switch off after 10-30 minutes depending on the outside temperature. However, if the outside temperature is 32°F (0°C) or below, it does not automatically switch off.

### ⌘ Rear Defogger/Heated Door Mirror\* Button

#### NOTICE

When cleaning the inside of the rear window, be careful not to damage the heating wires. It is critical to wipe the window from side to side along the defogger heating wires.

This system consumes a lot of power, so turn it off when the window has been defogged or deiced. Also, do not use the system for a long period when the engine is idling. This may weaken the battery, making it difficult to start the engine.

\*1 : Models with the smart entry system have an **ENGINE START/STOP** button instead of an ignition switch.

\* Not available on all models

## Adjusting the Steering Wheel

The steering wheel height and distance from your body can be adjusted so that you can comfortably grip the steering wheel in an appropriate driving posture.

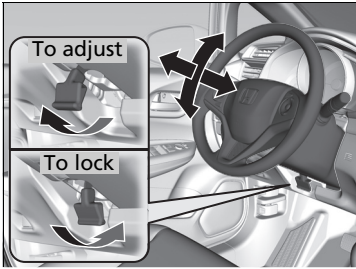

1. Pull the steering wheel adjustment lever up.
  - ▶ The steering wheel adjustment lever is under the steering column.
2. Move the steering wheel up or down, and in or out.
  - ▶ Make sure you can see the instrument panel gauges and indicators.
3. Push the steering wheel adjustment lever down to lock the steering wheel in position.
  - ▶ After adjusting the position, make sure you have securely locked the steering wheel in place by trying to move it up, down, in, and out.

### Adjusting the Steering Wheel

#### **WARNING**

Adjusting the steering wheel position while driving may cause you to lose control of the vehicle and be seriously injured in a crash.

Adjust the steering wheel only when the vehicle is stopped.

# Adjusting the Mirrors

## Interior Rearview Mirror

Adjust the angle of the rearview mirror when you are sitting in the correct driving position.

### Interior Rearview Mirror

Keep the inside and outside mirrors clean and adjusted for best visibility.

Adjust the mirrors before you start driving.

➤ **Front Seats** P. 175

### Rearview Mirror with Day and Night Positions

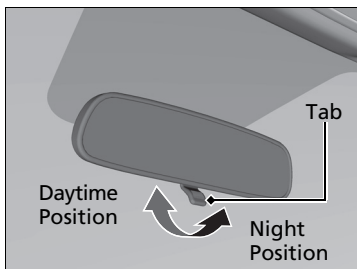

Flip the tab to switch the position. The night position will help to reduce the glare from headlights behind you when driving after dark.

## Power Door Mirrors

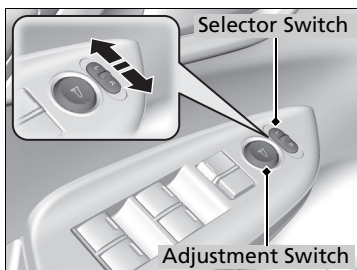

You can adjust the door mirrors when the ignition switch is in ON \*1.

### Mirror position adjustment

**L/R selector switch:** Select the left or right mirror. After adjusting the mirror, return the switch to the center position.

**Mirror position adjustment switch:** Press the switch left, right, up, or down to move the mirror.

\*1: Models with the smart entry system have an **ENGINE START/STOP** button instead of an ignition switch.

## Front Seats

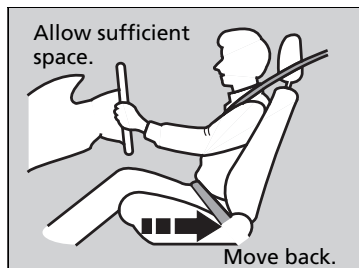

Adjust the driver's seat as far back as possible while allowing you to maintain full control of the vehicle. You should be able to sit upright, well back in the seat and be able to adequately press the pedals without leaning forward, and grip the steering wheel comfortably. The passenger's seat should be adjusted in a similar manner, so that it is as far back from the front airbag in the dashboard as possible.

### Adjusting the Seats

#### **⚠ WARNING**

**Sitting too close to a front airbag can result in serious injury or death if the front airbags inflate.**

**Always sit as far back from the front airbags as possible while maintaining control of the vehicle.**

The National Highway Traffic Safety Administration and Transport Canada recommend that drivers allow at least 10 inches (25 cm) between the center of the steering wheel and the chest.

Always make seat adjustments before driving.

## ■ Adjusting the Seat Positions

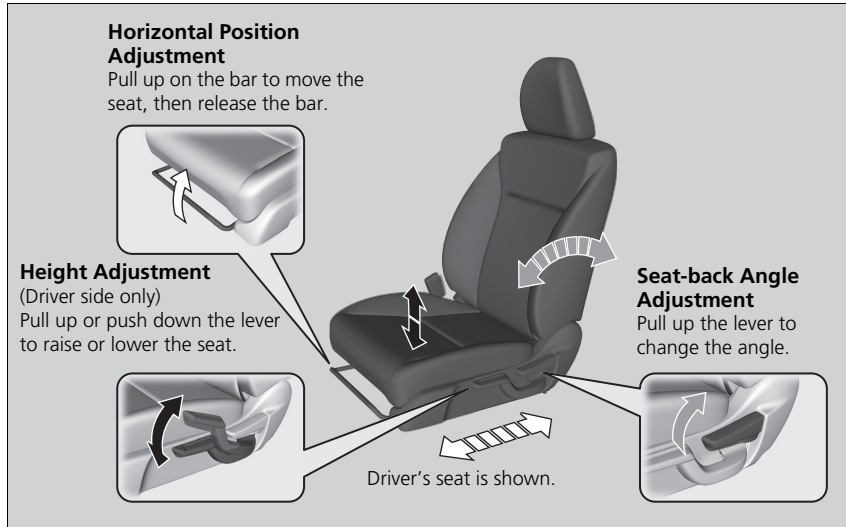

## ► Adjusting the Seat Positions

Once a seat is adjusted correctly, rock it back and forth to make sure it is locked in position.



## ■ Adjusting the Seat-Backs

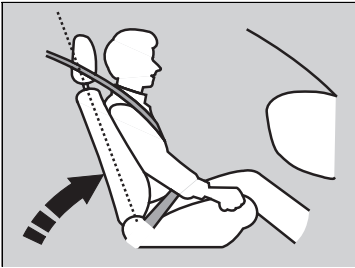

Adjust the driver's seat-back to a comfortable, upright position, leaving ample space between your chest and the airbag cover in the center of the steering wheel.

The front seat passenger should also adjust their seat-back to a comfortable, upright position.

Reclining a seat-back so that the shoulder part of the belt no longer rests against the occupant's chest reduces the protective capability of the belt. It also increases the chance of sliding under the belt in a crash and being seriously injured. The farther a seat-back is reclined, the greater the risk of injury.

## ▣ Adjusting the Seat-Backs

### **⚠ WARNING**

**Reclining the seat-back too far can result in serious injury or death in a crash.**

**Adjust the seat-back to an upright position, and sit well back in the seat.**

Do not put a cushion, or other object, between the seat-back and your back.

Doing so may interfere with proper seat belt or airbag operation.

If you cannot get far enough away from the steering wheel and still reach the controls, we recommend that you investigate whether some type of adaptive equipment may help.

## ■ Reclining the Front Seats

Reclining the seat-backs on the front seats until they are level with the rear seat cushions provides a large cushioned area that can (and should only) be used when the vehicle is safely parked.

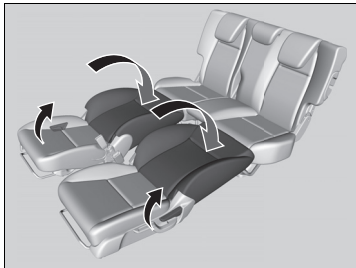

1. Remove the front head restraints while pushing the release button.
  - Store the head restraints in the cargo area.
2. Adjust the front seats forward as far as possible.
3. While pulling the seat-back angle adjustment lever, pivot the seat-back backward until it is level with the rear seat cushion.
4. Move the front seat backward until it touches the rear seat.
5. Unlatch the detachable anchor from the anchor buckle, and store the rear center seat belt.
  - **Seat Belt with Detachable Anchor** P. 43
6. Adjust the rear seat-back to the desired position.

To return the front seats and rear center seat belt to their original positions, reverse this procedure.

When you return a seat-back to its upright position, hold the seat-back to keep it from going up too quickly.

## ► Reclining the Front Seats

Both front seats must be returned to their normal upright position, and the head restraints reinstalled and properly adjusted before driving.

### ► **Removing and Reinstalling the Head Restraints** P. 184

## Rear Seats

### ■ Rear Seat-back Adjusting

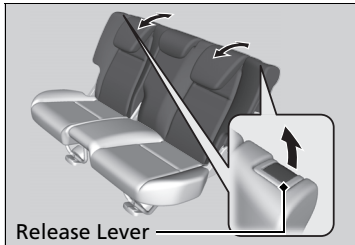

Pull the lever on the right to change the angle of the right half of the seat-back, and left for the left half.

## ■ Folding Down the Rear Seats

The rear seats can be folded down separately to allow for additional storage space.

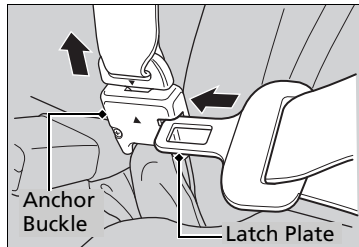

### ■ To fold down the seat

1. Store the center seat belt first. Insert the latch plate into the slot on the side of the anchor buckle.
2. Retract the seat belt into the holder on the ceiling.
3. Lower the head restraint to its lowest position.  
    ❑ **Seat Belt with Detachable Anchor** P. 43
4. Pull the release lever and fold down the seat-back.

To return the seat to the original position, pull up the seat-back in the upright position.

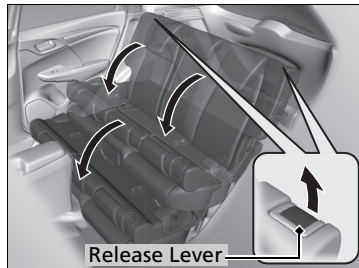

## ❑ Folding Down the Rear Seats

**Make sure all items in the cargo area or items extending to the rear seats are properly secured. Loose items can fly forward if you have to brake hard.**

Remove any items from the rear seat cushion and floor before you fold down the rear seat.

To lock the seat-back upright, push it backwards until it locks.

Make sure the seat-back, head restraints and seat cushion are securely latched back into place before driving. Also, make sure all rear shoulder belts are positioned in front of the seat-back, and the center shoulder belt is re-positioned in the holding slot.

Make sure that the folded seat-back does not press against the front passenger seat, as this can cause the weight sensors in the front passenger seat to work improperly.

❑ **Passenger Front Airbag Off Indicator** P. 58

## ■ Folding the Rear Seat Up

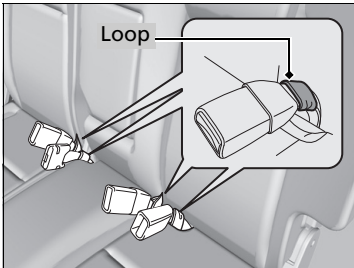

Separately lift up the left and right halves of the rear seat cushions to make room for cargo area.

### ■ Lifting up the seat cushion

1. Make sure the seat belt buckles are in their loops on the seat.
2. Pull up the rear seat cushion.
3. Fold the seat leg down while pushing the seat cushion firmly against the seat-back to lock it.

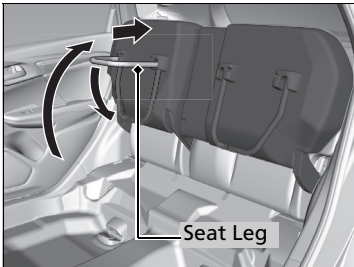

### ■ Putting the seat in the original position

1. Hold the seat cushion in the upright position, and pull up the seat leg fully.
  - ▶ The seat cushion can abruptly fall down once you pull up the seat leg.
2. Slowly put down the seat cushion and set the seat leg in the floor guide.
  - ▶ A latch comes out when the leg is set properly.

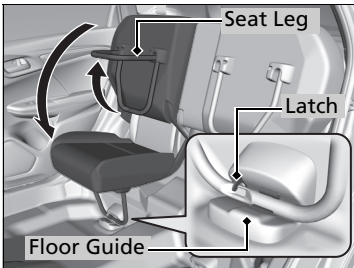

## ▣ Folding the Rear Seat Up

After you fold the seat up, or put it back in the original position, make sure the seat is firmly secured by rocking it forward and back.

Check if there are any items on the seat before you pull the seat cushion up. Check if there are any obstacles around the floor guide before you put the seat back in the original position.

## Head Restraints

Your vehicle is equipped with head restraints in all seating positions.

### ■ Adjusting the front head restraint positions

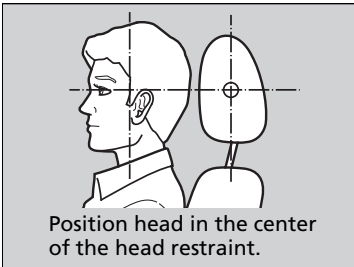

Head restraints are most effective for protection against whiplash and other rear-impact crash injuries when the center of the back of the occupant's head rests against the center of the restraint. The tops of the occupant's ears should be level with the center height of the restraint.

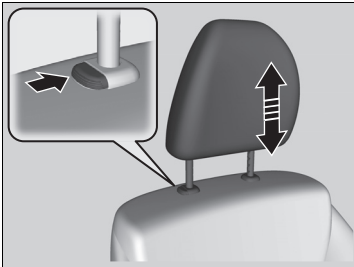

**To raise the head restraint:** Pull it upward.  
**To lower the head restraint:** Push it down while pressing the release button.

### ► Adjusting the front head restraint positions

#### **⚠ WARNING**

Improperly positioning head restraints reduces their effectiveness and increases the likelihood of serious injury in a crash.

**Make sure head restraints are in place and positioned properly before driving.**

In order for the head restraint system to work properly:

- Do not hang any items on the head restraints, or from the restraint legs.
- Do not place any objects between an occupant and the seat-back.
- Install each restraint in its proper location.

## ■ Changing the Rear Seat Head Restraint Positions

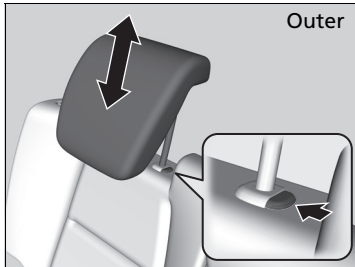

A passenger sitting in a back seating position should adjust the height of their head restraint to an appropriate position before the vehicle begins moving.

**To raise the head restraint:**

Pull it upward.

**To lower the head restraint:**

Push it down while pressing the release button.

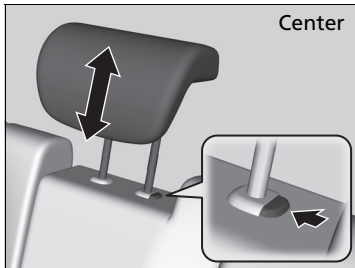

## ■ Removing and Reinstalling the Head Restraints

Head restraints can be removed for cleaning or repair.

### To remove a head restraint:

Pull the restraint up as far as it will go. Then push the release button, and pull the restraint up and out.

### To reinstall a head restraint:

Insert the legs back in place, then adjust the head restraint to an appropriate height while pressing the release button. Pull up on the restraint to make sure it is locked in position.

## ✎ Removing and Reinstalling the Head Restraints

### **WARNING**

Failure to reinstall, or correctly reinstall, the head restraints can result in severe injury during a crash.

Always replace the head restraints before driving.

To remove and install the rear outer head restraint, recline the seat-back slightly forward as the space between the ceiling and the seat-back is limited.



## Maintain a Proper Sitting Position

After all occupants have adjusted their seats and head restraints, and put on their seat belts, it is very important that they continue to sit upright, well back in their seats, with their feet on the floor, until the vehicle is safely parked and the engine is off.

Sitting improperly can increase the chance of injury during a crash. For example, if an occupant slouches, lies down, turns sideways, sits forward, leans forward or sideways, or puts one or both feet up, the chance of injury during a crash is greatly increased.

In addition, an occupant who is out of position in the front seat can be seriously or fatally injured in a crash by striking interior parts of the vehicle or being struck by an inflating front airbag.

### ⓘ Maintain a Proper Sitting Position

#### **⚠ WARNING**

**Sitting improperly or out of position can result in serious injury or death in a crash.**

**Always sit upright, well back in the seat, with your feet on the floor.**

## Armrest\*

### ■ Using the Front Seat Armrest

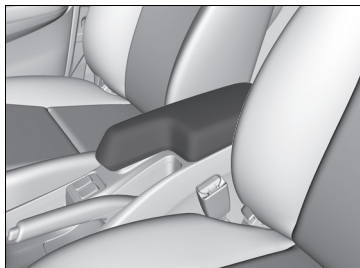

The console lid can be used as an armrest.

## Interior Lights

### Interior Light Switches

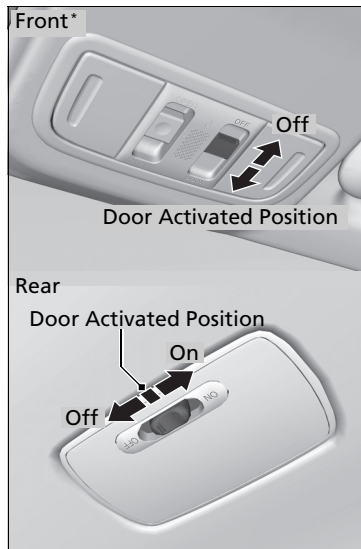

#### ■ ON

The interior lights come on regardless of whether the doors are open or closed.

#### ■ Door activated

The interior lights come on in the following situations:

- When any doors are opened.
- You unlock the driver's door.

#### Models without smart entry system

- You remove the key from the ignition switch.

#### Models with smart entry system

- When the power mode is set to VEHICLE OFF (LOCK).

#### ■ OFF

The interior lights remain off regardless of whether the doors are open or closed.

### Interior Light Switches

In the door activated position, the interior lights fade out and go off about 30 seconds after the doors are closed.

The lights go off after 30 seconds in the following situations:

- When you unlock the driver's door but do not open it.

#### Models without smart entry system

- When you remove the key from the ignition switch but do not open a door.

#### Models with smart entry system

- When you set the power mode to VEHICLE OFF (LOCK) but do not open a door.

The interior lights go off immediately in the following situations:

- When you lock the driver's door.
- When you turn the ignition switch to ON \*1.

#### Models without smart entry system

- When you close the driver's door with the key in the ignition switch.

#### Models with smart entry system

- When you close the driver's door in ACCESSORY mode.

If you leave any of the doors open in VEHICLE OFF (LOCK) mode, or without the key in the ignition switch, the interior lights go off after about 15 minutes.

\*1: Models with the smart entry system have an **ENGINE START/STOP** button instead of an ignition switch.

\* Not available on all models

## Map Lights

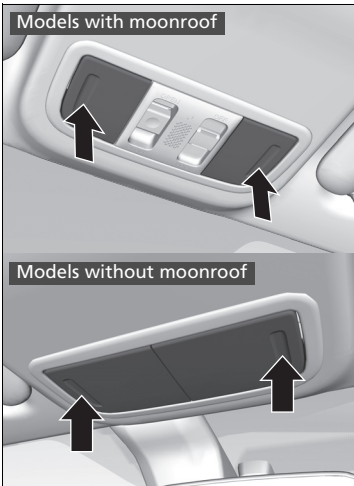

The map lights can be turned on and off by pressing the lenses.

## Cargo Area Light

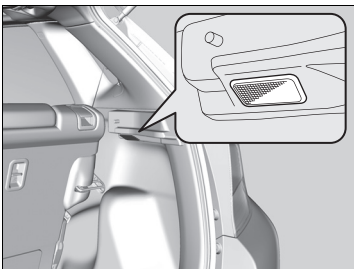

The light comes on when you open the tailgate, and goes off when closed.

## Map Lights

### Models with moonroof

When the interior light switch is in the door activated position and any door is open, the map light will not go off when you press the lens.

## Interior Convenience Items

### ■ Glove Box

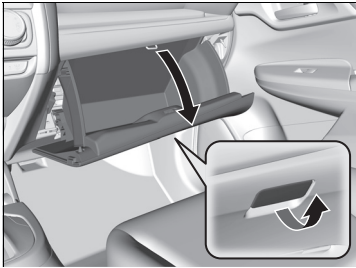

Pull the handle to open the glove box.

### ■ Console Compartment\*

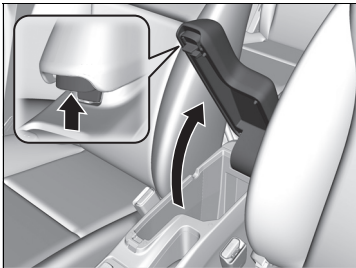

Pull the handle to open the console compartment.

### ☒ Glove Box

#### **⚠ WARNING**

An open glove box can cause serious injury to your passenger in a crash, even if the passenger is wearing the seat belt.

Always keep the glove box closed while driving.

\* Not available on all models

## ■ Beverage Holders

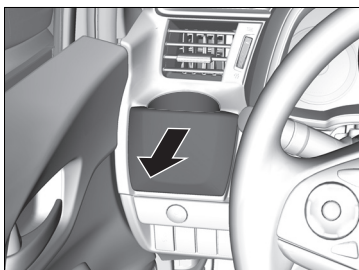

■ **Front seat beverage holders**  
Pull the lid backward to use the front panel beverage holder.

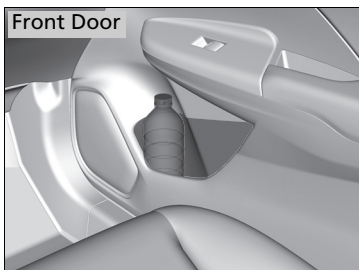
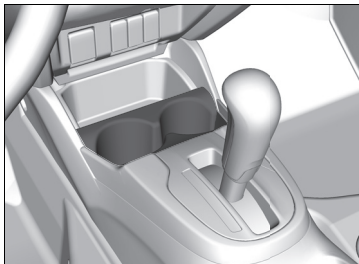

Front Door

The beverage holder is at the front of each door.

## ☞ Beverage Holders

### NOTICE

Spilled liquids can damage the upholstery, carpeting, and electrical components in the interior.

Be careful when you are using the beverage holders. Hot liquid can scald you.

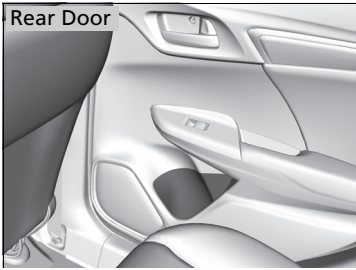

■ **Rear seat beverage holders**

The beverage holder is at the front of each door.

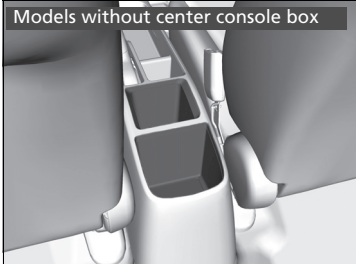

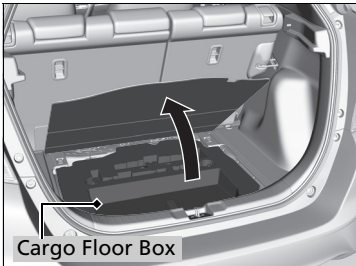

■ **Cargo Floor Box**



Pull up the cargo area floor lid.

## ■ Accessory Power Socket(s)

The accessory power socket can be used when the ignition switch must be in ACCESSORY  or ON \*1.

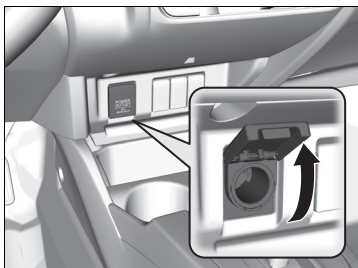

### ■ Accessory power socket (console panel)

Open the cover to use it.

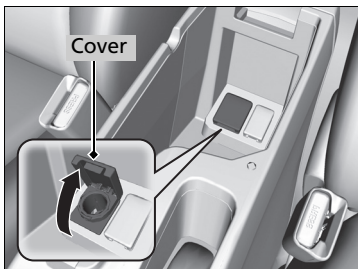

### ■ Accessory power socket (console compartment)\*

Open the console lid and the cover to use it.

## » Accessory Power Socket(s)

### NOTICE

Do not insert an automotive type cigarette lighter element.

This can overheat the power socket.

The accessory power socket is designed to supply power for 12-volt DC accessories that are rated 180 watts (15 amps) or less.

To prevent battery drain, use the power socket only when the engine is running.

\*1 : Models with the smart entry system have an **ENGINE START/STOP** button instead of an ignition switch.

\* Not available on all models



## ■ Coat Hook

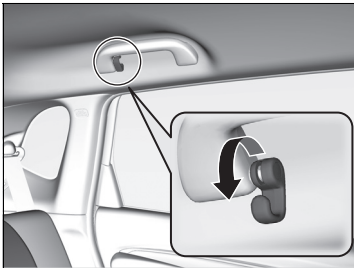

There is a coat hook on the rear left grab handle. Pull it down to use it.

## ☒ Coat Hook

The coat hook is not designed for large or heavy items.

## ■ Tie-down Anchors

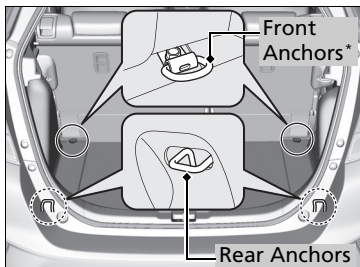

The tie-down anchors on the cargo area floor can be used to install a net for securing items.

## ■ Cargo Area Cover\*

The cargo area cover may be removed to give you more cargo room.

### ■ To remove the cargo area cover

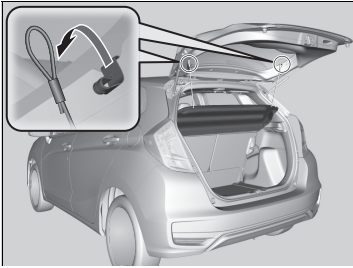

1. Open the tailgate.
2. Remove the strap on each side of the tailgate.

3. Disengage the support rods, then remove the cargo area cover.

Reverse this procedure to install the cargo area cover.

After reinstalling the cargo area cover, make sure it is latched securely.

## ▣ Cargo Area Cover\*

Do not place items on the cargo area cover, or stack objects higher than the top of the back seat. They could block your view and be thrown about the vehicle during a crush or sudden stop.

Do not apply excessive pressure to the cover, such as leaning on it to retrieve an item.

\* Not available on all models

## ■ Seat Heaters\*



The ignition switch must be in ON **II**\*1 to use the seat heaters. The **HI** setting heats the seats faster than the **LO** setting.

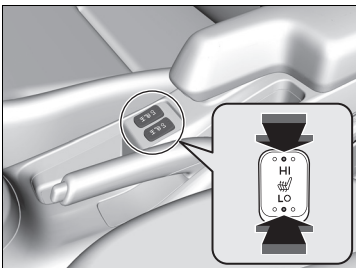

While in **HI**, the heater cycles on and off.

- The appropriate indicator will be on while the seat heater is on. Briefly press the switch on the opposite side to turn the heater off. The indicator will be off. When a comfortable temperature is reached, select **LO** to keep the seat warm.

## ▣ Seat Heaters\*

### ⚠ WARNING

Heat induced burns are possible when using seat heaters.

Persons with a diminished ability to sense temperature (e.g., persons with diabetes, lower-limb nerve damage, or paralysis) or with sensitive skin should not use seat heaters.

Do not use the seat heaters even in **LO** when the engine is off. Under such conditions, the battery may be weakened, making the engine difficult to start.

In the **LO** setting, the heater runs continuously and does not automatically turn off.

\*1: Models with the smart entry system have an **ENGINE START/STOP** button instead of an ignition switch.

\* Not available on all models

## Using Vents, Heating and A/C\*

The diagram shows a car's climate control panel with the following controls and functions:



- Mode Control Dial:** Change airflow. It has five settings: Dashboard vents, Floor and dashboard vents, Floor vents, Floor and windshield defroster vents, and Windshield defroster vents.
- Fan Control Dial:** Adjusts the fan speed. Rotate the dial all the way to **OFF** to turn everything off.
- Temperature Control Dial:** Adjusts the interior temperature.
- A/C Button:** Press to cool the interior or dehumidify while heating.
- Fresh Air/Recirculation Lever:** This lever controls the source of the air going into the system.
  - (Recirculation) Mode:** Recirculates air from the vehicle's interior through the system.
  - (Fresh Air) Mode:** Maintains outside ventilation. Keep the system in fresh air mode in normal situations.

\* Not available on all models

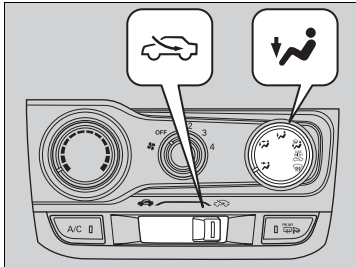

## ■ Heating



The heater uses heat from the engine coolant to warm the air.



1. Adjust the fan speed using the fan control dial.
2. Select  and .
3. Adjust the temperature using the temperature control dial.

### ■ To rapidly warm up the interior

1. Set the fan to the maximum speed.
2. Select .
3. Set the temperature to maximum warm.
4. Select .

### ■ To dehumidify the interior\*

When used in combination with the heater, the air conditioning system makes the interior warm and dry and can prevent the windows from fogging up.

1. Turn the fan on.
2. Press the **A/C** button to turn on the air conditioning.
3. Select  and . Adjust the temperature to your preference.

### ☒ To rapidly warm up the interior

Change to fresh air mode as soon as the interior gets warm enough. The windows may fog up if kept in recirculation mode.

**Cooling\***

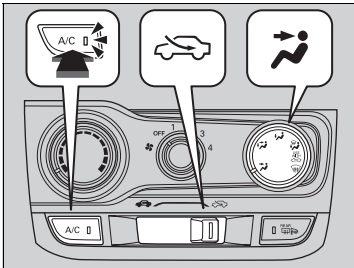

1. Adjust the fan speed using the fan control dial.
2. Select and .
3. Adjust the temperature using the temperature control dial.
4. Press the **A/C** button (indicator on).

**To rapidly cool down the interior**

1. Set the fan to the maximum speed.
2. Set the temperature to maximum cool.
3. Select .

►► To rapidly cool down the interior

If the interior is very warm, you can cool it down more rapidly by partially opening the windows.

**Models with ECON button**

While ECON mode is active, the heating and cooling system may have reduced cooling performance.

**Defrosting the Windshield and Windows\***

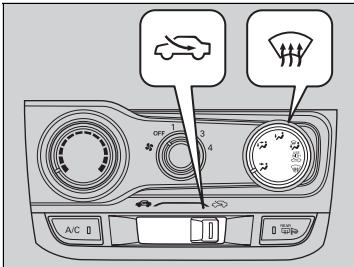

1. Selecting turns the air conditioning system on.
2. Select .

**To rapidly defrost the windows**

1. Set the fan to the maximum speed.
2. Select .
3. Select .
4. Set the temperature to maximum warm.

►► Defrosting the Windshield and Windows\*

**For your safety, make sure you have a clear view through all the windows before driving.**

Do not set the temperature near the upper or lower limit.

When cold air hits the windshield, the outside of the windshield may fog up.

If the side windows fog up, adjust the vents so that the air hits the side windows.

►► To rapidly defrost the windows

After defrosting the windows, switch over to fresh air mode.

If you keep the system in recirculation mode, the windows may fog up from humidity. This impedes visibility.

\* Not available on all models

## Using Automatic Climate Control

The automatic climate control system maintains the interior temperature you select. The system also selects the proper mix of heated or cooled air that raises or lowers the interior temperature to your preference as quickly as possible.

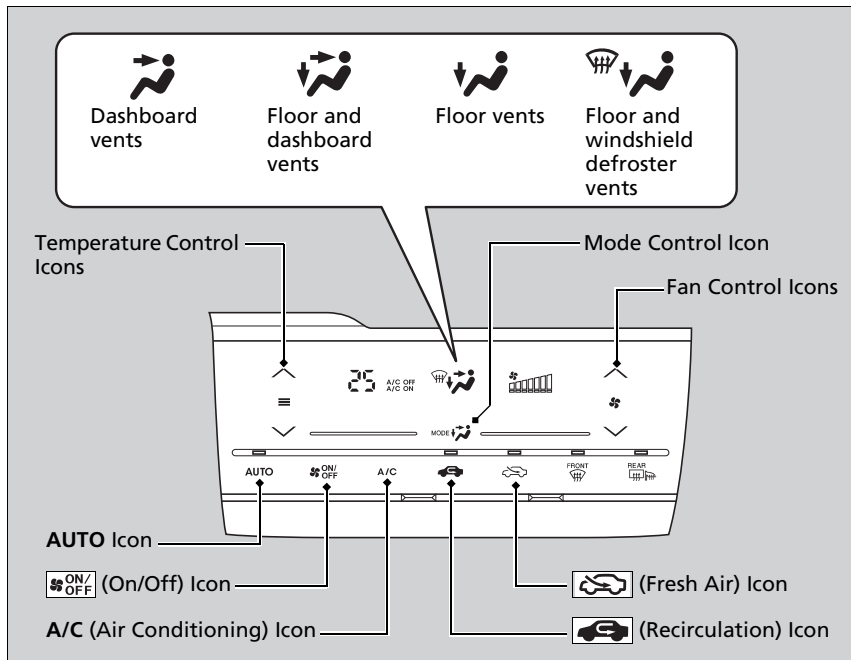

Use the system when the engine is running.

1. Select the **AUTO** icon.
2. Adjust the interior temperature using the temperature control icons.
3. Select the  icon to cancel.

\* Not available on all models

### Using Automatic Climate Control

If any icons are selected while using the climate control system in auto, the function of the icon that was selected will take priority. The **AUTO** indicator will go off, but functions unrelated to the icon that was selected will be controlled automatically.

To prevent cold air from blowing in from outside, the fan may not start immediately when the **AUTO** icon is selected.

If the interior is very warm, you can cool it down more rapidly by partially opening the windows, turning the system on auto, and setting the temperature to low. Change the fresh mode to recirculation mode until the temperature cools down.

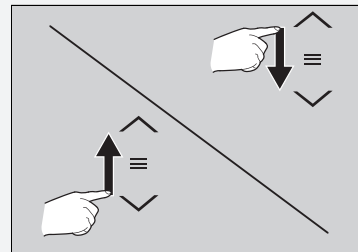

When you set the temperature to the lower or upper limit, **Lo** or **Hi** is displayed.

You can raise or lower the temperature or fan speed setting flicking either control icon.





### ■ Switching between the recirculation and fresh air modes

Select the  or  icon to switch the mode depending on environmental conditions.

 Recirculation mode (indicator on): Recirculates air from the vehicle's interior through the system.

 Fresh air mode (indicator on): Maintains outside ventilation. Keep the system in fresh air mode in normal situations.

### ■ Defrosting the Windshield and Windows

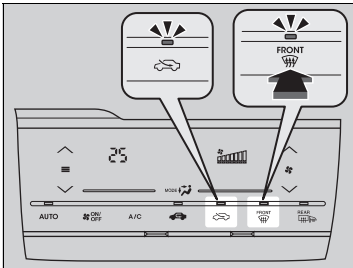

Select the  icon to turn the air conditioning system on and automatically switch the system to fresh air mode.

Select the  icon again to turn off, the system returns to the previous settings.

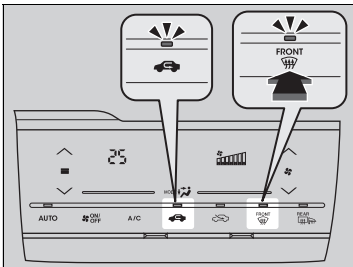

### ■ To rapidly defrost the windows

1. Select the  icon.
2. Select the  icon.

### ▣ Using Automatic Climate Control

Selecting the  icon switches the climate control system between on and off. When turned on, the system returns to your last selection.

### ▣ Models with ECON button

While ECON mode is active, the climate control system may have reduced cooling performance.

### ▣ Defrosting the Windshield and Windows

**For your safety, make sure you have a clear view through all the windows before driving.**

Do not set the temperature near the upper or lower limit.

When cold air hits the windshield, the outside of the windshield may fog up.

If the side windows fog up, adjust the vents so that the air hits the side windows.

### ▣ To rapidly defrost the windows



After defrosting the windows, switch over to fresh air mode. If you keep the system in recirculation mode, the windows may fog up from humidity. This impedes visibility.

## ■ Turning On and Off the Touch Screen Beep

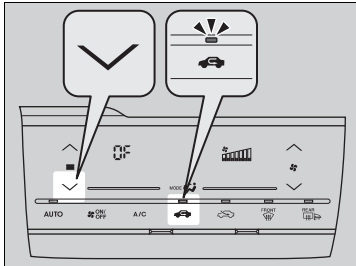
You hear the beep when operating the climate control system on the touch screen. This can be turned on and off.



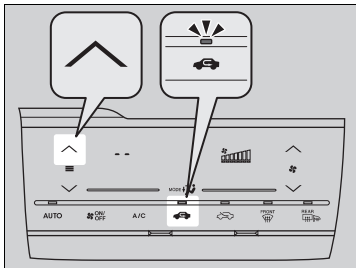

### To turn off the beep:

1. Set the power mode to ON.
2. Touch the  icon of the temperature control icon five times while pressing and holding the  icon.
3. Release the  icon, after -- blinks five times and **OF** is displayed.



### To turn on the beep:

1. Set the power mode to ON.
2. Touch the  icon of the temperature control icon five times while pressing and holding the  icon.
3. Release the  icon, after **OF** blinks five times and -- is displayed.

## ▣ Using Automatic Climate Control

If you touch any other icons during this procedure, the setting may fail. In this case, once you set the power mode to VEHICLE OFF (LOCK), then follow this procedure again.

## ■ Touch Panel Sensitivity Setting

You can set the level of sensitivity of the touch control panel to high, normal, or low.

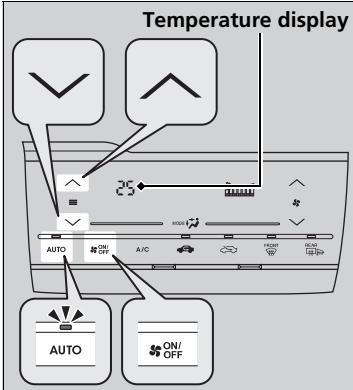

1. Set the power mode to ON.
2. Press and hold the **AUTO** icon, then press any of the following icons five times to set the level.
  - : High (**Hi**)\*1.
    - ▶ Previous setting blinks five times and **Hi** will be displayed in the temperature display area.
  - : Normal (--)  
 ▶ Previous setting blinks five times and -- will be displayed in the temperature display area.
  - : Low (**Lo**)  
 ▶ Previous setting blinks five times and **Lo** will be displayed in the temperature display area.
3. Release the **AUTO** icon.

\*1: Default setting

## ▣ Touch Panel Sensitivity Setting

If you touch any other icons during this procedure, the setting may fail. In this case, once you set the power mode to VEHICLE OFF (LOCK), then follow this procedure again.

## Automatic Climate Control Sensors

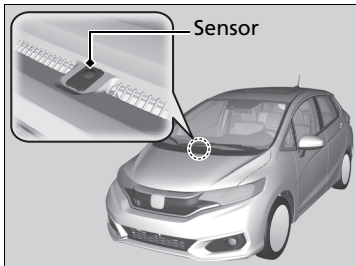

The automatic climate control system is equipped with sensors. Do not cover or spill any liquid on them.

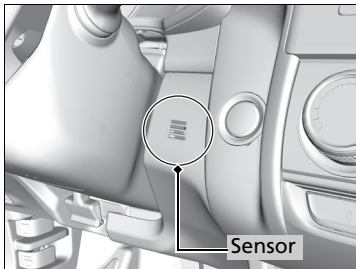

# Features

This chapter describes how to operate technology features.



<b>Audio System</b>	
About Your Audio System .....	206
USB Port(s) .....	207
Audio System Theft Protection .....	208
Audio Antenna .....	209
Audio Remote Controls* .....	210
<b>Models with color audio system</b>	
<b>Audio System Basic Operation</b> .....	212
Audio/Information Screen .....	213
Adjusting the Sound .....	217
Display Setup .....	218
Playing AM/FM Radio .....	219
Playing a CD .....	221
Playing an iPod .....	224
Playing a USB Flash Drive .....	227

Playing <i>Bluetooth</i> ® Audio .....	230
<b>Models with display audio system</b>	
<b>Audio System Basic Operation</b> .....	233
Audio/Information Screen .....	234
Adjusting the Sound .....	249
Display Setup .....	250
Playing AM/FM Radio .....	255
Playing an iPod .....	267
Playing Pandora® .....	274
Playing a USB Flash Drive .....	276
Playing <i>Bluetooth</i> ® Audio .....	279
HondaLink® .....	281
Siri® Eyes Free .....	288
<b>Audio Error Messages</b> .....	312

<b>General Information on the Audio System</b> .....	317
<b>Models with color audio system</b>	
<b>Customized Features</b> .....	321
<b>Models with display audio system</b>	
<b>Customized Features</b> .....	328
<b>Bluetooth® HandsFreeLink®</b>	
<b>Models with color audio system</b>	
Using HFL .....	343
<b>Models with display audio system</b>	
Using HFL .....	368

\* Not available on all models

## About Your Audio System

The audio system features AM/FM radio and SiriusXM® Radio service\*. It can also play audio CDs\*, WMA/MP3/AAC files, USB flash drives, and iPod, iPhone and Bluetooth® devices.

You can operate the audio system from the buttons and switches on the panel, the remote controls\* on the steering wheel, or the icons on the touchscreen interface\*.

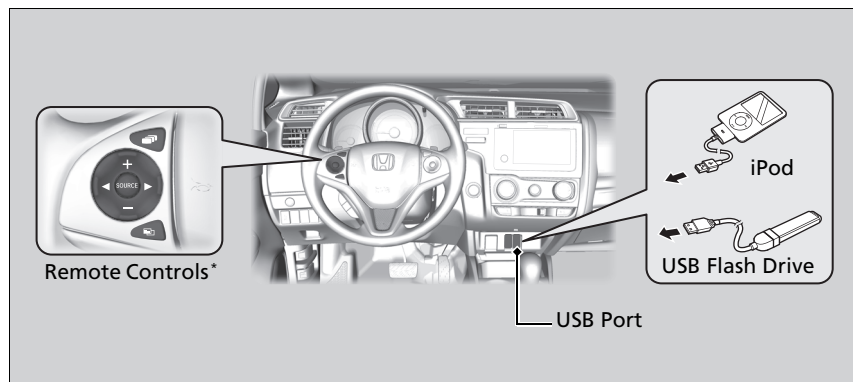

### About Your Audio System

Video CDs, DVDs, and 3-inch (8-cm) mini CDs are not supported.

iPod, iPhone and iTunes are trademarks of Apple Inc.

State or local laws may prohibit the operation of handheld electronic devices while operating a vehicle.

When the screen is viewed through polarized sunglasses, a rainbow pattern may appear on the screen due to optical characteristics of the screen. If this is disturbing, please operate the screen without polarized sunglasses.

SiriusXM® Radio\* is available on a subscription basis only. For more information on SiriusXM® Radio\*, contact a dealer.

**General Information on the Audio System**  
P. 317

SiriusXM® Radio\* is available in the United States and Canada, except Hawaii, Alaska, and Puerto Rico.

SiriusXM®\* is a registered trademark of SiriusXM Radio, Inc.

## USB Port(s)

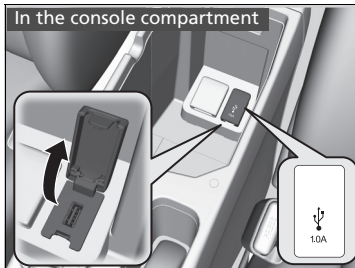
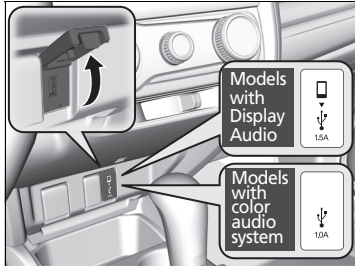

Install the iPod USB connector or the USB flash drive to the USB port.

### Models with color audio system

- ▶ The USB port (1.0A) is for playing audio files on a USB flash drive and connecting a cellular phone and charging device.

### Models with Display Audio

- ▶ The USB port (1.5A) is for charging devices, playing audio files and connecting compatible phones with Apple CarPlay™ or Android Auto™.

### ■ In the console compartment\*

The USB port (1.0A) is for playing audio files on the USB flash drive and connecting a cellular phone and charging device.

### ⊞ USB Port(s)

- Do not leave the iPod or USB flash drive in the vehicle. Direct sunlight and high temperatures may damage it.
- We recommend using an extension cable with the USB port.
- Do not connect the iPod or USB flash drive using a hub.
- Do not use a device such as a card reader or hard disk drive, as the device or your files may be damaged.
- We recommend keeping your data backed up before using the device in your vehicle.
- Displayed messages may vary depending on the device model and software version.

If the audio system does not recognize the iPod, try reconnecting it a few times or reboot the device. To reboot, follow the manufacturer's instructions provided with the iPod or visit [www.apple.com/ipod](http://www.apple.com/ipod).

### USB charge (1.0A/1.5A)

The USB port can supply up to 1.0A/1.5A of power. It does not output 1.0A/1.5A unless requested by the device.

For amperage details, read the operating manual of the device that needs to be charged.

Turn the ignition switch to ACCESSORY **I** or ON **II**\*1 first.

Under certain conditions, a device connected to the port may generate noise in the radio you are listening to.

\*1: Models with the smart entry system have an **ENGINE START/STOP** button instead of an ignition switch.

\* Not available on all models

## Audio System Theft Protection

---

The audio system is disabled when it is disconnected from the power source, such as when the battery is disconnected or goes dead. In certain conditions, the system may display a code entry screen. If this occurs, reactivate the audio system.

### ■ Reactivating the audio system

1. Turn the ignition switch to ON \*1.
2. Turn on the audio system.
3. Press and hold the audio system power button for more than two seconds.
  - ▶ The audio system is reactivated when the audio control unit establishes a connection with the vehicle control unit. If the control unit fails to recognize the audio unit, you must go to a dealer and have the audio unit checked.

\*1: Models with the smart entry system have an **ENGINE START/STOP** button instead of an ignition switch.



# Audio Antenna

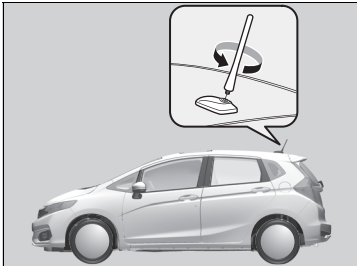

Your vehicle is equipped with a removable antenna at the rear of the roof.

## ▶▶ Audio Antenna

**NOTICE**

Before using a "drive-through" car wash, remove the antenna by unscrewing it by hand. This prevents the antenna from being damaged by the car wash brushes.

## Audio Remote Controls\*

Allow you to operate the audio system while driving.

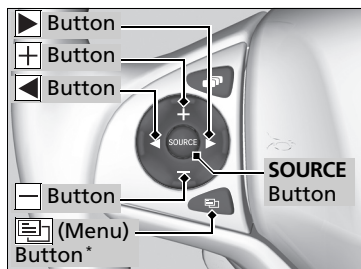

### SOURCE Button

Cycles through the audio modes as follows:

#### Models with color audio system

FM → AM → CD → USB → iPod → Bluetooth® Audio

#### Models with display audio system

FM → AM → SiriusXM® → USB → iPod → Bluetooth® Audio → Pandora®\* → Apps/Apple CarPlay™/Android Auto™

### (Volume) Buttons

**Press** : To increase the volume.

**Press** : To decrease the volume.





### ◀▶ Buttons

- When listening to the radio
  - Press** : To select the next preset radio station.
  - Press** : To select the previous preset radio station.
  - Press and hold** : To select the next strong radio station.
  - Press and hold** : To select the previous strong radio station.
- When listening to the SiriusXM® radio\*
  - Press** : To select the next preset radio station.
  - Press** : To select the previous preset radio station.
  - Press and hold** : To select the next channel.
  - Press and hold** : To select the previous channel.
- When listening to a CD\*, iPod, USB flash drive, or Bluetooth® Audio
  - Press** : To skip to the next song.
  - Press** : To go back to the beginning of the current or previous song.
- When listening to a CD\* or USB flash drive
  - Press and hold** : To skip to the next folder.
  - Press and hold** : To go back to the previous folder.

### ▶▶ Audio Remote Controls\*







Some modes appear only when an appropriate device or medium is used.

Depending on the *Bluetooth*® device you connect, some functions may not be operated.

- When listening to a *Bluetooth*® Audio
  - Press and hold** : To go to the group up.\*<sup>1</sup>
  - Press and hold** : To go to the group down.\*<sup>1</sup>
- When listening to Internet radio\*
  - Press** : To skip to the next song.
  - Press and hold** : To select the next station.
  - Press and hold** : To select the previous station.

#### Models with display audio system

#### Steering Wheel (Menu) Button

- When listening to the radio
  - Press** : To display the menu items. You can select **Scan**, **Save Preset**, or **Seek**.
- When listening to the SiriusXM® radio\*
  - Press** : To display the menu items. You can select **Scan**, **Save Preset**, **Channel**, or **Category**.
- When listening to a USB flash drive
  - Press** : To display the menu items. You can select **Scan**, **Repeat**, or **Random**.
- When listening to an iPod
  - Press** : To display the menu items. You can select **Repeat** or **Shuffle**.
- When listening to a *Bluetooth*® Audio
  - Press** : To display the menu items. You can select **Pause** or **Play**.
- When listening to a Pandora®\*
  - Press** : To display the menu items. You can select **Bookmark**, or **Play/Pause**.

\*1: Available on specific phones only.

\* Not available on all models

#### Audio Remote Controls\*

The  button is available only when the audio mode is FM, AM, CD\*, USB, iPod, Pandora®\*, or *Bluetooth*® Audio.

## Models with color audio system

To use the audio system, the ignition switch must be in ACCESSORY **I** or ON **II**.

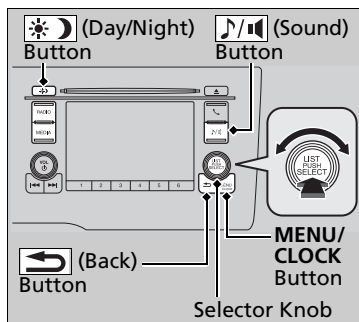

Use the selector knob or **MENU/CLOCK** button to access some audio functions.

Press to switch between the normal and extended display for some functions.

**Selector knob:** Rotate left or right to scroll through the available choices. Press to set your selection.

**MENU/CLOCK button:** Press to select any mode.

The available modes include the wallpaper, display, clock, language setup, and play modes. Play mode choices include scan, random, repeat, and so on.

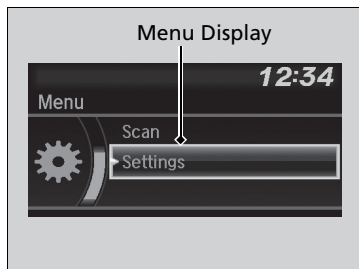

**(Back) button:** Press to go back to the previous display.

**(Sound) button:** Press to select the sound setting mode.

**(Day/Night) button:** Press to change the audio/information screen brightness.

Press , then adjust the brightness using .

- ▶ Each time you press , the mode switches between the daytime mode, nighttime mode and **OFF** mode.

## Audio System Basic Operation

These indications are used to show how to operate the selector knob.

Rotate to select.

Press to enter.

### Menu Items

- ▶ **Adjust Clock** P. 123
- ▶ **Wallpaper Setup** P. 215
- ▶ **Display Setup** P. 218
- ▶ **Scan** P. 220, 223, 229
- ▶ **Play Mode** P. 223, 226, 229
- ▶ **RDS Settings** P. 220
- ▶ **Bluetooth** P. 230

## Models with audio remote controls

Press the **SOURCE**, , , or button on the steering wheel to change any audio setting.

- ▶ **Audio Remote Controls\*** P. 210

One of the operating systems used in this unit is eCos.

For software license terms and condition, visit their website (eCos license URL:

<http://ecos.sourceforge.org/license-overview.html>)

For source code disclosure and other details regarding eCos, visit:

<http://www.hondaopensource2.com>

## Audio/Information Screen

Displays the audio status and wallpaper. From this screen, you can go to various setup options.

### Switching the Display

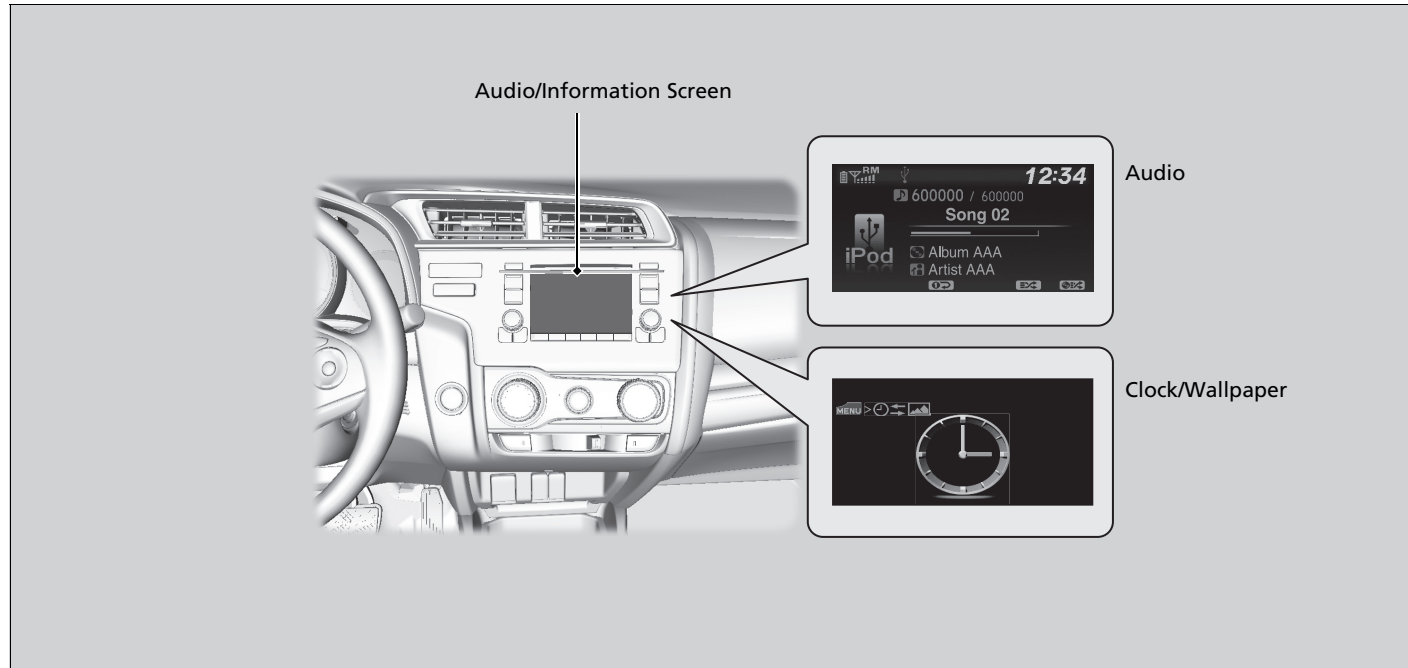





### ■ Audio

Shows the current audio information.

### ■ Clock/Wallpaper

Shows a clock screen or an image you import.

### ■ Change display

1. Press the **MENU/CLOCK** button.
2. Rotate  to select **Settings**, then press .
3. Rotate  to select **Display Change**, then press .
4. Rotate  to select **Wallpaper**, then press .
  - ▶ If you want to return to the audio display, select **Audio**.

## Wallpaper Setup

You can change, store, and delete the wallpaper on the audio/information screen.

### Import wallpaper

You can import up to three images, one at a time, for wallpaper from a USB flash drive.

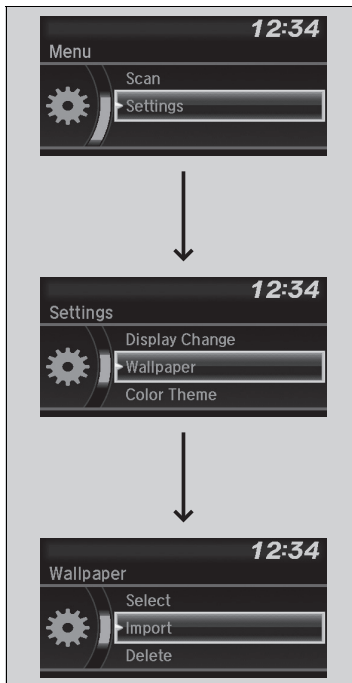









1. Connect the USB flash drive to the USB port.  
▶ **USB Port(s)** P. 207
2. Press the **MENU/CLOCK** button.
3. Rotate to select **Settings**, then press .
4. Rotate to select **Wallpaper**, then press .
5. Rotate to select **Import**, then press .  
▶ The picture name is displayed on the list.
6. Rotate to select a desired picture, then press .  
▶ The selected picture is displayed.
7. Press to save the picture.
8. Press to select **OK**.
9. Rotate to select a location to save the picture, then press .  
▶ The display will return to the wallpaper setting screen.

### Wallpaper Setup







- When importing wallpaper files, the image must be in the USB flash drive's root directory. Images in a folder cannot be imported.
- The file name must be fewer than 64 characters.
- The file format of the image that can be imported is BMP (bmp) or JPEG (jpg).
- The individual file size limit is 2 MB.
- The maximum image size is 1,920 x 936 pixels. If the image size is less than 480 x 234 pixels, the image is displayed in the middle of the screen with the extra area appearing in black.
- Up to 255 files can be selected.
- If the USB flash drive does not have any pictures, the **No files detected** message appears.

Continued







### ■ Select wallpaper

1. Press the **MENU/CLOCK** button.
2. Rotate  to select **Settings**, then press .
3. Rotate  to select **Wallpaper**, then press .
4. Rotate  to select **Select**, then press 
  - ▶ The screen changes to the wallpaper list.
5. Rotate  to select a desired wallpaper, then press .

### ■ To view wallpaper once it is set

1. Press the **MENU/CLOCK** button.
2. Rotate  to select **Settings**, then press .
3. Rotate  to select **Display Change**, then press .
4. Rotate  to select **Wallpaper**, then press 
  - ▶ The screen changes to the wallpaper list.
5. Rotate  to select a wallpaper that you want to set, then press .

### ■ Delete wallpaper

1. Press the **MENU/CLOCK** button.
2. Rotate  to select **Settings**, then press .
3. Rotate  to select **Wallpaper**, then press .
4. Rotate  to select **Delete**, then press 
  - ▶ The screen changes to the wallpaper list.
5. Rotate  to select a wallpaper that you want to delete, then press .
6. Rotate  to select **Yes**, then press 
  - ▶ The display will return to the wallpaper setting screen.

### ▶▶ Wallpaper Setup



To go back to the previous screen, press the  (Back) button.

When the file size is large, it takes a while to be previewed.



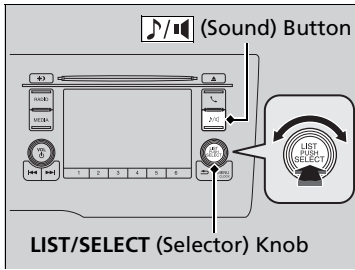

## Adjusting the Sound

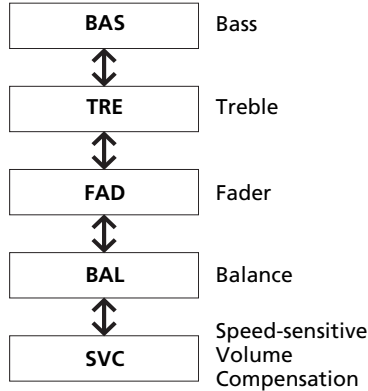
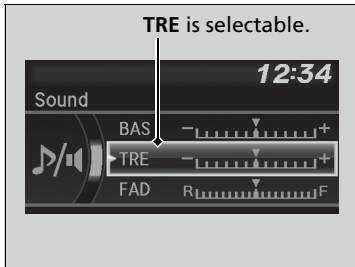

Press the  (Sound) button, and rotate  to scroll through the following choices:



Rotate  to adjust the sound setting, then press .

### Adjusting the Sound







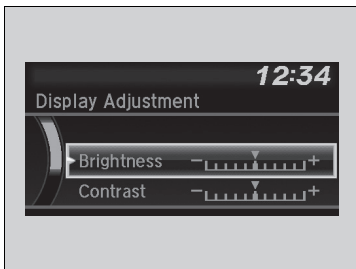

The SVC has four modes: **Off**, **Low**, **Mid**, and **High**. SVC adjusts the volume level based on the vehicle speed. As you go faster, audio volume increases. As you slow down, audio volume decreases.

## Display Setup

You can change the brightness or color theme of the audio/information screen.







### ■ Changing the Screen Brightness

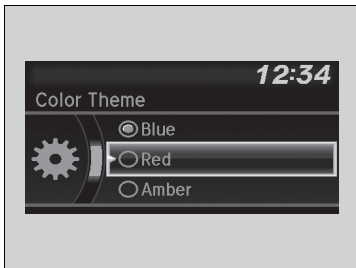

1. Press the **MENU/CLOCK** button.
2. Rotate  to select **Settings**, then press .
3. Rotate  to select **Display Adjustment**, then press .
4. Rotate  to select **Brightness**, then press .
5. Rotate  to adjust the setting, then press .

### ■ Changing the Screen's Color Theme



1. Press the **MENU/CLOCK** button.
2. Rotate  to select **Settings**, then press .
3. Rotate  to select **Color Theme**, then press .
4. Rotate  to select the setting you want, then press .

### ▣ Changing the Screen Brightness

You can change the **Contrast** and **Black Level** settings in the same manner.

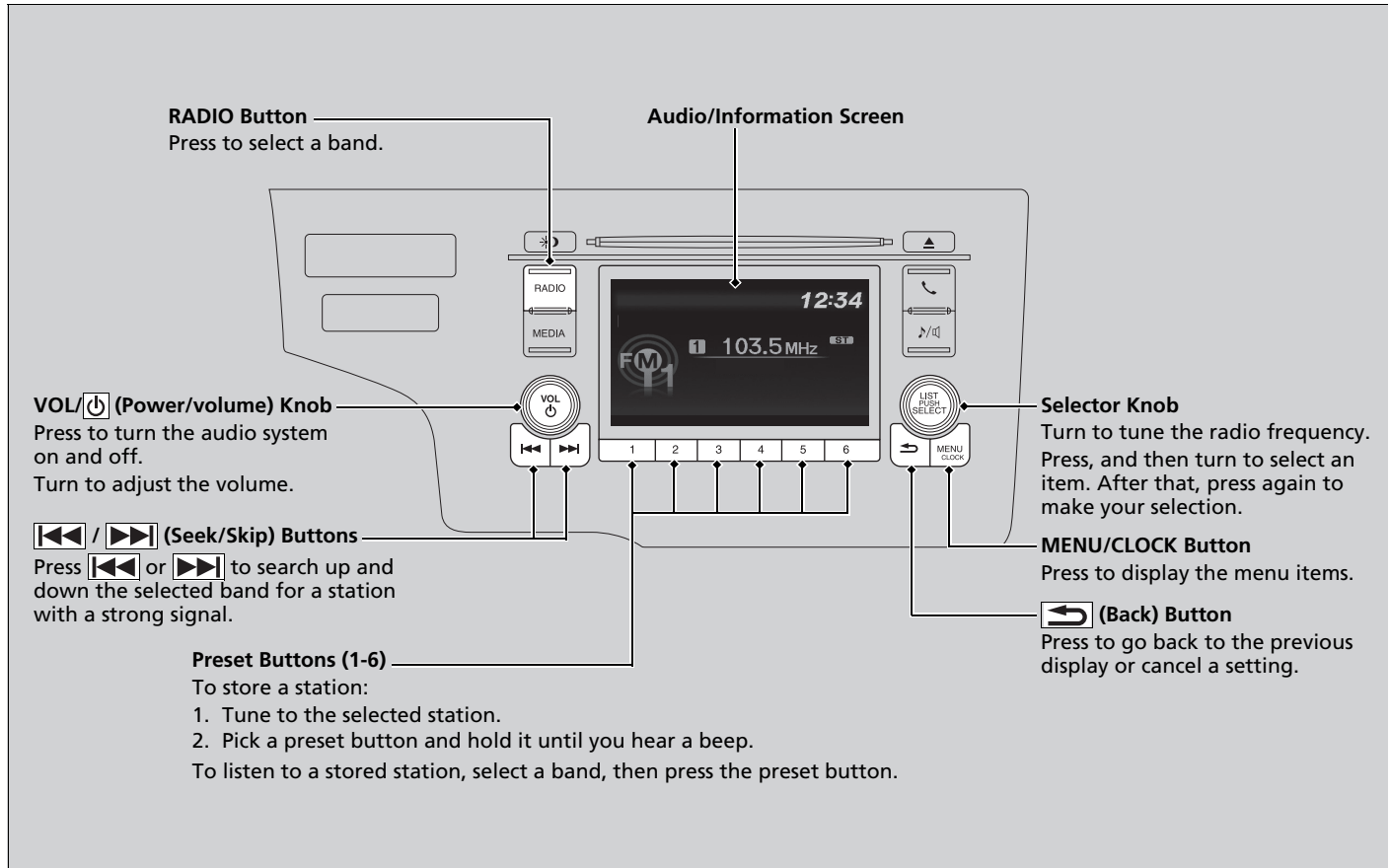

## Playing AM/FM Radio



## Radio Data System (RDS)



Provides text data information related to your selected RDS capable FM station.

### ■ To find an RDS station from Station List

1. Press  while listening to an FM station.
2. Rotate  to select the station, then press .

### ■ Update List

Updates your available station list at any time.

1. Press  while listening to an FM station.
2. Rotate  to select **Update List**, then press .

### ■ Radio text

Displays the radio text information of the selected RDS station.

1. Press the **MENU/CLOCK** button.
2. Rotate  to select **Settings**, then press .
3. Rotate  to select **RDS Settings**, then press .
4. Rotate  to select **Radio Text**, then press .

### ■ Scan

Samples each of the strongest stations on the selected band for 10 seconds.

1. Press the **MENU/CLOCK** button.
2. Rotate  to select **Scan**, then press .

To turn off scan, press .

## ▶▶ Playing AM/FM Radio

The **ST** indicator appears on the display indicating stereo FM broadcasts.  
Stereo reproduction in AM is not available.

You can store 6 AM stations and 12 FM stations into the preset memory.

### Models with audio remote controls

Switching the Audio Mode

Press the **SOURCE** button on the steering wheel.

▶ **Audio Remote Controls**\* P. 210

## ▶▶ Radio Data System (RDS)

When you select an RDS-capable FM station, the RDS automatically turns on, and the frequency display changes to the station name. However, when the signals of that station become weak, the display changes from the station name to the frequency.

## Playing a CD

Your audio system supports audio CDs, CD-Rs, and CD-RWs in either MP3 or WMA, or AAC\*1 format. With the CD loaded, press the **MEDIA** button.

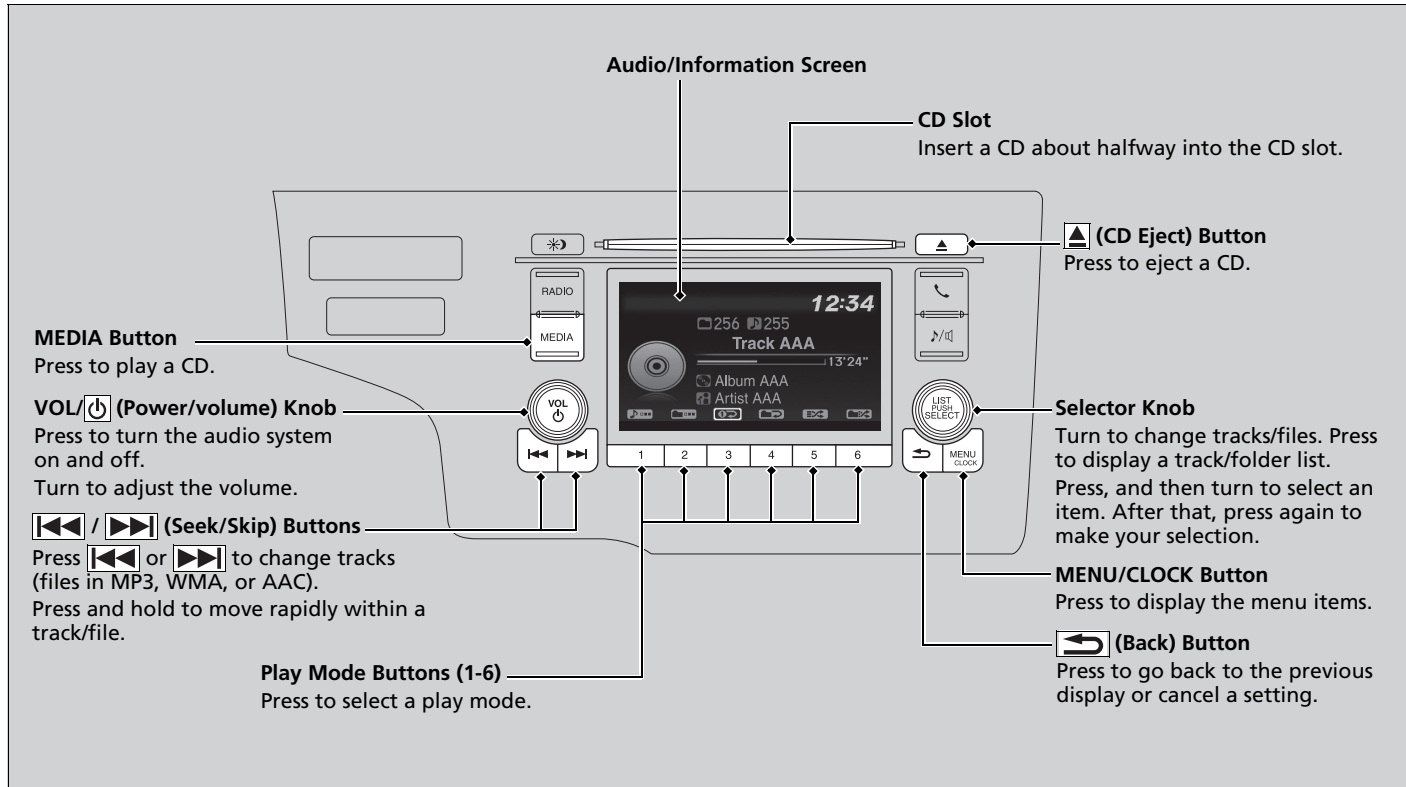

\*1: Only AAC format files recorded with iTunes are playable on this unit.

## How to Select a File from a Folder with the Selector Knob (MP3/WMA/AAC)

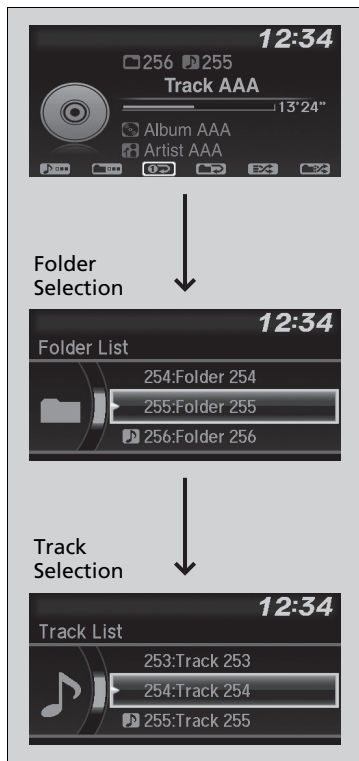

1. Press to switch the display to a folder list.

2. Rotate to select a folder.

3. Press to display a list of tracks in that folder.

4. Rotate to select a track, then press .

### ▶▶ Playing a CD

#### NOTICE

Do not use CDs with adhesive labels. The label can cause the CD to jam in the unit.

WMA files protected by digital rights management (DRM) cannot be played.

The audio system displays **UNPLAYABLE FILE**, then skips to the next file.

Text data appears on the display under the following circumstances:

- When you select a new folder, file, or track.
- When you change the audio mode to CD.
- When you insert a CD.

If you eject the CD but do not remove it from the slot, the system reloads the CD automatically after several seconds.

## How to Select a Play Mode

You can select repeat, random, and scan modes when playing a track or file.

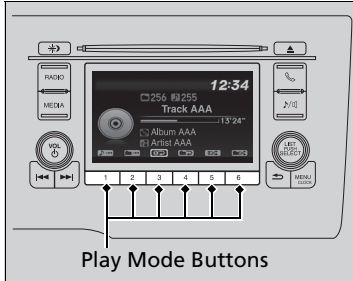

Available mode icons appear above the play mode buttons.

Press the button corresponding to the mode you want to select.

### To turn off a play mode

Press the selected button.

## How to Select a Play Mode

Play Mode Menu Items

### Repeat

 **Repeat One Folder (MP3/WMA/AAC):** Repeats all files in the current folder.

 **Repeat One Track:** Repeats the current track/file.

### Random

 **Random in Folder (MP3/WMA/AAC):** Plays all files in the current folder in random order.

 **Random All:** Plays all tracks/files in random order.



### Scan



 **Scan Folders (MP3/WMA/AAC):** Provides 10-second sampling of the first file in each of the main folders.

 **Scan Tracks:** Provides 10-second sampling of all tracks on the CD (all files in the current folder in MP3, WMA, or AAC).

You can also select a play mode by pressing the **MENU/CLOCK** button.

Rotate  to select **Play Mode**, then press .

Rotate  to select a mode, then press .

To turn it off, rotate  to select **Normal Play**, then press .

## Playing an iPod

Using your USB connector, connect the iPod to a USB port, then press the **MEDIA** button.

➔ **USB Port(s)** P. 207

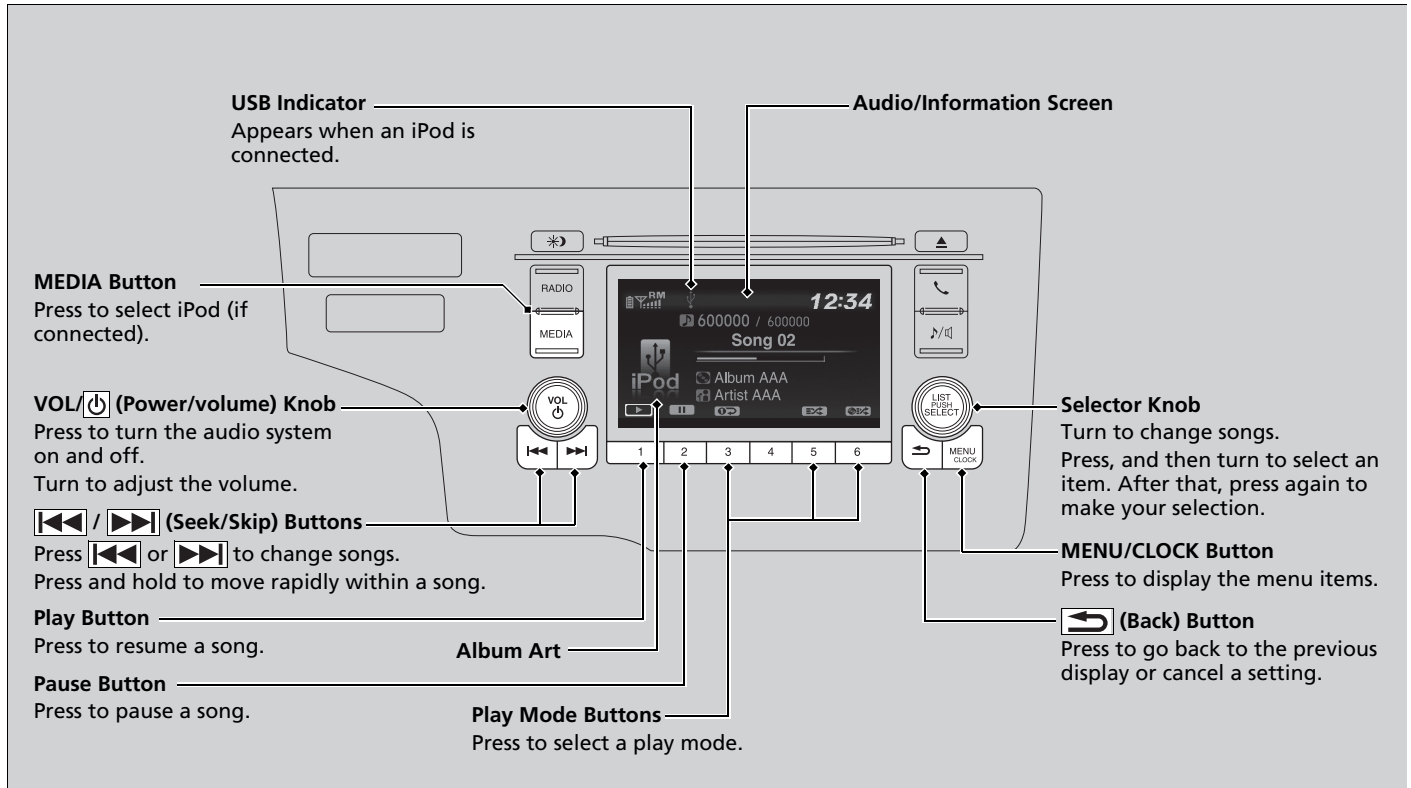



## How to Select a Song from the iPod Music List with the Selector Knob



1. Press to display the iPod music list.

2. Rotate to select a category.

3. Press to display a list of items in the category.

4. Rotate to select an item, then press .

- ▶ Press and rotate repeatedly until a desired item you want to listen is displayed.

### ▶▶ Playing an iPod

Available operating functions vary on models or versions. Some functions may not be available on the vehicle's audio system.

If there is a problem, you may see an error message on the audio display.

**iPod/USB Flash Drive** P. 313

## ■ How to Select a Play Mode

You can select repeat and shuffle modes when playing a song.

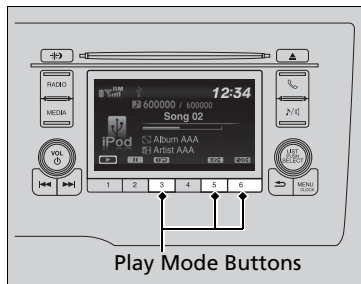

Available mode icons appear above the play mode buttons.

Press the button corresponding to the mode you want to select.

### ■ To turn off a play mode

Press the selected button.

## ▶▶ How to Select a Play Mode

Play Mode Menu Items

**Shuffle Album:** Plays all available albums in a selected category (playlists, artists, albums, songs, genres, or composers) in random order.

**Shuffle All:** Plays all available songs in a selected category (playlists, artists, albums, songs, genres, or composers) in random order.

**Repeat One Track:** Repeats the current song.

You can also select a play mode by pressing the **MENU/CLOCK** button.

Rotate to select **Play Mode**, then press .

Rotate to select a mode, then press .

To turn it off, rotate to select **Normal Play**, then press .

## Playing a USB Flash Drive

Your audio system reads and plays sound files on a USB flash drive in either MP3, WMA or AAC\*1 format.

Connect your USB flash drive to the USB port, then press the **MEDIA** button.

📌 **USB Port(s)** P. 207

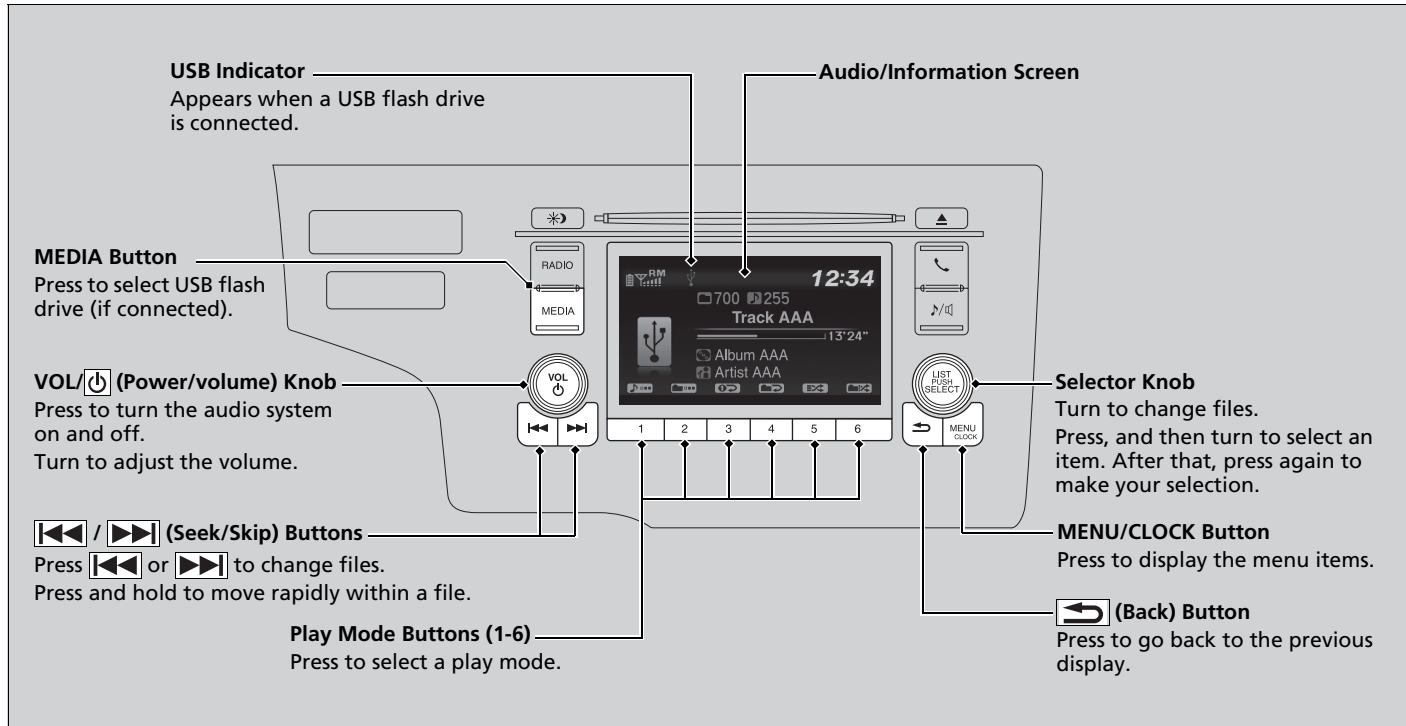

\*1: Only AAC format files recorded with iTunes are playable on this unit.

## How to Select a File from a Folder with the Selector Knob

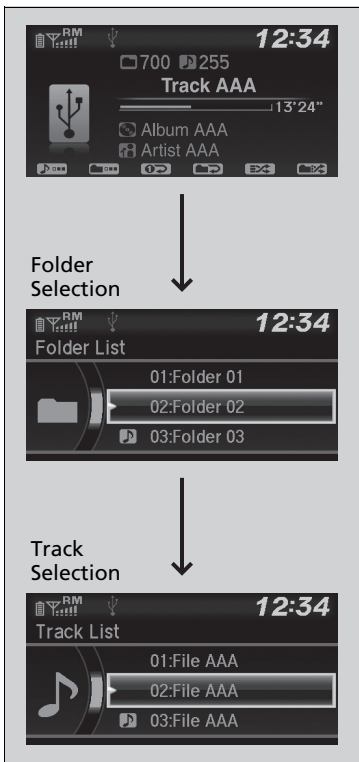

1. Press to display a folder list.
2. Rotate to select a folder.
3. Press to display a list of files in that folder.
4. Rotate to select a file, then press .

## ▶▶ Playing a USB Flash Drive

Use the recommended USB flash drives.

- ▶ **General Information on the Audio System** P. 317

Files in WMA format protected by digital rights management (DRM) are not played. The audio system displays **UNPLAYABLE FILE**, and then skips to the next file.

If there is a problem, you may see an error message on the audio/information screen.

- ▶ **iPod/USB Flash Drive** P. 313

## How to Select a Play Mode

You can select repeat, random, and scan modes when playing a file.

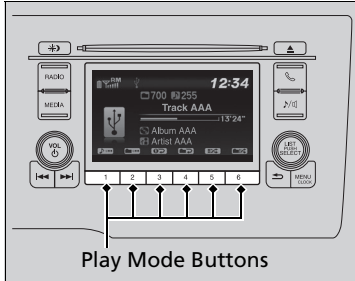

Available mode icons appear above the play mode buttons.

Press the button corresponding to the mode you want to select.

### To turn off a play mode

Press the selected button.

## How to Select a Play Mode

Play Mode Menu Items

### Repeat

**Repeat One Folder:** Repeats all files in the current folder.

**Repeat One Track:** Repeats the current file.

### Random

**Random in Folder:** Plays all files in the current folder in random order.

**Random All:** Plays all files in random order.

### Scan

**Scan Folders:** Provides 10-second sampling of the first file in each of the main folders.

**Scan Tracks:** Provides 10-second sampling of all files in the current folder.

You can also select a play mode by pressing the **MENU/CLOCK** button.

Rotate to select **Play Mode**, then press .

Rotate to select a mode, then press .

To turn it off, rotate to select **Normal Play**, then press .

## Playing *Bluetooth*® Audio

Your audio system allows you to listen to music from your *Bluetooth*-compatible phone.

This function is available when the phone is paired and connected to the vehicle's *Bluetooth*® HandsFreeLink® (HFL) system.

☑ **Phone Setup** P. 349

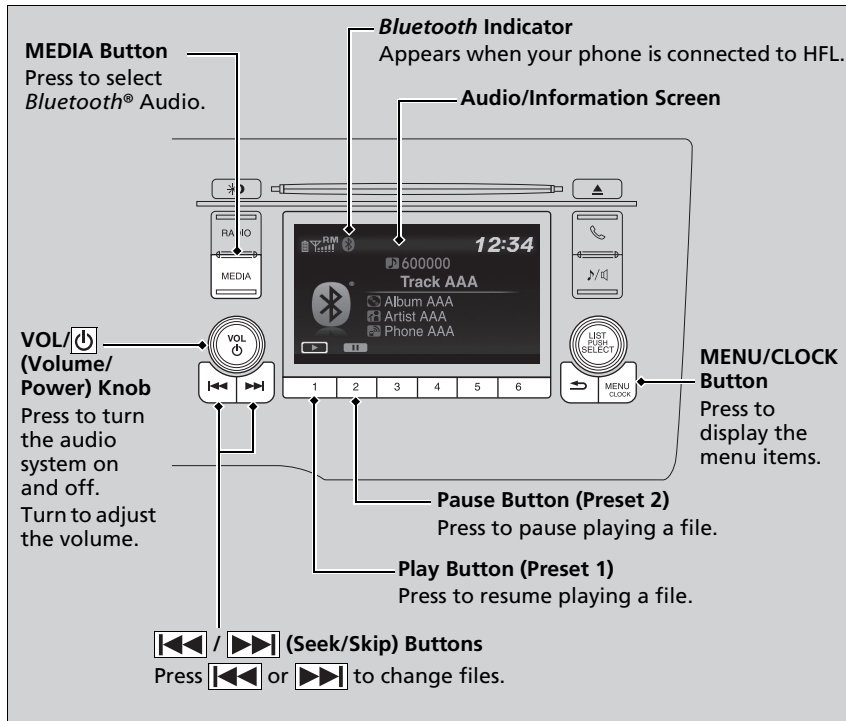

### ▶▶ Playing *Bluetooth*® Audio

Not all *Bluetooth*-enabled phones with streaming audio capabilities are compatible with the system.

For a list of compatible phones:

- U.S.: Visit [automobiles.honda.com/handsfreelink/](http://automobiles.honda.com/handsfreelink/), or call 1-888-528-7876.
- Canada: For more information on smartphone compatibility, call 1-888-528-7876.

In some states, it may be illegal to perform some data device functions while driving.

Only one phone can be used with HFL at a time. When there are more than two paired phones in the vehicle, the first paired phone the system finds is automatically connected.

If more than one phone is paired to the HFL system, there will be a delay before the system begins to play.

In some cases, the name of the artist, album, or track may not appear correctly.

Some functions may not be available on some devices.

## ■ To Play *Bluetooth*® Audio Files

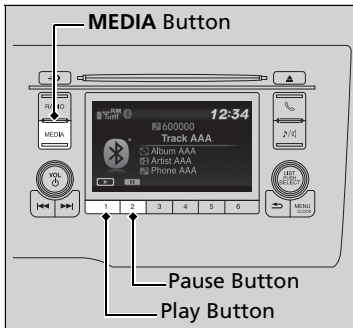

1. Make sure that your phone is paired and connected to HFL.
2. Press the **MEDIA** button until the Bluetooth Audio Source is selected.

If the phone is not recognized, another HFL-compatible phone, which is not compatible for *Bluetooth*® Audio, may already be connected.

## ■ To pause or resume a file

Press a **Play** or **Pause** button to select a mode.

## ▶▶ To Play *Bluetooth*® Audio Files

To play the audio files, you may need to operate your phone. If so, follow the phone maker's operating instructions.

The pause function may not be available on some phones.

If any audio device is connected to the auxiliary input jack or USB port, you may need to press the **MEDIA** button repeatedly to select the *Bluetooth*® Audio system.

Switching to another mode pauses the music playing from your phone.

## How to Select a Song from the Music Search List with the Selector Knob

### How to Select a Song from the Music Search List with the Selector Knob

Depending on the *Bluetooth*® device you connect, some or all of the categories may not be displayed.

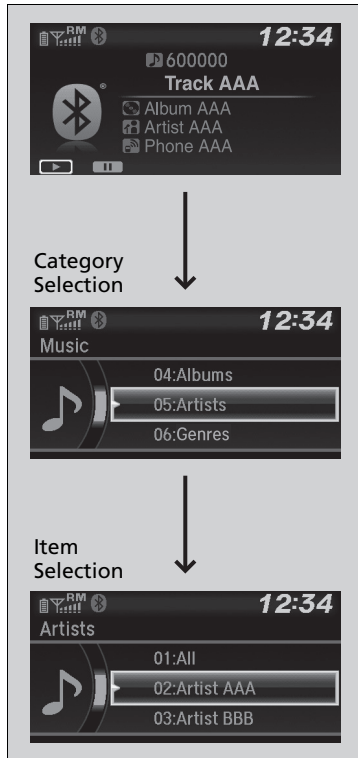

1. Press to display the music search list.

2. Rotate to select a category.

3. Press to display a list of items in the category.

4. Rotate to select an item, then press .

- ▶ Press and rotate repeatedly until a desired item you want to listen is displayed.



## Models with display audio system

To use the audio system function, the ignition switch must be in ACCESSORY **I** or ON **II**\*1.

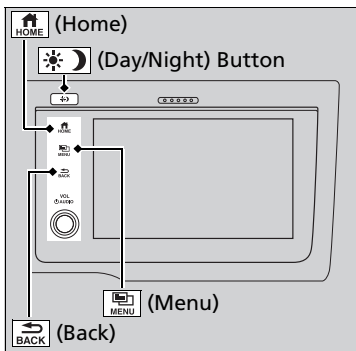

**HOME** (Home): Select to go to the home screen.

**Switching the Display** P. 234

**MENU** (Menu): Select to display available options including **Sound**, **View Radio Text**, **Music Search**, and playback modes.

**BACK** (Back): Select to go back to the previous display when it is displayed.

**Day/Night** button: Press to change the audio/information screen brightness.

Press **Day/Night** once and select **-** or **+** to make an adjustment.

▶ Each time you press **Day/Night**, the mode switches among the daytime mode, nighttime mode and off mode.

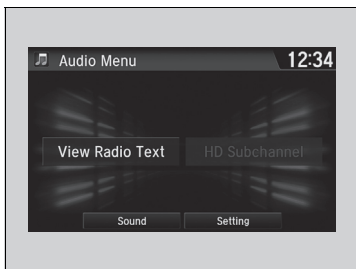

## Audio System Basic Operation

Audio Menu Items

▶ **Station List** P. 256

▶ **How to Select a File from the Music Search List** P. 277

▶ **Scan** P. 257, 266

▶ **How to Select a Play Mode** P. 269, 278

\*1: Models with the keyless access system have an **ENGINE START/STOP** button instead of an ignition switch.

## Audio/Information Screen

Displays the audio status and wallpaper. From this display, you can go to various setup options.

### ■ Switching the Display

#### ■ Using the button

Press the  (display) button to change the display.

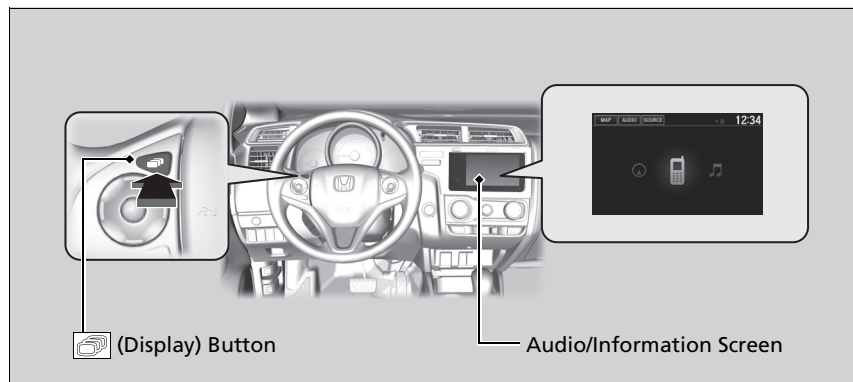

## ■ Using the audio/information screen

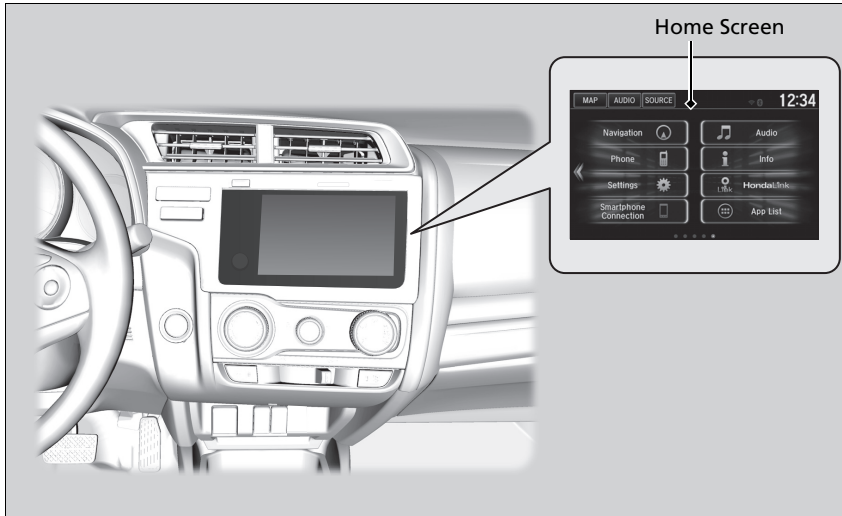

Select  to go to the home screen.

Select **Audio**, **Phone**, **Info**, **Settings**, **Smartphone Connection (Apple CarPlay, Android Auto)**, **Navigation\***, **HondaLink**, or **App List**.

### ■ Audio

Displays the current audio information.

### ■ Phone

Displays the HFL information.

 **Bluetooth® HandsFreeLink®** P. 368

\* Not available on all models

*Continued*

## ■ Info

Displays **Trip Computer**, **Voice Info**, **Clock/Wallpaper**, or **System/Device Information**. Select  on the **Info Menu** screen to see all available options: **Trip Computer**, **Voice Info**, **Clock/Wallpaper** and **System/Device Information**.

### Trip Computer:

- **Current Drive** tab: Displays the current trip information.
- **History of Trip A** tab: Displays information for the three previous drives. The information is stored every time you reset Trip A.  
To delete the history manually, select **Delete History** on the **History of Trip A** tab. The confirmation message appears on the screen, then select **Yes**.

**Voice Info:** Displays the all commands list.

**Clock/Wallpaper:** Displays the clock and wallpaper.

### System/Device Information:

- **System Info:** Displays the software version of the audio system.
- **USB Info:** Displays the memory usage of the USB device.
- **Switch USB Device:** Connects or disconnects USB device to this audio system.

## ■ Settings

Enters the customizing menu screen.

- **Customized Features** P. 328

## ■ Smartphone Connection

Connects with your smartphone\*<sup>1</sup> and allows some apps on your smartphone to be used on the audio system.

- **Apple CarPlay™** P. 289
- **Android Auto™** P. 293

## ☒ Audio/Information Screen

### Touchscreen operation

- Use simple gestures - including touching, swiping and scrolling - to operate certain audio functions.
- Some items may be grayed out during driving to reduce the potential for distraction.
- You can select them when the vehicle is stopped or use voice commands.
- Wearing gloves may limit or prevent touchscreen response.

You can change the touchscreen sensitivity setting.

- **Customized Features** P. 328

### ■ **Navigation\***

Displays the navigation screen.

➤ **Refer to the Navigation System Manual**

### ■ **HondaLink**

Connects with your smartphone\*<sup>1</sup> to play personalized music, information, and social media streams.

➤ **HondaLink®** P. 281

### ■ **App List**

Adds or removes apps or widgets on the Home screen.

➤ **Home Screen** P. 241

## ■ Changing the Home Screen Icon Layout

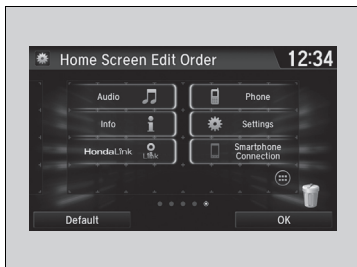

1. Select .
2. Select and hold an icon.
  - ▶ The screen switches to the customization screen.
3. Drag and drop the icon to where you want it to be.
4. Select **OK**.
  - ▶ The screen will return to the home screen.

## Wallpaper Setup

You can change, store, and delete the wallpaper on the audio/information screen.

### Import wallpaper

You can import up to five images, one at a time, for wallpaper from a USB flash drive.



1. Connect the USB flash drive to the USB port.

➤ **USB Port(s)** P. 207

2. Select **Settings**.

3. Select **Clock/Info**.

4. Select **Clock/Wallpaper Type**, then open the **Wallpaper** tab.

5. Select **Add New**.

▶ The picture name is displayed on the list.

6. Select a desired picture.

▶ The preview is displayed on the left side on the screen.

7. Select **Start Import** to save the data.

▶ The display will return to the wallpaper list.

### Wallpaper Setup

- When importing wallpaper files, the image must be in the USB flash drive's root directory. Images in a folder cannot be imported.
- The file name must be fewer than 64 characters.
- The file format of the image that can be imported is BMP (bmp) or JPEG (jpg).
- The individual file size limit is 5 MB.
- The maximum image size is 4,096 x 4,096 pixels. If the image size is less than 800 x 480 pixels, the image is displayed in the middle of the screen with the extra area appearing in black.
- If the USB flash drive does not have any pictures, the **No files detected** message appears.

## ■ Select wallpaper

1. Select **Settings**.
2. Select **Clock/Info**.
3. Select **Clock/Wallpaper Type**, then open the **Wallpaper** tab.
  - ▶ The screen changes to the wallpaper list.
4. Select a desired wallpaper.
  - ▶ The preview is displayed on the left side on the screen.
  - ▶ The pop-up menu appears on the screen.
5. Select **Set**.
  - ▶ The display will return to the wallpaper list.

## ■ To view wallpaper once it is set

1. Select .
2. Select **Info**.
3. Select .
4. Select **Clock/Wallpaper**.

## ■ Delete wallpaper

1. Select **Settings**.
2. Select **Clock/Info**.
3. Select **Clock/Wallpaper Type**, then open the **Wallpaper** tab.
  - ▶ The screen changes to the wallpaper list.
4. Select a wallpaper that you want to delete.
  - ▶ The preview is displayed on the left side on the screen.
  - ▶ The pop-up menu appears on the screen.
5. Select **Delete**.
  - ▶ A confirmation message appears on the screen.
6. Select **Yes** to delete completely.
  - ▶ The display will return to the wallpaper list.

## ▶▶ Wallpaper Setup

From the pop-up menu, select **Preview** to see a preview at full-size screen.



To go back to the previous screen, select **OK**, or select  (Back).

When the file size is large, it takes a while to be previewed.



To delete all wallpapers you add, select **Delete All**, then **Yes**.

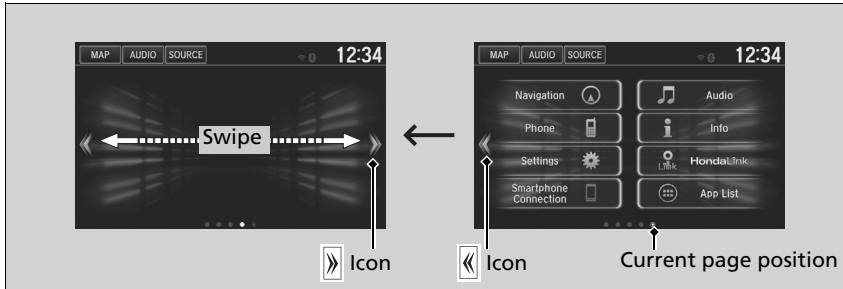

## Home Screen

### To change to a next screen





Selecting  or , or swiping the screen left or right changes to the next screen.

## Home Screen

The home screen has 5 pages (fixed). You cannot add any more pages.

## ■ To use apps or widgets



1. Select .
2. Select  or App List.  
▶ The **APPS** screen appears.
3. Select the app or widget you want to use.

Preinstall app list:

- **Browser:** Displays the web browser utilized by smartphone and Wi-Fi connection.
- **Calculator:** Displays Calculator.
- **Downloads:** Displays the data downloaded from the web browser and so on.
- **App Installer:** Check with a Honda dealer for apps that are available for installation.
- **Search:** Displays various retrieval screens.

## ▶▶ To use apps or widgets

Select and hold a selected app or widget to add that app's or widget's shortcut on the home screen.

Pre-installed apps may not start up normally. If this occurs, you need to reset the system.

▶ **Defaulting All the Settings** P. 342

If you perform **Factory Data Reset**, it may reset all the settings to their factory default.

▶ **Defaulting All the Settings** P. 342

In case those apps still do not startup normally even after **Factory Data Reset**, contact your dealer.

There is a possibility that a browser is shut down in the situation of the use. In that situation, the screen will return to before the browser startup.

Do not install apps other than those confirmed by a Honda dealer. Installation of unauthorized apps may introduce data corruption risks to your vehicle's information and your privacy.

You can delete user installed apps by the following procedure.

1. Select .
2. Select **Settings**.
3. Select **System**.
4. Select the **Others** tab.
5. Select **Detail Information**.
6. Select an App that you want to delete.
7. Select **Delete**.

Pre-installed apps cannot be deleted.

## ■ To add app or widget icons on the home screen

App or widget icons can be added on the home screen.

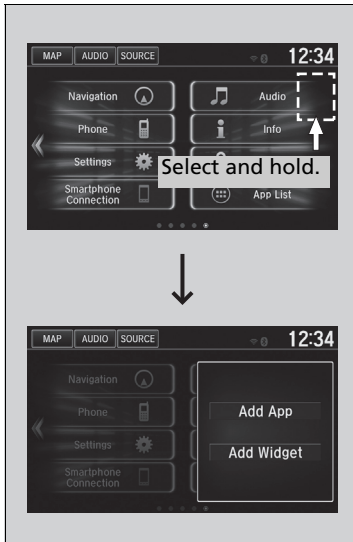

1. Select .
2. Select .
3. Select and hold empty space on the home screen.
  - ▶ The pop-up menu appears on the screen.
4. Select **Add App** or **Add Widget**.
  - ▶ The **Add app/widget** screen appears.



5. Select and hold an app or widget icon you want to add.
  - ▶ The screen switches to the customization screen.
6. Drag and drop the icon to where you want it to be.
7. Select **OK**.
  - ▶ The screen will return to the home screen.

## ■ To move icons on the home screen

You can change location on the home screen.

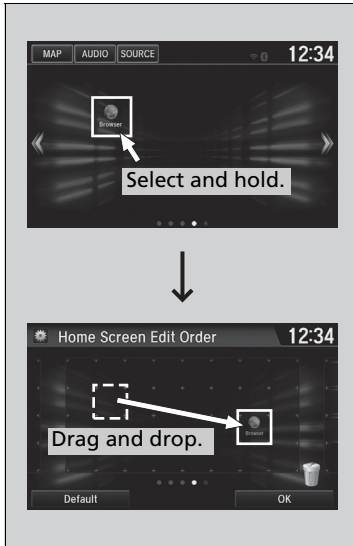

1. Select and hold an icon.
  - ▶ The screen switches to the customization screen.
2. Drag and drop the icon to where you want it to be.
3. Select **OK**.
  - ▶ The screen will return to the home screen.

## ☒ To move icons on the home screen

You can also move the **Audio, Phone, Info, Settings, Smartphone Connection (Apple CarPlay, Android Auto), Navigation<sup>\*</sup>, HondaLink**, and **App List** icons in the same manner.

\* Not available on all models

### ■ To remove icons on the home screen

You can delete the icons on the home screen.

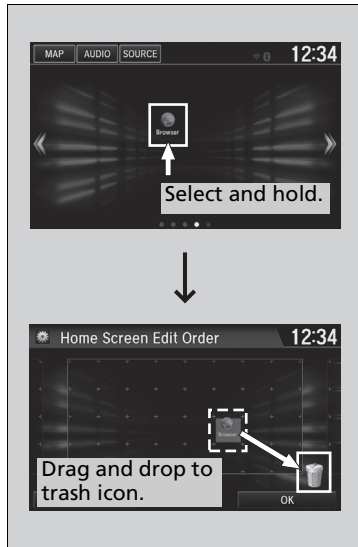

1. Select and hold an icon.
  - ▶ The screen switches to the customization screen.
2. Drag and drop the icon you want to remove to the trash icon.
  - ▶ The icon is removed from the home screen.
3. Select **OK**.
  - ▶ The screen will return to the home screen.

### ☒ To remove icons on the home screen

You cannot delete the **Audio, Phone, Info, Settings, Smartphone Connection (Apple CarPlay, Android Auto), Navigation\*, HondaLink, and App List** icons.

Apps or widgets will not be deleted by deleting the icon on the home screen.

## Status Area

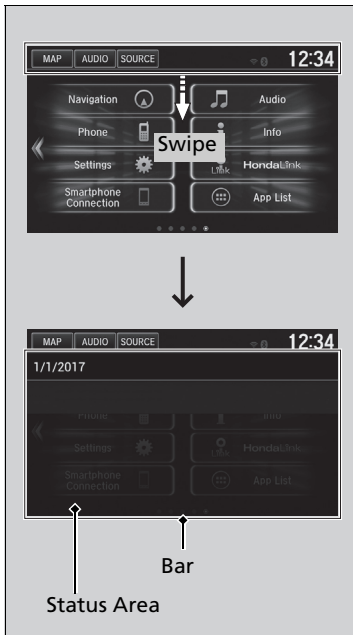

1. Swipe the upper area of the screen.
  - ▶ The status area appears.
2. Select an item to see the details.
3. Select  or swipe up the bottom bar to close the area.

## ■ Closing Apps

You can close specific apps running in the background on the system.

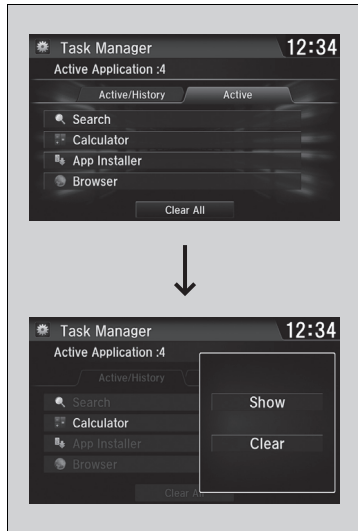

1. Select and hold .
2. Select the **Active** tab.
  - ▶ If you select the **Active/History** tab, you can close the apps that are currently running and delete the app activity history simultaneously.
3. Select an app you want to close.
4. Select **Clear**.
  - ▶ The display will return to the app list.

## » Closing Apps

If you leave the apps used open in the background, some apps may stop operating properly next time using them.  
If this happens close unused apps.

To close all apps on the system, select **Clear All**, then **Yes**.

You cannot close the HondaLink® and Garmin\* apps.



## Adjusting the Sound

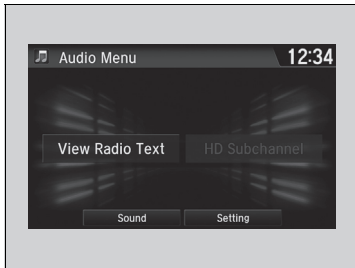

1. Select .
2. Select **Audio**.
3. Select .
4. Select **Sound**.

Select a tab from the following choices:

- **BAS-MID-TRE**: Bass, Middle, Treble
- **FAD-BAL**: Fader, Balance
- **SVC**: Speed Volume Compensation

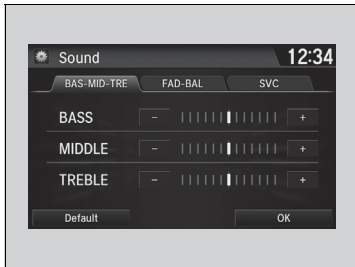

### Adjusting the Sound

The SVC has four modes: **Off**, **Low**, **Mid**, and **High**. SVC adjusts the volume level based on the vehicle speed. As you go faster, audio volume increases. As you slow down, audio volume decreases.

You can also adjust the sound the following procedure.

1. Select .
2. Select **Settings**.
3. Select **Audio**, then the **Common** tab.
4. Select **Sound**.

## Display Setup

You can change the brightness or color theme of the audio/information screen.

### ■ Changing the Screen Brightness

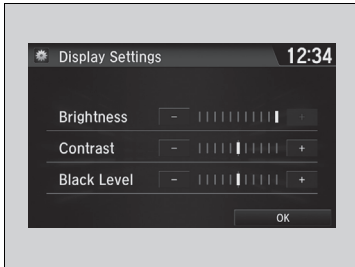

1. Select **HOME**.
2. Select **Settings**.
3. Select **System**.
4. Select the **Display** tab.
5. Select **Display Settings**.
6. Select the setting you want.
7. Select **OK**.

### ☒ Changing the Screen Brightness

You can change the **Contrast** and **Black Level** settings in the same manner.

### ■ Changing the Screen's Color Theme

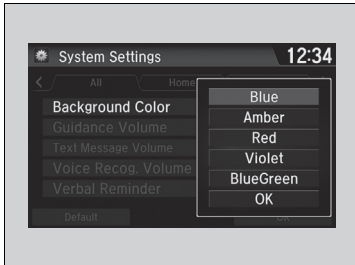

1. Select **HOME**.
2. Select **Settings**.
3. Select **System**.
4. Select the **Display** tab.
5. Select **Background Color**.
6. Select the setting you want.
  - ▶ A confirmation message appears on the screen. Select **Yes** to reboot the system.

### ☒ Changing the Screen's Color Theme

Reboot may take a few minutes.  
If you default the **System** settings when the color theme is changed from its default color, the system reboots.

☒ **Customized Features** P. 328

## Selecting an Audio Source

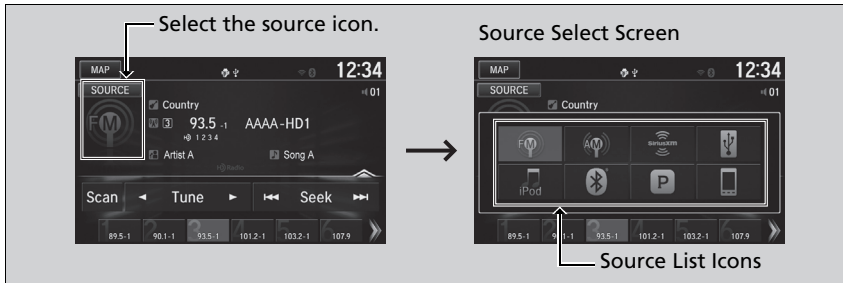

Select the current source icon, then select an icon on the source list to switch the audio source.

## Limitations for Manual Operation

Certain manual functions are disabled or inoperable while the vehicle is in motion. You cannot select a greyed-out option until the vehicle is stopped.



### ▶▶ Selecting an Audio Source

If you startup preinstalled audio apps, **AUDIO Apps** is displayed on the lower right of the screen. These preinstalled apps cannot be displayed on the source select screen.

You can startup those audio apps from **AUDIO Apps**.

## Voice Control Operation

Your vehicle has a voice control system that allows hands-free operation.

The voice control system uses the  (Talk) and  (hang-up/back) buttons on the steering wheel and a microphone near the map lights on the ceiling.

### Voice Recognition

To achieve optimum voice recognition when using the voice control system:



- Make sure the correct screen is displayed for the voice command that you are using.

The system recognizes only certain commands. Available voice commands.

 **Voice Portal Screen** P. 253

- Close the windows and moonroof\*.
- Adjust the dashboard and side vents so air does not blow onto the microphone on the ceiling.
- Speak clearly in a natural speaking voice without pausing between words.
- Reduce any background noise if possible. The system may misinterpret your command if more than one person is speaking at the same time.

### Voice Control Operation

When you press the  button, a helpful prompt asks what you would like to do. Press and release the  button again to bypass this prompt and give a command.

## Voice Portal Screen

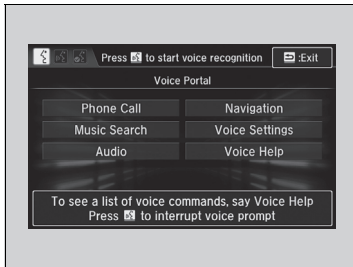

When the [Talk] (Talk) button is pressed, available voice commands appear on the screen.

For a complete list of commands, say “Voice Help” after the beep or select **Voice Help**.

You can also see the list of commands by selecting **Info**, [MENU], and **Voice Info**.

The system only recognizes the commands on the following pages, at certain screens. Free form voice commands are not recognized.

\*1: Models with navigation system

\* Not available on all models

### Phone Call

This can be only used when the phone is connected. When the system recognizes the *Phone call* command, the screen will change to the voice recognition screen for the phone commands.

- *Dial by number*
- *Call history*
- *Redial*
- *Call <Your Contact Name>*
- *Call <Phone Number>*

Phone Call commands are not available if using Apple CarPlay™.

### Music Search\*1

This can be only used when the iPod or USB device is connected.

### Audio\*1

When the system recognizes the *Audio* command, the screen will change to the audio voice recognition screen.

- *FM*
- *AM*
- *SXM*

### Navigation\*1

The screen changes to the navigation voice recognition screen.

Refer to the **Navigation System Manual**

### Voice Settings

The screen changes to the **Voice Recog.** tab on the **System settings** screen.

### Voice Help

You can see a list of the available commands on the screen.

- *Phone Commands*
- *Audio Commands\**
- *On Screen Commands*
- *Music Search Commands\**
- *General Commands*
- *All Commands*
- *Voice Settings*
- *Getting Started*

## Phone Commands

The system accepts these commands on the dedicated screen for the voice recognition of the phone.

- *Dial by Number*
- *Call by Name*
- *Dial [Phone Number]*
- *Call [Your contact Name]*

## Audio Commands\*1

The system accepts these commands on the dedicated screen for the voice recognition of the audio.

### Music Search Commands

Music Search Commands List

- ▶ **Music Search Commands\*1** P. 254

### Radio FM Commands

- *Radio tune to <87.7-107.9> FM*
- *Radio tune to <87.7 -107.9> HD <1-8> FM*

### Radio AM Commands

- *Radio tune to <530-1710> AM*

\*1: Models with navigation system

\* Not available on all models

## Radio SXM Commands\*

- *SXM channel <0-999>*
- *SXM channel [station name]*

## On Screen Commands

When **On Screen Commands** is selected, the explanation screen is displayed.

## Music Search Commands\*1

The system accepts these commands on the **Music Search** screen.

### Using Song By Voice

Song By Voice™ is a feature that allows you to select music from your iPod or USB device using Voice Commands. To activate this mode, you must push the talk switch and say: "Music search".

### Song By Voice Commands

- *What am I listening to?*
- *Who am I listening to?*
- *Who is this?*
- *What's playing?*
- *Who's playing?*
- *What album is this?*

## Play Commands

- *Play artist [Name]*
- *Play track/song [Name]*
- *Play album [Name]*
- *Play genre/category [Name]*
- *Play playlist [Name]*
- *Play composer [Name]*

## List Commands

- *List artist [Name]*
- *List album [Name]*
- *List genre/category [Name]*
- *List playlist [Name]*
- *List composer [Name]*

## General Commands

- *What time is it?*
- *What is today's date?*

### NOTE:

These commands toggle the function on and off, so the command may not match your intended action.

# Playing AM/FM Radio

**Audio/Information Screen**

**(Menu)** Select to display the menu items.

**(Back)** Select to go back to the previous display.

**VOL/⏻ (Power/volume) Knob** Press to turn the audio system on and off. Turn to adjust the volume.

**Scan Icon** Select to scan each station with a strong signal.

**Tune Icons** Select or to tune the radio frequency.

**Open/Close Icon\*<sup>1</sup>** Displays/hides the detailed information.

**Preset Icons** Tune the radio frequency for preset memory. Select and hold the preset icon to store that station. Select to display beyond preset 7.

**Seek Icons** Select or to search up and down the selected band for a station with a strong signal.

\*1: Some or all of the lists may not be displayed.

## ■ Preset Memory

To store a station:

1. Tune to the selected station.
2. Select and hold the preset number for the station you want to store.

You can also store a preset station by the following procedure.

1. Tune to the selected station.
2. Select the open/close icon to display a list.
3. Select the **Preset** tab.
4. Select and hold the preset number for the station you want to store.

## ■ Station List

Lists the strongest stations on the selected band.

1. Select the open/close icon to display a list.
2. Select the **Station List** tab.
3. Select the station.

## ■ Manual update

Updates your available station list at any time.

1. Select the open/close icon to display a list.
2. Select the **Station List** tab.
3. Select **Refresh**.

## ▶▶ Preset Memory

The **ST** indicator appears on the display indicating stereo FM broadcasts. Stereo reproduction in AM is not available.

Switching the Audio Mode

Press the **SOURCE** button on the steering wheel or select **SOURCE** on the screen.

▶▶ **Audio Remote Controls**\* P. 210

You can store 6 AM stations and 12 FM stations into preset memory.

## ▶▶ Models with HD Radio™

HD Radio Technology manufactured under license from iBiquity Digital Corporation. U.S. and Foreign Patents. For patents see <http://dts.com/patents>. HD Radio, Artist Experience, and the HD, HD Radio, and "ARC" logos are registered trademarks or trademarks of iBiquity Digital Corporation in the United States and/or other countries.





## ■ Scan

Samples each of the strongest stations on the selected band for 10 seconds. To turn off scan, select **Cancel** or .

### Models with HD Radio™

## ■ HD Subchannel

Displays the subchannel list when an HD Radio™ station is selected while listening to an FM station.

1. Select .
2. Select **HD Subchannel**.
3. Select the channel number.

## ■ Radio Data System (RDS)

Provides text data information related to your selected RDS-capable FM station.

### ■ To find an RDS station from Station List

1. Select the open/close icon to display a list while listening to an FM station.
2. Select the **Station List** tab.
3. Select the station.

### ■ Manual update

Updates your available station list at any time.

1. Select the open/close icon to display a list while listening to an FM station.
2. Select the **Station List** tab.
3. Select **Refresh**.

### ⌘ Radio Data System (RDS)

When you select an RDS-capable FM station, the RDS automatically turns on, and the frequency display changes to the station name. However, when the signals of that station become weak, the display changes from the station name to the frequency.

### ■ Radio text

Displays the radio text information of the selected RDS station.

1. Select .
2. Select **View Radio Text**.

### ■ Scan

Samples each of the strongest stations on the selected band for 10 seconds.

To turn off scan, select **Cancel** or .

# Playing SiriusXM® Radio

The diagram shows a car's infotainment screen displaying the SiriusXM radio interface. The screen is divided into two main sections: **Album Art** on the left and **Audio/Information Screen** on the right. The **Album Art** section shows a menu with options like HOME, MENU, BACK, and VOL/AUDIO. The **Audio/Information Screen** displays station information such as 'Pop', 'CH 004', '40s on 4', 'Artist A', and 'Song A'. It also features a 'Scan' button, 'Category' buttons (CH000-CH005), 'Channel' navigation buttons, and 'Skip' buttons. The screen also shows 'Station Art', 'Open/Close Icon', 'Skip Icons', and 'Preset Icons'.

**Album Art**      **Audio/Information Screen**

**(Menu)**  
Select to display the menu items.

**(Back)**  
Select to go back to the previous display.

**VOL/ (Power/volume) Knob**  
Press to turn the audio system on and off.  
Turn to adjust the volume.

**Scan Icon**  
Select to scan each channel.

**Category Icons**  
Select ◀ or ▶ to display and select a SiriusXM® Radio category.

**Station Art**

**Open/Close Icon<sup>\*1</sup>**  
Displays/hides the detailed information.

**Skip Icons**  
Select ◀◀ or ▶▶ to change section in the channel.  
Select and hold to move rapidly within the section.

**Preset Icons**  
Tune the radio frequency for preset memory. Select and hold the preset icon to store that station. Select >> to display beyond preset 7.

**Channel Icons**  
Select ◀◀ or ▶▶ to the previous or next channel.  
Select and hold to rapidly skip 10 channels at a time.

\*1: Some or all of the lists may not be displayed.

## ■ To Change the Tune Mode

1. Select .
2. Select **Tune Mode**.
3. Select **Channel Mode** or **Category Mode**.

## ▶▶ Playing SiriusXM® Radio

In the channel mode, all available channels are selectable. In the category mode, you can select a channel within a category (Jazz, Rock, Classical, etc.).

There may be instances when SiriusXM® Radio does not broadcast all the data fields (artist name, title). This does not indicate a problem with your audio system.

SiriusXM® Radio stations load in ascending order, which can take about a minute. Once they have loaded you will be able to scroll up or down to make your selections.

Switching the Audio Mode

Press the **SOURCE** button on the steering wheel or select **SOURCE** on the screen.

 **Audio Remote Controls\*** P. 210

**Tune Start:**

When you change to a preset channel, a song being played on that channel restarts from the beginning with this function. This can be turned on or off from the **Audio Settings** screen.

 **Customized Features** P. 328

## ■ Preset Memory

To store a channel:

1. Tune to the selected channel.
2. Select to hold the preset number for the station you want to store.
3. Select **Replace**.

You can also store a channel by the following procedure.

1. Tune to the selected channel.
2. Select the open/close icon to display a list.
3. Select the **Preset** tab.
4. Select and hold the preset number for the station you want to store.

## ■ Multi-channel preset (for music channels only)

You can store up to four of your preferred music channels per preset.

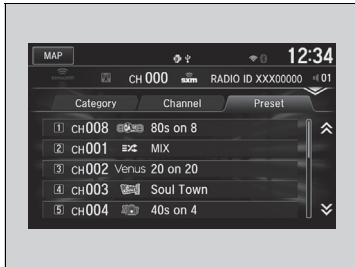

1. Tune a station.
2. Select the open/close icon to display a list.
3. Select the **Preset** tab.
4. Select and hold the preset number you want to add a music channel.
  - ▶ A message appears if there are no available presets.
5. Select **Combine**.

## ▶▶ Playing SiriusXM® Radio

You can store 12 SiriusXM® channels into the preset memory.

## ■ Listening to Featured Channels

Suggested channel listing received from SiriusXM® can be displayed and selected.

1. Select the open/close icon to display a channel list.
2. Select the **Channel List** tab.
3. Select the featured channel list title you want to listen to.
  - ▶ The selected channel list of the title is displayed.
4. Select the channel.

## ▶▶ Listening to Featured Channels

Up to three featured channels by SiriusXM® can be displayed.

Featured channel lists are at the top of the channel list.

## Replay Function

The system can record up to the last 60 minutes of your currently tuned channel's broadcast, as well as the last 30 minutes of your preset channel's broadcast, starting from the moment you turn the vehicle on. If you tuned to preset channel, the system records up to 60 minutes of a broadcast instead of up to 30 minutes. You can rewind and replay the last 30 or 60 minutes of a broadcast.

1. Select .
2. Select **Playback**.
3. Move the gauge to the position you want to replay.

The following items are available on the pop-up screen:

 (Skip Down): Skips to the previously stored channel. Select and hold to fast-rewind the current selection.

 (Skip Up): Skips to the next channel. Select and hold to fast-forward the current selection.

 (15Sec Back): Select to skip back 15 seconds in the current selection. Select and hold to fast-rewind the current selection.

 (15Sec Skip): Select to skip forward 15 seconds in the current selection. Select and hold to fast-forward the current selection.

▶ Select **OK** or  to close the pop-up menu. Replay in playback mode continues.

To play or pause on playback mode:

1. Select .
2. Select **Play/Pause**.

## Returning to real-time broadcast

1. Select .
2. Select **Go to Live**.

## Replay Function

The system starts storing broadcast in memory when the power mode is turned ON. You can go back to the program from that point.

You can no longer replay any program once the power mode is turned off as it erases memory. You can check how long the program has been stored in memory from the audio/information screen.

After 30 or 60 minutes of recording the system will automatically start deleting the oldest data.

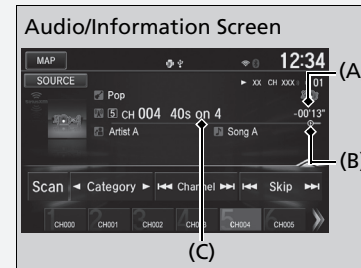

(A): Shows how much time the replayed segment is behind the real-time broadcast

(B): Replayed segment

(C): Length stored in memory

## ■ Live Sports Alert

While listening to other channel, you can receive sports alerts such as scores from your favorite teams.

### ■ To set up a favorite team



1. Select .
2. Select **Settings**.
3. Select **Audio**.
4. Select the **SXM** tab.
5. Select **SportsFlash Setup**.
6. Select **Favorite Team**.
7. Select a team.

### ■ To set up an alert message

1. Select .
2. Select **Settings**.
3. Select **Audio**.
4. Select the **SXM** tab.
5. Select **SportsFlash Setup**.
6. Select **Interrupt**.
7. Select **On(one time)** or **On(continue)**.

### ⌘ Live Sports Alert

The sports alert function at SiriusXM® mode only.

### ⌘ To set up a favorite team

Sports alerts cut in only when SiriusXM® mode is on. Selecting **On(one time)** from the customize settings disables the alert feature next time you turn the power mode to ON.

 **Customized Features** P. 328

You can also set up a favorite team by the following procedure.

1. Select **Audio**.
2. Select .
3. Select **Settings**.
4. Select the **SXM** tab.



### ■ To set up a alert beep

1. Select .
2. Select **Settings**.
3. Select **Audio**.
4. Select the **SXM** tab.
5. Select **SportsFlash Setup**.
6. Select **Interrupt Beep**.
7. Select **On**.

### ■ Receiving a sports alert

1. A pop-up appears and notifies you of a sports alert.
  2. Select **Listen**.
    - ▶ You can use the same items as the playback mode pop-up screen.
      - **Replay Function** P. 263
- To go back to the previous screen, select **Back**.

### ☒ To set up a alert beep

You can also set up a alert beep by the following procedure.

1. Select **Audio**.
2. Select .
3. Select **Settings**.
4. Select the **SXM** tab.

## ■ Traffic and Weather Information

You can receive traffic and weather information.

### ■ To set up a traffic & weather information

1. Select .
2. Select **Settings**.
3. Select **Audio**.
4. Select the **SXM** tab.
5. Select **Traffic & Weather Setup**.
6. Select the region.
  - ▶ When you do not want to receive the information, select **Unregistered**.

### ■ Listening to traffic and weather information

1. Select .
2. Select **Traffic & Weather**.
  - ▶ Play mode can also use the any items same as playback mode.
    - ▶ **Replay Function** P. 263
  - To go back to the previous screen, select **OK**.

## ■ Scan

Sample each channel on the selected mode for 10 seconds.

1. Select **Scan**.
2. Select **Scan Channels**.
  - ▶ You can select the desired channel by songs using **Scan Song in Presets**.

To turn off scan, select **Cancel Scan**.

## ▶▶ Traffic and Weather Information

The traffic and weather information function at SiriusXM® mode only.

You can also set up the traffic and weather information by the following procedure.

1. Select **Audio**.
2. Select .
3. Select **Settings**.
4. Select the **SXM** tab.

## ▶▶ Scan

The “Scan Songs in Presets” function is based on TuneScan™ technology of SiriusXM®.

The “Featured Channels” function is based on Featured Favorites™ technology of SiriusXM®.

TuneScan™ and Featured Favorites™ are registered trademarks of SiriusXM® Radio, Inc.

## Playing an iPod

Connect the iPod using your USB connector to the USB port, then select the iPod mode.

 **USB Port(s)** P. 207

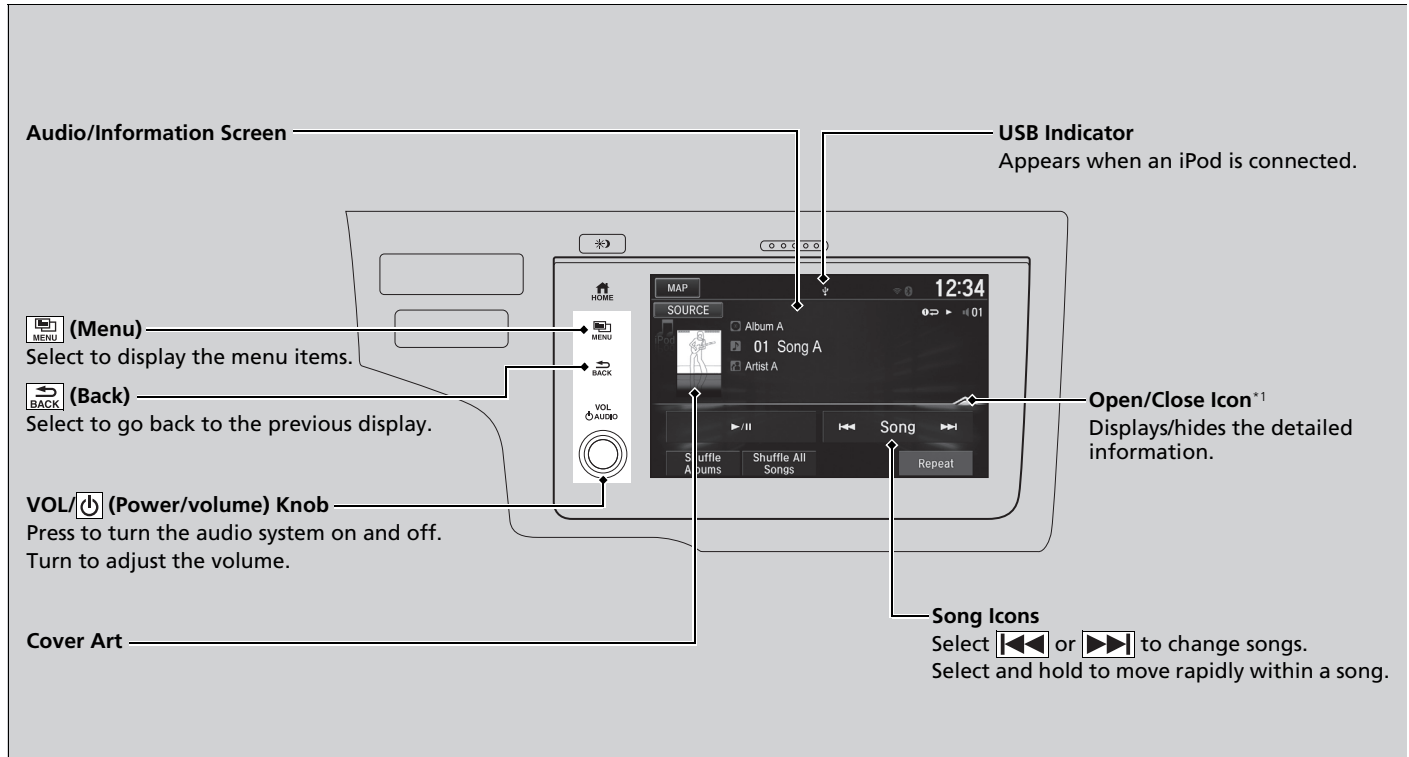

\*1: Some or all of the lists may not be displayed.

## How to Select a Song from the Music Search List

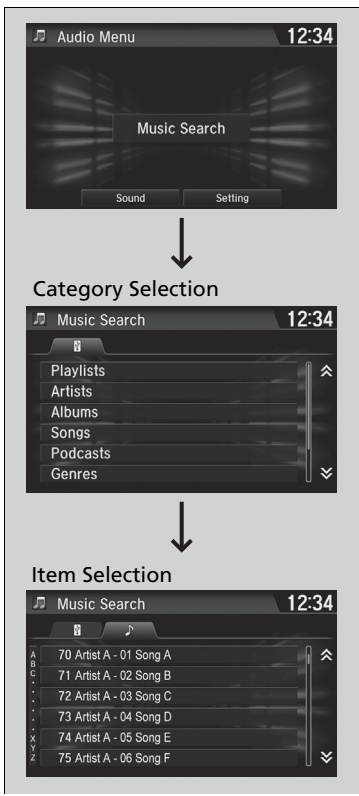

1. Select  and select **Music Search**.

2. Select the items on that menu.

## ▶▶ Playing an iPod

Available operating functions vary on models or versions. Some functions may not be available on the vehicle's audio system.

If there is a problem, you may see an error message on the audio/information screen.

 **iPod/USB Flash Drive** P. 313

If you operate the music app on your iPhone/iPod while the phone is connected to the audio system, you may no longer be able to operate the same app on the audio/information screen. Reconnect the device if necessary.

## How to Select a Play Mode

You can select repeat and shuffle modes when playing a file.

Select a mode.

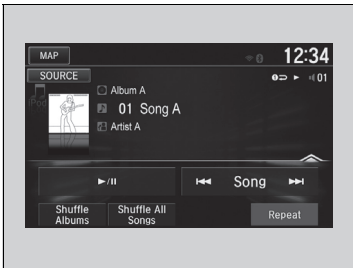

### To turn off a play mode

Select the mode you want to turn off.

## How to Select a Play Mode

Play Mode Menu Items

**Shuffle Albums:** Plays all available albums in a selected list (playlists, artists, albums, songs, podcasts, genres, composers, or audiobooks) in random order.

**Shuffle All Songs:** Plays all available files in a selected list (playlists, artists, albums, songs, podcasts, genres, composers, or audiobooks) in random order.

**Repeat Song:** Repeats the current track.

Models with navigation system

## Song By Voice™ (SBV)

Use SBV to search for and play music from your USB flash drive or iPod using voice commands.

### ■ To enable SBV

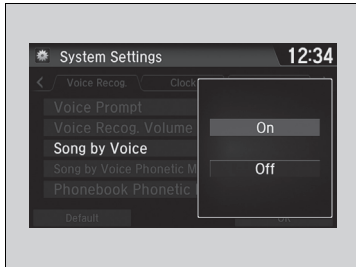

1. Select .
2. Select **Settings**.
3. Select **System**.
4. Select the **Voice Recog.** tab.
5. Select **Song by Voice**.
6. Select **On** or **Off**.



### ☞ Song By Voice™ (SBV)

Setting options:

- **On** (factory default): Song By Voice™ commands are available.
- **Off**: Disable the feature.

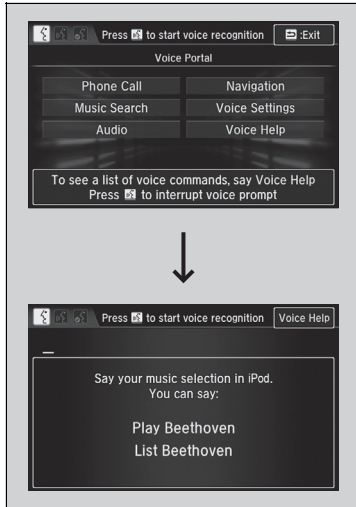
## ■ Searching for music using SBV



1. Set the **Song by Voice** setting to **On**.
2. Press the  (Talk) button and say "Music Search" to activate the SBV feature for the USB flash drive and iPod.
3. Press the  button and say a command.
  - ▶ Example 1: Say "(List) 'Artist A'" to view a list of songs by that artist. Select the desired song to start playing.
  - ▶ Example 2: Say "Play 'Artist A'" to start playing songs by that artist.
4. To cancel SBV, press the  (hang-up/back) button on the steering wheel. The selected song continues playing.

Once you have canceled this mode, you need to press the  button and say "Music Search" again to re-activate this mode.

### ▶▶ Searching for music using SBV

Song By Voice™ Commands List

▶ **Song By Voice™ (SBV)** P. 270

NOTE:

Song By Voice™ commands are available for tracks stored on the USB flash drive or iPod.

You can add phonetic modifications of difficult words so that it is easier for SBV to recognize artists, songs, albums, and composers in voice commands.

▶ **Phonetic Modification** P. 272

## Phonetic Modification

Add phonetic modifications of difficult or foreign words so that it is easier for SBV to recognize artists, songs, albums, and composers in voice commands when searching for music on the USB flash drive or iPod.

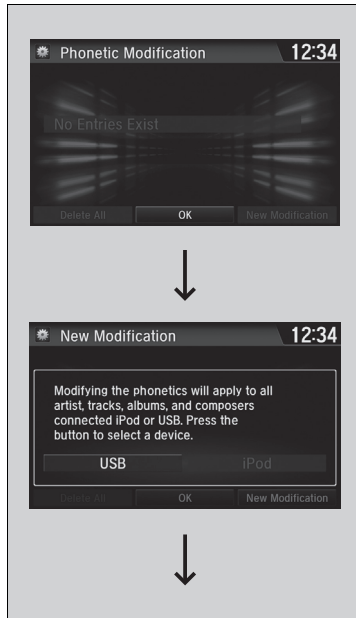

1. Select .
2. Select **Settings**.
3. Select **System**.
4. Select the **Voice Recog.** tab.
5. Select **Song by Voice Phonetic Modification**.
6. Select **New Modification**.
7. Select **USB** or **iPod**.

### Phonetic Modification

**Song by Voice Phonetic Modification** is grayed out when **Song By Voice** is set to **Off**.

You can store up to 2,000 phonetic modification items.



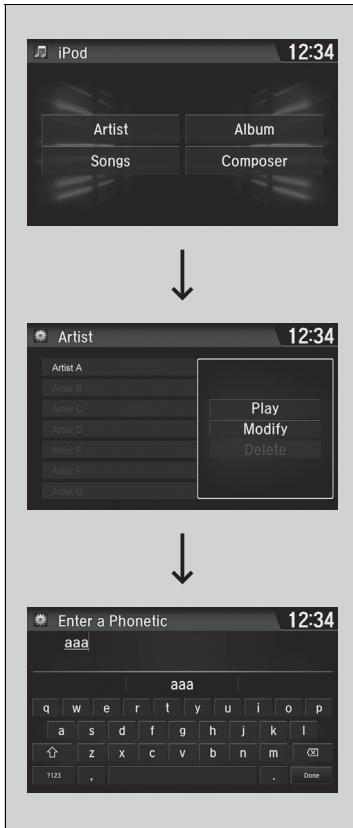

8. Select the item to modify (e.g., **Artist**).

▶ The list of the selected item appears on the screen.

9. Select an entry to modify.

▶ The pop-up menu appears on the screen.

▶ To listen to the current phonetic modification, select **Play**.

▶ To delete the current phonetic modification, select **Delete**.

10. Select **Modify**.

11. Select the phonetic spelling you want to use (e.g., "Artist A") when prompted.

12. Select **OK**.

▶ The artist "No Name" is phonetically modified to "Artist A." When in the SBV mode, you can press the  (Talk) button and use the voice command "Play 'Artist A'" to play songs by the artist "No Name."

U.S. models

## Playing Pandora®

Your audio system allows you to listen to music from the Pandora® app on a compatible smartphone.

This function is available when the phone is paired and connected to the vehicle's *Bluetooth*® HandsFreeLink® (HFL) system, or with an iPhone, you can connect using your USB cable to the USB port.

▶ **Phone Setup** P. 375

▶ **USB Port(s)** P. 207

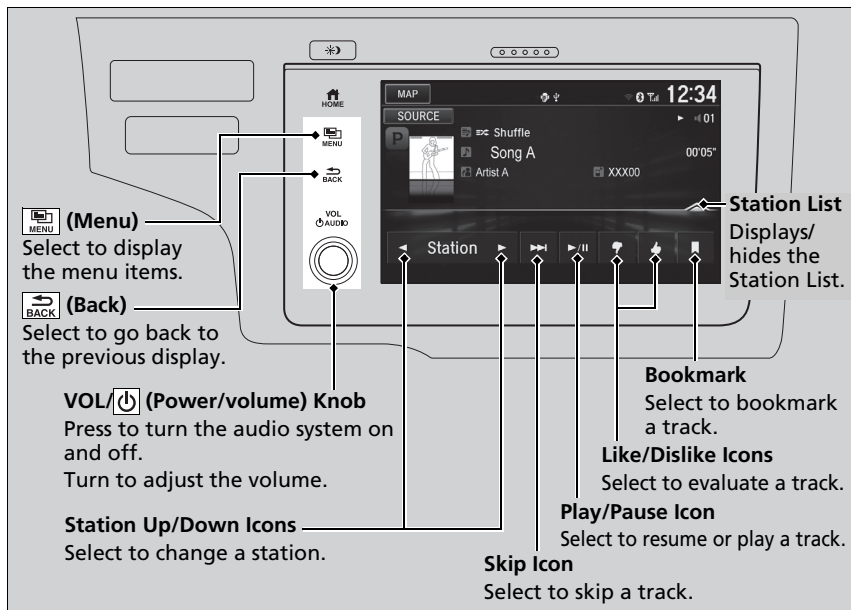

\*1: Some or all of the lists may not be displayed.

### ▶▶ Playing Pandora®

Pandora®, the Pandora logo, and the Pandora trade dress are trademarks or registered trademarks of Pandora Media, Inc., used with permission. Pandora is only available in certain countries. Visit the Pandora website for more information.

To find out if your phone is compatible with this feature, visit [automobiles.honda.com/handsfreelink/](http://automobiles.honda.com/handsfreelink/), or call 1-888-528-7876.

To use this service in your vehicle, the Pandora® app must first be installed on your phone. Visit [www.pandora.com](http://www.pandora.com) for more information.

Find the music you love and let the music you love find you. Pandora® gives you a personalized music experience that continually evolves with your tastes. Create personalized stations from songs, artists or genres. Not sure where to start? Use our voice search to easily find stations that match your mood or activity.

If you cannot operate Pandora® through the audio system, it may be streaming through *Bluetooth*® Audio. Make sure Pandora® mode on your audio system is selected.

If your phone is connected to Android Auto™, Pandora is only available through the Android Auto™ interface. Visit the Android Auto™ website to check compatibility.

## Pandora® Menu

You can operate some of the Pandora® menu items from your vehicle's audio system. The available items are:

- **Station List**
- **Manage Station**
- **Sound**
- **Setting**

### ■ Operating a menu item

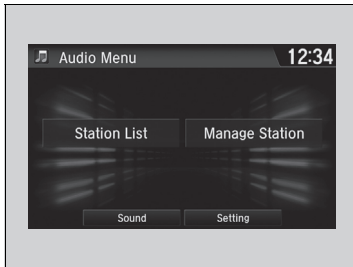

1. Select .
2. Select an item.

### ▶▶ Pandora® Menu

Manage Station Items

**Genre:** Add the selected genre to the station list.

**Current Artist:** Add the current artist to station list.

**Current Track:** Add the current track to station list.

**Delete:** Delete the selected Station from the Station list.

Available operating functions vary on software versions. Some functions may not be available on the vehicle's audio system.

If there is a problem, you may see an error message on the audio/information screen.

▶▶ **Pandora®** P. 314

Pandora® may limit the total number of skips allowed on the service. If you dislike a track after the skip limit has been reached, your feedback will be saved but the current track will continue to play.

To change stations, activate the Pandora® menu, select **Station List**, and then select a new station. It also changes stations on the main Pandora® screen.

## Playing a USB Flash Drive

Your audio system reads and plays sound and video files on a USB flash drive in either MP3, WMA, or AAC\*<sup>1</sup> format.

Connect your USB flash drive to the USB port, then select the USB mode.

➤ **USB Port(s)** P. 207

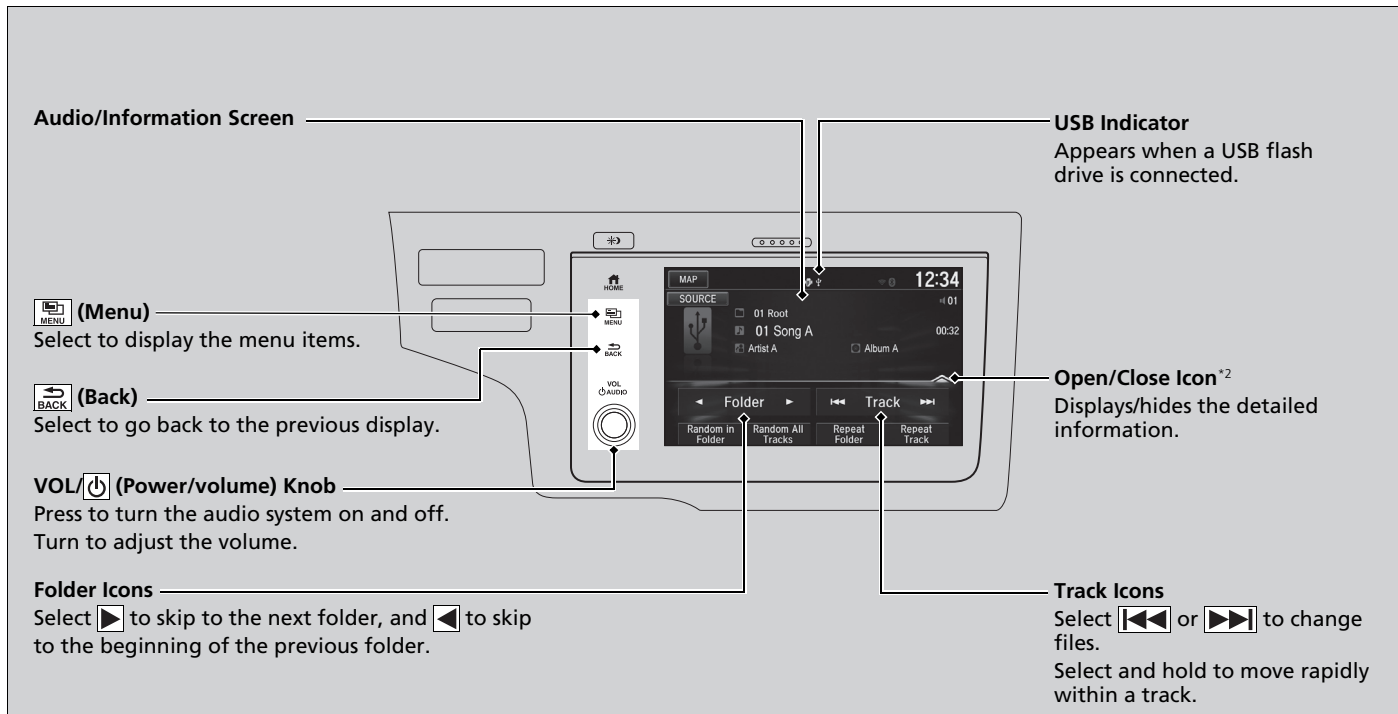

\*1: Only AAC format files recorded with iTunes are playable on this unit.

\*2: Some or all of the lists may not be displayed.

## How to Select a File from the Music Search List

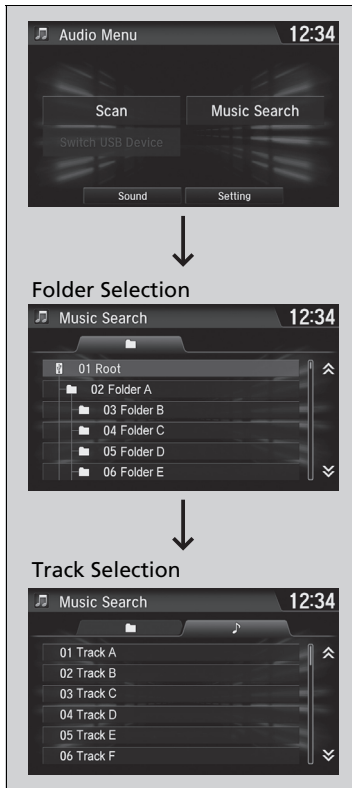

1. Select  and select **Music Search**.

2. Select a folder.

3. Select a track.

## ▶▶ Playing a USB Flash Drive

Use the recommended USB flash drives.

▶ **General Information on the Audio System**  
P. 317

WMA files protected by digital rights management (DRM) cannot be played.

The audio system displays **Unplayable File**, then skips to the next file.

If there is a problem, you may see an error message on the audio/information screen.

▶ **iPod/USB Flash Drive** P. 313

Select **Switch USB Device** in the **Audio Menu** screen to switch to another USB device.

## ■ How to Select a Play Mode

You can select scan, repeat, and random modes when playing a file.

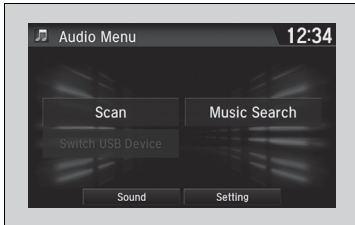

1. Select .
2. Select **Scan**.
3. Select a mode.

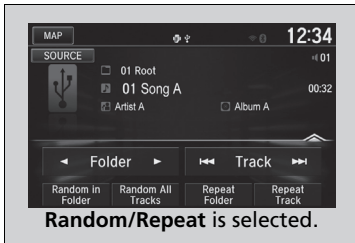

### ■ Random/Repeat

Select a play mode.

### ■ To turn off a play mode

To turn off Scan, select  or **Cancel**.

To turn off **Random/Repeat**, select the mode again.

## ▶▶ How to Select a Play Mode

Play Mode Menu Items

### Scan

**Scan Folders:** Provides 10-second sampling of the first file in each of the main folders.

**Scan Tracks:** Provides 10-second sampling of all files in the current folder.

### Random/Repeat

**Repeat Folder:** Repeats all files in the current folder.

**Repeat Track:** Repeats the current file.

**Random in Folder:** Plays all files in the current folder in random order.

**Random All Tracks:** Plays all files in random order.

## Playing *Bluetooth*® Audio

Your audio system allows you to listen to music from your *Bluetooth*-compatible phone.

This function is available when the phone is paired and connected to the vehicle's *Bluetooth*® HandsFreeLink® (HFL) System.

☑ **Phone Setup** P. 375

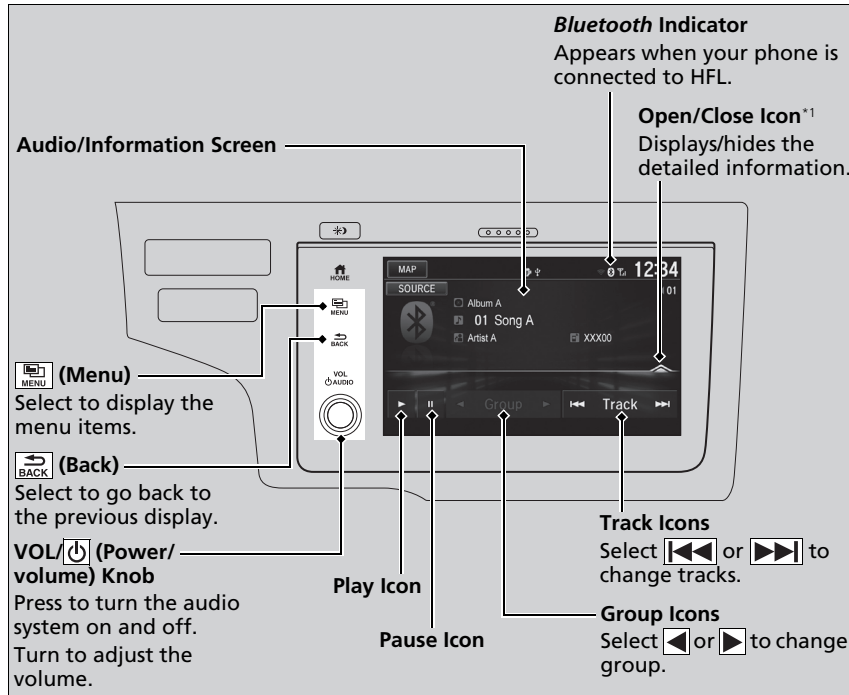

\*1: Depending on the *Bluetooth*® device you connect, some or all of the lists may not be displayed.

### ▶▶ Playing *Bluetooth*® Audio

Not all *Bluetooth*-enabled phones with streaming audio capabilities are compatible.  
To check if your phone is compatible, visit [automobiles.honda.com/handsfreelink/](http://automobiles.honda.com/handsfreelink/).

It may be illegal to perform some data device functions while driving.

Only one phone can be used with HFL at a time. When there are more than two paired phones in the vehicle, the first paired phone the system finds is automatically connected.

If more than one phone is paired to the HFL system, there may be a delay before the system begins to play.

In some cases, the name of the artist, album, or track may not appear correctly.

Some functions may not be available on some devices.

If a phone is currently connected via Apple CarPlay™ or Android Auto™, *Bluetooth*® Audio from that phone is unavailable. However, a second previously paired phone can stream *Bluetooth*® Audio by selecting **Connect**  from **Bluetooth Device List**.

☑ **Phone Setup** P. 375

## ■ To Play *Bluetooth*® Audio Files

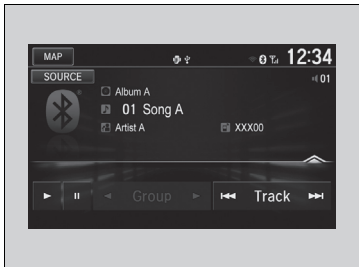



1. Make sure that your phone is paired and connected to the system.  
 ▶ **Phone Setup** P. 375
2. Select the *Bluetooth*® Audio mode.

If the phone is not recognized, another HFL-compatible phone, which is not compatible for *Bluetooth*® Audio, may already be connected.

- **To pause or resume a file**  
 Select the play icon or pause icon.

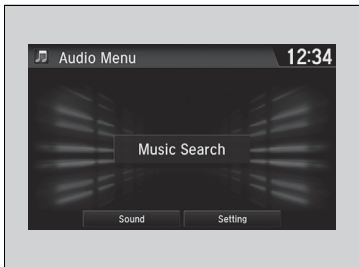
## ■ Searching for Music



1. Select .
2. Select **Music Search**.
3. Select a search category (e.g., Albums).
4. Select an item.  
 ▶ The selection begins playing.

## ▶▶ To Play *Bluetooth*® Audio Files

To play the audio files, you may need to operate your phone. If so, follow the phone maker's operating instructions.

Switching to another mode pauses the music playing from your phone.

You can change the connected phone in the *Bluetooth*® settings on the **Audio Menu** screen by the following procedure.

1. Select .
2. Select **Setting**.
3. Select **Bluetooth Device List**.

## ▶▶ Searching for Music

Depending on the *Bluetooth*® device you connect, some or all of the lists may not be displayed.



## HondaLink®

HondaLink® connects you to the latest information from Honda. You can connect your phone wirelessly through Wi-Fi or *Bluetooth®*.

▶ **Wi-Fi Connection** P. 286

▶ **Phone Setup** P. 375

### HondaLink® Menu

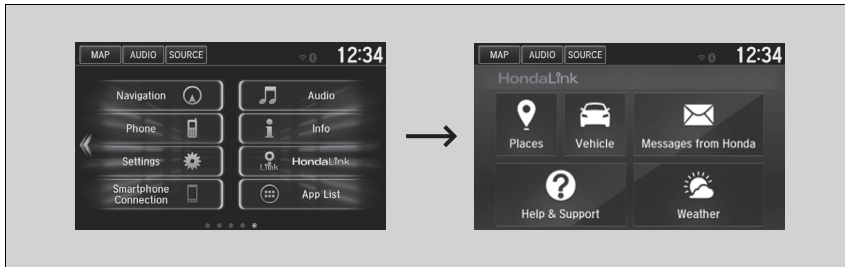

#### ■ Places\*

Displays restaurants, gas stations, Honda dealer, and so on. You can also navigate to the found locations via the navigation.

#### ■ Vehicle

Displays instruction messages when the vehicle needs service.

#### ■ Help & Support

Displays tips for vehicle usage, and get support via road side or customer service center.

#### ▶▶ HondaLink®

The HondaLink® connect app is compatible with most iPhone and Android phones.

Some cell phone carriers charge for tethering and smartphone data use. Check your phone's data subscription package.

If there is an active connection to Apple CarPlay™ or Android Auto™, HondaLink® can only be connected through Wi-Fi.

\* Not available on all models

## ■ Messages from Honda

Displays helpful and important information from Honda.

## ■ Weather\*

Displays a weekly five-day weather forecast for any location you want. You can change the ZIP Code at any time.

## ■ To Set Up to Connect HondaLink® Service

Use the following procedure to connect to HondaLink® service.

### ■ To enable the HondaLink® service

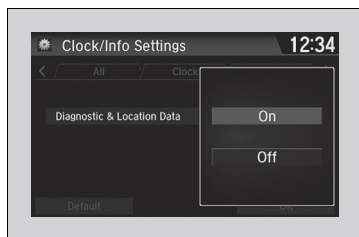

1. Select .
2. Select **Settings**.
3. Select **Clock/Info**.
4. Select the **HondaLink** tab.
5. Select **Diagnostic & Location Data**.
6. Select **On**.

You need to allow the consent of the location service to enable the HondaLink® service.

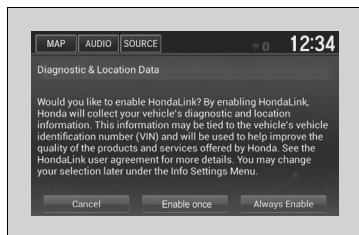

**Enable once:** Allows only one time. (Prompt shows again next time.)

**Always Enable:** Allows anytime. (Prompt does not show again.)

**Cancel:** Does not allow this consent.

## ■ To link with HondaLink®

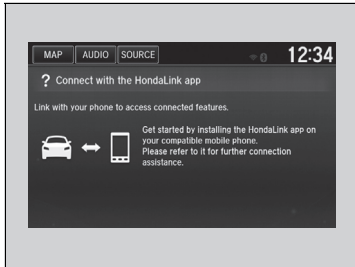

You can see the **Connection Guide** screen after launching HondaLink®. If you do not need this guide, select check-box and select **OK**.

## ■ Vehicle Information and Message from Honda Tips

You can check the messages that are received quickly in the shortcut operation.



1. A message appears and notifies you of a new message on the header area.

▶ When the message is received, a notification ring can be heard.

2. A message icon is continuously displayed in the header area until the new message is read.

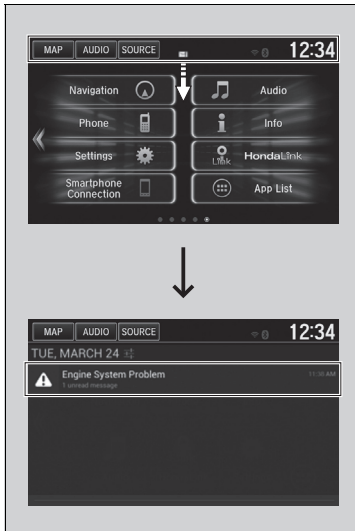

- From the top of the screen, swipe down to see the messages.

- Select a new message to open.
  - ▶ If you have selected the update option for HondaLink®, follow the directions on the screen to complete the process.

#### ▶▶ Vehicle Information and Message from Honda Tips

When you update HondaLink®, you must keep the engine running and maintain a constant connection with HondaLink®.

If the update is interrupted, the system will automatically resume the process. If, however, a week has elapsed since the process was first interrupted, you must repeat the process from the beginning.

You can update HondaLink® by selecting **Message from Honda** on the HondaLink® menu.

## Wi-Fi Connection

You can connect the display audio system to the Internet using Wi-Fi and browse websites or use online services on the audio/information screen. If your phone has wireless hotspot capabilities, the system can be tethered to the phone. Use the following steps to setup.

### Wi-Fi mode (setting for the first time)



1. Select .
2. Select **Settings**.
3. Select **Bluetooth / Wi-Fi**.
4. Select the **Wi-Fi** tab.
5. Select **Wi-Fi On/Off Status**, then **On**.
6. A confirmation message appears on the screen. Select **Yes**.
7. Select **Wi-Fi Device List**.
  - ▶ Make sure your phone's Wi-Fi setting is in access point (tethering) mode.
  - ▶ Select the phone you want to connect to the system.
  - ▶ If you do not find the phone you want to connect in the list, select **Scan**.

### Wi-Fi mode (setting for the first time)

You cannot go through the setting procedure while a vehicle is moving. Park in a safe place to set the audio system in Wi-Fi mode.

Some cell phone carriers charge for tethering and smartphone data use. Check your phone's data subscription package.

Check your phone manual to find out if the phone has Wi-Fi connectivity.

You can confirm whether Wi-Fi connection is on or off with the  icon on **Wi-Fi Device List**. Transmission speed and others will not be displayed on this screen.

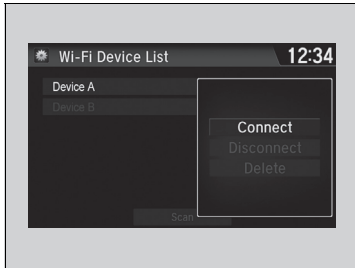

**8. Select **Connect**.**

- ▶ Enter a password for your phone, and select **Done**.
- ▶ When the connection is successful, the  icon is displayed on the list.

**9. Select  to go back to the home screen.**

## Wi-Fi mode (after the initial setting has been made)

Make sure your phone's Wi-Fi setting is in access point (tethering) mode.

### Wi-Fi mode (after the initial setting has been made)

#### iPhone users

You may need to go through an initial setup for Wi-Fi connection again after you boot your phone.

## Siri® Eyes Free

You can talk to Siri® using the  (Talk) button on the steering wheel when your iPhone is paired to the *Bluetooth*® HandsFreeLink® (HFL) System.

➔ **Phone Setup** P. 375

### ▶▶ Siri® Eyes Free

Siri® is a trademark of Apple Inc.

Check Apple Inc. website for features available for Siri®.

We recommend against using Siri® other than in Siri® Eyes Free while operating a vehicle.

### ▶▶ Using Siri® Eyes Free

Some commands work only on specific phone features or apps.

### ■ Using Siri® Eyes Free

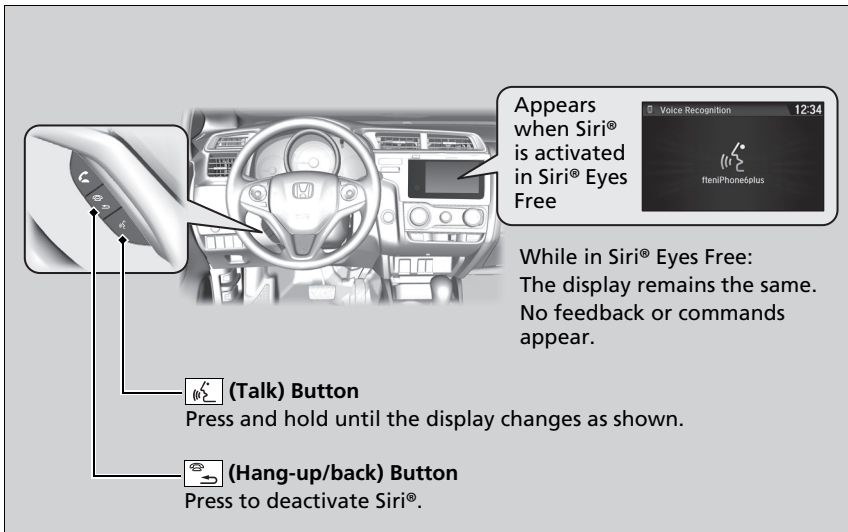

Appears when Siri® is activated in Siri® Eyes Free

While in Siri® Eyes Free:  
The display remains the same.  
No feedback or commands appear.

 **(Talk) Button**  
Press and hold until the display changes as shown.

 **(Hang-up/back) Button**  
Press to deactivate Siri®.



## Apple CarPlay™

If you connect an Apple CarPlay™-compatible iPhone to the system via the 1.5A USB port, you can use the audio/information touch screen, instead of the iPhone display, to make a phone call, listen to music, view maps (navigation), and access messages.

📄 **USB Port(s)** P. 207

### 📄 Apple CarPlay™

Only iPhone5 or newer versions with iOS 8.4 or later are compatible with Apple CarPlay™.

Park in a safe place before connecting your iPhone to Apple CarPlay™ and when launching any compatible apps.

To use Apple CarPlay™, connect the USB cable to the 1.5A USB port. The USB port located in the center console storage will not enable Apple CarPlay™ operation.

📄 **USB Port(s)** P. 207

To directly access the Apple CarPlay™ phone function, select **Phone** on the home screen. While connected to Apple CarPlay™, calls are only made through Apple CarPlay™. If you want to make a call with *Bluetooth*® HandsFreeLink®, turn Apple CarPlay™ OFF or detach the USB cable from your iPhone.

📄 **Setting Up Apple CarPlay™** P. 291

When your iPhone is connected to Apple CarPlay™, it is not possible to use the *Bluetooth*® Audio or *Bluetooth*® HandsFreeLink®. However, other previously paired phones can stream audio via *Bluetooth*® while Apple CarPlay™ is connected.

📄 **Phone Setup** P. 375

For details on countries and regions where Apple CarPlay™ is available, as well as information pertaining to function, refer to the Apple homepage.

## ■ Apple CarPlay™ Menu

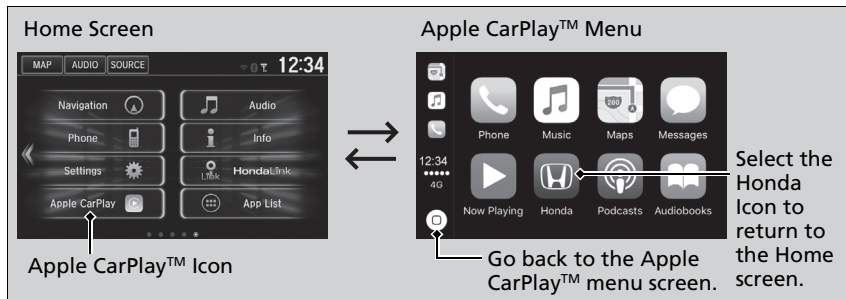

### ■ Phone

Access the contact list, make phone calls, or listen to voice mail.

### ■ Messages

Check and reply to text messages, or have messages read to you.

### ■ Music

Play music stored on your iPhone.

### ■ Maps

Display Apple Maps and use the navigation function just as you would on your iPhone.

### Models with navigation system

Only one navigation system (pre-installed navigation or Apple CarPlay™ map) can give directions at a time. When you are using one system, directions to any prior destination set on the other system will be canceled, and the system you are currently using will direct you to your destination.

## ▶▶ Apple CarPlay™

### Apple CarPlay™ Operating Requirements & Limitations

Apple CarPlay™ requires a compatible iPhone with an active cellular connection and data plan. Your carrier's rate plans will apply.

Changes in operating systems, hardware, software, and other technology integral to providing Apple CarPlay™ functionality, as well as new or revised governmental regulations, may result in a decrease or cessation of Apple CarPlay™ functionality and services. Honda cannot and does not provide any warranty or guarantee of future Apple CarPlay™ performance or functionality.

It is possible to use 3rd party apps if they are compatible with Apple CarPlay™. Refer to the Apple homepage for information on compatible apps.

## ■ Setting Up Apple CarPlay™

After you have connected your iPhone to the system via USB, use the following procedure to set up Apple CarPlay™. Use of Apple CarPlay™ will result in the transmission of certain user and vehicle information (such as vehicle location, speed, and status) to your iPhone to enhance the Apple CarPlay™ experience. You will need to consent to the sharing of this information on the audio/information touch screen.

### ■ Enabling Apple CarPlay™

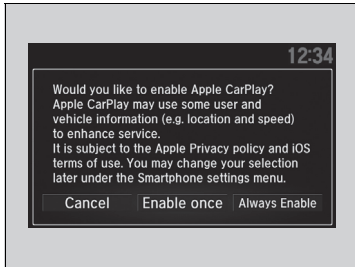

- **Enable once:** Allows only once. (Prompt shows again next time.)
- **Always Enable:** Allows anytime. (Prompt does not show again.)
- **Cancel:** Does not allow this consent.

You may change the consent settings under the **Smartphone** settings menu.

### ▶▶ Setting Up Apple CarPlay™

You can also use the method below to set up Apple CarPlay™:  
Select HOME→Settings→Smartphone→Apple CarPlay.

#### Use of user and vehicle information

The use and handling of user and vehicle information transmitted to/from your iPhone by Apple CarPlay™ is governed by the Apple iOS terms and conditions and Apple's Privacy Policy.

## ■ Operating Apple CarPlay™ with Siri®

Press and hold the talk button to activate Siri®.

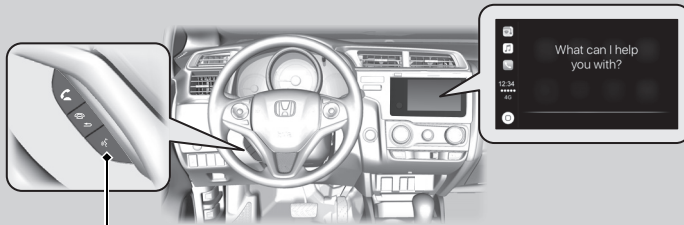

 **(Talk) button:**  
Press and hold to activate Siri®.  
Press again to deactivate Siri®.  
Press and release to activate standard voice recognition system.

## ▶▶ Operating Apple CarPlay™ with Siri®

Below are examples of questions and commands for Siri®.

- What movies are playing today?
- Call dad at work.
- What song is this?
- How's the weather tomorrow?
- Read my latest email.
- Find a table for four tonight in Chicago.

For more information, please visit  
[www.apple.com/ios/siri](http://www.apple.com/ios/siri).

## Android Auto™

When you connect an Android phone to the Display Audio system via the 1.5A USB port, Android Auto™ is automatically initiated. When connected via Android Auto™, you can use the audio/information touch screen to access the Phone, Google Maps (Navigation), Google Play Music, and Google Now functions. When you first use Android Auto™, a tutorial will appear on the screen. We recommend that you complete this tutorial while safely parked before using Android Auto™.

➤ **USB Port(s)** P. 207

➤ **Auto Pairing Connection** P. 295

### Android Auto™

To use Android Auto™, you need to download the Android Auto™ app from Google Play to your smartphone.

Only Android 5.0 (Lollipop) or later versions are compatible with Android Auto™. *Bluetooth* A2DP cannot be used with Android Auto™ phone.

Park in a safe place before connecting your Android phone to Android Auto™ and when launching any compatible apps.

To use Android Auto™, connect the USB cable to the 1.5A USB port. The USB port in the center console storage will not enable Android Auto™ operation.

➤ **USB Port(s)** P. 207

To directly access the Android Auto™ phone function, select **Phone** on the home screen. While connected to Android Auto™, calls are only made through Android Auto™. If you want to make a call with *Bluetooth*® HandsFreeLink®, turn Android Auto™ OFF or detach the USB cable from your Android phone.

➤ **Auto Pairing Connection** P. 295

When your Android phone is connected to Android Auto™, it is not possible to use *Bluetooth*® Audio or *Bluetooth*® HandsFreeLink®. However, other previously paired phones can stream audio via *Bluetooth*® while Android Auto™ is connected.

➤ **Phone Setup** P. 375

## Android Auto™ Menu

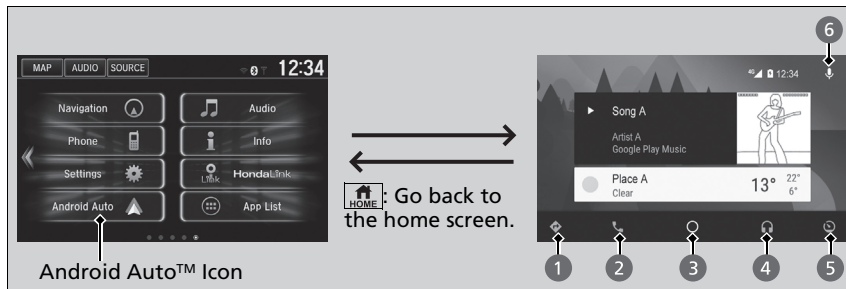

Android Auto™ Icon

### 1 Maps (Navigation)

Display Google Maps and use the navigation function just as you would with your Android phone. When the vehicle is in motion, it is not possible to make keyboard entries. Stop the vehicle in a safe location to undertake a search or provide other inputs.

#### Models with navigation system

Only one navigation system (pre-installed navigation or Android Auto™) can give directions at a time. When you are using one system, directions to any prior destination set on the other system will be canceled, and the system you are currently using will direct you to your destination.

The audio/Information screen shows you turn-by-turn driving directions to your destination.

### 2 Phone (Communication)

Make and receive phone calls as well as listen to voicemail.

### 3 Google Now (Home screen)

Display useful information organized by Android Auto™ into simple cards that appear just when they're needed.

### 4 Music and audio

Play Google Play Music and music apps that are compatible with Android Auto™. To switch between music apps, press this icon.

### 5 Go back to the home screen

### 6 Voice

Operate Android Auto™ with your voice.

## Android Auto™

For details on countries and regions where Android Auto™ is available, as well as information pertaining to function, refer to the Android Auto™ homepage.

### Android Auto™ Operating Requirements & Limitations

Android Auto™ requires a compatible Android phone with an active cellular connection and data plan. Your carrier's rate plans will apply.

Changes in operating systems, hardware, software, and other technology integral to providing Android Auto™ functionality, as well as new or revised governmental regulations, may result in a decrease or cessation of Android Auto™ functionality and services. Honda cannot and does not provide any warranty or guarantee of future Android Auto™ performance or functionality.

It is possible to use 3rd party apps if they are compatible with Android Auto™. Refer to the Android Auto™ homepage for information on compatible apps.

## ■ Auto Pairing Connection

When you connect an Android phone to the unit via USB, Android Auto™ is automatically initiated.

## ■ Enabling Android Auto™

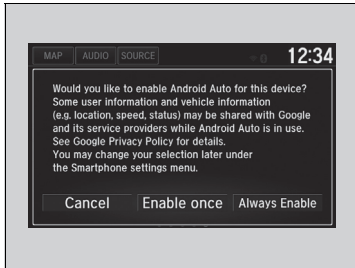

- **Enable once:** Allows only once. (Prompt shows again next time.)
- **Always Enable:** Allows anytime. (Prompt does not show again.)
- **Cancel:** Does not allow this consent.

You may change the consent settings under the **Smartphone** settings menu.

## ▶▶ Enabling Android Auto™

Only initialize Android Auto™ when you are safely parked. When Android Auto™ first detects your phone, you will need to set up your phone so that auto pairing is possible. Refer to the instruction manual that came with your phone.

You can use the method below to change Android Auto™ settings after you have completed the initial setup:  
Select HOME→Settings→Smartphone→Android Auto.

### Use of user and vehicle information

The use and handling of user and vehicle information transmitted to/from your phone by Android Auto™ is governed by Google's Privacy Policy.

## ■ Operating Android Auto™ with Voice Recognition

Press and hold the talk button to operate Android Auto™ with your voice.

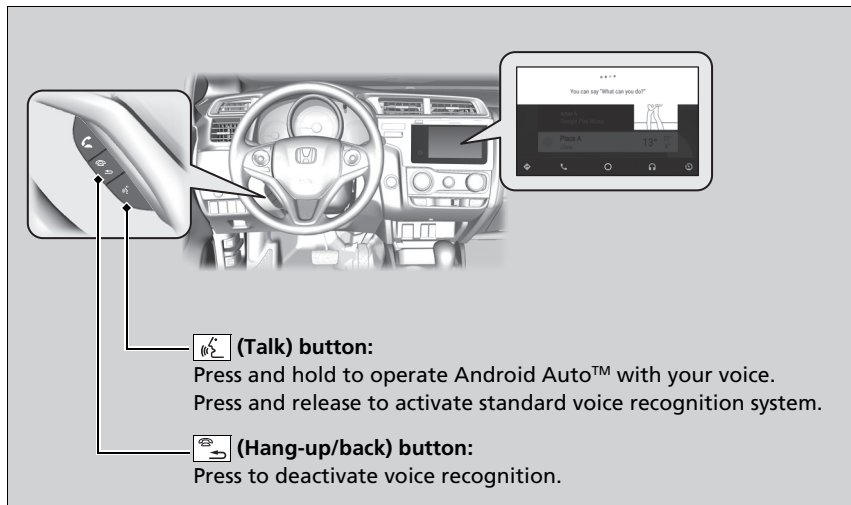

## ▶▶ Operating Android Auto™ with Voice Recognition

Below are examples of commands you can give with voice recognition:

- Reply to text.
- Call my wife.
- Navigate to Honda.
- Play my music.
- Send a text message to my wife.
- Call flower shop.

For more information, please refer to the Android Auto™ homepage.

You can also activate the voice recognition function by pressing the  icon in the upper-right corner of the screen.



# Honda App License Agreement

## END USER LICENSE AGREEMENT

PLEASE CAREFULLY READ THIS END USER LICENSE AGREEMENT (THIS "AGREEMENT") WHICH GOVERNS YOUR USE OF THE SOFTWARE INSTALLED ON YOUR HONDA OR ACURA VEHICLE (YOUR "VEHICLE") AS WELL AS THE APPLICATIONS, SERVICES, FUNCTIONS, AND CONTENT PROVIDED THROUGH THE SOFTWARE (COLLECTIVELY, THE "SERVICES"). YOUR USE OF THE SOFTWARE OR SERVICES WILL SERVE AS YOUR CONSENT TO THE TERMS OF THIS AGREEMENT. THE SOFTWARE IS OWNED (OR LICENSED), PROVIDED, AND/OR OPERATED BY AMERICAN HONDA MOTOR CO. INC., ("HONDA," "US," "WE," OR "OUR"), WITH ITS BUSINESS ADDRESS AT 1919 TORRANCE BLVD., TORRANCE, CA 90501. REFERENCE TO "HONDA" IN THIS AGREEMENT INCLUDES HONDA'S PARENT COMPANY AND ITS AFFILIATES AND DESIGNATED AGENTS. THE SERVICES ARE OWNED (OR LICENSED), PROVIDED, AND/OR OPERATED BY HONDA OR A THIRD-PARTY SERVICE PROVIDER (A "PROVIDER"). REFERENCE TO A "PROVIDER" IN THIS AGREEMENT INCLUDES SUCH PROVIDER'S PARENT COMPANY, AFFILIATES, AND DESIGNATED AGENTS.

**A. Description of the Software.** The SOFTWARE includes the software, firmware and the like, installed and executing on your VEHICLE during manufacture, and thereafter updated from time to time by HONDA, you or an authorized HONDA dealer (a "DEALER"). The SOFTWARE allows you to access and use a variety of SERVICES, including but not limited to: (a) HONDA applications, services, and content provided through the SOFTWARE (together, "HONDA SERVICES"); and (b) PROVIDER applications, services, and content provided through the SOFTWARE (together, "PROVIDER SERVICES"), each of which may provide access to various information, media, content, and services.

### **B. SOFTWARE Licensing and Intellectual Property.**

**1. SOFTWARE.** This AGREEMENT grants you a non-exclusive, limited, and revocable license to use the SOFTWARE and SERVICES solely (a) as installed on your VEHICLE by HONDA, (b) as updated on your Vehicle by HONDA, you (but only as and when directed by HONDA), or a DEALER and (c) as permitted under the terms of this AGREEMENT.

**2. HONDA Services.** The SOFTWARE may provide you with access to various HONDA SERVICES. Installation, activation, or use of HONDA SERVICES may require your consent to additional terms, conditions, and privacy policies applicable to those HONDA SERVICES (the "HONDA TERMS"). You acknowledge and agree that any collection, use, sharing of data generated by your VEHICLE or your use of your VEHICLE, and your use of the HONDA SERVICES shall be subject to this AGREEMENT and any additional HONDA TERMS that may be specifically applicable to such HONDA SERVICES or data generation. The HONDA SERVICES may collect, use, and share such data while you are using the SOFTWARE.

**3. Open-Source Software.** The SOFTWARE and SERVICES may incorporate software licensed to HONDA under free or open-source licenses which govern HONDA's distribution and your use of such software. HONDA and the third-party authors, licensors, and distributors of such software disclaim all warranties and all liability arising from any and all use or distribution of the software. To the extent such software is provided under terms that differ from the applicable free or open-source licenses, those terms are offered by HONDA alone. Additional information regarding free and open-source software incorporated in the SOFTWARE and SERVICES is available in this manual or within the SOFTWARE.

**4. Provider Services.** The SOFTWARE may provide you with access to various PROVIDER SERVICES. Installation or use of such PROVIDER SERVICES may require your consent to additional terms, conditions, and privacy policies of the applicable PROVIDER (the "PROVIDER TERMS"). This AGREEMENT restricts the manner in which you can install and use PROVIDER SERVICES but does not grant you a license or permission to use such PROVIDER SERVICES. Your permission to use PROVIDER SERVICES is limited and subject to any license grants, conditions, and limitations included in the PROVIDER TERMS. You acknowledge that any collection, use, sharing of your information, targeted advertising practices by PROVIDERS, and your use of the PROVIDER SERVICES shall be subject to both this AGREEMENT and any applicable PROVIDER TERMS. The PROVIDER SERVICES may collect, use, and share such information while you are using the SOFTWARE.

### **5. License Limitations and Restrictions on Use.**

(a) Limited License. You understand and agree that the SOFTWARE and SERVICES are licensed, not sold, to you solely for use in accordance with this AGREEMENT and any applicable PROVIDER TERMS, and any documentation for the VEHICLE made available to you by HONDA (any "DOCUMENTATION"). HONDA and its licensors reserve all rights in the SOFTWARE and HONDA SERVICES not expressly granted to you under this AGREEMENT. PROVIDERS and their licensors reserve all rights in the PROVIDER SERVICES not expressly granted to you under the applicable PROVIDER TERMS.

(b) Restrictions on Use. The licenses granted under this AGREEMENT do not permit you to use the SOFTWARE or SERVICES on a device other than your VEHICLE. As a condition of using the SOFTWARE and SERVICES, you agree that you may not and will not:

- (1) copy, download, distribute, modify, publish, sell, rent, lease, lend, license, sublicense, reuse, or create derivative works of the SOFTWARE or SERVICES or any of the content or other material within the SOFTWARE or SERVICES, including without limitation, HONDA or PROVIDER names, logos, or any other trademarks of HONDA or PROVIDERS or used in association with the SOFTWARE or any SERVICES, except as required to use the SOFTWARE or SERVICES in accordance with this AGREEMENT, any applicable PROVIDER TERMS, and the DOCUMENTATION;
- (2) access or use the SOFTWARE or SERVICES in any manner intended to damage or impair the operation of the SOFTWARE or SERVICES or interfere with anyone else's use and enjoyment of the SOFTWARE or SERVICES;
- (3) access or attempt to access any system or server on which the SOFTWARE or SERVICES is hosted or modify or alter the SOFTWARE or SERVICES in any way;
- (4) use the SOFTWARE or SERVICES for any unlawful purpose, or in violation of any third party rights;
- (5) use the SOFTWARE or SERVICES in violation of any applicable traffic regulations, rules or laws, including but not limited to any driver distraction laws, rules or regulations;
- (6) violate the terms of this AGREEMENT, any HONDA TERMS, any PROVIDER TERMS or other applicable third-party terms, conditions, and privacy policies; or
- (7) reverse engineer, decompile, disassemble, attempt to derive the source code of, nor permit others to reverse engineer, decompile, or disassemble, or attempt to derive the source code of the SOFTWARE or SERVICES, except and only to the extent that such activity is expressly permitted (a) by applicable law notwithstanding this limitation or (b) the terms of applicable free or opensource software licenses.

**6. Intellectual Property Rights.** All title and intellectual property rights in and to the SOFTWARE and SERVICES, the accompanying DOCUMENTATION, and all copies of the SOFTWARE or SERVICES are owned by HONDA, PROVIDERS, or their suppliers or licensors. This AGREEMENT does not grant you any rights in connection with any trademarks or service marks of HONDA, PROVIDERS, or their licensors, affiliates, or suppliers.

**7. Export Restrictions:** You acknowledge that the SOFTWARE and SERVICES are subject to U.S., European Union, and other export jurisdictions. You agree to comply with all applicable international and national laws that apply to the SOFTWARE and SERVICES, including the U.S. Export Administration Regulations, as well as end-user, end-use, and destination restrictions issued by the U.S. and other governments.

### **C. SOFTWARE Operation**

**1.** HONDA reserves the right to suspend or terminate your access to and use of the SOFTWARE or SERVICES if you are found to be in violation of this AGREEMENT or as reasonably deemed necessary by HONDA.

**2.** Eligibility/Registration/Activation. The SOFTWARE is intended for and available to individuals who (a) are of legal age of majority in their jurisdiction of residence (and at least 18 years of age), or are younger than 18 years of age and possess a valid driver's license issued by their jurisdiction of residence, and (b) own or have permissive access to a compatible VEHICLE. We do not knowingly collect any information, including personal information, from children under 13. If we learn or are notified that we have collected personal information of a child under 13, we will immediately take steps to delete such information.

**3.** Use of PROVIDER SERVICES through the SOFTWARE. Certain PROVIDER SERVICES made available through the SOFTWARE may require that you register or otherwise have an account with the PROVIDER and agree to PROVIDER TERMS. Any use of any of such PROVIDER SERVICES within the SOFTWARE is subject to this AGREEMENT and the applicable PROVIDER TERMS. HONDA does not exercise control over such PROVIDER SERVICES and is not responsible or liable for the availability, security, or content of such PROVIDER SERVICES, and the inclusion of any PROVIDER SERVICES does not imply a referral from, the approval of, or the endorsement by HONDA of such PROVIDER SERVICES. HONDA is not responsible or liable, directly or indirectly, for any damage relating to or resulting from your use of the PROVIDER SERVICES.

**4.** Links to Third Party Sites: The SOFTWARE may provide you with the ability to access third-party sites and content through the use of the SOFTWARE or SERVICES. The third-party sites and content are not under the control of HONDA. HONDA is not responsible or liable, directly or indirectly, for such third-party websites and their content or for any damage relating to or resulting from your access or use of such websites and content.

**5. Unauthorized Use and Abuse.** You are responsible for ensuring your (and any authorized third parties') use of the SOFTWARE and SERVICES remains in compliance with this AGREEMENT and all other applicable HONDA TERMS and PROVIDER TERMS. You acknowledge and agree that any use of the SOFTWARE or SERVICES occurring through your VEHICLE will be deemed your actions and that HONDA and PROVIDERS may rely upon such actions. You agree to immediately notify us if you suspect fraudulent or abusive activity involving the SOFTWARE or SERVICES. If you so notify us or if we otherwise suspect fraudulent or abusive activity, you agree to cooperate with us in any fraud investigation and to use any fraud prevention measures we prescribe. Your failure to immediately notify us or cooperate to use such measures will result in your liability for all fraudulent usage or abusive activity associated with your VEHICLE.

**6. SOFTWARE Updates.** The SOFTWARE and SERVICES may be updated when your VEHICLE is serviced by a DEALER or remotely, over-the-air, by HONDA from time to time; such updates may occur with or without further notice or your future consent. The SOFTWARE may be updated at HONDA's discretion and for any purpose including, without limitation, to patch or otherwise improve the SOFTWARE or SERVICES functionality, security, or stability. All updates to the SOFTWARE and SERVICES are subject to this AGREEMENT and any other applicable HONDA TERMS and PROVIDER TERMS.

**7. Uninstalling, Removing, and Replacing the SOFTWARE.** Replacing SOFTWARE or HONDA SERVICES with software or firmware not provided and installed by HONDA or a DEALER will render all representations and warranties for the SOFTWARE, HONDA SERVICES, and VEHICLE functionality reliant upon the SOFTWARE or HONDA SERVICES null and void.

#### **D. SOFTWARE Operational Notices and Warnings**

**1. Vehicle Geolocation Information.** You acknowledge that your VEHICLE may be equipped with certain traffic and map features. The traffic feature will automatically collect and transmit, through GPS technology, your Vehicle's current location (longitude and latitude), travel direction and speed ("VEHICLE GEOLOCATION INFORMATION") to HONDA and PROVIDERS. The VEHICLE GEOLOCATION INFORMATION is used by HONDA and PROVIDERS to provide traffic and navigation-related information to you, but may also be used to provide other SERVICES or offers to you. HONDA will not use such VEHICLE GEOLOCATION INFORMATION for its own marketing efforts, or provide such information to unaffiliated third parties for their own purposes, without your express consent.

**2. Potential Map Inaccuracy and Route Safety.** Maps used by this system may be inaccurate because of changes in roads, traffic controls, routing, or driving conditions. Always use good judgment and common sense when following suggested routes. Do not follow the route suggestions if doing so would result in an unsafe or illegal driving maneuver, if you would be placed in an unsafe situation, or if you would be directed into an area that you consider unsafe. Do not rely on any navigation features included in the system to route you to emergency services. Not all emergency services such as police, fire stations, hospitals, or clinics are likely to be contained in the map database for such navigation features. Ask local authorities or an emergency services operator for such locations and routes. The driver is ultimately responsible for the safe operation of the vehicle and therefore, must evaluate whether it is safe to follow the suggested directions. Any navigation features are provided only as an aid. Make your driving decisions based on your observations of local conditions and existing traffic regulations. Navigation features are not a substitute for your personal judgment. Any route suggestions made by the SOFTWARE or SERVICES should never replace any local traffic regulations or your personal judgment or knowledge of safe driving practices.

**3. Speech Recognition:** You acknowledge and understand that HONDA and PROVIDERS may record, retain, and use voices commands when you use the speech recognition components of the SOFTWARE or SERVICES. You and all VEHICLE operators and passengers (a) consent to the recording and retention of voice commands in support of providing speech recognition components and (b) release HONDA and PROVIDERS from all claims, liabilities, and losses that may result from any use of such recorded voice commands. Recognition errors are inherent in speech recognition. It is your responsibility to monitor any speech recognition functions included in the system and address any errors. Neither HONDA nor PROVIDERS will be liable for any damages arising out of errors in the speech recognition process.

**4. Distraction Hazards.** Navigation features may require manual (non-verbal) input or setup. Attempting to perform such set-up or insert data while driving can seriously distract your attention and could cause a crash or other serious consequences; the ability to undertake such interactions may also be limited by state or local law, which laws you are responsible to know and follow. Even occasional short scans of the screen may be hazardous if your attention has been diverted away from your driving at a critical time. Pull over and stop the vehicle in a safe and legal manner before attempting to access a function of the system requiring prolonged attention. Do not raise the volume excessively. Keep the volume at a level where you can still hear outside traffic and emergency signals while driving. Driving while unable to hear these sounds could result in a crash.

## E. Information Collection and Storage

**1. Information Collection, Use, Transmission and Storage of Data. Consent to Use of Data:** You agree that HONDA and PROVIDERS may collect and use your information gathered in any manner as part of product support services related to the SOFTWARE or related services. HONDA may share such information with third parties, including, without limitation, PROVIDERS, third party software and services suppliers, their affiliates and/or their designated agents, solely to improve their products or to provide services or technologies to you. HONDA, third party software and systems suppliers, their affiliates and/or their designated agent may disclose this information to others, but not in a form that personally identifies you.

**2. Information Storage.** Depending on the type of multimedia system you have in your VEHICLE, certain information may be stored for ease of use of the SOFTWARE including, without limitation, search history, location history in certain applications, previous and saved destinations, map locations within certain applications, and device numbers and contact information.

(a) **Vehicle Health Information.** Your VEHICLE may remotely transmit information regarding the status and health of your VEHICLE (“VEHICLE INFORMATION”) to HONDA without notification to you. VEHICLE INFORMATION may contain VEHICLE maintenance and malfunction status that is derived from VEHICLE diagnostic data and includes, but is not limited to, status of powered doors and windows, battery life data, battery charging data, VEHICLE speed, coolant temperature, air compressor revolution, output power, warning codes, diagnostic trouble codes, fuel injection volume, and engine rotations per minute. VEHICLE HEALTH INFORMATION may be used by HONDA for research and development, to deliver HONDA SERVICES and information to you, and to contact you, and is retained only for a period of time necessary to fulfill these goals.

(b) **VEHICLE Geolocation Data (non-navigation/map based).** If you opt-in to geolocation-based SERVICES, your vehicle’s geolocation data (latitude and longitude) will be automatically sent from your VEHICLE to HONDA and PROVIDERS.

(c) You understand that the inputting or uploading of information to your VEHICLE’s multimedia system or the SOFTWARE or SERVICES is at your own risk and that HONDA is not responsible for unauthorized access to or use of any personal or other information. All information uploaded to the SOFTWARE and SERVICES may be stored on your VEHICLES’s multimedia system and you understand that the security and safety of your VEHICLE’s multimedia system is your sole responsibility.

**F. NO WARRANTY.** You understand and agree that your use of the SOFTWARE and SERVICES are solely at your own risk and that you will be solely responsible for any damage to your VEHICLE's multimedia system or any other equipment or any loss of data that may result from your use of the SOFTWARE or SERVICES. THE SOFTWARE AND SERVICES ARE PROVIDED ON AN "AS IS" AND "AS AVAILABLE" BASIS WITHOUT ANY WARRANTY OF ANY KIND, EXPRESSED, IMPLIED OR STATUTORY. WE SPECIFICALLY DISCLAIM ANY IMPLIED WARRANTIES OF MERCHANTABILITY, FITNESS FOR A PARTICULAR PURPOSE, AND NON-INFRINGEMENT. HONDA makes no warranties that the SOFTWARE or SERVICES will meet your requirements, or that the SOFTWARE or SERVICES will be uninterrupted, timely, secure, non-infringing or error free. You understand and agree that you are responsible for any and all charges, costs or expenses associated with your use of the SOFTWARE or SERVICES. Advice or information, whether oral or written, obtained by you from us or through the SOFTWARE or SERVICES are provided for informational purposes only and will not create any warranty not expressly made herein. You should not rely on any such information or advice. We assume no liability or responsibility for any errors or omissions in the SOFTWARE or SERVICES. We do not make any warranty or representation that your use of the material displayed on, or obtained through, the SOFTWARE or SERVICES is non-infringing of any rights of any third party. Any decision or action taken by you on the basis of information or content provided via the application is at your sole discretion and risk. HONDA and PROVIDERS are not responsible or liable for any such decision, or for the accuracy, completeness, usefulness, or availability of any content or information displayed, transmitted, or otherwise made available via the SOFTWARE or SERVICES. To the extent jurisdictions do not allow the exclusion of certain warranties, some of the above exclusions may not apply to you.

**G. LIMITATIONS ON LIABILITY.** You and HONDA are each waiving important rights

**1. Limitations on YOUR liability.** HONDA cannot recover from you any consequential, indirect, incidental, or special damages, or attorney's fees in connection with your use of the SOFTWARE or HONDA SERVICES. HONDA WAIVES TO THE FULLEST EXTENT ALLOWED BY LAW ANY CLAIM FOR DAMAGES OTHER THAN DIRECT, COMPENSATORY DAMAGES AS LIMITED IN THIS AGREEMENT.



**2. Limitation on HONDA and PROVIDER liability.** Neither HONDA nor PROVIDERS will be liable to you or any other party for consequential, indirect, incidental, special, or punitive damages (including without limitation lost profits) in connection with your use of the SOFTWARE or SERVICES, even if HONDA or PROVIDERS are aware of the possibility of such damages. These limitations apply to all claims, including, without limitation, claims in contract and tort (such as negligence, product liability and strict liability). To the extent that a jurisdiction does not permit the exclusion or limitation of liability as set forth herein our liability is limited to the maximum extent permitted by law in such states. If HONDA or PROVIDERS are found liable to you for any reason, you agree that the aggregate liability of all these parties to you for any claim is limited to ten U.S. dollars (US \$10.00). Neither HONDA nor any PROVIDER would have agreed to provide the SOFTWARE or SERVICES to you if you did not agree to this limitation. This amount is the sole and exclusive liability of HONDA and PROVIDERS to you, and is payable as liquidated damages and not as a penalty. Except where prohibited by law, you may not bring any claim against HONDA or any third-party beneficiary more than two (2) years after the claim arises. We do not have any liability for SOFTWARE or SERVICES interruptions of any length.

(a) Release of HONDA and PROVIDERS For yourself and anyone else claiming under you, you agree to release and discharge HONDA, PROVIDERS, their respective officers, directors, and employees, and each third-party beneficiary from all claims, liabilities and losses in connection with the SOFTWARE or SERVICES, including, but not limited to claims for personal injury or property damage arising from the total or partial failure of performance of the SOFTWARE or SERVICES, even if caused by or based upon the negligence, gross negligence, strict products liability, Deceptive Trade Practices Act violations, bad faith, or breach of warranty of us or the malfunction of the SOFTWARE or SOFTWARE SERVICES. YOU AGREE TO WAIVE TO THE FULLEST EXTENT ALLOWED BY LAW, ANY CLAIM FOR DAMAGES OTHER THAN DIRECT, COMPENSATORY DAMAGES AS LIMITED IN THIS AGREEMENT. YOU HEREBY RELEASE AND DISCHARGE HONDA AND ITS LICENSORS AND CONTRACTORS (INCLUDING ANY THIRD PARTIES PROVIDING ALL OR PART OF THE SOFTWARE OR SERVICES) FROM AND AGAINST ANY CLAIMS, DAMAGES, EXPENSES AND LIABILITY ARISING FROM OR RELATED TO ANY INJURIES, DAMAGES, OR LOSSES TO ANY PERSON (INCLUDING DEATH) OR PROPERTY OF ANY KIND RESULTING IN WHOLE OR PART, DIRECTLY OR INDIRECTLY, FROM YOUR USE OF THE SOFTWARE OR SERVICES.

**H. Survival.** You agree that the limitations of liability and indemnities in this AGREEMENT will survive even after the AGREEMENT has ended. These limitations of liability apply not only to you, but to anyone using the SOFTWARE or SERVICES via your VEHICLE, to anyone making a claim on your behalf, and to any claims made by your family, employees, customers, or others arising out of or relating to your VEHICLE, the SOFTWARE, or SERVICES.

**I. Availability/Interruption.** The SOFTWARE and certain SERVICES are made available through your VEHICLE's compatible multimedia system when the VEHICLE is turned on. Certain SERVICES may be available only through your compatible mobile device when it is within the operating range of the VEHICLE and a wireless carrier. The availability of the SOFTWARE and SERVICES may be subject to transmission limitation or interruption, including but not limited to technical obsolescence or sunset of the hardware, software or firmware, inside of or external to the Vehicle, required for data transmission or receipt. HONDA does not guarantee that the SOFTWARE, SERVICES, or any portion thereof will be available at all times or in all areas. You acknowledge and agree that HONDA is not responsible for performance degradation, interruption or delays. You acknowledge that HONDA shall not be liable to you if the SOFTWARE or SERVICES in a given location are not available. If the SOFTWARE or SERVICES are not available within your intended location, you agree that your sole remedy shall be to cease using the SOFTWARE and SERVICES.

**J. PRODUCT SUPPORT:** Product support for the SOFTWARE is provided by HONDA. For product support, please refer to HONDA instructions provided in the DOCUMENTATION. Should you have any questions concerning this AGREEMENT, or if you desire to contact HONDA for any other reason, please refer to the HONDA contact information provided in the DOCUMENTATION.

#### **K. Termination and Transfer.**

**1. Termination.** This AGREEMENT is effective until terminated by you or US. WE may terminate this AGREEMENT for any or no reason, and with or without notice to you. Your rights under this AGREEMENT will terminate automatically without notice from US if you fail to comply with any term of this AGREEMENT. Upon termination of this AGREEMENT, you shall cease all use of the SOFTWARE and SERVICES.

**2. Transfer:** You may permanently transfer your rights under this AGREEMENT only as part of a sale or transfer of the VEHICLE, provided you retain no copies, you transfer all of the SOFTWARE and HONDA SERVICES (including all component parts, the media and printed materials, and any upgrades), and the recipient agrees to the terms of this AGREEMENT. You agree to notify HONDA upon the sale or transfer of the VEHICLE. To contact HONDA, please refer to the HONDA contact information provided in the DOCUMENTATION.

**L. Changes to the SOFTWARE or SERVICES.** WE may change, modify, or update the SOFTWARE or SERVICES from time to time. Unless explicitly stated otherwise, any new features or services that augment or enhance the SOFTWARE or SERVICES in the future shall respectively be considered part of the SOFTWARE or SERVICES and subject to this AGREEMENT. WE reserve the right at any time and from time to time to interrupt, restrict, modify, suspend, discontinue, temporarily or permanently, the SOFTWARE or SERVICES (or any portion thereof), with or without notice to you, and you agree that HONDA shall not be liable to you or to any third party for any modification, suspension or discontinuance of the SOFTWARE or SERVICES.

**M. ARBITRATION:**

PLEASE READ THIS ARBITRATION PROVISION CAREFULLY TO UNDERSTAND YOUR RIGHTS. YOU AGREE THAT ANY CLAIM THAT YOU MAY HAVE IN THE FUTURE MUST BE RESOLVED THROUGH BINDING ARBITRATION. YOU WAIVE THE RIGHT TO HAVE YOUR DISPUTE HEARD IN COURT AND WAIVE THE RIGHT TO BRING CLASS CLAIMS. YOU UNDERSTAND THAT DISCOVERY AND APPEAL RIGHTS ARE MORE LIMITED IN ARBITRATION.

Arbitration is a method of resolving a claim, dispute or controversy without filing a lawsuit. By agreeing to arbitrate, the right to go to court is waived and instead claims, disputes or controversies are submitted to binding arbitration. This provision sets forth the terms and conditions of our agreement. YOU and HONDA agree and acknowledge that this Agreement affects interstate commerce and the Federal Arbitration Act ("FAA") applies. By using the Software, Vehicle, or Services, YOU elect to have disputes resolved by arbitration. YOU, HONDA or any involved third party may pursue a Claim. "Claim" means any dispute between YOU, HONDA, or any involved third party relating to your use of the Software, the Vehicle, or the Services, this Agreement, or our relationship, including any representations, omissions or warranties. "Claim" does not include personal injury or wrongful death claims.

YOU or HONDA may seek remedies in small claims court or provisional judicial remedies without arbitrating. In addition, notwithstanding anything herein to the contrary, YOU or HONDA may seek equitable relief in a court of competent jurisdiction. YOU or HONDA may select arbitration with American Arbitration Association, JAMS or National Arbitration and Mediation. Contact these sponsors for their rules. The hearing will be in the federal district where YOU reside. If agreed, it may be by telephone or written submissions. Filing and arbitrator fees to be paid per the sponsor rules. You may contact the sponsor for a fee waiver. If no fee waivers, HONDA will pay filing and arbitrator fees up to \$5,000, unless law requires more. Each party is responsible for other fees. Arbitrator may award costs or fees to prevailing party, if permitted by law. HONDA will not seek fees, unless the claims are frivolous.

Arbitrator shall be an attorney or current or retired judge familiar with automotive or consumer software. The arbitrator shall follow substantive law, statute of limitations and decide all issues relating to the interpretation, construction, enforceability and applicability of this provision. The arbitrator may order relief permitted by law. This provision is governed and enforceable by the FAA. An award shall include a written opinion and be final, subject to appeal by the FAA.

This provision survives termination of this Agreement or relationship, bankruptcy, assignment or transfer. If part of this provision is unenforceable, the remainder remains in effect. If unenforceability allows arbitration as a class action, then this provision is entirely unenforceable. YOU may opt out within 30 days of your initial use of the Software by sending a signed, written notice to HONDA at Honda Financial Services, P.O. Box 165007, Irving, TX 75016. HONDA reserves the right to make changes to this provision after providing written notice and an opportunity to opt out.

**N. Miscellaneous:** You may not assign this AGREEMENT without HONDA's prior written consent. This AGREEMENT and any additional HONDA TERMS and PROVIDER TERMS represents the entire agreement between you and US. HONDA may amend the terms of this AGREEMENT by providing you with notices of such updated terms. If you do not consent to be bound by the updated terms, your sole remedy will be to cease using the SOFTWARE and SERVICES. If any part of this AGREEMENT is found invalid, void, or unenforceable, the balance of the AGREEMENT will remain valid and enforceable according to its terms. To the fullest extent permitted by law, and except as explicitly provided otherwise, this AGREEMENT and any disputes arising out of or relating to it will be governed by the laws of the State of California, except that California laws concerning choice of law or conflicts shall not apply if they would cause the substantive law of another jurisdiction to apply. Notwithstanding the foregoing, Section M shall be governed by the Federal Arbitration Act and the laws of the State of California, as applicable, as set forth therein. The failure to enforce any term of this AGREEMENT on one occasion shall not prevent enforcement on any other occasion or the enforcement of any other term. Headings and captions shall not be considered included for purposes of interpretation or application hereof, but are for convenience only.

## Models with Display Audio

## Legal Information on Apple CarPlay™/Android Auto™

### OWNER'S MANUAL LICENSE/LIABILITY STATEMENTS

USE OF APPLE CARPLAY IS SUBJECT TO YOUR AGREEMENT TO THE CARPLAY TERMS OF USE, WHICH ARE INCLUDED AS PART OF THE APPLE iOS TERMS OF USE. IN SUMMARY, THE CARPLAY TERMS OF USE DISCLAIM APPLE AND ITS SERVICE PROVIDERS' LIABILITY IF THE SERVICES FAIL TO PERFORM CORRECTLY OR ARE DISCONTINUED, STRICTLY LIMIT APPLE AND ITS SERVICE PROVIDERS' OTHER LIABILITIES, DESCRIBE THE KINDS OF USER INFORMATION (INCLUDING, FOR EXAMPLE, VEHICLE LOCATION, VEHICLE SPEED, AND VEHICLE STATUS) BEING GATHERED AND STORED BY APPLE AND ITS SERVICE PROVIDERS, AND DISCLOSE CERTAIN POSSIBLE RISKS ASSOCIATED WITH THE USE OF CARPLAY, INCLUDING THE POTENTIAL FOR DRIVER DISTRACTION. SEE APPLE'S PRIVACY POLICY FOR DETAILS REGARDING APPLE'S USE AND HANDLING OF DATA UPLOADED BY CARPLAY.

USE OF ANDROID AUTO IS SUBJECT TO YOUR AGREEMENT TO THE ANDROID AUTO TERMS OF USE WHICH MUST BE AGREED TO WHEN THE ANDROID AUTO APPLICATION IS DOWNLOADED TO YOUR ANDROID PHONE. IN SUMMARY, THE ANDROID AUTO TERMS OF USE DISCLAIM GOOGLE AND ITS SERVICE PROVIDERS' LIABILITY IF THE SERVICES FAIL TO PERFORM CORRECTLY OR ARE DISCONTINUED, STRICTLY LIMIT GOOGLE AND ITS SERVICE PROVIDERS' OTHER LIABILITIES, DESCRIBE THE KINDS OF USER INFORMATION (INCLUDING, FOR EXAMPLE, VEHICLE LOCATION, VEHICLE SPEED, AND VEHICLE STATUS) BEING GATHERED AND STORED BY GOOGLE AND ITS SERVICE PROVIDERS, AND DISCLOSE CERTAIN POSSIBLE RISKS ASSOCIATED WITH THE USE OF ANDROID AUTO, INCLUDING THE POTENTIAL FOR DRIVER DISTRACTION. SEE GOOGLE'S PRIVACY POLICY FOR DETAILS REGARDING GOOGLE'S USE AND HANDLING OF DATA UPLOADED BY ANDROID AUTO.

## DISCLAIMER OF WARRANTIES; LIMITATION ON LIABILITY

YOU EXPRESSLY ACKNOWLEDGE AND AGREE THAT USE OF APPLE CARPLAY OR ANDROID AUTO (“THE APPLICATIONS”) IS AT YOUR SOLE RISK AND THAT THE ENTIRE RISK AS TO SATISFACTORY QUALITY, PERFORMANCE, ACCURACY AND EFFORT IS WITH YOU TO THE MAXIMUM EXTENT PERMITTED BY APPLICABLE LAW, AND THAT THE APPLICATIONS AND INFORMATION ON THE APPLICATIONS IS PROVIDED “AS IS” AND “AS AVAILABLE,” WITH ALL FAULTS AND WITHOUT WARRANTY OF ANY KIND, AND HONDA HEREBY DISCLAIMS ALL WARRANTIES AND CONDITIONS WITH RESPECT TO THE APPLICATIONS AND INFORMATION ON THE APPLICATIONS, EITHER EXPRESS, IMPLIED OR STATUTORY, INCLUDING, BUT NOT LIMITED TO, THE IMPLIED WARRANTIES AND/OR CONDITIONS OF MERCHANTABILITY, SATISFACTORY QUALITY, FITNESS FOR A PARTICULAR PURPOSE, ACCURACY, QUIET ENJOYMENT, AND NON-INFRINGEMENT OF THIRD PARTY RIGHTS. NO ORAL OR WRITTEN INFORMATION OR ADVICE GIVEN BY HONDA OR AN AUTHORIZED REPRESENTATIVE SHALL CREATE A WARRANTY. AS EXAMPLES, AND WITHOUT LIMITATION, HONDA DISCLAIMS ANY WARRANTY REGARDING THE ACCURACY OF DATA PROVIDED BY THE APPLICATIONS, SUCH AS THE ACCURACY OF DIRECTIONS, ESTIMATED TRAVEL TIME, SPEED LIMITS, ROAD CONDITIONS, NEWS, WEATHER, TRAFFIC, OR OTHER CONTENT PROVIDED BY APPLE, GOOGLE, THEIR AFFILIATES, OR THIRD PARTY PROVIDERS; HONDA DOES NOT GUARANTEE AGAINST LOSS OF APPLICATION DATA, WHICH MAY BE LOST AT ANY TIME; HONDA DOES NOT GUARANTEE THAT THE APPLICATIONS OR ANY SERVICES PROVIDED THROUGH THEM WILL BE PROVIDED AT ALL TIMES OR THAT ANY OR ALL SERVICES WILL BE AVAILABLE AT ANY PARTICULAR TIME OR LOCATION. FOR EXAMPLE, SERVICES MAY BE SUSPENDED OR INTERRUPTED WITHOUT NOTICE FOR REPAIR, MAINTENANCE, SECURITY FIXES, UPDATES, ETC., SERVICES MAY BE UNAVAILABLE IN YOUR AREA OR LOCATION, ETC. IN ADDITION, YOU UNDERSTAND THAT CHANGES IN THIRD PARTY TECHNOLOGY OR GOVERNMENT REGULATION MAY RENDER THE SERVICES AND/OR APPLICATIONS OBSOLETE AND/OR UNUSABLE.

TO THE EXTENT NOT PROHIBITED BY LAW, IN NO EVENT SHALL HONDA OR ITS AFFILIATES BE LIABLE FOR PERSONAL INJURY, OR ANY INCIDENTAL, SPECIAL, INDIRECT OR CONSEQUENTIAL DAMAGES WHATSOEVER, INCLUDING, WITHOUT LIMITATION, DAMAGES FOR LOSS OF PROFITS, CORRUPTION OR LOSS OF DATA, FAILURE TO TRANSMIT OR RECEIVE ANY DATA, BUSINESS INTERRUPTION OR ANY OTHER COMMERCIAL DAMAGES OR LOSSES, ARISING OUT OF OR RELATED TO THE APPLICATIONS OR YOUR USE OF OR INABILITY TO USE THE APPLICATIONS OR INFORMATION ON THE APPLICATIONS, HOWEVER CAUSED, REGARDLESS OF THE THEORY OF LIABILITY (CONTRACT, TORT OR OTHERWISE) AND EVEN IF HONDA WERE ADVISED OF THE POSSIBILITY OF SUCH DAMAGES. SOME STATES AND JURISDICTIONS DISALLOW THE EXCLUSION OR LIMITATION OF LIABILITY FOR DAMAGES, SO THESE LIMITATIONS AND EXCLUSIONS MAY NOT APPLY TO YOU. IN NO EVENT SHALL HONDA’S TOTAL LIABILITY TO YOU FOR ALL DAMAGES (OTHER THAN AS MAY BE REQUIRED BY APPLICABLE LAW IN CASES INVOLVING PERSONAL INJURY) EXCEED THE AMOUNT OF FIVE DOLLARS (\$5.00). THE FOREGOING LIMITATIONS WILL APPLY EVEN IF THE ABOVE STATED REMEDY FAILS OF ITS ESSENTIAL PURPOSE.

## About Open Source Licenses

To see the open source license information, follow these steps.

1. Select .
2. Select **Settings**.
3. Select **System**.
4. Select the **Others** tab.
5. Select **Detail Info**.
6. Select **About device**.
7. Select **Legal information**.
8. Select **Open source licenses**.

### ▣ About Open Source Licenses

LICENCE: Copyright © 2001 Bob Trower, Trantor Standard Systems Inc.



Permission is hereby granted, free of charge, to any person obtaining a copy of this software and associated documentation files (the "Software"), to deal in the Software without restriction, including without limitation the rights to use, copy, modify, merge, publish, distribute, sublicense, and/or sell copies of the Software, and to permit persons to whom the Software is furnished to do so, subject to the following conditions:

The above copyright notice and this permission notice shall be included in all copies or substantial portions of the Software.

THE SOFTWARE IS PROVIDED "AS IS", WITHOUT WARRANTY OF ANY KIND, EXPRESS OR IMPLIED, INCLUDING BUT NOT LIMITED TO THE WARRANTIES OF MERCHANTABILITY, FITNESS FOR A PARTICULAR PURPOSE AND NONINFRINGEMENT. IN NO EVENT SHALL THE AUTHORS OR COPYRIGHT HOLDERS BE LIABLE FOR ANY CLAIM, DAMAGES OR OTHER LIABILITY, WHETHER IN AN ACTION OF CONTRACT, TORT OR OTHERWISE, ARISING FROM, OUT OF OR IN CONNECTION WITH THE SOFTWARE OR THE USE OR OTHER DEALINGS IN THE SOFTWARE.

## CD Player\*

If a disc error occurs, you may see the following error messages.

Error Message	Cause	Solution
<b>UNPLAYABLE FILE</b>	Track/file format not supported	<ul style="list-style-type: none"> <li>• Current track/file will be skipped. The next supported track/file plays automatically.</li> </ul>
<b>BAD DISC PLEASE CHECK OWNERS MANUAL PUSH EJECT</b>	Mechanical error	<ul style="list-style-type: none"> <li>• Press the  (eject) button and remove the disc, and check that the error message is cleared.</li> <li>• Check that the disc is not damaged or deformed, and insert the disc again.                             <ul style="list-style-type: none"> <li>➤ <b>Protecting CDs</b> P. 319</li> </ul> </li> </ul>
<b>MECHA ERROR</b>		
<b>BAD DISC PLEASE CHECK OWNERS MANUAL</b>	Servo error	<ul style="list-style-type: none"> <li>• If the error message reappears, press the  button, and pull out the disc.</li> <li>• Insert a different disc. If the new disc plays, there is a problem with the first disc.</li> <li>• If the error message repeats, or the disc cannot be removed, contact a dealer. Do not try to force the disc out of the player.</li> </ul>
<b>CHECK DISC</b>	Disc error	<ul style="list-style-type: none"> <li>• Check that the disc is not damaged or deformed.                             <ul style="list-style-type: none"> <li>➤ <b>Protecting CDs</b> P. 319</li> </ul> </li> </ul>
<b>HEAT ERROR</b>	High temperature	<ul style="list-style-type: none"> <li>• Turn the audio system off and allow the player to cool down until the error message is cleared.</li> </ul>



## iPod/USB Flash Drive

If an error occurs while playing an iPod or USB flash drive, you may see the following error messages. If you cannot clear the error message, contact a dealer.

Error Message	Solution
<b>USB Error</b> <sup>*1</sup>	Appears when there is a problem with the USB adapter unit. Check if the device is compatible with the USB adapter unit.
<b>Incompatible USB device.</b> See Owner's Manual for details <sup>*1</sup> <b>BAD USB DEVICE</b> <b>PLEASE CHECK OWNERS MANUAL</b> <sup>*2</sup>	Appears when an incompatible device is connected. Disconnect the device. Then turn the audio system off, and turn it on again. Do not reconnect the device that caused the error.
<b>Unsupported Version</b> <sup>*1</sup> <b>UNSUPPORTED VER.</b> <sup>*2</sup>	Appears when an unsupported iPod is connected. If it appears when a supported iPod is connected, update the iPod software to the newer version.
<b>Connect Retry</b> <sup>*1, *2</sup>	Appears when the system does not acknowledge the iPod. Reconnect the iPod.
<b>Unplayable File</b> <sup>*1, *2</sup>	Appears when the files in the USB flash drive are DRM or an unsupported format. This error message appears for about 3 seconds, then plays the next song.
<b>No Data</b> <sup>*1</sup> <b>NO SONG</b> <sup>*2</sup>	<b>iPod</b> Appears when the iPod is empty.
	<b>USB flash drive</b> Appears when the USB flash drive is empty or there are no MP3, WMA, or AAC files in the USB flash drive.
	<b>iPod and USB flash drive</b> Check that compatible files are stored on the device.
<b>Unsupported</b> <sup>*1, *2</sup>	Appears when an unsupported device is connected. If it appears when a supported device is connected, reconnect the device.

\*1: Display audio system

\*2: Color audio system

The error message is displayed in capitals.

U.S. models

Models with display audio system

## Pandora®

If an error occurs while playing Pandora®, you may see the following error messages.

If you cannot clear the error message, contact a dealer.





Error Message	Solution
<b>To begin listening, select a station from the Stations list.</b>	
<b>Unable to rate this track. Please try again. You've reached your skip limit.</b>	<ul style="list-style-type: none"> <li>• Appears when there is no station list on the device. Use the device to create a station.</li> </ul>
<b>The maximum number of stations has been created. To create more, please delete one or more previously created stations.</b>	<ul style="list-style-type: none"> <li>• Appears when the number of stations that can be created is exceeded. Follow the message.</li> </ul>
<b>Unable to create new station. Please try again.</b>	
<b>Unable to play Pandora. Please try again later.</b>	<ul style="list-style-type: none"> <li>• Appears when the commanded operation is failed. Try again later.</li> </ul>
<b>Unable to save bookmark.</b>	
<b>This Pandora station is currently not available. Please select another station.</b>	<ul style="list-style-type: none"> <li>• Appears when the station you selected is not available. Change a station, or try again later.</li> </ul>
<b>Unable to play Pandora. When stopped, log-in to Pandora.</b>	<ul style="list-style-type: none"> <li>• Appears when you have not logged into Pandora®. Follow the message.</li> </ul>

Error Message	Solution
<b>Unable to connect to Pandora. When stopped, check your mobile phone.</b>	<ul style="list-style-type: none"> <li>• Appears when failed to connect. Check your device and try again.</li> </ul>
<b>There is no internet connectivity on the phone.</b>	
<b>Unable to play Pandora. Please try again later.</b>	
<b>Connect Retry</b>	<ul style="list-style-type: none"> <li>• Appears when you travel outside the Pandora® service coverage areas. Pandora® can only be played in U.S. and will not work in other countries.</li> </ul>
<b>Unable to play Pandora in this country.</b>	
<b>Unsupported</b>	<ul style="list-style-type: none"> <li>• Appears when the device is not supported. Use another device.</li> </ul>
<b>Unsupported Version</b>	<ul style="list-style-type: none"> <li>• Appears when Pandora® version is not supported. Update Pandora® to the latest version.</li> </ul>
<b>Pandora app version is unsupported. When stopped, please update the app.</b>	
<b>Please make sure the phone's Bluetooth setting is ON and try again.</b>	<ul style="list-style-type: none"> <li>• Appears when Pandora® is unable to play music. Check the Bluetooth status on your device.</li> </ul>
<b>No Data</b>	<ul style="list-style-type: none"> <li>• Appears when no data is available with Pandora® activated. Reboot the app and reconnect the device.</li> </ul>
<b>Incompatible USB device. See Owner's Manual for details</b>	<ul style="list-style-type: none"> <li>• Appears when an incompatible device is connected. Disconnect the device. Then turn the audio system off, and turn it again. Do not reconnect the device that caused the error.</li> </ul>

Models with display audio system

## Android/Apps

If an error occurs while using the audio system or apps, you may see the following error messages. If you cannot clear the error message, contact a dealer.

Error Message*1	Solution
Unfortunately, **** has stopped.	<p>Error has occurred within app, select <b>OK</b> on the screen to close the app. Unless it is a fatal error, it would return to normal if you startup the app.</p> <p>If it does not return to normal even after starting up the app, press and hold the  (power) button to perform the forced reset. If it still does not get back to normal, you need <b>Factory Data Reset</b>.</p> <p> <b>Defaulting All the Settings</b> P. 342</p>
**** is not responding. Would you like to close it?	<p>App is in a busy state.</p> <p>Select <b>Wait</b> if you can wait for a response from app a little longer. If it does not respond even if you keep waiting, select <b>OK</b> to close the app and start it up. When it does not return to normal, press and hold the  (power) button to perform the forced reset. You also need <b>Factory Data Reset</b>.</p> <p> <b>Defaulting All the Settings</b> P. 342</p>

\*1: \*\*\*\*part is variable characters, and will change depending upon where an error occurs.

## SiriusXM® Radio Service

### ■ Subscribing to SiriusXM® Radio

1. You need your radio ID ready before registering for subscription. To see the ID in the display: Select **Channel 000**.
2. Have your radio ID and credit card number ready, and either call or visit the SiriusXM® website to subscribe.

### ■ Receiving SiriusXM® Radio

Switch to the SiriusXM® mode by using the **SOURCE** button on the steering wheel, or through the audio/informations screen, and stay in this mode for about 30 minutes until the service is activated. Make sure your vehicle is in an open area with good reception.

### ■ SiriusXM® Radio Display Messages

#### **Check antenna:**

The SiriusXM® antenna is disconnected or shorted. Contact a dealer.

#### **No Signal:**

The signal is too weak in the current location.

#### **Channel Not Subscribed:**

You are not subscribed to the channel selected.

#### **Subscription Updated:**

SiriusXM® radio is receiving information update from the network.

#### **Replay Memory Almost Full:**

The Recording memory is nearly full.

#### **Replay Memory Full:**

The recording memory is full.

### ☒ Subscribing to SiriusXM® Radio

Contact Information for SiriusXM® Radio:

- U.S.: SiriusXM® Radio at [www.siriusxm.com/subscribe-now](http://www.siriusxm.com/subscribe-now) or 1-877-447-0011
- Canada: SiriusXM® Canada at [www.siriusxm.ca/subscribe-now](http://www.siriusxm.ca/subscribe-now), or 1-877-209-0079

### ☒ Receiving SiriusXM® Radio

The SiriusXM® satellites are in orbit over the equator; therefore, objects south of the vehicle may cause satellite reception interruptions. Satellite signals are more likely to be blocked by tall buildings and mountains the farther north you travel from the equator.

You may experience reception problems under the following circumstances:

- In a location with an obstruction to the south of your vehicle.
- In tunnels
- On the lower level of a multi-tiered road
- Large items carried on the roof rack

## Recommended CDs\*

- Use only high-quality CD-R or CD-RW discs labeled for audio use.
- Use only CD-R or CD-RW discs on which the recordings are closed.
- Play only standard round-shaped CDs.

The CD packages or jackets should have one of these marks.



### CDs with MP3, WMA, or AAC files

- Some software files may not allow for audio play or text data display.
- Some versions of MP3, WMA, or AAC formats may be unsupported.

### ▶▶ Recommended CDs\*

A Dual-disc cannot play on this audio unit. If recorded under certain conditions, a CD-R or CD-RW may not play either.

## ■ Protecting CDs

Follow these precautions when handling or storing CDs:

- Store a CD in its case when it is not being played.
- When wiping a CD, use a soft clean cloth from the center to the outside edge.
- Handle a CD by its edge. Never touch either surface.
- Never insert foreign objects into the CD player.
- Keep CDs out of direct sunlight and extreme heat.
- Do not place stabilizer rings or labels on the CD.
- Avoid fingerprints, liquids, and felt-tip pens on the CD.

### ▶▶ Protecting CDs

#### NOTICE

Do not insert a damaged CD. It may be stuck inside and damage the audio unit.

#### Examples:

- Bubbled, wrinkled, labeled, and excessively thick CDs



Bubbled/  
Wrinkled



With Label/  
Sticker



Using  
Printer Label  
Kit



Sealed



With Plastic Ring

- Damaged CDs



Chipped/  
Cracked



Warped

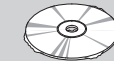

Burrs

- Poor quality CDs

- Small CDs



3-inch (8-cm)  
CD

## Compatible iPod, iPhone, and USB Flash Drives

### ■ iPod and iPhone Model Compatibility

Model
iPod (5th generation)
iPod classic 80GB/160GB (launch in 2007)
iPod classic 120GB (launch in 2008)
iPod classic 160GB (launch in 2009)
iPod nano (1st to 7th generation) released between 2005 and 2012
iPod touch (1st to 5th generation) released between 2005 and 2012
iPhone 3G/iPhone 3GS/iPhone 4/iPhone 4s/iPhone 5/iPhone 5s* <sup>1</sup> / iPhone 5c* <sup>1</sup> /iPhone 6* <sup>1</sup> /iPhone 6 plus* <sup>1</sup> /iPhone 6s* <sup>1</sup> /iPhone 6s plus* <sup>1</sup>

\* 1 : Display audio system

### ■ USB Flash Drives

- A USB flash drive of 256 MB or higher is recommended.
- Some digital audio players may not be compatible.
- Some USB flash drives (e.g., a device with security lockout) may not work.
- Some software files may not allow for audio play or text data display.
- Some versions of MP3, WMA, or AAC formats may be unsupported.

### ▣ iPod and iPhone Model Compatibility

This system may not work with all software versions of these devices.

### ▣ USB Flash Drives

Files on the USB flash drive are played in their stored order. This order may be different from the order displayed on your PC or device.



# Customized Features

Use the audio/information screen to customize certain features.

Models with color audio system

## How to customize

While the vehicle is at a complete stop with the ignition switch in ON **[II]**, press the **MENU/CLOCK** button, then select **Settings**. To customize the phone settings, press the **[Phone]** button, then select **Phone Setup**.

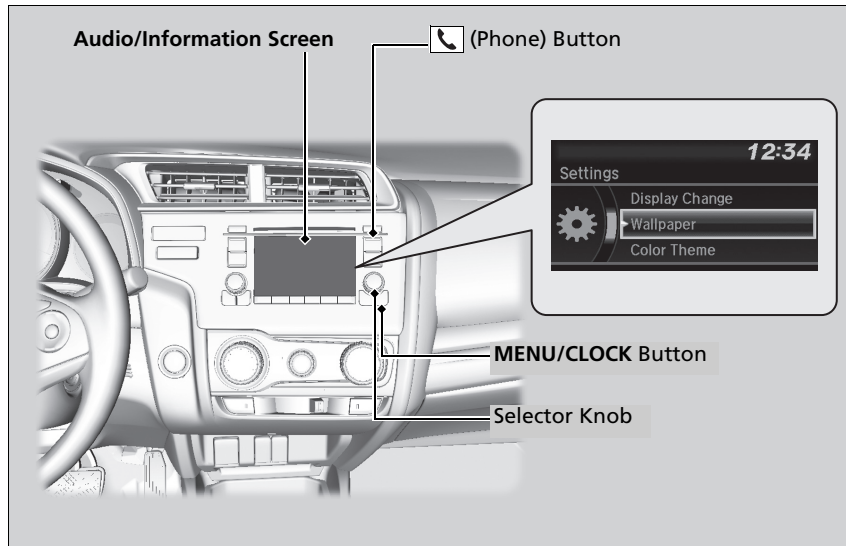

## Customized Features

When you customize settings:

- Make sure that the vehicle is at a complete stop.

### Continuously variable transmission models

- Shift to **[P]**.

### Manual transmission models



- Set the parking brake.

## How to customize

These indications are used to show how to operate the selector knob.

Rotate  to select.

Press  to enter.

To customize other features, select **Settings**, rotate , then press .

**➤ List of customizable options P. 325**

Continued

### ■ Customization Flow

Press the **MENU/CLOCK** button.

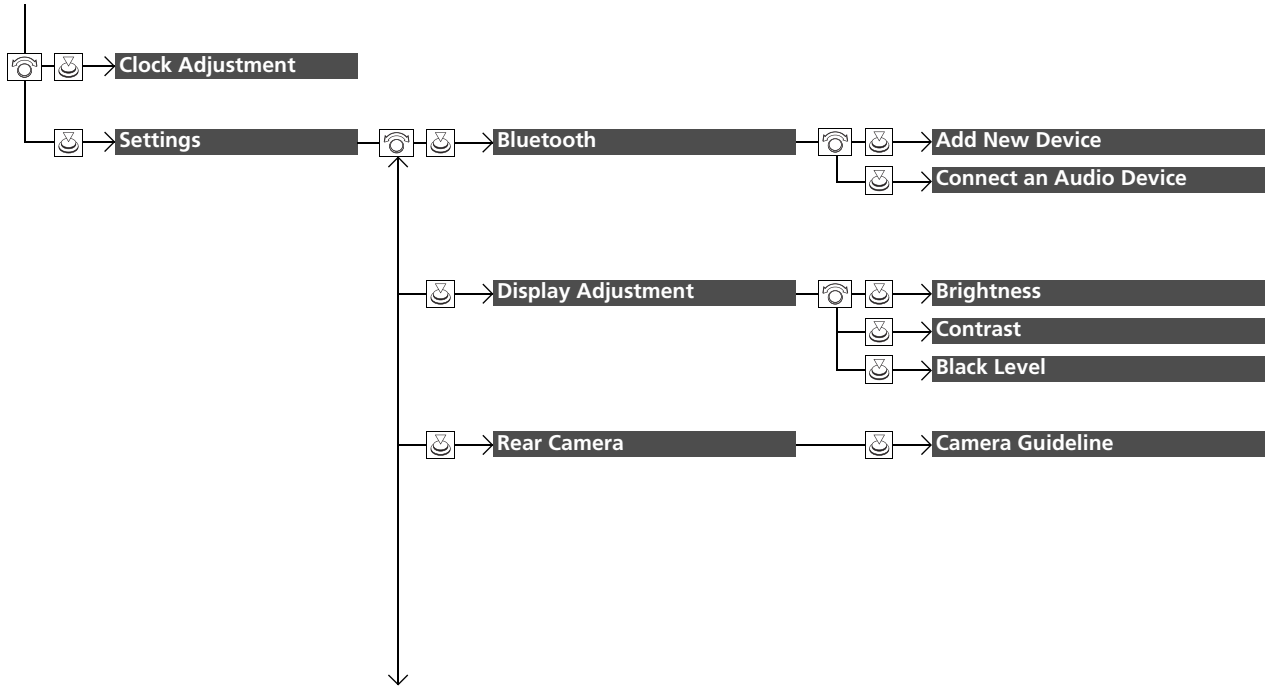

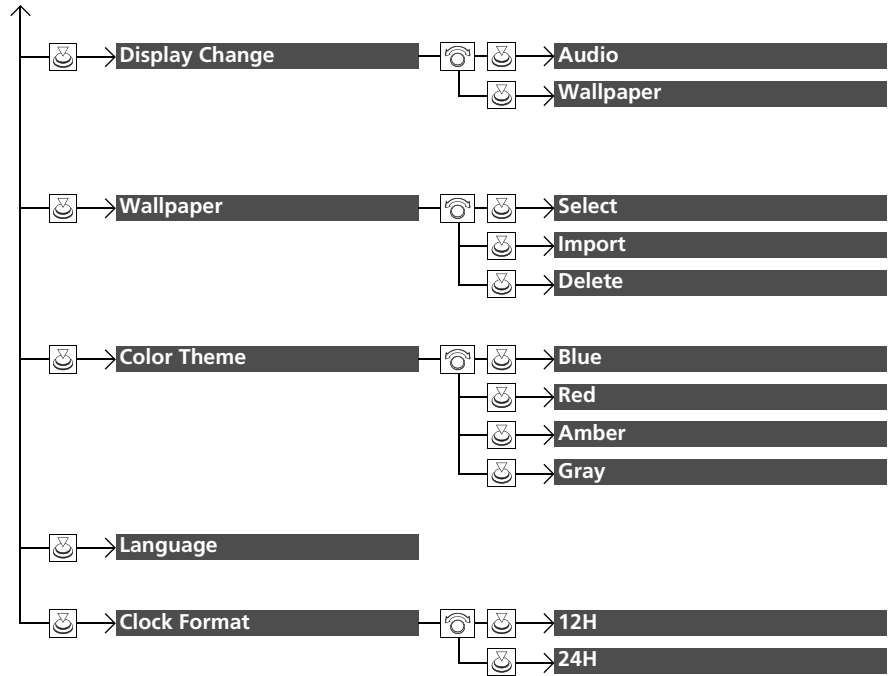

Press the  button and rotate  to select **Phone Setup**, then press .

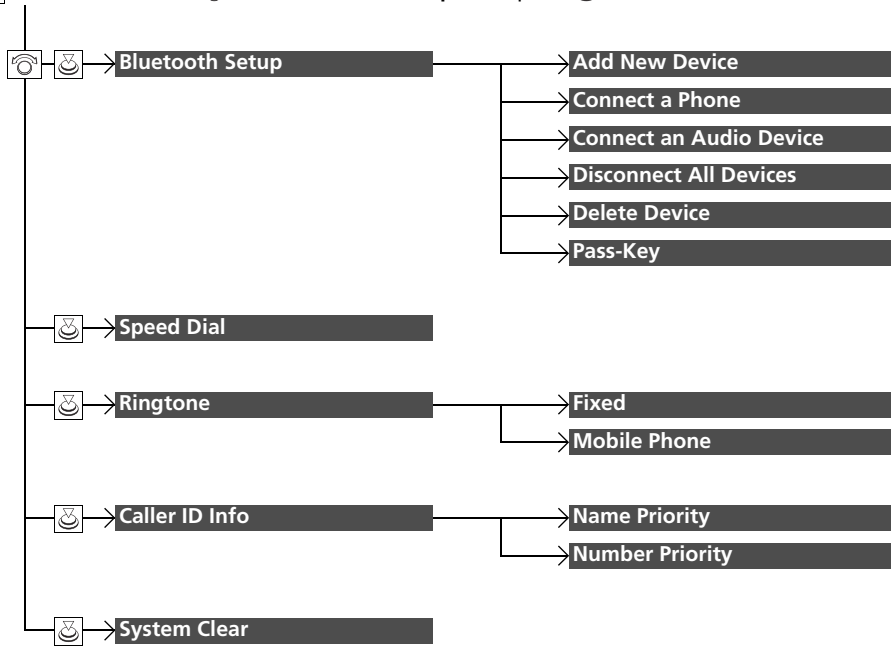

■ List of customizable options

Setup Group	Customizable Features	Description	Selectable Settings	
<b>Clock Adjustment</b>		Adjust Clock. ☒ <b>Clock</b> P. 122	—	
<b>Settings</b>	<b>Bluetooth</b>			
	<b>Add New Device</b>	Pairs a new phone to HFL, edits and deletes a paired phone, and create a code for a paired phone. ☒ <b>Phone Setup</b> P. 349	—	
	<b>Connect an Audio Device</b>	Connects, disconnects or pairs a <i>Bluetooth</i> ® Audio device to HFL.	—	
	<b>Brightness</b>	Changes the brightness of the audio/information screen.	—	
	<b>Display Adjustment</b>	<b>Contrast</b>	Changes the contrast of the audio/information screen.	—
		<b>Black Level</b>	Changes the black level of the audio/information screen.	—
<b>Rear Camera</b>	<b>Camera Guideline</b>	Selects whether the guidelines come on the audio/information screen.	<b>On<sup>*1</sup>/Off</b>	

\*1: Default Setting

Setup Group	Customizable Features	Description	Selectable Settings	
Settings	<b>Display Change</b>	Changes the display type.	<b>Audio<sup>*1</sup>/Wallpaper</b>	
	<b>Wallpaper</b>	<b>Select</b>	Changes the wallpaper type.	<b>Clock<sup>*1</sup>/Image1/Image2/Image3</b>
		<b>Import</b>	Imports an image file for a new wallpaper.  <b>Wallpaper Setup</b> P. 215	—
		<b>Delete</b>	Deletes an image file for a wallpaper.	<b>Image1<sup>*1</sup>/Image2/Image3</b>
	<b>Color Theme</b>	Changes the background color of the audio/information screen.	<b>Blue<sup>*1</sup>/Red/Amber/Gray</b>	
	<b>Language</b>	Changes the display language.	<b>English<sup>*1</sup>/French/Spanish</b>	
	<b>Clock Format</b>	Selects the digital clock display from 12H to 24H.	<b>12H<sup>*1</sup>/24H</b>	

\*1 : Default Setting

Setup Group	Customizable Features	Description	Selectable Settings
Phone Setup	<b>Add New Device</b>	Pairs a new phone to HFL. ➤ <b>Phone Setup</b> P. 349	—
	<b>Connect a Phone</b>	Pairs a new phone or connects a paired phone to HFL. ➤ <b>Phone Setup</b> P. 349	—
	<b>Bluetooth Setup</b>		
	<b>Connect an Audio Device</b>	Connects a <i>Bluetooth</i> ® Audio device to HFL.	—
	<b>Disconnect All Devices</b>	Disconnects a paired phone from HFL.	—
	<b>Delete Device</b>	Deletes a paired phone.	—
	<b>Pass-Key</b>	Inputs and changes a code for a paired phone.	—
	<b>Speed Dial</b>	Edits, adds or deletes a speed dial entry. ➤ <b>Speed Dial</b> P. 358	—
	<b>Ringtone</b>	Selects the ring tone.	<b>Fixed</b> *1/ <b>Mobile Phone</b>
	<b>Caller ID Info</b>	Prioritizes the caller's name or phone number as the caller ID.	<b>Name Priority</b> *1/ <b>Number Priority</b>
<b>System Clear</b>	Cancels/Resets all customized items in the <b>Phone Setup</b> group as default.	—	

\*1: Default Setting

Use the audio/information screen to customize certain features.

Models with display audio system

## ■ How to customize

With the ignition switch in ON **II**\*1, select **Settings**, then select a setting item.

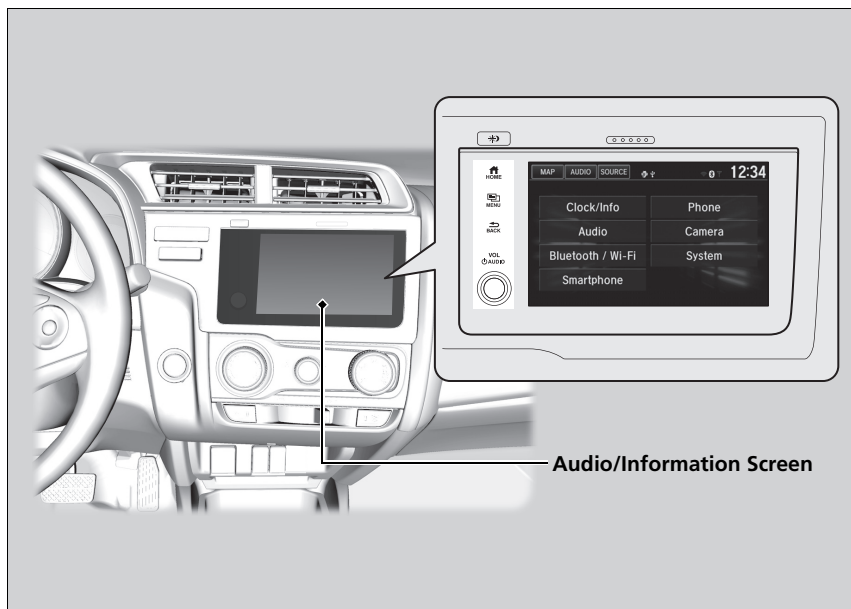

## ▶ Customized Features

When you customize settings:

- Make sure that the vehicle is at a complete stop.
- **Continuously variable transmission models**  
Shift to **P**.
- **Manual transmission models**  
Set the parking brake.

To customize other features, select **Settings**.

▶ **List of customizable options** P. 334

\*1 : Models with the keyless access system have an **ENGINE START/STOP** button instead of an ignition switch.



Models with display audio system

■ Customization Flow

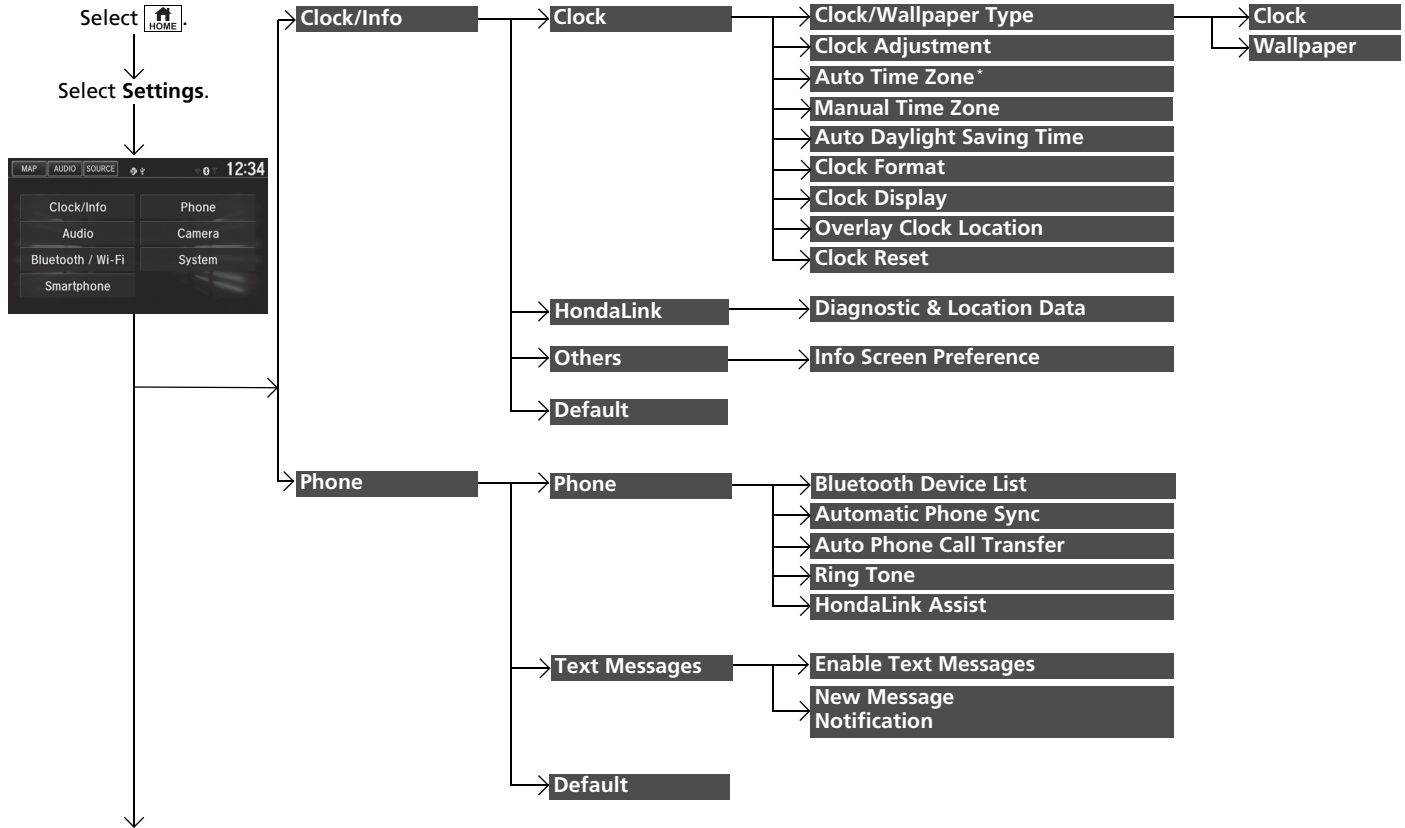

\* Not available on all models

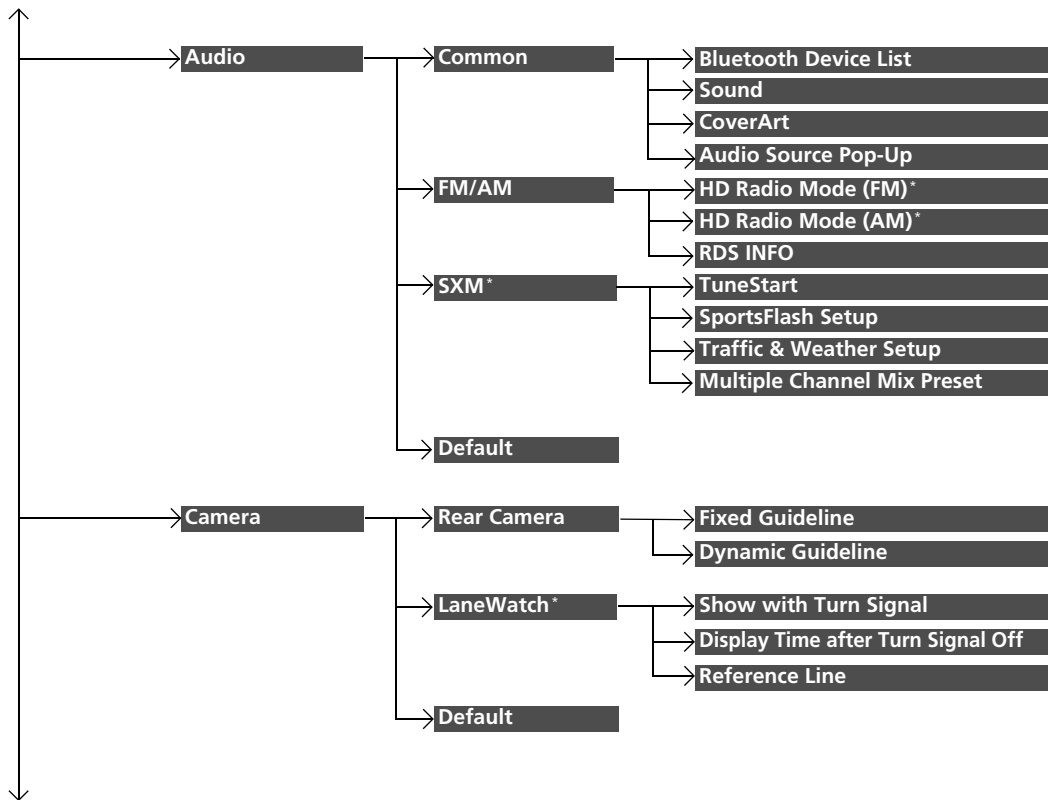

\* 1 : May change depending on your currently selected source.

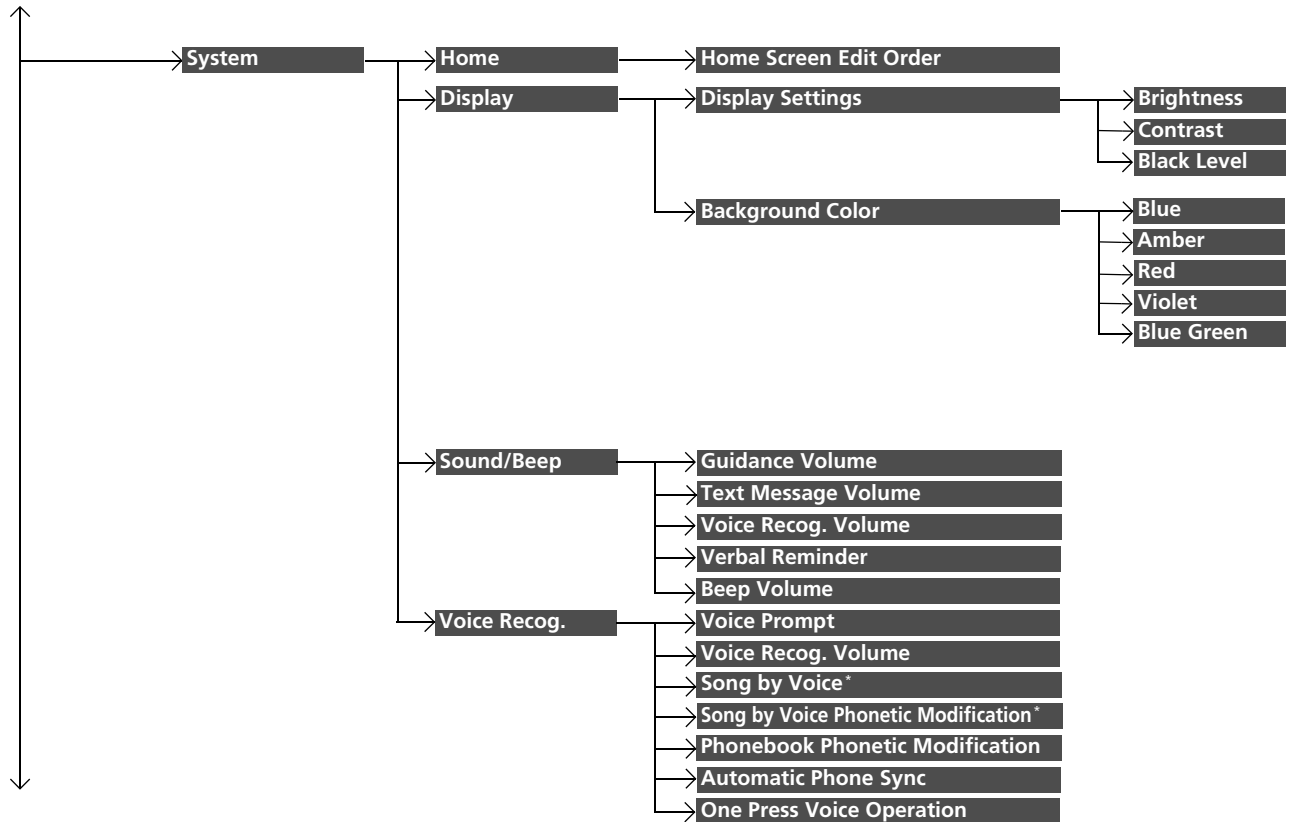

\* Not available on all models

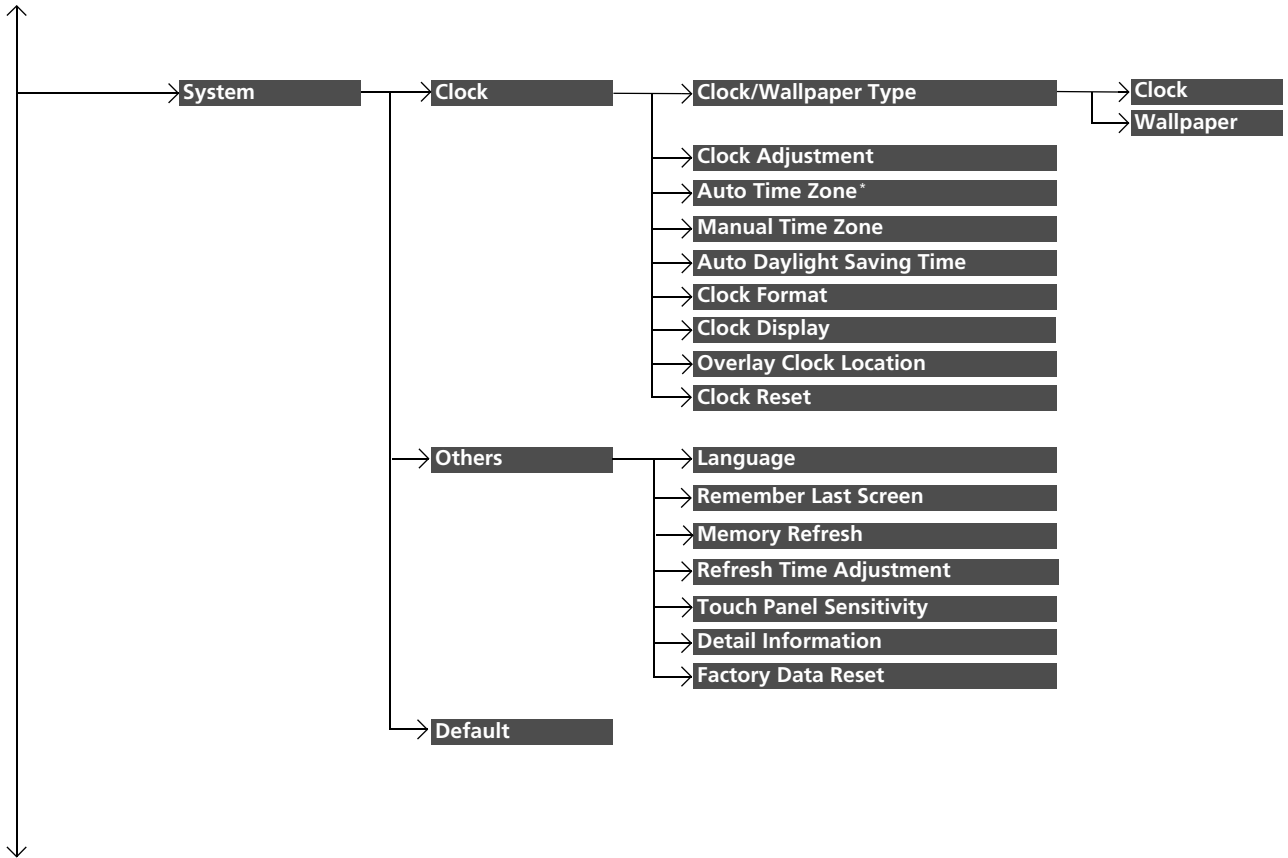

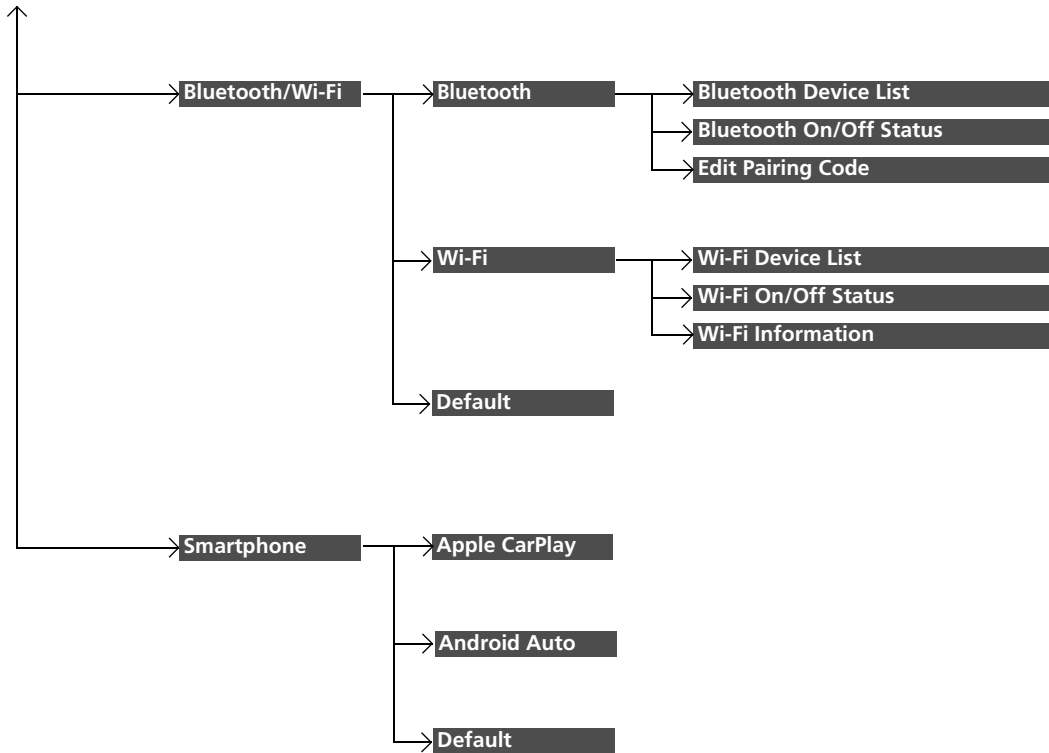





■ List of customizable options

Setup Group	Customizable Features	Description	Selectable Settings	
Clock/Info	Clock	<b>Clock</b>	Changes the clock display type. <b>Analog/Digital*<sup>1</sup>/Small Digital/Off</b>	
		<b>Clock/Wallpaper Type</b>	<ul style="list-style-type: none"> <li>Changes the wallpaper type.</li> <li>Imports an image file for a new wallpaper.</li> <li>Deletes an image file for a wallpaper.</li> </ul> <b>Galaxy*<sup>1</sup>/Metallic/Time Zone/Blank</b>	
	Clock	<b>Clock Adjustment</b>	Adjusts clock.  <b>Adjusting the Clock</b> P. 122	—
		<b>Auto Time Zone*</b>	Automatically adjusts the clock when driving through different time zones.	<b>On*<sup>1</sup>/Off</b>
		<b>Manual Time Zone</b>	Changes the time zone manually.	—
		<b>Auto Daylight Saving Time</b>	Select <b>On</b> to have the GPS automatically adjust the clock to daylight savings time. Select <b>Off</b> to cancel this function.	<b>On*<sup>1</sup>/Off</b>
		<b>Clock Format</b>	Selects the digital clock display from 12H to 24H.	<b>12H*<sup>1</sup>/24H</b>
		<b>Clock Display</b>	Selects whether the clock display comes on.	<b>On*<sup>1</sup>/Off</b>
		<b>Overlay Clock Location</b>	Changes the clock display layout.	<b>Upper Right*<sup>1</sup>/Upper Left/Lower Right/Lower Left/Off</b>
		<b>Clock Reset</b>	Resets the clock settings to the factory default.	<b>Yes/No</b>
<b>HondaLink</b>	<b>Diagnostic &amp; Location Data</b>	Turns HondaLink® on and off.	<b>On/Off*<sup>1</sup></b>	

\*1 : Default Setting

Setup Group	Customizable Features	Description	Selectable Settings	
Clock/Info	Others <b>Info Screen Preference</b>	Selects the top menu when the  button is pressed. <ul style="list-style-type: none"> <li>• <b>Info Top</b>- A brief menu pops up.</li> <li>• <b>Info Menu</b>- A full menu pops up.</li> <li>• <b>Off</b>- A menu does not pop up.</li> </ul>	<b>Info Top/Info Menu/Off</b> <sup>*1</sup>	
	<b>Default</b>	Cancels/Resets all customized items in the <b>Clock/Info</b> settings group as default.	<b>Yes/No</b>	
Phone	<b>Bluetooth Device List</b>	Pairs a new phone to HFL, edits or deletes a paired phone.  <b>Phone Setup</b> P. 375	—	
	Phone	<b>Automatic Phone Sync</b>	Sets a phonebook and call history data to be automatically imported when a phone is paired to HFL.	<b>On</b> <sup>*1</sup> / <b>Off</b>
		<b>Auto Phone Call Transfer</b>	Set calls to automatically transfer from your phone to HFL when you enter the vehicle.	<b>On</b> <sup>*1</sup> / <b>Off</b>
		<b>Ring Tone</b>	Selects the ring tone.	<b>Fixed/Mobile Phone</b> <sup>*1</sup>
		<b>HondaLink Assist</b>	Turns HondaLink® Assist on and off.	<b>On/Off</b> <sup>*1</sup>
	Text Messages	<b>Enable Text Messages</b>	Turns the text message function on and off.	<b>On</b> <sup>*1</sup> / <b>Off</b>
		<b>New Message Notification</b>	Selects whether a pop-up alert comes on the screen when HFL receives a new text message.	<b>On/Off</b>
<b>Default</b>	Cancels/Resets all customized items in the <b>Phone</b> settings group as default.	<b>Yes/No</b>		

\*1: Default Setting

Setup Group	Customizable Features	Description	Selectable Settings
Audio	<b>Bluetooth Device List</b>	Pairs a new phone to HFL, edits or deletes a paired phone.  <b>Phone Setup</b> P. 375	—
	<b>Common</b> <b>Sound</b>	Adjusts the settings of the audio speaker's sound.  <b>Adjusting the Sound</b> P. 249	<b>-6 ~ 0*<sup>1</sup> ~ +6 (BASS, MIDDLE, and TREBLE), RR9~0*<sup>1</sup>~FR9 (FADER), L9~0*<sup>1</sup>~R9 (BALANCE), Off/Low/Mid*<sup>1</sup>/High (SVC)</b>
	<b>iPod, USB mode</b> [Your selected media] <b>Cover Art</b>	Turns the cover art display on and off.	<b>On*<sup>1</sup>/Off</b>
	<b>Audio Source Pop-Up</b>	Selects whether the list of selectable audio source comes on when <b>Audio</b> is selected on the home screen.	<b>On/Off*<sup>1</sup></b>
	<b>FM/AM mode</b> <b>FM/AM</b> <b>HD Radio Mode (FM)*</b>	Selects whether the FM radio automatically switches to the digital radio waves or receives the analog waves only.	<b>Auto*<sup>1</sup>/Analog Only</b>
	<b>HD Radio Mode (AM)*</b>	Selects whether the AM radio automatically switches to the digital radio waves or receives the analog waves only.	<b>Auto*<sup>1</sup>/Analog Only</b>
	<b>RDS INFO</b>	Turns on and off the RDS information.	<b>On/Off*<sup>1</sup></b>

\* 1 : Default Setting



Setup Group	Customizable Features	Description	Selectable Settings		
Audio	SiriusXM® mode SXM*	<b>TuneStart</b>	Turns on and off, starts the song from the beginning as you change preset stations.	On*/Off	
		<b>SportsFlash Setup</b>	<b>Interrupt</b>	Turns on and off the sports alert function.	Off/On(one time)/ On(continue)*1
			<b>Favorite Team</b>	Selects your favorite sports teams. <input checked="" type="checkbox"/> <b>Live Sports Alert</b> P. 264	—
			<b>Interrupt Beep</b>	Causes the system to beep when the sports alert is notified.	On*/Off
		<b>Traffic &amp; Weather Setup</b>	Selects the region you want to receive the information.	—	
		<b>Multiple Channel Mix Preset</b>	Turns multiple channel mix preset on and off.	On/Off*1	
	<b>Default</b>	Cancels/Resets all customized items in the <b>Audio</b> settings group as default.	Yes/No		
Camera	Rear Camera	<b>Fixed Guideline</b>	Selects whether the fixed guidelines come on the rear camera monitor. <input checked="" type="checkbox"/> <b>Multi-View Rear Camera</b> P. 481	On*/Off	
		<b>Dynamic Guideline</b>	Selects whether the guidelines adjust to the movement of the steering wheel. <input checked="" type="checkbox"/> <b>Multi-View Rear Camera</b> P. 481	On*/Off	
	<b>Default</b>	Cancels/Resets all customized items in the <b>Rear Camera</b> setting group as default.	Yes/No		

\*1: Default Setting

\* Not available on all models

Setup Group	Customizable Features	Description	Selectable Settings		
Camera	<b>Show with Turn Signal</b>	Selects whether the LaneWatch display comes on when you move the turn signal lever to indicate a right turn.	<b>On<sup>*1</sup>/Off</b>		
	<b>LaneWatch<sup>*</sup> Display Time after Turn Signal Off</b>	Changes the length of time the LaneWatch display stays on after the turn signal lever returns to the center.	<b>0 second<sup>*1</sup>/2 seconds</b>		
	<b>Reference Line</b>	Selects whether the reference lines come on the LaneWatch monitor.	<b>On<sup>*1</sup>/Off</b>		
	<b>Default</b>	Cancels/Resets all customized items in the <b>LaneWatch</b> group as default.	<b>Yes/No</b>		
System	<b>Home</b>	<b>Home Screen Edit Order</b> Changes the <b>HOME</b> screen icon layout.	—		
	<b>Display</b>	<b>Brightness</b>	Changes the brightness of the audio/information screen.	—	
		<b>Display Settings</b>	<b>Contrast</b>	Changes the contrast of the audio/information screen.	—
			<b>Black Level</b>	Changes the black level of the audio/information screen.	—
	<b>Background Color</b>	Changes the background color of the audio/information screen.	<b>Blue<sup>*1</sup>/Amber/Red/Violet/BlueGreen</b>		

\*1: Default Setting

Setup Group	Customizable Features	Description	Selectable Settings	
System	Sound/ Beep	<b>Guidance Volume</b>	Changes the sound volume. Adjusts the guidance volume of the navigation system.	<b>00~06<sup>*1</sup>~11</b>
		<b>Text Message Volume</b>	Changes the text message reading volume.	<b>01~06<sup>*1</sup>~11</b>
		<b>Voice Recog. Volume</b>	Changes the volume of the voice prompt.	<b>01~06<sup>*1</sup>~11</b>
		<b>Verbal Reminder</b>	Turns the verbal reminders on and off.	<b>On<sup>*1</sup>/Off</b>
		<b>Beep Volume</b>	Changes the beep volume.	<b>Off/1/2<sup>*1</sup>/3</b>
		<b>Voice Prompt</b>	Turns the voice prompt on and off.	<b>On<sup>*1</sup>/Off</b>
	Voice Recog.	<b>Voice Recog. Volume</b>	Changes the volume of the voice prompt.	<b>01~06<sup>*1</sup>~11</b>
		<b>Song by Voice<sup>*</sup></b>	Turns the Song By Voice™ on and off.	<b>On<sup>*1</sup>/Off</b>
		<b>Song by Voice Phonetic Modification<sup>*</sup></b>	Modifies a voice command for music stored in the system or an iPod/iPhone. ▶ <b>Phonetic Modification</b> P. 272	—
		<b>Phonebook Phonetic Modification</b>	Modifies a voice command for the phonebook. ▶ <b>Phonebook Phonetic Modification</b> P. 384	—
		<b>Automatic Phone Sync</b>	Sets phonebook and call history data to be automatically imported when a phone is paired to HFL.	<b>On<sup>*1</sup>/Off</b>
		<b>One Press Voice Operation</b>	Changes the setting of the  (Talk) button operation when using the voice operation.	<b>On<sup>*1</sup>/Off</b>

\*1: Default Setting

\* Not available on all models

Setup Group	Customizable Features	Description	Selectable Settings
System	<b>Clock</b> <hr/> <b>Clock/Wallpaper Type</b> <hr/> <b>Clock Adjustment</b> <hr/> <b>Auto Time Zone*</b> <hr/> <b>Manual Time Zone</b> <hr/> <b>Auto Daylight Saving Time</b> <hr/> <b>Clock Format</b> <hr/> <b>Clock Display</b> <hr/> <b>Overlay Clock Location</b> <hr/> <b>Clock Reset</b>	See <b>Clock/Info</b> on P. 334	
Others	<b>Language</b>	Change the display language.	<b>English (United States)*<sup>1</sup>/ Français/Español</b>
	<b>Remember Last Screen</b>	Selects whether the device remembers the last screen.	<b>On/Off*<sup>1</sup></b>
	<b>Memory Refresh</b>	Turns on the audio system automatically and restores the fragmentation of a memory when the ignition switch is LOCK 0* <sup>2</sup> .	<b>On*<sup>1</sup>/Off</b>
	<b>Refresh Time Adjustment</b>	Sets the time for <b>Memory Refresh</b> .	—
	<b>Touch Panel Sensitivity</b>	Sets the sensitivity of the touch panel screen.	<b>High/Low*<sup>1</sup></b>
	<b>Detail Information</b>	Displays the details of the head unit and operating system information.	—

\*1 : Default Setting

\*2: Models with the smart entry system have an **ENGINE START/STOP** button instead of an ignition switch

Setup Group	Customizable Features		Description	Selectable Settings
System	Others	<b>Factory Data Reset</b>	Resets all the settings to their factory default. ▶ <b>Defaulting All the Settings</b> P. 342	Yes/No
	Default		Cancels/Resets all customized items in the <b>System</b> group as default.	Yes/No
Bluetooth/ Wi-Fi	Bluetooth	<b>Bluetooth Device List</b>	Pairs a new phone to HFL, edits or deletes a paired phone. ▶ <b>Phone Setup</b> P. 375	—
		<b>Bluetooth On/Off Status</b>	Changes the <i>Bluetooth</i> ® status.	On* <sup>1</sup> /Off
		<b>Edit Pairing Code</b>	Edits a pairing code. ▶ <b>To change the pairing code setting</b> P. 376	Random/Fixed* <sup>1</sup>
	Wi-Fi	<b>Wi-Fi Device List</b>	Connects, disconnects, or deletes the Wi-Fi device.	—
		<b>Wi-Fi On/Off Status</b>	Changes the Wi-Fi mode.	On/Off* <sup>1</sup>
<b>Wi-Fi Information</b>		Shows the Wi-Fi information of the head unit.	—	
Default		Cancels/Resets all customized items in the <b>Bluetooth/Wi-Fi</b> group as default.	Yes/No	
Smartphone		<b>Apple CarPlay</b>	Sets up the Apple CarPlay™ connection.	—
		<b>Android Auto</b>	Sets up the Android Auto™ connection.	—
	Default		Cancels/Resets all customized items in the <b>Smartphone</b> group as default.	Yes/No

\*1: Default Setting

\*2: Models with the smart entry system have an **ENGINE START/STOP** button instead of an ignition switch.

## Defaulting All the Settings

Reset all the menu and customized settings as the factory defaults.

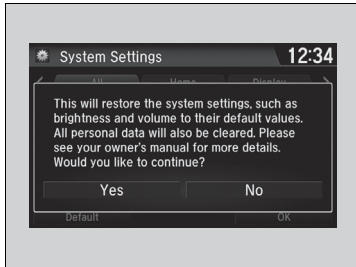

1. Select .
2. Select **Settings**.
3. Select **System**.
4. Select the **Others** tab.
5. Select **Factory Data Reset**.
  - A confirmation message appears on the screen.
6. Select **Yes** to reset the settings.
  - A confirmation message appears on the screen.
7. Select **Yes** again to reset the settings.
  - After selecting **Yes**, the system will reboot.

### ►► Defaulting All the Settings

When you transfer the vehicle to a third party, reset all settings to default and delete all personal data.

If you perform **Factory Data Reset**, it will reset the preinstalled apps to their factory default.

If you perform **Factory Data Reset**, you cannot use the HondaLink® because it becomes off line.

► **HondaLink®** P. 281

Bluetooth® HandsFreeLink® (HFL) allows you to place and receive phone calls using your vehicle's audio system, without handling your cell phone.

Models with color audio system

## Using HFL

### HFL Buttons

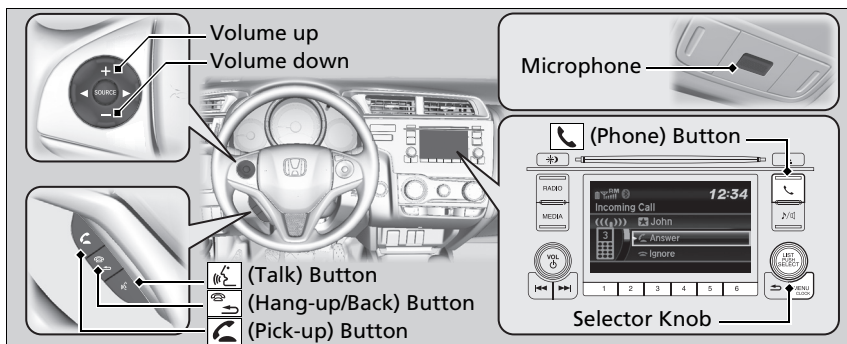



**(Pick-up) button:** Press to go directly to the **Phone** screen or to answer an incoming call.

**(Hang-up/Back) button:** Press to end a call or to cancel a command.

**(Talk) button:** Press to call a number with a stored voice tag.

**(Phone) button:** Press to go directly to the **Phone** screen.

**Selector knob:** Rotate  to select an item on the screen, then press .

### Using HFL

Place your phone where you can get good reception. To use HFL, you need a Bluetooth-compatible cell phone. For a list of compatible phones, pairing procedures, and special feature capabilities:

- U.S.: Visit [automobiles.honda.com/handsfreelink/](http://automobiles.honda.com/handsfreelink/), or call 1-888-528-7876.
- Canada: For more information on smartphone compatibility, call 1-888-528-7876.

#### Voice control tips

- Aim the vents away from the ceiling and close the windows, as noise coming from them may interfere with the microphone.
- Press and release the  button when you want to call a number using a stored voice tag. Speak clearly and naturally after a beep.
- If the microphone picks up voices other than yours, the command may be misinterpreted.
- To change the volume level, use the audio system's volume knob or the remote audio controls\* on the steering wheel.

State or local laws may prohibit the operation of handheld electronic devices while operating a vehicle.

If you receive a call while using the audio system, the system resumes its operation after ending the call.

Up to 20 speed dial entries can be stored. If there is no entry in the system, Speed Dial is disabled.

 **Speed Dial** P. 358

Up to 20 call histories can be stored. If there is no call history, Call History is disabled.

\* Not available on all models

Continued

### HFL Status Display

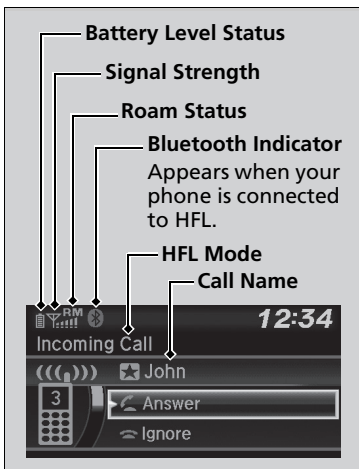

The audio/information screen notifies you when there is an incoming call.

### Limitations for Manual Operation

Certain manual functions are disabled or inoperable while the vehicle is in motion. You cannot select a grayed-out option until the vehicle is stopped.

Only previously stored speed dial entries can be called using voice commands while the vehicle is in motion.

▶ **Speed Dial** P. 358

### Using HFL

**Bluetooth® Wireless Technology**  
The *Bluetooth®* word mark and logos are registered trademarks owned by *Bluetooth SIG, Inc.*, and any use of such marks by Honda Motor Co., Ltd., is under license. Other trademarks and trade names are those of their respective owners.

**HFL Limitations**  
An incoming call on HFL will interrupt the audio system when it is playing. It will resume when the call is ended.

### HFL Status Display

The information that appears on the audio/information screen varies between phone models.

You can change the system language to English, French, or Spanish.

▶ **Customized Features** P. 321



# HFL Menu

The ignition switch must be in ACCESSORY **I** or ON **II** to use HFL.

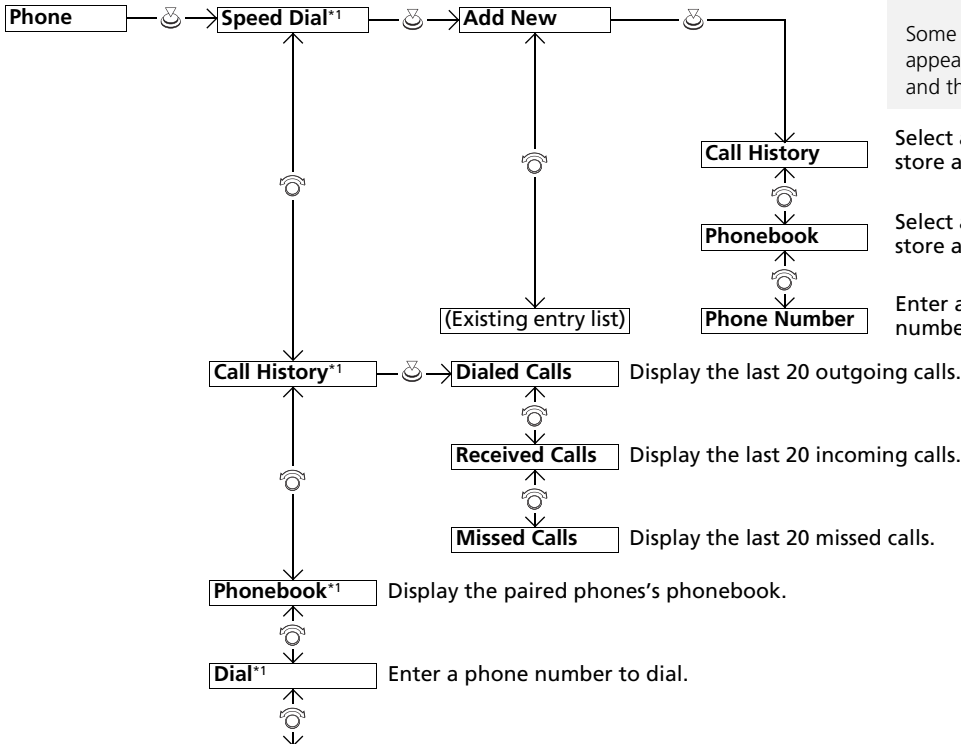
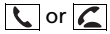

\*1: Appears only when a phone is connected to HFL.

**HFL Menu**

To use HFL, you must first pair your Bluetooth-compatible cell phone to the system while the vehicle is parked.

Some functions are limited while driving. A message appears on the screen when the vehicle is moving and the operation is canceled.

Select a phone number from the call history to store as a speed dial number.

Select a phone number from the phonebook to store as a speed dial number.

Enter a phone number to store as a speed dial number.

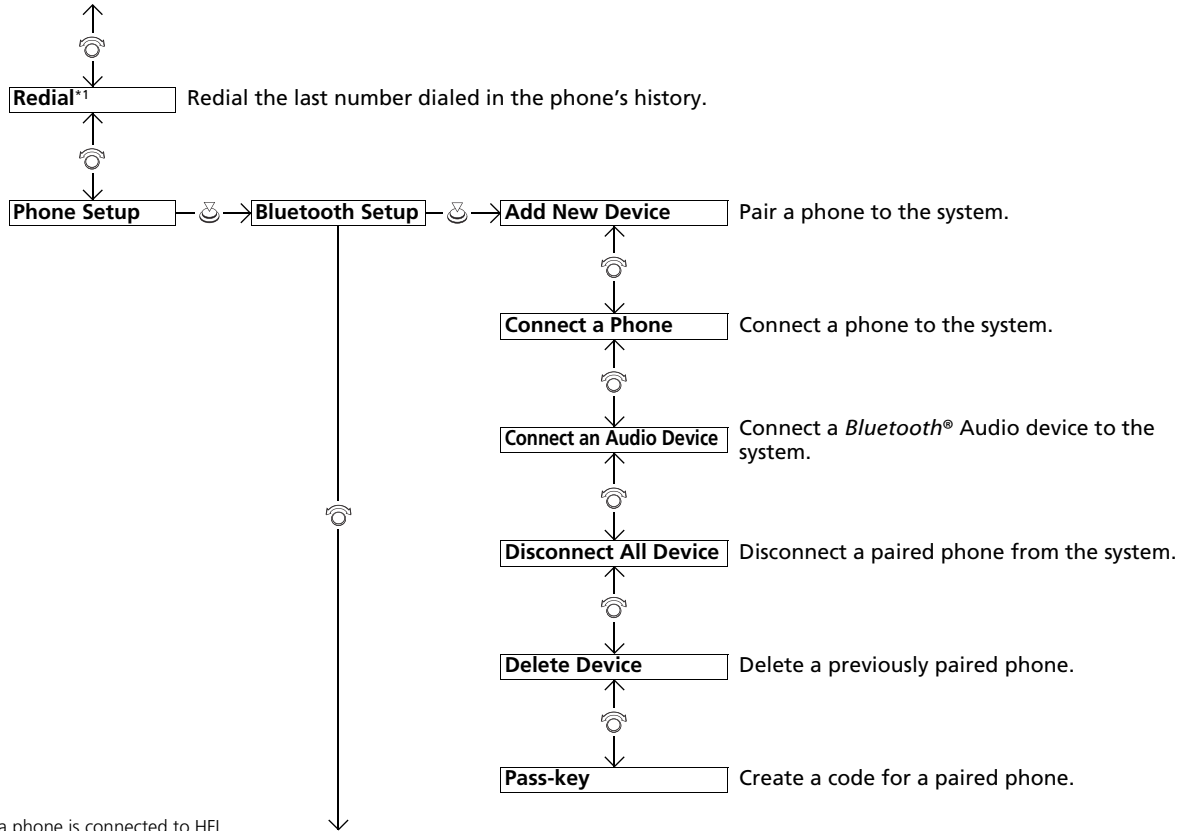

\*1: Appears only when a phone is connected to HFL.

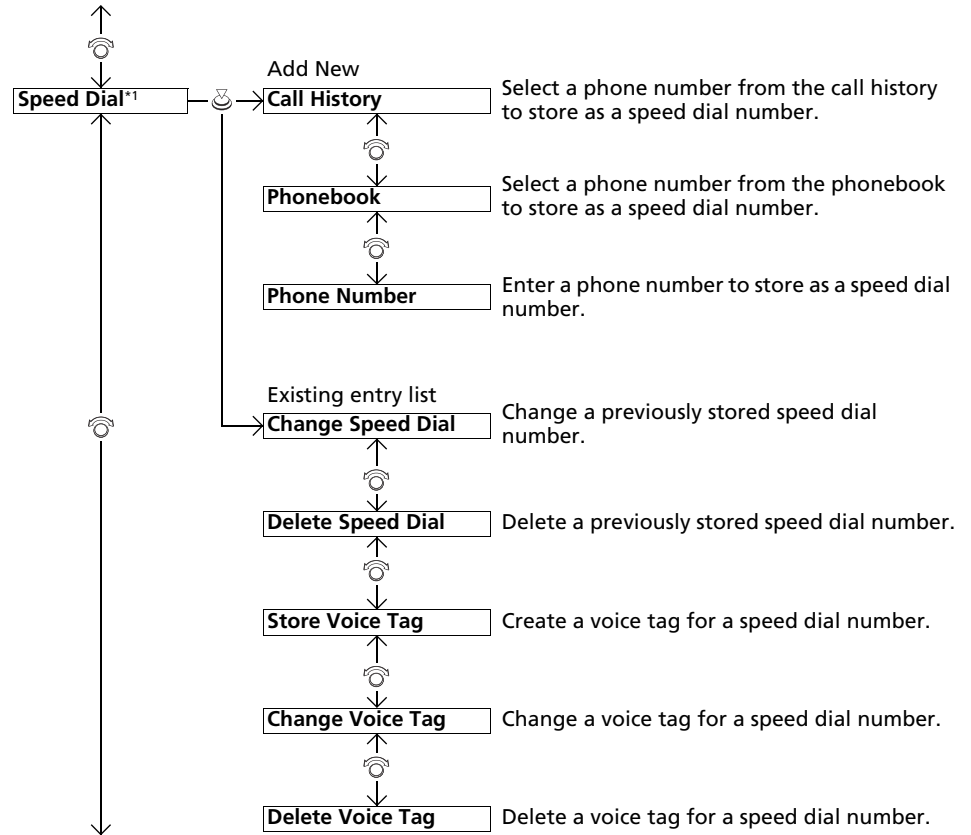

\*1: Appears only when a phone is connected to HFL.

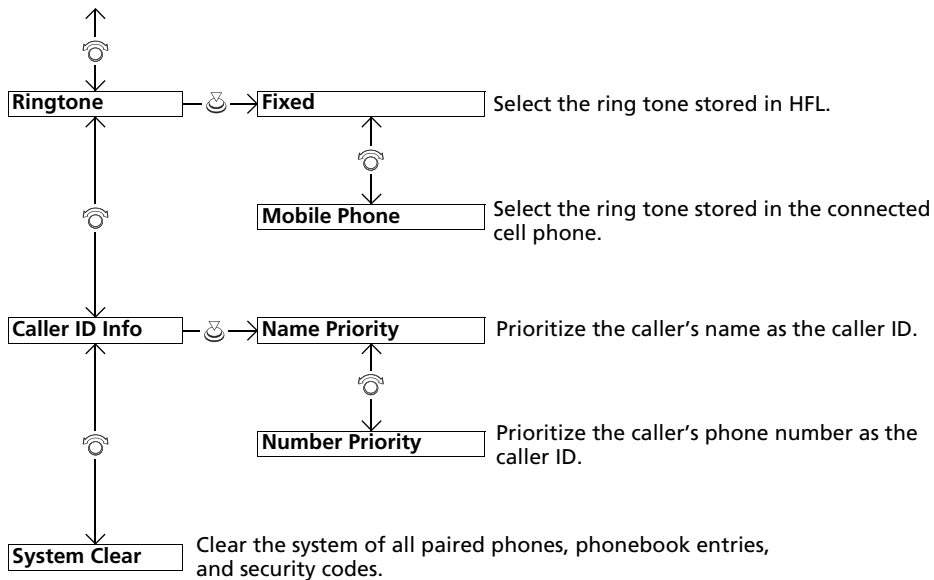

## Phone Setup

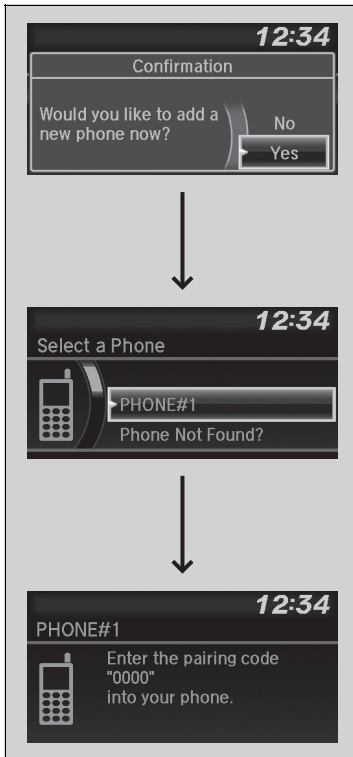

### ■ To pair a cell phone (No phone has been paired to the system)

1. Press the button or the button.
2. Rotate to select **Yes**, then press .
3. Make sure your phone is in search or discoverable mode, then press .
  - ▶ HFL automatically searches for a *Bluetooth*® device.
4. When your phone appears on the list, select it by pressing .
  - ▶ If your phone doesn't appear, select **Phone Not Found?** and search for *Bluetooth*® devices using your phone. From your phone, select **HandsFreeLink**.
5. The system gives you a pairing code on the audio/information screen.
  - ▶ Confirm if the pairing code on the screen and your phone match. This may vary by phone.
6. A notification appears on the screen if pairing is successful.

### ☒ Phone Setup

Your *Bluetooth*-compatible phone must be paired to HFL before you can make and receive hands-free calls.

#### Phone Pairing Tips:

- You cannot pair your phone while the vehicle is moving.
- Up to six phones can be paired.
- Your phone's battery may drain faster when it is connected to HFL.
- If your phone is not ready for pairing or not found by the system within three minutes, the system will time out and returns to idle.

Once you have paired a phone, you can see it displayed on the screen with one or two icons on the right side.

These icons indicate the following:







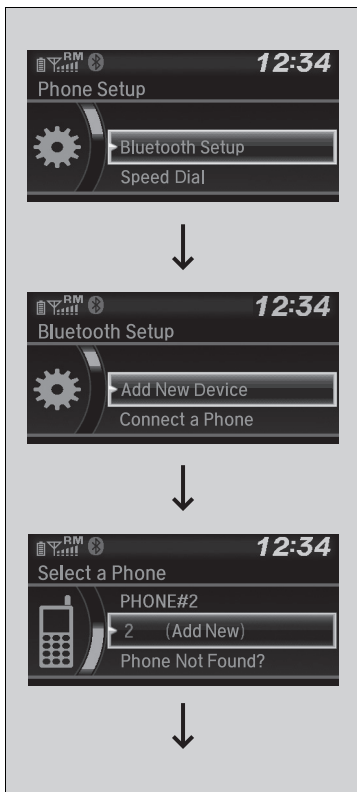

: The phone can be used with HFL.

: The phone is compatible with *Bluetooth*® Audio.



Continued



■ **To pair a mobile phone (when a phone has already been paired to the system)**

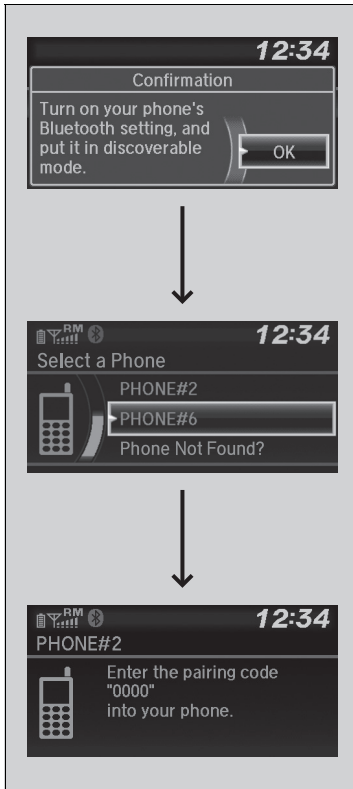





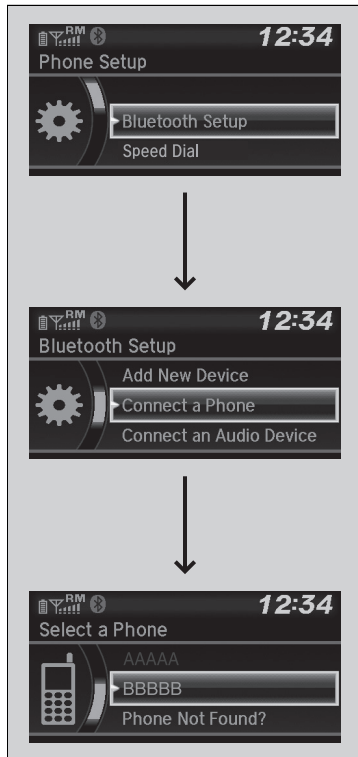



1. Press the  button or the  button.
  - ▶ If a prompt appears asking to connect to a phone, select **No** and proceed with step 2.
2. Rotate  to select **Phone Setup**, then press .
3. Rotate  to select **Bluetooth Setup**, then press .
4. Rotate  to select **Add New Device**, then press .
  - ▶ The screen changes to device list.
5. Rotate  to select **Add New**, then press .



6. Make sure your phone is in search or discoverable mode, then press .
  - ▶ HFL automatically searches for a *Bluetooth®* device.
  
7. When your phone appears on the list, select it by pressing .
  - ▶ If your phone does not appear, select **Phone Not Found?** and search for *Bluetooth®* devices using your phone. From your phone, select **HandsFreeLink**.
  
8. The system gives you a pairing code on the audio display.
  - ▶ Confirm if the pairing code on the screen and your phone match. This may vary by phone.



■ **To Change the currently paired phone**

1. Press the  button or the  button.
2. Rotate  to select **Phone Setup**, then press .
3. Rotate  to select **Bluetooth Setup**, then press .
4. Rotate  to select **Connect a Phone**, then press 
  - ▶ The screen changes to a device list.
5. Rotate  to select a desired device name, then press 
  - ▶ HFL disconnects the connected phone and starts searching for another paired phone.



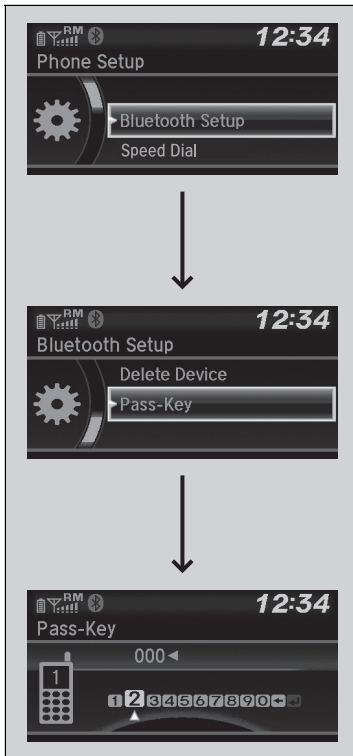

■ **To change the pairing code setting**

1. Press the button or the button.
2. Rotate to select **Phone Setup**, then press .
3. Rotate to select **Bluetooth Setup**, then press .
4. Rotate to select **Pass-Key**, then press .
5. Input a new pairing code, then press .

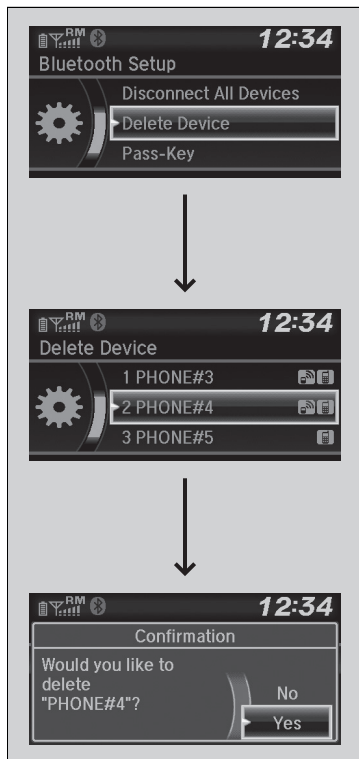

■ **To delete a paired phone**

1. Press the button or the button.
2. Rotate to select **Phone Setup**, then press .
3. Rotate to select **Bluetooth Setup**, then press .
4. Rotate to select **Delete Device**, then press .
  - ▶ The screen changes to a device list.
5. Rotate to select a phone you want to delete, then press .
6. A confirmation message appears on the screen. Rotate to select **Yes**, then press .

## Ring Tone

You can change the ring tone setting.

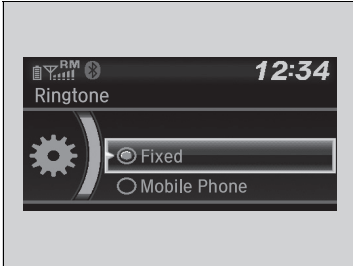

1. Press the button or the button.
2. Rotate to select **Phone Setup**, then press .
3. Rotate to select **Ringtone**, then press .
4. Rotate to select **Fixed** or **Mobile Phone**, then press .

## Caller's ID Information

You can select a caller's information to be displayed when you have an incoming call.

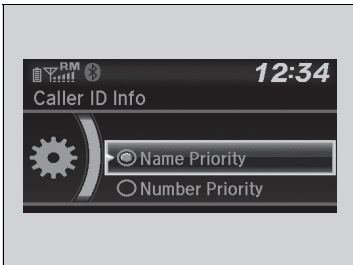

1. Press the button or the button.
2. Rotate to select **Phone Setup**, then press .
3. Rotate to select **Caller ID Info**, then press .
4. Rotate to select a mode you want, then press .

### Ring Tone

**Fixed:** The fixed ring tone sounds from the speakers.  
**Mobile Phone:** For certain connected phones, the ring tone stored in the phone sounds from the speakers.

### Caller's ID Information

**Name Priority:** A caller's name is displayed if it is stored in the phonebook.  
**Number Priority:** A caller's phone number is displayed.

## ■ To Clear the System

Pairing codes, paired phones, all stored voice tags, all speed dial entries, all call history data, and all imported phonebook data are erased.

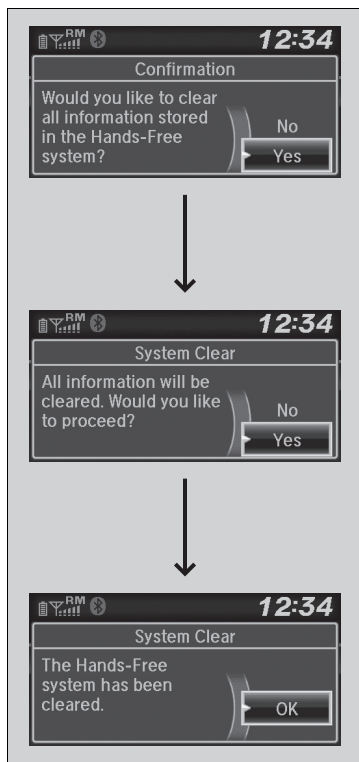

1. Press the button or the button.
2. Rotate to select **Phone Setup**, then press .
3. Rotate to select **System Clear**, then press .
4. Rotate to select **Yes**, then press .
5. A confirmation message appears on the screen. Rotate to select **Yes**, then press .
6. A notification appears on the screen. Press .

## Automatic Import of Cellular Phonebook and Call History

When your phone is paired, the contents of its phonebook and call history are automatically imported to HFL.

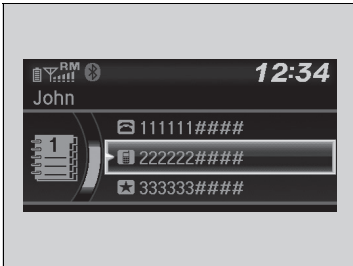

### Automatic Import of Cellular Phonebook and Call History

When you select a person from the list in the cellular phonebook, you can see up to three category icons. The icons indicate what types of numbers are stored for that name.



If a name has four or more numbers, ... appears instead of category icons.

On some phones, it may not be possible to import the category icons to HFL.

The phonebook is updated after every connection. Call history is updated after every connection or call.

## ■ Speed Dial

Up to 20 speed dial numbers can be stored per phone.

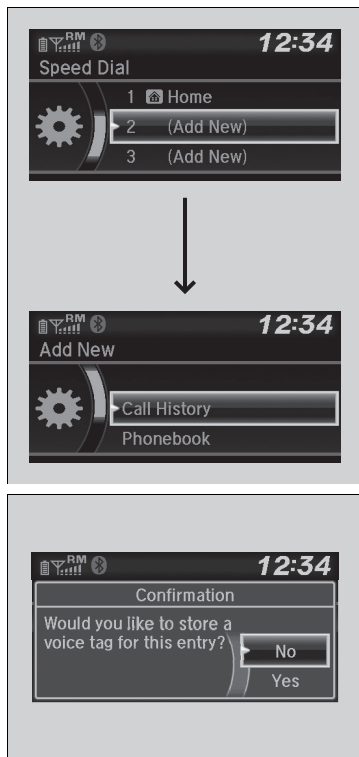

To store a speed dial number:

1. Press the button or the button.
2. Rotate to select **Speed Dial**, then press .
3. Rotate to select **Add New**, then press .
4. Rotate to select a place to choose a number from, then press .

From **Call History**:

- ▶ Select a number from the call history.

From **Phonebook**:

- ▶ Select a number from the connected cell phone's imported phonebook.

From **Phone Number**:

- ▶ Input the number manually.

5. When the speed dial is successfully stored, you are asked to create a voice tag for the number. Rotate to select **Yes** or **No**, then press .
6. Using the button, follow the prompts to say the name for the speed dial entry.

## ▶▶ Speed Dial







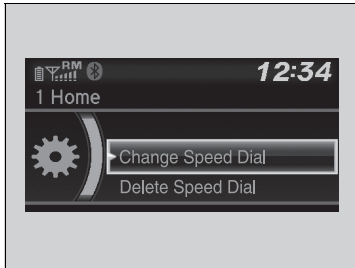

You can use the audio preset buttons during a call to store a speed dial number:

1. Press and hold the desired audio preset button during a call.
2. The contact information for the active call will be stored for the corresponding speed dial.

When a voice tag is stored, you can press the button and call the number using voice commands.



### ■ To edit a speed dial

1. Press the  button or the  button.
2. Rotate  to select **Phone Setup**, then press .
3. Rotate  to select **Speed Dial**, then press .
4. Select an existing speed dial entry.
5. Rotate  to select **Change Speed Dial**, then press .
6. Select a new speed dial number, then press .

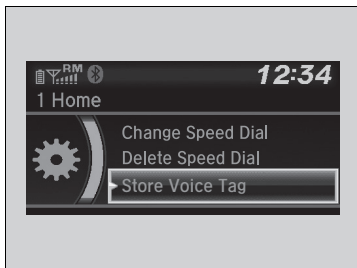

■ **To add a voice tag to a stored speed dial number**

1. Press the button or the button.
2. Rotate to select **Phone Setup**, then press .
3. Rotate to select **Speed Dial**, then press .
4. Select an existing speed dial entry.
5. Rotate to select **Store Voice Tag**, then press .
6. Using the button, follow the prompts to complete the voice tag.

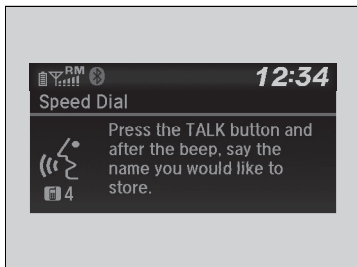

■ **To change a voice tag**

1. Press the button or the button.
2. Rotate to select **Phone Setup**, then press .
3. Rotate to select **Speed Dial**, then press .
4. Select an existing speed dial entry.
5. Rotate to select **Change Voice Tag**, then press .
6. Using the button, follow the prompts to complete the voice tag.

▶▶ Speed Dial

Avoid using duplicate voice tags.  
 Avoid using "home" as a voice tag.  
 It is easier for HFL to recognize a longer name. For example, use "John Smith" instead of "John."



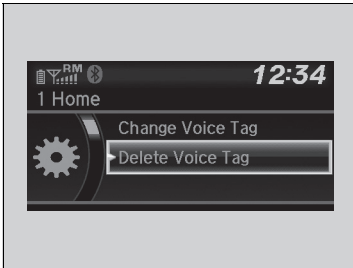

### ■ To delete a voice tag

1. Press the button or the button.
2. Rotate to select **Phone Setup**, then press .
3. Rotate to select **Speed Dial**, then press .
4. Select an existing speed dial entry.
5. Rotate to select **Delete Voice Tag**, then press .
  - ▶ A confirmation message appears on the screen. Rotate to select **Yes**, then press .

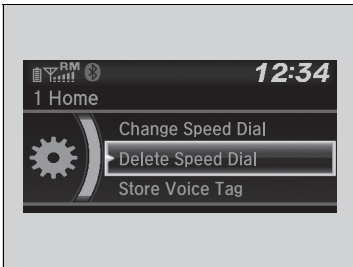

### ■ To delete a speed dial number

1. Press the button or the button.
2. Rotate to select **Phone Setup**, then press .
3. Rotate to select **Speed Dial**, then press .
4. Select an existing speed dial entry.
5. Rotate to select **Delete Speed Dial**, then press .
  - ▶ A confirmation message appears on the screen. Rotate to select **Yes**, then press .

## ■ Making a Call

You can make calls by inputting any phone number, or by using the imported phonebook, call history, speed dial entries, or redial.

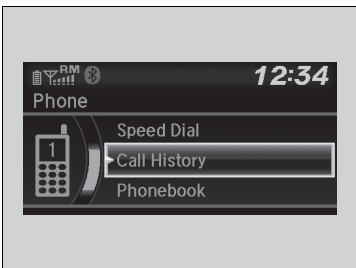

## ▣ Making a Call

Any voice-tagged speed dial entry can be dialed by voice from any screen.

Press the  button and follow the prompts.

The maximum range between your phone and vehicles is 30 feet (10 meters).

Once a call is connected, you can hear the voice of the person you are calling through the audio speakers.

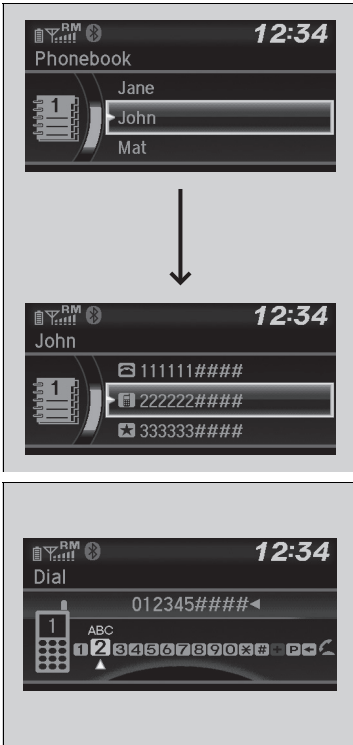

### ■ To make a call using the imported phonebook

When your phone is paired, the contents of its phonebook are automatically imported to HFL.

1. Press the button or the button.
  2. Rotate to select **Phonebook**, then press .
  3. The phonebook is stored alphabetically. Rotate to select the initial, then press .
  4. Rotate to select a name, then press .
  5. Rotate to select a number, then press .
- ▶ Dialing starts automatically.

### ■ To make a call using a phone number

1. Press the button or the button.
  2. Rotate to select **Dial**, then press .
  3. Rotate to select a number, then press .
  4. Rotate to select , then press .
- ▶ Dialing starts automatically.

### ☒ To make a call using the imported phonebook

This function is disabled while the vehicle is moving. However, you can call a stored voice-tagged speed dial number using voice commands.

- ☒ **Limitations for Manual Operation** P. 344
- ☒ **Speed Dial** P. 358

### ☒ To make a call using a phone number

This function is disabled while the vehicle is moving. However, you can call a stored voice-tagged speed dial number using voice commands.

- ☒ **Limitations for Manual Operation** P. 344
- ☒ **Speed Dial** P. 358

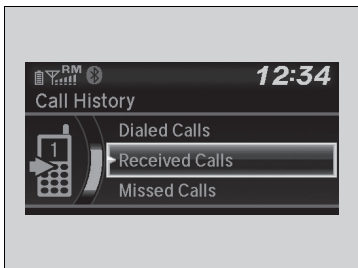

### ■ To make a call using redial

1. Press the button or the button.
2. Rotate to select **Redial**, then press .
- ▶ Dialing starts automatically.

### ■ To make a call using the call history

Call history is stored by **Dialed Calls**, **Received Calls**, and **Missed Calls**.

1. Press the button or the button.
2. Rotate to select **Call History**, then press .
3. Rotate to select **Dialed Calls**, **Received Calls**, or **Missed Calls**, then press .
4. Rotate to select a number, then press .
- ▶ Dialing starts automatically.

### ▶▶ To make a call using redial





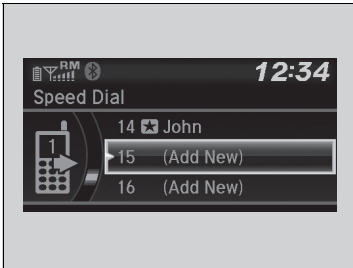

Press and hold the button to redial the last number dialed in your phone's call history.

### ▶▶ To make a call using the call history

The call history appears only when a phone is connected to HFL, and displays the last 20 dialed, received, or missed calls.



### ■ To make a call using a speed dial entry

1. Press the  button or the  button.
2. Rotate  to select **Speed Dial**, then press .
3. Rotate  to select a number, then press .
  - ▶ Dialing starts automatically.

### ☒ To make a call using a speed dial entry

On the **Phone** screen, the first six speed dials on the list can be directly selected by pressing the corresponding audio preset buttons (1-6).

When a voice tag is stored, press the  button and call the number using voice commands.

▶ **Speed Dial** P. 358

Any voice-tagged speed dial entry can be dialed by voice from any screen. Press the  button and follow the prompts.

## Receiving a Call

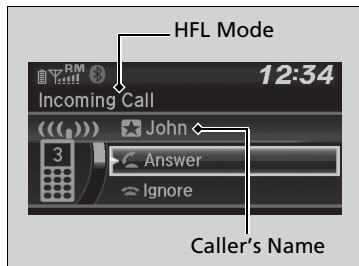

When there is an incoming call, an audible notification sounds and the **Incoming Call** screen appears.

Press the  button to answer the call.

Press the  button to decline or end the call.

## Receiving a Call





### Call Waiting

Press the  button to put the current call on hold to answer the incoming call.

Press the  button again to return to the current call.

Select **Ignore** to ignore the incoming call if you do not want to answer it.

Press the  button if you want to hang up the current call.

You can select the icons on the audio/information screen instead of the  and  buttons. Rotate  to select the icon, then press .

## Options During a Call

The following options are available during a call.



**Swap Call:** Put the current call on hold to answer the incoming call.

**Mute:** Mute your voice.

**Transfer Call:** Transfer a call from HFL to your phone.

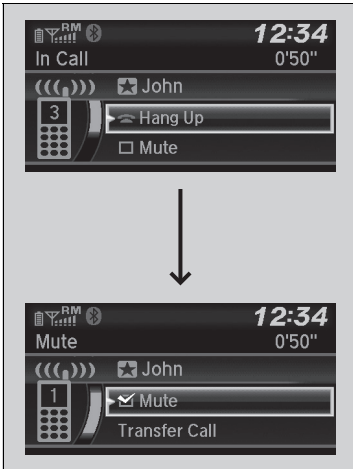
**Dial Tones:** Send numbers during a call. This is useful when you call a menu-driven phone system.



1. To view the available options, press the  button.
2. Rotate  to select the option, then press .
  - ▶ The check box is checked when **Mute** is selected. Select **Mute** again to turn it off.

## Options During a Call

**Dial Tones:** Available on some phones.

## Models with display audio system

The *Bluetooth*® HandsFreeLink® (HFL) allows you to place and receive phone calls using your vehicle's audio system, without handling your mobile phone.

## Using HFL

### HFL Buttons

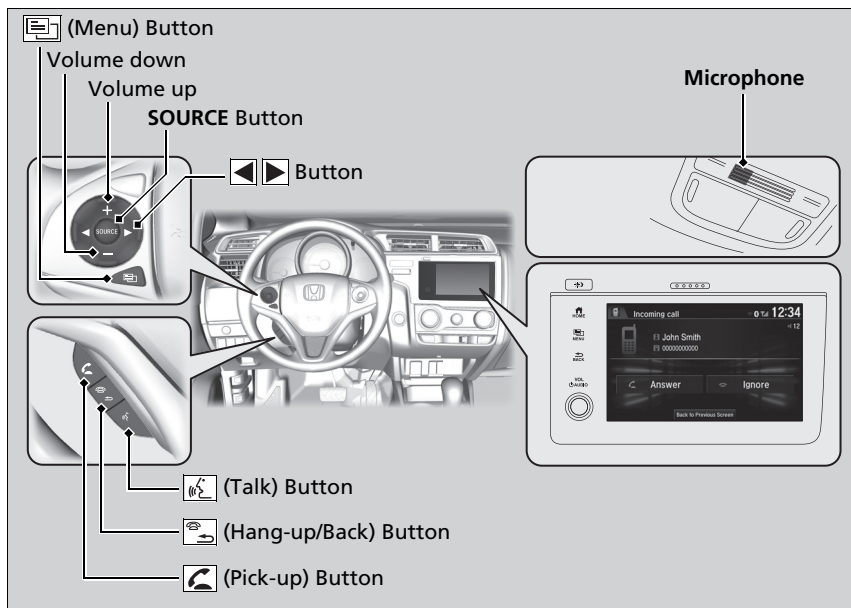

### Bluetooth® HandsFreeLink®

Place your phone where you can get good reception. To use HFL, you need a *Bluetooth*-compatible mobile phone. For a list of compatible phones, pairing procedures, and special feature capabilities:

- U.S.: Visit [automobiles.honda.com/handsfreelink/](http://automobiles.honda.com/handsfreelink/), or call 1-888-528-7876.
- Canada: For more information on smartphone compatibility, call 1-888-528-7876.

To use the system, the **Bluetooth On/Off Status** setting must be **On**. If there is an active connection to Apple CarPlay™, HFL is unavailable.

➤ **Customized Features** P. 328

#### Voice control tips

- Aim the vents away from the ceiling and close the windows, as noise coming from them may interfere with the microphones.
- Press the  button when you want to call a number using a stored voice tag. Speak clearly and naturally after a beep.
- If the microphones pick up voices other than yours, the command may be misinterpreted.
- To change the volume level, use the audio system's volume knob or the remote audio controls on the steering wheel.

Up to five speed dial entries can be displayed among a total of 20 that can be entered. If there is no entry in the system, Speed Dial is disabled.

➤ **Speed Dial** P. 381

Up to five call histories can be displayed among a total of 20 that can be entered. If there is no call history, Call History is disabled.



 **(Pick-up) button:** Press to go directly to the phone screen, or to answer an incoming call.

 **(Hang-up/back) button:** Press to end a call, go back to the previous command, or cancel a command.



 **(Talk) button:** Press to call a number with a stored voice tag.

 **(Menu) button:** Press and hold to display **Speed Dial, Call History, or Redial** on the phone screen.

 **button:** Press to select an item displayed on the phone screen.

**SOURCE button:** Press to call a number listed in the selected item on the phone screen.

To go to the **Phone Menu** screen:

1. Select .
2. Select **Phone** to switch the display to the phone screen.
3. Select .

#### Bluetooth® HandsFreeLink®

##### *Bluetooth®* Wireless Technology

The *Bluetooth®* word mark and logos are registered trademarks owned by *Bluetooth SIG, Inc.*, and any use of such marks by Honda Motor Co., Ltd., is under license. Other trademarks and trade names are those of their respective owners.

##### HFL Limitations

An incoming call on HFL will interrupt the audio system when it is playing. It will resume when the call is ended.

## HFL Status Display

The audio/information screen notifies you when there is an incoming call.

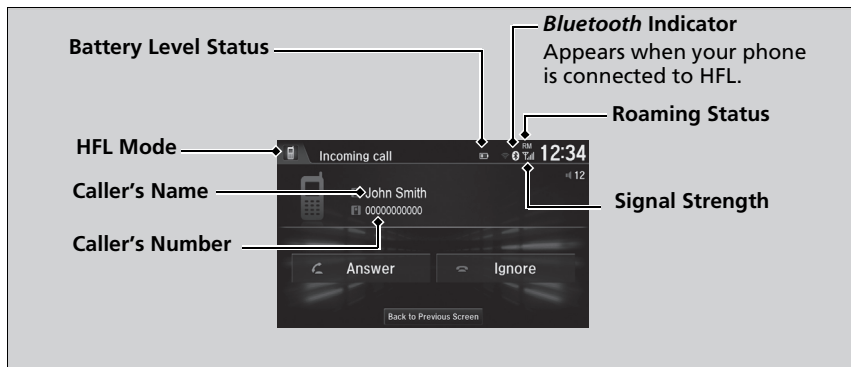

## Limitations for Manual Operation

Certain manual functions are disabled or inoperable while the vehicle is in motion. You cannot select a grayed-out option until the vehicle is stopped.

Only previously stored speed dial entries with voice tags, phonebook names, or numbers can be called using voice commands while the vehicle is in motion.

▶ **Speed Dial** P. 381

## HFL Status Display

The information that appears on the audio/information screen varies between phone models.

You can change the system language.

▶ **Customized Features** P. 328

# HFL Menu

The ignition switch must be in ACCESSORY  or ON \*1 to use the system.

## ■ Phone settings screen



1. Select .
2. Select **Settings**.
3. Select **Phone**.

### ▶ HFL Menu

To use HFL, you must first pair your *Bluetooth*-compatible mobile phone to the system while the vehicle is parked.

Some functions are limited while driving.

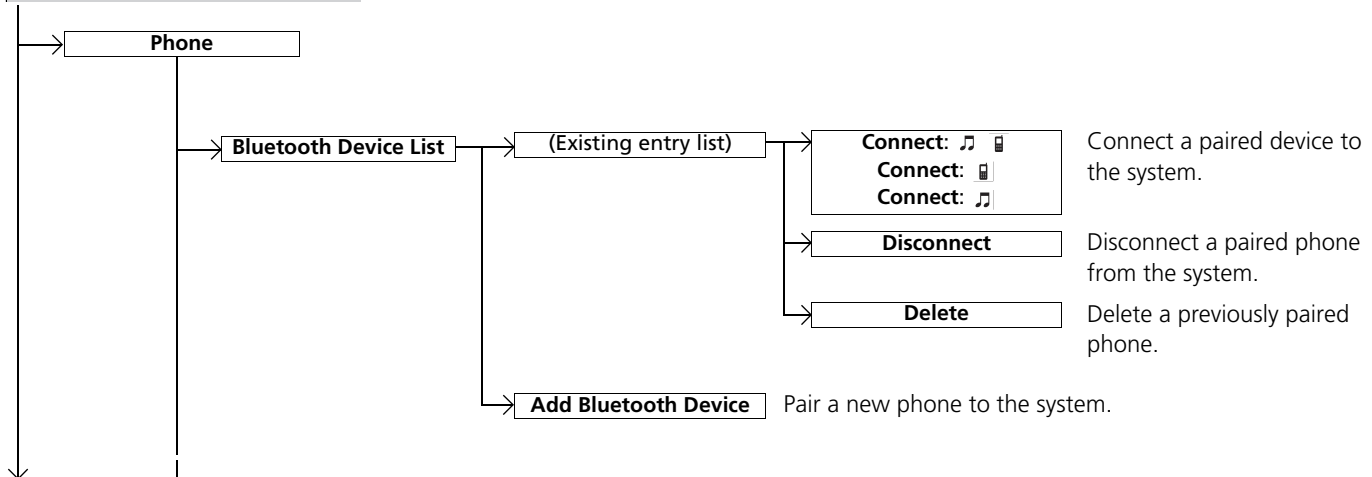

\*1: Models with the keyless access system have an **ENGINE START/STOP** button instead of an ignition switch.

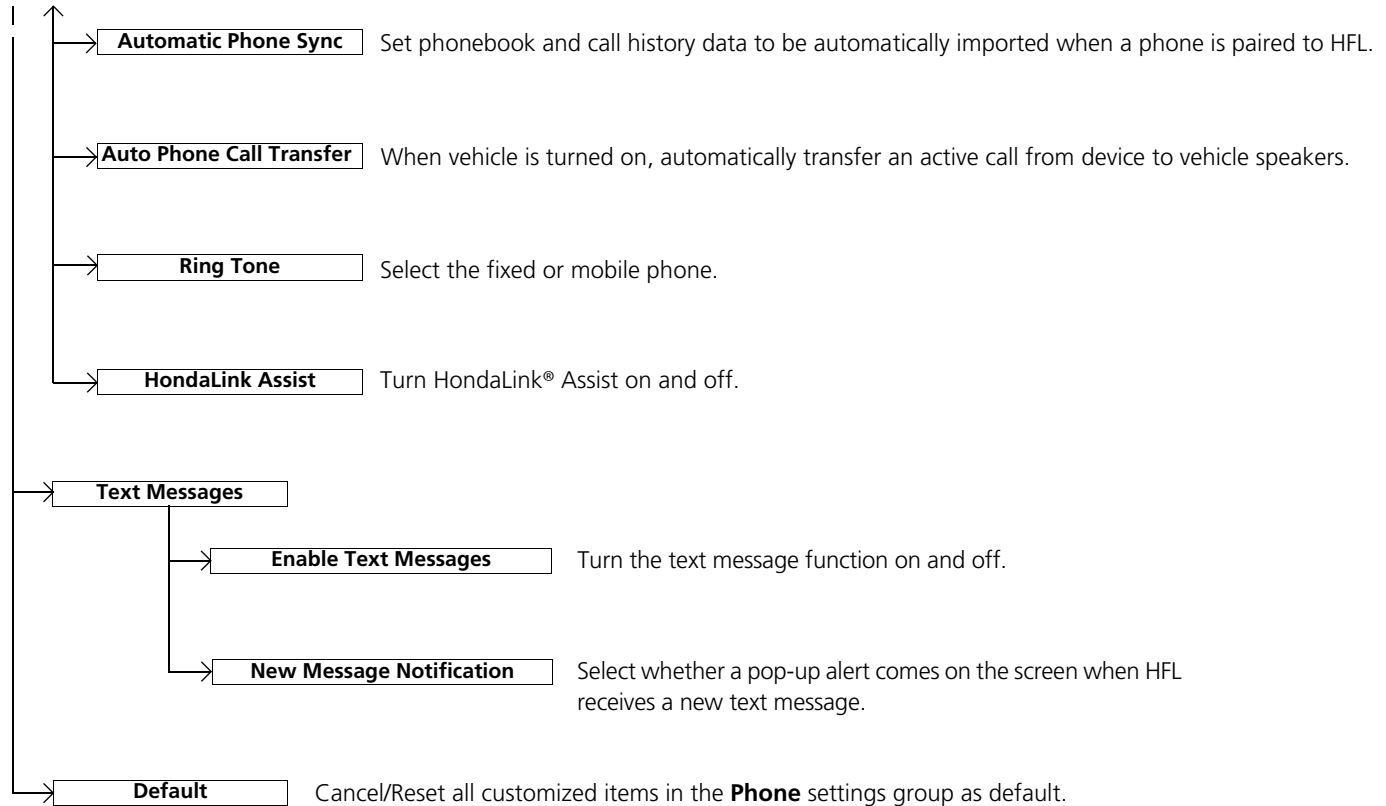

## ■ Phone Menu screen



1. Select .
2. Select **Phone**.
3. Select .

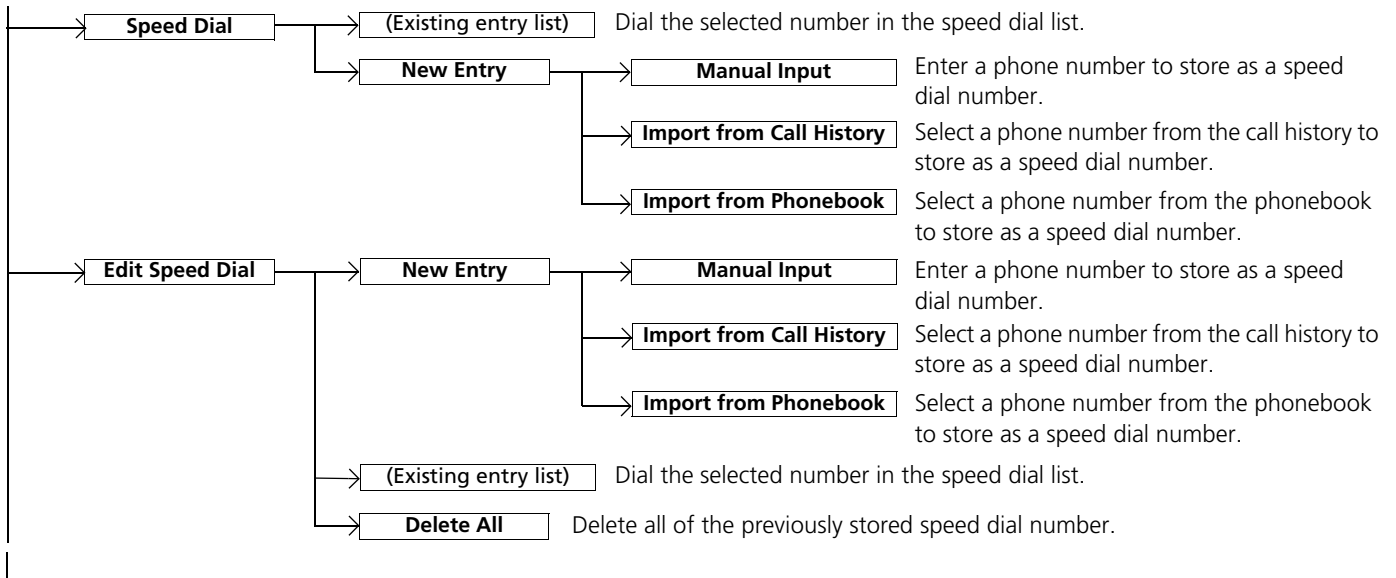

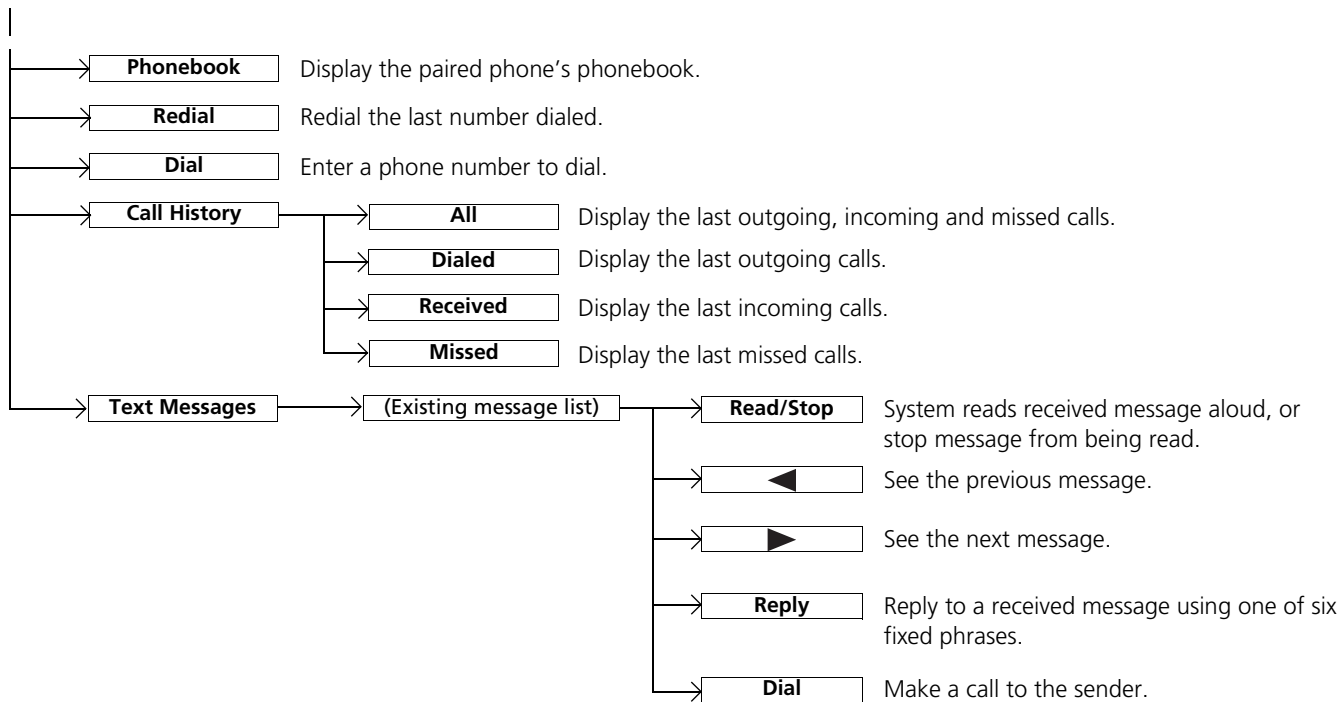

## Phone Setup



### ■ To pair a mobile phone (when there is no phone paired to the system)

1. Select **Phone**.
2. Select **Yes**.
3. Make sure your phone is search or discoverable mode, then select **OK**.
  - ▶ HFL automatically searches for a *Bluetooth*® device.
4. Select your phone when it appears on the list.
  - ▶ If your phone does not appear, you can select **Refresh** to search again.
  - ▶ If your phone still does not appear, select **Phone Not Found** and search for *Bluetooth*® devices using your phone. From your phone, search for **HandsFreeLink**.
5. The system gives you a pairing code on the audio/information screen.
  - ▶ Confirm if the pairing code on the screen and your phone match. This may vary by phone.

## ☒ Phone Setup



Your *Bluetooth*-compatible phone must be paired to the system before you can make and receive hands-free calls.

### Phone Pairing Tips:

- You cannot pair your phone while the vehicle is moving.
- Up to six phones can be paired.
- Your phone's battery may drain faster when it is paired to the system.
- If your phone is not ready for pairing or not found by the system within three minutes, the system will time out and returns to idle.

Once you have paired a phone, you can see it displayed on the screen with one or two icons on the right side.





These icons indicate the following:

-  : The phone can be used with HFL.
-  : The phone is compatible with *Bluetooth*® Audio.

If there is an active connection to Apple CarPlay™, pairing of additional *Bluetooth*-compatible devices is unavailable and **Add Bluetooth Device** is grayed out from the **Bluetooth Device List** screen.



■ **To change the currently paired phone**

1. Go to the phone settings screen.
  - ▶ **Phone settings screen** P. 371
2. Select **Bluetooth Device List**.
3. Select a phone to connect.
  - ▶ HFL disconnects the connected phone and starts searching for another paired phone.
4. Select **Connect**  , **Connect** , or **Connect** .

■ **To change the pairing code setting**

1. Select .
  2. Select **Settings**.
  3. Select **Bluetooth / Wi-Fi**.
  4. Select the **Bluetooth** tab.
  5. Select **Edit Pairing Code**.
6. Select **Random** or **Fixed**.

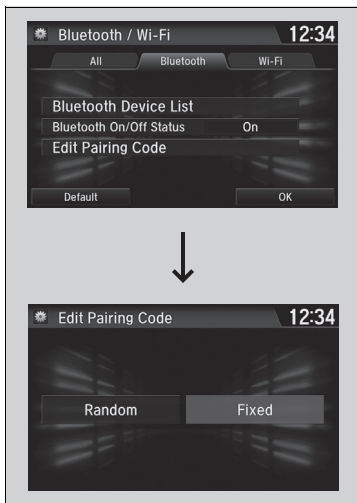

▶▶ To change the currently paired phone

If no other phones are found or paired when trying to switch to another phone, HFL will inform you that the original phone is connected again.

To pair other phones, select **Add Bluetooth Device** from the **Bluetooth Device List** screen.

▶▶ To change the pairing code setting

The default pairing code is **0000** until you change the setting.

To create your own, select **Fixed**, and delete the current code, then enter a new one.

For a randomly generated pairing code each time you pair a phone, select **Random**.



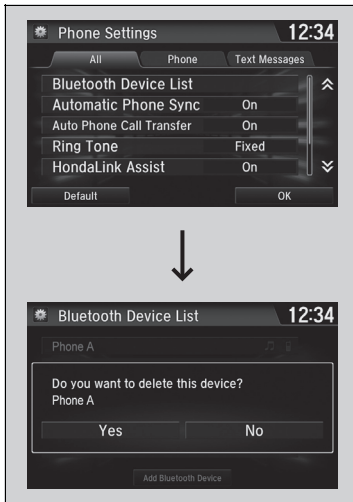

### ■ To delete a paired phone

1. Go to the phone settings screen.
  - ▶ **Phone settings screen** P. 371
2. Select **Bluetooth Device List**.
3. Select a phone you want to delete.
4. Select **Delete**.
5. A confirmation message appears on the screen. Select **Yes**.

## ■ To Set Up Text Message Options

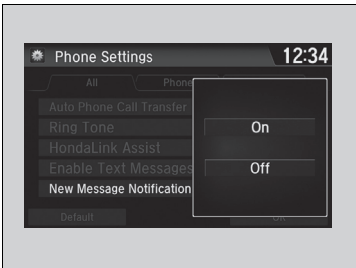
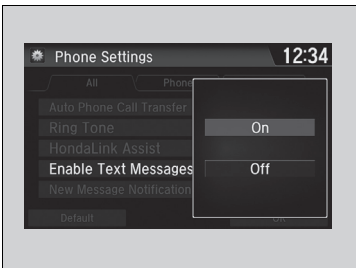

### ■ To turn on or off the text message function

1. Go to the phone settings screen.
  - ▶ **Phone settings screen** P. 371
2. Select **Enable Text Messages**.
  - ▶ A pop-up menu appears on the screen.
3. Select **On** or **Off**.

### ■ To turn on or off the text message notice

1. Go to the phone settings screen.
  - ▶ **Phone settings screen** P. 371
2. Select **New Message Notification**.
  - ▶ A pop-up menu appears on the screen.
3. Select **On** or **Off**.

### ☞ To Set Up Text Message Options

To use the text message function, it may be necessary to set up on your phone.

### ☞ To turn on or off the text message notice

**On:** A pop-up notification comes on every time you receive a new message.

**Off:** The message you receive is stored in the system without notification.

## Automatic Import of Cellular Phonebook and Call History

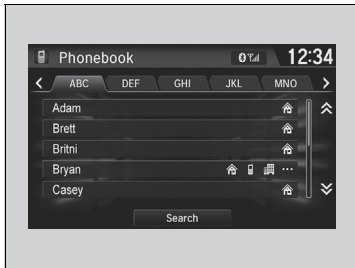

### ■ When Automatic Phone Sync is set to On:

When your phone is paired, the contents of its phonebook and call history are automatically imported to the system.

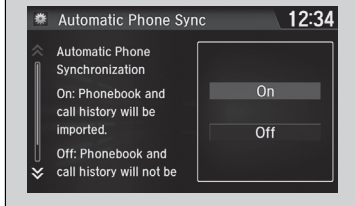
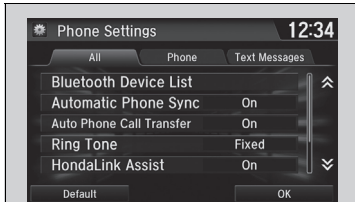

### ■ Changing the Automatic Phone Sync setting

1. Go to the phone settings screen.
  - ▶ Phone settings screen P. 371
2. Select **Automatic Phone Sync**.
3. Select **On** or **Off**.

### ⌘ Automatic Import of Cellular Phonebook and Call History

When you select a name from the list in the cellular phonebook, you can see up to three category icons. The icons indicate what types of numbers are stored for that name.

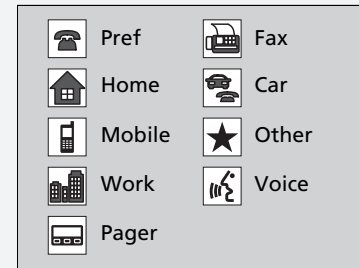

On some phones, it may not be possible to import the category icons to the system.

The phonebook is updated after every connection. Call history is updated after every connection or call.

Continued

## Ring Tone

You can change the ring tone setting.

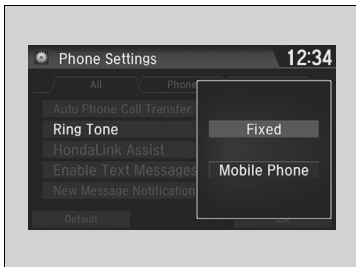

1. Go to the phone settings screen.  
▶ **Phone settings screen** P. 371
2. Select **Ring Tone**.
3. Select **Fixed** or **Mobile Phone**.

## Automatic Transferring

If you get into the vehicle while you are on the phone, the call can be automatically transferred to HFL.

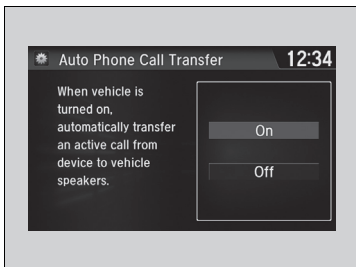

1. Go to the phone setting screen.  
▶ **Phone settings screen** P. 371
2. Select **Auto Phone Call Transfer**.
3. Select **On** or **Off**.

## Ring Tone

**Fixed:** The fixed ring tone sounds from the speakers.  
**Mobile Phone:** For certain connected phones, the ring tone stored in the phone sounds from the speakers.

## Speed Dial

Up to 20 speed dial numbers can be stored per phone.

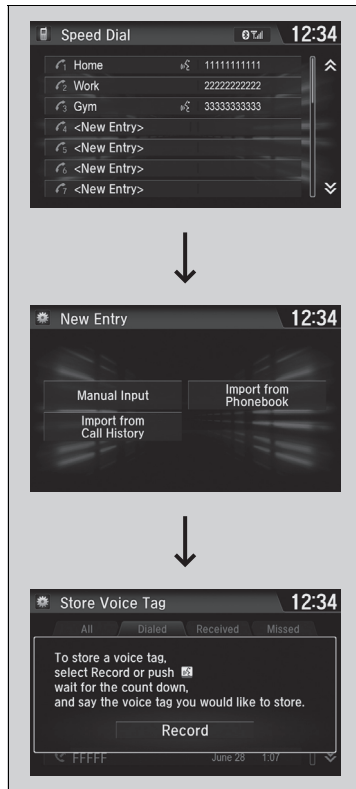

To store a speed dial number:

1. Go to the phone menu screen.

➤ **Phone Menu screen P. 373**

2. Select **Speed Dial**.

3. Select **New Entry**.

4. Select a place to choose a number.

From **Import from Call History**:

▶ Select a number from the call history.

From **Manual Input**:

▶ Input the number manually.

From **Import from Phonebook**:

▶ Select a number from the connected mobile phone's imported phonebook.

5. When the speed dial is successfully stored, you are asked to create a voice tag for the number. Select **Yes** or **No**.

6. Select **Record** to store a voice tag for the speed dial entry.

▶ Using the  button, follow the prompts to store a voice tag for the speed dial entry.

## Speed Dial

When a voice tag is stored, press the  button to call the number using the voice tag. Say the voice tag name.

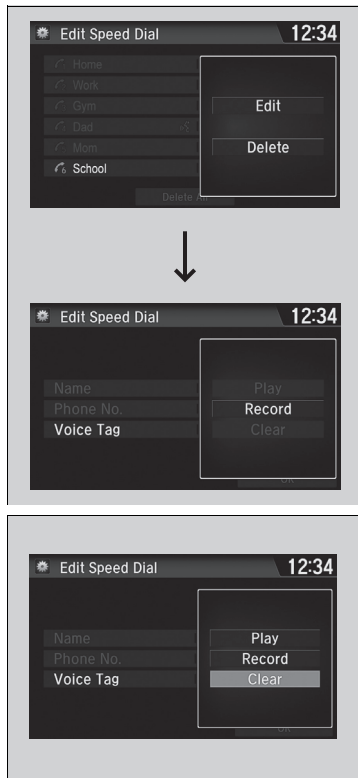

■ **To add a voice tag to a stored speed dial number**

1. Go to the phone menu screen.
  - ▶ **Phone Menu screen** P. 373
2. Select **Edit Speed Dial**.
3. Select an existing speed dial entry.
  - ▶ From the pop-up menu, select **Edit**.
4. Select **Voice Tag**.
  - ▶ From the pop-up menu, select **Record**.
5. Select **Record**, or use the  button, follow the prompts to complete the voice tag.

■ **To delete a voice tag**

1. Go to the phone menu screen.
  - ▶ **Phone Menu screen** P. 373
2. Select **Edit Speed Dial**.
3. Select an existing speed dial entry.
  - ▶ From the pop-up menu, select **Edit**.
4. Select **Voice Tag**.
  - ▶ From the pop-up menu, select **Clear**.
5. A confirmation message appears on the screen. Select **Yes**.

▶▶ Speed Dial

Avoid using duplicate voice tags.  
 Avoid using "home" as a voice tag.  
 It is easier for the system to recognise a longer name.  
 For example, use "John Smith" instead of "John."

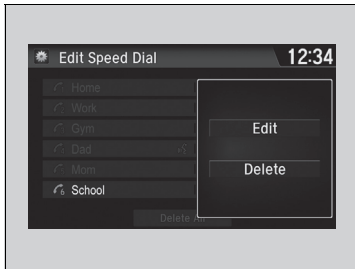

### ■ To edit a speed dial

1. Go to the phone menu screen.
  - ▶ **Phone Menu screen** P. 373
2. Select **Edit Speed Dial**.
3. Select an existing speed dial entry.
  - ▶ From the pop-up menu, select **Edit**.
4. Select a setting you want.

### ■ To delete a speed dial

1. Go to the phone menu screen.
  - ▶ **Phone Menu screen** P. 373
2. Select **Edit Speed Dial**.
3. Select an existing speed dial entry.
  - ▶ From the pop-up menu, select **Delete**.
4. A confirmation message appears on the screen. Select **Yes**.

## Phonebook Phonetic Modification

Add phonetic modifications or a new voice tag to the phone's contact name so that it is easier for HFL to recognize voice commands.

### Phonebook Phonetic Modification

You can store up to 20 phonetic modification items.

#### To add a new voice tag

1. Select .
2. Select **Settings**.
3. Select **System**.
4. Select the **Voice Recog.** tab.
5. Select **Phonebook Phonetic Modification**.
6. Select the phone you want to add phonetic modification to.

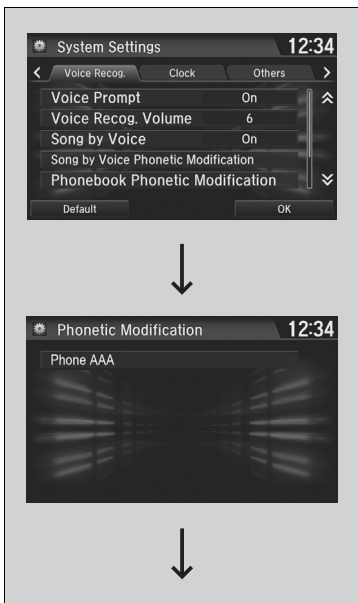



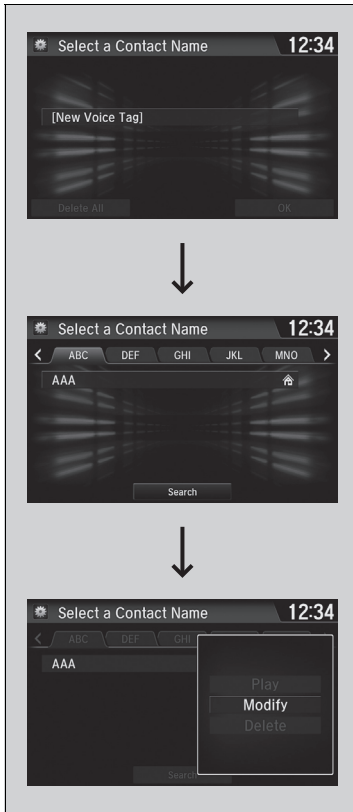

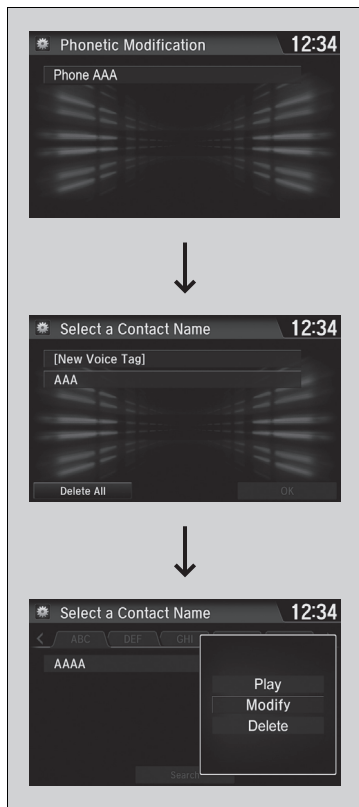

7. Select **New Voice Tag**.
8. Select a contact name you want to add to.
  - ▶ The pop-up menu appears on the screen.
9. Select **Modify**.
10. Using **Record** or the  button, follow the prompts to complete the voice tag.
11. You will receive a confirmation message on the screen, then select **OK**.



■ **To modify a voice tag**

1. Select .
2. Select **Settings**.
3. Select **System**.
4. Select the **Voice Recog.** tab.
5. Select **Phonebook Phonetic Modification**.
6. Select the phone you want to modify phonetic modification.
7. Select a contact name you want to modify.
  - ▶ The pop-up menu appears on the screen.
8. Select **Modify**.
9. Using **Record** or the  button, follow the prompts to complete the voice tag.
10. You will receive a confirmation message on the screen, then select **OK**.

▶▶ Phonebook Phonetic Modification

You can only modify or delete contact names for the currently connected phone.

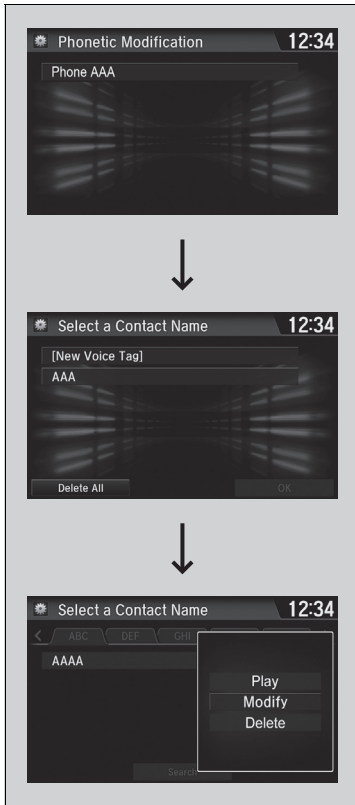

■ **To delete a modified voice tag**

1. Select .
2. Select **Settings**.
3. Select **System**.
4. Select the **Voice Recog.** tab.
5. Select **Phonebook Phonetic Modification**.
6. Select the phone you want to delete phonetic modification.
7. Select a contact name you want to delete.
  - ▶ The pop-up menu appears on the screen.
8. Select **Delete**.
  - ▶ The selected contact name has been selected.
9. Select **OK**.

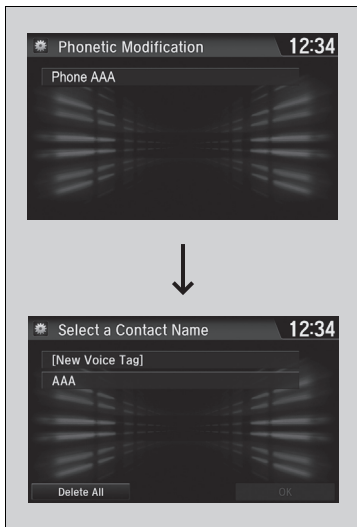

■ To delete all modified voice tags

1. Select .
2. Select **Settings**.
3. Select **System**.
4. Select the **Voice Recog.** tab.
5. Select **Phonebook Phonetic Modification**.
6. Select the phone you want to delete phonetic modification.
  - ▶ The contact name list appears.
7. Select **Delete All**.
8. You will receive a confirmation message on the screen, then select **Yes**.

⌘ Making a Call

Any voice-tagged speed dial entry can be dialed by voice from most screens. Press the  button and say the voice tag name.

Once a call is connected, you can hear the voice of the person you are calling through the audio speakers.

While there is an active connection with Apple CarPlay™, phone calls cannot be made with HandsFreeLink® and are only made from Apple CarPlay™.

■ Making a Call

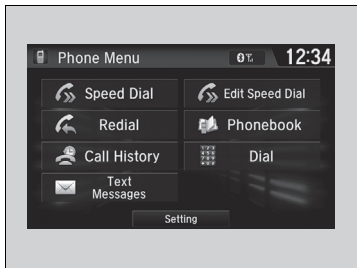

You can make calls by inputting any phone number, or by using the imported phonebook, call history, speed dial entries, or redial.

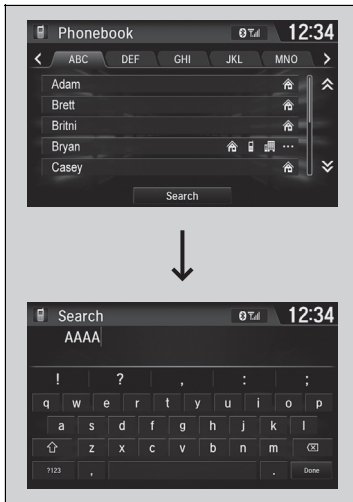

■ **To make a call using the imported phonebook**

1. Go to the phone menu screen.  
▶ **Phone Menu screen** P. 373
2. Select **Phonebook**.
3. Select a name.  
▶ You can also search by letter. Select **Search**.  
▶ Use the keyboard on the touch screen for entering letters.
4. Select a number.  
▶ Dialing starts automatically.

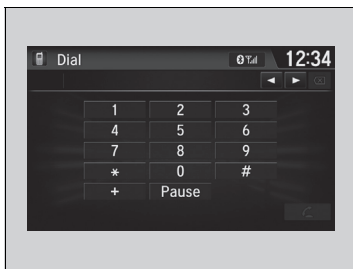

■ **To make a call using a phone number**

1. Go to the phone menu screen.  
▶ **Phone Menu screen** P. 373
2. Select **Dial**.
3. Select a number.  
▶ Use the keyboard on the touch screen for entering numbers.
4. Select .  
▶ Dialing starts automatically.

☒ **To make a call using the imported phonebook**

You can call a stored voice-tagged speed dial number using voice commands.

▶ **Speed Dial** P. 381

☒ **To make a call using a phone number**

You can call a stored voice-tagged speed dial number using voice commands.

▶ **Speed Dial** P. 381

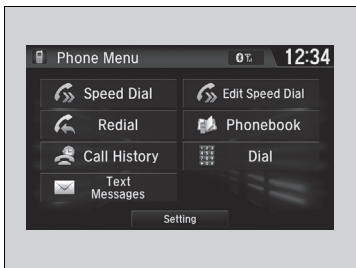

■ **To make a call using redial**

1. Go to the phone menu screen.
  - ▶ **Phone Menu screen** P. 373
2. Select **Redial**.
  - ▶ Dialing starts automatically.

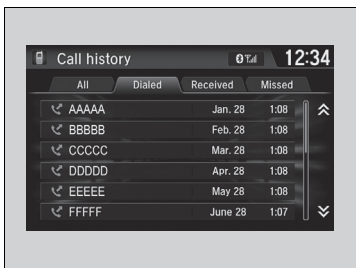

■ **To make a call using the Call History**  
Call history is stored by **All, Dialed, Received, and Missed.**

1. Go to the phone menu screen.
  - ▶ **Phone Menu screen** P. 373
2. Select **Call History**.
3. Select **All, Dialed, Received, or Missed**.
4. Select a number.
  - ▶ Dialing starts automatically.



■ **To make a call using a Speed Dial entry**

1. Go to the phone menu screen.
  - ▶ **Phone Menu screen** P. 373
2. Select **Speed Dial**.
3. Select a number.
  - ▶ Dialing starts automatically.

▶▶ To make a call using redial

Press and hold the  button to redial the last number dialed.

▶▶ To make a call using the Call History

The call history displays the last 20 all, dialed, received, or missed calls. (Appears only when a phone is connected to the system.)

▶▶ To make a call using a Speed Dial entry

When a voice tag is stored, press the  button to call the number using the voice tag.

▶ **Speed Dial** P. 381



Any voice-tagged speed dial entry can be dialed by voice from any screen.

Press the  button and follow the prompts.

## Receiving a Call



When there is an incoming call, an audible notification sounds (if activated) and the **Incoming call** screen appears.

Press the  button to answer the call.  
Press the  button to decline or end the call.

## Options During a Call

The following options are available during a call.

**Mute:** Mute your voice.

**Transfer:** Transfer a call from the system to your phone.

**Touch Tones:** Send numbers during a call. This is useful when you call a menu-driven phone system.



The available options are shown on the lower half of the screen.

Select the option.

- ▶ The mute icon appears when **Mute** is selected. Select **Mute** again to turn it off.

## Receiving a Call

**Call Waiting**

Press the  button to put the current call on hold to answer the incoming call.

Press the  button again to return to the current call.

Select **Ignore** to ignore the incoming call if you do not want to answer it.

Press the  button if you want to hang up the current call.

You can select the icons on the audio/information screen instead of the  and  buttons.

## Options During a Call

**Touch Tones:** Available on some phones.

You can select the icons on the audio/information screen.

## ■ Receiving a Text Message

HFL can display newly received text messages as well as 20 of the most recently received messages on a linked cell phone. Each received message can be read aloud and replied to using a fixed common phrase.



1. A pop-up appears and notifies you of a new text message.
2. Select **Read** to listen to the message.
  - ▶ The text message is displayed. The system automatically starts reading out the message.
3. To discontinue the message read-out, select **Stop**.

## ▣ Receiving a Text Message

The system does not display any received messages while you are driving. You can only hear them read aloud.

The system can only receive messages that are sent as text (SMS) messages. The message sent using the data services will not be displayed in the list.

With some phones, you may be able to display up to 20 most recent text messages.

State or local laws may limit your use of the HFL text message feature. Only use the text message feature when conditions allow you to do so safely.

When you receive a text message for the first time since the phone is paired to HFL, you are asked to turn the **New Message Notification** setting to **On**.

➤ **To turn on or off the text message notice**  
P. 378

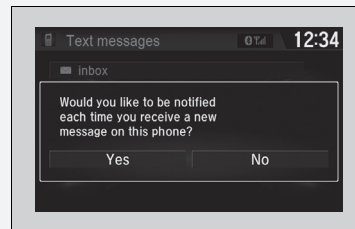



## Displaying Messages

### Folder List



### Message List



### Text Message

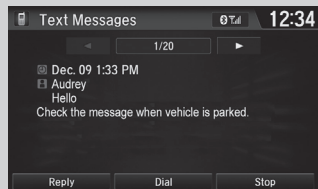



### ■ Displaying text messages

1. Go to the phone menu screen.  
 ▶ **Phone Menu screen** P. 373
2. Select **Text Messages**.  
 ▶ Select a folder if necessary.
3. Select a message.  
 ▶ The text message is displayed. The system automatically starts reading the message aloud.

### ⌘ Displaying Messages

The  icon appears next to an unread message.

If you delete a message on the phone, the message is also deleted in the system. If you send a message from the system, the message goes to your phone's outbox.

To see the previous or next message, select  (previous) or  (next) on the message screen.

Continued



### ■ Read or Stop reading a message

1. Go to the text message screen.
  - ▶ The system automatically starts reading the message aloud.
  - ☑ **Displaying Messages** P. 393
2. Select **Stop** to stop reading.
  - Select **Read** again to start reading the message from the beginning.

### ■ Reply to a message

1. Go to the text message screen.
  - ▶ The system automatically starts reading the message aloud.
  - ☑ **Displaying Messages** P. 393
2. Select **Reply**.
3. Select the reply message.
  - ▶ The pop-up menu appears on the screen.
4. Select **Send** to send the message.
  - ▶ **Complete** appears on the screen when the reply message was successfully sent.

### ☒ Reply to a message

The available fixed reply messages are as follows:

- **Talk to you later, I'm driving.**
- **I'm on my way.**
- **I'm running late.**
- **OK**
- **Yes**
- **No**

You cannot add, edit, or delete reply messages.

Only certain phones receive and send messages when paired and connected. For a list of compatible phones:

- U.S.: Visit [automobiles.honda.com/handsfreelink/](http://automobiles.honda.com/handsfreelink/), or call 1-888-528-7876.
- Canada: For more information on smartphone compatibility, call 1-888-528-7876.



### ■ Making a call to a sender

1. Go to the text message screen.
2. Select **Dial**.

## ■ In Case of Emergency

### ■ Automatic collision notification

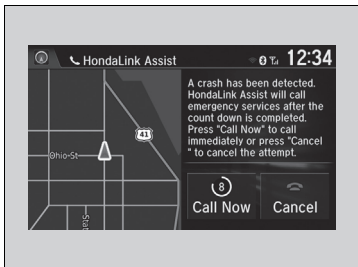

If your vehicle’s airbags deploy or if the unit detects that the vehicle is severely impacted, your vehicle automatically will attempt to connect to the HondaLink® operator. If connected, information about your vehicle, its location, and its condition can be sent to the operator\*1; you also can speak to the operator when connected.

**IMPORTANT:** For vehicles equipped with HondaLink® Assist, owner activation constitutes authorization for Honda to collect information from your vehicle needed to provide the service, and agreement to the Terms of Use at [www.hondalink.com/TermsAndConditions](http://www.hondalink.com/TermsAndConditions). In a crash, HondaLink® Assist will attempt to notify emergency services but NEITHER Honda-PRO NOR ITS SERVICE PROVIDERS GUARANTEE THAT SUCH NOTIFICATION WILL OCCUR.

Honda reserves the right to terminate HondaLink® Assist services at any time or for any reason, and in the future may not be able to provide services due to changes in, or obsolescence of, technology integral to the service or changes in governmental regulation.

\*1 : Depending on your phone and adequate cellular coverage, your vehicle’s location may not be sent to the operator.

## ▶▶ In Case of Emergency

Your vehicle may not be able to connect to the operator if the battery level is low, the line is disconnected, or you do not have adequate cellular coverage.

You cannot use this emergency service when:

- You travel outside the HondaLink® service coverage areas.
- There is a problem with the connecting devices, such as the microphones, speakers, or the unit itself.

You cannot operate other phone-related functions using the screen while talking to the operator. Select **Hang Up** to terminate the connection to your vehicle.

## ▶▶ Automatic collision notification

If the unit fails to connect to the operator, it repeatedly tries until it succeeds.

## ■ To enable notification

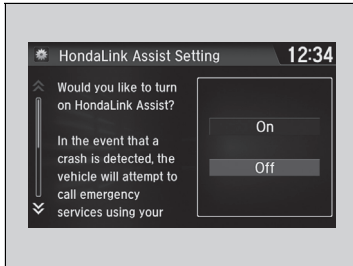

1. Go to the phone settings screen.
  - ▶ **Phone settings screen** P. 371
2. Select **HondaLink Assist**.
  - ▶ A pop-up menu appears on the screen.
3. Select **On** or **Off**.

## ☒ To enable notification

Setting options:

- **On:** Notification is available.
- **Off:** Disable the feature.



# Driving

This chapter discusses driving and refueling.



## Before Driving

Driving Preparation .....	400
Maximum Load Limit.....	403

## Towing a Trailer

Towing Your Vehicle .....	406
---------------------------	-----

## When Driving

### Models without smart entry system

Starting the Engine .....	409
---------------------------	-----

### Models with smart entry system

Starting the Engine .....	411
Precautions While Driving.....	415
Continuously Variable Transmission* .....	416

### Continuously variable transmission models without paddle shifters

Shifting .....	417
----------------	-----

### Continuously variable transmission models with paddle shifters

Shifting .....	419
----------------	-----

### Manual transmission models

Shifting .....	423
ECON Button* .....	427
Cruise Control* .....	428
Front Sensor Camera* .....	431
Adaptive Cruise Control (ACC)* .....	433
Road Departure Mitigation (RDM) System* .....	447
Lane Keeping Assist System (LKAS)* .....	452
Vehicle Stability Assist® (VSA®), aka Electronic Stability Control (ESC), System .....	459
LaneWatch™* .....	461
Tire Pressure Monitoring System (TPMS).....	463

Tire Pressure Monitoring System (TPMS) - Required Federal Explanation .....	466
---	-----

## Braking

Brake System .....	468
Anti-lock Brake System (ABS).....	470
Brake Assist System .....	471
Collision Mitigation Braking System™ (CMBS™)* .....	472

## Parking Your Vehicle

When Stopped .....	480
--------------------	-----

## Multi-View Rear Camera

How to Refuel .....	481
---------------------	-----

## Refueling

Fuel Information .....	483
How to Refuel .....	484

## Fuel Economy and CO<sub>2</sub> Emissions

Improving Fuel Economy and Reducing CO <sub>2</sub> Emissions .....	486
---	-----

\* Not available on all models

## Driving Preparation

Check the following items before you start driving.

### Exterior Checks

- Make sure there are no obstructions on the windows, door mirrors, exterior lights, or other parts of the vehicle.
  - ▶ Remove any frost, snow, or ice.
  - ▶ Remove any snow on the roof, as this can slip down and obstruct your field of vision while driving. If frozen solid, remove ice once it has softened.
  - ▶ When removing ice from around the wheels, be sure not to damage the wheel or wheel components.
- Make sure the hood is securely closed.
  - ▶ If the hood opens while driving, your front view will be blocked.
- Make sure the tires are in good condition.
  - ▶ Check air pressure and check for damage and excessive wear.
    - ✦ **Checking and Maintaining Tires** P. 522
- Make sure there are no people or objects behind or around the vehicle.
  - ▶ There are blind spots from the inside.

### Exterior Checks

#### NOTICE

When doors are frozen shut, use warm water around the door edges to melt any ice. Do not try to force them open, as this can damage the rubber trim around the doors. When done, wipe dry to avoid further freezing.

Do not pour warm water into the key cylinder. You will be unable to insert the key if the water freezes in the hole.

Heat from the engine and exhaust can ignite flammable materials left under the hood, causing a fire. If you've parked your vehicle for an extended period, inspect and remove any debris that may have collected, such as dried grass and leaves that have fallen or have been carried in for use as a nest by a small animal. Also check under the hood for leftover flammable materials after you or someone else has performed maintenance on your vehicle.



## Interior Checks

- Store or secure all items on board properly.
  - ▶ Carrying too much cargo, or improperly storing it, can affect your vehicle's handling, stability, stopping distance, and tires, and make it unsafe.
    - ✦ **Maximum Load Limit** P. 403
- Do not pile items higher than the seat height.
  - ▶ They can block your view and may be thrown forward in the event of sudden braking.
- Do not place anything in the front seat footwells. Make sure to secure the floor mat\*.
  - ▶ An object or unsecured floor mat can interfere with your brake and accelerator pedal operation while driving.
- If you have any animals on board, do not let them move around in the vehicle.
  - ▶ They may interfere with driving and a crash could occur.
- Securely close and lock all doors and the tailgate.
  - ✦ **Locking/Unlocking the Doors from the Inside** P. 135
- Adjust your seating position properly.
  - ▶ Adjust the head restraint, too.
    - ✦ **Adjusting the Seats** P. 175
    - ✦ **Adjusting the front head restraint positions** P. 182
- Adjust the mirrors and steering wheel properly for your driving.
  - ▶ Adjust them while sitting in the proper driving position.
    - ✦ **Adjusting the Mirrors** P. 174
    - ✦ **Adjusting the Steering Wheel** P. 173

## Interior Checks

The headlight aim is set by the factory, and does not need to be adjusted. However, if you regularly carry heavy items in the cargo area, have the aiming readjusted at a dealer or by a qualified technician.

- Be sure items placed on the floor behind the front seats cannot roll under the seats.
  - ▶ They can interfere with the driver's ability to operate the pedals, the operation of the seats, or the operation of the sensors under the seats.
- Everyone in the vehicle must fasten their seat belt.
  - 📄 **Fastening a Seat Belt** P. 40
- Make sure that the indicators in the instrument panel come on when you start the vehicle, and go off soon after.
  - ▶ Always have a dealer check the vehicle if a problem is indicated.
    - 📄 **Indicators** P. 76

## Maximum Load Limit

The maximum load for your vehicle is 850 lbs (385 kg).  
See the Tire and Loading Information label attached to the driver's doorjamb.

Label Example

TIRE	SIZE	COLD TIRE PRESSURE	SEE OWNER'S MANUAL FOR ADDITIONAL INFORMATION
FRONT	XXXX/XXXX XXX	XXXKPA, XXPSI	
REAR	XXXX/XXXX XXX	XXXKPA, XXPSI	
SPARE	XXXX/XXXX XXX	XXXKPA, XXPSI	

This figure includes the total weight of all occupants, cargo, and accessories, and the tongue load if you are towing a trailer.

Steps for Determining Correct Load Limit -

- (1) Locate the statement "The combined weight of occupants and cargo should never exceed XXX kg or XXX lbs." on your vehicle's placard.
- (2) Determine the combined weight of the driver and passengers that will be riding in your vehicle.
- (3) Subtract the combined weight of the driver and passengers from XXX kg or XXX lbs.
- (4) The resulting figure equals the available amount of cargo and luggage load capacity. For example, if the "XXX" amount equals 1,400 lbs. and there will be five 150 lb. passengers in your vehicle, the amount of available cargo and luggage load capacity is 650 lbs.  
(1,400 - 750 (5 x 150) = 650 lbs.)

Continued

### Maximum Load Limit

## ⚠ WARNING

Overloading or improper loading can affect handling and stability and cause a crash in which you can be hurt or killed.

Follow all load limits and other loading guidelines in this manual.

Gross Vehicle Weight Rating (GVWR):

The maximum allowable weight of the vehicle, all occupants, all accessories, all cargo, and the tongue load.

📖 Specifications P. 574

Gross Axle Weight Rating (GAWR):

The maximum allowable weight of the vehicle axle.

📖 Specifications P. 574

- (5) Determine the combined weight of luggage and cargo being loaded on the vehicle. That weight may not safely exceed the available cargo and luggage load capacity calculated in step 4.
- (6) If your vehicle will be towing a trailer, load from your trailer will be transferred to your vehicle. Consult this manual to determine how this reduces the available cargo and luggage load capacity of your vehicle.

In addition, the total weight of the vehicle, all occupants, accessories, cargo, and trailer tongue load must not exceed the Gross Vehicle Weight Rating (GVWR) or the Gross Axle Weight Rating (GAWR). Both are on a label on the driver's doorjamb.

▶▶ Maximum Load Limit

Towing a Trailer:

See Towing a Trailer to determine whether your vehicle is designed to tow a trailer.

▶▶ **Towing a Trailer** P. 405

Load Limits Example

Example1



Max Load  
850 lbs  
(385 kg)



Passenger Weight  
150 lbs x 2 = 300 lbs  
(68 kg x 2 = 136 kg)



Cargo Weight  
550 lbs  
(249 kg)

Example2



Max Load  
850 lbs  
(385 kg)



Passenger Weight  
150 lbs x 5 = 750 lbs  
(68 kg x 5 = 340 kg)



Cargo Weight  
100 lbs  
(45 kg)

## Towing a Trailer

---

Your vehicle is not designed to tow a trailer. Attempting to do so can void your warranties.

## Towing Your Vehicle

### Continuously variable transmission models

Your vehicle is not designed to be towed behind a motorhome. If your vehicle needs to be towed in an emergency, refer to the emergency towing information.

➤ **Emergency Towing** P. 569

### Manual transmission models

Your vehicle can be towed behind a motorhome.

### When Your Vehicle is Towed Behind a Motorhome

Perform the following procedure before towing your vehicle.

1. Shift to **N**.
2. Release the parking brake.
3. Turn the ignition switch to ACCESSORY **I**\*1.
  - ▶ Make sure the steering wheel does not lock.
4. Turn off all the electric devices. Do not use any accessory power sockets.
  - ▶ This can prevent the battery from running down.

### » Towing Your Vehicle

Do not exceed 65 mph (100 km/h).

Consult your towing parts sales or rental agency if any other items are recommended or required for your towing situation.

\*1 : Models with the smart entry system have an **ENGINE START/STOP** button instead of an ignition switch.

## ■ Extended Towing

If you tow more than eight hours in one day, you should repeat the “When Your Vehicle is Towed Behind a Motorhome” procedure from the previous page at least every eight hours.

You also need to perform the following procedure to prevent the battery from running down.

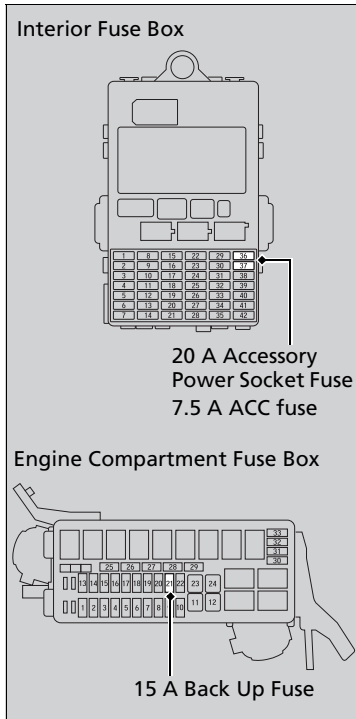

### Models without smart entry system

1. Remove the 20 A Front ACC Socket and 7.5 A ACC fuses. These fuses are located in the interior fuse box.
  - **Interior Fuse Boxes** P. 566
2. Remove the 15 A Back Up Main fuse. This fuse is located in the engine compartment fuse box.
  - **Engine Compartment Fuse Box** P. 564
3. Store the fuses in a safe place so you do not lose them.
  - ▶ Make sure to reinstall the fuses before you start driving your vehicle.
4. Shift to **N**.
5. Turn the ignition switch to ACCESSORY **I**.
  - ▶ Make sure the steering wheel does not lock.

### ▶ Towing Your Vehicle

Make sure to reinstall the fuses before you start driving your vehicle.

Continued

### Interior Fuse Box

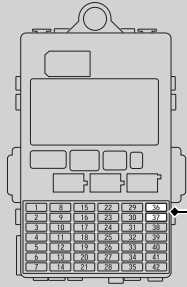

20 A Accessory  
Power Socket Fuse  
7.5 A ACC fuse

### Engine Compartment Fuse Box

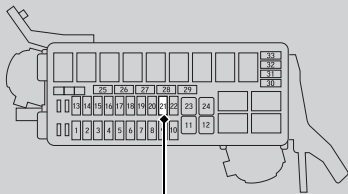

15 A Back Up Fuse

### Models with smart entry system

1. Remove the 20 A Front ACC Socket and 7.5 A ACC fuses. These fuses are located in the interior fuse box.
  - **Interior Fuse Boxes** P. 566
2. Remove the 15 A Back Up Main fuse. This fuse is located in the engine compartment fuse box.
  - **Engine Compartment Fuse Box** P. 564
3. Store the fuses in a safe place so you do not lose them.
  - Make sure to reinstall the fuses before you start driving your vehicle.
4. Push the **ENGINE START/STOP** button without depressing the clutch pedal.
  - The indicator on the **ENGINE START/STOP** button blinks.
5. Touch the center of the **ENGINE START/STOP** button with the **H** logo on the smart entry remote while the indicator is blinking.
  - The indicator stop blinking, then stays on.
6. Shift to **N**.
7. Push the **ENGINE START/STOP** button once without depressing the clutch pedal.
  - Make sure the steering wheel does not lock.



Models without smart entry system

## Starting the Engine

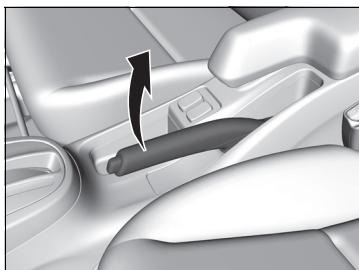

1. Make sure the parking brake is applied.

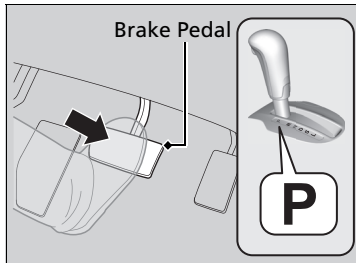

### Continuously variable transmission models

2. Check that the transmission is in **P**, then depress the brake pedal.
  - ▶ Although it is possible to start the vehicle in **N**, it is safer to start it in **P**.

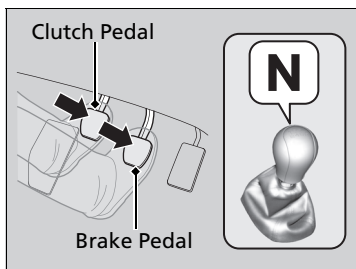

### Manual transmission models

2. Check that the transmission is in **N**. Then depress the brake pedal with your right foot, and the clutch pedal with your left foot.
  - ▶ The clutch pedal must be fully depressed to start the engine.

### Starting the Engine

Keep your foot firmly on the brake pedal when starting the engine.

The engine is harder to start in cold weather and in thinner air found at altitudes above 8,000 feet (2,400 meters).

When starting the engine in cold weather, turn off all electrical accessories such as the lights, heating and cooling\* system, and rear defogger in order to reduce battery drain.

If you live in a region where winter is extremely cold, an engine block heater will improve starting and warming of the engine. Consult a dealer for details.

If the exhaust system sounds abnormal or you can smell exhaust gas inside the vehicle, have your vehicle checked by a dealer. There may be a problem with the engine or exhaust system.

\* Not available on all models

Continued

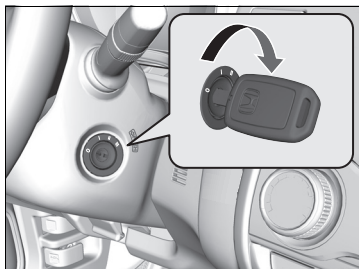

3. Turn the ignition switch to START **III** without depressing the accelerator pedal.

## Starting to Drive

### Continuously variable transmission models

1. Keeping your right foot on the brake pedal, release the parking brake. Check that the parking brake and brake system indicator has gone off.  
    ▶ **Parking Brake** P. 468
2. Put the shift lever in **D**. Select **R** when reversing.
3. Gradually release the brake pedal and gently depress the accelerator pedal to pull away.

### Hill start assist system

Hill start assist keeps the brake engaged briefly to help prevent the vehicle from rolling on inclines as you move your foot from the brake pedal to the accelerator.

### Manual transmission models

Depress the clutch pedal, and shift to one of the forward gears when facing uphill, or **R** when facing downhill, then release the brake pedal.

### Continuously variable transmission models

Move the shift lever to **D**, **S**, or **L** when facing uphill, or **R** when facing downhill, then release the brake pedal.

### Starting the Engine

Do not hold the key in START **III** for more than 10 seconds.

- If the engine does not start right away, wait for at least 30 seconds before trying again.
- If the engine starts, but then immediately stops, wait at least 30 seconds before repeating step 3 while gently depressing the accelerator pedal. Release the accelerator pedal once the engine starts.

The immobilizer system protects your vehicle from theft. If an improperly coded device is used, the engine's fuel system is disabled.

▶ **Immobilizer System** P. 148

### Hill start assist system

Hill start assist may not prevent the vehicle from rolling downhill on a very steep or slippery slope, and does not operate on small inclines.

Hill start assist is not a replacement for the parking brake.

Hill start assist will operate even when VSA® is switched off.

Models with smart entry system

## Starting the Engine

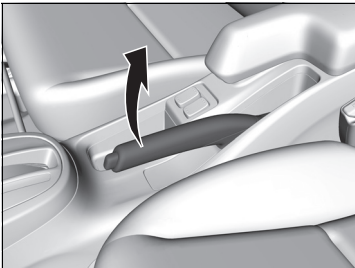

1. Make sure the parking brake is applied.

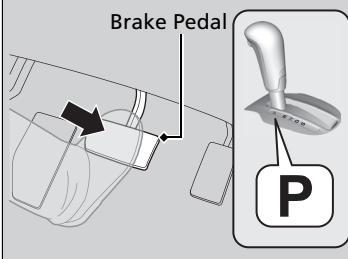

**Continuously variable transmission models**

2. Check that the transmission is in **P**, then depress the brake pedal.
  - ▶ Although it is possible to start the vehicle in **N**, it is safer to start it in **P**.

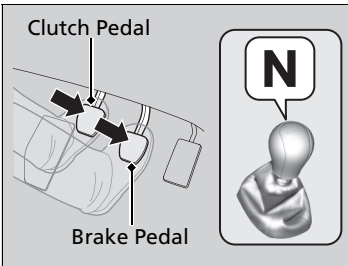

**Manual transmission models**

2. Check that the transmission is in **N**. Then depress the brake pedal with your right foot, and the clutch pedal with your left foot.
  - ▶ The clutch pedal must be fully depressed to start the engine.

▶▶ Starting the Engine

Keep your foot firmly on the brake pedal when starting the engine.

The engine is harder to start in cold weather and in thinner air found at altitudes above 8,000 feet (2,400 meters).

When starting the engine in cold weather, turn off all electrical accessories such as the lights, heating and cooling system/climate control system, and rear defogger in order to reduce battery drain.

If you live in a region where winter is extremely cold, an engine block heater will improve starting and warming of the engine. Consult a dealer for details.

If the exhaust system sounds abnormal or you can smell exhaust gas inside the vehicle, have your vehicle checked by a dealer. There may be a problem with the engine or exhaust system.

The immobilizer system protects your vehicle from theft. If an improperly coded device is used, the engine's fuel system is disabled.

▶ **Immobilizer System** P. 148

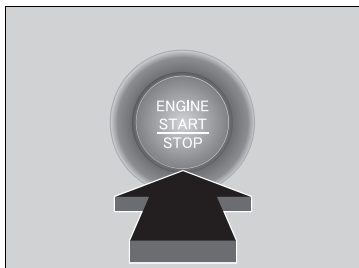

3. Press the **ENGINE START/STOP** button without depressing the accelerator pedal.

#### ▶▶ Starting the Engine

Bring the smart entry remote close to the **ENGINE START/STOP** button if the battery in the smart entry remote is weak.

▶ **If the Smart Entry Remote Battery is Weak**  
P. 553

The engine may not start if the smart entry remote is subjected to strong radio waves.

Do not hold the **ENGINE START/STOP** button to start the engine.  
If the engine does not start, wait at least 30 seconds before trying again.

## Stopping the Engine

You can turn the engine off when the vehicle is completely stopped.

### Continuously variable transmission models

1. Put the transmission into to **P**.
2. Press the **ENGINE START/STOP** button.

### Manual transmission models

- If the transmission is in **N**, press the **ENGINE START/STOP** button.
- If the transmission is in any gear other than **N**, depress the clutch pedal, then press the **ENGINE START/STOP** button.

## Starting to Drive

### Continuously variable transmission models

1. Keeping your right foot on the brake pedal, release the parking brake. Check that the parking brake and brake system indicator has gone off.  
➤ **Parking Brake** P. 468
2. Put the shift lever in **D**. Select **R** when reversing.
3. Gradually release the brake pedal and gently depress the accelerator pedal to pull away.

### ■ Hill start assist system

Hill start assist keeps the brake engaged briefly to help prevent the vehicle from rolling on inclines as you move your foot from the brake pedal to the accelerator.

#### Manual transmission models

Depress the clutch pedal, and shift to one of the forward gears when facing uphill, or **R** when facing downhill, then release the brake pedal.

#### Continuously variable transmission models

Move the shift lever to **D** or **S** when facing uphill, or **R** when facing downhill, then release the brake pedal.

#### ⓘ Hill start assist system

Hill start assist may not prevent the vehicle from rolling downhill on a very steep or slippery slope, and does not operate on small inclines.

Hill start assist is not a replacement for the parking brake.

Hill start assist will operate even when VSA® is switched off.

## Precautions While Driving

### In Rain

Avoid driving in deep water and on flooded roads. This can damage the engine or driveline, or cause electrical component failure.

### Precautions While Driving

#### NOTICE

Do not operate the shift lever while pressing the accelerator pedal. You could damage the transmission.

#### NOTICE

If you repeatedly turn the steering wheel at an extremely low speed, or hold the steering wheel in the full left or right position for a while, the electric power steering (EPS) system heats up. The system goes into a protective mode, and limits its performance. The steering wheel becomes harder and harder to operate. Once the system cools down, the EPS system is restored. Repeated operation under these conditions can eventually damage the system.

If the ignition switch is turned to ACCESSORY **I**\*1 while driving, the engine will shut down and all steering and brake power assist functions will stop, making it difficult to control the vehicle.

Do not put the transmission into **N**, as you will lose engine braking (and acceleration) performance.

During the first 600 miles (1,000 km) of operation, avoid sudden acceleration or full throttle operation so as to not damage the engine or powertrain.

Avoid hard braking for the first 200 miles (300 km). You should also follow this when the brake pads are replaced.

\*1: Models with the smart entry system have an **ENGINE START/STOP** button instead of an ignition switch.

## Other Precautions

If there is a strong impact with something under the vehicle, stop in a safe location. Check the underside of the vehicle for damage or any fluid leaks.

## Continuously Variable Transmission \*

### Creeping

The engine runs at a higher idle speed and creeping increases. Keep the brake pedal firmly depressed when stopped.

### Kickdown

Quickly depressing the accelerator pedal while driving uphill may cause the transmission to drop to a lower ratio, unexpectedly increasing vehicle speed. Depress the accelerator pedal carefully, especially on slippery roads and curves.

## Precautions While Driving

### NOTICE

The following can damage the under spoiler:

- Parking the vehicle by a parking block
- Parallel parking along the road shoulder
- Driving towards the bottom of a hill
- Driving up or down to a different surface level (such as a road shoulder)
- Driving on a rutted or bumpy road
- Driving on a road with potholes.



Continuously variable transmission models without paddle shifters

## Shifting

Change the shift position in accordance with your driving needs.

### ■ Shift lever positions

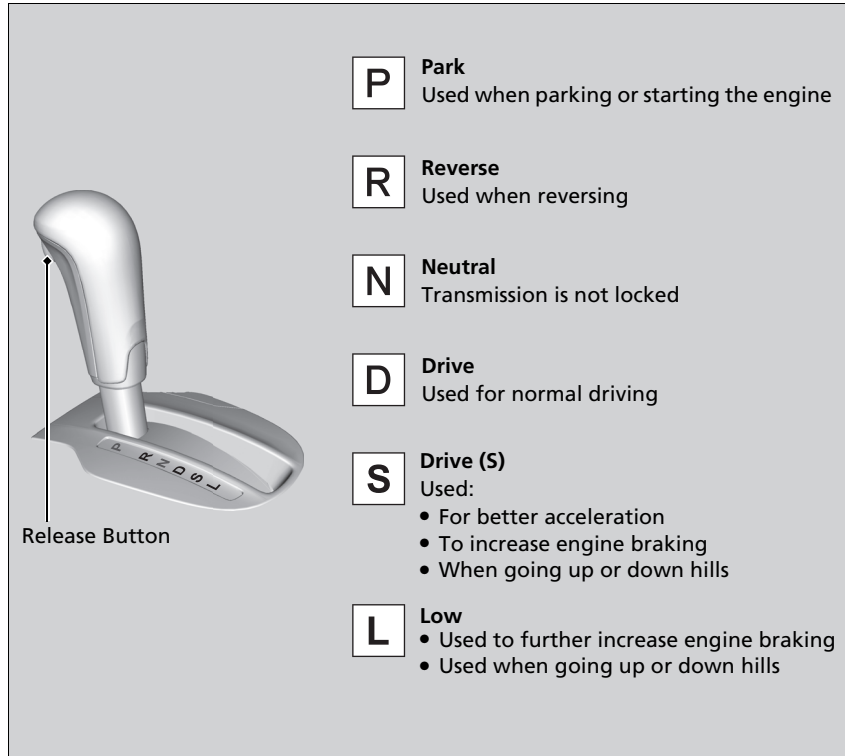

\*1: Models with the smart entry system have an **ENGINE START/STOP** button instead of an ignition switch.

### ▶▶ Shifting

You cannot turn the ignition switch to LOCK [0]\*1 and remove the key unless the shift lever is in [P].

The vehicle may move forward very slightly even in [N] while the engine is cold. Depress the brake pedal firmly and, when necessary, apply the parking brake.

When shifting positions in extremely low temperatures (-22°F/-30°C), there may be a short delay before the shift position is displayed. Always confirm you are in the correct shift position before driving.

## Shift Lever Operation

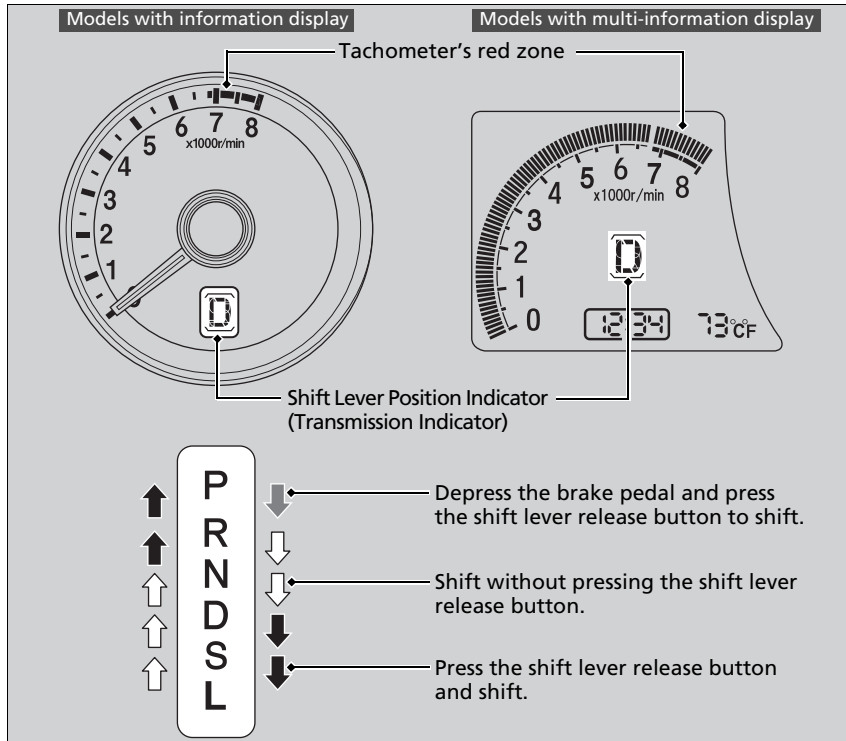

## Shift Lever Operation

### NOTICE

When you change the shift lever from **D** to **R** and vice versa, come to a complete stop and keep the brake pedal depressed. Operating the shift lever before the vehicle has come to a complete standstill can damage the transmission.

Use the shift lever position indicator to check the lever position before pulling away.

If the transmission indicator blinks when driving, in any shift position, there is a problem with the transmission.

Avoid sudden acceleration and have the transmission checked by a dealer as soon as possible.

The fuel supply may be cut off if you drive at engine speeds in or over the tachometer red zone (engine speed limit). If this happens, you may experience a slight jolt.

It may not be possible to operate the shift lever if the brake pedal is applied while the shift lever release button is held down.

Depress the brake pedal first.

Continuously variable transmission models with paddle shifters

## Shifting

Change the shift position in accordance with your driving needs.

### ■ Shift lever positions

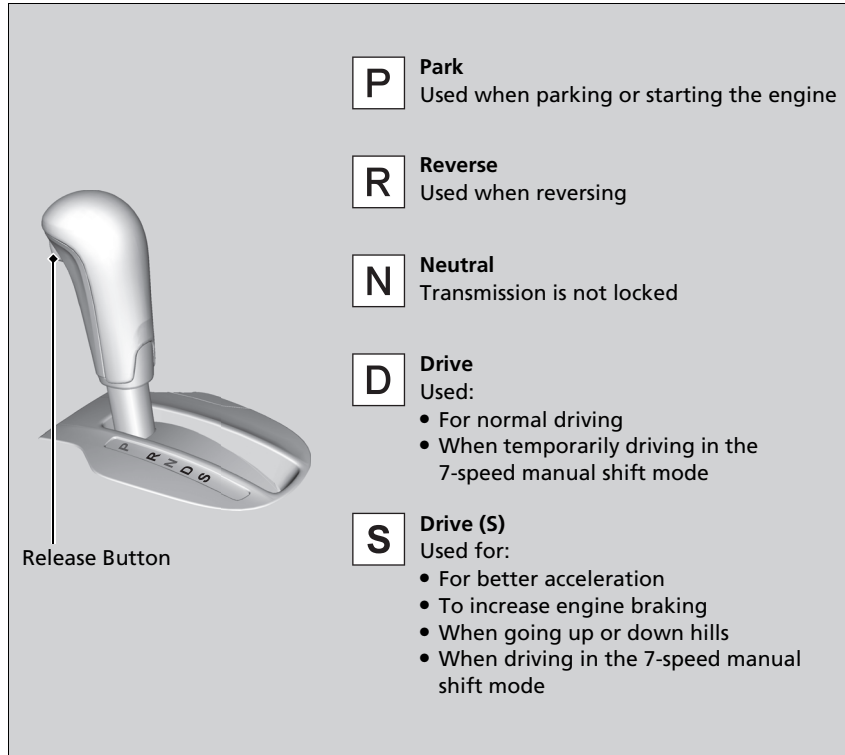

\*1: Models with the smart entry system have an **ENGINE START/STOP** button instead of an ignition switch.

### ▶▶ Shifting

You cannot turn the ignition switch to LOCK [0]\*1 and remove the key unless the shift lever is in [P].

The vehicle may move forward very slightly even in [N] while the engine is cold. Depress the brake pedal firmly and, when necessary, apply the parking brake.

When shifting positions in extremely low temperatures (-22°F/-30°C), there may be a short delay before the shift position is displayed. Always confirm you are in the correct shift position before driving.

Continued

## Shift Lever Operation

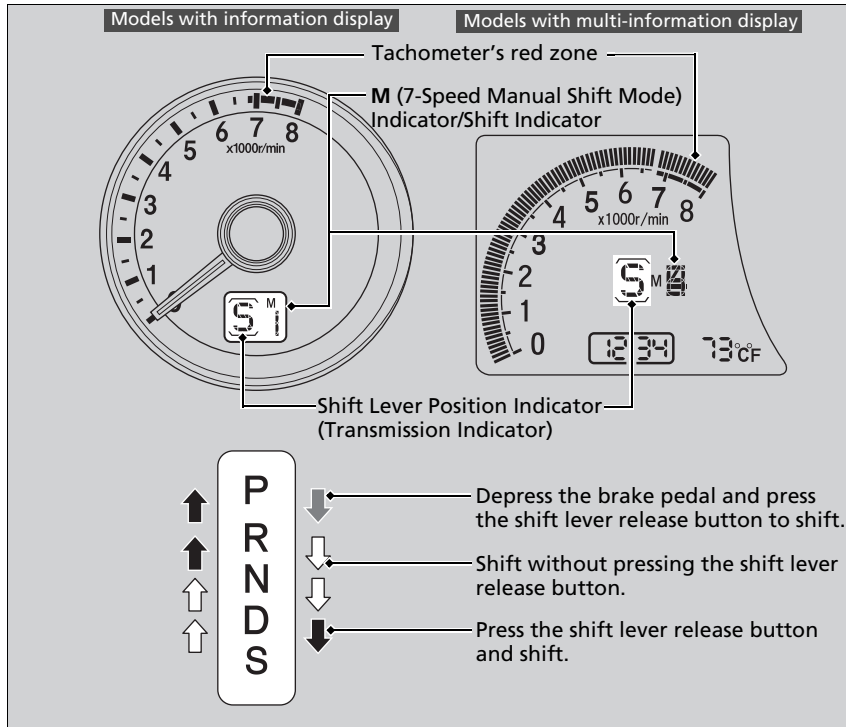

## Shift Lever Operation

### NOTICE

When you change the shift lever from **D** to **R** and vice versa, come to a complete stop and keep the brake pedal depressed. Operating the shift lever before the vehicle has come to a complete standstill can damage the transmission.

Use the shift lever position indicator to check the lever position before pulling away.

If the transmission indicator blinks when driving, in any shift position, there is a problem with the transmission.

Avoid sudden acceleration and have the transmission checked by a dealer as soon as possible.

The fuel supply may be cut off if you drive at engine speeds in or over the tachometer red zone (engine speed limit). If this happens, you may experience a slight jolt.

It may not be possible to operate the shift lever if the brake pedal is applied while the shift lever release button is held down.

Depress the brake pedal first.

## ■ 7-Speed Manual Shift Mode

Use the paddle shifters to change between 1st and 7th speeds without releasing your hands from the steering wheel. The transmission switches to the 7-speed manual shift mode when you pull a paddle shifter while driving. This mode is useful when engine braking is needed.

### ■ When the shift lever is in **D**:

The shift mode goes into the 7-speed manual shift mode temporarily, and the number is displayed in the shift indicator.

The 7-speed manual shift mode is canceled automatically if you drive at constant speed or accelerate, and the number in the shift indicator goes off.

You can cancel this mode by pulling the **+** paddle shifter for a few seconds.

The 7-speed manual shift mode is especially useful when reducing the vehicle speed temporarily before making a turn.

### ■ When the shift lever is in **S**:

The shift mode goes into the 7-speed manual shift mode. The **M** indicator and the speed number are displayed in the shift indicator. As the vehicle speed slows down, the transmission automatically shifts down accordingly. When the vehicle comes to a stop, it automatically shifts down into 1st.

If the vehicle speed increases and the engine speed reaches near the tachometer's red zone, the transmission automatically shifts up.

## ⌘ 7-Speed Manual Shift Mode

In the 7-speed manual shift mode, the transmission shifts up or down by operating either paddle shifter under the following conditions:

Shift Up: The engine speed reaches the lowest threshold of the higher speed position.

Shift Down: The engine speed reaches the highest threshold of the lower speed position.

When the engine speed reaches near the tachometer's red zone, the transmission shifts up automatically.

When the engine speed reaches the lowest threshold of the selected speed position, the transmission shifts down automatically.

Operating the paddle shifters on slippery surfaces may cause the tires to lock up. In this case, the 7-speed manual shift mode is canceled and goes back to the normal **D** driving mode.

## ■ 7-Speed Manual Shift Mode Operation

You can only pull away in 1st speed.

When canceling the 7-speed manual shift mode, move the shift lever from **S** to **D**. When the 7-speed manual shift mode is canceled, the **M** indicator and shift indicator will turn off.

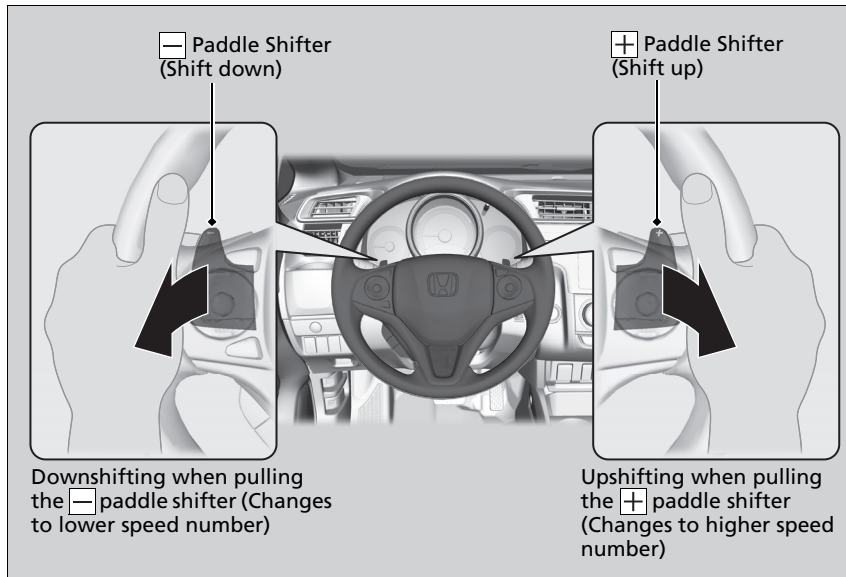

## ▶▶ 7-Speed Manual Shift Mode Operation

Each paddle shift operation makes a single speed change.

To change continuously, release the paddle shifter before pulling it again for the next speed.

The shift indicator blinks when you cannot shift up or down. It indicates that your vehicle speed is not in its allowable shifting range.

Slightly accelerate to shift up and decelerate to shift down while the indicator is blinking.

Manual transmission models

## Shifting

### Shift Lever Operation

Fully depress the clutch pedal to operate the shift lever and change gears, then slowly release the pedal.

Depress the clutch pedal, and pause for a few seconds before shifting into **R**, or shift into one of the forward gears for a moment. This stops the gears so they do not “grind.”

### Shifting

**NOTICE**

Do not shift to **R** before the vehicle comes to a complete stop. Shifting to **R** before stopping can damage the transmission.

**NOTICE**

Before downshifting, make sure the engine will not go into the tachometer’s red zone. Should this occur, it can severely damage your engine.

*Continued*

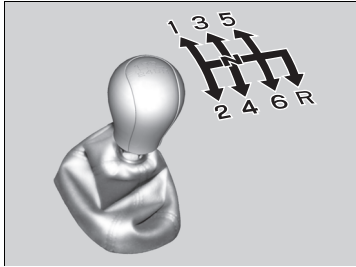

When you are not shifting, do not rest your foot on the clutch pedal. This can cause your clutch to wear out faster.

#### ▶ Shifting

If you exceed the maximum speed for the gear you are in, the engine speed will enter into the tachometer's red zone. When this happens, you may experience a slight jolt.



## Reverse Lockout

The manual transmission has a lockout mechanism that stops you from accidentally shifting into **R** from a forward gear while the vehicle is moving above a certain speed.

If you cannot shift to **R** when the vehicle is stopped, do the following:

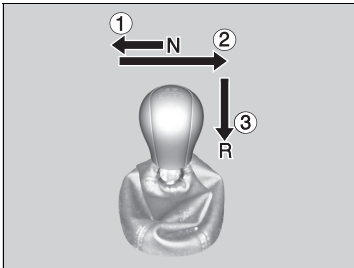

1. Depress the clutch pedal, move the shift lever all the way to the left, and shift to **R**.
2. If you still cannot shift into **R**, apply the parking brake, and turn the ignition switch to ACCESSORY **I** or LOCK **O**\*1.
3. Depress the clutch pedal and shift into **R**.
4. Keep depressing the clutch pedal and start the engine.

Have the vehicle checked by a dealer if you have to go through this procedure repeatedly.

\*1: Models with the smart entry system have an **ENGINE START/STOP** button instead of an ignition switch.

### ■ Shift Up/Down Indicators\*

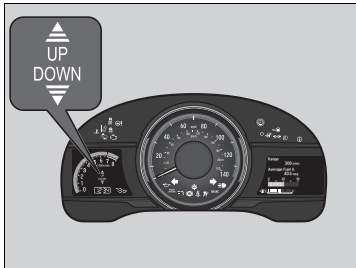

Come on to inform you that upshifting or downshifting is necessary to prevent the engine from over revving or stalling.

The shift up indicator:  
Comes on when upshifting is recommended.  
The shift down indicator:  
Comes on when downshifting is recommended.

### ▣ Shift Up/Down Indicators\*

This indicator will not prompt you to downshift to increase engine braking. It is up to you to downshift to increase engine braking when driving downhill.

Always shift down at the appropriate vehicle speed.

Ambient meter color may change if you do not change gears when a shift indicator illuminates.

Road and traffic conditions may require you to shift at times other than those indicated.

## ECON Button\*

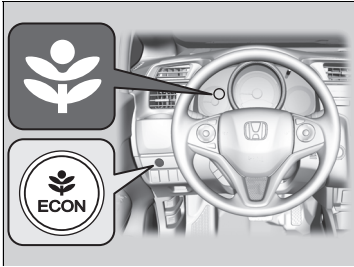

The **ECON** button turns the ECON mode on and off. The ECON mode helps you improve your fuel economy by adjusting the performance of the engine, transmission, climate control system\*, and cruise control\*.

### » ECON Button\*

#### Models with climate control system

While in ECON mode, the climate control system has greater temperature fluctuations.

\* Not available on all models

## Cruise Control \*

Maintains a constant vehicle speed without having to keep your foot on the accelerator. Use cruise control on freeways or open roads where you can travel at a constant speed with little acceleration or deceleration.

### When to use

- Vehicle speed for cruise control:  
Desired speed in a range above roughly 25 mph (40 km/h) ~

Always keep sufficient distance between you and the vehicle in front of you.

### Continuously variable transmission models

- Shift positions for cruise control:  
In **D** or **S**



### How to use

**CRUISE MAIN**

**CRUISE MAIN** is on in the instrument panel.  
Cruise control is ready to use.

- Press the **CRUISE** button on the steering wheel.

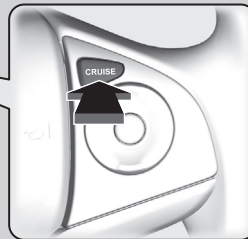
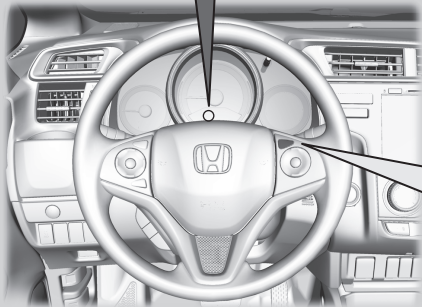

### ⚠ Cruise Control \*

## ⚠ WARNING

Improper use of the cruise control can lead to a crash.

Use the cruise control only when traveling on open highways in good weather.

It may not be possible to maintain a constant speed when driving uphill or downhill.

When not using cruise control:  
Turn off cruise control by pressing the **CRUISE** button.

### Models with ECON system

While in ECON mode, it may take relatively more time to accelerate to maintain the set speed.

### Manual transmission models

When the engine speed slows down, try to downshift.

You can maintain the set speed if you change gear within five seconds.

## ■ To Set the Vehicle Speed

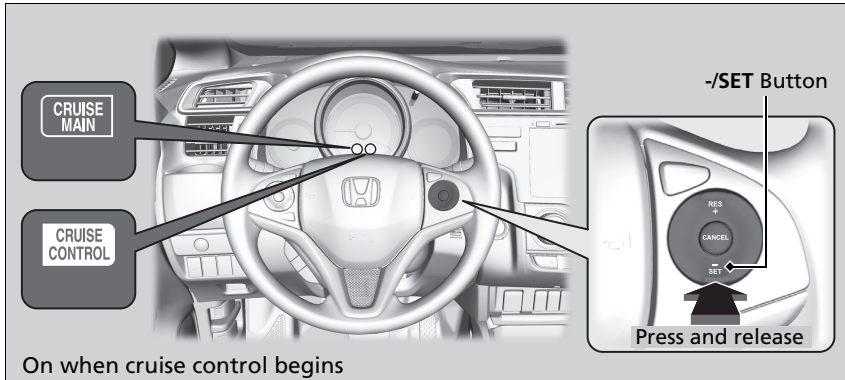

On when cruise control begins

Take your foot off the pedal and press the **-/SET** button when you reach the desired speed.

The moment you release the **-/SET** button, the set speed is fixed, and cruise control begins. The **CRUISE CONTROL** indicator comes on.

## ■ To Adjust the Vehicle Speed

Increase or decrease the vehicle speed using the **RES/+** or **-/SET** buttons on the steering wheel.

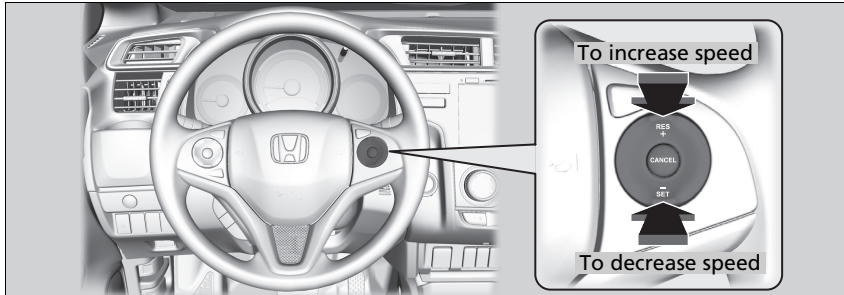

- Each time you press the button, the vehicle speed is increased or decreased by about 1 mph (1.6 km/h).
- If you keep the button pressed, the vehicle speed increases or decreases until you release it. This speed is then set.

## ■ To Cancel

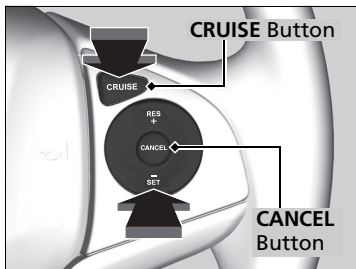

To cancel cruise control, do any of the following:

- Press the **CANCEL** button.
- Press the **CRUISE** button.
- Depress the brake pedal.

### Manual transmission models

- Depress the clutch pedal for five seconds or more.

The **CRUISE CONTROL** indicator goes off.

## ▶▶ To Adjust the Vehicle Speed

You can set the vehicle speed using the **-/SET** button on the steering wheel when adjusting the speed with the accelerator and brake pedals.

## ▶▶ To Cancel

Resuming the prior set speed:  
After cruise control has been canceled, you can still resume the prior set speed by pressing the **RES/+** button while driving at a speed of at least 25 mph (40 km/h) or more.

You cannot set or resume in the following situations:

- When vehicle speed is less than 25 mph (40 km/h)
- When the **CRUISE** button is turned off

At vehicle speeds of 22 mph (35 km/h) or less, cruise control is canceled automatically.

## Front Sensor Camera \*

The camera, used in systems such as LKAS, RDM, ACC, CMBS™, and auto high-beam, is designed to detect an object that triggers any of the systems to operate their functions.

### Camera Location and Handling Tips

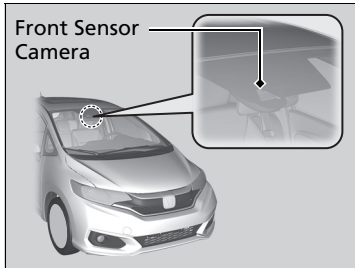

This camera is located behind the rearview mirror.

To help reduce the likelihood that high interior temperatures will cause the camera's sensing system to shut off, when parking, find a shady area or face the front of the vehicle away from the sun. If you use a reflective sun shade, do not allow it to cover the camera housing. Covering the camera can concentrate heat on it.

### Front Sensor Camera \*

Never apply a film or attach any objects to the windshield, the hood, or the front grill that could obstruct the camera's field of vision and cause the system to operate abnormally. Scratches, nicks, and other damage to the windshield within the camera's field of vision can cause the system to operate abnormally. If this occurs, we recommend that you replace the windshield with a genuine Honda replacement windshield. Making even minor repairs within the camera's field of vision or installing an aftermarket replacement windshield may also cause the system to operate abnormally. After replacing the windshield, have a dealer recalibrate the camera. Proper calibration of the camera is necessary for the system to operate properly.

Do not place an object on the top of the instrument panel. It may reflect onto the windshield and prevent the system from detecting lane lines properly.

📷 Front Sensor Camera\*

If the **Some Driver Assist Systems Cannot Operate: Camera Temperature Too High** message appears:

- Use the climate control system to cool down the interior and, if necessary, also use defroster mode with the airflow directed towards the camera.
- Start driving the vehicle to lower the windshield temperature, which cools down the area around the camera.

If the **Some Driver Assist Systems Cannot Operate: Clean Front Windshield** message appears:

- Park your vehicle in a safe place, and clean the windshield. If the message does not disappear after you have cleaned the windshield and driven for a while, have your vehicle checked by a dealer.



## Adaptive Cruise Control (ACC)\*

Helps maintain a constant vehicle speed and a set following-interval behind a vehicle detected ahead of yours, without you having to keep your foot on the brake or the accelerator.

**When to use**

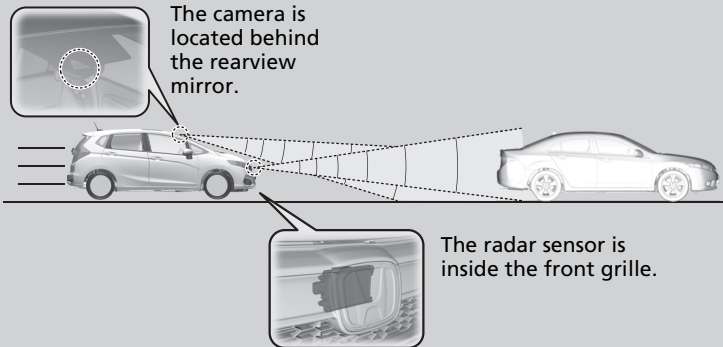

The camera is located behind the rearview mirror.

The radar sensor is inside the front grille.

- Vehicle speed for ACC: Desired speed in a range above roughly 25 mph (40 km/h) ~
- Continuously variable transmission models
- Shift position for ACC: In **D** or **S**
- Manual transmission models
- Shift position for ACC: In **2** or higher position

\* Not available on all models

Continued

### ⚠ Adaptive Cruise Control (ACC)\*

#### ⚠ WARNING

Improper use of ACC can lead to a crash.

Use ACC only when driving on expressways or freeways in good weather conditions.

#### ⚠ WARNING

ACC has limited braking capability.

When your vehicle speed drops below 22 mph (35 km/h), ACC will automatically cancel and no longer will apply your vehicle's brakes.

Always be prepared to apply the brake pedal when conditions require.

#### Important Reminder

As with any system, there are limits to ACC. Use the brake pedal whenever necessary, and always keep a safe interval between your vehicle and other vehicles.

Be careful not to severely impact the radar sensor cover.

#### Manual transmission models

Shift up when the engine revolutions is increasing. Shift down when the engine revolutions is decreasing. You can keep the set speed if you change the shift position within five second after depressing the clutch pedal.

## ■ How to activate the system

### How to use

ACC is on in the multi-information display.  
ACC is ready to use.

ACC

■ Press the **MAIN** button on the steering wheel.

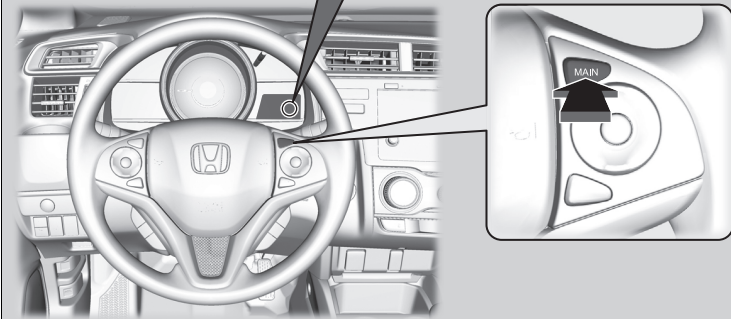

### ▶ Adaptive Cruise Control (ACC)\*

You can read about handling information for the camera equipped with this system.

▶ **Front Sensor Camera\*** P. 431

The radar sensor for ACC is shared with the collision mitigation braking system™ (CMBS™)

▶ **Collision Mitigation Braking System™ (CMBS™)\*** P. 472

When not using ACC: Turn off adaptive cruise by pressing the **MAIN** button. This also will turn off the Lane Keeping Assist System (LKAS).

When the **MAIN** button is pressed both ACC and the Lane Keeping Assist System (LKAS) are either turned on or off.

ACC may not work properly under certain conditions.

▶ **ACC Conditions and Limitations** P. 438

Do not use ACC under the following conditions:

- On roads with heavy traffic or while driving in continuous stop and go traffic.
- On roads with sharp turns.
- On roads with steep downhill sections, as the set vehicle speed can be exceeded by coasting. In such cases, ACC will not apply the brakes to maintain the set speed.
- On roads with toll collection facilities or other objects between lanes of traffic, or in parking areas, or facilities with drive through access.

## ■ To Set the Vehicle Speed

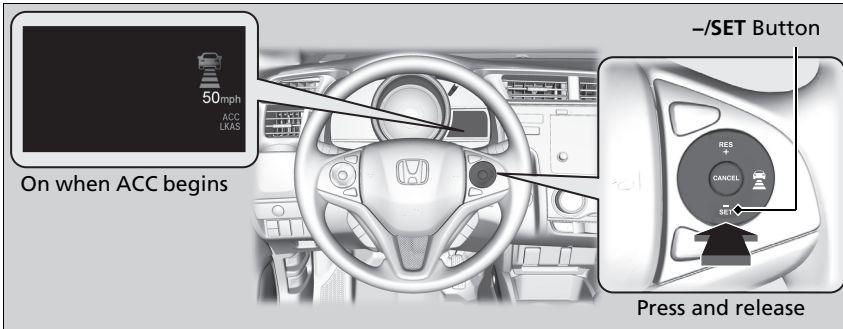

Take your foot off the pedal and press down the **-/SET** button when you reach the desired speed. The moment you release the button, the set speed is fixed, and ACC begins.

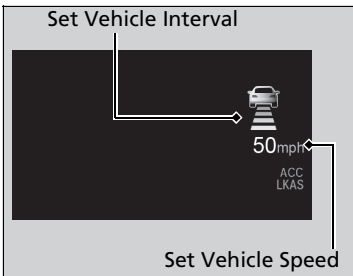

When ACC starts operating, the vehicle icon, interval bars and set speed appear on the multi-information display.

## ☒ To Set the Vehicle Speed

You can switch the displayed set speed measurements on the multi-information display between mph and km/h.

☒ **Customized Features P. 111**

\* Not available on all models

## ■ When in Operation

### ■ There is a vehicle ahead

ACC monitors if a vehicle ahead of you enters the ACC range. If a vehicle is detected doing so, the ACC system maintains or decelerates your vehicle's set speed in order to keep the vehicle's set following-interval from the vehicle ahead.

➤ **To Set or Change Following-interval** P. 441

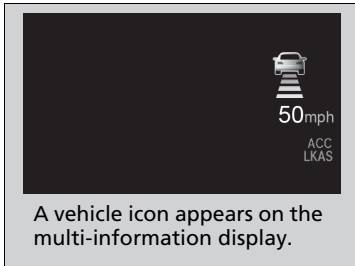
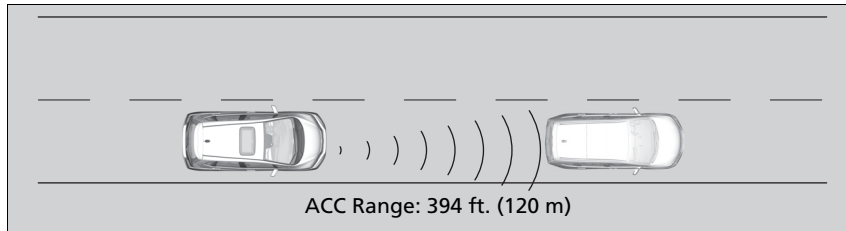

When a vehicle whose speed is slower than your set speed comes in or cuts in front of you, your vehicle starts to slow down.

## ⌘ When in Operation

If the vehicle detected ahead of you slows down abruptly, or if another vehicle is detected cutting in front of you, the beeper sounds and a message appears on the multi-information display. Depress the brake pedal, and keep an appropriate interval from the vehicle ahead.

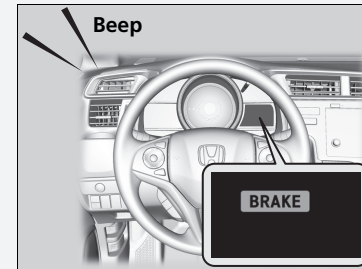

Even if the interval between your vehicle and the vehicle detected ahead is short, ACC may start accelerating your vehicle under the following circumstances:

- The vehicle ahead of you is going at almost the same speed as, or faster than, your vehicle.
- A vehicle that cuts in front of you is going faster than your vehicle, gradually increasing the interval between the vehicles.

You can also set the system to beep when a vehicle in front of you comes in and goes out of the ACC detecting range. Change the **ACC Forward Vehicle Detect Beep** setting.

➤ **Customized Features** P. 111

### ■ There is no vehicle ahead

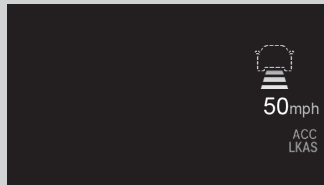

A vehicle icon with dotted-line contour appears on the multi-information display.

Your vehicle maintains the set speed without having to keep your foot on the brake or accelerator pedal.

If there previously was a vehicle detected ahead that kept your vehicle from traveling at the set speed, ACC accelerates your vehicle to the set speed, and then maintains it.

### ■ When you depress the accelerator pedal

You can temporarily increase the vehicle speed. In this case, there is no audible or visual alert even if a vehicle is in the ACC range.

ACC stays on unless you cancel it. Once you release the accelerator pedal, the system resumes an appropriate speed for keeping the following-interval while a vehicle ahead is within the ACC range.

#### ⌘ When in Operation

##### Limitations

You may need to use the brake to maintain a safe interval when using ACC. Additionally, ACC may not work properly under certain conditions.

➤ **ACC Conditions and Limitations** P. 438

Continued

## ■ ACC Conditions and Limitations

The system may automatically shut off and the **ACC** indicator will come on under certain conditions. Some examples of these conditions are listed below. Other conditions may reduce some of the ACC functions.

➤ **Front Sensor Camera**\* P. 431

### ■ Environmental conditions

- Driving in bad weather (rain, fog, snow, etc.).

### ■ Roadway conditions

- Driving on a snowy or wet roadway (obscured lane marking, vehicle tracks, reflected lights, road spray, high contrast).

### ■ Vehicle conditions

- The outside of the windshield is blocked by dirt, mud, leaves, wet snow, etc.
- An abnormal tire or wheel condition (Wrong sized, varied size or construction, improperly inflated, compact spare tire, etc.).
- The camera temperature gets too high.
- The parking brake is applied.
- When the radar sensor cover is dirty.
- The vehicle is tilted due to a heavy load or suspension modifications.
- When tire chains are installed.

## ➤ ACC Conditions and Limitations

The radar sensor for ACC is shared with the collision mitigation braking system™ (CMBS™).

➤ **Collision Mitigation Braking System™ (CMBS™)\*** P. 472

You can read about handling information for the camera equipped with this system.

➤ **Front Sensor Camera**\* P. 431

Always keep the radar sensor cover clean.

Never use chemical solvents or polishing powder for cleaning the sensor cover. Clean it with water or a mild detergent.

Do not put a sticker on the radar sensor cover or replace the radar sensor cover.

If you need the radar sensor to be repaired, or removed, or the radar sensor cover is strongly impacted, turn off the system by pressing the **MAIN** button and take your vehicle to a dealer.

Have your vehicle checked by a dealer if you find any unusual behavior of the system (e.g., the warning message appears too frequently).

If the front of the vehicle is impacted in any of the following situations, the radar sensor may not work properly. Have your vehicle checked by a dealer:

- The vehicle mounted onto a bump, curb, chock, embankment, etc.
- You drive the vehicle where the water is deep.
- Your vehicle has a frontal collision.

**■ Detection limitations**

- A vehicle suddenly crosses in front of you.
- The interval between your vehicle and the vehicle ahead of you is too short.
- A vehicle cuts in front of you at a slow speed, and it brakes suddenly.
- When you accelerate rapidly and approach the vehicle ahead of you at high speed.
- The vehicle ahead of you is a motorcycle, bicycle, mobility scooter, or other small vehicle.
- When there are animals in front of your vehicle.
- When you drive on a curved or winding or undulating road that makes it difficult for the sensor to properly detect a vehicle in front of you.
- The speed difference between your vehicle and a vehicle in front of you is significantly large.
- An oncoming vehicle suddenly comes in front of you.
- Your vehicle abruptly crosses over in front of an oncoming vehicle.
- When driving through a narrow iron bridge.
- When the vehicle ahead of you brakes suddenly.
- When the vehicle ahead of you has a unique shape.
- When your vehicle or the vehicle ahead of you is driving on one edge of the lane.

## ■ To Adjust the Vehicle Speed

Increase or decrease the vehicle speed using the **RES/+** or **-/SET** buttons on the steering wheel.

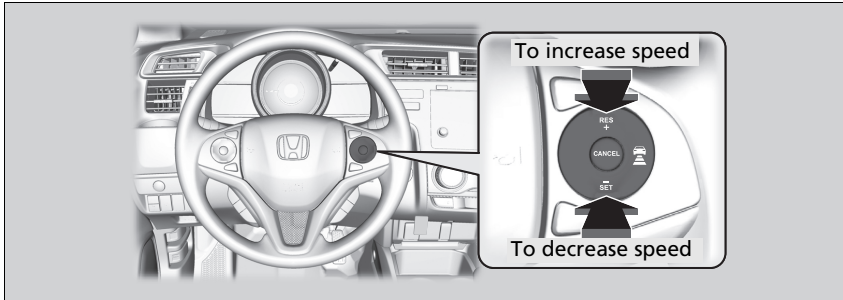

- Each time you press the **RES/+** or **-/SET** button, the vehicle speed is increased or decreased by about 1 mph or 1 km/h accordingly.
- If you press and hold the **RES/+** or **-/SET** button, the vehicle speed increases or decreases by about 5 mph or 5 km/h accordingly.

## ▶▶ To Adjust the Vehicle Speed

If a vehicle detected ahead is going at a speed slower than your increased set speed, ACC may not accelerate your vehicle. This is to maintain the set interval between your vehicle and the vehicle ahead.



## ■ To Set or Change Following-interval

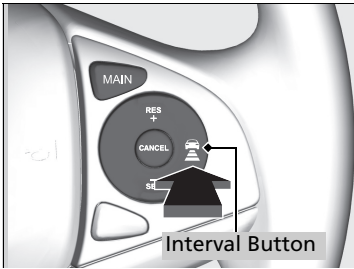





Press the  (interval) button to change the ACC following-interval.

Each time you press the button, the following-interval (the interval behind a vehicle detected ahead of you) setting cycles through short, middle, long, and extra long following-intervals.

Determine the most appropriate following-interval setting based on your specific driving conditions. Be sure to adhere to any following-interval requirements set by local regulation.

The higher your vehicle's following-speed is, the longer the short, middle, long or extra long following-interval becomes. See the following examples for your reference.

Vehicle Interval		When the Set Speed is:	
		50 mph (80 km/h)	65 mph (104 km/h)
Short		84 feet 26 meters 1.1 sec	102 feet 31 meters 1.1 sec
Middle		111 feet 34 meters 1.5 sec	139 feet 43 meters 1.5 sec
Long		155 feet 48 meters 2.1 sec	202 feet 62 meters 2.1 sec
Extra Long		204 feet 62 meters 2.8 sec	265 feet 81 meters 2.8 sec

## ■ To Cancel

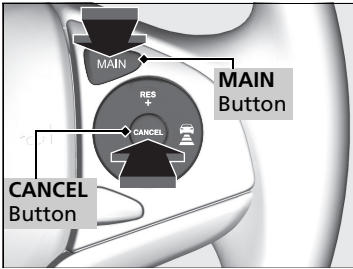

To cancel ACC, do any of the following:

- Press the **CANCEL** button.
- Press the **MAIN** button.
  - ▶ The **ACC** indicator (green) goes off.
- Depress the brake pedal.

### Manual transmission models

- Depress the clutch pedal for five seconds or more.

## ☒ To Cancel

Resuming the prior set speed: After you have canceled ACC, you can resume the prior set speed while it is still displayed. Press the **RES/+** button when driving at a speed of at least 25 mph (40 km/h) or more.

The set speed cannot be set or resumed when ACC has been turned off using the **MAIN** button. Press the **MAIN** button to activate the system, then set the desired speed.

### ■ Automatic cancellation

The beeper sounds and a message appears on the multi-information display when ACC is automatically canceled. Any of these conditions may cause the ACC to automatically cancel:

- Bad weather (rain, fog, snow, etc.)
- When the radar sensor inside the front grille gets dirty.
- The vehicle ahead of you cannot be detected.
- An abnormal tire condition is detected, or the tires are skidding.
- Driving on a mountainous road, or driving off road for extended periods.
- Abrupt steering wheel movement.
- When the ABS, VSA® or CMBS™ is activated.
- When the ABS or VSA® system indicator comes on.
- When you manually apply the parking brake.
- When the detected vehicle within the ACC range is too close to your vehicle.
- The camera behind the rearview mirror, or the area around the camera, including the windshield, gets dirty.

#### Models with manual transmission



- When you do not shift down about for ten seconds after the shift down indicator coming on
- When the engine speed reaches the tachometer's red zone
- When the engine speed reaches 1,000 rpm or less
- When you keep **N** while driving
- When you put the transmission into **N** without depressing the clutch pedal

#### ⌘ Automatic cancellation

Even though ACC has been automatically canceled, you can still resume the prior set speed. Wait until the condition that caused ACC to cancel improves, then press the **RES/+** button.

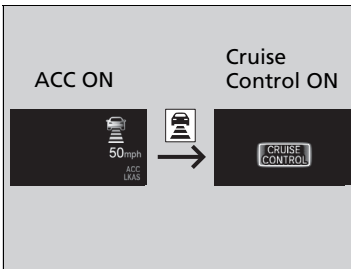
## ■ To Switch ACC to Cruise Control



Press and hold the  (interval) button for one second. **Cruise Mode Selected** appears on the multi-information display for two seconds, and then the mode switches to Cruise and the Cruise Mode indicator is displayed. To switch back to ACC, press and hold the  button again for one second. **ACC Mode Selected** appears on the multi-information display for two seconds.

### ■ When to use

Desired speed in a range above roughly 25 mph (40 km/h) ~.

## ■ To Set the Vehicle Speed

Take your foot off the pedal and press the **-/SET** button when you reach the desired speed.

The moment you release the **-/SET** button, the set speed is fixed, and cruise control begins. The **CRUISE CONTROL** indicator comes on.

## ■ To Adjust the Vehicle Speed

Each time you press the **RES/+** or **-/SET** button, the vehicle speed is increased or decreased by about 1 mph (1 km/h).

If you keep the **RES/+** or **-/SET** button pressed, the vehicle speed increases or decreases by about 5 mph or 5 km/h accordingly.

### ▶▶ To Switch ACC to Cruise Control

Always be aware which mode you are in. When you are driving in Cruise mode, the system will not assist you to maintain a following-interval from a vehicle ahead of you.

## ■ To Cancel

To cancel cruise control, do any of the following:

- Press the **CANCEL** button.
- Press the **MAIN** button.
- Depress the brake pedal.

### Manual transmission models

- Depress the clutch pedal for five seconds or more.
- The **CRUISE CONTROL** indicator goes off.

## ☞ To Cancel

Resuming the prior set speed:

After cruise control has been canceled, you can still resume the prior set speed by pressing the **RES/+** button while driving at a speed of at least 25 mph (40 km/h) or more.

You cannot set or resume in the following situations:

- When vehicle speed is less than 25 mph (40 km/h)
- When the **MAIN** button is turned off.

At vehicle speeds of 22 mph (35 km/h) or less, cruise control canceled automatically.

## Road Departure Mitigation (RDM) System\*

Alerts and helps to assist you when the system determines a possibility of your vehicle unintentionally crossing over detected lane markings and/or leaving the roadway altogether.

### How the System Works

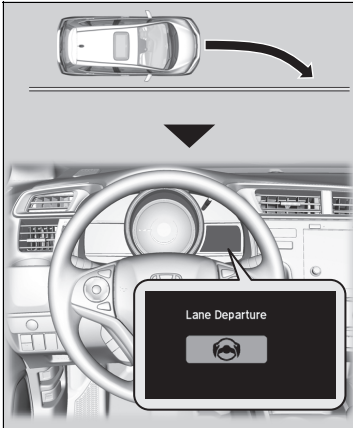

The front camera behind the rearview mirror monitors left and right lane markings (in white or yellow). If your vehicle is getting too close to detected lane markings without a turn signal activated, the system, in addition to a visual alert, applies steering torque and alerts you with rapid vibrations on the steering wheel, to help you remain within the detected lane.

▶ **Customized Features** P. 111

As a visual alert, the **Lane Departure** message appears on the multi-information display.

### ⚠ Road Departure Mitigation (RDM) System\*

#### Important Safety Reminder

Like all assistance systems, the RDM system has limitations.

Over-reliance on the RDM system may result in a collision. It is always your responsibility to keep the vehicle within your driving lane.

The RDM system only alerts you when lane drift is detected without a turn signal in use. The RDM system may not detect all lane markings or lane or roadway departures; accuracy will vary based on weather, speed and lane marker condition. It is always your responsibility to safely operate the vehicle and avoid collisions.

You can read about handling information for the camera equipped with this system.

▶ **Front Sensor Camera\*** P. 431

The RDM system may not work properly or may work improperly under the certain conditions:

▶ **RDM Conditions and Limitations** P. 450

There are times when you may not notice RDM functions due to your operation of the vehicle, or road surface conditions.

If the system determines that its steering input is insufficient to keep your vehicle on the roadway, it may apply braking.

▶ Braking is applied only when the lane markings are solid continuous lines.

The system cancels assisting operations when you turn the steering wheel to avoid crossing over detected lane markings.

If the system operates several times without detecting driver response, the system beeps to alert you.

⌘ Road Departure Mitigation (RDM) System\*

If LKAS is off and you have selected **Narrow** from the customized options using the multi-information display, the message below will appear in case the system determines a possibility of your vehicle crossing over detected lane markings.

➤ **Customized Features** P. 111





## How the System Activates

The system becomes ready to start searching for lane markings when all the following conditions are met:

- The vehicle is traveling between about 45 and 90 mph (72 and 145 km/h).
- The vehicle is on a straight or slightly curved road.
- The turn signals are off.
- The brake pedal is not depressed.
- The wipers are not in continuous operation.
- The vehicle is not accelerating or braking, and the steering wheel is not being turned.
- The system makes a determination that the driver is not actively accelerating, braking or steering.

## RDM On and Off

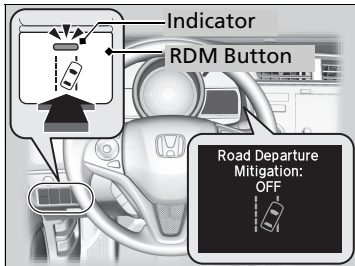

Press the RDM button to turn the system on and off.

- ▶ The indicator in the button comes on and the message appears on the multi-information display when the system is on.

## How the System Activates

The RDM system may automatically shut off and the  indicator comes and stays on.

▶ **Indicators** P. 76

RDM system function can be impacted when the vehicle is:

- Not driven within a traffic lane.
- Driven on the inside edge of a curve, or outside of a lane.
- Driven in a narrow lane.

## RDM On and Off

When you have selected **Warning Only** from the customized options using the multi-information display, the system does not operate the steering wheel and braking.

## ■ RDM Conditions and Limitations

The system may not properly detect lane markings and the position of your vehicle under certain conditions. Some examples of these conditions are listed below.

### ■ Environmental conditions

- Driving in bad weather (rain, fog, snow, etc.).
- Sudden changes between light and dark, such as an entrance or exit of a tunnel.
- There is little contrast between lane lines and the roadway surface.
- Driving into low sunlight (e.g., at dawn or dusk).
- Strong light is reflected onto the roadway.
- Driving in the shadows of trees, buildings, etc.
- Shadows of adjacent objects are parallel to lane markings.
- Roadway objects or structures are misinterpreted as lane markers.
- Reflections on the interior of the windshield.
- Driving at night or in a dark condition such as a tunnel.

**■ Roadway conditions**

- Driving on a snowy or wet roadway (obscured lane marking, vehicle tracks, reflected lights, road spray, high contrast).
- Driving on a road with temporary lane markings.
- Faint, multiple, or varied lane markings are visible on the roadway due to road repairs or old lane markings.
- The roadway has merging, split, or crossing lines (e.g., such as at an intersection or crosswalk).
- The lane markings are extremely narrow, wide, or changing.
- The vehicle in front of you is driving near the lane lines.
- The road is hilly or the vehicle is approaching the crest of a hill.
- Driving on rough or unpaved roads, or over bumpy surfaces.
- When objects on the road (curb, guard rail, pylons, etc.) are recognized as white lines (or yellow lines).
- Driving on roads with double lines.

**■ Vehicle conditions**

- Headlight lenses are dirty or the headlights are not properly adjusted.
- The outside of the windshield is streaked or blocked by dirt, mud, leaves, wet snow, etc.
- The inside of the windshield is fogged.
- The camera temperature gets too high.
- An abnormal tire or wheel condition (wrong sized, varied size or construction, improperly inflated, compact spare tire, etc.).
- The vehicle is tilted due to a heavy load or suspension modifications.
- When tire chains are installed.

## Lane Keeping Assist System (LKAS)\*

Provides steering input to help keep the vehicle in the middle of a detected lane and provides tactile and visual alerts if the vehicle is detected drifting out of its lane.

### ■ Steering input assist

The system applies torque to the steering to keep the vehicle between the left and right lane lines. The applied torque becomes stronger as the vehicle gets closer to either of the lane lines.

### ■ Front Sensor Camera

Monitors the lane lines.

### ■ Tactile and visual alerts

Rapid vibrations on the steering wheel and a warning display alert you that the vehicle is drifting out of a detected lane.

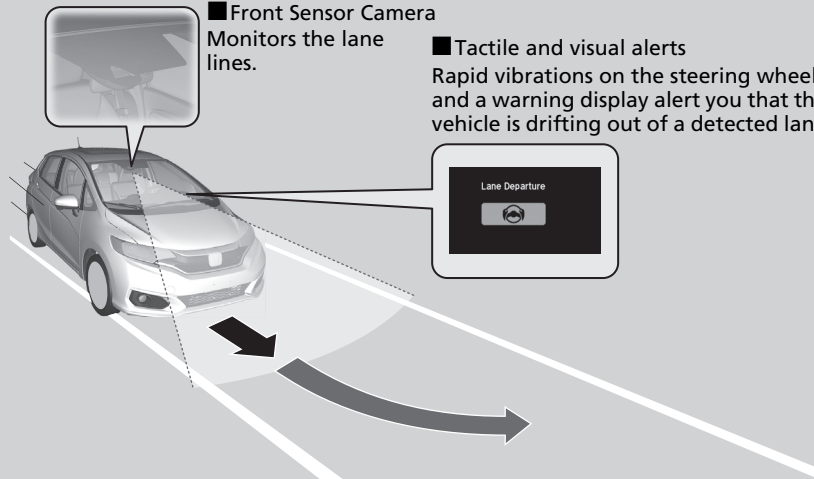

When you operate the turn signals to change lanes, the system is suspended, and resumes after the signals are off.

➡ If you make a lane change without operating the turn signals, the LKAS alerts activate, and torque is applied to the steering.

### ▶ Lane Keeping Assist System (LKAS)\*

#### Important Safety Reminders

The LKAS is for your convenience only. It is not a substitute for your vehicle control. The system does not work if you take your hands off the steering wheel or fail to steer the vehicle.

#### ▶ Multi-Information Display Warning and Information Messages\* P. 92

Do not place objects on the instrument panel. Objects may reflect on the windshield and prevent correct detection of the traffic lanes.

The LKAS only alerts you when lane drift is detected without a turn signal in use. The LKAS may not detect all lane markings or lane departures; accuracy will vary based on weather, speed, and lane marker condition.

It is always your responsibility to safely operate the vehicle and avoid collisions.

The LKAS is convenient when it is used on freeways.

The LKAS may not work properly or may work improperly under the certain conditions:

#### ▶ LKAS Conditions and Limitations P. 457

You can read about handling information for the camera equipped with this system.

#### ▶ Front Sensor Camera\* P. 431

### ■ Lane Keep Support Function

Provides assistance to keep the vehicle in the center of the lane. When the vehicle nears a white or yellow line, steering force of the electric power steering will become stronger.

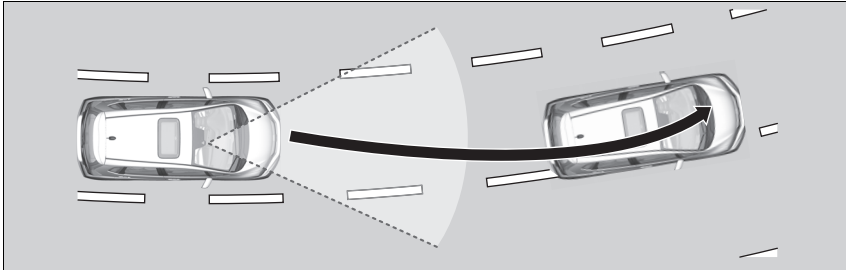

### ■ Lane Departure Warning Function

When the vehicle enters the warning area, the LKAS alerts you with slight steering wheel vibration as well as a warning display.

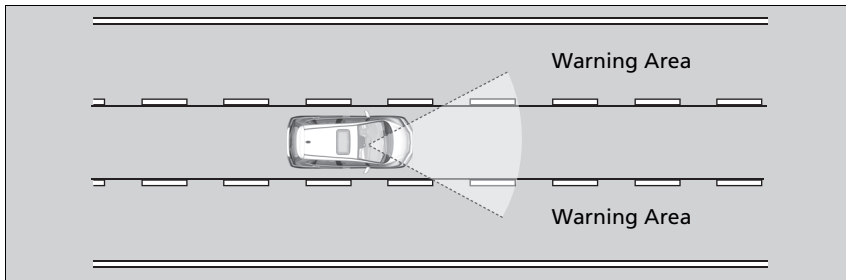

### ☒ Lane Keeping Assist System (LKAS)\*

When it fails to detect lanes, the system will temporarily be canceled. When a lane is detected, the system will recover automatically.

\* Not available on all models

Continued

## ■ When the System can be Used

The system can be used when the following conditions are met.

- The lane in which you are driving has detectable lane markers on both sides, and your vehicle is in the center of the lane.
- The vehicle speed is between 45 and 90 mph (72 and 145 km/h).
- You are driving on a straight or slightly curved road.
- The turn signals are off.
- The brake pedal is not depressed.
- The wipers are not in continuous operation.

## ■ How to activate the system

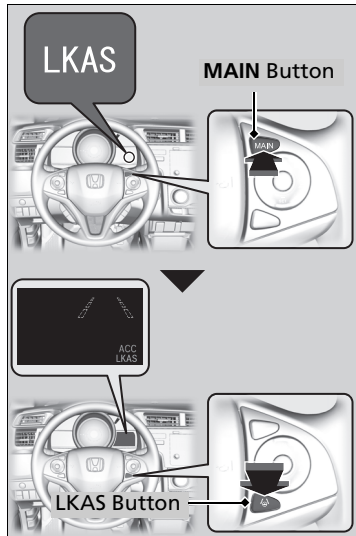

1. Press the **MAIN** button.
  - ▶ The LKAS is on in the multi-information display.  
The system is ready to use.
2. Press the LKAS button.
  - ▶ Lane outlines appear on the multi-information display.  
The system is activated.

## ▶▶ When the System can be Used

If the vehicle drifts toward either left or right lane line due to the system applying torque, turn off the LKAS and have your vehicle checked by a dealer.

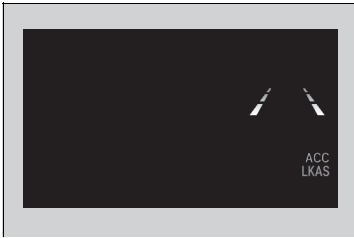

3. Keep your vehicle near the center of the lane while driving.
  - ▶ The dotted outer lines change to solid ones once the system starts operating after detecting the left and right lane markings.

## To Cancel

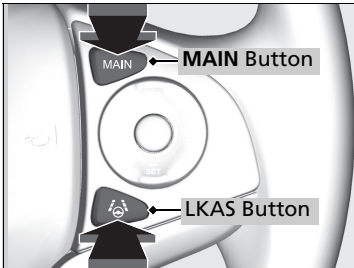

To cancel the LKAS:  
Press the **MAIN** or LKAS button.

The LKAS is turned off every time you stop the engine, even if you turned it on the last time you drove the vehicle.

## ⌘ To Cancel

Pressing the **MAIN** button also turns ACC on and off.

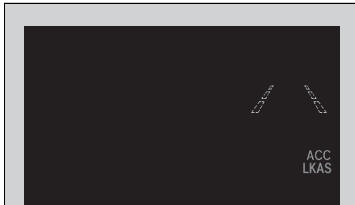

When the LKAS is suspended, the lane lines on the multi-information display change to contour lines, and the beeper sounds (if activated).

■ **The system operation is suspended if you:**

- Set the wipers to LO, HI or MIST to operate continuously.
  - ▶ Turning the wipers off resumes the LKAS.
- Decrease the vehicle speed to 40 mph (64 km/h) or less.
  - ▶ Increasing the vehicle speed to 45 mph (72 km/h) or more resumes the LKAS.
- Depress the brake pedal.
  - ▶ The LKAS resumes and starts detecting the lane lines again once you release the brake pedal.

■ **The LKAS may automatically be suspended when:**

- The system fails to detect lane lines.
  - The steering wheel is quickly turned.
  - You fail to steer the vehicle.
  - The vehicle runs on a curved road over the speed limit.
  - Driving through a sharp curve.
  - Driving at a speed in excess of approximately 90 mph (145 km/h).
- Once these conditions no longer exist, the LKAS automatically resumes.



**■ The LKAS may automatically be canceled when:**

- The camera temperature gets extremely high or low.
- The camera behind the rearview mirror, or the area around the camera, including the windshield, gets dirty.
- The ABS or VSA® system engages.

The beeper sounds if the LKAS is automatically canceled.

**■ LKAS Conditions and Limitations**

The system may not detect lane markings and therefore may not keep the vehicle in the middle of a lane under certain conditions, including the following:

**■ Environmental conditions**

- Driving in bad weather (rain, fog, snow, etc.).
- Sudden changes between light and dark, such as an entrance or exit of a tunnel.
- There is little contrast between lane lines and the roadway surface.
- Driving into low sunlight (e.g., at dawn or dusk).
- Strong light is reflected onto the roadway.
- Driving in the shadows of trees, buildings, etc.
- Shadows of adjacent objects are parallel to lane markings.
- Roadway objects or structures are misinterpreted as lane markers.
- Reflections on the interior of the windshield.
- Driving at night or in a dark condition such as a tunnel.

### ■ Roadway conditions

- Driving on a snowy or wet roadway (obscured lane marking, vehicle tracks, reflected lights, road spray, high contrast).
- Driving on a road with temporary lane markings.
- Faint, multiple, or varied lane markings are visible on the roadway due to road repairs or old lane markings.
- The roadway has merging, split, or crossing lines (e.g., such as at an intersection or crosswalk).
- The lane markings are extremely narrow, wide, or changing.
- The vehicle in front of you is driving near the lane lines.
- The road is hilly or the vehicle is approaching the crest of a hill.
- Driving on rough or unpaved roads, or over bumpy surfaces.
- When objects on the road (curb, guard rail, pylons, etc.) are recognized as white lines (or yellow lines).
- Driving on roads with double lines.

### ■ Vehicle conditions

- Headlight lenses are dirty or the headlights are not properly adjusted.
- The outside of the windshield is streaked or blocked by dirt, mud, leaves, wet snow, etc.
- The inside of the windshield is fogged.
- The camera temperature gets too high.
- An abnormal tire or wheel condition (wrong sized, varied size or construction, improperly inflated, compact spare tire, etc.).
- The vehicle is tilted due to a heavy load or suspension modifications.

## Vehicle Stability Assist® (VSA®), aka Electronic Stability Control (ESC), System

VSA® helps to stabilize the vehicle during cornering if the vehicle turns more or less than what was intended. It also assists in maintaining traction on slippery surfaces. It does so by regulating engine output and selectively applying the brakes.

### ■ VSA® Operation

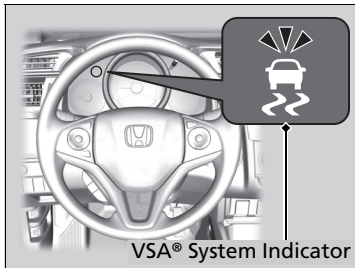

When VSA® activates, you may notice that the engine does not respond to the accelerator. You may also notice some noise from the hydraulic system. You will also see the indicator blink.

### ▣ Vehicle Stability Assist® (VSA®), aka Electronic Stability Control (ESC), System

The VSA® may not function properly if tire type and size are mixed. Make sure to use the same size and type of tire, and the air pressures as specified.

When the VSA® system indicator comes on and stays on while driving, there may be a problem with the system. While this may not interfere with normal driving, have your vehicle checked by a dealer immediately.

VSA® cannot enhance stability in all driving situations and does not control the entire braking system. You still need to drive and corner at speeds appropriate for the conditions and always leave a sufficient margin of safety.

The main function of the VSA® system is generally known as Electronic Stability Control (ESC). The system also includes a traction control function.

## ■ VSA® On and Off

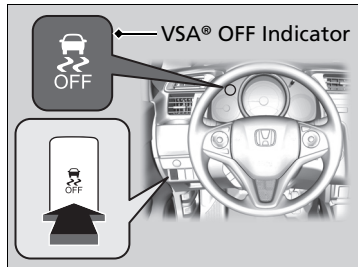

This button is on the driver side control panel. To partially disable VSA® functionality/features, press and hold it until you hear a beep.

Your vehicle will have normal braking and cornering ability, but traction control function will be less effective.

To restore VSA® functionality/features, press the  (VSA® **OFF**) button until you hear a beep.

VSA® is turned on every time you start the engine, even if you turned it off the last time you drove the vehicle.

## ▶▶ Vehicle Stability Assist® (VSA®), aka Electronic Stability Control (ESC), System

In certain unusual conditions when your vehicle gets stuck in shallow mud or fresh snow, it may be easier to free it with the VSA® temporarily switched off.

When the  button is pressed, the traction control function becomes less effective. This allows for the wheels to spin more freely at low speed. You should only attempt to free your vehicle with the VSA® off if you are not able to free it when the VSA® is on.

Immediately after freeing your vehicle, be sure to switch VSA® on again. We do not recommend driving your vehicle with the VSA® system switched off.

You may hear a motor sound coming from the engine compartment while system checks are being performed immediately after starting the engine or while driving. This is normal.

## LaneWatch™\*

LaneWatch is an assistance system that allows you to check the passenger side rear areas displayed on the audio/information screen when the turn signal is activated to the passenger's side. A camera in the passenger side door mirror monitors these areas and allows you to check for vehicles, in addition to your visual check and use of the passenger door mirror. You can also keep the system on for your convenience while driving.

**1** The system activates when you:

Move the turn signal lever to the passenger side.

Press the LaneWatch button.



The system deactivates when you:

Pull the turn signal lever back.

Press the LaneWatch button again.

**2** The passenger side view display appears on the audio/information screen.



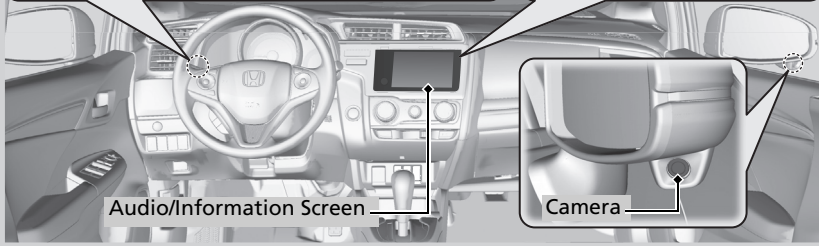

Audio/Information Screen

Camera

### ⓘ LaneWatch™\*

## ⚠ WARNING

Failure to visually confirm that it is safe to change lanes before doing so may result in a crash and serious injury or death.

Do not rely only on LaneWatch while driving.

Always look in your mirrors, to either side of your vehicle, and behind you for other vehicles before changing lanes.

### Important Safety Reminder

Like all assistance systems, LaneWatch has limitations. Over reliance on LaneWatch may result in a collision.

The LaneWatch function can be affected by weather, lighting (including headlights and low sun angle), ambient darkness, camera condition, and loading.

The LaneWatch may not provide the intended display of traffic to the side and rear under the following conditions:

- Your vehicle's suspension has been altered, changing the height of the vehicle.
- Your tires are over or under inflated.
- Your tires or wheels are of varied size or construction.

\* Not available on all models

Continued

## ■ Customizing the LaneWatch settings

You can customize the following items using the audio/information screen.

- **Show with Turn Signal:** Selects whether LaneWatch monitor comes on when you operate the turn signal light lever.
- **Display Time after Turn Signal Off:** Changes the remaining Lane Watch display time after you pull the turn signal lever back.
- **Reference Line:** Selects whether the reference lines appear on the LaneWatch monitor.
- **Display:** Adjusts display settings.
  - ✎ **Customized Features** P. 328

## ■ Reference Lines

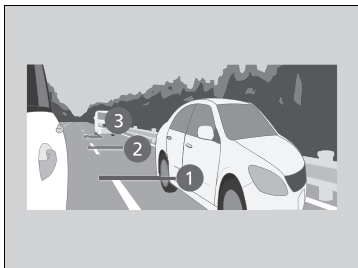

Three lines that appear on the screen can give an idea of how far the vehicles or objects on the screen are from your vehicle, respectively. If an object is near line 1 (in red), it indicates that it is close to your vehicle whereas an object near line 3 farther away.

## ☒ LaneWatch™\*

The LaneWatch camera view is restricted. Its unique lens makes objects on the screen slightly look different from what they are.

LaneWatch display does not come on when the shift lever is in **R**.

For proper LaneWatch operation:

- The camera is located in the passenger side door mirror. Always keep this area clean. If the camera lens is covered with dirt or moisture, use a soft, moist cloth to keep the lens clean and free of debris.
- Do not cover the camera lens with labels or stickers of any kind.
- Do not touch the camera lens.

## ☒ Reference Lines

The area around the reference line 1 (red) is very close to your vehicle. As always, make sure to visually confirm the safety of a lane change before changing lanes.

The distance between your vehicle and lines 1, 2 and 3 on the screen vary depending on road conditions and vehicle loading. For example, the reference lines on the screen may seem to appear closer than the actual distances when the rear of your vehicle is more heavily loaded.

Consult a dealer if:

- The passenger side door mirror, or area around it is severely impacted, resulting in changing the camera angle.
- The LaneWatch display does not come on at all.

U.S. models only

## Tire Pressure Monitoring System (TPMS)

Instead of directly measuring the pressure in each tire, the TPMS on this vehicle monitors and compares the rolling radius and rotational characteristics of each wheel and tire while you are driving to determine if one or more tires are significantly under-inflated. This will cause the low tire pressure/TPMS indicator to come on.

### TPMS Calibration

You must start TPMS calibration every time you:

- Adjust the pressure in one or more tires.
- Rotate the tires.
- Replace one or more tires.

Before calibrating the TPMS:

- Set the cold tire pressure in all four tires.

➤ **Checking Tires** P. 522

Make sure:

- The vehicle is at a complete stop.

- **Manual transmission models**

The shift lever is in **N**.

- **Continuously variable transmission models**

The shift lever is in **P**.

- **All models**

The ignition switch is in ON **II**\*1.

\*1: Models with the smart entry system have an **ENGINE START/STOP** button instead of an ignition switch.

### ⊠ Tire Pressure Monitoring System (TPMS)

The system does not monitor the tires when driving at low speed.

Conditions such as low ambient temperature and altitude change directly affect tire pressure and can trigger the low tire pressure/TPMS indicator to come on.

Tire pressure checked and inflated in:

- Warm weather can become under-inflated in colder weather.
- Cold weather can become over-inflated in warmer weather.

The low tire pressure/TPMS indicator will not come on as a result of over inflation.

The TPMS may not function properly if tire type and size are mixed. Make sure to use the same size and type of tire.

➤ **Checking and Maintaining Tires** P. 522

The low tire pressure/TPMS indicator may come on with a delay or may not come on at all when:

- You rapidly accelerate, decelerate, or turn the steering wheel.
- You drive on snowy or slippery roads.
- Snow chains are used.

The low tire pressure/TPMS indicator may come on under the following conditions:

- A compact spare tire is used.
- There is a heavier and uneven load on the tires than the condition at calibration.
- Snow chains are used.

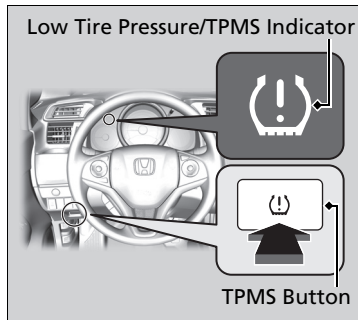

#### Models with information display

Press and hold the TPMS button until the low tire pressure/TPMS indicator blinks twice, indicating the calibration process has begun.

- If the low tire pressure/TPMS indicator does not blink, confirm the above conditions then press and hold the TPMS button again.
- The calibration process finishes automatically.

#### ▶▶ TPMS Calibration

- TPMS cannot be calibrated if a compact spare tire is installed.
- The calibration process requires approximately 30 minutes of cumulative driving at speeds between 30-60 mph (48-97 km/h).
- During this period, if the ignition is turned on\*1 and the vehicle is not moved within 45 seconds, you may notice the low tire pressure/TPMS indicator comes on briefly. This is normal and indicates that the calibration process is not yet complete.

If the snow chains are installed, remove them before calibrating the TPMS.

If the low tire pressure/TPMS indicator comes on even when the properly inflated specified regular tires are installed, have your vehicle checked by a dealer.

We recommend that the tires be replaced with the same brand, model, and size as the originals. Ask a dealer for details.

\*1: Models with the smart entry system have an **ENGINE START/STOP** button instead of an ignition switch.



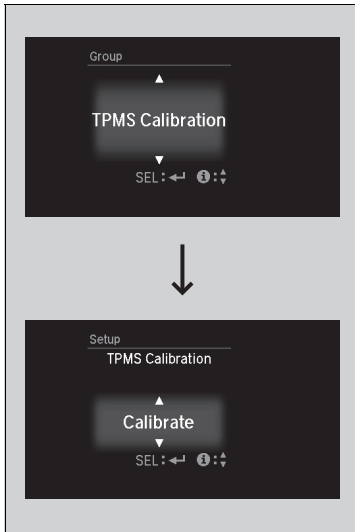

#### Models with multi-information display

You can calibrate the system from the customized features on the multi-information display.

1. Press the /▼ button to select Vehicle Settings, then press the **SEL/RESET** button.
    - ▶ TPMS Calibration appears on the display.
  2. Press the **SEL/RESET** button.
    - ▶ The display switches to the customization setup screen, where you can select Cancel or Calibrate.
  3. Press the /▼ button and select Calibrate, then press the **SEL/RESET** button.
    - ▶ Calibration Started screen appears, then the display returns to the customization menu screen.
- If the Calibration Failed to Start message appears, repeat steps 2-3.
  - The calibration process finishes automatically.

U.S. models

## Tire Pressure Monitoring System (TPMS) - Required Federal Explanation

Each tire, including the spare (if provided), should be checked monthly when cold and inflated to the inflation pressure recommended by the vehicle manufacturer on the vehicle placard or tire inflation pressure label.

(If your vehicle has tires of a different size than the size indicated on the vehicle placard or tire inflation pressure label, you should determine the proper tire inflation pressure for those tires.)

As an added safety feature, your vehicle has been equipped with a tire pressure monitoring system (TPMS) that illuminates a low tire pressure telltale



when one or more of your tires is significantly under-inflated.

Accordingly, when the low tire pressure telltale illuminates, you should stop and check your tires as soon as possible, and inflate them to the proper pressure.

Driving on a significantly under-inflated tire causes the tire to overheat and can lead to tire failure. Under-inflation also reduces fuel efficiency and tire tread life, and may affect the vehicle's handling and stopping ability.

Please note that the TPMS is not a substitute for proper tire maintenance, and it is the driver's responsibility to maintain correct tire pressure, even if under-inflation has not reached the level to trigger illumination of the TPMS low tire pressure telltale.

Your vehicle has also been equipped with a TPMS malfunction indicator to indicate when the system is not operating properly. The TPMS malfunction indicator is combined with the low tire pressure telltale. When the system detects a malfunction, the telltale will flash for approximately one minute and then remain continuously illuminated. This sequence will continue upon subsequent vehicle start-ups as long as the malfunction exists.

When the malfunction indicator is illuminated, the system may not be able to detect or signal low tire pressure as intended.

TPMS malfunctions may occur for a variety of reasons, including the installation of replacement or alternate tires or wheels on the vehicle that prevent the TPMS from functioning properly.

Always check the TPMS malfunction telltale after replacing one or more tires or wheels on your vehicle to ensure that the replacement or alternate tires and wheels allow the TPMS to continue to function properly.

## Brake System

### ■ Parking Brake

Use the parking brake to keep the vehicle stationary when parking.

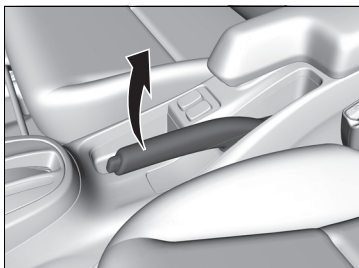

#### To apply:

Pull the lever fully up without pressing the release button.

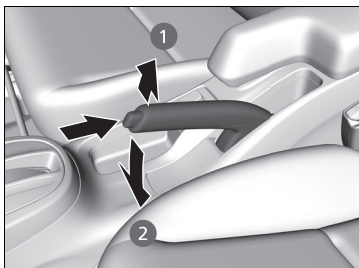

#### To release:

1. Pull the lever slightly, and press and hold the release button.
2. Lower the lever down all the way, then release the button.

### » Parking Brake

#### NOTICE

Release the parking brake fully before driving. The rear brakes and axle can be damaged if you drive with the parking brake applied.

If you start driving without fully releasing the parking brake, a buzzer sounds as a warning, and **Release Parking Brake** appears on the multi-information display\*.

Always apply the parking brake when parking.

## Foot Brake

Your vehicle is equipped with disc brakes at the front, and drum brakes in the rear wheels. A vacuum power assist helps reduce the effort needed on the brake pedal. The brake assist system increases the stopping force when you depress the brake pedal hard in an emergency situation. The anti-lock brake system (ABS) helps you retain steering control when braking very hard.

➤ **Brake Assist System** P. 471

➤ **Anti-lock Brake System (ABS)** P. 470

### Foot Brake

Check the brakes after driving through deep water, or if there is a buildup of road surface water. If necessary, dry the brakes by lightly depressing the pedal several times.

If you hear a continuous metallic friction sound when applying the brakes, this is caused by the brake wear indicator rubbing on the brake rotor and indicates that the brake pads need to be replaced. Have the vehicle checked by a dealer. If you hear only an occasional squeak or squeal when you initially apply the brake pedal, this may be normal and caused by high frequency vibration of the brake pads against the rotating brake disc.

Constantly using the brake pedal while going down a long hill builds up heat, which reduces the brake effectiveness. Apply engine braking by taking your foot off the accelerator pedal and downshifting to a lower gear/speed position. With manual transmission use a lower gear for greater engine braking.

Do not rest your foot on the brake pedal while driving, as it will lightly apply the brakes and cause them to lose effectiveness over time and reduce pad life. It will also confuse drivers behind you.

## Anti-lock Brake System (ABS)

### ■ ABS

Helps prevent the wheels from locking up, and helps you retain steering control by pumping the brakes rapidly, much faster than you.

The electronic brake distribution (EBD) system, which is part of the ABS, also balances the front-to-rear braking distribution according to vehicle loading.

You should never pump the brake pedal. Let the ABS work for you by always keeping firm, steady pressure on the brake pedal. This is sometimes referred to as “stomp and steer.”

### ■ ABS operation

The brake pedal may pulsate slightly when the ABS is working. Keep holding the pedal firmly down. On dry pavement, you will need to press on the brake pedal very hard before the ABS activates. However, you may feel the ABS activate immediately if you are trying to stop on snow or ice.

ABS may activate when you depress the brake pedal when driving on:

- Wet or snow covered roads.
- Roads paved with stone.
- Roads with uneven surfaces, such as potholes, cracks, manholes, etc.

When the vehicle speed goes under 6 mph (10 km/h), the ABS stops.

### ► Anti-lock Brake System (ABS)

#### NOTICE

The ABS may not function correctly if you use a tire of the wrong size or type.

If the **ABS** indicator comes on while driving, there may be a problem with the system. While normal braking will not be affected, there is a possibility that the ABS will not be operating. Have your vehicle checked by a dealer immediately.

The ABS is not designed for the purpose of reducing the time or distance it takes for a vehicle to stop: It is designed to limit brake lockup which can lead to skidding and loss of steering control.

In the following cases, your vehicle may need more distance to stop than a vehicle without the ABS:

- You are driving on rough or uneven road surfaces, such as gravel or snow.
- The tires are equipped with snow chains.

The following may be observed with the ABS system:

- Motor sounds coming from the engine compartment when the brakes are applied, or when system checks are being performed after the engine has been started and while the vehicle accelerates.

- Brake pedal and/or the vehicle body vibration when ABS activates.

These vibrations and sounds are normal to ABS systems and are no cause for concern.

## Brake Assist System

---

Designed to assist the driver by generating greater braking force when you depress the brake pedal hard during emergency braking.

### ■ Brake assist system operation

Press the brake pedal firmly for more powerful braking.

When brake assist operates, the pedal may wiggle slightly and an operating noise may be heard. This is normal. Keep holding the brake pedal firmly down.

## Collision Mitigation Braking System™ (CMBS™)\*

Can assist you when there is a possibility of your vehicle colliding with a vehicle or a pedestrian detected in front of yours. The CMBS™ is designed to alert you when a potential collision is determined, as well as to reduce your vehicle speed to help minimize collision severity when a collision is deemed unavoidable.

### ■ How the system works

**When to use**

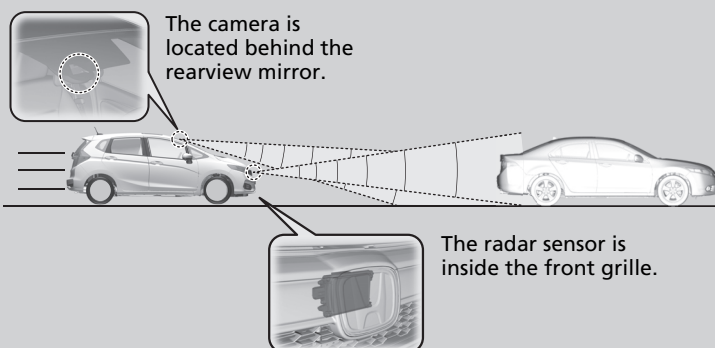

The camera is located behind the rearview mirror.

The radar sensor is inside the front grille.

The system starts monitoring the roadway ahead when your vehicle speed is about 3 mph (5 km/h) and there is a vehicle in front of you.

The CMBS™ activates when:

- The speed difference between your vehicle and a vehicle or pedestrian detected in front of you becomes about 3 mph (5 km/h) and over with a chance of a collision.
- Your vehicle speed is about 62 mph (100 km/h) or less and there is a chance of a collision with an oncoming detected vehicle or a pedestrian in front of you.

### ⚠ Collision Mitigation Braking System™ (CMBS™)\*

#### Important Safety Reminder

The CMBS™ is designed to reduce the severity of an unavoidable collision. It does not prevent collision nor stop the vehicle automatically. It is still your responsibility to operate the brake pedal and steering wheel appropriately according to the driving conditions.

The CMBS™ may not activate or may not detect a vehicle in front of your vehicle under certain conditions:

➤ **CMBS™ Conditions and Limitations** P. 476

You can read about handling information for the camera equipped with this system.

➤ **Front Sensor Camera**\* P. 431

Be careful not to severely impact the radar sensor cover.

Rapid vibrations on the steering wheel alert you when your vehicle speed is between 19 and 62 mph (30 and 100 km/h) with an oncoming vehicle detected in front of you.

When the CMBS™ activates, it may automatically apply the brake. It will be canceled when your vehicle stops or a potential collision is not determined.



## ■ When the system activates

The system provides visual, audible and tactile alerts of a possible collision, and stops if the collision is avoided.

- ▶ Take appropriate action to prevent a collision (apply the brakes, change lanes, etc.)

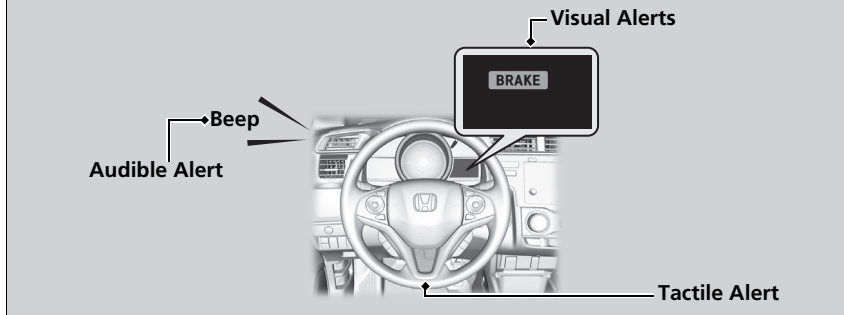

At system's earliest collision alert stage, you can change the distance (**Long/Normal/Short**) between vehicles at which alerts will come on through multi-information display setting options.

- ▶ **List of customizable options** P. 114

## ■ Vibration alert on the steering wheel

When a potential collision to an oncoming detected vehicle is determined, the system alerts you with rapid vibration on the steering wheel, in addition to visual and audible alerts.

- ▶ Take appropriate action to prevent a collision (apply the brakes, operate the steering wheel, etc.).

\* Not available on all models

Continued

## ▶▶ Collision Mitigation Braking System™ (CMBS™)\*

### ▶ Models with manual transmission

When the CMBS™ activates, the engine may stop automatically.

Start the engine by normal operation if the engine stops.

- ▶ **Starting the Engine** P. 409

## ▶▶ When the system activates

The camera in the CMBS™ is also designed to detect pedestrians.

However, this pedestrian detection feature may not activate or may not detect a pedestrian in front of your vehicle under certain conditions.

Refer to the ones indicating the pedestrian detection limitations from the list.

- ▶ **CMBS™ Conditions and Limitations** P. 476

## ▶▶ Vibration alert on the steering wheel

Vibration alert function is disabled when the electric power steering (EPS) system indicator comes on.

- ▶ **Electric Power Steering (EPS) System Indicator** P. 82

## ■ Collision Alert Stages

The system has three alert stages for a possible collision. However, depending on circumstances, the CMBS™ may not go through all of the stages before initiating the last stage.

Distance between vehicles		CMBS™			
		The radar sensor detects a vehicle	Audible & Visual WARNINGS	Steering Wheel	Braking
Stage one		There is a risk of a collision with the vehicle ahead of you.	When in <b>Long</b> , visual and audible alerts come on at a longer distance from a vehicle ahead than in <b>Normal</b> setting, and in <b>Short</b> , at a shorter distance than in <b>Normal</b> .	In case of an oncoming vehicle detected, rapid vibration is provided.	—
Stage two		The risk of a collision has increased, time to respond is reduced.	Visual and audible alerts.	—	Lightly applied
Stage three		The CMBS™ determines that a collision is unavoidable.			Forcefully applied

## ■ CMBS™ On and Off

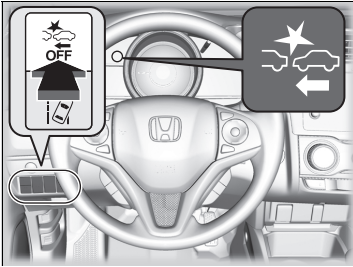

Press and hold the button until the beeper sounds to switch the system on or off.

When the CMBS™ is off:

- The CMBS™ indicator in the instrument panel comes on.
- A message on the multi-information display reminds you that the system is off.

The CMBS™ is turned on every time you start the engine, even if you turned it off the last time you drove the vehicle.

## ▣ Collision Mitigation Braking System™ (CMBS™)\*

The CMBS™ may automatically shut off, and the CMBS™ indicator will come and stay on under certain conditions:

▣ **CMBS™ Conditions and Limitations** P. 476

\* Not available on all models

## ■ CMBS™ Conditions and Limitations

The system may automatically shut off and the CMBS™ indicator will come on under certain conditions. Some examples of these conditions are listed below. Other conditions may reduce some of the CMBS™ functions.

➤ **Front Sensor Camera\*** P. 431

### ■ Environmental conditions

- Driving in bad weather (rain, fog, snow, etc.).
- Sudden changes between light and dark, such as an entrance or exit of a tunnel.
- There is little contrast between objects and the background.
- Driving into low sunlight (e.g., at dawn or dusk).
- Strong light is reflected onto the roadway.
- Driving in the shadows of trees, buildings, etc.
- Roadway objects or structures are misinterpreted as vehicles and pedestrians.
- Reflections on the interior of the windshield.
- Driving at night or in a dark condition such as a tunnel.

### ■ Roadway conditions

- Driving on a snowy or wet roadway (obscured lane marking, vehicle tracks, reflected lights, road spray, high contrast).
- Driving on curvy, winding, or undulating roads.
- The road is hilly or the vehicle is approaching the crest of a hill.

**■ Vehicle conditions**

- Headlight lenses are dirty or the headlights are not properly adjusted.
- The outside of the windshield is blocked by dirt, mud, leaves, wet snow, etc.
- The inside of the windshield is fogged.
- An abnormal tire or wheel condition (wrong sized, varied size or construction, improperly inflated, compact spare tire, etc.).
- When tire chains are installed.
- The vehicle is tilted due to a heavy load or suspension modifications.
- The camera temperature gets too high.
- Driving with the parking brake applied.
- When the radar sensor inside the front grille gets dirty.

**■ Detection limitations**

- A vehicle or pedestrian suddenly crosses in front of you.
- The distance between your vehicle and the vehicle or pedestrian ahead of you is too short.
- A vehicle cuts in front of you at a slow speed, and it brakes suddenly.
- When you accelerate rapidly and approach the vehicle or pedestrian ahead of you at high speed.
- The vehicle ahead of you is a motorcycle, bicycle, mobility scooter or other small vehicle.
- When there are animals in front of your vehicle.
- When you drive on a curved, winding or undulating road that makes it difficult for the sensor to properly detect a vehicle in front of you.
- The speed difference between your vehicle and a vehicle or pedestrian in front of you is significantly large.
- An oncoming vehicle suddenly comes in front of you.
- Another vehicle suddenly comes in front of you at an intersection, etc.
- Your vehicle abruptly crosses over in front of an oncoming vehicle.
- When driving through a narrow iron bridge.
- When the lead vehicle suddenly slows down.

**Limitations applicable to pedestrian detection only**

- When there is a group of people in front of your vehicle walking together side by side.
- Surrounding conditions or belongings of the pedestrian alter the pedestrian's shape, preventing the system from recognizing that the person is a pedestrian.
- When the pedestrian is shorter than about 3.3 feet (1 meter) or taller than about 6.6 feet (2 meters) in height.
- When a pedestrian blends in with the background.
- When a pedestrian is bent over or squatting, or when their hands are raised or they are running.
- When several pedestrians are walking ahead in a group.
- When the camera cannot correctly identify that a pedestrian is present due to an unusual shape (holding luggage, body position, size).

**■ Automatic shutoff**

The CMBS™ may automatically shut itself off and the CMBS™ indicator comes and stays on when:

- The temperature inside the system is high.
- You drive off-road or on a mountain road, or curved and winding road for an extended period.
- An abnormal tire condition is detected (wrong tire size, flat tire, etc.).
- The camera behind the rearview mirror, or the area around the camera, including the windshield, gets dirty.

Once the conditions that caused the CMBS™ to shut off improve or are addressed (e.g., cleaning), the system comes back on.

## ■ With Little Chance of a Collision

The CMBS™ may activate even when you are aware of a vehicle ahead of you, or when there is no vehicle ahead. Some examples of this are:

### ■ When Passing

Your vehicle approaches another vehicle ahead of you and you change lanes to pass.

### ■ At an intersection

Your vehicle approaches or passes another vehicle that is making a left or right turn.

### ■ On a curve

When driving through curves, your vehicle comes to a point where an oncoming vehicle is right in front of you.

### ■ Through a low bridge at high speed

You drive under a low or narrow bridge at high speed.

### ■ Speed bumps, road work sites, train tracks, roadside objects, etc.

You drive over speed bumps, steel road plates, etc., or your vehicle approaches train tracks or roadside objects [such as a traffic sign and guard rail] on a curve or, when parking, stationary vehicles and walls.

## ⓘ Collision Mitigation Braking System™ (CMBS™)\*

For the CMBS™ to work properly:

Always keep the radar sensor cover clean.

Never use chemical solvents or polishing powder for cleaning the sensor cover. Clean it with water or a mild detergent.

Do not put a sticker on the emblem or replace the emblem.

If you need the radar sensor to be repaired, or removed, or the radar sensor cover is strongly impacted, turn off the system by pressing the CMBS™ off button and take your vehicle to a dealer.

Have your vehicle checked by a dealer if you find any unusual behavior of the system (e.g., the warning message appears too frequently).

If the front of the vehicle is impacted in any of the following situations, the radar sensor may not work properly. Have your vehicle checked by a dealer:

- The vehicle mounted onto a bump, curb, chock, embankment, etc.
- You drive the vehicle where the water is deep.
- Your vehicle has a frontal collision.

\* Not available on all models

## When Stopped

1. Depress the brake pedal firmly.
2. Firmly apply the parking brake.

### Continuously variable transmission models

3. Move the shift lever from **D** to **P**.

### Manual transmission models

3. Move the shift lever to **R** or **1**.

### All models

4. Turn off the engine.

Always set the parking brake firmly, in particular if you are parked on an incline.

### » Parking Your Vehicle

Do not park your vehicle near flammable objects, such as dry grass, oil, or timber. Heat from the exhaust can cause a fire.

### » When Stopped

#### NOTICE

##### Continuously variable transmission models

The following can damage the transmission:

- Depressing the accelerator and brake pedals simultaneously.
- Holding the vehicle in place when facing uphill by depressing the accelerator pedal.
- Moving the shift lever into **P** before the vehicle stops completely.

In extremely cold temperatures, the parking brake may freeze up if applied. If such temperatures are expected, do not apply the parking brake but, if parking on a slope, either turn the front wheels so they will contact the curb if the vehicle rolls down the slope or block the wheels to keep the vehicle from moving. If you do not take either precaution, the vehicle may roll unexpectedly, leading to a crash.



## About Your Multi-View Rear Camera

The audio/information screen can display your vehicle's rear view.

The display automatically changes to a rear view when the shift lever is moved to **R**.

### Multi-View Rear Camera Display Area

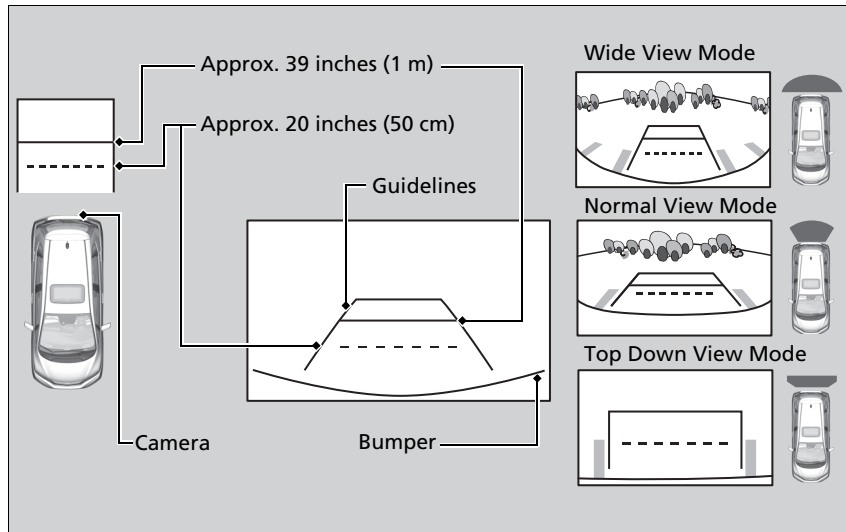

### About Your Multi-View Rear Camera

The rear camera view is restricted. You cannot see the corner ends of the bumper or what is underneath the bumper. Its unique lens also makes objects appear closer or farther than they actually are.

Visually confirm that it is safe to drive before backing up. Certain conditions (such as weather, lighting, and high temperatures) may also restrict the rear view. Do not rely on the rearview display which does not give you all information about conditions at the back of your vehicle.

If the camera lens is covered with dirt or moisture, use a soft, moist cloth to keep the lens clean and free of debris.

You can change the **Fixed Guideline** and **Dynamic Guideline** settings.

➤ **Customized Features P. 328**

#### Fixed Guideline

**On:** Guidelines appear when you shift into **R**.

**Off:** Guidelines do not appear.

#### Dynamic Guideline

**On:** Guidelines move according to the steering wheel direction.

**Off:** Guidelines do not move.

You can view three different camera angles on the rearview display.

**Models with color audio system**

Press the **LIST/SELECT** (selector) knob to switch the angle.

**Models with display audio system**

Touch the appropriate icon to switch the angle.



: Wide view



: Normal view



: Top down view

**All models**

- If the last used viewing mode was Wide or Normal, the same mode is selected the next time you put the transmission into **R**.
- If Top down view was last used before you turned off the engine, Wide View mode is selected next time you turn the ignition switch to ON **II**\*1 and put the transmission into **R**.
- If Top down view was last used more than 10 seconds after you put the transmission out of **R**, Wide View mode is selected the next time you put the transmission into **R**.

\*1: Models with the smart entry system have an **ENGINE START/STOP** button instead of an ignition switch.

## Fuel Information

### ■ Fuel recommendation

#### Unleaded gasoline, pump octane number 87 or higher

Use of lower octane gasoline can cause occasional metallic knocking noise in the engine and will result in decreased engine performance.

Use of gasoline with a pump octane less than 87 can lead to engine damage.

### ■ Top tier detergent gasoline

Because the level of detergency and additives in gasoline vary in the market, Honda endorses the use of "TOP TIER Detergent Gasoline" where available to help maintain the performance and reliability of your vehicle. TOP TIER Detergent Gasoline meets a new gasoline standard jointly established by leading automotive manufacturers to meet the needs of today's advanced engines.

Qualifying gasoline retailers will, in most cases, identify their gasoline as having met "TOP TIER Detergent Gasoline" standards at the retail location. This fuel is guaranteed to contain the proper level of detergent additives and be free of metallic additives. The proper level of detergent additives, and absence of harmful metallic additives in gasoline, help avoid build-up of deposits in your engine and emission control system.

For further important fuel-related information for your vehicle, or on information on gasoline that does not contain MMT, visit [www.hondacars.com](http://www.hondacars.com). In Canada, visit [www.honda.ca](http://www.honda.ca) for additional information on gasoline. For more information on top tier gasoline, visit [www.toptiergas.com](http://www.toptiergas.com).

### ■ Fuel tank capacity: 10.6 US gal (40 L)

### ⌘ Fuel Information

#### NOTICE

We recommend quality gasoline containing detergent additives that help prevent fuel system and engine deposits. In addition, in order to maintain good performance, fuel economy, and emissions control, we strongly recommend the use of gasoline that does NOT contain harmful manganese-based fuel additives such as MMT, if such gasoline is available.

Use of gasoline with these additives may adversely affect performance, and cause the malfunction indicator lamp on your instrument panel to come on. If this happens, contact a dealer for service.

Some gasoline today is blended with oxygenates such as ethanol. Your vehicle is designed to operate on oxygenated gasoline containing up to 15% ethanol by volume. Do not use gasoline containing methanol. If you notice any undesirable operating symptoms, try another service station or switch to another brand of gasoline.

## How to Refuel

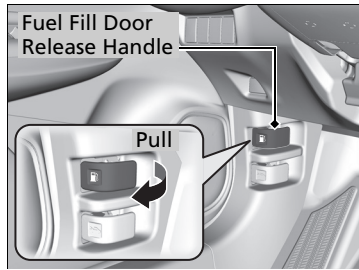

1. Stop your vehicle with the service station pump on the left side of the vehicle in the rear.
2. Turn off the engine.
3. Pull on the fuel fill door release handle under the lower left corner of the dashboard.
  - ▶ The fuel fill door opens.

### How to Refuel

#### **⚠ WARNING**

Gasoline is highly flammable and explosive. You can be burned or seriously injured when handling fuel.

- Stop the engine, and keep heat, sparks, and flame away.
- Handle fuel only outdoors.
- Wipe up spills immediately.

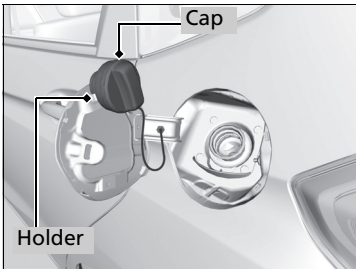
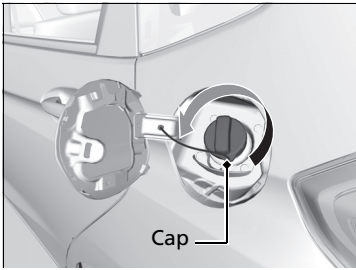

**4.** Remove the fuel fill cap slowly. If you hear a release of air, wait until this stops, then turn the knob slowly to open the fuel fill cap.

**5.** Place the fuel fill cap in the holder.

**6.** Insert the filler nozzle fully.

▶ When the tank is full, the fuel nozzle will click off automatically. This leaves space in the fuel tank in case the fuel expands with a change in the temperature.

**7.** After filling, replace the fuel fill cap, tightening it until you hear it click at least once.

▶ Shut the fuel fill door by hand.

⌘ How to Refuel

The filler nozzle automatically stops to leave space in the fuel tank so that fuel does not overflow as a result of changes in air temperature.

If the filler nozzle keeps turning off when the tank is not full, there may be a problem with the pump's fuel vapor recovery system. Try filling at another pump. If this does not fix the problem, consult a dealer.

Do not continue to add fuel after the filler nozzle has automatically stopped. Additional fuel can exceed the full tank capacity.

## Improving Fuel Economy and Reducing CO<sub>2</sub> Emissions

Achieving fuel economy and reducing CO<sub>2</sub> emissions is dependent on several factors, including driving conditions, load weight, idling time, driving habits, and vehicle condition. Depending on these and other factors, you may not achieve the rated fuel economy of this vehicle.

### Maintenance and Fuel Economy

You can optimize your fuel economy with proper maintenance of your vehicle. Always maintain your vehicle in accordance with the messages displayed on the information display\*/multi-information display\*.

- Use the recommended viscosity engine oil, displaying the API Certification Seal.
- Maintain the specified tire pressure.
- Do not load the vehicle with excess cargo.
- Keep your vehicle clean. A buildup of snow or mud on your vehicle's underside adds weight and increases wind resistance.

### Improving Fuel Economy and Reducing CO<sub>2</sub> Emissions

Direct calculation is the recommended method to determine actual fuel consumed while driving.

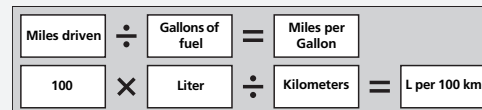

In Canada, posted fuel economy numbers are established following a simulated test. For more information on how this test is performed, please visit <http://oee.nrcan.gc.ca/>

# Maintenance

This chapter discusses basic maintenance.



## Before Performing Maintenance

Inspection and Maintenance .....	488
Safety When Performing Maintenance .....	489
Parts and Fluids Used in Maintenance Service .....	490
<b>Maintenance Minder™</b> .....	491

## Maintenance Under the Hood

Maintenance Items Under the Hood .....	499
Opening the Hood .....	500
Recommended Engine Oil .....	501
Oil Check .....	502
Adding Engine Oil .....	503
Changing the Engine Oil and Oil Filter .....	504
Engine Coolant .....	506

Transmission Fluid .....	508
Brake/Clutch * Fluid .....	509
Refilling Window Washer Fluid .....	510
<b>Replacing Light Bulbs</b> .....	511
<b>Checking and Maintaining Wiper Blades</b> .....	518
<b>Checking and Maintaining Tires</b>	
Checking Tires .....	522
Tire and Loading Information Label ..	524
Tire Labeling .....	524
DOT Tire Quality Grading (U.S. Vehicles) .....	526
Wear Indicators .....	528
Tire Service Life .....	528
Tire and Wheel Replacement .....	529

Tire Rotation .....	530
Winter Tires .....	531
<b>Battery</b> .....	532
<b>Remote Transmitter Care</b>	
Replacing the Button Battery .....	534
<b>Heating and Cooling System*/Climate Control System* Maintenance</b> .....	536
<b>Cleaning</b>	
Interior Care .....	537
Exterior Care .....	539
<b>Accessories and Modifications</b>	
Accessories .....	542
Modifications .....	542

\* Not available on all models

## Inspection and Maintenance

For your safety, perform all listed inspections and maintenance to keep your vehicle in good condition. If you become aware of any abnormality (noise, smell, insufficient brake fluid, oil residue on the ground, etc.), have your vehicle inspected by a dealer. (Note, however, that service at a dealer is not mandatory to keep your warranties in effect.)

### Types of Inspection and Maintenance

#### ■ Daily inspections

Perform inspections before long distance trips, when washing the vehicle, or when refueling.

#### ■ Periodic inspections

- Check the brake fluid level monthly.
  - **Brake/Clutch\* Fluid** P. 509
- Check the tire pressure monthly. Examine the tread for wear and foreign objects.
  - **Checking and Maintaining Tires** P. 522
- Check the operation of the exterior lights monthly.
  - **Replacing Light Bulbs** P. 511
- Check the condition of the wiper blades at least every six months.
  - **Checking and Maintaining Wiper Blades** P. 518

### Inspection and Maintenance

#### U.S. models

**Maintenance, replacement, or repair of emissions control devices and systems may be done by any automotive repair establishment or individuals using parts that are "certified" to EPA standards.**

According to state and federal regulations, failure to perform maintenance on the maintenance main items marked with # will not void your emissions warranties. However, all maintenance services should be performed in accordance with the intervals indicated by the information display\*/multi-information display(MID)\*.

➤ **Maintenance Service Items** P. 493

If you want to perform complex maintenance tasks that require more skills and tools, you can purchase a subscription to the Service Express website at [www.techinfo.honda.com](http://www.techinfo.honda.com).

➤ **Authorized Manuals** P. 584

If you want to perform maintenance yourself, make sure that you have the necessary tools and skills first. After performing maintenance, update the records in the separate maintenance booklet.



## Safety When Performing Maintenance

Some of the most important safety precautions are given here. However, we cannot warn you of every conceivable hazard that can arise in performing maintenance. Only you can decide whether or not you should perform a given task.

### Maintenance Safety

- To reduce the possibility of fire or explosion, keep cigarettes, sparks, and flames away from the battery and all fuel related parts.
- Never leave rags, towels, or other flammable objects under the hood.
  - ▶ Heat from the engine and exhaust can ignite them, causing a fire.
- To clean parts, use a commercially available degreaser or parts cleaner, not gasoline.
- Wear eye protection and protective clothing when working with the battery or compressed air.
- Engine exhaust contains carbon monoxide, which is poisonous and can kill you.
  - ▶ Only operate the engine if there is sufficient ventilation.

### Vehicle Safety

- The vehicle must be in a stationary condition.
  - ▶ Make sure your vehicle is parked on level ground, the parking brake is set, and the engine is off.
- Be aware that hot parts can burn you.
  - ▶ Make sure to let the engine and exhaust system cool thoroughly before touching vehicle parts.
- Be aware that moving parts can injure you.
  - ▶ Do not start the engine unless instructed, and keep your hands and limbs away from moving parts.

#### ⚠ Safety When Performing Maintenance

### ⚠ WARNING

Improperly maintaining this vehicle or failing to correct a problem before driving can cause a crash in which you can be seriously hurt or killed.

Always follow the inspection and maintenance recommendations according to the schedules in this owner's manual.

### ⚠ WARNING

Failure to properly follow maintenance instructions and precautions can cause you to be seriously hurt or killed.

Always follow the procedures and precautions in this owner's manual.

## Parts and Fluids Used in Maintenance Service

---

The use of Honda genuine parts and fluids is recommended when maintaining and servicing your vehicle. Honda genuine parts are manufactured according to the same high quality standards used in Honda vehicles.



If the engine oil life is less than 15%, you will see the Maintenance Minder messages appear on the information display or the multi-information display every time you turn the ignition switch to ON \*1. The messages notify you when to change the engine oil, or when to bring your vehicle to a dealer for indicated maintenance services.

Models without multi-information display

## To Use Maintenance Minder™

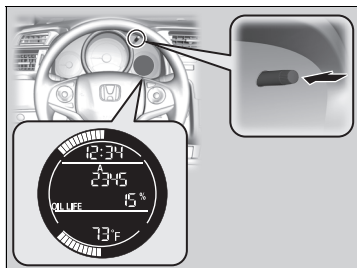
### ■ Displaying the Maintenance Minder Information



1. Turn the ignition switch to ON .
2. Press the  (select/reset) knob repeatedly until the engine oil life appears on the information display.

The Maintenance Minder indicator () stays on in the instrument panel after the engine oil life becomes **0%**. Have the indicated maintenance done by a dealer immediately.

### ▣ Displaying the Maintenance Minder Information

Based on the engine operating conditions, the remaining engine oil life is calculated and displayed as a percentage.





Displayed Engine Oil Life (%)	Calculated Engine Oil Life (%)
100	100 to 91
90	90 to 81
80	80 to 71
70	70 to 61
60	60 to 51
50	50 to 41
40	40 to 31
30	30 to 21
20	20 to 16
15	15 to 11
10	10 to 6
5	5 to 1
0	0

\*1: Models with the smart entry system have an **ENGINE START/STOP** button instead of an ignition switch.

Continued

## ■ Maintenance Minder Messages on the Information Display

To switch the display, press the  (select/reset) knob.

Oil Life Display	Explanation	Information	Maintenance Minder Indicator
	<p>The engine oil life indicator starts to appear along with other due soon maintenance item codes when the remaining oil life becomes 15 percent.</p>	<p>The engine oil is approaching the end of its service life.</p>	 Starts to come on when the remaining engine oil life becomes 15 percent. It goes off when the display is switched.
	<p>The <b>SERVICE</b> message also starts to appear along with the engine oil life indicator and the maintenance item codes.</p>	<p>The engine oil has almost reached the end of its service life, and the maintenance items should be inspected and serviced as soon as possible.</p>	
	<p>The remaining engine oil life has passed its service life, and a negative distance appears after driving over 10 miles (U.S. models) or 10 km (Canadian models). The negative distance on the display blinks.</p>	<p>The engine oil life has passed. The maintenance items must be inspected and serviced immediately.</p>	 Stays on as a reminder even when the display is switched.

## Maintenance Service Items

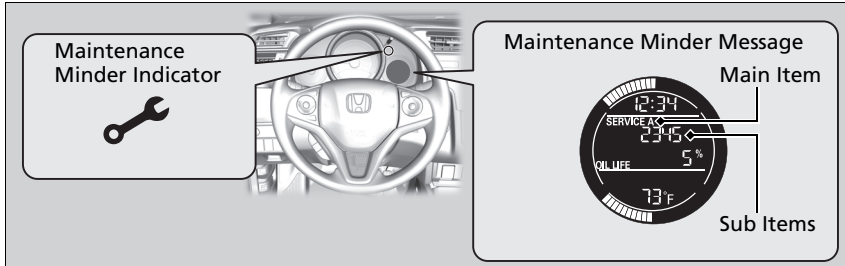

### Maintenance Service Items

- Independent of the Maintenance Minder information, replace the brake fluid every 3 years.
- Adjust the valves during services A, B, 1, 2, or 3 if they are noisy.

CODE	Maintenance Main Items
A	<ul style="list-style-type: none"> <li>• Replace engine oil*<sup>1</sup></li> </ul>
B	<ul style="list-style-type: none"> <li>• Replace engine oil*<sup>1</sup> and oil filter</li> <li>• Inspect front and rear brakes</li> <li>• Check parking brake adjustment</li> <li>• Inspect tie rod ends, steering gearbox, and boots</li> <li>• Inspect suspension components</li> <li>• Inspect driveshaft boots</li> <li>• Inspect brake hoses and lines (Including ABS/VSA)</li> <li>• Inspect all fluid levels and condition of fluids</li> <li>• Inspect exhaust system<sup>#</sup></li> <li>• Inspect fuel lines and connections<sup>#</sup></li> </ul>

CODE	Maintenance Sub Items
1	<ul style="list-style-type: none"> <li>• Rotate tires</li> </ul>
2	<ul style="list-style-type: none"> <li>• Replace air cleaner element*<sup>2</sup></li> <li>• Replace dust and pollen filter*<sup>3</sup></li> <li>• Inspect drive belt</li> </ul>
3	<ul style="list-style-type: none"> <li>• Replace transmission fluid</li> </ul>
4	<ul style="list-style-type: none"> <li>• Replace spark plugs</li> <li>• Inspect valve clearance</li> </ul>
5	<ul style="list-style-type: none"> <li>• Replace engine coolant</li> </ul>

\*2: If you drive in dusty conditions, replace the air cleaner element every 15,000 miles (24,000 km).

\*3: If you drive primarily in urban areas that have high concentrations of soot in the air from industry and from diesel-powered vehicles, replace the dust and pollen filter every 15,000 miles (24,000 km).

\*1: If a message **SERVICE** does not appear more than 12 months after the display is reset, change the engine oil every year.



# : See information on maintenance and emissions warranty.

Continued

## ■ Resetting the Display

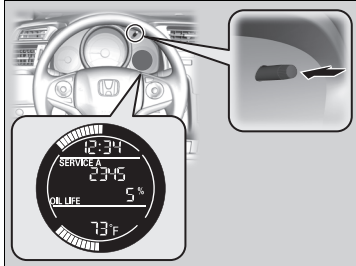
Reset the engine oil life display if you have performed the maintenance service.



1. Turn the ignition switch to ON **II**.
2. Display the engine oil life by repeatedly pressing the  (select/reset) knob.
3. Press and hold the  knob for ten seconds or more.
  - The engine oil life indicator and the maintenance item codes blink.
4. Press the  knob for five seconds or more.
  - The displayed maintenance items disappear, and the engine oil life display returns to **100%**.

## ►► Resetting the Display

### NOTICE

Failure to reset the Maintenance Minder™ display after a maintenance service results in the system showing incorrect maintenance intervals, which can lead to serious mechanical problems.

The dealer will reset the Maintenance Minder™ display after completing the required maintenance service. If someone other than a dealer performs maintenance service, reset the Maintenance Minder™ display yourself.



Models with multi-information display

## To Use Maintenance Minder™

### ■ Displaying the Maintenance Minder Information

Maintenance items, which should be serviced at the same time that you replace the engine oil, appear on the multi-information display.

You can view them on the engine oil life screen at any time.

1. Turn the ignition switch to ON \*1.
2. Press the  (Information) button repeatedly until the engine oil life appears on the multi-information display.

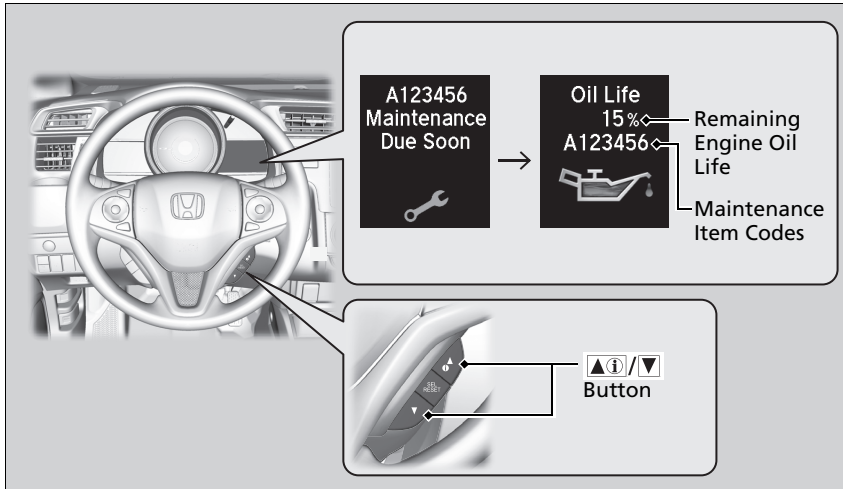

\*1: Models with the smart entry system have an **ENGINE START/STOP** button instead of an ignition switch.

### ▣ Displaying the Maintenance Minder Information







Based on the engine operating conditions, the remaining engine oil life is calculated and displayed as a percentage.

Displayed Engine Oil Life (%)	Calculated Engine Oil Life (%)
100	100 to 91
90	90 to 81
80	80 to 71
70	70 to 61
60	60 to 51
50	50 to 41
40	40 to 31
30	30 to 21
20	20 to 16
15	15 to 11
10	10 to 6
5	5 to 1
0	0

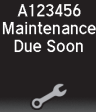
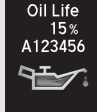
There is a list of maintenance main and sub items you can view on the information display.

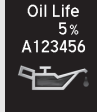
▣ **Maintenance Service Items** P. 497

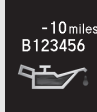
## Maintenance Minder Messages on the Multi-Information Display

Maintenance Message	Oil Life Display	Explanation	Information
<p><b>Maintenance Due Soon</b></p> 	<p>15 %</p> 	<p>The remaining engine oil life is 15 to 6 percent. Once you switch the display by pressing the  (Information) button, this message will go off.</p>	<p>The engine oil is approaching the end of its service life, and the maintenance items should be inspected and serviced soon.</p>
<p><b>Maintenance Due Now</b></p> 	<p>5 %</p> 	<p>The remaining engine oil life is 5 to 1 percent. Press the  button to switch to another display.</p>	<p>The engine oil has almost reached the end of its service life, and the maintenance items should be inspected and serviced as soon as possible.</p>
<p><b>Maintenance Past Due</b></p> 	<p>Negative Distance</p> 	<p>The remaining engine oil life has passed its service life, and a negative distance appears after driving over 10 miles (U.S. models) or 10 km (Canadian models). Press the  button to switch to another display.</p>	<p>The engine oil life has passed. The maintenance items must be inspected and serviced immediately.</p>

The system message indicator (ⓘ) comes on along with the Maintenance Minder message.



## Maintenance Service Items

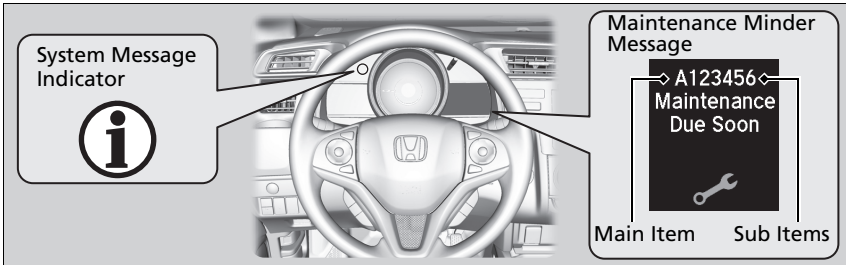

### » Maintenance Service Items

- Independent of the Maintenance Minder information, replace the brake fluid every 3 years.
- Adjust the valves during services A, B, 1, 2, or 3 if they are noisy.

CODE	Maintenance Main Items
A	<ul style="list-style-type: none"> <li>• Replace engine oil*<sup>1</sup></li> </ul>
B	<ul style="list-style-type: none"> <li>• Replace engine oil*<sup>1</sup> and oil filter</li> <li>• Inspect front and rear brakes</li> <li>• Check parking brake adjustment</li> <li>• Inspect tie rod ends, steering gearbox, and boots</li> <li>• Inspect suspension components</li> <li>• Inspect driveshaft boots</li> <li>• Inspect brake hoses and lines (Including ABS/VSA)</li> <li>• Inspect all fluid levels and condition of fluids</li> <li>• Inspect exhaust system<sup>#</sup></li> <li>• Inspect fuel lines and connections<sup>#</sup></li> </ul>

CODE	Maintenance Sub Items
1	<ul style="list-style-type: none"> <li>• Rotate tires</li> </ul>
2	<ul style="list-style-type: none"> <li>• Replace air cleaner element*<sup>2</sup></li> <li>• Replace dust and pollen filter*<sup>3</sup></li> <li>• Inspect drive belt</li> </ul>
3	<ul style="list-style-type: none"> <li>• Replace transmission fluid</li> </ul>
4	<ul style="list-style-type: none"> <li>• Replace spark plugs</li> <li>• Inspect valve clearance</li> </ul>
5	<ul style="list-style-type: none"> <li>• Replace engine coolant</li> </ul>

\*2: If you drive in dusty conditions, replace the air cleaner element every 15,000 miles (24,000 km).

\*3: If you drive primarily in urban areas that have high concentrations of soot in the air from industry and from diesel-powered vehicles, replace the dust and pollen filter every 15,000 miles (24,000 km).

\*1: If a message **Maintenance** does not appear more than 12 months after the display is reset, change the engine oil every year.

#: See information on maintenance and emissions warranty.

## ■ Resetting the Display

Reset the maintenance minder information display if you have performed the maintenance service.

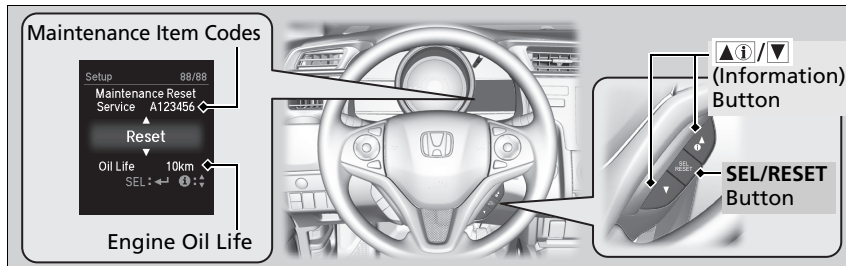

1. Turn the ignition switch to ON \*1.
2. Press the button to select **Maintenance Info.**, then press the **SEL/RESET** button.
3. Select **Reset** with the button, then press the **SEL/RESET** button.
  - ▶ The displayed maintenance items disappear, and the engine oil life display returns to **100%**.

To cancel the oil life reset mode, select **Cancel**, then press the **SEL/RESET** button.

\*1: Models with the smart entry system have an **ENGINE START/STOP** button instead of an ignition switch.

## ▶▶ Resetting the Display

### NOTICE

Failure to reset the Maintenance Minder™ display after a maintenance service results in the system showing incorrect maintenance intervals, which can lead to serious mechanical problems.

The dealer will reset the Maintenance Minder™ display after completing the required maintenance service. If someone other than a dealer performs maintenance service, reset the Maintenance Minder™ display yourself.

## Maintenance Items Under the Hood

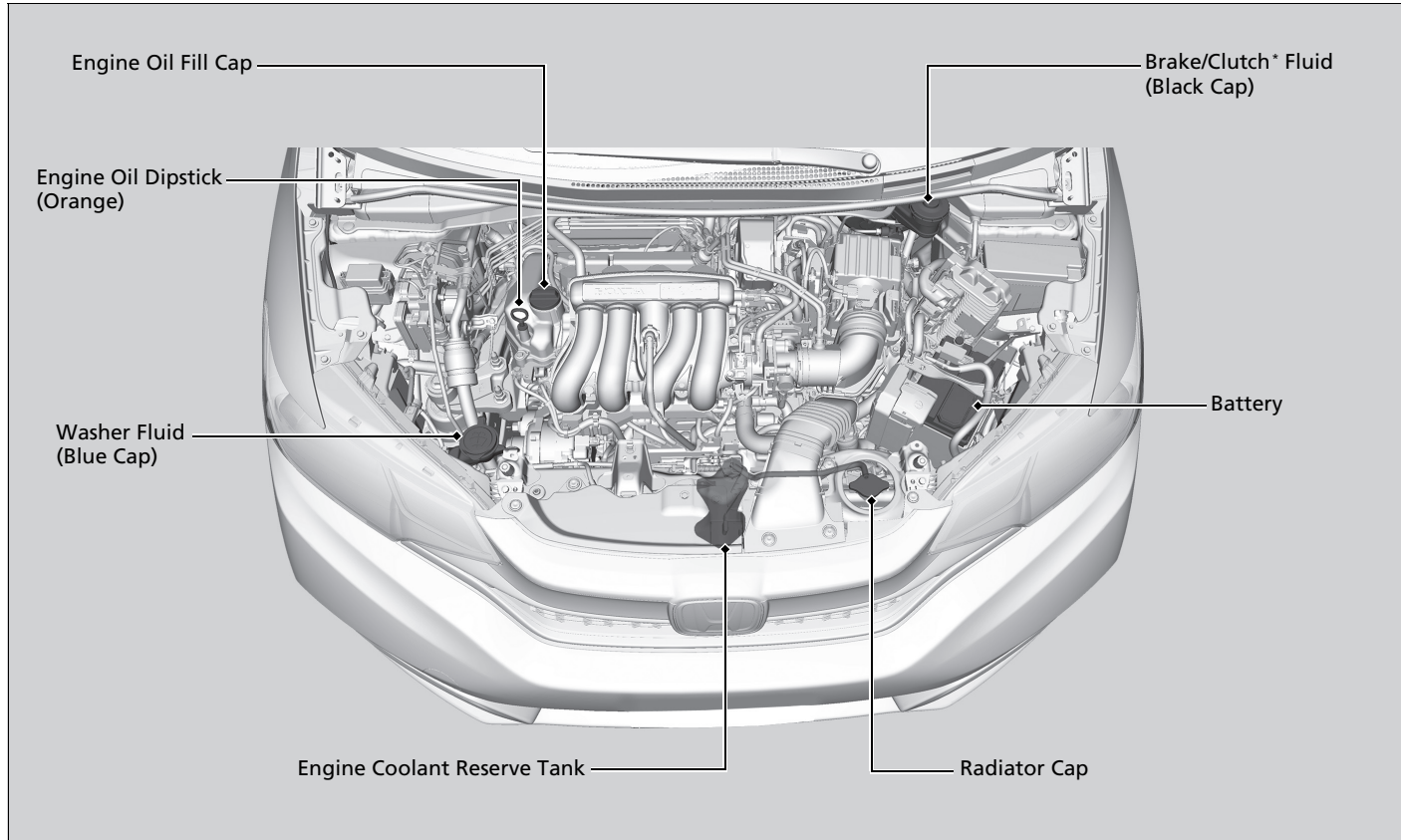

\* Not available on all models

## Opening the Hood

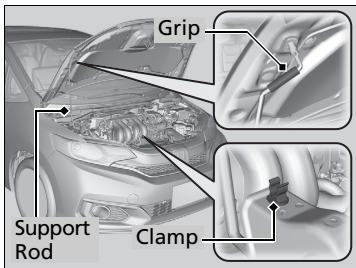
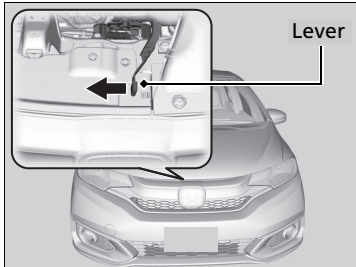
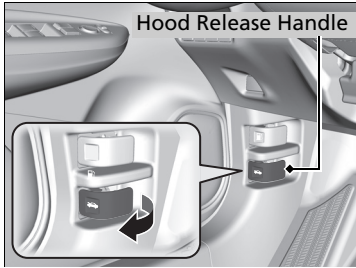

1. Park the vehicle on a level surface, and set the parking brake.
2. Pull the hood release handle under the driver's side lower outside corner of the dashboard.  
► The hood will pop up slightly.
3. Push the hood latch lever (located under the front edge of the hood to the center) to the side and raise the hood. Once you have raised the hood slightly, you can release the lever.

4. Remove the support rod from the clamp using the grip. Mount the support rod in the hood.

When closing, remove the support rod, and stow it in the clamp, then gently lower the hood. Remove your hand at a height of approximately 12 inches (30 cm) and let the hood close.

### ►► Opening the Hood

#### NOTICE

Do not open the hood when the wiper arms are raised. The hood will strike the wipers, resulting in damage to the hood and/or the wipers.

When closing the hood, check that the hood is securely latched.

If the hood latch lever moves stiffly, or if you can open the hood without lifting the lever, the latch mechanism should be cleaned and lubricated.

## Recommended Engine Oil

- **Genuine Honda Motor Oil**
- **Premium-grade 0W-16, 0W-20 detergent oil with an API Certification Seal on the container.**



Oil is a major contributor to your engine's performance and longevity. If you drive the vehicle with insufficient or deteriorated oil, the engine may fail or be damaged.

This seal indicates the oil is energy conserving and that it meets the American Petroleum Institute's latest requirements.

Use a Genuine Honda Motor Oil or another commercial engine oil of suitable viscosity for the ambient temperature as shown.

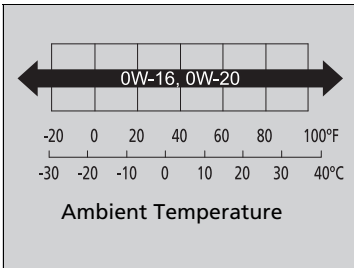

### ■ Synthetic oil

You may also use synthetic motor oil if it is labeled with the API Certification Seal and is the specified viscosity grade.

### ☒ Recommended Engine Oil

#### Engine Oil Additives

Your vehicle does not require oil additives. In fact, they may adversely affect the engine performance and durability.

## Oil Check

We recommend that you check the engine oil level every time you refuel.

Park the vehicle on level ground.

Wait approximately three minutes after turning the engine off before you check the oil.

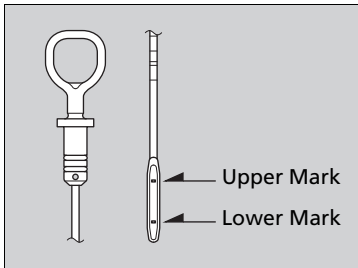
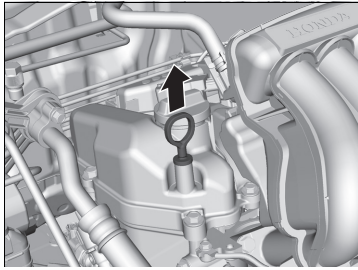

1. Remove the dipstick (orange).
2. Wipe the dipstick with a clean cloth or paper towel.
3. Insert the dipstick back all the way into its hole.
4. Remove the dipstick again, and check the level. It should be between the upper and lower marks. Add oil if necessary.

### Oil Check

If the oil level is near or below the lower mark, slowly add oil, being careful not to overfill.

## Adding Engine Oil

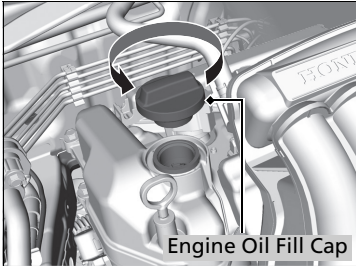

1. Unscrew and remove the engine oil fill cap.
2. Add oil slowly.
3. Reinstall the engine oil fill cap, and tighten it securely.
4. Wait for three minutes and recheck the engine oil dipstick.

### ⚠ Adding Engine Oil

If any oil spills, wipe it away immediately. Spilled oil may damage the engine compartment components.

#### **NOTICE**

Do not fill the engine oil above the upper mark. Overfilling the engine oil can result in leaks and engine damage.

## Changing the Engine Oil and Oil Filter

You must change the engine oil and oil filter regularly in order to maintain the engine's lubrication. The engine may be damaged if they are not changed regularly.

Change the oil and filter in accordance with the Maintenance Minder message on the information display\*/multi-information display\*.

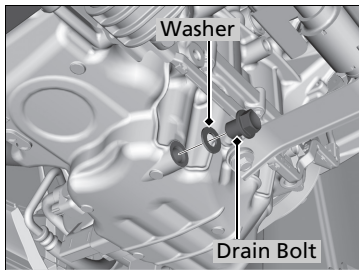
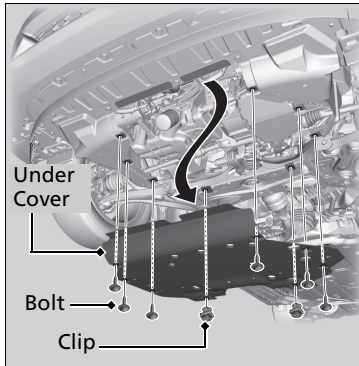

1. Run the engine until it reaches normal operating temperature, and then turn the engine off.
2. Open the hood and remove the engine oil fill cap.
3. Remove the bolts and clips on the undercarriage and remove the under cover.
4. Remove the drain bolt and washer from the bottom of the engine, and drain the oil into a suitable container.

### ► Changing the Engine Oil and Oil Filter

#### NOTICE

You may damage the environment if you do not dispose of the oil in a suitable way. If you are changing the oil by yourself, appropriately dispose of the used oil. Put the oil in a sealed container and take it to a recycling center. Do not throw the oil away into a garbage can or onto the ground.



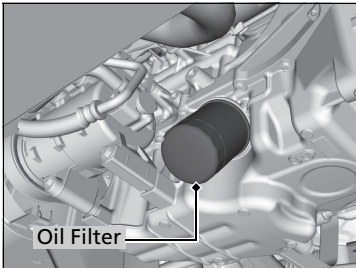

5. Remove the oil filter and dispose of the remaining oil.
6. Check that the filter gasket is not stuck to the engine contact surface.
  - If it is stuck, you must detach it.
7. Wipe away dirt and dust adhering to the contact surface of the engine block, and install a new oil filter.
  - Apply a light coat of new engine oil to the oil filter gasket.
8. Put a new washer on the drain bolt, then reinstall the drain bolt.
  - Tightening torque:  
29 lbf·ft (39 N·m, 4.0 kgf·m)
9. Pour the recommended engine oil into the engine.
  - Engine oil change capacity (including filter):  
3.5 US qt (3.3 L)
10. Reinstall the engine oil fill cap securely and start the engine.
11. Run the engine for a few minutes, and then check that there is no leak from the drain bolt or oil filter.
12. Stop the engine, wait for three minutes, and then check the oil level on the dipstick.
  - If necessary, add more engine oil.

#### ✘ Changing the Engine Oil and Oil Filter

You will need a special wrench to replace the oil filter. You can buy this wrench from a dealer.

When installing the new oil filter, follow the instructions supplied with the oil filter.

Reinstall the engine oil fill cap. Start the engine. The low oil pressure indicator should go off within five seconds. If it does not, turn off the engine, and check your work.

## Engine Coolant

### Specified coolant: Honda Long Life Antifreeze/Coolant Type 2

This coolant is premixed with 50% antifreeze and 50% water. Do not add any straight antifreeze or water.

We recommend you check the engine coolant level every time you refuel. Check the reserve tank first. If it is completely empty, also check the coolant level in the radiator. Add the engine coolant accordingly.

### Reserve Tank

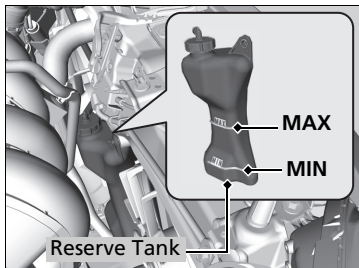

1. Make sure the engine and radiator are cool.
2. Check the amount of coolant in the reserve tank.
  - If the coolant level is below the **MIN** mark, add the specified coolant until it reaches the **MAX** mark.

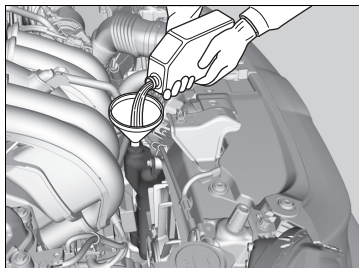

3. Inspect the cooling system for leaks.

### Engine Coolant

## ⚠ WARNING

Removing the radiator cap while the engine is hot can cause the coolant to spray out, seriously scalding you.

Always let the engine and radiator cool down before removing the radiator cap.

### NOTICE

Genuine Honda engine coolant is a 50/50 mixture of antifreeze and water that can withstand freezing at temperatures as low as about -31°F (-35°C). If your vehicle is consistently subjected to temperatures below this, the concentration of antifreeze in the coolant should be increased. Consult a dealer for details.

If Honda antifreeze/coolant is not available, you may use another major brand of non-silicate coolant as a temporary replacement. Check that it is a high quality coolant recommended for aluminum engines. Continued use of any non-Honda coolant can result in corrosion, causing the cooling system to malfunction or fail. Have the cooling system flushed and refilled with Honda antifreeze/coolant as soon as possible.

Do not add rust inhibitors or other additives to your vehicle's cooling system. They may not be compatible with the coolant or with the engine components.

## Radiator

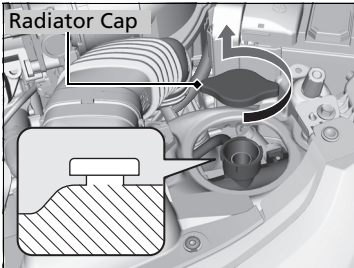

- 1. Make sure the engine and radiator are cool.**
- 2.** Turn the radiator cap 1/8 turn counter-clockwise and relieve any pressure in the cooling system.
- 3.** Push down and turn the radiator cap counter-clockwise to remove it.
- 4.** The coolant level should be up to the base of the filler neck. Add coolant if it is low.
- 5.** Put the radiator cap back on, and tighten it fully.

## Radiator

### NOTICE

Pour the fluid slowly and carefully so you do not spill any. Clean up any spills immediately; they can damage components in the engine compartment.

## Transmission Fluid

### Continuously variable transmission models

#### Continuously Variable Transmission (CVT) Fluid

##### Specified fluid: Honda HCF-2 Transmission Fluid

Have a dealer check the fluid level and replace if necessary.

Do not attempt to check or change the continuously variable transmission (CVT) fluid yourself.

### Manual transmission models

#### Manual Transmission Fluid

##### Specified fluid: Honda Manual Transmission Fluid (MTF)

Have a dealer check the fluid level and replace if necessary.

Do not attempt to check or change the manual transmission fluid yourself.

### Continuously Variable Transmission (CVT) Fluid

#### NOTICE

##### Do not mix HCF-2 with other transmission fluids

Using a transmission fluid other than HCF-2 may adversely affect the operation and durability of your vehicle's transmission, and damage the transmission. Any damage caused by using a transmission fluid that is not equivalent to HCF-2 is not covered by Honda's new vehicle limited warranty.

### Manual Transmission Fluid

If Honda MTF is not available, you may use the API certificated SAE 0 W-20 or 5 W-20 viscosity motor oil as a temporary measure.

Replace with MTF as soon as possible. Motor oil does not contain the proper additives for the transmission and continued use can cause decreased shifting performance and lead to transmission damage.

## Brake/Clutch\* Fluid

**Specified fluid: Honda Heavy Duty Brake Fluid DOT 3**

Use the same fluid for both the brakes and clutch.

### Checking the Brake Fluid

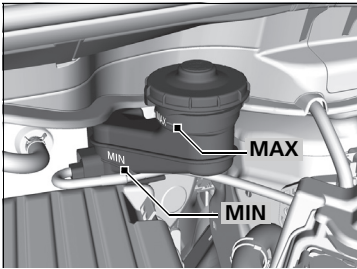

The fluid level should be between the **MIN** and **MAX** marks on the side of the reservoir.

#### Manual transmission models

The brake fluid reservoir is also used for your vehicle's clutch fluid. As long as you keep the brake fluid level as instructed above, there is no need for checking the clutch fluid level.

#### Brake/Clutch\* Fluid

##### NOTICE

Brake fluid marked DOT 5 is not compatible with your vehicle's braking system and can cause extensive damage.

If the specified brake fluid is not available, you should use only DOT 3 or DOT 4 fluid from a sealed container as a temporary replacement.

Using any non-Honda brake fluid can cause corrosion and decrease the longevity of the system. Have the brake system flushed and refilled with Honda Heavy Duty Brake Fluid DOT 3 as soon as possible.

If the brake fluid level is at or below the **MIN** mark, have a dealer inspect the vehicle for leaks or worn brake pads as soon as possible.

\* Not available on all models

## Refilling Window Washer Fluid

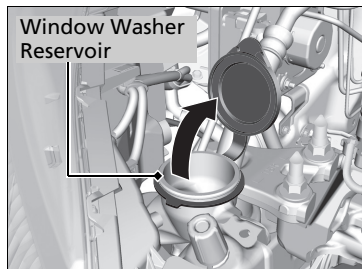

### Models without washer level sensor

Check the amount of window washer fluid by looking at the reservoir.  
If the level is low, fill the washer reservoir.

### Models with washer level sensor

If the washer fluid is low, the washer level indicator\* appears on the instrument panel or a message appears on the multi-information display\*.

Pour the washer fluid carefully. Do not overflow the reservoir.

### ►► Refilling Window Washer Fluid

#### NOTICE

Do not use engine antifreeze or a vinegar/water solution in the window washer reservoir. Antifreeze can damage your vehicle's paint. A vinegar/water solution can damage the window washer pump.

# Replacing Light Bulbs

## Headlight Bulbs

When replacing, use the following bulbs.

**High/Low beam headlight: 60/55 W (H4LL/HB2LL\*, H4/HB2\* for halogen bulb type)**

### High/Low Beam Headlight

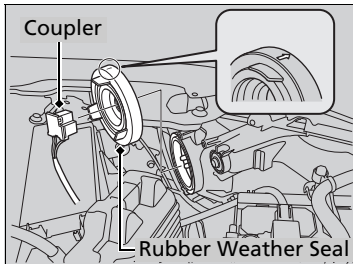

1. Remove the coupler.
2. Remove the rubber weather seal.

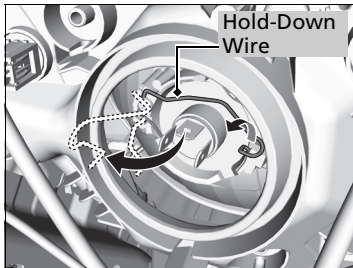

3. Remove the hold-down wire, then remove the bulb.
4. Insert a new bulb.

### Headlight Bulbs

#### NOTICE

Halogen bulbs get very hot when lit.

Oil, perspiration, or a scratch on the glass can cause the bulb to overheat and shatter.

The headlight aim is set by the factory, and does not need to be adjusted. However, if you regularly carry heavy items in the cargo area, have the aiming readjusted at a dealer or by a qualified technician.

When replacing a halogen bulb, handle it by its base, and protect the glass from contact with your skin or hard objects. If you touch the glass, clean it with denatured alcohol and a clean cloth.

\* Not available on all models

*Continued*

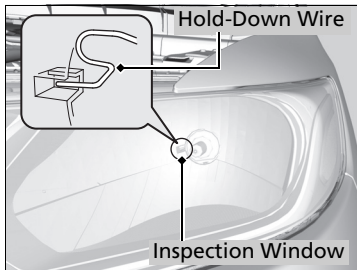

5. Reinstall the hold-down wire. Hook the end of the wire on the knob in the slot.
  - You can see if the hold-down wire is in the right place from the inspection window.
6. Reinstall the rubber weather seal.
7. Insert the coupler into the connector of the bulb.

## Front Turn Signal/Parking Light Bulbs

When replacing, use the following bulbs.

**Front Turn Signal/Parking Light: 28/8 W (Amber)**

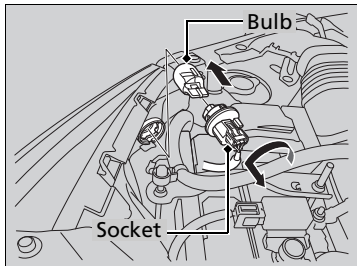

1. Turn the socket counter-clockwise and remove it.
2. Remove the old bulb and insert a new bulb.



## Side Marker Light Bulbs

When replacing, use the following bulbs.

### Side Marker Light: 3CP

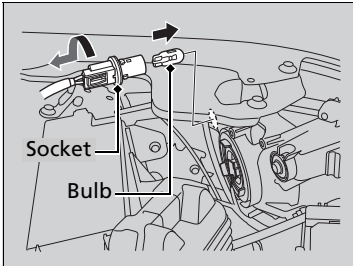

1. Turn the socket counter-clockwise and remove it.
2. Remove the old bulb and insert a new bulb.

## Fog Light Bulbs \*

When replacing, use the following bulbs.

### Fog Light: 35W (H8 for halogen bulb type)

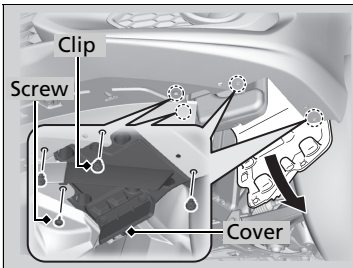

1. Remove the screws using a Phillips-head screwdriver and remove the holding clips using a flat-tip screwdriver.
2. Pull the under part of the inner fender cover down.

### ☒ Fog Light Bulbs \*

#### NOTICE

Halogen bulbs get very hot when lit. Oil, perspiration, or a scratch on the glass can cause the bulb to overheat and shatter.

When replacing a halogen bulb, handle it by its plastic case, and protect the glass from contact with your skin or hard objects. If you touch the glass, clean it with denatured alcohol and a clean cloth.

\* Not available on all models

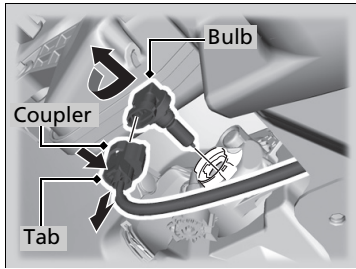

3. Push the tab to remove the coupler.
4. Rotate the old bulb counter-clockwise to remove.
5. Insert a new bulb into the fog light assembly and turn it clockwise.
6. Insert the coupler into the connector of the bulb.

## Side Turn Signal/Emergency Indicator Lights\*

Door mirror side turn lights are LED type. Have an authorized Honda dealer inspect and replace the light assembly.

### ▶▶ Fog Light Bulbs\*

#### ▶▶ Holding clip

Insert a flat-tip screwdriver, lift and remove the central pin to remove the clip.

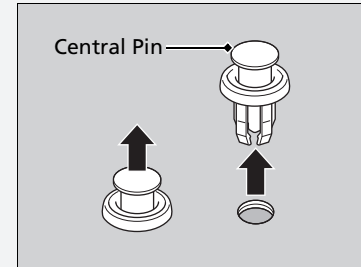

Insert the clip with the central pin raised, and push until it is flat.

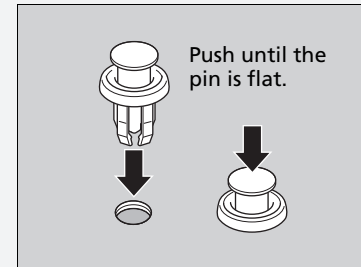

## Back-Up Light and Rear Turn Signal Light Bulbs

When replacing, use the following bulbs.

**Back-Up Light: 21 W**  
**Rear Turn Signal Light: 21 W**

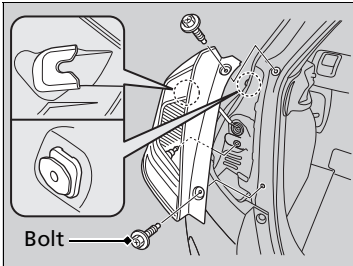

1. Use a Phillips-head screwdriver to remove the bolts.
2. Pull the light assembly out of the rear pillar.

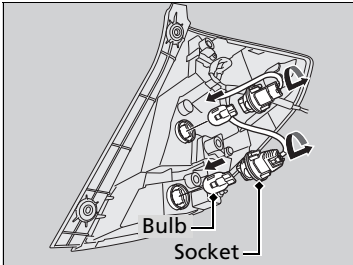

3. Turn the socket counter-clockwise and remove it. Remove the old bulb.
4. Insert a new bulb.
5. Slide the light assembly onto the guide on the body.

## **Brake/Tail/Rear Side Marker Lights**

---

Brake/tail/rear side marker lights are LED type. Have an authorized Honda dealer inspect and replace the light assembly.

## **High-Mount Brake Light**

---

High-mount brake light is LED type. Have an authorized Honda dealer inspect and replace the light assembly.

## Rear License Plate Light Bulbs

When replacing, use the following bulb.

### Rear License Plate Light: 5 W

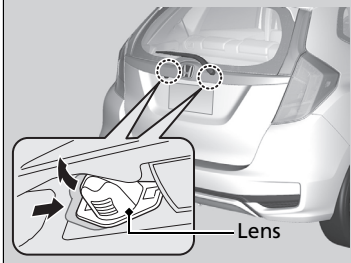

1. Push the lens on the left and pull out the lens and the socket attached to it.

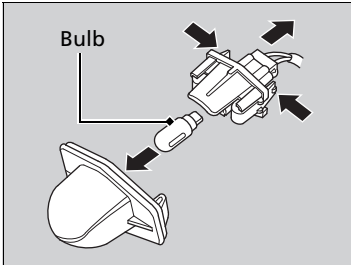

2. Remove the license plate light assembly by squeezing the tabs on both sides of the socket.

3. Remove the old bulb and insert a new bulb.

## Checking Wiper Blades

If the wiper blade rubber has deteriorated, it will leave streaks and the hard surfaces of the blade may scratch the window glass.

## Changing the Front Wiper Blade Rubber

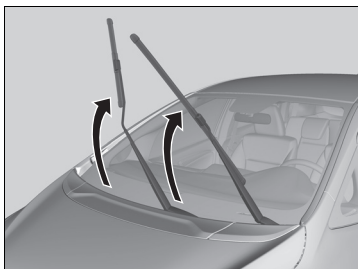

1. Lift the driver side wiper arm first, then the passenger side.

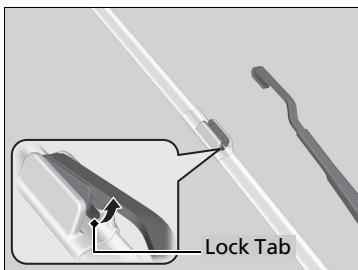

2. Press and hold the tab, then slide the holder off the wiper arm.

### Changing the Front Wiper Blade Rubber

#### NOTICE

Avoid dropping the wiper arm onto the windshield, it may damage the wiper arm and/or the windshield.

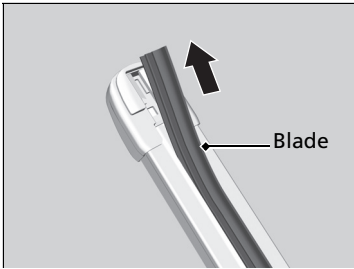

3. Slide the wiper blade out of the holder by pulling the tabbed end out.

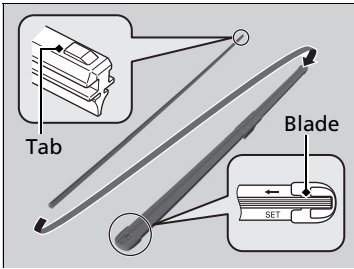

4. Slide the new wiper blade onto the holder from the bottom end.

▶ The tab on the blade should fit in the indent of the top of the wiper holder.

5. Slide the holder onto the wiper arm securely.

6. Lower the passenger side wiper arm first, then the driver side.

## Changing the Rear Wiper Blade Rubber

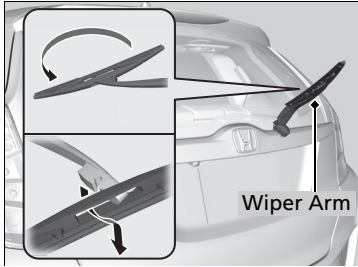

1. Raise the wiper arm off.
2. Pivot the bottom end of the wiper blade up until it comes off from the wiper arm.

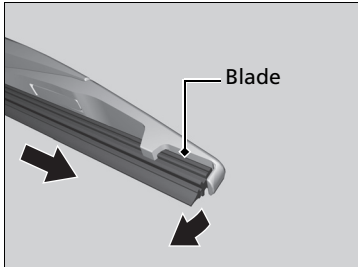

3. Slide the wiper blade out from the end with the indent.

### ▶▶ Changing the Rear Wiper Blade Rubber

#### NOTICE

Avoid dropping the wiper arm; it may damage the rear window.



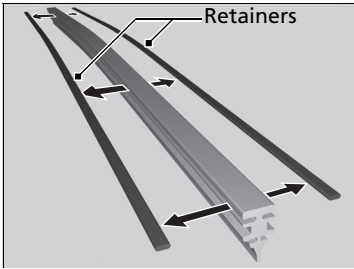

4. Remove the retainers from the wiper blade and mount to a new rubber blade.

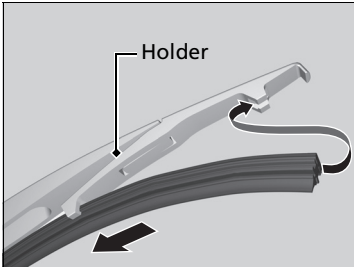

5. Slide the wiper blade onto the holder.
  - ▶ Make sure it is engaged correctly, then install the wiper blade assembly onto the wiper arm.

## Checking Tires

To safely operate your vehicle, your tires must be of the proper type and size, in good condition with adequate tread, and properly inflated.

### ■ Inflation guidelines

Properly inflated tires provide the best combination of handling, tread life, and comfort. Refer to the driver's doorjamb label or specification's page for the specified pressure.

Underinflated tires wear unevenly, adversely affect handling and fuel economy, and are more likely to fail from overheating.

Overinflated tires make your vehicle ride harshly, are more prone to road hazards, and wear unevenly.

Every day before you drive, look at each of the tires. If one looks lower than the others, check the pressure with a tire gauge.

At least once a month or before long trips, use a gauge to measure the pressure in all tires, including the spare. Even tires in good condition can lose 1-2 psi (10-20 kPa, 0.1-0.2 kgf/cm<sup>2</sup>) per month.

### 🔧 Checking Tires

## WARNING

Using tires that are excessively worn or improperly inflated can cause a crash in which you can be seriously hurt or killed.

Follow all instructions in this owner's manual regarding tire inflation and maintenance.

Measure the air pressure when tires are cold. This means the vehicle has been parked for at least three hours, or driven less than 1 mile (1.6 km). If necessary, add or release air until the specified pressure is reached.

If checked when hot, tire pressure can be as much as 4-6 psi (30-40 kPa, 0.3-0.4 kgf/cm<sup>2</sup>) higher than if checked when cold.

Have a dealer check the tires if you feel a consistent vibration while driving. New tires and any that have been removed and reinstalled should be properly balanced.

### U.S. models

Whenever tire pressure is adjusted, you must calibrate the TPMS.

🔧 **TPMS Calibration** P. 463

Check the spare tire pressure once a month or before long trips.

■ **Inspection guidelines**

Every time you check inflation, also examine the tires and valve stems.

Look for:

- Bumps or bulges on the side or in the tread. Replace the tire if you find any cuts, splits, or cracks in the side of the tire. Replace it if you see fabric or cord.
- Remove any foreign objects and inspect for air leaks.
- Uneven tread wear. Have a dealer check the wheel alignment.
- Excessive tread wear.

📄 **Wear Indicators** P. 528

- Cracks or other damage around valve stem.

📄 **Checking Tires**

**High speed driving**

We recommend that you do not drive faster than the posted speed limits and conditions allow. If you drive at sustained high speeds (over 99 mph or 160 km/h), adjust the cold tire pressures as shown below to avoid excessive heat build up and sudden tire failure.

Tire Size	185/55R16 83H	
Pressure	Front	35 psi (240 kPa, 2.4 kgf/cm <sup>2</sup> )
	Rear	33 psi (230 kPa, 2.3 kgf/cm <sup>2</sup> )

## Tire and Loading Information Label

The label attached to the driver’s doorjamb provides necessary tire and loading information.

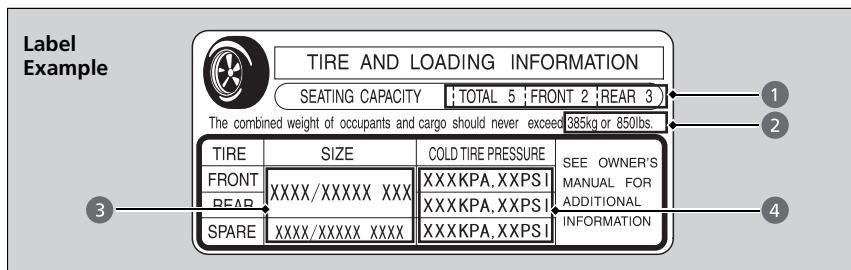

### ▶▶ Tire and Loading Information Label

The tire and loading information label attached to the driver’s doorjamb contains:

- 1 The number of people your vehicle can carry.
- 2 The total weight your vehicle can carry. Do not exceed this weight.
- 3 The original tire sizes for front, rear, and spare.
- 4 The proper cold tire pressure for front, rear, and spare.

## Tire Labeling

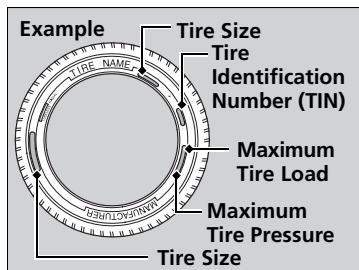

The tires that came on your vehicle have a number of markings. Those you should be aware of are described below.

### ▶▶ Tire Sizes

Following is an example of tire size with an explanation of what each component means.

#### **185/55R16 83H**

- 185: Tire width in millimeters.
- 55: Aspect ratio (the tire’s section height as a percentage of its width).
- R: Tire construction code (R indicates radial).
- 16: Rim diameter in inches.
- 83: Load index (a numerical code associated with the maximum load the tire can carry).
- H: Speed symbol (an alphabetical code indicating the maximum speed rating).

### Tire Sizes

Whenever tires are replaced, they should be replaced with tires of the same size.

## ■ Tire Identification Number (TIN)

The tire identification number (TIN) is a group of numbers and letters that look like the example in the side column. TIN is located on the sidewall of the tire.

## ■ Glossary of Tire Terminology

**Cold Tire Pressure** – The tire air pressure when the vehicle has been parked for at least three hours or driven less than 1 mile (1.6 km).

**Load Rating** – Means the maximum load that a tire is rated to carry for a given inflation pressure.

**Maximum Inflation Pressure** – The maximum tire air pressure that the tire can hold.

**Maximum Load Rating** – Means the load rating for a tire at the maximum permissible inflation pressure for that tire.

**Recommended Inflation Pressure** – The cold tire inflation pressure recommended by the manufacturer.

**Treadwear Indicators (TWI)** – Means the projections within the principal grooves designed to give a visual indication of the degrees of wear of the tread.

### ☒ Tire Identification Number (TIN)

#### **DOT B97R FW6X 2209**

DOT: This indicates that the tire meets all requirements of the U.S. Department of Transportation.

B97R: Manufacturer's identification mark.

FW6X: Tire type code.

22 09: Date of manufacture.

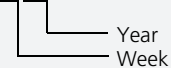

## DOT Tire Quality Grading (U.S. Vehicles)

The tires on your vehicle meet all U.S. Federal Safety Requirements. All tires are also graded for treadwear, traction, and temperature performance according to Department of Transportation (DOT) standards. The following explains these gradings.

### ■ Uniform Tire Quality Grading

Quality grades can be found where applicable on the tire sidewall between tread shoulder and maximum section width.

### ■ Treadwear

The treadwear grade is a comparative rating based on the wear rate of the tire when tested under controlled conditions on a specified government test course. For example, a tire graded 150 would wear one and one-half (1 1/2) times as well on the government course as a tire graded 100. The relative performance of tires depends upon the actual conditions of their use, however, and may depart significantly from the norm due to variations in driving habits, service practices and differences in road characteristics and climate.

### ▣ Uniform Tire Quality Grading

For example:

**Treadwear 200**  
**Traction AA**  
**Temperature A**

All passenger car tires must conform to Federal Safety Requirements in addition to these grades.

## ■ Traction

The traction grades, from highest to lowest, are AA, A, B, and C. Those grades represent the tire's ability to stop on wet pavement as measured under controlled conditions on specified government test surfaces of asphalt and concrete. A tire marked C may have poor traction performance.

## ■ Temperature

The temperature grades are A (the highest), B, and C, representing the tire's resistance to the generation of heat and its ability to dissipate heat when tested under controlled conditions on a specified indoor laboratory test wheel. Sustained high temperature can cause the material of the tire to degenerate and reduce tire life, and excessive temperature can lead to sudden tire failure. The grade C corresponds to a level of performance which all passenger car tires must meet under the Federal Motor Vehicle Safety Standard No. 109. Grades B and A represent higher levels of performance on the laboratory test wheel than the minimum required by law.

### ⌘ Traction

Warning: The traction grade assigned to this tire is based on straight-ahead braking traction tests, and does not include acceleration, cornering, hydroplaning, or peak traction characteristics.

### ⌘ Temperature

Warning: The temperature grade for this tire is established for a tire that is properly inflated and not overloaded. Excessive speed, underinflation, or excessive loading, either separately or in combination, can cause heat buildup and possible tire failure.

## Wear Indicators

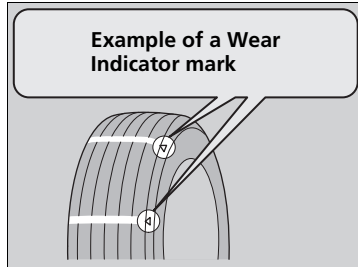

The groove where the wear indicator is located is 1/16 inch (1.6 mm) shallower than elsewhere on the tire. If the tread has worn so that the indicator is exposed, replace the tire.

**Worn out tires have poor traction on wet roads.**

## Tire Service Life

The life of your tires is dependent on many factors, including driving habits, road conditions, vehicle loading, inflation pressure, maintenance history, speed, and environmental conditions (even when the tires are not in use).

In addition to regular inspections and inflation pressure maintenance, it is recommended that you have annual inspections performed once the tires reach five years old. All tires, including the spare, should be removed from service after 10 years from the date of manufacture, regardless of their condition or state of wear.



## Tire and Wheel Replacement

Replace your tires with radials of the same size, load range, speed rating, and maximum cold tire pressure rating (as shown on the tire's sidewall). Using tires of a different size or construction can cause certain vehicle systems such as the ABS and Vehicle Stability Assist® (VSA®) system to work incorrectly.

It is best to replace all four tires at the same time. If that isn't possible, replace the front or rear tires in pairs.

Make sure that the wheel's specifications match those of the original wheels.

### ⚠ Tire and Wheel Replacement

#### **⚠ WARNING**

Installing improper tires on your vehicle can affect handling and stability. This can cause a crash in which you can be seriously hurt or killed.

Always use the size and type of tires recommended in this owner's manual.

## Tire Rotation

Rotating tires according to the maintenance messages on the information display\*/ multi-information display\* helps to distribute wear more evenly and increase tire life.

### ■ Tires without rotation marks

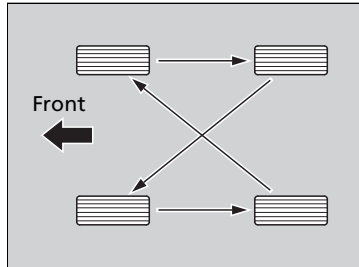

Rotate the tires as shown here.

### ■ Tires with rotation marks

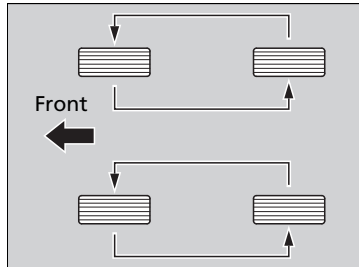

Rotate the tires as shown here.

### ▶▶ Tire Rotation

Tires with directional tread patterns should only be rotated front to back (not from one side to the other). Directional tires should be mounted with the rotation indication mark facing forward, as shown below.

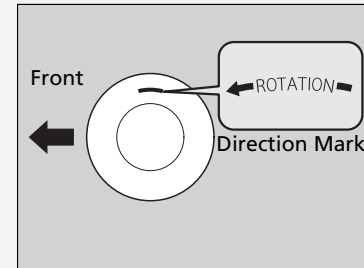

#### U.S. models

Whenever tires are rotated, you must calibrate the TPMS.

▶▶ **TPMS Calibration** P. 463

## Winter Tires

If driving on snowy or frozen roads, mount all season marked **M+S** tires, snow tires, or tire chains; reduce speed; and maintain sufficient distance between vehicles when driving.

Be particularly careful when operating the steering wheel or brakes to prevent skidding.

Use tire chains, snow tires, or all season tires when necessary or according to the law.

When mounting, refer to the following points.

For winter tires:

- Select the size and load ranges that are the same as the original tires.
- Mount the tires to all four wheels.

For tire chains:

- Install them on the front tires only.
- Because your vehicle has limited tire clearance, we strongly recommend using the chains listed below:

**Cable-type: SCC Radial Chain SC1026**

- Follow the chain manufacturer's instruction when installing. Mount them as tightly as you can.
- Check that the chains do not touch the brake lines or suspension.
- Drive slowly.

### ❗ Winter Tires

## ⚠ WARNING

Using the wrong chains, or not properly installing chains, can damage the brake lines and cause a crash in which you can be seriously injured or killed.

Follow all instructions in this owner's manual regarding the selection and use of tire chains.

### NOTICE

Traction devices that are the wrong size or improperly installed can damage your vehicle's brake lines, suspension, body, and wheels. Stop driving if they are hitting any part of the vehicle.

When tire chains are mounted, follow the chain manufacturer's instructions regarding vehicle operational limits.

If your vehicle is equipped with summer tires, be aware that these tires are not designed for winter driving conditions. For more information, contact a dealer.

## Checking the Battery

The battery condition is being monitored by the sensor on the negative terminal of the battery. If there is a problem with the sensor, the warning message on the information display\*/multi-information display\* will let you know. Have your vehicle checked by a dealer.

Check the battery terminals for corrosion monthly.

If your vehicle's battery is disconnected or goes dead:

- The audio system is disabled.
  - **Audio System Theft Protection** P. 208
- The clock resets.
  - **Clock** P. 122

### ⓘ Battery

#### **WARNING**

The battery gives off explosive hydrogen gas during normal operation.

A spark or flame can cause the battery to explode with enough force to kill or seriously hurt you.

When conducting any battery maintenance, wear protective clothing and a face shield, or have a skilled technician do it.

**WARNING:** Battery post, terminals, and related accessories contain lead and lead compounds.

**Wash your hands after handling.**

When replacing the battery, the replacement must be of the same specifications.  
Consult a dealer for more information.

## Charging the Battery

---

Disconnect both battery cables to prevent damaging your vehicle's electrical system. Always disconnect the negative (-) cable first, and reconnect it last.

### ⌘ Battery

When you find corrosion, clean the battery terminals by applying a baking powder and water solution. Clean terminals with a damp towel. Cloth/towel dry the battery. Coat the terminals with grease to help prevent future corrosion.

## Replacing the Button Battery

If the indicator does not come on when the button is pressed, replace the battery.

▣ Replacing the Button Battery

### **⚠ WARNING**

#### **CHEMICAL BURN HAZARD**

The battery that powers the remote transmitter can cause severe internal burns and can even lead to death if swallowed. Keep new and used batteries away from children.

If you suspect that a child has swallowed the battery, seek medical attention immediately.

#### **NOTICE**

An improperly disposed of battery can damage the environment. Always confirm local regulations for battery disposal.

Replacement batteries are commercially available or at a dealer.

### ■ Master Keys with Remote Transmitter\*

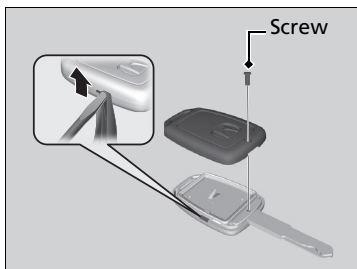

#### **Battery type: CR1620**

1. Unscrew the cover with a small Phillips-head screwdriver.
2. Open the remote transmitter.
  - ▶ Wrap the small flat-tip screwdriver with a cloth to prevent scratching the transmitter.
3. Remove the button battery with the small flat-tip screwdriver.
4. Make sure to replace the battery with the correct polarity.

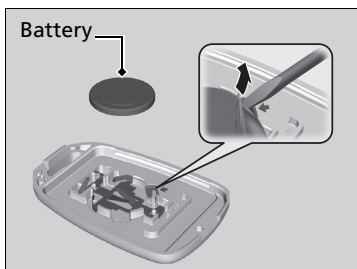

## Smart Entry Remote\*

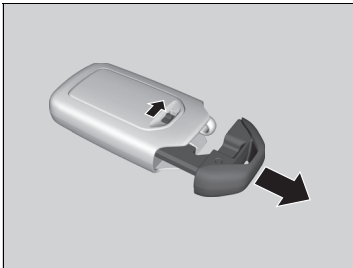

**Battery type: CR2032**

1. Remove the built-in key.
  
2. Remove the upper half of the cover by carefully prying on the edge with a coin.
  - ▶ Remove carefully to avoid losing the buttons.
  - ▶ Wrap a coin with a cloth to prevent scratching the smart entry remote.
  
3. Make sure to replace the battery with the correct polarity.

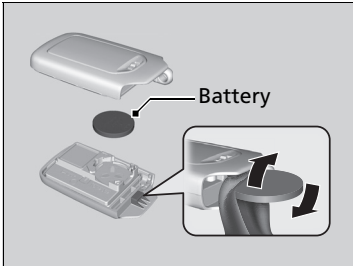

\* Not available on all models

## Air Conditioning\*

To ensure proper and safe operation, the Society of Automotive Engineers (SAE J2845) recommends that the refrigerant system only be serviced by trained and certified technicians.

Never repair or replace the air conditioning evaporator (cooling coil) with one removed from a used or salvaged vehicle.

New replacement mobile air conditioning evaporators must be certified (and labeled) as meeting SAE Standard J2842.

## Dust and Pollen Filter

The heating and cooling system\*/climate control system\* is equipped with a dust and pollen filter that collects pollen, dust, and other debris in the air. The Maintenance Minder™ messages will let you know when to replace the filter.

We recommend that you replace the dust and pollen filter sooner when using your vehicle in areas with high concentrations of dust.

### ➤ Heating and Cooling System\*/Climate Control System\* Maintenance

#### NOTICE

Vented refrigerant is harmful to the environment. To avoid refrigerant from venting, never replace the evaporator with one removed from a used or salvaged vehicle.

Refrigerant in your vehicle's air conditioning system is flammable and can be ignited during servicing if proper procedures are not followed.

The air conditioner label is found under the hood:

- **Safety Labels** P. 74
- **Specifications** P. 574

### ➤ Dust and Pollen Filter

If the airflow from the heating and cooling system\*/climate control system\* deteriorates noticeably, and the windows fog up easily, the filter may need to be replaced. Please contact a dealer for replacement.



## Interior Care

Use a damp cloth with a mixture of mild detergent and warm water to remove dirt.  
Use a clean cloth to remove detergent residue.

### Cleaning Seat Belts

Use a soft brush with a mixture of mild soap and warm water to clean the seat belts.  
Let the belts air dry. Wipe the loops of the seat belt anchors using a clean cloth.

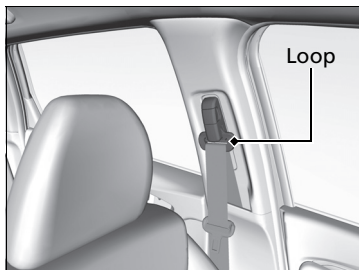

### Cleaning the Window

Wipe using a glass cleaner.

#### Interior Care

Do not spill liquids inside the vehicle.  
Electrical devices and systems may malfunction if liquids are splashed on them.

Do not use silicone based sprays on electrical devices such as audio devices and switches.  
Doing so may cause the items to malfunction or cause a fire inside the vehicle.  
If a silicone based spray is inadvertently used on electrical devices, consult a dealer.

Depending on their composition, chemicals and liquid aromatics may cause discoloration, wrinkles, and cracking to resin-based parts and textiles.  
Do not use alkali solvents or organic solvents such as benzene or gasoline.

After using chemicals, make sure to gently wipe them away using a dry cloth.  
Do not place used cloths on top of resin based parts or textiles for long periods of time without washing.

#### Models with front sensor camera

Be careful not to spill fluids, such as water or glass cleaner, on or around the cover of the front sensor camera.

#### Cleaning the Window

Wires are mounted to the inside of the rear window.  
Wipe along the same direction as the wires with a soft cloth so as not to damage them.

## ■ Floor Mats\*

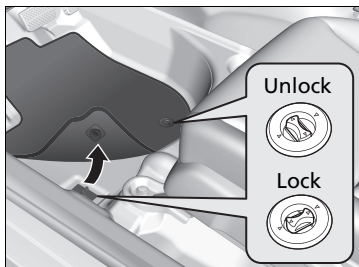

The driver's floor mat hooks over floor anchors, which keep the mat from sliding forward. To remove a mat for cleaning, turn the anchor knobs to the unlock position. When reinstalling the mat after cleaning, turn the knobs to the lock position.

**Do not put additional floor mats on top of the anchored mat.**

## ■ Maintaining Genuine Leather\*

To properly clean leather:

1. Use a vacuum or soft dry cloth first to remove any dirt or dust.
2. Clean the leather with a soft cloth dampened with a solution comprised of 90% water and 10% neutral soap.
3. Wipe away any soap residue with a clean damp cloth.
4. Wipe away residual water and allow leather to air dry in the shade.

## ▣ Floor Mats\*

If you use any floor mats that were not originally provided with your vehicle, make sure they are designed for your specific vehicle, fit correctly, and are securely anchored by the floor anchors. Position the rear seat floor mats properly. If they are not properly positioned, the floor mats can interfere with the front seat functions.

## ▣ Maintaining Genuine Leather\*

It is important to clean or wipe away dirt or dust as soon as possible. Spills can soak into leather resulting in stains. Dirt or dust can cause abrasions in the leather. In addition, please note that some dark colored clothing can rub onto the leather seats resulting in discoloration or stains.

## Exterior Care

Dust off the vehicle body after you drive.

Regularly inspect your vehicle for scratches on painted surfaces. A scratch on a painted surface can result in body rust. If you find a scratch, promptly repair it.

### ■ Washing the Vehicle

Wash the vehicle regularly. Wash more frequently when driving in the following conditions:

- If driving on roads with road salt.
- If driving in coastal areas.
- If tar, soot, bird droppings, insects, or tree sap are stuck to painted surfaces.

### ■ Using an Automated Car Wash

- Make sure to follow the instructions indicated on the automated car wash.
- Remove the audio antenna.
  - ▶ **Audio Antenna** P. 209
- Fold in the door mirrors.

### ■ Using High Pressure Cleaners

- Keep sufficient distance between the cleaning nozzle and the vehicle body.
- Take particular care around the windows. Standing too close may cause water to enter the vehicle interior.
- Do not spray high pressure water directly into the engine compartment. Instead, use low pressure water and a mild detergent.

### ▶▶ Washing the Vehicle

Do not spray water into the air intake vents. It can cause a malfunction.

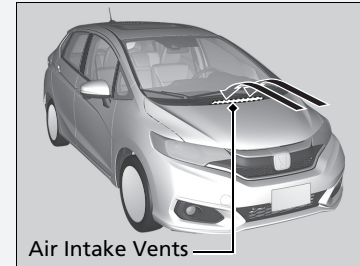

Continued

## ■ Applying Wax

A good coat of automotive body wax helps protect your vehicle's paint from the elements. Wax will wear off over time and expose your vehicle's paint to the elements, so reapply as necessary.

## ■ Maintaining the Bumpers and Other Resin Coated Parts

If you get gasoline, oil, engine coolant, or battery fluid on resin coated parts, they may be stained or the coating may peel. Promptly wipe it away using a soft cloth and clean water.

## ■ Cleaning the Window

Wipe using a glass cleaner.

## ■ Maintaining Aluminum Wheels\*

Aluminium is susceptible to deterioration caused by salt and other road contaminants. When necessary, as early as possible use a sponge and mild detergent to wipe away these contaminants. Do not use a stiff brush or harsh chemicals (including some commercial wheel cleaners). These can damage the protective finish on aluminium alloy wheels, resulting in corrosion. Depending on the type of finish, the wheels also may lose their luster or appear burnished. To avoid water stains, wipe the wheels dry with a cloth while they are still wet.

## ►► Applying Wax

### NOTICE

Chemical solvents and strong cleaners can damage the paint, metal, and plastic on your vehicle. Wipe away spills immediately.

## ►► Maintaining the Bumpers and Other Resin Coated Parts

Ask a dealer about the correct coating material when you want to repair the painted surface of the parts made of resin.

## ■ Fogged Exterior Light Lens

The inside lenses of exterior lights (headlights, brake lights, etc.) may fog temporarily if you have driven in the rain, or after the vehicle has been run through a car wash. Dew condensation also may build up inside the lenses when there is a significant enough difference between the ambient and inside lens temperatures (similar to vehicle windows fogging up in rainy conditions). These conditions are natural processes, not structural design problems in the exterior lights.

Lens design characteristics may result in moisture developing on the light lens frame surfaces. This also is not a malfunction.

However, if you see large amounts of water accumulation, or large water drops building up inside the lenses, have your vehicle inspected by a dealer.

## Accessories

When installing accessories, check the following:

- Do not install accessories on the windshield. They can obstruct your view and delay your reaction to driving conditions.
- Do not install accessories over areas marked **SRS AIRBAG**, on the sides or backs of the front seats, on front or side pillars, or near the side windows. Accessories installed in these areas may interfere with proper operation of the vehicle's airbags or may be propelled into you or another occupant if the airbags deploy.
- Be sure electronic accessories do not overload electrical circuits or interfere with proper operation of your vehicle.
  - ▣ **Fuses** P. 564
- Before installing any electronic accessory, have the installer contact a dealer for assistance. If possible, have a dealer inspect the final installation.

## Modifications

Do not modify your vehicle in a manner that may affect its handling, stability, or reliability, or install non-genuine Honda parts or accessories that may have a similar effect.

Even minor modifications to vehicle systems can affect overall vehicle performance. Always make sure all equipment is properly installed and maintained, and do not make any modification to your vehicle or its systems that might cause your vehicle to no longer meet federal, state, province, territory, and local regulations.

The on-board diagnostic port (OBD-II/SAE J1962 connector) installed on this vehicle is intended to be used with automobile system diagnostic devices or with other devices that Honda has approved. Use of any other type of device may adversely affect the vehicle's electronic systems or allow them to be compromised, possibly resulting in a system malfunction, drained battery, or other unexpected problems.

Do not modify or attempt to repair any of the electrical components.

### Accessories and Modifications

## **WARNING**

**Improper accessories or modifications can affect your vehicle's handling, stability, and performance, and cause a crash in which you can be seriously hurt or killed.**

**Follow all instructions in this owner's manual regarding accessories and modifications.**

Honda Genuine accessories are recommended to ensure proper operation on your vehicle.

# Handling the Unexpected

This chapter explains how to handle unexpected troubles.

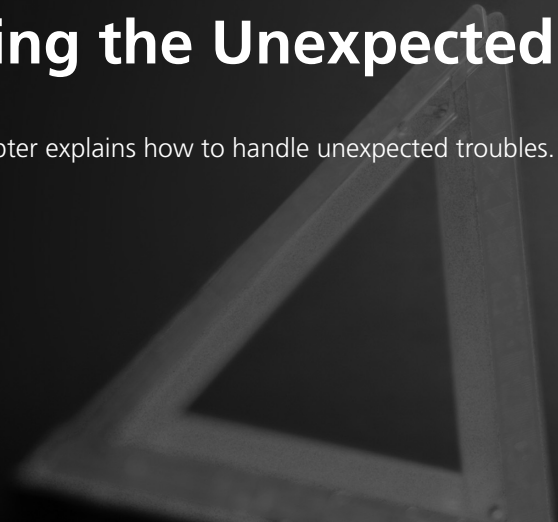

## **Tools**

Types of Tools..... 544

## **If a Tire Goes Flat**

Changing a Flat Tire..... 545

## **Engine Does Not Start**

Checking the Engine..... 552

If the Smart Entry Remote Battery is Weak  
..... 553

Emergency Engine Stop ..... 554

**Jump Starting**..... 555

**Shift Lever Does Not Move**..... 557

## **Overheating**

How to Handle Overheating..... 558

## **Indicator, Coming On/Blinking**

If the Low Oil Pressure Indicator Comes On  
..... 560

If the Charging System Indicator Comes  
On ..... 560

If the Malfunction Indicator Lamp Comes  
On or Blinks..... 561

If the Brake System Indicator (Red) Comes  
On..... 562

If the Electric Power Steering (EPS) System

Indicator Comes On..... 562

If the Low Tire Pressure/TPMS Indicator  
Comes On or Blinks ..... 563

## **Fuses**

Fuse Locations ..... 564

Inspecting and Changing Fuses..... 568

**Emergency Towing**..... 569

**When You Cannot Open the Tailgate**..... 570

## Types of Tools

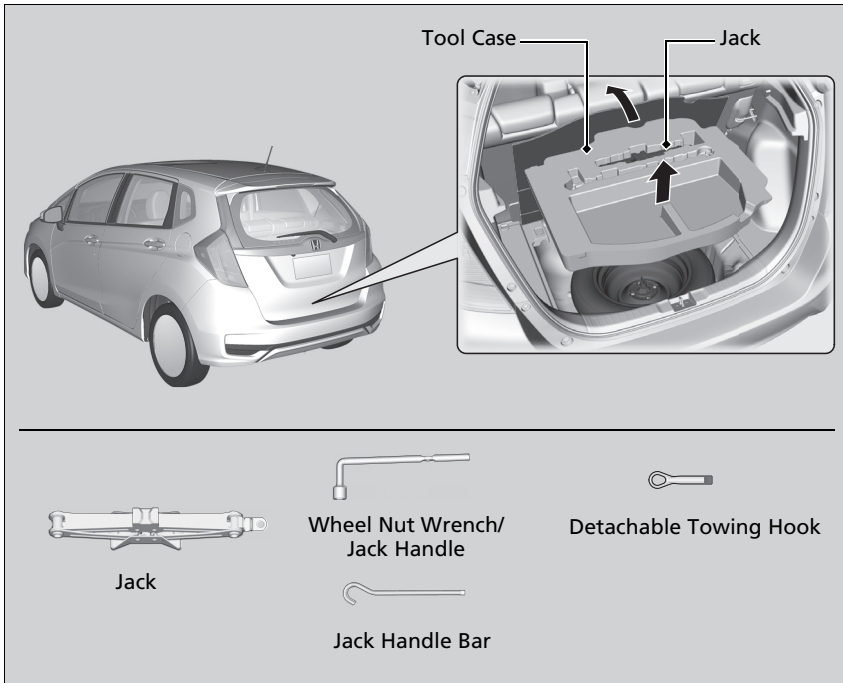

### Types of Tools

The tools are stored in the cargo area.



## Changing a Flat Tire

If a tire goes flat while driving, grasp the steering wheel firmly, and brake gradually to reduce speed. Then, stop in a safe place. Replace the flat tire with a compact spare tire. Go to a dealer as soon as possible to have the full-size tire repaired or replaced.

1. Park the vehicle on firm, level, non-slippery surface and apply the parking brake.

### Continuously variable transmission models

2. Move the shift lever to **P**.

### Manual transmission models

2. Move the shift lever to **R**.

### All models

3. Turn on the hazard warning lights and turn the ignition switch to LOCK **0**\*1.

\*1: Models with the smart entry system have an **ENGINE START/STOP** button instead of an ignition switch.

### Changing a Flat Tire

Follow compact spare precautions:  
Periodically check the tire pressure of the compact spare. It should be set to the specified pressure.  
Specified Pressure: 60 psi (420 kPa, 4.2 kgf/cm<sup>2</sup>)

When driving with the compact spare tire, keep the vehicle speed under 50 mph (80 km/h). Replace with a full-size tire as soon as possible.

The compact spare tire and wheel in your vehicle are specifically for this model.  
Do not use them with another vehicle.  
Do not use another type of compact spare tire or wheel with your vehicle.

Do not mount tire chains on a compact spare tire.  
If a chain-mounted front tire goes flat, remove one of the full-size rear tires and replace it with the compact spare tire. Remove the flat front tire and replace it with the full-size tire that was removed from the rear. Mount the tire chains on the front tire.

Do not use the jack if it doesn't work properly. Call your dealer or a professional towing service.

## ■ Getting Ready to Replace the Flat Tire

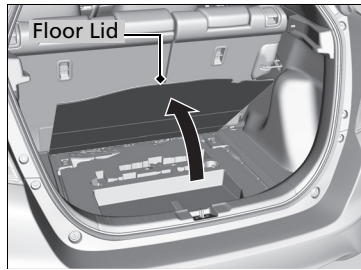

1. Open the cargo area floor lid.

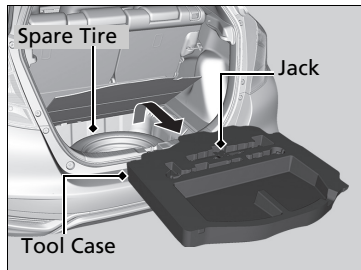

2. Take the tool case out of the cargo area.
3. Take the wheel nut wrench, jack handle bar and jack out of the tool case.
4. Unscrew the wing bolt, and remove the spacer cone. Then, remove the spare tire.

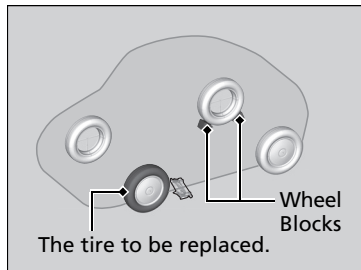

5. Place a wheel block or rock in front and rear of the wheel diagonal to the flat tire.

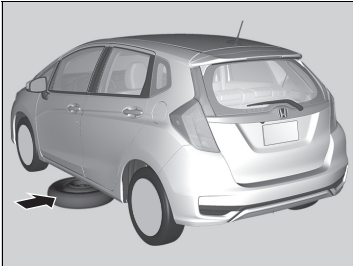

6. Place the compact spare tire (wheel side up) under the vehicle body, near the tire that needs to be replaced.

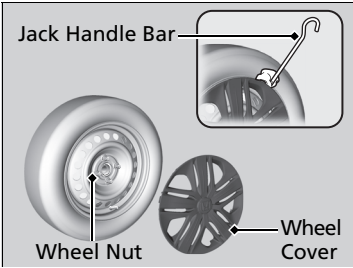

**Models with wheel cover**

7. Put the flat tip of the jack handle bar into the edge of the wheel cover. Carefully pry the edge and remove the cover.
  - ▶ Wrap a cloth around the flat tip of the jack handle bar to prevent scratches on the cover.

**All models**

8. Loosen each wheel nut about one turn using the wheel nut wrench.



## ■ How to Set Up the Jack

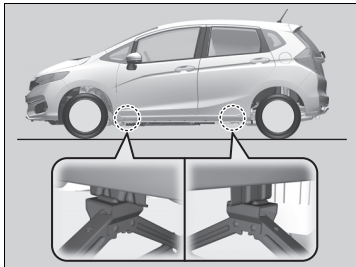

1. Place the jack under the jacking point closest to the tire to be changed.

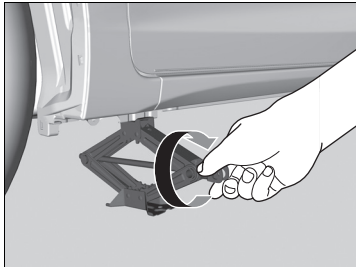

2. Turn the end bracket as shown in the image until the top of the jack contacts the jacking point.  
▶ Make sure that the jacking point tab is resting in the jack notch.

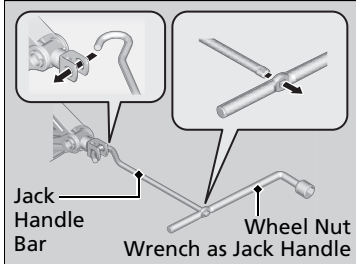

3. Raise the vehicle, using the jack handle bar and the jack handle, until the tire is off the ground.

## ▶▶ How to Set Up the Jack

### **⚠ WARNING**

The vehicle can easily roll off the jack, seriously injuring anyone underneath.

Follow the directions for changing a tire exactly, and no person should place any portion of their body under a vehicle that is supported by a jack.

Do not use the jack with people or luggage in the vehicle.

Use the jack provided in your vehicle. Other jacks may not support the weight ("load") or may not fit the jacking point.

The following instructions must be followed to use the jack safely:

- Do not use while the engine is running.
- Use only where the ground is firm and level.
- Use only at the jacking points.
- Do not get in the vehicle while using the jack.
- Do not put anything on top of or underneath the jack.

## Replacing the Flat Tire

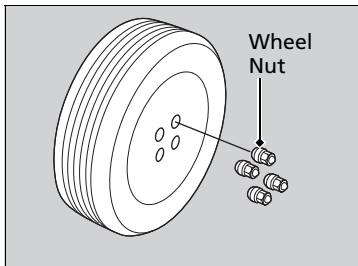

1. Remove the wheel nuts and flat tire.

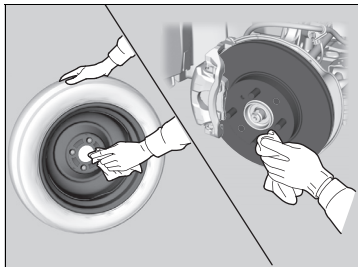

2. Wipe the mounting surfaces of the wheel with a clean cloth.

3. Mount the compact spare tire.

4. Screw the wheel nuts until they touch the lips around the mounting holes, and stop rotating.

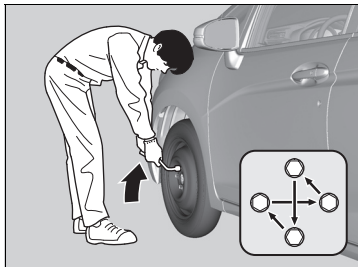

5. Lower the vehicle and remove the jack. Tighten the wheel nuts in the order indicated in the image. Go around, tightening the nuts, two to three times in this order.

**Wheel nut torque:**

80 lbf-ft (108 N·m, 11 kgf·m)

## Replacing the Flat Tire

Do not over tighten the wheel nuts by applying extra torque using your foot or a pipe.

### Models with wheel cover

Make sure the wire support ring is hooked into the clips around the edge of the wheel cover.

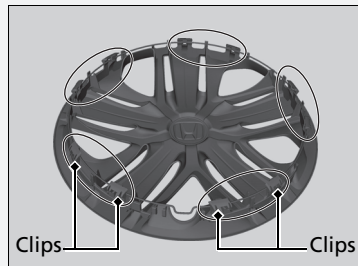

Align the valve mark on the wheel cover to the tire valve on the wheel, then install the wheel cover.

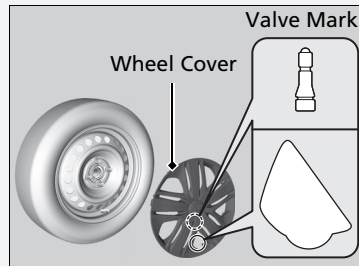

## ■ Storing the Flat Tire

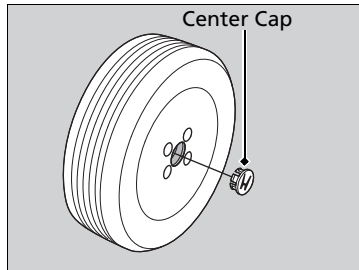

### Models with aluminum wheels

1. Remove the center cap.

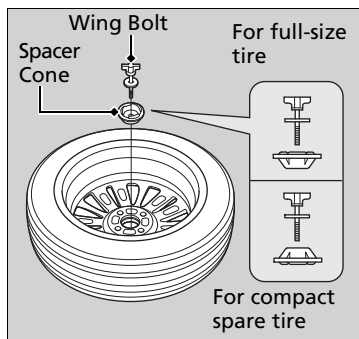

### All models

2. Place the flat tire face down in the spare tire well.
3. Remove the spacer cone from the wing bolt, flip it over, and insert it back on the bolt. Secure the flat tire with the wing bolt.
4. Securely store the wheel nut wrench, jack handle bar and jack back in the tool case. Store the case in the cargo area under the cargo floor lid.

## ▶▶ Storing the Flat Tire

### ⚠ WARNING

Loose items can fly around the interior in a crash and can seriously injure the occupants.

Store the wheel, jack, and tools securely before driving.

### Models with wheel cover

Make sure the wire support ring is on the outer side of the tire valve as shown.

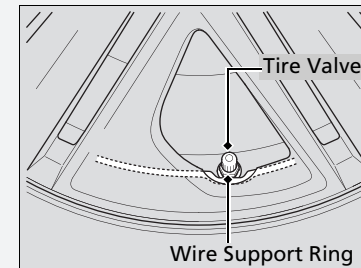

The system cannot monitor the pressure of the spare tire. Manually check the spare tire pressure to be sure that it is correct.

## TPMS and the Spare Tire

### U.S. models

If you replace a flat tire with the spare tire, the low tire pressure/TPMS indicator comes on while you are driving. After driving for a few miles (kilometers), the indicator will start blinking for a short time and then stay on, **Tire Pressure Monitor Problem** or **Tire Pressure Low** appears on the multi-information display\* but this is normal.

Calibrate the TPMS when you replace the tire with a specified regular tire.

📖 **TPMS Calibration** P. 463

\* Not available on all models

## Checking the Engine

If the engine does not start, check the starter.

☞ Checking the Engine

If you must start the vehicle immediately, use an assisting vehicle or booster battery to jump start it.

☞ **Jump Starting** P. 555

### Starter condition

### Checklist

#### Starter doesn't turn or turns over slowly.

The battery may be dead. Check each of the items on the right and respond accordingly.

#### Models with multi-information display

##### Check for a message on the multi-information display.

- If the **To Start, Hold Remote Near Start Button** message appears
  - ☞ **If the Smart Entry Remote Battery is Weak** P. 553
- ▶ Make sure the smart entry remote is in its operating range.
  - ☞ **ENGINE START/STOP Button Operating Range** P. 155

#### All models

##### Check the brightness of the interior lights.

Turn on the interior lights and check the brightness.

- If the interior lights are dim or do not come on at all ☞ **Battery** P. 532
- If the interior lights come on normally ☞ **Fuses** P. 564

#### Models with Smart Entry System

- Make sure the smart entry remote is in its operating range.
  - ☞ **ENGINE START/STOP Button Operating Range** P. 155

#### The starter turns over normally but the engine doesn't start.

There may be a problem with the fuse. Check each of the items on the right and respond accordingly.

##### Review the engine start procedure.

Follow its instructions, and try to start the engine again. ☞ **Starting the Engine** P. 409, 411

##### Check the immobilizer system indicator.

When the immobilizer system indicator is blinking, the engine cannot be started.

☞ **Immobilizer System** P. 148

##### Check the fuel level.

There should be enough fuel in the tank. ☞ **Fuel Gauge** P. 106, 110

##### Check the fuse.

Check all fuses, or have your vehicle checked by a dealer.

☞ **Inspecting and Changing Fuses** P. 568

##### If the problem continues:

☞ **Emergency Towing** P. 569



## Models with smart entry system

**If the Smart Entry Remote Battery is Weak**

If the beeper sounds, the **ENGINE START/STOP** button flashes, and the engine won't start.

## Models with multi-information display

The **To Start, Hold Remote Near Start Button** message appears on the multi-information display.

## All models

Start the engine as follows:

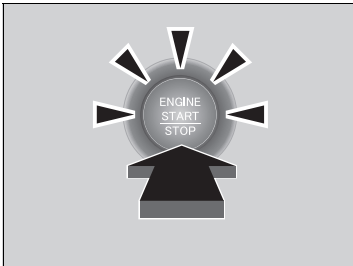
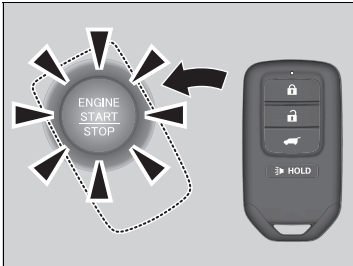

1. Touch the center of the **ENGINE START/STOP** button with the **H** logo on the smart entry remote while the **ENGINE START/STOP** button is flashing. The buttons on the smart entry remote should be facing you.
  - ▶ The **ENGINE START/STOP** button flashes for about 30 seconds.
2. Depress the brake pedal (continuously variable transmission) or clutch pedal (manual transmission) and press the **ENGINE START/STOP** button within 10 seconds after the beeper sounds and the **ENGINE START/STOP** button changes from flashing to on.
  - ▶ If you don't depress the pedal, the mode will change to ACCESSORY.

Models with smart entry system

## Emergency Engine Stop

The **ENGINE START/STOP** button may be used to stop the engine due to an emergency situation even while driving. If you must stop the engine, do either of the following operations:

- Press and hold the **ENGINE START/STOP** button for about two seconds.
- Firmly press the **ENGINE START/STOP** button three times.

The steering wheel will not lock. However, because turning off the engine disables the power assist the engine provides to the steering and braking systems, it will require significantly more physical effort and time to steer and slow the vehicle. Use both feet on the brake pedal to slow down the vehicle and stop immediately in a safe place. With manual transmission models you can also downshift the transmission to utilize engine braking.

Continuously variable transmission models

The power mode is in ACCESSORY when the engine is stopped.

To change the mode to VEHICLE OFF, move the shift lever to **P** after the vehicle comes to a complete stop.

Canadian continuously variable transmission models

Then press the **ENGINE START/STOP** button twice without depressing the brake pedal.

Manual transmission models

The power mode changes to VEHICLE OFF.

### Emergency Engine Stop

Do not press the button while driving unless it is absolutely necessary for the engine to be turned off.

## Jump Starting Procedure

Turn off the power to electric devices, such as audio and lights. Turn off the engine, then open the hood.

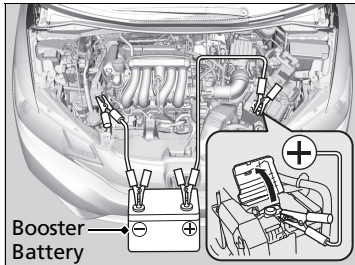

1. Connect the first jumper cable to your vehicle's battery ⊕ terminal.
  - ▶ Remove the cover from the under-hood fuse box.
  - ▶ **Engine Compartment Fuse Box** P. 564
2. Connect the other end of the first jumper cable to the booster battery ⊕ terminal.
  - ▶ Use a 12-volt booster battery only.
  - ▶ Connect when using the automotive battery charger to boost your 12-volt battery, select a lower charging voltage than 15-volt. Check the charger manual for the proper setting.
3. Connect the second jumper cable to the booster battery ⊖ terminal.
4. Connect the other end of the second jumper cable to the stud bolt as shown. Do not connect this jumper cable to any other part.
5. If your vehicle is connected to another vehicle, start the assisting vehicle's engine and increase its rpm slightly.
6. Attempt to start your vehicle's engine. If it turns over slowly, check that the jumper cables have good metal-to-metal contact.

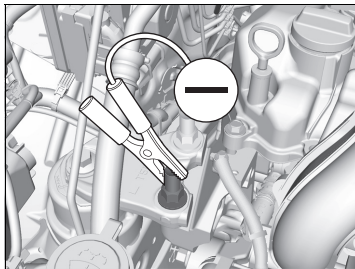

## Jump Starting

### ⚠ WARNING

A battery can explode if you do not follow the correct procedure, seriously injuring anyone nearby.

Keep all sparks, open flames, and smoking materials away from the battery.

Securely attach the jumper cables clips so that they do not come off when the engine vibrates. Also be careful not to tangle the jumper cables or allow the cable ends to touch each other while attaching or detaching the jumper cables.

Battery performance degrades in cold conditions and may prevent the engine from starting.

## ■ What to Do After the Engine Starts

Once your vehicle's engine has started, remove the jumper cables in the following order.

1. Disconnect the jumper cable from your vehicle's stud bolt.
2. Disconnect the other end of the jumper cable from the booster battery ⊖ terminal.
3. Disconnect the jumper cable from your vehicle's battery ⊕ terminal.
4. Disconnect the other end of the jumper cable from the booster battery ⊕ terminal.

Have your vehicle inspected by a nearby service station or a dealer.

# Shift Lever Does Not Move

## Continuously variable transmission models

Follow the procedure below if you cannot move the shift lever out of the **P** position.

## Releasing the Lock

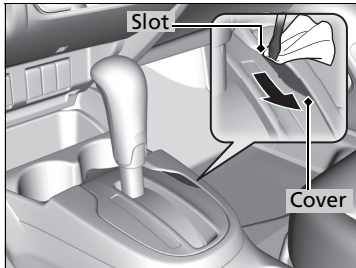

1. Set the parking brake.

### Models without smart entry system

2. Remove the key from the ignition switch.

### Models with smart entry system

2. Remove the built-in key from the smart entry remote.

### All models

3. Wrap a cloth around the tip of a small flat-tip screwdriver. Put it into the shift lock release slot as shown in the image, and remove the cover.
4. Insert the key into the shift lock release slot.
5. While pushing the key down, press the shift lever release button, and place the shift lever into **N**.
  - ▶ The lock is now released. Have the shift lever checked by a dealer as soon as possible.

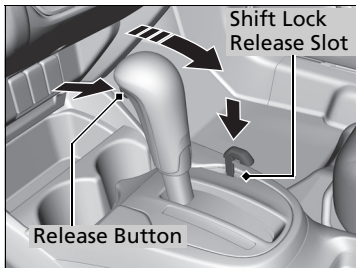

## How to Handle Overheating

Overheating symptoms are as follows:

- The high temperature indicator comes on or the engine suddenly loses power.
- The **Stop Driving When Safe. Engine Temperature Too Hot** message appears on the multi-information display\*.
- Steam or spray comes out of the engine compartment.

### ■ First thing to do

1. Immediately park the vehicle in a safe place.
2. Turn off all accessories and turn on the hazard warning lights.
  - ▶ **No steam or spray present:** Keep the engine running and open the hood.
  - ▶ **Steam or spray is present:** Turn off the engine and wait until it subsides. Then open the hood.

### ☞ How to Handle Overheating

## **WARNING**

Steam and spray from an overheated engine can seriously scald you.

Do not open the hood if steam is coming out.

### **NOTICE**

Continuing to drive with the high temperature indicator on may damage the engine.

If the coolant is leaking, contact a dealer for repairs.

### ■ Next thing to do

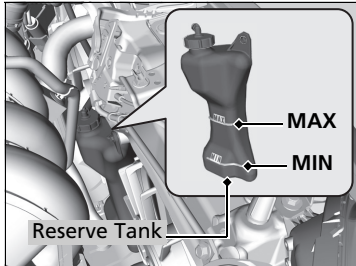

1. Check that the cooling fan is operating and stop the engine once the high temperature indicator goes off.
  - ▶ If the cooling fan is not operating, immediately stop the engine.
2. Once the engine has cooled down, inspect the coolant level and check the cooling system components for leaks.
  - ▶ If the coolant level in the reserve tank is low, add coolant until it reaches the **MAX** mark.
  - ▶ If there is no coolant in the reserve tank, check that the radiator is cool. Cover the radiator cap with a heavy cloth and open the cap. If necessary, add coolant up to the base of the filler neck, and put the cap back on.

### ■ Last thing to do

Once the engine has cooled sufficiently, restart it and check the high temperature indicator.

If the high temperature indicator is off, resume driving. If it stays on, contact a dealer for repairs.

#### How to Handle Overheating

### ⚠ WARNING

Removing the radiator cap while the engine is hot can cause the coolant to spray out, seriously scalding you.

Always let the engine and radiator cool down before removing the radiator cap.

Use water as an emergency/temporary measure only. Have a dealer flush the system with proper antifreeze as soon as possible.

## If the Low Oil Pressure Indicator Comes On



### ■ Reasons for the indicator to come on

Comes on when the engine oil pressure is low.

### ■ What to do as soon as the indicator comes on

1. Immediately park the vehicle on level ground in a safe place.
2. If necessary, turn the hazard warning lights on.

### ■ What to do after parking the vehicle

1. Stop the engine and let it sit for about three minutes.
2. Open the hood and check the oil level.
  - ▶ Add oil as necessary.
    - 📖 **Oil Check** P. 502
3. Start the engine and check the low oil pressure indicator.
  - ▶ The indicator goes off: Start driving again.
  - ▶ The indicator does not go off within 10 seconds: Stop the engine and contact a dealer for repairs immediately.

## If the Charging System Indicator Comes On



### ■ Reasons for the indicator to come on

Comes on when the battery is not being charged.

### ■ What to do when the indicator comes on

Turn off the heating and cooling system\*/climate control system\*, rear defogger, and other electrical systems, and immediately contact a dealer for repairs.

### 📖 If the Low Oil Pressure Indicator Comes On

#### NOTICE

Running the engine with low oil pressure can cause serious mechanical damage almost immediately.

### 📖 If the Charging System Indicator Comes On

If you need to stop temporarily, do not turn off the engine. Restarting the engine may rapidly discharge the battery.



## If the Malfunction Indicator Lamp Comes On or Blinks



### ■ Reasons for the indicator lamp to come on or blink

- Comes on when there is a problem with the engine emissions control system, or the fuel fill cap is missing, or loose.
- Blinks when engine misfiring is detected.

### ■ What to do when the indicator lamp comes on

Avoid high speeds and immediately get your vehicle inspected at a dealer.

### ■ What to do when the indicator lamp blinks

Park the vehicle in a safe place with no flammable items and wait at least 10 minutes or more with the engine stopped until it cools.

## ■ Check/Tighten Fuel Cap Message

### ■ The message appears on when:

An evaporative system leak is detected. This may be caused by the fuel fill cap being loose or not being installed.

### ■ What to do when the message appears:

1. Stop the engine.
2. Check that the fuel fill cap is fully installed.
  - ▶ If not, loosen the cap, and then retighten it until it clicks at least once.
3. Drive for several days of normal driving.
  - ▶ The message should go off.

### ■ When the malfunction indicator lamp comes on

Malfunction indicator lamp comes on if the system continues to detect a leak of gasoline vapor. If this happens, check the fuel fill cap using the procedures described above.

## ▶▶ If the Malfunction Indicator Lamp Comes On or Blinks

### NOTICE

If you drive with the malfunction indicator lamp on, the emissions control system and the engine could be damaged.

If the malfunction indicator lamp blinks again when restarting the engine, drive to the nearest dealer at 31 mph (50 km/h) or less. Have your vehicle inspected.

## If the Brake System Indicator (Red) Comes On

U.S.



Canada



### ■ Reasons for the indicator to come on

- The brake fluid is low.
- There is a malfunction in the brake system.

### ■ What to do when the indicator comes on while driving

Depress the brake pedal lightly to check pedal pressure.

- If normal, check the brake fluid level the next time you stop.
- If abnormal, take immediate action. If necessary, downshift the transmission to slow the vehicle using engine braking.

### ⚠ If the Brake System Indicator (Red) Comes On

Have your vehicle repaired immediately.

It is dangerous to drive with low brake fluid. If there is no resistance from the brake pedal, stop immediately in a safe place. If necessary downshift the gears.

If the brake system indicator and **ABS** indicator come on simultaneously, the electronic brake distribution system is not working. This can result in vehicle instability under sudden braking.

Have your vehicle inspected by a dealer immediately.

## If the Electric Power Steering (EPS) System Indicator Comes On



### ■ Reasons for the indicator to come on

- Comes on when there is a problem with the EPS system.
- If you depress the accelerator pedal repeatedly to increase the engine speed while the engine is idling, the indicator comes on, and sometimes the steering wheel becomes harder to operate.

### ■ What to do when the indicator comes on

Stop the vehicle in a safe place and restart the engine.

If the indicator comes on and stays on, immediately have your vehicle inspected by a dealer.

U.S. models

## If the Low Tire Pressure/TPMS Indicator Comes On or Blinks



### ■ Reasons for the indicator to come on or blink

A tire pressure is significantly low, or the TPMS has not been calibrated. If there is a problem with the TPMS or the compact spare tire is installed, the indicator blinks for about one minute, and then stays on

### ■ What to do when the indicator comes on

Drive carefully and avoid abrupt cornering and hard braking. Stop your vehicle in a safe place. Check the tire pressure and adjust the pressure to the specified level. The specified tire pressure is on a label on the driver side doorjamb.

▶ Calibrate the TPMS after the tire pressure is adjusted.

### ■ What to do when the indicator blinks, then remains on

Have the tire inspected by a dealer as soon as possible. If the compact spare tire causes the indicator to blink, change the tire to a full-size tire. The indicator goes off after driving for a few miles (kilometers).

▶ Calibrate the TPMS after a full-size tire is reinstalled.

### ▶▶ If the Low Tire Pressure/TPMS Indicator Comes On or Blinks

#### NOTICE

Driving on an extremely underinflated tire can cause it to overheat. An overheated tire can fail. Always inflate your tires to the prescribed level.

## Fuse Locations

If any electrical devices are not working, turn the ignition switch to LOCK [0]<sup>\*1</sup> and check to see if any applicable fuse is blown.

### ■ Engine Compartment Fuse Box

#### ■ Fuse box A

Located near the brake fluid reservoir. Push the tabs to open the box.

Fuse locations are shown on the fuse box cover. Locate the fuse in question by the fuse number and box cover number.

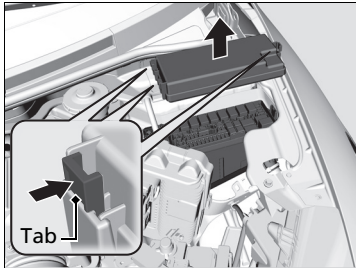

### ■ Circuit protected and fuse rating

	Circuit Protected	Amps
1	Headlight Low Beam Main	20 A
2	CDC *	(30 A)
3	Hazard	10 A
4	DBW	15 A
5	Wiper	(30 A)
6	Stop	10 A
7	IGP	15 A
8	IG Coil	15 A
9	EOP*	(10 A)
10	INJ	(20 A)
11	–	–
12	Main Fan	30 A
13	Starter SW	(30 A)
14	MG Clutch	(7.5 A)
15	Battery Sensor	(7.5 A)
16	–	–
17	Daytime Running Lights	(7.5 A)
18	Horn	10 A
19	Fog Light*	(15 A)
20	UB ECU*	(7.5 A)

	Circuit Protected	Amps
21	Back Up Main	15 A
22	Interior Lights	7.5 A
23	Sub Fan	(30 A)
24	–	–
25	Smart Entry Auto Start <sup>*2</sup>	(7.5 A)
26	ST MG <sup>*3</sup>	(7.5 A)
27	–	–
28	–	–
29	Back Up	(10 A)
30	IGP LAF	(10 A)
31	IGPS	(7.5 A)
32	Right Headlight Low Beam	10 A
33	Left Headlight Low Beam	10 A

\*1: Models with the smart entry system have an **ENGINE START/STOP** button instead of an ignition switch.

\*2: Models with smart entry system

\*3: Models without smart entry system

■ Fuse box B

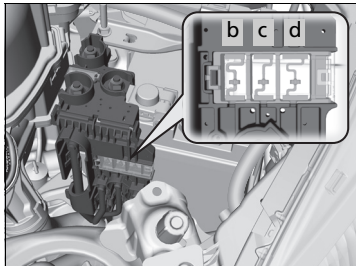
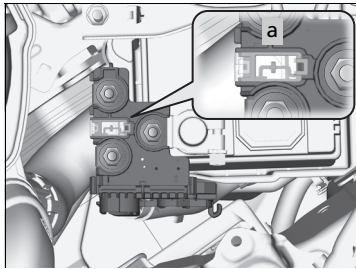
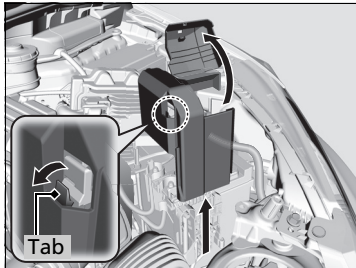

Pull up the cover on the ⊕ terminal, then remove it while pulling out the tab as shown.  
 Replacement of engine compartment fuses should be done by a dealer.

■ Circuit protected and fuse rating

	Circuit Protected	Amps
a	Battery Main	100 A
b	RB Main 1	70 A
c	RB Main 2	80 A
d	CAP Main	70 A

## Interior Fuse Boxes

### Fuse box A

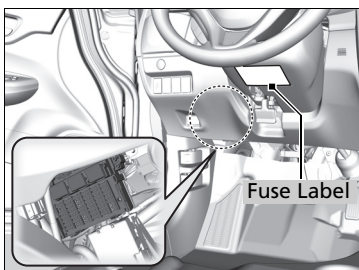

Located behind the instrument panel. Fuse locations are shown on the label under the steering column. Locate the fuse in question by the fuse number and label number.

### Circuit protected and fuse rating

	Circuit Protected	Amps
1	Door Lock	(20 A)
2	–	–
3	Smart*	(10 A)
4	Driver Side Door Unlock	15 A
5	Passenger Side Door Unlock	15 A
6	Driver Door Unlock	(10 A)
7	Driver Door Lock	(10 A)
8	Driver's Power Window	20 A
9	Passenger's Power Window	20 A
10	Rear Left Power Window	20 A
11	Rear Right Power Window	20 A
12	Driver Side Door Lock	15 A
13	Passenger Side Door Lock	15 A
14	–	–
15	Right Headlight High Beam	10 A
16	STS*	(7.5 A)
17	ACC Socket Console*	(20 A)
18	Moonroof*	(20 A)
19	Front Seat Heater*	(20 A)
20	–	–

	Circuit Protected	Amps
21	–	–
22	Washer	15 A
23	Rear Wiper*	(10 A)
24	A/C	7.5 A
25	Daytime Running Lights	7.5 A
26	Starter Cut	7.5 A
27	ABS/VSA	7.5 A
28	SRS	10 A
29	Left Headlight High Beam	10 A
30	ACG	10 A
31	Power Window	10 A
32	Fuel Pump	15 A
33	SRS	7.5 A
34	Meter	7.5 A
35	Mission SOL	7.5 A
36	Front ACC Socket	20 A
37	ACC	7.5 A
38	ACC Key Lock	7.5 A
39	Option	(10 A)
40	Rear Wiper	10 A
41	–	–
42	–	–

■ Fuse box B

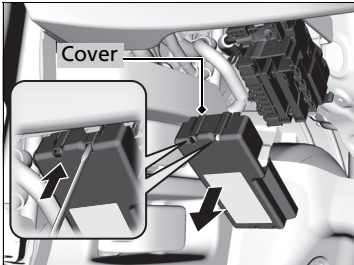
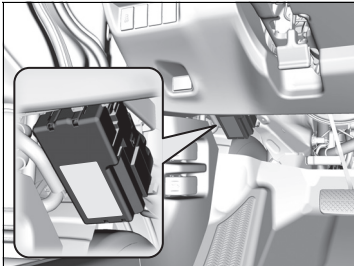

Remove the cover by putting the flat-tip screwdriver into the side slot as shown.

■ Circuit protected and fuse rating

	Circuit Protected	Amps
1	EPS	70 A
	IG Main	30 A <sup>*1</sup>
		50 A <sup>*2</sup>
	Fuse Box Main 2	50 A
	ABS/VSA Motor	40 A
	Fuse Box Main 1	30 A
	Fuse Box Main 3	40 A
	–	–
	–	–
2	–	–
	–	–
	–	–
	–	–
	–	–
	–	–

	Circuit Protected	Amps
3	Heater	30 A
4 <sup>*1</sup>	IG Main 2	30 A
4 <sup>*2</sup>	–	–
5	ABS/VSA FSR	30 A
6	–	–
7	–	–
8	Front Sensor Camera	(7.5 A) <sup>*</sup>
9	Small Light	10 A
10	ACC Socket (Console) <sup>*</sup>	(20 A)
11	Rear Defogger	30 A
12 <sup>*1</sup>	–	–
12 <sup>*2</sup>	ACC Key Lock	(7.5 A)
13	Heated Door Mirror <sup>*</sup>	(10 A)
14	A/C Blower SW	(7.5 A)
15 <sup>*1</sup>	–	–
15 <sup>*2</sup>	Wiper	30 A

\*1: Models with smart entry system

\*2: Models without smart entry system

\* Not available on all models

## Inspecting and Changing Fuses

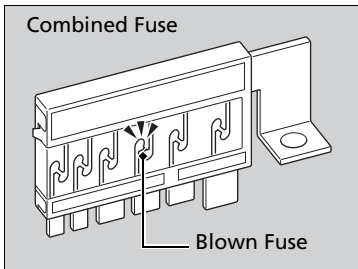
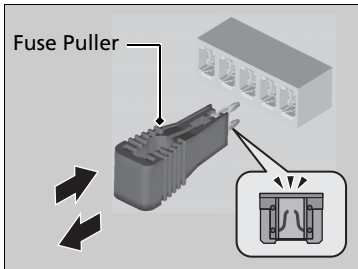
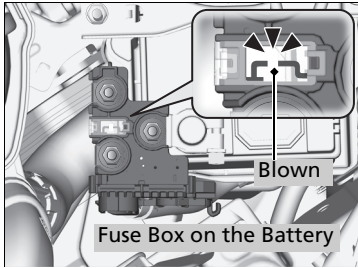

1. Turn the ignition switch to LOCK **0**\*1. Turn headlights and all accessories off.
2. Remove the fuse box cover.
3. Check the large fuses on the battery in the engine compartment.
  - If the fuse is blown, have it replaced by a dealer.
4. Inspect the small fuses in the engine compartment and the vehicle interior.
  - If there is a blown fuse, remove it with the fuse puller and replace it with a new one.
5. Check the large fuse in the vehicle interior.
  - If the fuse is blown, use a phillips-head screwdriver to remove the screw and replace it with a new one.

### Inspecting and Changing Fuses

#### NOTICE

Replacing a fuse with one that has a higher rating greatly increases the chances of damaging the electrical system.

Replace fuse with a spare fuse of the same specified amperage.

Confirm the specified amperage using the charts on P. 564 to P. 567.

There is a fuse puller on the back of the engine compartment fuse box cover.

\*1: Models with the smart entry system have an **ENGINE START/STOP** button instead of an ignition switch.



Call a professional towing service if you need to tow your vehicle.

## ■ Flat bed equipment

The operator loads your vehicle on the back of a truck.

**This is the best way to transport your vehicle.**

## ■ Wheel lift equipment

The tow truck uses two pivoting arms that go under the front tires and lift them off the ground. The rear tires remain on the ground. **This is an acceptable way to tow your vehicle.**

### »Emergency Towing

#### NOTICE

Trying to lift or tow your vehicle by the bumpers will cause serious damage. The bumpers are not designed to support the vehicle's weight.

#### NOTICE

Improper towing such as towing behind a motorhome or other motor vehicle can damage the transmission.

Never tow your vehicle with just a rope or chain. It is very dangerous, since ropes or chains may shift from side to side or break.

## What to Do When Unable to Open the Tailgate

If you cannot open the tailgate, use the following procedure.

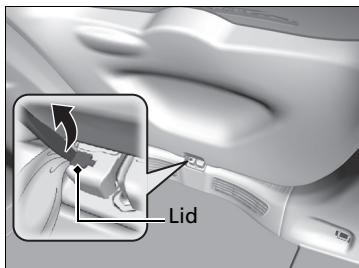

1. Wrap a cloth around the flat-tip screwdriver. Put it into the lid as shown in the image, and open the lid.

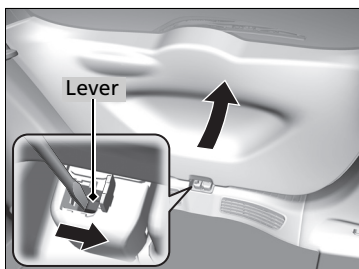

### Models with smart entry system

2. To open the tailgate, push the tailgate while sliding the lever to the right.

## When You Cannot Open the Tailgate

Following up:

After taking these steps, contact a dealer to have your vehicle checked.

When you open the tailgate from inside, make sure there is enough space around the tailgate, and it does not hit anyone or any object.

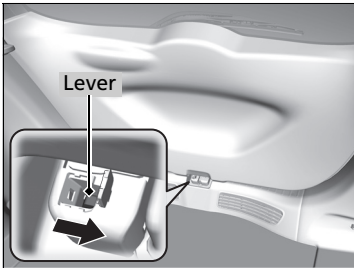

**Models without smart entry system**

- 2.** Slide the lever to unlock the tailgate.
- 3.** Open the tailgate.



# Information

This chapter includes your vehicle's specifications, locations of identification numbers, and other information required by regulation.

<b>Specifications</b> .....	574
<b>Identification Numbers</b>	
Vehicle Identification Number (VIN), Engine Number, and Transmission Number .....	576
<b>Devices that Emit Radio Waves</b> .....	577
<b>Reporting Safety Defects</b> .....	579
<b>Emissions Testing</b>	
Testing of Readiness Codes .....	580
<b>Warranty Coverages</b> .....	582
<b>Authorized Manuals</b> .....	584
<b>Customer Service Information</b> .....	585

## ■ Vehicle Specifications

Model	Fit
No. of Passengers:	
Front	2
Rear	3
Total	5
<b>Weights:</b>	
Gross Vehicle Weight Rating <sup>*1</sup>	U.S.: 3,461 lbs (1,570 kg) <sup>*4,*5,*8</sup> Canada: 1,570 kg <sup>*3,*4</sup> 1,590 kg <sup>*5,*8</sup>
Gross Vehicle Weight Rating <sup>*2</sup>	U.S.: 3,483 lbs (1,580 kg) <sup>*4,*9</sup> 3,505 lbs (1,590 kg) <sup>*5,*6,*7,*8</sup> Canada: 1,580 kg <sup>*4</sup> 1,590 kg <sup>*5,*6,*8</sup>
Gross Axle Weight Rating (Front) <sup>*1</sup>	U.S.: 1,829 lbs (830 kg) <sup>*4</sup> 1,873 lbs (850 kg) <sup>*5,*8</sup> Canada: 830 kg <sup>*3,*4</sup> 850 kg <sup>*5,*8</sup>
Gross Axle Weight Rating (Front) <sup>*2</sup>	U.S.: 1,829 lbs (830 kg) <sup>*4,*9</sup> 1,873 lbs (850 kg) <sup>*5,*6,*7,*8</sup> Canada: 830 kg <sup>*4</sup> 850 kg <sup>*5,*6,*8</sup>
Gross Axle Weight Rating (Rear)	U.S.: 1,664 lbs (755 kg) <sup>*4,*5,*6,*7,*8,*9</sup> Canada: 755 kg <sup>*3,*4,*5,*6,*8</sup>

- \*1: Manual transmission models
- \*2: Continuously variable transmission models
- \*3: DX
- \*4: LX
- \*5: EX
- \*6: EX-L
- \*7: EX-LNA
- \*8: SPORT
- \*9: LX SE

## ■ Air Conditioning\*

Refrigerant Type	R-1234yf <sup>*1</sup> HFC-134a (R-134a) <sup>*2</sup>
Charge Quantity	13.2 – 15.0 oz (375 – 425 g)
Lubricant Type	ND-OIL14 <sup>*1</sup> ND-OIL8 <sup>*2</sup>
Quantity	4.2 – 5.0 cu-in (70 – 82 cm <sup>3</sup> ) <sup>*1</sup> 3.3 – 4.0 cu-in (55 – 67 cm <sup>3</sup> ) <sup>*2</sup>

- \*1: U.S. models
- \*2: Canadian models

## ■ Engine Specifications

Displacement	91.4 cu-in (1,498 cm <sup>3</sup> )
Spark Plugs	NGK DILZKAR7C11S DENSO DXE22HCR11S

## ■ Fuel

Fuel Type	Unleaded gasoline, Pump octane number of 87 or higher
Fuel Tank Capacity	10.6 US gal (40 L)

## ■ Washer Fluid

Tank Capacity	U.S.: 2.6 US qt (2.5 L) Canada: 4.2 US qt (4.0 L)
---------------	--

## ■ Light Bulbs

Headlights/Daytime Running Lights (High/Low Beam)	60/55W (H4LL/HB2LL <sup>*</sup> , H4/HB2 <sup>*</sup> )
Fog Lights <sup>*</sup>	35W (H8)
Side Marker Lights	3CP
Front Turn Signal/Parking Lights	28/8W (Amber)
Brake/Tail/Side Marker Lights	LED
Back-Up Lights	21W
Rear Turn Signal Lights	21W
High-Mount Brake Light	LED
Side Turn Signal Lights	LED
Rear License Plate Lights	5W
<b>Interior Lights</b>	
Map Lights	8W
Ceiling Light	8W
Cargo Area Light	5W

■ Brake Fluid

Specified	Honda Heavy Duty Brake Fluid DOT 3
-----------	------------------------------------

■ Continuously Variable Transmission Fluid\*

Specified	Honda HCF-2 Transmission Fluid
Capacity	Change 3.6 US qt (3.4 L)

■ Manual Transmission Fluid\*

Specified	Honda Manual Transmission Fluid
Capacity	Change 1.5 US qt (1.4 L)

■ Engine Oil

Recommended	-Genuine Honda Motor Oil 0W-16, 0W-20	
	-API Premium-grade 0W-16, 0W-20 detergent oil	
Capacity	Change	3.3 US qt (3.1 L)
	Change including filter	3.5 US qt (3.3 L)

■ Engine Coolant

Specified	Honda Long-Life Antifreeze/Coolant Type2
Ratio	50/50 with distilled water
Capacity	0.999 US gal (3.78 L)
	(change including the remaining 0.111 US gal (0.42 L) in the reserve tank)

■ Tire

Regular	Size	185/60R15 84T <sup>*1</sup>	
	Pressure psi (kPa[kgf/cm <sup>2</sup> ])	Front	33 (230 [2.3])
		Rear	33 (230 [2.3]) <sup>*1</sup> 32 (220 [2.2]) <sup>*2</sup>
Compact Spare	Size	T135/80D15 99M T135/80D15 100M <sup>*3</sup>	
Wheel Size	Regular	15 x 6J <sup>*1</sup>	
	Compact Spare	16 x 6J <sup>*2</sup>	
		15 x 4T	

\*1: LX, LX SE, Canadian DX, LX

\*2: EX, SPORT, EX-L, EX-LNA, Canadian EX, EX-L, SPORT

\*3: U.S. models

\* Not available on all models

## Vehicle Identification Number (VIN), Engine Number, and Transmission Number

Your vehicle has a 17-digit vehicle identification number (VIN) used to register your vehicle for warranty purposes, and for licensing and insuring your vehicle.

The locations of your vehicle's VIN, engine number, and transmission number are shown as follows.

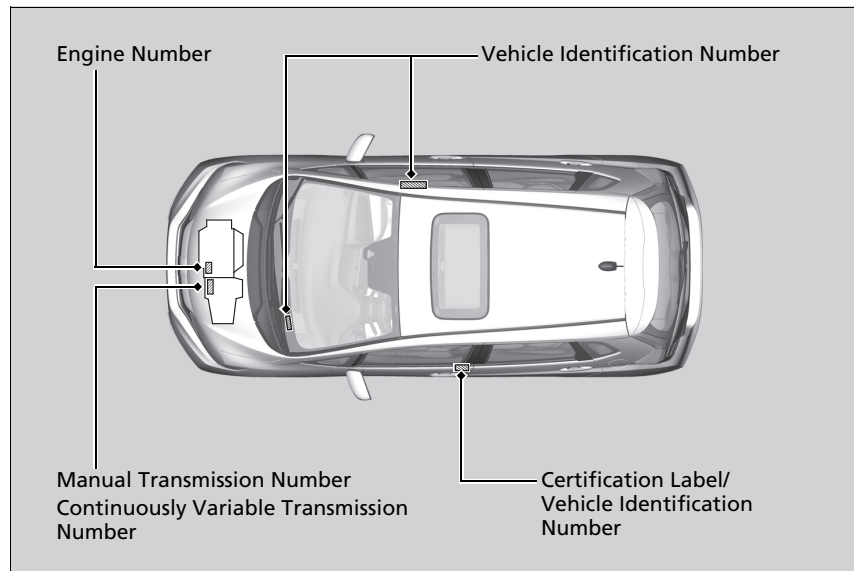

### Vehicle Identification Number (VIN), Engine Number, and Transmission Number

The interior vehicle identification number (VIN) is located under the cover.

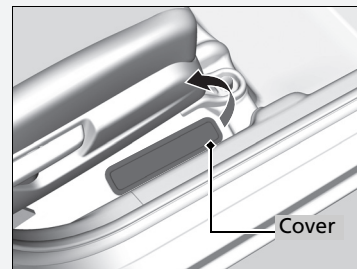



## Devices that Emit Radio Waves

The following products and systems on your vehicle emit radio waves when in operation.

### Audio System

*Bluetooth*® Audio

*Bluetooth*® HandsFreeLink®

Immobilizer System

Smart Entry System\*

Remote Transmitter

Collision Mitigation Braking System™ (CMBS™)\*

Each of the above complies with the appropriate requirements or the required standards of FCC (Federal Communications Commission) and Industry Canada Standard, described below:

As required by the FCC:

This device complies with Part 15 of the FCC rules. Operation is subject to the following two conditions: (1) This device may not cause harmful interference, and (2) this device must accept any interference received, including interference that may cause undesired operation.

Changes or modifications not expressly approved by the party responsible for compliance could void the user's authority to operate the equipment.

\* Not available on all models

This device complies with Industry Canada licence-exempt RSS standard(s).

Operation is subject to the following two conditions: (1) this device may not cause interference, and (2) this device must accept any interference, including interference that may cause undesired operation of the device.

In the U.S.

If you believe that your vehicle has a defect which could cause a crash or could cause injury or death, you should immediately inform the National Highway Traffic Safety Administration (NHTSA) in addition to notifying American Honda Motor Co., Inc.

If NHTSA receives similar complaints, it may open an investigation, and if it finds that a safety defect exists in a group of vehicles, it may order a recall and remedy campaign. However, NHTSA cannot become involved in individual problems between you, your dealer, or American Honda Motor Co., Inc.

To contact NHTSA, you may call the Vehicle Safety Hotline toll-free at 1-888-327-4236 (TTY: 1-800-424-9153); go to <http://www.safercar.gov>; or write to: Administrator, NHTSA, 1200 New Jersey Avenue, SE., Washington, DC 20590. You can also obtain other information about motor vehicle safety from <http://www.safercar.gov>.

In Canada

If you believe that your vehicle has a defect which could cause a crash or could cause injury or death, you should immediately inform Honda Canada Inc. and you may also inform Transport Canada.

If Transport Canada receives similar complaints, it may open an investigation, and if it finds that a safety defect exists in a group of vehicles, it may lead to a recall and remedy campaign. However, Transport Canada cannot become involved in individual problems between you, your dealer, or Honda Canada Inc.

To contact Transport Canada's Defect Investigations and Recalls Division, you may call 1-800-333-0510. For more information on reporting safety defects or about motor vehicle safety, go to <http://www.tc.gc.ca/roadsafety>.

## Testing of Readiness Codes

Your vehicle has readiness code as part of the onboard self diagnostic system. Some states use these codes for testing to verify whether your vehicle's emissions components are working properly. The codes may not be read properly if testing is performed just after the battery has gone dead or been disconnected.

To check if they are set, turn the ignition switch to ON **II**\*1, without starting the engine. The malfunction indicator lamp will come on for several seconds. If it then goes off, the readiness codes are set. If it blinks five times, the readiness codes are not set.

If you are required to have your vehicle tested before the readiness codes are ready, prepare the vehicle for retesting by doing the following:

1. Fill the gas tank to approximately 3/4 full.
2. Park the vehicle and leave the engine off for 6 hours or more.
3. Make sure the ambient temperature is between 40°F and 95°F (4°C and 35°C).
4. Start the engine without touching the accelerator pedal, and let it idle for 20 seconds.
5. Keep the vehicle in **P** (continuously variable transmission) or **N** (manual transmission). Increase the engine speed to 2,000 rpm, and hold it there for about three minutes.
6. Let the engine idle with your foot off the accelerator for 20 seconds.

### Testing of Readiness Codes

The readiness codes are erased when the battery is disconnected, and set again only after several days of driving under a variety of conditions.

If a testing facility determines that the readiness codes are not set, you may be requested to return at a later date to complete the test.

If the testing facility determines the readiness codes are still not set, see a dealer.

\*1: Models with the smart entry system have an **ENGINE START/STOP** button instead of an ignition switch.

7. Select a nearby, lightly traveled major highway where you can maintain a speed of 50 to 60 mph (80 to 97 km/h) for at least 20 minutes. Drive on the highway in **D** (automatic) or 6MT (manual). Do not use cruise control. When traffic allows, drive for 90 seconds without moving the accelerator pedal. (Vehicle speed may vary slightly; this is okay.) If you cannot do this for a continuous 90 seconds because of traffic conditions, drive for at least 30 seconds, then repeat it two more times (for a total of 90 seconds).
8. Drive in city or suburban traffic for at least 10 minutes. When traffic conditions allow, let the vehicle coast for several seconds without using the accelerator pedal or the brake pedal.
9. Park the vehicle and leave the engine off for 30 minutes.

## ■ U.S. Owners

Your new vehicle is covered by these warranties:

***New Vehicle Limited Warranty*** – covers your new vehicle, except for the emissions control systems and accessories, against defects in materials and workmanship.

***Emissions Control Systems Defects Warranty and Emissions Performance Warranty*** – these two warranties cover your vehicle's emissions control systems. Time, mileage, and coverage are conditional. Please read your warranty booklet for exact information.

***Seat Belt Limited Warranty*** – a seat belt that fails to function properly is covered by a limited warranty. Please read your warranty booklet for details.

***Rust Perforation Limited Warranty*** – all exterior body panels are covered for rust-through from the inside for the specified time period with no mileage limit.

***Accessory Limited Warranty*** – Honda accessories are covered under this warranty. Time and mileage limits depend on the type of accessory and other factors. Please read your warranty booklet for details.

***Replacement Parts Limited Warranty*** – covers all Honda replacement parts against defects in materials and workmanship.

**Replacement Battery Limited Warranty** – provides prorated coverage for a replacement battery purchased from a dealer.

**Replacement Muffler Lifetime Limited Warranty** – provides coverage for as long as the purchaser of the muffler owns the vehicle.

Restrictions and exclusions apply to all these warranties. Please read the Honda warranty information booklet that came with your vehicle for precise information on warranty coverages. Your vehicle's original tires are covered by their manufacturer. Tire warranty information is in a separate booklet.

#### ■ Canadian Owners

Please refer to the warranty manual that came with your vehicle.

#### ■ EPA Contact Information

An owner may obtain further information concerning emission warranties or report violations of the terms of the emission warranties by contacting:

U.S. Environmental Protection Agency  
Office of Transportation and Air Quality  
Compliance Division, Light-Duty Vehicle Group  
Attn: Warranty Complaints  
2000 Traverwood Drive  
Ann Arbor, MI 48105  
Email: [complianceinfo@epa.gov](mailto:complianceinfo@epa.gov)

## ■ Service Express

For electronic copies of service publications, you can purchase a subscription to Service Express. Visit [www.techinfo.honda.com](http://www.techinfo.honda.com) for pricing and options.

## ■ For U.S. Owners

Manuals be purchased from Helm Incorporated. You can order a manual by phone at 1- (800) 782-4356 (credit card orders only), or online at [www.helminc.com](http://www.helminc.com).

## ■ For Canadian Owners

Please contact a dealer to order any manuals that you may require.



Honda dealership personnel are trained professionals.

They should be able to answer all your questions. If you encounter a problem that your dealership does not solve to your satisfaction, please discuss it with the dealership's service manager or general manager. If you are dissatisfied with the decision made by the dealership's management, contact Honda Customer Services.

## U.S. Owners

American Honda Motor Co., Inc.  
Honda Automobile Customer Services  
Mail Stop 100-5E-8A  
1919 Torrance Blvd.  
Torrance, CA 90501-2746  
Tel: 1 (800) 999-1009

## Canadian Owners

Honda Canada Inc.  
Customer Relations  
180 Honda Boulevard  
Markham, ON  
L6C 0H9  
Tel: 1-888-9-HONDA-9  
Fax: 1-877-939-0909  
E-mail: Honda\_cr@ch.honda.com

## In Puerto Rico and the U.S. Virgin Islands

Bella International  
P.O. Box 190816  
San Juan, PR 00919-0816  
Tel: 1 (787) 620-7546

## Customer Service Information

When you call or write, please give us the following information:

- Vehicle Identification Number
  - ▣ **Vehicle Identification Number (VIN), Engine Number, and Transmission Number** P. 576
- Date of purchase
- Odometer reading of your vehicle
- Your name, address, and telephone number
- A detailed description of the problem
- Name of the dealer who sold the vehicle to you

## ■ Disclaimer of Pandora®\*

### Requirements to access Pandora®

- Latest version of the Pandora app installed on your Android, Blackberry, or iPhone.
- Registered Pandora account (you can create a free account at [www.pandora.com](http://www.pandora.com) <<http://www.pandora.com>> or on your smartphone)
- Connection to the internet via WiFi or cellular data network.
- Android devices must be connected to the vehicle via *Bluetooth*, iPhone® devices may be connected via USB or *Bluetooth*.

### Limitations

- Access to Pandora requires an active internet connection
- Ability to access Pandora through this system is subject to change without notice
- Certain functionality of Pandora service is not available when accessing the service through this system including, but not limited to, creating new stations, deleting stations, emailing current stations, buying songs, viewing additional text information, logging in to Pandora, and adjusting Cell Network Audio Quality. Pandora internet radio is a music service not affiliated with HONDA. More information is available at <http://www.pandora.com> <<http://www.pandora.com>>. Pandora, the Pandora logo, and the Pandora trade dress are trademarks or registered trademarks of Pandora Media, Inc., used with permission.
- Mobile access requires a smartphone with an active data plan. Standard data rates may apply.
- Pandora is only available in the United States.

## Numbers

7-Speed Manual Shift Mode ..... 421

## A

ABS (Anti-lock Brake System) ..... 470

Accessories and Modifications ..... 542

Accessory Power Socket ..... 192

Adaptive Cruise Control (ACC) ..... 89, 433

### Additives

Coolant ..... 506

Engine Oil ..... 501

Washer ..... 510

Additives, Engine Oil ..... 501

### Adjusting

Front Seats ..... 175

Head Restraints ..... 182

Headlights ..... 511

Mirrors ..... 174

Rear Seats ..... 179

Steering Wheel ..... 173

Temperature ..... 103

Adjusting the Sound ..... 249

### Air Conditioning System

Climate Control System ..... 200

Defrosting the Windshield

and Windows ..... 201

Dust and Pollen Filter ..... 536

### Air Conditioning System

(Heating and Cooling System)

Cooling ..... 199

Defrosting the Windshield

and Windows ..... 199

Heating ..... 198

Heating and Cooling System ..... 197

Air Pressure ..... 524, 575

Airbags ..... 46

Advanced Airbags ..... 52

Airbag Care ..... 59

Event Data Recorder ..... 0

Front Airbags (SRS) ..... 49

Indicator ..... 57, 80

Passenger Front Airbag Off Indicator ..... 58

Sensors ..... 46

Side Airbags ..... 53

Side Curtain Airbags ..... 55

Android Auto ..... 293

Anti-lock Brake System (ABS) ..... 470

Indicator ..... 80

Apple CarPlay ..... 289

Armrest ..... 186

Audio Remote Controls ..... 210

Audio System ..... 206

Adjusting the Sound ..... 217

Error Messages ..... 312

General Information ..... 317

MP3/WMA/AAC ..... 227, 276

Recommended CDs ..... 318

Recommended Devices ..... 320

Remote Controls ..... 5, 210

Security Code ..... 208

Theft Protection ..... 208

USB Flash Drives ..... 320

USB Port(s) ..... 207

Audio/Information Screen ..... 213, 234

Authorized Manuals ..... 584

Auto Door Locking/Unlocking ..... 139

Customize ..... 140

Auto High-Beam ..... 164

Automatic Climate Control Sensors ..... 204

Average Fuel Economy ..... 105, 109

Average Speed ..... 110

## B

Battery ..... 532

Charging System Indicator ..... 78, 560

Jump Starting ..... 555

Maintenance (Checking the Battery) ..... 532

Maintenance (Replacing) ..... 534

Belts (Seat) ..... 36

Beverage Holders ..... 190

Bluetooth® HandsFreeLink® ..... 343, 368

Booster Seats (For Children) ..... 72

Brake System ..... 468

Anti-lock Brake System (ABS) ..... 470

Brake Assist System ..... 471

Fluid ..... 509

Foot Brake ..... 469

Indicator ..... 76, 562

Parking Brake ..... 468

Brake System Indicator ..... 76

Brightness Control (Instrument Panel) ... 171

<b>Bulb Replacement</b> .....	511
Back-Up Light and Rear Turn Signal	
Lights.....	515
Brake/Tail/Rear Side Marker Lights .....	516
Fog Lights.....	513
Headlights.....	511
High-Mount Brake Light .....	516
Rear License Plate Light.....	517
Side Turn Signal/Emergency Indicator	
Lights.....	514
<b>Bulb Specifications</b> .....	574

## C

<b>Carbon Monoxide Gas</b> .....	73
<b>Cargo Area Cover</b> .....	195
<b>Cargo Floor Box</b> .....	191
<b>Carrying Cargo</b> .....	401, 403
<b>CD Player</b> .....	221
<b>Certification Label</b> .....	576
<b>Changing Bulbs</b> .....	511
<b>Charging System Indicator</b> .....	78, 560
<b>Child Safety</b> .....	60
Childproof Door Locks.....	138
<b>Child Seat</b> .....	60
Booster Seats.....	72
Child Seat for Infants.....	62
Child Seat for Small Children .....	63
Installing a Child Seat with	
a Lap/Shoulder Seat Belt .....	67
Larger Children.....	71

Rear-facing Child Seat .....	62
Selecting a Child Seat.....	64
<b>Childproof Door Locks</b> .....	138
<b>Cleaning the Exterior</b> .....	539
<b>Cleaning the Interior</b> .....	537
<b>Climate Control System</b> .....	200
<b>Clock</b> .....	122
<b>CMBS™ (Collision Mitigation Braking</b>	
<b>System™)</b> .....	472
<b>Coat Hook</b> .....	193
<b>Collision Mitigation Braking System™</b>	
<b>(CMBS™)</b> .....	472
<b>Compact Spare Tire</b> .....	545, 575
<b>Console Compartment</b> .....	189
<b>Continuously Variable Transmission</b> .....	416
7-Speed Manual Shift Mode.....	421
Creeping.....	416
Fluid.....	508
Kickdown.....	416
Operating the Shift Lever.....	21, 418, 420
Shift Lever Does Not Move .....	557
Shifting .....	417, 419
<b>Controls</b> .....	121
<b>Coolant (Engine)</b> .....	506
Adding to the Radiator.....	507
Adding to the Reserve Tank.....	506
High Temperature Indicator.....	81
Low Temperature Indicator.....	81
Overheating .....	558
<b>Creeping (Continuously Variable</b>	
<b>Transmission)</b> .....	416

<b>Cruise Control</b> .....	428
Indicator .....	86
<b>Cup Holders</b> .....	190
<b>Customer Service Information</b> .....	585
<b>Customized Features</b> .....	111, 321, 328

## D

<b>Daytime Running Lights</b> .....	168
<b>Dead Battery</b> .....	555
<b>Defrosting the Windshield</b>	
<b>and Windows</b> .....	199
<b>Devices that Emit Radio Waves</b> .....	577
<b>Dimming</b>	
Headlights .....	160
Rearview Mirror .....	174
<b>Dipstick (Engine Oil)</b> .....	502
<b>Directional Signals (Turn Signal)</b> .....	159
<b>Display Setup</b> .....	218, 250
<b>Door Mirrors</b> .....	174
<b>Doors</b> .....	124
Auto Door Locking.....	139
Auto Door Unlocking .....	139
Door and Tailgate Open Indicator .....	35, 82
Keys.....	124
Locking/Unlocking the Doors	
from the Inside.....	135
Locking/Unlocking the Doors	
from the Outside.....	127
Lockout Prevention System .....	134
<b>DOT Tire Quality Grading</b> .....	526



## Gear Shift Lever Positions

Continuously Variable Transmission .....	417, 419
Manual Transmission .....	424
Glass (care) .....	537, 540
Glove Box .....	189

## H

Halogen Bulbs .....	511, 513
Handling the Unexpected .....	543
Hands-Free Telephone (HFT) System	
Android Auto .....	293
Apple CarPlay .....	289
HandsFreeLink® (HFL) .....	343, 368
Displaying Messages .....	393
In Case of Emergency .....	396
Menus .....	345
Phone Setup .....	349, 375
Phonebook Phonetic Modification .....	384
To Set Up Text Message/E-mail Options ...	378
Hazard Warning Button .....	4
HD Radio™ .....	256
Head Restraints .....	182
Headlights .....	160
Aiming .....	511
Dimming .....	160, 168
Operating .....	160
Heated Door Mirrors .....	172
Heating and Cooling System .....	197
Cooling .....	199

Defrosting the Windshield and Windows .....	199
Dust and Pollen Filter .....	536
Heating .....	198
HFL (HandsFreeLink®) .....	343, 368
High-Beam Indicator .....	84
Hill Start Assist System .....	410, 414
Honda Sensing® .....	24
HondaLink® .....	281

## I

Identification Numbers .....	576
Engine and Transmission .....	576
Vehicle Identification .....	576
Ignition Switch .....	154
Illumination Control .....	171
Knob .....	171
Immobilizer System .....	148
Indicator .....	85
Indicators .....	76
ABS (Anti-lock Brake System) .....	80
Adaptive Cruise Control (ACC) (Amber) .....	89
Adaptive Cruise Control (ACC) (Green) .....	89, 434
Brake System .....	76
Charging System .....	78, 560
Collision Mitigation Braking System™ (CMBS™) .....	90
CRUISE CONTROL .....	86, 429
CRUISE MAIN .....	86, 428

Door and Tailgate Open .....	35, 82
ECON Mode .....	85, 427
EPS (Electric Power Steering) System .....	82, 562
Fog Light .....	85
High Temperature .....	81
High-Beam .....	84
Immobilizer System .....	85
Lane Keeping Assist System (LKAS) (Amber) .....	89
Lane Keeping Assist System (LKAS) (Green) .....	89, 454
Lights On .....	84
Low Fuel .....	80
Low Oil Pressure .....	77, 560
Low Temperature .....	81
Low Tire Pressure .....	463
Maintenance Minder™ .....	87, 491
Malfunction Indicator Lamp .....	77, 561
Parking Brake and Brake System .....	76, 562
Road Departure Mitigation (RDM) .....	88
Seat Belt Reminder .....	38, 79
Security System Alarm .....	86
Shift Lever Position .....	78
Smart Entry System .....	83
Starter System .....	96
Supplemental Restraint System .....	57, 80
TPMS .....	83
Transmission .....	78
Turn Signal .....	84

VSA® (Vehicle Stability Assist)	
System .....	81, 459
VSA® OFF.....	82, 460
Washer Level .....	87
<b>Information</b> .....	573
<b>Information Display</b> .....	104
<b>Instant Fuel Economy</b> .....	110
<b>Instrument Panel</b> .....	75
Brightness Control .....	171
<b>Interior Lights</b> .....	187
<b>Interior Rearview Mirror</b> .....	174
<b>Internet Radio</b> .....	274

## J

<b>Jack (Wheel Nut Wrench)</b> .....	544, 548
<b>Jump Starting</b> .....	555

## K

<b>Keyless Lockout Prevention</b> .....	134
<b>Keys</b> .....	124
Lockout Prevention .....	134
Rear Door Won't Open .....	138
Remote Transmitter .....	131
Types and Functions.....	124
Won't Turn .....	27
<b>Kickdown (Continuously Variable Transmission)</b> .....	416

## L

<b>Lane Keeping Assist System (LKAS)</b> .....	452
<b>LaneWatch™</b> .....	461
<b>LATCH (Child Seats)</b> .....	65
<b>Lights</b> .....	160, 511
Bulb Replacement.....	511
Daytime Running Lights .....	168
Fog Lights.....	163
High-Beam Indicator .....	84
Interior .....	187
Light Switches .....	160
Lights On Indicator .....	84
Turn Signals.....	159
<b>Load Limits</b> .....	403
<b>Locking/Unlocking</b> .....	124
Auto Door Locking/Unlocking .....	139
Childproof Door Locks .....	138
From Inside.....	135
From Outside.....	127
Keys .....	124
Lockout Prevention System .....	134
Using a Key .....	133
<b>Lockout Prevention System</b> .....	134
<b>Low Battery Charge</b> .....	560
<b>Low Fuel Indicator</b> .....	80
<b>Low Oil Pressure Indicator</b> .....	77, 560
<b>Lower Anchors</b> .....	65
<b>Lubricant Specifications Chart</b> .....	575
<b>Luggage (Maximum Load Limit)</b> .....	403

## M

<b>Maintenance</b> .....	487
Battery .....	532
Brake Fluid .....	509
Cleaning .....	537
Coolant.....	506
Heating and Cooling System .....	536
Maintenance Minder™.....	491
Oil.....	502
Precautions .....	489
Radiator .....	507
Remote Transmitter.....	534
Replacing Light Bulbs .....	511
Safety.....	489
Service Items .....	493, 497
Tires .....	522
Transmission Fluid .....	508
Under the Hood .....	499
<b>Malfunction Indicator Lamp</b> .....	77, 561
<b>Manual Transmission</b> .....	423
Reverse Lockout .....	425
<b>Map Lights</b> .....	188
<b>Maximum Load Limit</b> .....	403
<b>Meters, Gauges</b> .....	103
<b>Mirrors</b> .....	174
Adjusting .....	174
Door .....	174
Exterior .....	174
Interior Rearview .....	174
<b>Modifications (and Accessories)</b> .....	542
<b>Moonroof</b> .....	153

MP3.....	221, 227, 276
Multi-Information Display.....	107
Multi-View Rear Camera.....	481

## N

Numbers (Identification).....	576
-------------------------------	-----

## O

Odometer.....	105, 109
Oil (Engine).....	501
Adding.....	503
Checking.....	502
Displaying Oil Life.....	491, 495
Low Oil Pressure Indicator.....	77, 560
Recommended Engine Oil.....	501
Viscosity.....	501
Open Source Licenses.....	311
Opening and Closing the Moonroof.....	153
Opening/Closing.....	
Hood.....	500
Power Windows.....	151
Tailgate.....	145
Outside Temperature Display.....	103
Overheating.....	558

## P

Paddle Shifters (7-Speed Manual Shift Mode).....	21, 421, 422
Pandora®.....	274

Panic Mode.....	150
Parking.....	480
Parking Brake.....	468
Parking Brake and Brake System Indicator.....	76, 562
Passenger Front Airbag Off Indicator.....	58
Passing Indicators.....	160
Playing <i>Bluetooth</i> ® Audio.....	230, 279
Precautions While Driving.....	415
Rain.....	415
Pregnant Women.....	44
Puncture (Tire).....	545

## R

Radiator.....	507
Radio (FM/AM).....	219
Radio (SiriusXM®).....	259
Radio Data System (RDS).....	220, 257
Range.....	109
RDS (Radio Data System).....	220, 257
Readiness Codes (Emissions Testing).....	580
Rear Defogger/Heated Door Mirror Button.....	172
Rear Seats (Folding Down).....	180
Rearview Mirror.....	174
Refueling.....	483
Fuel Gauge.....	106, 110
Gasoline.....	483, 574
Low Fuel Indicator.....	80
Regulations.....	466, 526, 577

Remote Transmitter.....	131
Replacement.....	
Battery.....	534
Bulbs.....	511
Fuses.....	564, 566
Tires.....	529
Wiper Blade Rubber.....	518, 520
Reporting Safety Defects.....	579
Resetting a Trip Meter.....	105, 109
Road Departure Mitigation (RDM).....	447
Indicator.....	88
On and Off.....	449

## S

Safe Driving.....	31
Safety Check.....	35
Safety Labels.....	74
Safety Message.....	1
Seat Belts.....	36
Adjusting the Shoulder Anchor.....	42
Automatic Seat Belt Tensioners.....	39
Checking.....	45
Detachable Anchor.....	43
Fastening.....	40
Installing a Child Seat with a Lap/Shoulder Seat Belt.....	67
Pregnant Women.....	44
Reminder.....	38
Warning Indicator.....	38, 79
Seat Heaters.....	196



Seats.....	175	Starter System Indicator.....	96	Labeling.....	524
Adjusting.....	175	Starting the Engine.....	409, 411	Puncture (Flat Tire).....	545
Front Seats.....	175	Does Not Start.....	552	Regulations.....	526
Rear Seats.....	179	Engine Switch Buzzer.....	154	Rotation.....	530
Security System.....	148	Jump Starting.....	555	Spare Tire.....	545, 575
Immobilizer System Indicator.....	85	Steering Wheel.....	173	Summer.....	531
Security System Alarm Indicator.....	86	Adjusting.....	173	Tire Chains.....	531
SEL/RESET Button.....	108	Stopping.....	480	Wear Indicators.....	528
Select Lever.....	21, 417, 419	Summer Tires.....	531	Winter.....	531
Operation.....	21, 418, 420	Supplemental Restraint System (SRS).....	49	Tools.....	544
Releasing.....	557	Switches		Towing a Trailer.....	405
Won't Move.....	557	(Around the Steering Wheel).....	4, 5, 154	Towing Your Vehicle	
Select/Reset Knob.....	104	<b>T</b>		Emergency.....	569
Selecting a Child Seat.....	64	Tachometer.....	103	TPMS (Tire Pressure Monitoring	
Selector Knob (Audio).....	212	Tailgate.....	145	System).....	463
Setting the Clock.....	122	Temperature		Indicator.....	83
Shift Lever.....	21, 417, 419, 423	High Temperature Indicator.....	81	Transmission.....	417, 419, 423
Shift Lever Position Indicator.....	78, 418, 420	Low Temperature Indicator.....	81	7-Speed Manual Shift Mode.....	421
Shifting (Transmission).....	417, 419, 423	Outside Temperature Display.....	103	Continuously Variable.....	416
Shoulder Anchor.....	42	Temperature Sensor.....	103	Fluid.....	508
Side Airbags.....	53	Tie-down Hooks.....	194	Manual.....	423
Side Curtain Airbags.....	55	Time (Setting).....	122	Number.....	576
Siri Eyes Free.....	288	Tire Pressure Monitoring System		Shift Position Indicator.....	78, 418, 420
SiriusXM® Radio.....	259	(TPMS).....	463	Trip Meter.....	105, 109
Snow Tires.....	531	Indicator.....	83	Troubleshooting.....	543
Spare Tire.....	545, 575	Tires.....	522	Blown Fuse.....	564, 566
Spark Plugs.....	574	Air Pressure.....	524, 575	Brake Pedal Vibrates.....	27
Specifications.....	574	Checking and Maintaining.....	522	Buzzer Sounds When Opening Door.....	28
Specified Fuel.....	483, 574	Inspection.....	523	Emergency Towing.....	569
Speedometer.....	103			Engine Won't Start.....	552
SRS Airbags (Airbags).....	49			Noise When Braking.....	29

Overheating.....	558
Puncture/Flat Tire.....	545
Rear Door Won't Open.....	28, 138
Select Lever Won't Move.....	557
Warning Indicators.....	76
Turn Signals.....	159
Indicators (Instrument Panel).....	84

## U

Unlocking the Doors.....	127, 135
USB Flash Drives.....	320
USB Port(s).....	207

## V

Vanity Mirrors.....	7
Vehicle Identification Number (VIN).....	576
Vehicle Stability Assist (VSA®).....	459
Off Button.....	460
Off Indicator.....	82
System Indicator.....	81
Viscosity (Oil).....	501, 575
Voice Control Operation.....	252
Audio Commands.....	254
General Commands.....	254
Music Search Commands.....	254
On Screen Commands.....	254
Phone Commands.....	254
Voice Portal Screen.....	253
Voice Recognition.....	252

VSA® (Vehicle Stability Assist).....	459
--------------------------------------	-----

## W

Wallpaper.....	239
Warning and Information Messages... ..	91, 92
Warning Indicator On/Blinking.....	560
Warning Labels.....	74
Warranties (Warranty Manual provided separately).....	582
Watts.....	574
Wear Indicators (Tire).....	528
Wheel Nut Wrench	
(Jack Handle).....	544, 548
Wi-Fi Connection.....	286
Window Washers.....	169
Adding/Refilling Fluid.....	510
Switch.....	169
Windshield.....	169
Cleaning.....	537, 540
Defrosting/Defogging.....	199
Washer Fluid.....	510
Wiper Blades.....	518
Wipers and Washers.....	169
Winter Tires.....	531
Snow Tires.....	531
Tire Chains.....	531
Wipers and Washers.....	169
Checking and Replacing Wiper Blades.....	518, 520
WMA.....	221, 227, 276

Worn Tires.....	522, 528
-----------------	----------





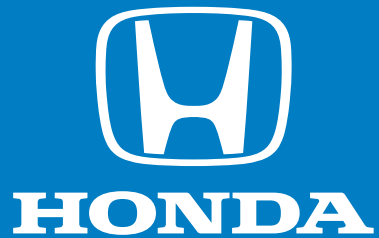

31T5A6400  
OM-07578  
0031X-T5A-6400

[owners.honda.com](https://owners.honda.com) (U.S.)  
[myhonda.ca](https://myhonda.ca) (Canada)

2019 Honda Fit Owner's Manual  
©2018 Honda Motor Co., Ltd. — All Rights Reserved

Printed in U.S.A.