

## TABLE OF CONTENTS

1	<b>Before driving</b>	Adjusting and operating features such as door locks, mirrors, and steering column.
2	<b>When driving</b>	Driving, stopping and safe-driving information.
3	<b>Interior features</b>	Air conditioning and audio systems, as well as other interior features for a comfortable driving experience.
4	<b>Maintenance and care</b>	Cleaning and protecting your vehicle, performing do-it-yourself maintenance, and maintenance information.
5	<b>When trouble arises</b>	What to do if the vehicle needs to be towed, gets a flat tire, or is involved in an accident.
6	<b>Vehicle specifications</b>	Detailed vehicle information.
7	<b>For U.S. owners</b>	Reporting safety defects for U.S. owners.
	<b>Index</b>	Alphabetical listing of information contained in this manual.

<b>1</b>	<b>Before driving</b>	
<b>1-1.</b>	<b>Key information .....</b>	<b>24</b>
	Keys .....	24
<b>1-2.</b>	<b>Opening, closing and locking the doors .....</b>	<b>26</b>
	Smart key system .....	26
	Wireless remote control .....	40
	Side doors .....	43
	Back door .....	48
<b>1-3.</b>	<b>Adjustable components (seats, mirrors, steering wheel) .....</b>	<b>51</b>
	Front seats .....	51
	Rear seats .....	53
	Driving position memory system .....	62
	Head restraints .....	65
	Seat belts .....	69
	Steering wheel .....	77
	Inside rear view mirror .....	79
	Outside rear view mirrors .....	80
<b>1-4.</b>	<b>Opening and closing the windows and moon roof .....</b>	<b>83</b>
	Power windows .....	83
	Moon roof .....	86
<b>1-5.</b>	<b>Refueling .....</b>	<b>89</b>
	Opening the fuel tank cap .....	89
<b>1-6.</b>	<b>Theft deterrent system .....</b>	<b>93</b>
	Engine immobilizer system .....	93
	Alarm .....	97
	Theft prevention labels .....	99
<b>1-7.</b>	<b>Safety information .....</b>	<b>100</b>
	Correct driving posture .....	100
	SRS airbags .....	102
	Front passenger occupant classification system .....	117
	Child restraint systems .....	123
	Installing child restraints .....	127
<b>2</b>	<b>When driving</b>	
<b>2-1.</b>	<b>Driving procedures .....</b>	<b>140</b>
	Driving the vehicle .....	140
	Engine (ignition) switch .....	149
	Automatic transmission .....	153
	Turn signal lever .....	158
	Parking brake .....	159
<b>2-2.</b>	<b>Instrument cluster .....</b>	<b>160</b>
	Gauges and meters .....	160
	Indicators and warning lights .....	163
	Multi-information display .....	166
<b>2-3.</b>	<b>Operating the lights and wipers .....</b>	<b>170</b>
	Headlight switch .....	170
	Fog light switch .....	172
	Windshield wipers and washer .....	173

Rear window wiper and washer .....	176		
Headlight cleaner switch .....	177		
<b>2-4. Using other driving systems .....</b>	<b>178</b>		
Cruise control .....	178		
Toyota park assist system .....	181		
Four-wheel drive system .....	190		
Crawl control .....	197		
Driving assist systems .....	201		
Pre-Collision System .....	208		
<b>2-5. Driving information .....</b>	<b>209</b>		
Off-road precautions .....	209		
Cargo and luggage .....	214		
Vehicle load limits .....	221		
Winter driving tips .....	222		
Trailer towing .....	227		
Dinghy towing .....	239		
<hr/>			
<b>3 Interior features</b>			
<b>3-1. Using the air conditioning system and defogger .....</b>	<b>242</b>		
Front air conditioning system .....	242		
Rear air conditioning system .....	252		
Rear window and outside rear view mirror defoggers .....	256		
Windshield wiper de-icer .....	257		
<b>3-2. Using the audio system ...</b>	<b>258</b>		
Audio system type .....	258		
Using the radio .....	260		
Using the CD player .....	265	1	
Playing back MP3 and WMA discs .....	273		
Optimal use of the audio system .....	280		
Using the AUX adapter .....	282	2	
Using the steering switches .....	283		
<b>3-3. Using the rear seat entertainment system ....</b>	<b>285</b>	3	
Rear seat entertainment system features .....	285		
Using the radio .....	292		
Using the DVD changer .....	293	4	
Playing an audio CD/CD text .....	294		
Playing WMA/MP3 discs ...	295		
Playing DVD video/audio ...	296	5	
Playing a video CD .....	310		
DVD player and DVD video disc information .....	314		
Using the video mode .....	321		
Changing other settings .....	323	6	
<b>3-4. Using the interior lights ...</b>	<b>325</b>		
Interior lights list .....	325		
• Interior lights .....	326	7	
• Personal lights .....	327		
<b>3-5. Using the interior lights ...</b>	<b>328</b>		
List of storage features .....	328		
• Glove box .....	329		
• Console box/cool box .....	330		
• Overhead console .....	332		

TABLE OF CONTENTS | Index

- Cup holders ..... 333
- Bottle holders ..... 334
- Card holders and auxiliary box ..... 336

**3-6. Other interior features ..... 337**

- Sun visors ..... 337
- Vanity mirror ..... 338
- Clock ..... 339
- Outside temperature display ..... 340
- Ashtrays ..... 341
- Cigarette lighter ..... 343
- Power outlets ..... 344
- Seat heaters ..... 346
- Armrest ..... 348
- Floor mats ..... 349
- Luggage compartment features ..... 350
- Garage door opener ..... 352

**4-2. Maintenance ..... 365**

- Maintenance requirements ..... 365
- General maintenance ..... 367
- Emission inspection and maintenance (I/M) programs ..... 370

**4-3. Do-it-yourself maintenance ..... 371**

- Do-it-yourself service precautions ..... 371
- Hood ..... 374
- Engine compartment ..... 375
- Tires ..... 391
- Tire inflation pressure ..... 401
- Wheels ..... 405
- Air conditioning filter ..... 407
- Electronic key battery ..... 410
- Checking and replacing fuses ..... 413
- Light bulbs ..... 426

**4 Maintenance and care**

**4-1. Maintenance and care ..... 360**

- Cleaning and protecting the vehicle exterior ..... 360
- Cleaning and protecting the vehicle interior ..... 362

**5 When trouble arises**

**5-1. Essential information ..... 440**

- If your vehicle needs to be towed ..... 440
- If you think something is wrong ..... 445
- Fuel pump shut off system ..... 446
- Event data recorder ..... 447

<b>5-2. Steps to take in an emergency .....</b>	<b>449</b>
If a warning light turns on or a warning sounds... ..	449
If a warning message is displayed.....	460
If you have a flat tire.....	463
If the engine will not start ....	476
If the shift lever cannot be shifted from P.....	478
If you lose your keys .....	479
If you cannot operate back door opener .....	480
If the electronic key does not operate properly.....	481
If the battery is discharged .....	484
If your vehicle overheats ....	488
If the vehicle becomes stuck .....	491

## 6 Vehicle specifications

<b>6-1. Specifications.....</b>	<b>494</b>
Maintenance data (fuel, oil level, etc.) .....	494
Fuel information .....	504
Tire information .....	507
<b>6-2. Customization .....</b>	<b>519</b>
Customizable features .....	519
<b>6-3. Initialization .....</b>	<b>523</b>
Items to initialize .....	523

## 7 For U.S. owners

Reporting safety defects for U.S. owners.....	526	1
---	-----	---

## Index

Abbreviation list .....	528	2
Alphabetical index.....	530	3
What to do if.....	538	4

5

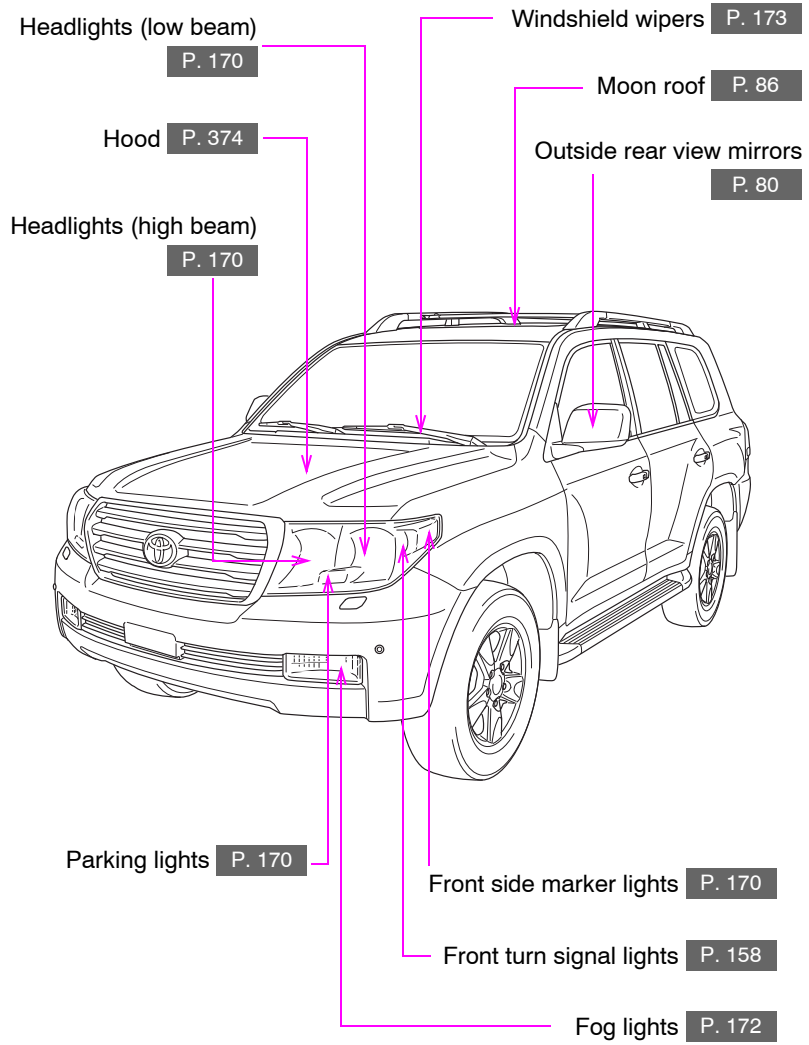

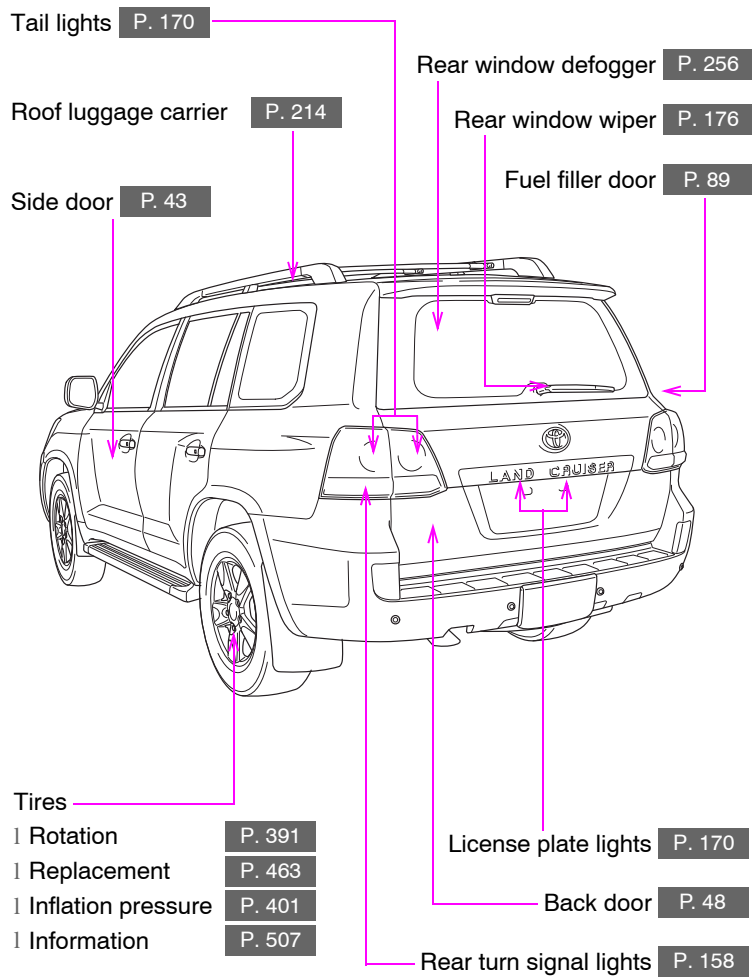

: If equipped

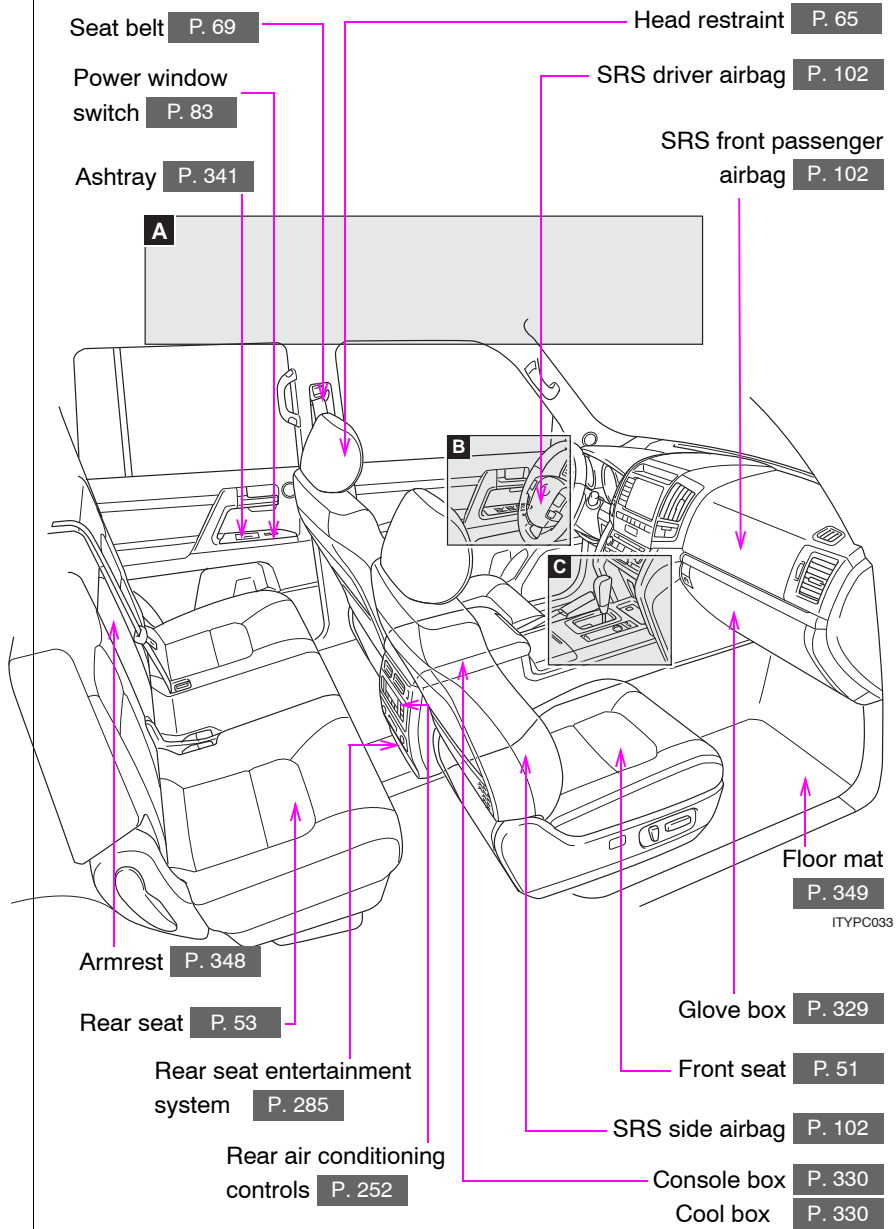



**A**

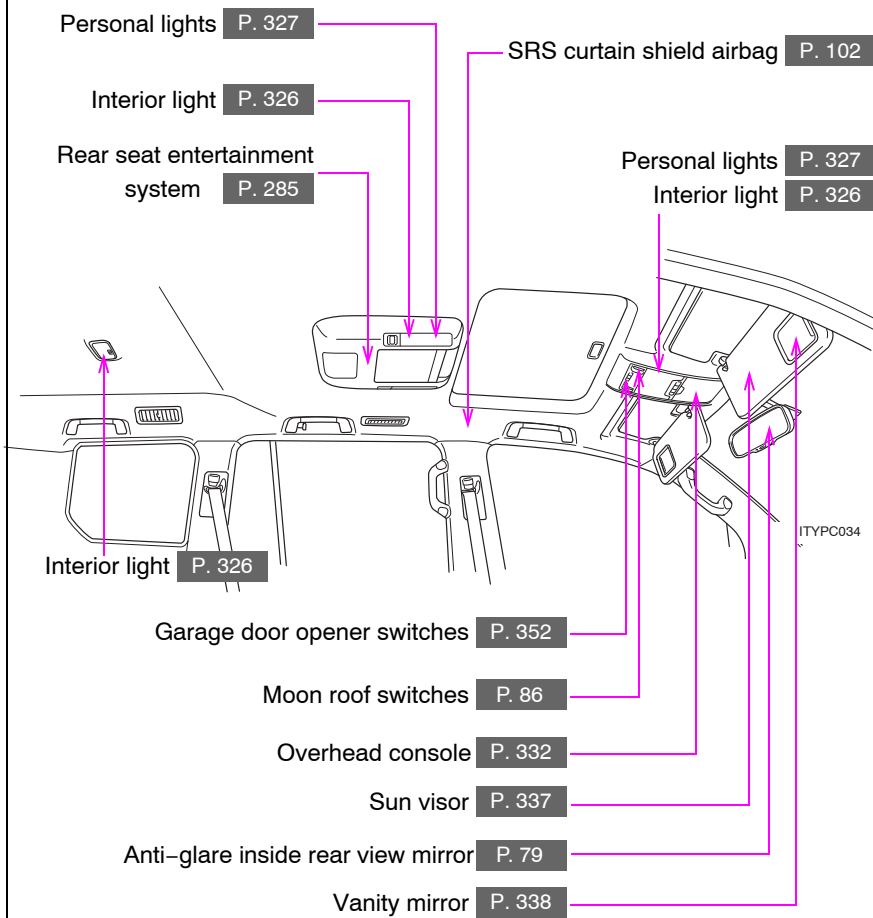

: If equipped

**B**

Driving position memory switches P. 62

Door lock switch P. 43

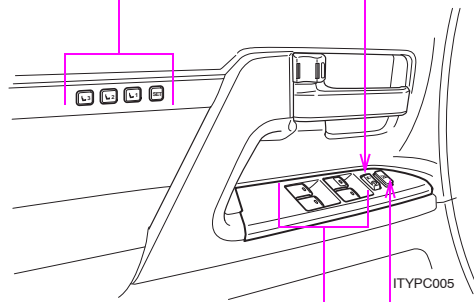

Power window switches P. 83

Window lock switch P. 83

**C**

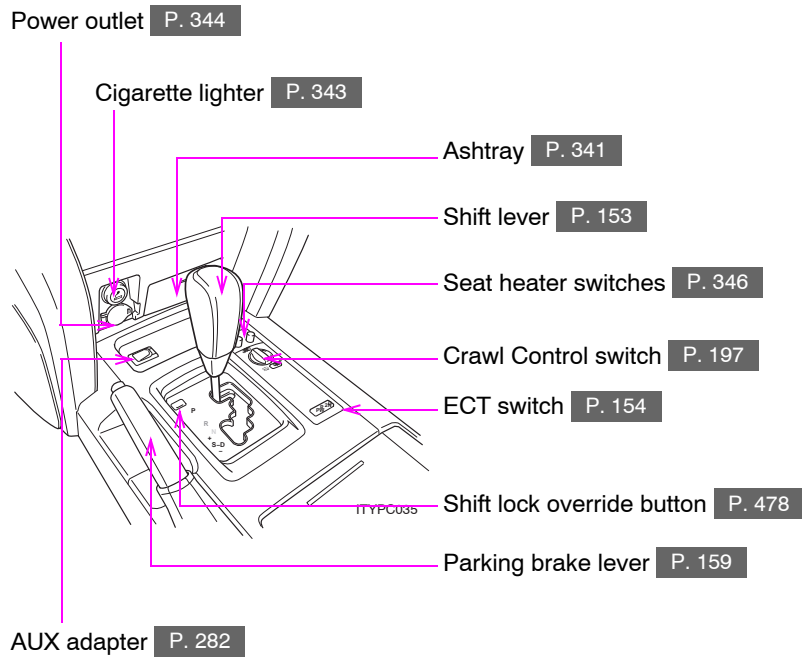

## Pictorial index

## Instrument panel

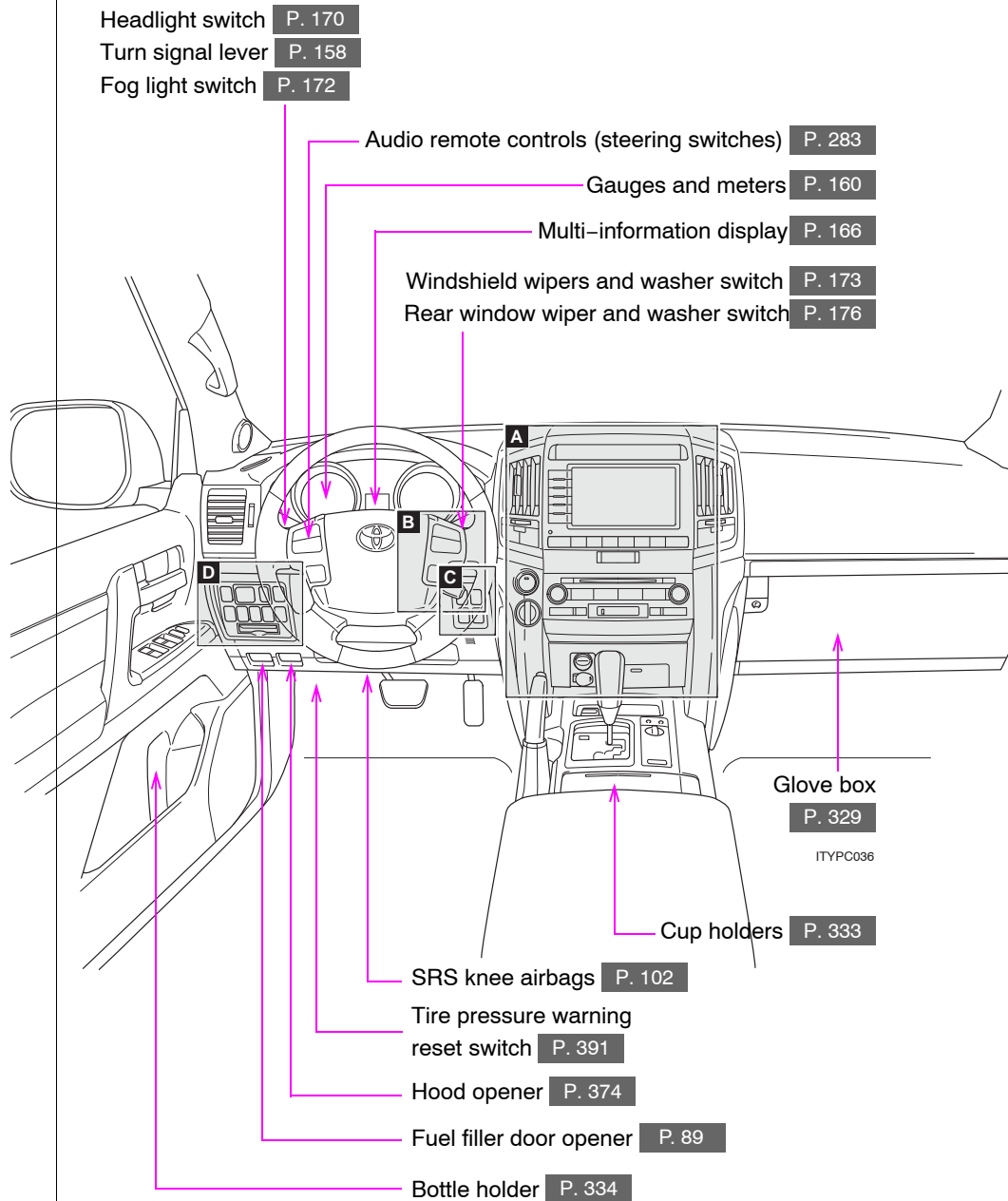

**A**

▶ Without navigation system

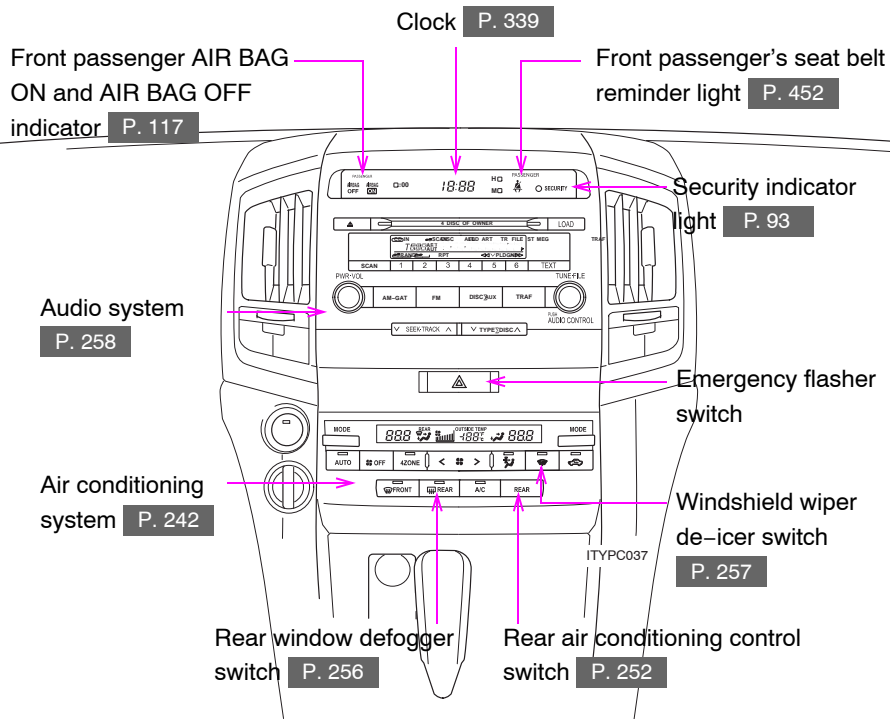

: If equipped

**A**

► With navigation system

Clock P. 339  
Outside temperature display P. 340  
Front passenger AIR BAG ON and AIR BAG OFF indicator P. 117  
Front passenger's seat belt reminder light P. 452

Navigation system\*  
Security indicator light P. 93  
Emergency flasher switch  
Audio system\*  
Air conditioning system\*  
Rear window defogger switch\*

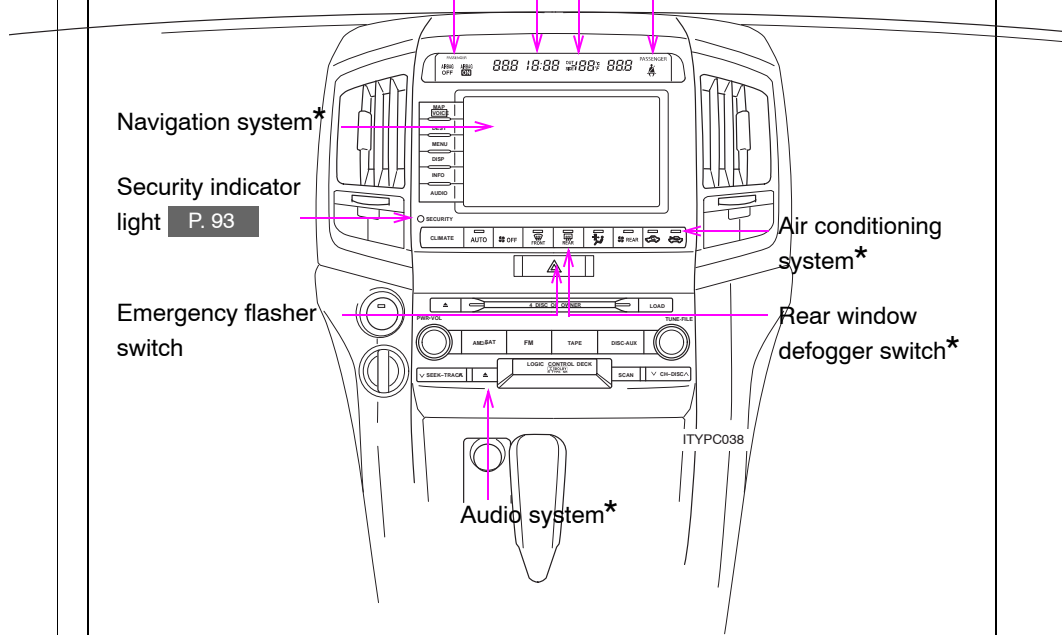

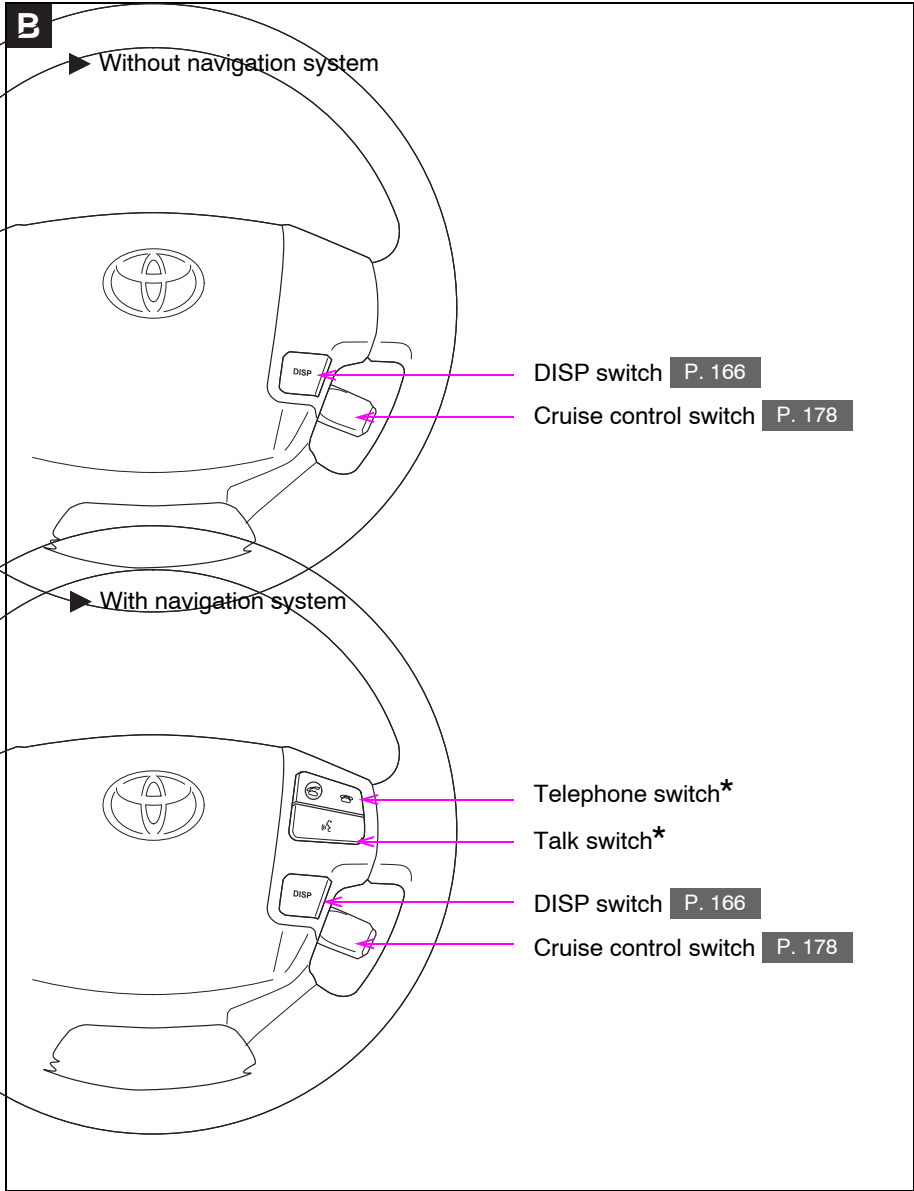

: If equipped  
\*: Refer to "Navigation System Owner's Manual".

**C**

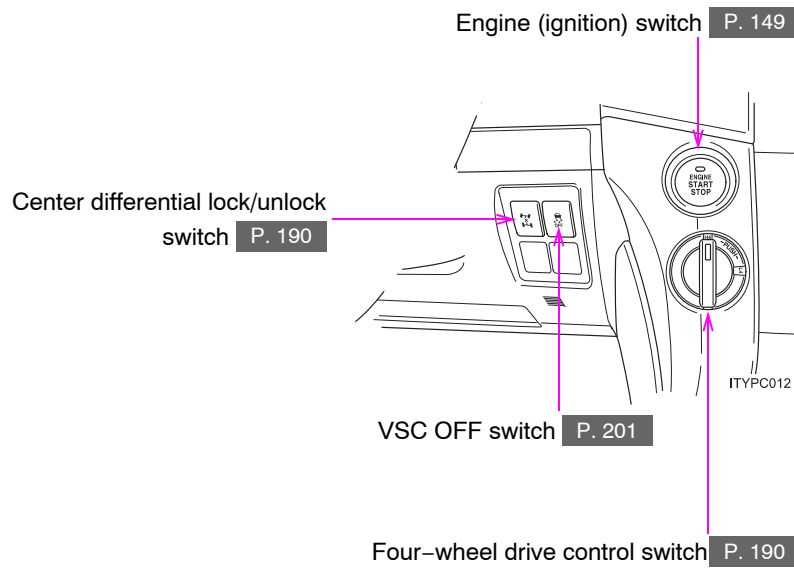



**D**

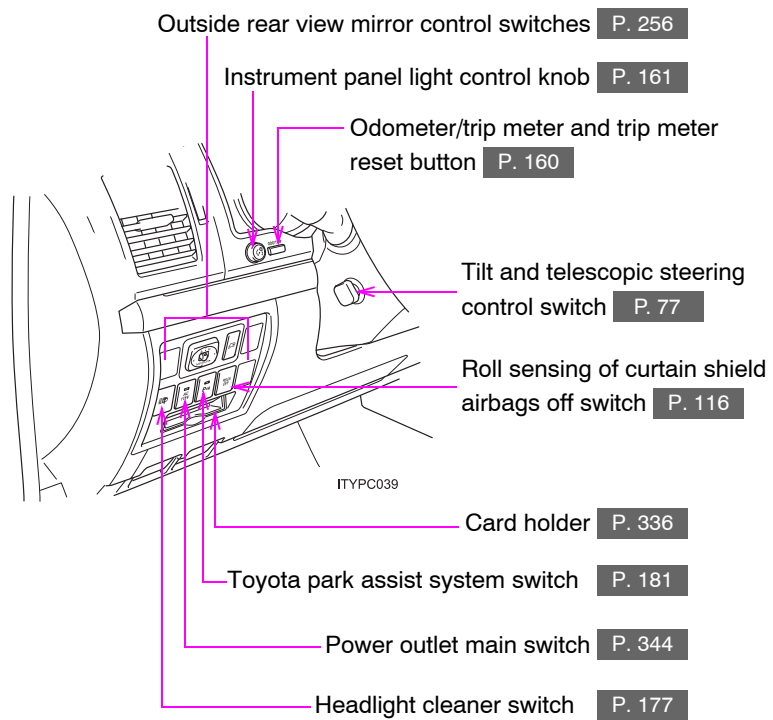

: If equipped

## For your information

### **Main Owner's Manual**

Please note that this manual applies to all models and explains all equipment, including options. Therefore, you may find some explanations for equipment not installed on your vehicle.

All specifications provided in this manual are current at the time of printing. However, because of the Toyota policy of continual product improvement, we reserve the right to make changes at any time without notice.

Depending on specifications, the vehicle shown in the illustration may differ from your vehicle in terms of equipment.

### **Accessories, spare parts and modification of your Toyota**

A wide variety of non-genuine spare parts and accessories for Toyota vehicles are currently available in the market. You should know that Toyota does not warrant these products and is not responsible for their performance, repair, or replacement, or for any damage they may cause to, or adverse effect they may have on, your Toyota vehicle.

This vehicle should not be modified with non-genuine Toyota products. Modification with non-genuine Toyota products could affect its performance, safety or durability, and may even violate governmental regulations. In addition, damage or performance problems resulting from the modification may not be covered under warranty.

### **Installation of a mobile two-way radio system**

As the installation of a mobile two-way radio system in your vehicle could affect electronic systems such as the multiport fuel injection system/sequential multiport fuel injection system, cruise control system, anti-lock brake system, SRS airbag system and seat belt pretensioner system, be sure to check with your Toyota dealer for precautionary measures or special instructions regarding installation.

Unwanted noise may occur in the reception of the mobile two-way radio.

### **Scrapping of your Toyota**

The SRS airbag and seat belt pretensioner devices in your Toyota contain explosive chemicals. If the vehicle is scrapped with the airbags and seat belt pretensioners left as they are, this may cause an accident such as fire. Be sure to have the systems of the SRS airbag and seat belt pretensioner removed and disposed of by a qualified service shop or by your Toyota dealer before you scrap your vehicle.

### **Perchlorate Material**

Special handling may apply, See [www.dtsc.ca.gov/hazardouswaste/perchlorate](http://www.dtsc.ca.gov/hazardouswaste/perchlorate).

Your vehicle has components that may contain perchlorate. These components may include airbag, seat belt pretensioners, and wireless remote control batteries.

 CAUTION

**n General precautions while driving**

Driving under the influence: Never drive your vehicle when under the influence of alcohol or drugs that have impaired your ability to operate your vehicle. Alcohol and certain drugs delay reaction time, impair judgment and reduce coordination, which could lead to an accident that will hurt or kill you, your occupants or others.

Defensive driving: Always drive defensively. Anticipate mistakes that other drivers or pedestrians might make and be ready to avoid accidents.

Driver distraction: Always give your full attention to driving. Anything that distracts the driver, such as adjusting controls, talking on a cellular phone or reading can result in a collision with resulting death or serious injury to you, your occupants or others.

**n General precaution regarding children's safety**

Never leave children unattended in the vehicle, and never allow children to have or use the key.

Children may be able to start the vehicle or shift the vehicle into neutral. There is also a danger that children may injure themselves by playing with the cigarette lighter, the windows, the moon roof, or other features of the vehicle. In addition, heat build-up or extremely cold temperatures inside the vehicle can be fatal to children.

## Symbols used throughout this manual

### Cautions & Notices

#### CAUTION

This is a warning against anything which may cause injury to people if the warning is ignored. You are informed about what you must or must not do in order to reduce the risk of injury to yourself and others.

#### NOTICE

This is a warning against anything which may cause damage to the vehicle or its equipment if the warning is ignored. You are informed about what you must or must not do in order to avoid or reduce the risk of damage to your Toyota and its equipment.

### Safety symbol



Throughout this manual, you will also see the symbol of a circle with a slash through it. This means “Do not”, “Do not do this”, or “Do not let this happen”.



## 1-1. Key information

# Keys

The following keys are provided with the vehicle.

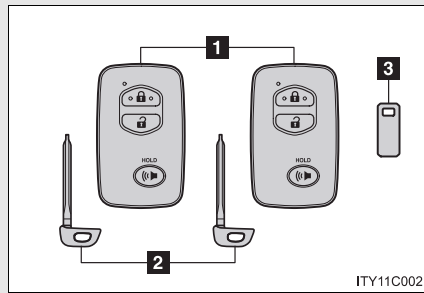

### 1 Electronic keys

- Operating the smart key system ( P. 26)
- Operating the wireless remote control function ( P. 40)

### 2 Mechanical keys

### 3 Key number plate

### Using the mechanical key

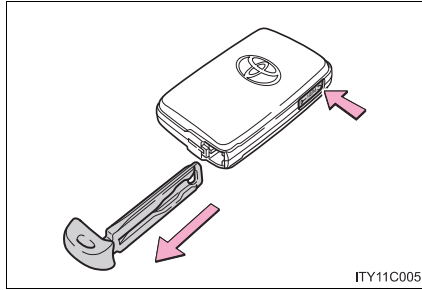

Take out the mechanical key.

After using the mechanical key, store it in the electronic key. Carry the mechanical key together with the electronic key. If the electronic key battery is depleted, you will need the mechanical key. ( P. 481)

1  
Before driving

#### n Key number plate

Keep the plate in a safe place such as your wallet, not in the vehicle. In the event that a key is lost, a new key can be made at your Toyota dealer using the key number plate. ( P. 479)

#### ⚠ NOTICE

##### n To prevent key damage

- ! Do not subject the keys to strong shocks, expose them to high temperatures by placing them in direct sunlight, or get them wet.
- ! Do not expose the keys to electromagnetic materials or attach any material that blocks electromagnetic waves to the key surface.
- ! Do not disassemble the electronic key.



1-2. Opening, closing and locking the doors  
Smart key system

The following operations can be performed simply by carrying the electronic key on your person, for example in your pocket.

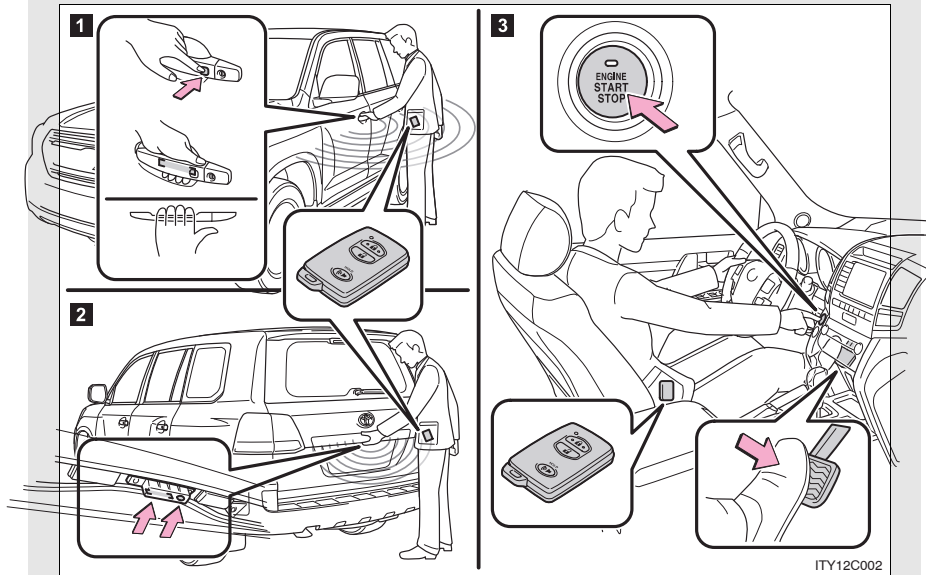

- 1** Locks and unlocks the side doors ( P. 27)
- 2** Locks and unlocks the back door ( P. 48)
- 3** Starts and stops the engine ( P. 149)

### Locking and unlocking the side doors

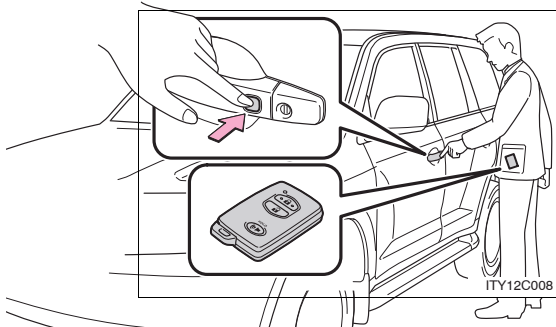

Press the lock button to lock the door.

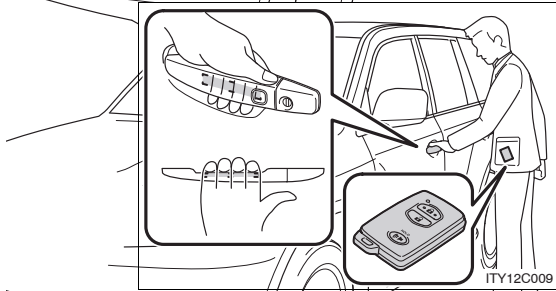

Grip the handle to unlock the door.

Make sure to touch the sensor on the back of the handle.

The door cannot be unlocked for 3 seconds after the door is locked.

### Locking and unlocking the back door

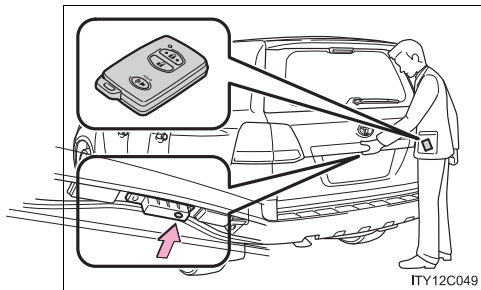

Press the lock button to lock the back door.

1-2. Opening, closing and locking the doors

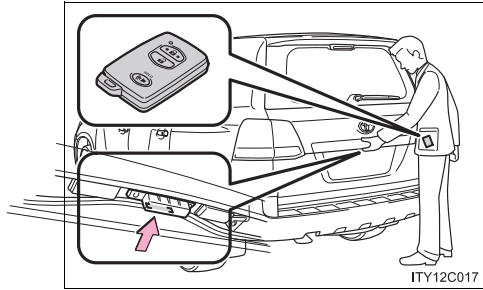

Press the unlock button to unlock the back door.

**Antenna location**

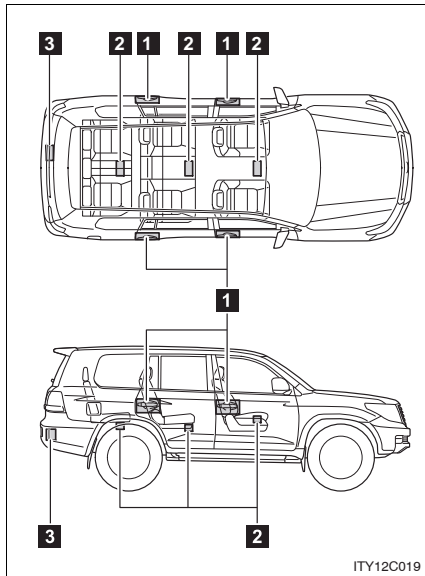

- 1** Antennas outside cabin
- 2** Antennas inside cabin
- 3** Antenna outside luggage compartment

n **Effective range (areas within which the electronic key is detected)**

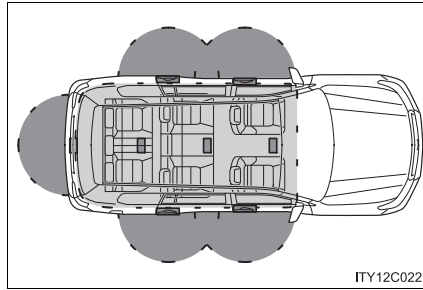

- When locking or unlocking the doors

The system can be operated when the electronic key is within about 2.3 ft. (0.7 m) of an outside door handle.

- When starting the engine or changing “ENGINE START STOP” switch modes

The system can be operated when the electronic key is inside the vehicle.

1

Before driving

---

■ **Operation signals**

A buzzer sounds and the emergency flashers flash to indicate that the doors have been locked/unlocked. (Locked: Once; Unlocked: Twice)

■ **Door lock buzzer**

If a door is not fully closed, a buzzer sounds continuously if an attempt to lock the door is made. Fully close the door to stop the buzzer, and lock the vehicle once more.

■ **Conditions affecting operation**



The smart key system uses weak radio waves. In the following situations, the communication between the electronic key and the vehicle may be affected, preventing the smart key system and wireless remote control from operating properly. (Way of coping P. 481)

- l When the electronic key battery is depleted
- l Near a TV tower, electric power plant, gas station, radio station, large display, airport or other facility that generates strong radio waves or electrical noise
- l When carrying a portable radio, cellular phone, cordless phone or other wireless communication devices
- l When the electronic key has come into contact with, or is covered by a metallic object
- l When multiple electronic keys are in the vicinity
- l When carrying or using the electronic key together with the following devices that emit radio waves
  - Another vehicle's electronic key
  - A wireless key that emits radio waves
  - Personal computer
- l If window tint with a metallic content or metallic objects are attached to the rear window



**n Switching the door unlock function**

If it is possible to set which doors the entry function unlocks.

**STEP 1** Turn the “ENGINE START STOP” switch OFF.

**STEP 2** When the indicator on the key surface is turned off, press and hold  , or  for approximately 5 seconds while pressing  on the key.

The setting changes each time an operation is performed, as shown below. (When changing the setting continuously, release the buttons, wait for at least 5 seconds, and repeat step 2.)

Multi-information display	Unlocking function	Beep
	Hold the driver's door handle to unlock only the driver's door.	Exterior: Beeps three times Interior: Pings once
	Hold either door handle to unlock all doors.	Exterior: Beeps twice Interior: Pings once

1  
Before driving

**n Battery-saving function**

In the following circumstances, the entry function is disabled in order to prevent the vehicle and electronic key batteries from discharging.

- l When the entry function has not been used for 2 weeks or more
- l When the electronic key has been left within approximately 3 ft. (1 m) of the vehicle for 10 minutes or more

The system will resume operation when...

- l The vehicle is locked using the door handle lock switch.
- l The vehicle is locked/unlocked using the wireless remote control function ( P. 40) or the mechanical key. ( P. 481)

**n Electronic key battery depletion**

- l The standard battery life is 1 to 2 years. (The battery becomes depleted even if the electronic key is not used.) If the smart key system or the wireless remote control function does not operate, or the detection area becomes smaller, the battery may be depleted. Replace the battery when necessary. ( P. 410)

- l To avoid serious deterioration, do not leave the electronic key within 3 ft. (1 m) of the following electrical appliances that produce a magnetic field.

- TVs
- Personal computers
- Recharging cellular phones or cordless phones
- Table lamps

**n To operate the system properly**

Make sure to carry the electronic key when operating the system. Do not get the electronic key too close to the vehicle when operating the system from the outside of the vehicle.

Depending on the position and holding condition of the electronic key, the key may not be detected correctly and the system may not operate properly. (The alarm may go off accidentally, or the door lock prevention may not function.)

**n Note for the smart key system**

- l Even when the electronic key is within the effective range (detection areas), the system may not operate properly in the following cases.
  - The electronic key is too close to the window or outside door handle, near the ground, or in a high place when the doors are locked or unlocked.
  - The electronic key is near the ground or in a high place, or too close to the rear bumper center when the back door is locked or unlocked.
  - The electronic key is on the instrument panel, floor or in the glove box when the engine is started or “ENGINE START STOP” switch modes are changed.
- l As long as the electronic key is within the effective range, the doors may be locked or unlocked by anyone.
- l Even if the electronic key is not inside the vehicle, it may be possible to start the engine if the electronic key is near the window.
- l The doors may unlock if a large amount of water splashes on the door handle, such as in the rain or in a car wash. (The doors will automatically be locked after approximately 60 seconds if the doors are not opened and closed.)
- l Gripping the door handle when wearing a glove may not unlock the door.
- l If the wireless remote control is used to lock the doors when the electronic key is near the vehicle, there is a possibility that the door may not be unlocked by the smart key system. (Use the wireless remote control to unlock the doors.)
- l A sudden approach to the effective range or door handle operation may prevent the doors from being unlocked. In this case, return the door handle to the original position and check that the doors unlock before pulling the door handle.

**n When the vehicle is not driven for extended periods**

To prevent theft of the vehicle, do not leave the electronic key within 6 ft. (2 m) of the vehicle.

**n Security feature**

If a door is not opened within approximately 60 seconds after the vehicle is unlocked, the security feature automatically locks the vehicle again.



**n Alarms and warning indicators**

A combination of exterior and interior alarms as well as warnings displayed on the multi-information display are used to prevent theft of the vehicle and unforeseeable accidents resulting from erroneous operation. Perform the appropriate correction procedure described in the following table.

Alarm	Situation	Correction procedure
Exterior alarm sounds once for 2 seconds	An attempt was made to lock the doors using the entry function while the electronic key was still inside the passenger compartment	Retrieve the electronic key from the passenger compartment and lock the doors again
Exterior alarm sounds once for 60 seconds	An attempt was made to exit the vehicle and lock the doors without first turning the "ENGINE START STOP" switch OFF	Turn the "ENGINE START STOP" switch OFF and lock the doors again
Exterior alarm sounds once for 10 seconds	An attempt was made to lock the vehicle while a door is open	Close all of the doors and lock the doors again
Interior alarm pings continuously*1	The "ENGINE START STOP" switch was turned to ACCESSORY mode while the driver's door was open (or the driver's door was opened while the "ENGINE START STOP" switch was in ACCESSORY mode)	Turn the "ENGINE START STOP" switch OFF and close the driver's door
	The "ENGINE START STOP" switch was turned OFF while the driver's door was open	Close the driver's door

Alarm	Situation	Correction procedure
Interior alarm sounds continuously*1	When the "ENGINE START STOP" switch is in IGNITION ON or ACCESSORY mode, an attempt was made to open the door and exit the vehicle, and the shift lever was not in "P"	Shift the shift lever to "P" and turn the "ENGINE START STOP" switch OFF
Interior and exterior alarms sound continuously*1	When the "ENGINE START STOP" switch is in IGNITION ON or ACCESSORY mode, the driver's door was closed after the key was carried outside the vehicle, and the shift lever not in "P"	Shift the shift lever to "P", turn the "ENGINE START STOP" switch OFF and close the driver's door again
Interior alarm pings once*1	The electronic key has a low battery	Replace the electronic key battery
	An attempt was made to start the engine without the electronic key being present, or the electronic key was not functioning normally	Start the engine with the electronic key present*2

1-2. Opening, closing and locking the doors

Alarm	Situation	Correction procedure
Interior alarm pings once and exterior alarm sounds 3 times*1	The driver's door was closed after the key was carried outside the vehicle, and the "ENGINE START STOP" switch was not turned OFF	Turn the "ENGINE START STOP" switch OFF and close the driver's door again
	An occupant carried the electronic key outside the vehicle and closed the door while the "ENGINE START STOP" switch was not OFF	Bring the electronic key back into the vehicle

\*1: A message will be shown on the multi-information display in the instrument cluster.

\*2: If the engine does not start when the electronic key is inside the vehicle, the electronic key battery may be depleted or there may be difficulties receiving signal from the key. ( P. 481)

n **If the smart key system does not operate properly**

l Locking and unlocking the doors: Use the mechanical key. ( P. 481)

l Starting the engine: P. 150

n

P. 410

n **Customization that can be configured at Toyota dealer**

Settings (e.g. smart key system) can be changed. (Customizable features P. 519)

n **Certification for the smart key system**

FCC ID:NI4TMLF-5

**NOTE:**

This device complies with Part 15 of the FCC Rules. Operation is subject to the following two conditions: (1) this device may not cause harmful interference, and (2) this device must accept any interference received, including interference that may cause undesired operation.

**FCC WARNING:**

Changes or modifications not expressly approved by the party responsible for compliance could void the user's authority to operate the equipment.

1-2. Opening, closing and locking the doors

**TCB**

**GRANT OF EQUIPMENT  
AUTHORIZATION**

**TCB**

**Certification  
Issued Under the Authority of the  
Federal Communications Commission  
By:**

**PHOENIX TESTLAB GmbH  
Koenigswinkel 10  
D-32825 Blomberg,  
Germany**

**Date of Grant: 10/05/2006  
Application Dated: 10/05/2006**

**Toyota Motor Corporation  
1, Toyota-Cho  
Toyota Aichi, 471-71  
Japan**

**Attention: Kazunori Sakai , General Manager**

**NOT TRANSFERABLE**

**EQUIPMENT AUTHORIZATION is hereby issued to the named GRANTEE,  
and is VALID ONLY for the equipment identified hereon for use under the  
Commission's Rules and Regulations listed below.**

**FCC IDENTIFIER: NI4TMLF-5  
Name of Grantee: Toyota Motor Corporation  
Equipment Class: Part 15 Low Power Transmitter Below 1705 kHz  
Notes: Smart LF Oscillator**

<b>Grant Notes</b>	<b>FCC Rule Parts</b>	<b>Frequency Range (MHZ)</b>	<b>Output Watts</b>	<b>Frequency Tolerance</b>	<b>Emission Designator</b>
	15C	0.1342 - 0.1342			

 CAUTION

**n Caution regarding interference with electronic devices**

**I** People with implanted pacemakers or cardiac defibrillators should keep away from the smart key system antennas. ( P. 28)  
The radio waves may affect the operation of such devices. If necessary, the smart key system can be disabled. Ask your Toyota dealer for details, such as the frequency of radio waves and timing of emitting the radio waves. Then, consult your doctor to see if you should disable the smart key system.

**I** Users of any electrical medical device other than implanted pacemakers and implanted cardiac defibrillators should consult the manufacturer of the device for information about its operation under the influence of radio waves. Radio waves could have unexpected effects on the operation of such medical devices.

Ask your Toyota dealer for details for disabling the smart key system.

## 1-2. Opening, closing and locking the doors

### Wireless remote control

The wireless remote control can be used to lock and unlock the vehicle.

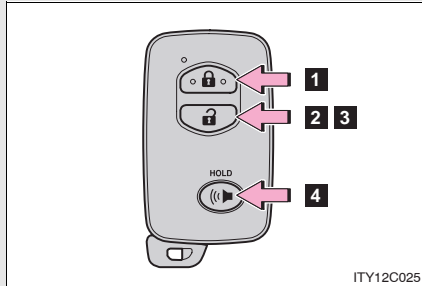

- 1** Locks all doors
- 2** Unlocks all doors
- 3** Opens the windows and moon roof (press and hold)
- 4** Sounds alarm (press and hold) ( P. 97 )

■ **2-step unlocking function**

When you press the  button, the driver's door is unlocked. Pressing the button again within 3 seconds unlocks the other doors.

■ **Operation signals**

Doors: A buzzer sounds and the emergency flashers flash to indicate that the doors have been locked/unlocked. (Locked: Once; Unlocked: Twice)

Windows and moon roof: A buzzer sounds when the windows and moon roof begin to open.

■

P. 30

■

P. 33

■ **Alarm**

Using the wireless remote control to lock the door will set the alarm system. ( P. 97)

■

P. 481

■ **If the wireless remote control does not operate properly**

┆ Locking and unlocking the doors: Use the mechanical key. ( P. 481)

┆ Starting the engine: ( P. 149)

■

P. 410

■

P. 30

■ **Customization that can be configured at Toyota dealer**

Settings (e.g. 2-step unlocking function) can be changed. (Customizable features P. 519)



**n Certification for wireless remote control**

FCC ID:HYQ14AAB FCC ID:HYQ13BZS
------------------------------------

**NOTE:**

This device complies with Part 15 of the FCC Rules. Operation is subject to the following two conditions: (1) this device may not cause harmful interference, and (2) this device must accept any interference received, including interference that may cause undesired operation.

**NOTICE:**

This equipment has been tested and found to comply with the limits for a Class B digital device, pursuant to Part 15 of the FCC Rules. These limits are designed to provide reasonable protection against harmful interference in a residential installation. This equipment generates, uses and can radiate radio frequency energy and, if not installed and used in accordance with the instructions, may cause harmful interference to radio communications. However, there is no guarantee that interference will not occur in a particular installation. If this equipment does cause harmful interference to radio or television reception, which can be determined by turning the equipment off and on, the user is encouraged to try to correct the interference by one or more of the following measures:

- 1 Reorient or relocate the receiving antenna.
- 1 Increase the separation between the equipment and receiver.
- 1 Connect the equipment into an outlet on a circuit different from that to which the receiver is connected.
- 1 Consult the dealer or an experienced radio/TV technician for help.

**FCC WARNING:**

Changes or modifications not expressly approved by the party responsible for compliance could void the user's authority to operate the equipment.

## 1-2. Opening, closing and locking the doors Side doors

The vehicle can be locked and unlocked using the smart key system, wireless remote control or door lock switch.

n

P. 26

n

P. 40

n **Door lock switch**

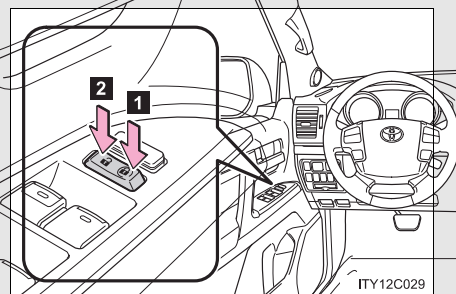

- 1** Locks all doors
- 2** Unlocks all doors

n **Inside lock button**

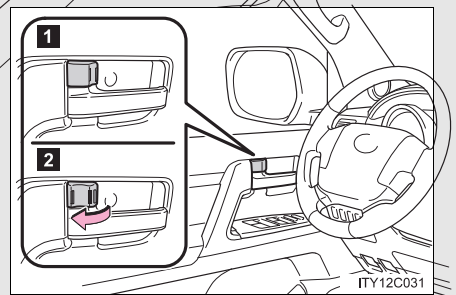

- 1** Locks the door
- 2** Unlocks the door

The front doors can be opened by pulling the inside handles even if the lock buttons are in the lock position.

1

Before driving

### Locking the driver's doors from the outside without a key

**STEP 1** Move the inside lock button to the lock position.

**STEP 2** Close the door.

The door cannot be locked if the "ENGINE START STOP" switch is in ACCESSORY or IGNITION ON mode, or the electronic key is left inside the vehicle.

The key may not be detected correctly and the door may be locked.

### Rear door child-protector lock

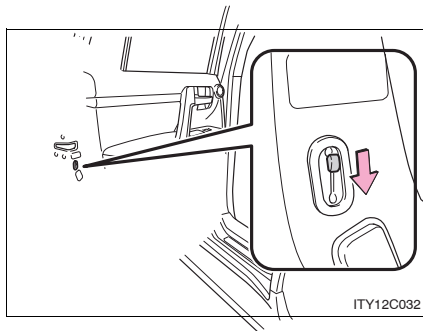

The door cannot be opened from inside the vehicle when the locks are set.

These locks can be set to prevent children from opening the rear doors. Press down rear door switches to lock the rear doors.

**Automatic door locking and unlocking systems**

The following functions can be set or canceled:

Function	Operation
Shift position linked door locking function	Shifting the shift lever out of "P" locks all doors.
Shift position linked door unlocking function	Shifting the shift lever to "P" unlocks all doors.
Speed linked door locking function	All doors are locked when the vehicle speed is approximately 12 mph (20 km/h) or higher.
Driver's door linked door unlocking function	All doors are unlocked when the driver's door is opened within 10 seconds after turning the "ENGINE START STOP" switch OFF.

1  
Before driving

**n Setting and canceling the functions**

To switch between setting and canceling, follow the procedure below:

**STEP 1** Close all the doors and switch the "ENGINE START STOP" switch IGNITION ON mode. (Perform step 2 within 20 seconds.)

**STEP 2** Shift the shift lever to "P" or "N", press and hold the driver's door lock switch ( **1** or **2** ) for 5 seconds then release.

The shift lever and switch positions corresponding to the desired function to be set or canceled are shown as follows.

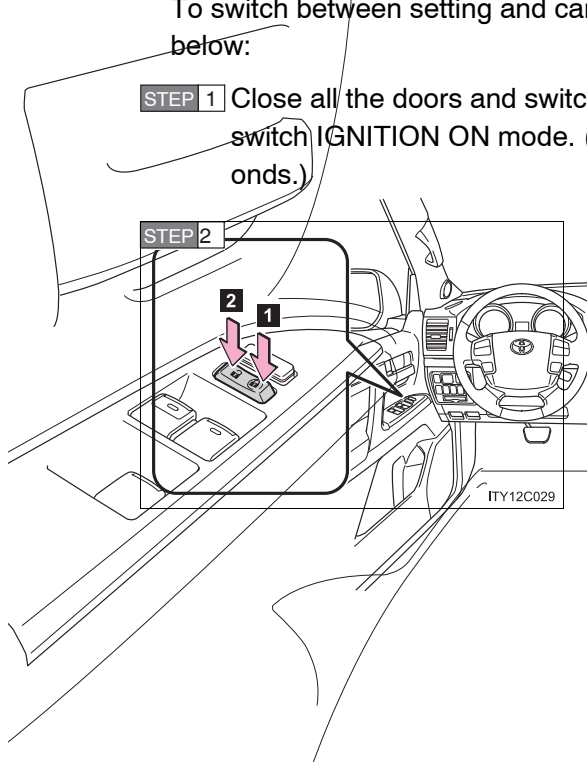

## 1-2. Opening, closing and locking the doors

Function	Shift lever position	Switch position
Shift position linked door locking function	"P"	1
Shift position linked door unlocking function		2
Speed linked door locking function	"N"	1
Driver's door linked door unlocking function		2

When the setting or canceling operation is complete, all doors are locked and then unlocked.

---

### n **Impact detection door lock release system**

In the event that the vehicle is subject to a strong impact, all the doors are unlocked.

Depending on the force of the impact or the type of accident, however, the system may not operate.

### n **Using the mechanical key**

The doors can also be locked and unlocked with the mechanical key.  
( P. 481)

### n **Customization that can be configured at Toyota dealer**

Settings (e.g. unlocking function using a key) can be changed. (Customizable features P. 519)

 CAUTION

**n To prevent an accident**

Observe the following precautions while driving the vehicle.  
Failing to do so may result in a door opening and an occupant falling out,  
resulting in death or serious injury.

- I Always use a seat belt.
- I Always lock all doors.
- I Ensure that all doors are properly closed.
- I Do not pull the inside handle of the front door while driving.
- I Set the rear door child protector locks when children are seated in the rear seat.

1

Before driving

1-2. Opening, closing and locking the doors  
Back door

The back door can be opened using the back door opener

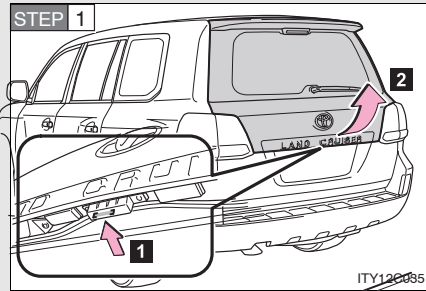

- 1 Unlock the back door
- 2 Raise the back door

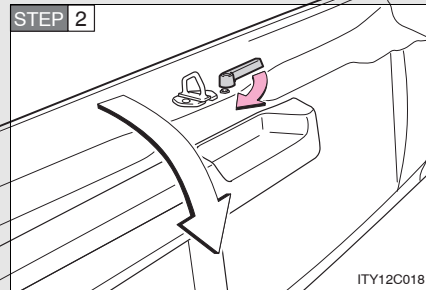

Pull the handle

The back door can be locked and unlocked using the entry function, wireless remote control or door lock switch.

n

P. 26

n

P. 40

n

P. 43

### Rear step bumper

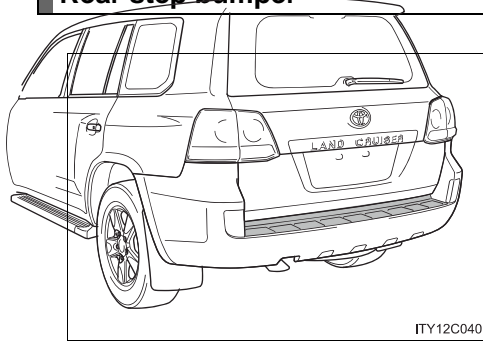

The rear step bumper is for rear end protection and easier step-up loading.

1  
Before driving

#### ■ When closing the back door

- 1 Make sure that the lower side of the back door is closed before closing the upper side of the back door.

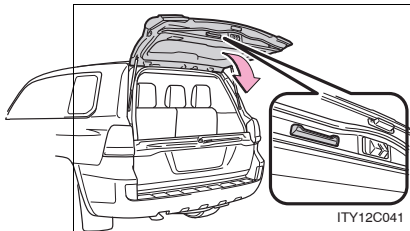

- 1 Lower the back door using the back door handle, and make sure to push the back door down from the outside to close it.

■

P. 480



 **CAUTION**

**n While driving**

Observe the following precautions.

Failing to do so may result in death or serious injury.

**I** Keep the back door closed.

This not only keeps personal belongings from being thrown out, but also prevents exhaust gases from entering the vehicle.

**I** Do not get on the rear step bumper.

 **NOTICE**

**n To prevent damage to the back door components**

**I** Do not apply force to the back door dampers and keep the dampers free of paint and other foreign matter.

**I** Make sure there is nothing in the doorway before closing.

**I** Do not allow more than one person to get on the rear step bumper at a time.

1–3. Adjustable components (seats, mirrors, steering wheel)

Front seats

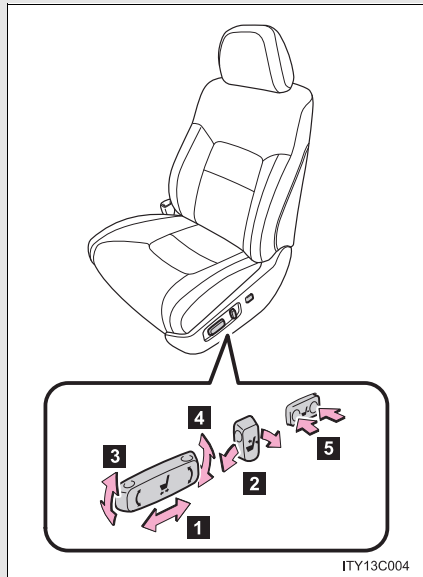

- 1 Seat position fore/aft control switch
- 2 Seatback angle control switch
- 3 Seat cushion (front) angle control switch
- 4 Vertical height control switch
- 5 Lumbar support control switch (driver's side only)

1  
Before driving

**Active head restraint**

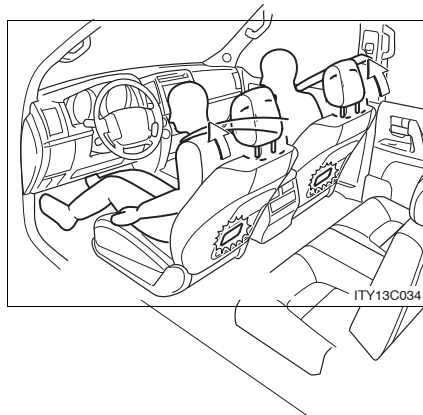

When a front seatback receives a strong impact, the head restraint moves slightly forward and upward to help reduce the risk of whiplash on the seat occupant.

### 1–3. Adjustable components (seats, mirrors, steering wheel)

---

#### n **Active head restraint**

Even small forces applied to the seatback may cause the head restraint to move. This does not indicate a problem.

#### **CAUTION**

#### n **Seat adjustment**

- I Be careful that the seat does not hit passengers or luggage.
- I Do not recline the seat more than necessary when the vehicle is in motion to reduce the risk of sliding under the lap belt.  
If the seat is too reclined, during an accident the lap belt may slide past the hips and apply restraint forces directly to the abdomen or your neck may contact the shoulder belt, increasing the risk of death or serious injury.

1–3. Adjustable components (seats, mirrors, steering wheel)

Rear seats

► Second seat

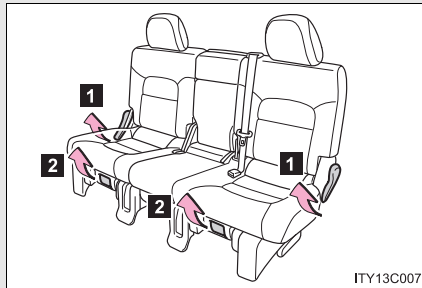

- 1 Seatback angle adjustment lever
- 2 Seat position adjustment lever

► Third seat

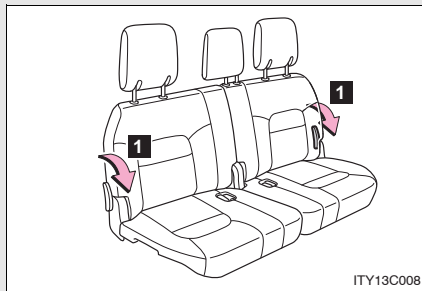

1-3. Adjustable components (seats, mirrors, steering wheel)

### Tumbling the second seats and third seat entry

For easy access to the third seat, perform **STEP 1** in “Tumbling second seats”. ( P. 55)

#### n Before tumbling second seats

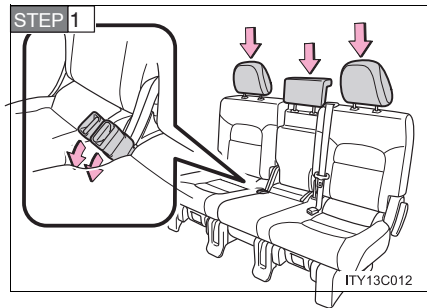

Stow the seat belt buckles and lower the head restraints to the lowest position.

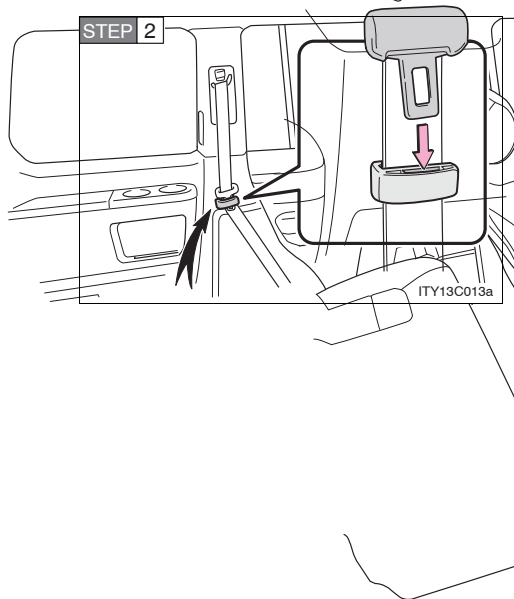

Pass the outer seat belts through the seat belt hangers and secure the seat belt plates.

This prevents the shoulder belt from being damage.

Make sure that the seat belts are removed from the hangers before using them.

### n Tumbling second seats

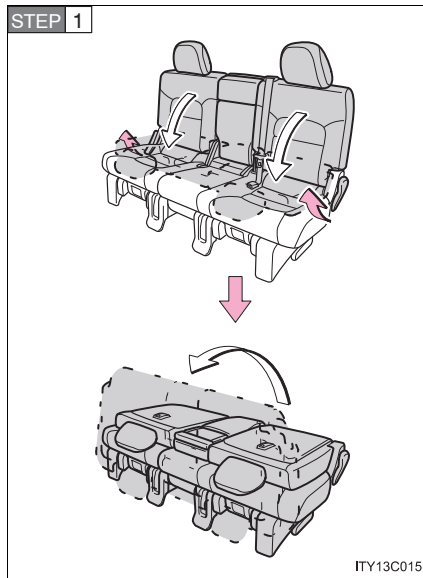

Fold down the seatback while pulling the seatback angle adjustment lever, and swing the whole seat up and forward.

1  
Before driving

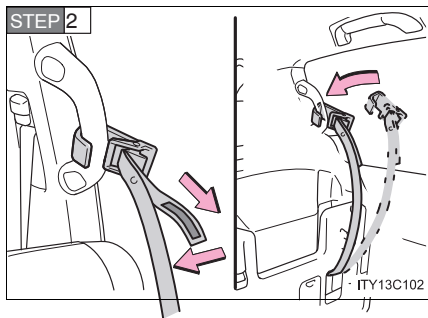

Hook the holding strap to the assist grip and secure the seat by pulling its free end.

When returning the second seat to its original position, stow the holding strap.

1-3. Adjustable components (seats, mirrors, steering wheel)

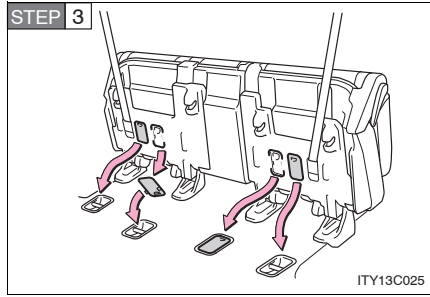

Remove the seat hook covers from the back of the seat cushion, and install them on the seat hooks.

When returning the second seat to its original position, remove the seat hook covers from the floor and install them in the back of the seat cushion.

▮ If you cannot raise the left side seatback

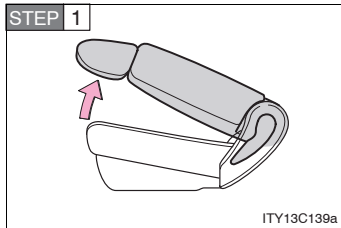

Lift the seatback until it stops.

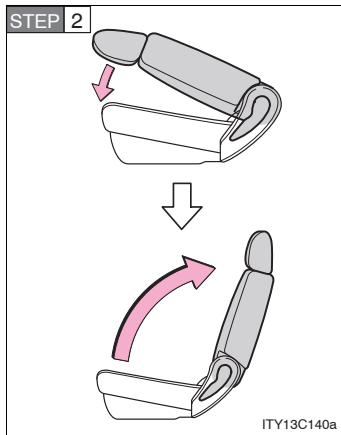

Lower the seatback a little then lift it again.

## Tumbling the third seats

### n Before tumbling third seats

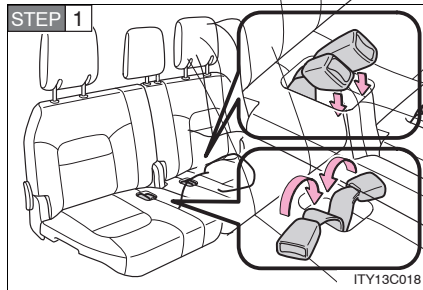

Stow the seat belts buckles.

**STEP 2** Stow the center head restraint in the seat back. ( P. 68 )

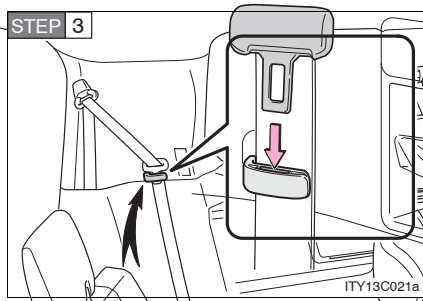

Pass the outer seat belts through the seat belt hangers and secure the seat belt plates.

This prevents the shoulder belt from being damage.

Make sure that the seat belts are removed from the hangers before using them.

**STEP 4** Stow the center seat belt tabs in the cover set in the roof. ( P. 71 )



1-3. Adjustable components (seats, mirrors, steering wheel)

n **Folding up the third seats**

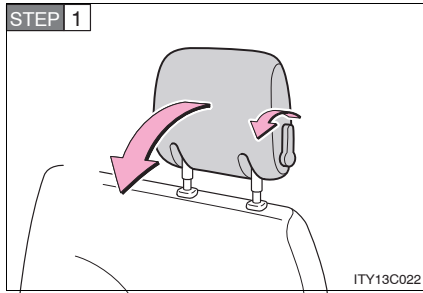

Fold down the head restraints while pulling the head restraint angle lever.

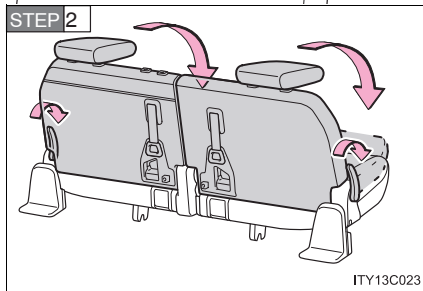

Push the seatback angle levers and fold the third seats.

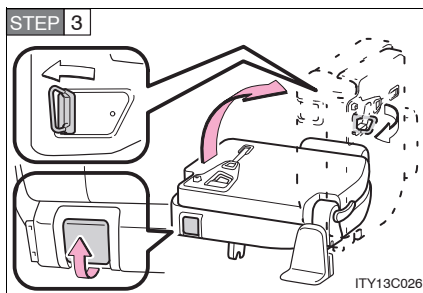

Lift the seats sideward while pulling the seat leg lock release levers.

The seat back striker will also automatically sit up.

1-3. Adjustable components (seats, mirrors, steering wheel)

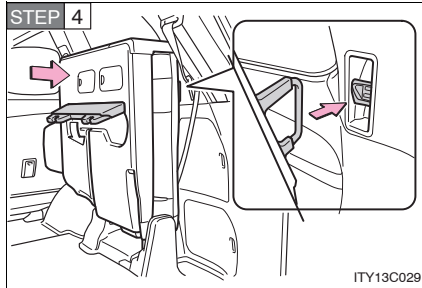

Secure the seats by the strikers.

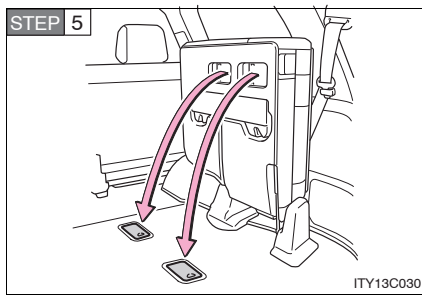

Remove the seat hook covers from the back of the seat cushion, and install them on the seat hooks.

n **Returning the third seats**

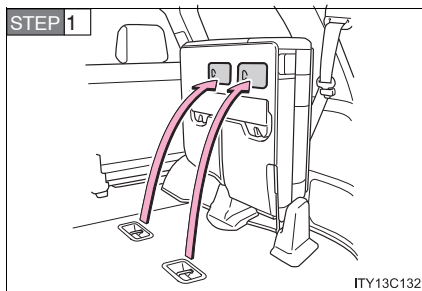

Remove the seat hook covers from the floor and install them into the back of the seat cushion.

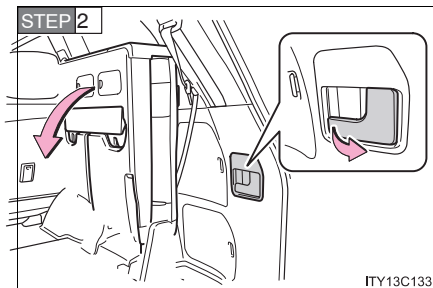

Unlock the seats by pulling the stowed seat lock release levers and lower the seats to its original position.

1-3. Adjustable components (seats, mirrors, steering wheel)

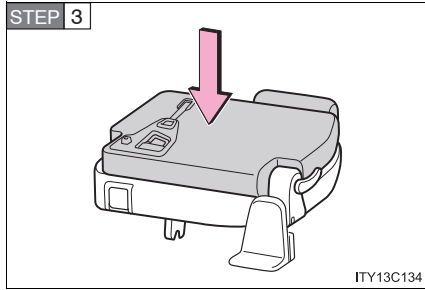

Secure the seats by the strikers.

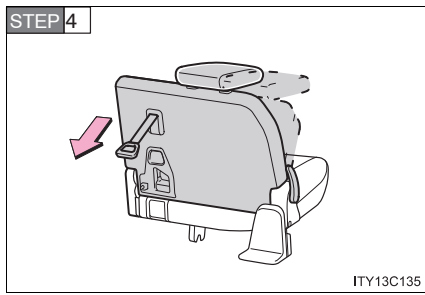

Pull the handle and raise the seatbacks.

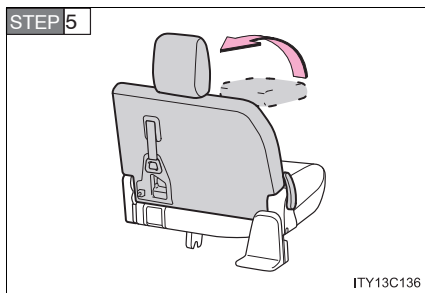

Raise the head restraints.

 CAUTION

**n Seat adjustment**

Do not recline the seat more than necessary when the vehicle is in motion, to reduce the risk of sliding under the lap belt.

If the seat is too reclined, during an accident the lap belt may slide past the hips and apply restraint forces directly to the abdomen or your neck may contact the shoulder belt, increasing the risk of death or serious injury.

**n When the seatback is folded**

**I** Do not sit on or place anything on the seatback while driving.

**I** Be sure to install the seat hook covers on the seat hooks, or you may get burned when they become hot.

**n When returning the seatbacks to their original position**

Observe the following precautions. Failure to do so may result in death or serious injury.

**I** Be careful not to get your hands or feet pinched in the seat.

**I** Make sure the seats are securely locked. Failure to do so will prevent the seat belt from operating properly.

**I** Check that the seat belts are not twisted or caught under the seat.

**I** Arrange the seat belts in the proper positions for ready use.

**n Avoiding damage to seat components**

Do not hang or attach anything on the seat back striker.

1

Before driving

 NOTICE

**n Before tumbling, folding up the seats**

The seat belts and buckles must be stowed.

## Driving position memory system

Your preferred driving position (the position of the driver’s seat, steering wheel and outside rear view mirrors) can be entered into the computer’s memory and recalled with the touch of a button. It is also possible to set this function to activate automatically when the doors are unlocked.

Three different driving positions can be entered into memory.

### n Entering a position to memory

Check that the shift lever is set in “P”.

**STEP 1** Switch to IGNITION ON mode.

**STEP 2** Adjust the driver’s seat, steering wheel, and outside rear view mirrors to the desired positions.

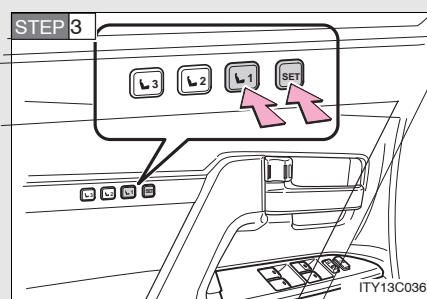

While pressing the “SET” button, press button “1”, “2” or “3” until the signal beeps.

If the selected button has already been preset, the previously recorded position will be overwritten.

### n Recalling the memorized position

Check that the shift lever is set in “P”.

**STEP 1** Switch to IGNITION ON mode.

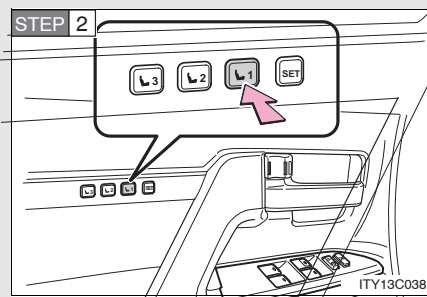

Press button “1”, “2” or “3” to recall the desired position.

### Linking driving position memory with door unlock operation

Record your driving position to button “1”, “2” or “3” before performing the following:

► Using the wireless remote control

**STEP 1** Turn the “ENGINE START STOP” switch to OFF and close the driver’s door.

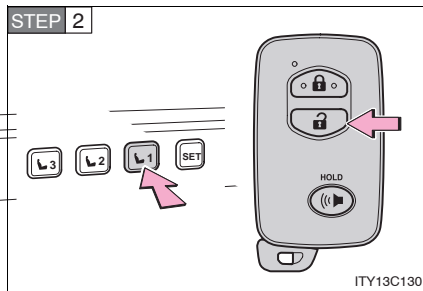

While pressing the desired button (“1”, “2” or “3”), press  on the wireless remote control until the signal beeps.

The driving position is recalled when the driver’s door is unlocked using the entry function or wireless remote control and the driver’s door is opened.

1  
Before driving

### Canceling the linked door unlock operation

**STEP 1** Turn the “ENGINE START STOP” switch to OFF and close the driver’s door.

**STEP 2** Using the wireless remote control: While pressing “SET” button, press  button on the wireless remote control until the signal beeps.

### 1–3. Adjustable components (seats, mirrors, steering wheel)

#### n **Retained accessory power**

Each memorized position (except for the steering wheel position) can be activated within 30 seconds after the driver's door is opened, even if the "ENGINE START STOP" switch turns off.

#### n **To cancel seat position recall**

Perform any one of the following operations.

- l Press the "SET" button
- l Press button "1", "2" or "3".
- l Adjust the seat using the switches (only cancels seat position recall)

#### n **If the battery is disconnected**

The memorized positions must be reset because the computer's memory is erased when the battery is disconnected.

#### **CAUTION**

#### n **Seat adjustment caution**

Take care during seat adjustment that the seat does not strike the rear passenger or squeeze your body against the steering wheel.

1-3. Adjustable components (seats, mirrors, steering wheel)  
Head restraints

► Front seats, second seats

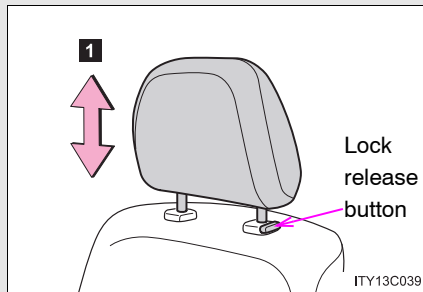

**1** Vertical adjustment

Press and hold the lock release button when lowering the head restraint.

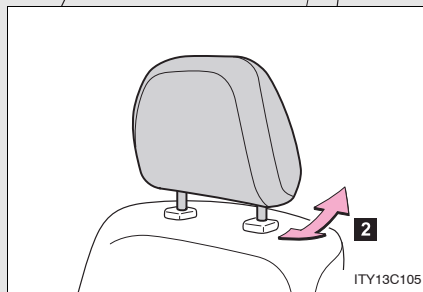

**2** Angle adjustment (front seats only)

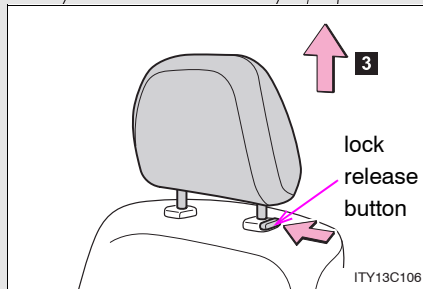

**3** Removal

Pull the head restraint up while pressing the lock release button.

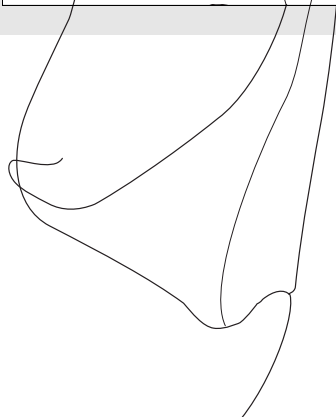



1-3. Adjustable components (seats, mirrors, steering wheel)

► Third outboard seats

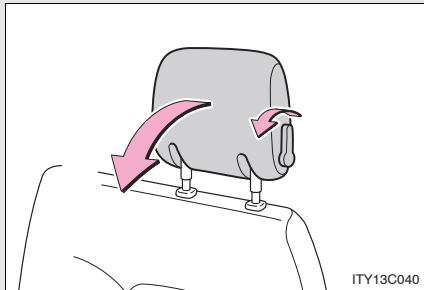

To fold

Pull the head restraint angle lever to fold the head restraint.

► Third center seat

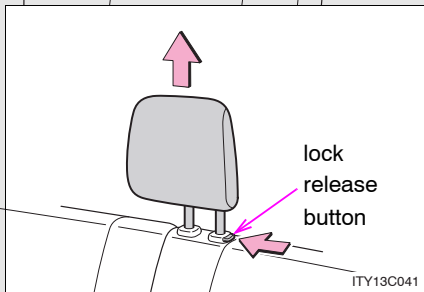

Removal

Pull the head restraint up while pressing the lock release button.

**n Adjusting the height of the head restraints**

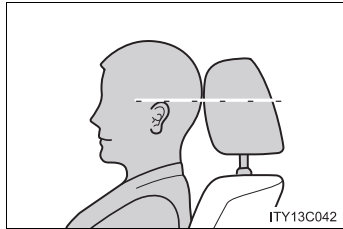

Make sure that the head restraints are adjusted so that the center of the head restraint is closest to the top of your ears.

1

Before driving

**n Adjusting the second center seat head restraint**

Always raise the head restraint one level from the stowed position when using.

**n Removing the third outboard seat head restraints**

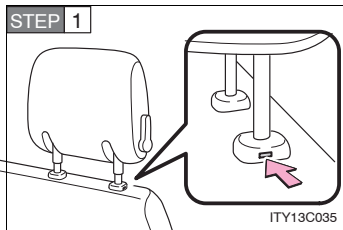

Push a flathead screwdriver into the slot. The slot is located on the left side of the left head restraint anchor.

**STEP 2** While pressing in the screwdriver, pull up the head restraint.

1–3. Adjustable components (seats, mirrors, steering wheel)

n **Installing the third outboard seat head restraints**

**STEP 1** Align the head restraint with the installation holes.

**STEP 2** Push down the head restraint to the lock position.

n **When not using the third center seat head restraint**

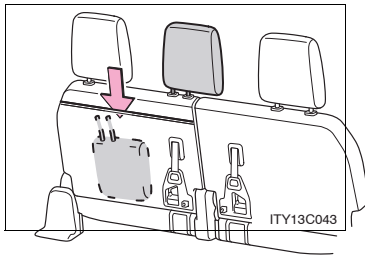

Open the zipper on the back of the third seat and stow the head restraint inside.

**⚠ CAUTION**

n **Head restraint precautions**

Observe the following precautions regarding the head restraints. Failure to do so may result in death or serious injury.

- l Use the head restraints designed for each respective seat.
- l Adjust the head restraints to the correct position at all times.
- l After adjusting the head restraints, push down on them and make sure they are locked in position.
- l Do not drive with the head restraints removed.

1–3. Adjustable components (seats, mirrors, steering wheel)

## Seat belts

**Make sure that all occupants are wearing their seat belts before driving the vehicle.**

### n Correct use of the seat belts

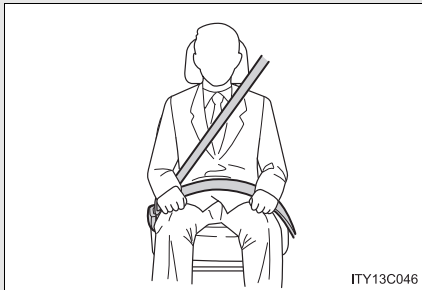

- 1 Extend the shoulder belt so that it comes fully over the shoulder, but does not come into contact with the neck or slide off the shoulder.
- 1 Position the lap belt as low as possible over the hips.
- 1 Adjust the position of the seatback. Sit up straight and well back in the seat.
- 1 Do not twist the seat belt.

### n Fastening and releasing the seat belt

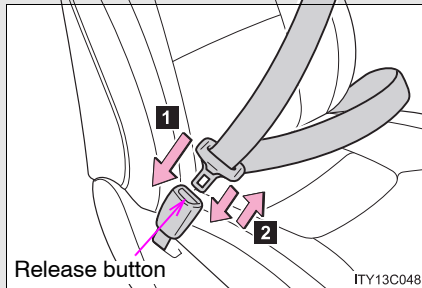

#### 1 Fastening the belt

Push the tab into the buckle until a clicking sound is heard.

#### 2 Releasing the belt

Press the release button.

n **Adjusting the height of the belt (front, second outboard seat)**

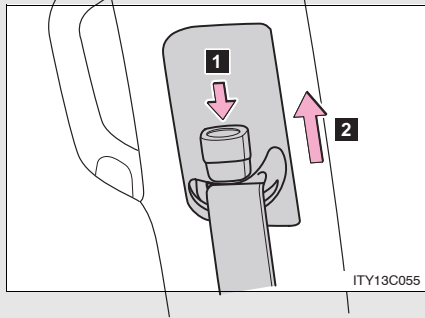

**1** Down

**2** Up

Move the height adjuster up and down as needed until you hear a click.

**Third center seat belt**

The third center seat belt is a 3-point type restraint with 2 buckles. Both seat belt buckles must be correctly located and securely latched for proper operation.

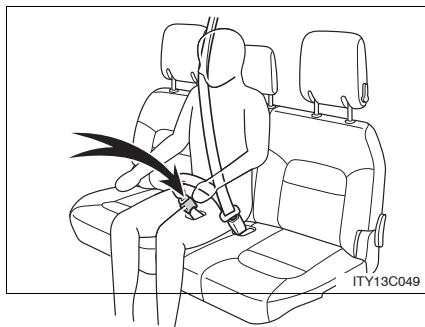

Make sure that the buckle with the gray buckle release button is securely latched for ready use of the center seat belt.

n **Release method**

The belt can be completely released when not required, such as when removing the third seat.

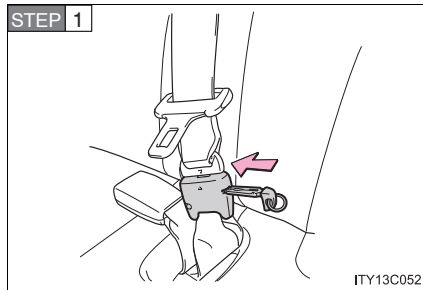

To release the hooked tab, insert the mechanical key into the hole on the buckle with the light gray buckle release button.

1  
Before driving

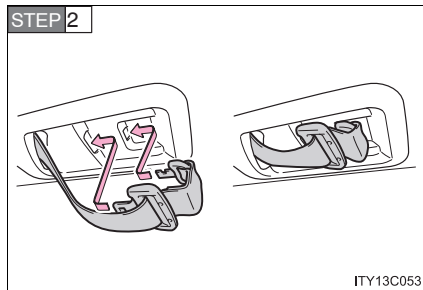

Stow the seat belt tabs in the cover set in the roof as shown.

n **Extracting the belt**

Pull the belt out partially, then remove the tabs from the cover.

1–3. Adjustable components (seats, mirrors, steering wheel)

### Seat belt pretensioners (front, second outboard seats)

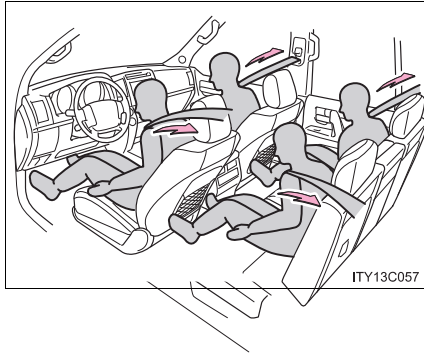

The pretensioner helps the seat belt to quickly restrain the occupant by retracting the seat belt when the vehicle is subjected to certain types of severe frontal collision.

The pretensioner may not activate in the event of a minor frontal impact, a side impact or a rear impact.

### Pre-collision seat belts (front seats of vehicles with pre-collision system)

When operating in the event of sudden braking, the seat belts lessen collision injury by retracting the slack in the front seat belts before the collision, thus restraining the driver and passenger at an earlier stage. ( P. 208)

#### n Emergency locking retractor (ELR)

The retractor will lock the belt during a sudden stop or on impact. It may also lock if you lean forward too quickly. A slow, easy motion will allow the belt to extend, and you can move around fully.

#### n Automatic locking retractor (ALR)

When a passenger's shoulder belt is completely extended and then retracted even slightly, the belt is locked in that position and cannot be extended. This feature is used to hold the child restraint system (CRS) firmly. To free the belt again, fully retract the belt and then pull the belt out once more. ( P. 127)

▫ **Pregnant women**

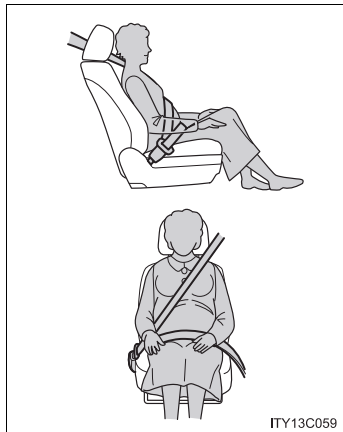

Obtain medical advice and wear the seat belt in the proper way. ( P. 69)

Women who are pregnant should position the lap belt as low as possible over the hips in the same manner as other occupants. Extend the shoulder belt completely over the shoulder and position the belt across the chest. Avoid belt contact over the rounding of the abdominal area.

If the seat belt is not worn properly, not only a pregnant woman, but also the fetus could suffer death or serious injury as a result of sudden braking or a collision.

1  
Before driving

▫ **People suffering illness**

Obtain medical advice and wear the seat belt in the proper way. ( P. 69)

▫ **Child seat belt usage**

The seat belts of your vehicle were principally designed for persons of adult size.

- I Use a child restraint system appropriately for the child, until the child become large enough to properly wear the vehicle's seat belt. ( P. 123)
- I When the child becomes large enough to properly wear the vehicle's seat belt, follow the instructions on P. 69 regarding seat belt usage.

▫ **Replacing the belt after the pretensioner has been activated**

The seat belts cannot be used if a pretensioner has activated. After an accident, have your Toyota dealer inspect the pretensioners and replace them, if necessary.



1–3. Adjustable components (seats, mirrors, steering wheel)

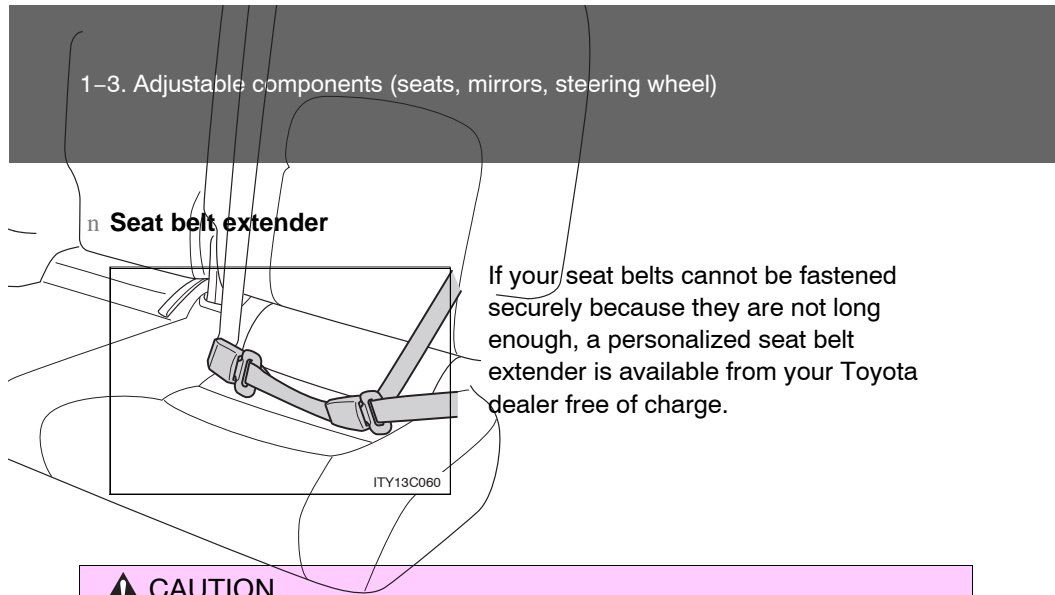

If your seat belts cannot be fastened securely because they are not long enough, a personalized seat belt extender is available from your Toyota dealer free of charge.

**⚠ CAUTION**

**n Wearing a seat belt**

Observe the following precautions to reduce the risk of injury in the event of sudden braking or an accident.

Failing to do so may cause death or serious injury.

- l Ensure that all passengers wear a seat belt.
- l Always wear a seat belt properly.
- l Each seat belt should be used by one person only. Do not use a seat belt for more than one person at the same time, including children.
- l Children should be seated in the rear seat and always use a seat belt and/or an appropriate child restraint system.
- l Do not recline the seat any more than necessary to achieve a proper seating position. The seat belt is most effective when the occupants are sitting up straight and well back in the seats.
- l Do not wear the shoulder belt under your arm.
- l Always wear your seat belt low and snug across your hips.

**n Seat belt pretensioners**

Do not place anything, such as a cushion, on the front passenger's seat. Doing so will disperse the passenger's weight, which prevents the sensor from detecting the passenger's weight properly. As a result, the seat belt pretensioner for the front passenger's seat may not activate in the event of a collision.

**⚠ CAUTION**

**n When using the third center seat belt**

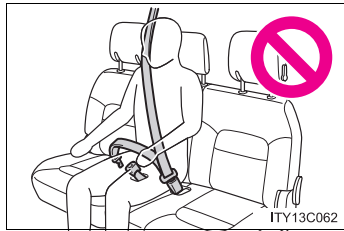

Do not use the third center seat belt with either buckle released. Fastening only one of the buckles may result in death or serious injury in case of sudden braking or a collision.

**n Seat belt damage and wear**

- I** Do not damage the seat belts by allowing the belt, plate or buckle to be jammed in the door.
- I** Inspect the seat belt system periodically. Check for cuts, fraying, and loose parts. Do not use a damaged seat belt until it is replaced. Damaged seat belts cannot protect an occupant from death or serious injury.
- I** Ensure that the belt and tab are locked and the belt is not twisted. If the seat belt does not function correctly, immediately contact your Toyota dealer.
- I** Replace the seat assembly, including the belts, if your vehicle has been involved in a serious accident, even if there is no obvious damage.
- I** Do not attempt to install, remove, modify, disassemble or dispose of a seat belt. Have any necessary repairs carried out by your Toyota dealer. Inappropriate handling of the pretensioner may cause it to activate or operate improperly and may cause death or serious injury.

 CAUTION

**n Using a seat belt extender**

- I** Do not wear the seat belt extender, if you can fasten the seat belt without the extender.
- I** Do not use the seat belt extender when installing a child restraint system, because the belt will not securely hold the child restraint system, increasing the risk of death or serious injury in the event of a collision.
- I** The personalized extender may not be safe on another vehicle, when used by another person, or at a different seating position other than the one originally intended.

**n Precaution for pre–collision seat belts**

Do not rely solely on the pre–collision system to avoid accidents. Always pay attention to the surrounding conditions, and drive safely and responsibly.

 NOTICE

**n When using a seat belt extender**

When releasing the seat belt, press on the buckle release button on the extender, not on the seat belt.  
This helps prevent damage to the vehicle interior and the extender itself.

1-3. Adjustable components (seats, mirrors, steering wheel)  
Steering wheel

The steering wheel can be adjusted to a comfortable position while the "ENGINE START STOP" switch is in ACCESSORY or IGNITION ON mode.

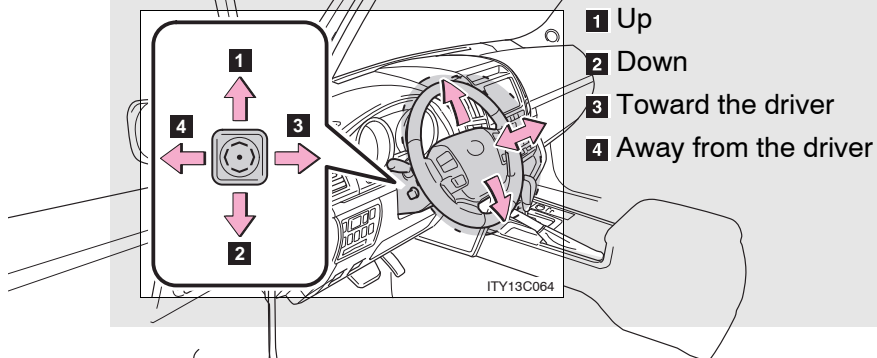

1  
Before driving

**Auto tilt away and auto return**

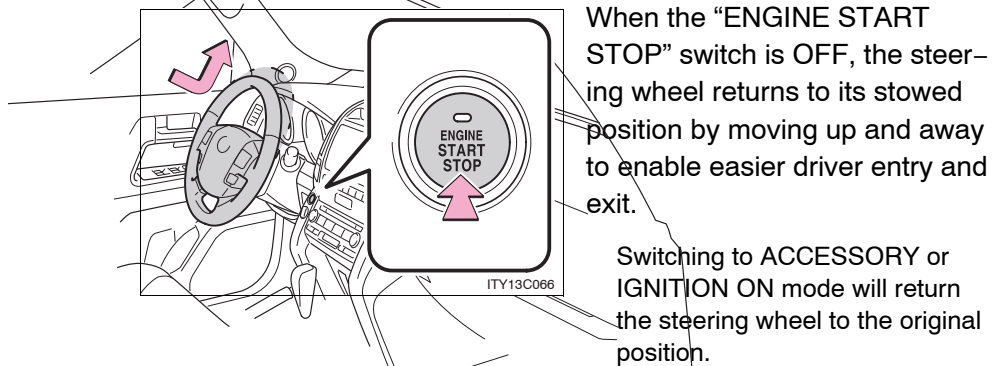

1-3. Adjustable components (seats, mirrors, steering wheel)

---

n **One-touch adjustment of the steering position**

A desired steering position can be entered to memory and recalled automatically by the driving position memory. ( P. 62 )

 **CAUTION**

n **While driving**

Do not adjust the steering wheel.  
Doing so may cause the driver to mishandle the vehicle and an accident, resulting in death or serious injury.

1-3. Adjustable components (seats, mirrors, steering wheel)  
Inside rear view mirror

In auto mode, sensors are used to detect the headlights of vehicles behind and automatically reduces the reflected light.

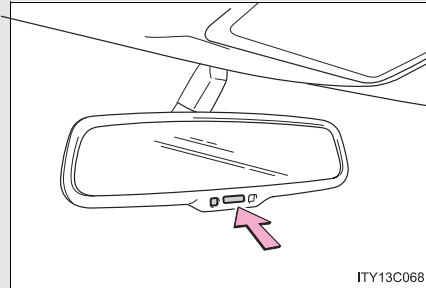

Turns auto mode on/off

The indicator comes on when auto mode is turned on.

The mirror will revert to the auto mode each time the "ENGINE START STOP" switch is turned to IGNITION ON mode.

1

Before driving

■ To prevent sensor error

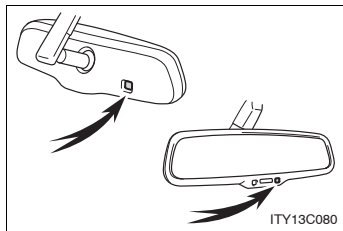

To ensure correct functioning of the sensors, do not touch or cover the sensors.

**⚠ CAUTION**

■ While driving

Do not adjust the position of the mirror.  
Doing so may lead to mishandling of the vehicle and an accident, or resulting in death or serious injury.

1-3. Adjustable components (seats, mirrors, steering wheel)

## Outside rear view mirrors

Mirror angle can be adjusted using the switch when the "ENGINE START STOP" switch is in ACCESSORY or IGNITION ON mode.

STEP 1

Select a mirror to adjust

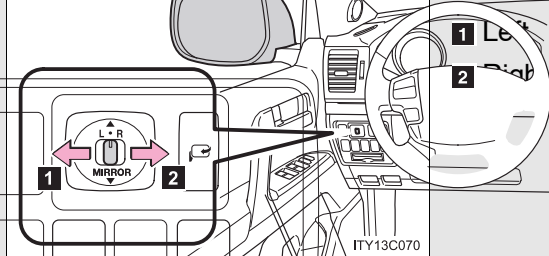

STEP 2

Adjust the mirror

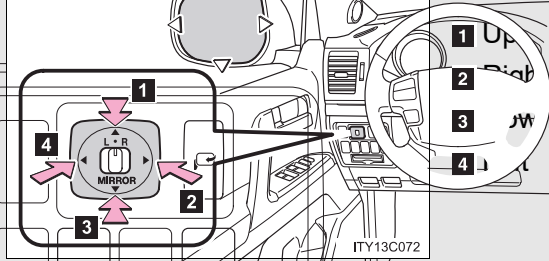

### Folding back the mirrors

Press the switch

Pressing again will extend the mirror.

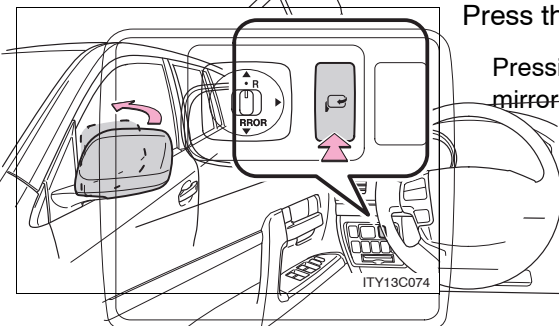

■ **When the mirrors are fogged up**

Turn on the outside rear view mirror defoggers to defog the mirrors.  
( P. 256)

■ **Auto anti-glare function**

When the anti-glare inside rear view mirror is set to auto mode, the outside rear view mirrors will activate in conjunction with the anti-glare inside rear view mirror to reduce reflected light. ( P. 79)

■ **Linked mirror function when reversing**

The outside rear view mirrors will automatically angle downwards when the vehicle is reversing in order to give a better view of the ground. However, this function will not operate when the mirror select switch is in the neutral position (between “L” and “R”).

■ **One-touch adjustment of the mirror angle**

A desired mirror face angle can be entered to memory and adjusted with the touch of a button. ( P. 62)

 **CAUTION**

■ **While driving**

Observe the following precautions.  
Failing to do so may result in losing control of the vehicle and cause an accident, resulting in death or serious injury.

- ! Do not adjust the mirrors.
- ! Do not drive with the mirrors folded back.
- ! Before driving, be sure to extend mirrors and make an adjustment properly.

■ **When the mirror defoggers are operating**

Do not touch the mirror surface as the mirror surface becomes hot.



1–3. Adjustable components (seats, mirrors, steering wheel)

 NOTICE

**n If ice should jam the mirror**

Do not operate the control or scrape the mirror face. Use a spray de-icer to free the mirror.

1-4. Opening and closing the windows and moon roof  
Power windows

The power windows can be opened and closed using the following switches.

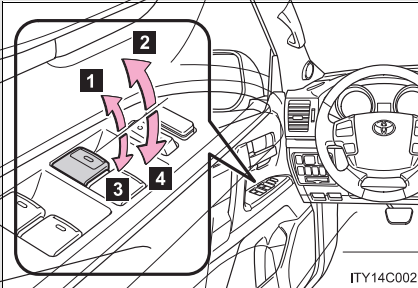

- 1 Closing
- 2 One-touch closing\*
- 3 Opening
- 4 One-touch opening\*

\*: Pressing the switch in the opposite direction will stop window travel partway.

1  
Before driving

**Lock switch**

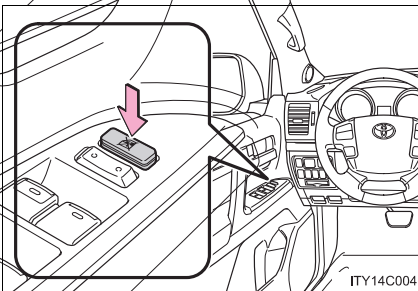

Press the switch down to lock passenger window switches.

Use this switch to prevent children from accidentally opening or closing a passenger window.

---

n **The power windows can be operated when**

The “ENGINE START STOP” switch is in IGNITION ON mode.

n **Linked door lock window operation**

l The power windows can be opened and closed using the mechanical key. ( P. 43)

l The power windows can be opened using the wireless remote control. ( P. 40)

l The power windows can be closed using the smart key system.

n **Operating the power windows after turning the “ENGINE START STOP” switch OFF**

The power windows can be operated for approximately 45 seconds even after the “ENGINE START STOP” switch is turned ACCESSORY mode or turned OFF. They cannot, however, be operated once the driver’s or front passenger’s door is opened.

n **Jam protection function**

If an object becomes caught between the window and the window frame, window travel is stopped and the window is opened slightly.

n **Customization that can be configured at Toyota dealer**

Settings (e.g. linked door lock operation) can be changed. (Customizable features P. 519)

 CAUTION

**n Closing the windows**

Observe the following precautions.

Failing to do so may result in death or serious injury.

- I** Check to make sure that all passengers do not have any part of their body in a position where it could be caught when a window is being operated.
- I** Do not allow children to operate the power windows.  
Closing a power window on someone can cause death or serious injury.

**n Jam protection function**

- I** Never try jamming any part of your body to activate the jam protection function intentionally.
- I** The jam protection function may not work if something gets caught just before the window fully closes.

## 1-4. Opening and closing the windows and moon roof

### Moon roof

Use the overhead switches to open, close, and tilt the moon roof up and down.

#### n Opening and closing

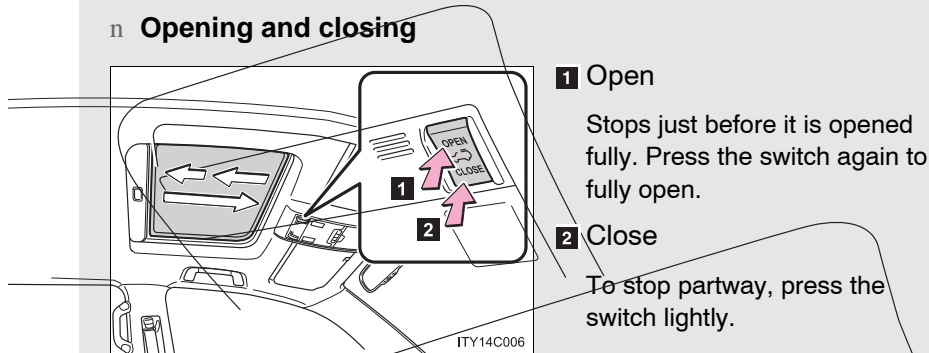

#### n Tilt up and down

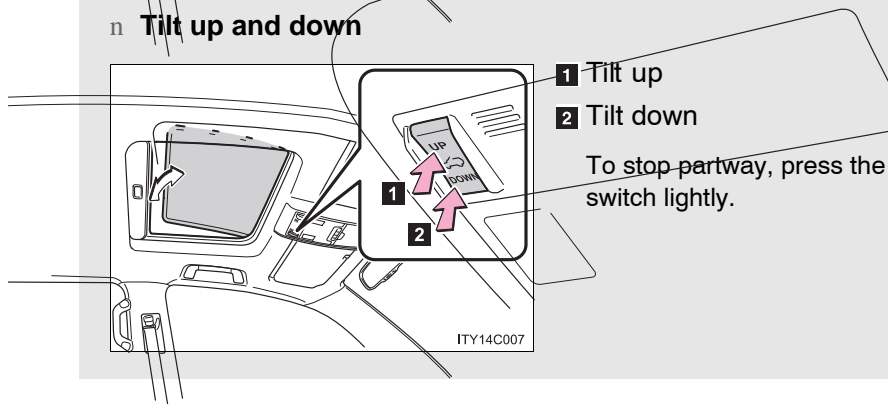

■ **The moon roof can be operated when**

The “ENGINE START STOP” switch is in IGNITION ON mode.

■ **Linked door lock moon roof operation**

- l The moon roof can be opened and closed using the mechanical key.  
( P. 43)
- l The moon roof can be opened using the wireless remote control.  
( P. 40)
- l The moon roof can be closed using the smart key system.

■ **Operating the moon roof after turning the “ENGINE START STOP” switch OFF**

The moon roof can be operated for approximately 45 seconds even after the “ENGINE START STOP” switch is turned to ACCESSORY mode or turned OFF. It cannot, however, be operated once the driver’s or front passenger’s door is opened.

■ **Jam protection function**

If an object is detected between the moon roof and the frame while closing or tilting down, travel is stopped and the moon roof opens slightly.

■ **If the moon roof cannot be closed automatically**

Keep the switch depressed.

■ **To reduce moon roof wind noise**

Drive with the moon roof opened automatically (just before fully opened position).

■ **Sunshade**

The sunshade can be opened and closed manually. However, the sunshade will open automatically when the moon roof is opened.

## 1-4. Opening and closing the windows and moon roof

### n **Moon roof open warning buzzer**

The buzzer sounds and message is shown on the multi-information display in the instrument panel when the “ENGINE START STOP” switch is turned OFF and the driver’s door is opened with the moon roof open.

### n **Customization that can be configured at Toyota dealer**

Settings (e.g. linked door lock operation) can be changed. (Customizable features P. 519)

## CAUTION

### n **Opening the moon roof**

Observe the following precautions.

Failing to do so may cause death or serious injury.

- ! Do not allow any passengers to put their hands or heads outside the vehicle while it is moving.
- ! Do not sit on top of the moon roof.

### n **Closing the moon roof**

Observe the following precautions.

Failing to do so may result in death or serious injury.

- ! Check to make sure that all passengers do not have any part of their bodies in a position where they could be caught when the moon roof is being operated.
- ! Do not allow children to operate the moon roof.  
Closing the moon roof on someone can cause death or serious injury.

### n **Jam protection function**

- ! Never try jamming any part of your body to activate the jam protection function intentionally.
- ! The jam protection function may not work if something gets caught just before the moon roof fully closes.

1-5. Refueling

Opening the fuel tank cap

Perform the following steps to open the fuel tank cap.

n **Before refueling the vehicle**

Turn the “ENGINE START STOP” switch OFF and ensure that all the doors and windows are closed.

n **Opening the fuel tank cap**

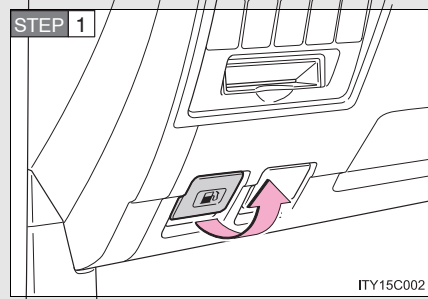

Pull the lever.

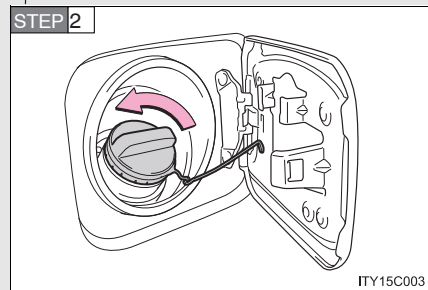

Turn the fuel tank cap slowly to open.

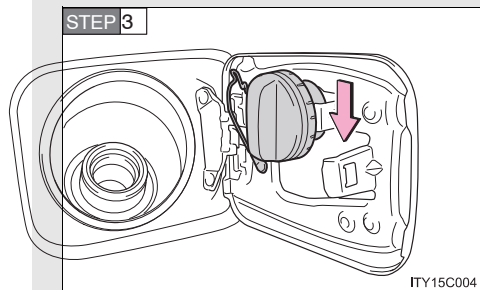

Hang the fuel tank cap on the back of the fuel filler door.



### Closing the fuel tank cap

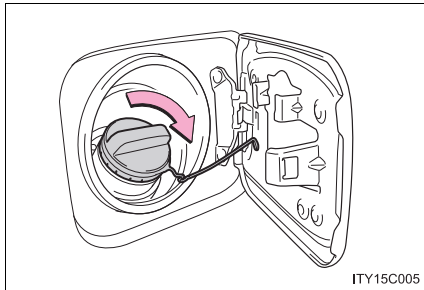

When replacing the fuel tank cap, turn it until a clicking sound is heard.

After releasing your hand, the cap will turn slightly to the opposite direction.

---

**n Fuel types**

Use unleaded gasoline. (87 Octane Rating [Research Octane Number 91] or higher)

**n Fuel tank capacity**

Approximately 24.6 gal. (93 L, 20.5 Imp. gal.)

**⚠ CAUTION****n Refueling the vehicle**

Observe the following precautions while refueling the vehicle. Failure to do so, may result in death or serious injury.

- I** Touch the vehicle or some other metal surface to discharge any static electricity.  
Sparks resulting from discharging static electricity may cause the fuel vapors to ignite.
- I** Always hold the grips on the fuel tank cap and turn it slowly to remove it. A whooshing sound may be heard when the fuel tank cap is loosened. Wait until the sound cannot be heard before fully removing the cap. In hot weather, pressurized fuel may spray out the filler neck and cause injury.
- I** Do not allow anyone that has not discharged static electricity from their bodies to come close to an open fuel tank.
- I** Do not inhale vaporized fuel.  
Fuel contains substances that are harmful if inhaled.
- I** Do not smoke while refueling the vehicle.  
Doing so may cause the fuel to ignite and cause a fire.
- I** Do not return to the vehicle or touch any person or object that is statically charged.  
This may cause static electricity to build up, resulting in a possible ignition hazard.

**n When replacing the fuel tank cap**

Do not use anything but a genuine Toyota fuel tank cap designed for your vehicle. Failure to do so may cause a fire or other incident which may result in death or serious injury.

## 1-5. Refueling

### NOTICE

#### **n Refueling**

Do not spill fuel during refueling.

Failing to do so may damage the vehicle, such as causing the exhaust systems to operate abnormally or damaging fuel system components or the vehicle's painted surface.

1-6. Theft deterrent system  
Engine immobilizer system

The vehicle's keys have built-in transponder chips that prevent the engine from starting if the key has not been previously registered in the vehicle's on-board computer.

Never leave the keys inside the vehicle when you leave the vehicle.

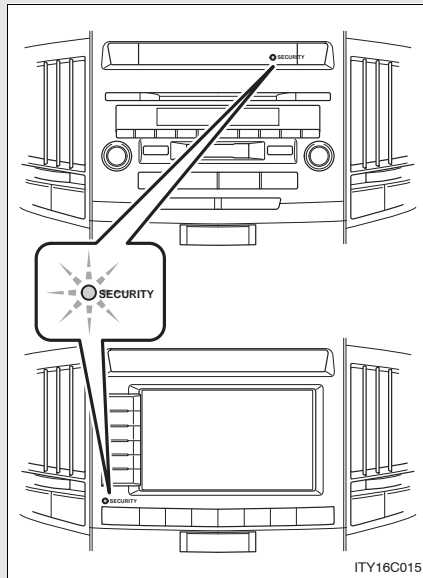

The indicator light flashes after the "ENGINE START STOP" switch has been turned OFF to indicate that the system is operating.

## 1-6. Theft deterrent system

---

### n **System maintenance**

The vehicle has a maintenance-free type of engine immobilizer system.

### n **Conditions that may cause the system to malfunction**

- l If the key is in contact with a metallic object.
- l If the key is in close proximity to or touching a key to the security system (key with a built-in transponder chip) of another vehicle.

**n Certifications for the engine immobilizer system**

FCC ID: NI4TMIMB-1

**NOTE:**

This device complies with Part 15 of the FCC Rules. Operation is subject to the following two conditions: (1) this device may not cause harmful interference, and (2) this device must accept any interference received, including interference that may cause undesired operation.

**FCC WARNING:**

Changes or modifications not expressly approved by the party responsible for compliance could void the user's authority to operate the equipment.

## 1-6. Theft deterrent system

### CAUTION

#### **n Certifications for the engine immobilizer system**

Changes or modifications not expressly approved by the party responsible for compliance could void the user's authority to operate the equipment.

### NOTICE

#### **n For proper system operation**

Do not modify, remove or disable the engine immobilizer system. If any unauthorized changes or modifications are made, the proper operation of the system cannot be guaranteed.

## Alarm

**The system sounds the alarm and flashes lights when forcible entry is detected.**

### n Triggering of the alarm

The alarm is triggered in the following situations.

- 1 A locked door is unlocked or opened in any way other than using the smart key system, the wireless remote control or using the mechanical key. (The doors will lock again automatically)
- 1 The hood is opened while the vehicle is locked.
- 1 The battery is reconnected.

### n Setting the alarm system

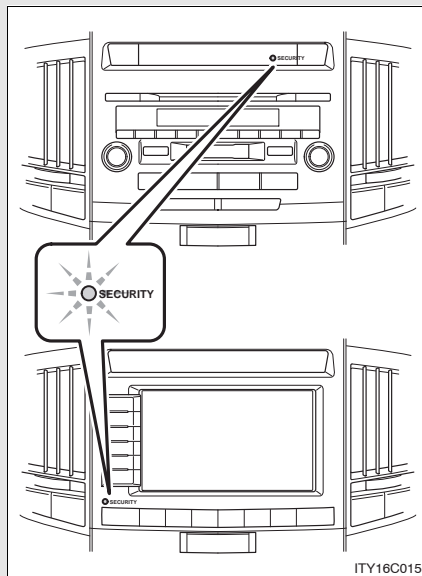

Close the doors and hood, and lock all doors.

The system will be set automatically after 30 seconds.

The indicator light changes from being on to flashing when the system is set.



## 1-6. Theft deterrent system

### n **Deactivating or stopping the alarm**

Do one of the following to deactivate or stop the alarm.

- l Unlock the doors using the smart key system or the wireless remote control.
- l Start the engine. (The alarm will be deactivated or stopped after a few seconds.)

---

### n **Items to check before locking the vehicle**

To prevent unexpected triggering of the alarm and vehicle theft, make sure of the following.

- l Nobody is in the vehicle.
- l The windows and moon roof are closed before the alarm is set.
- l No valuables or other personal items are left in the vehicle.

### n **Triggering of the alarm**

The alarm may be triggered in the following situations.  
(Stopping the alarm deactivates the alarm system.)

- l A person inside the vehicle opens a door or hood.
- l The battery is recharged or replaced when the vehicle is locked.

### n **Panic mode**

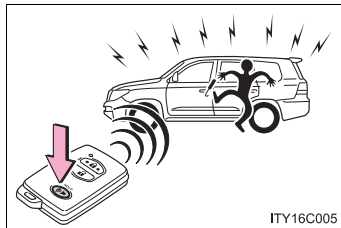

When  is pressed for longer than about one second, the headlights/tail lights/emergency flashers will flash, the front and rear interior lights will come on, and an alarm will sound for about 60 seconds to deter any person from trying to break into or damage your vehicle.

To stop the alarm, press any button on the wireless remote control.

1-6. Theft deterrent system  
Theft prevention labels

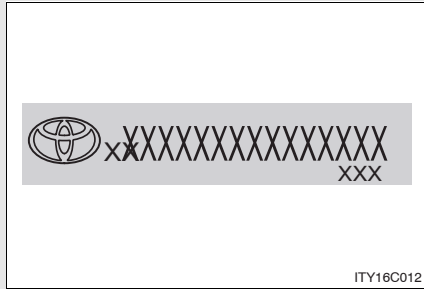

These labels are attached to the vehicle to reduce vehicle theft by facilitating the tracing and recovery of parts from stolen vehicles. Do not remove under penalty of law.

1  
Before driving

1-7. Safety information  
Correct driving posture

Drive with a good posture as follows:

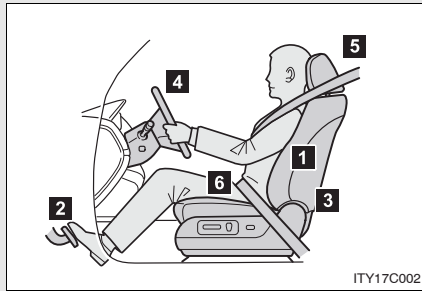

- 1** Sit upright and well back in the seat. ( P. 51 )
- 2** Adjust the position of the seat forward or backward to ensure the pedals can be reached and easily depressed to the extent required. ( P. 51 )
- 3** Adjust the seatback so that the controls are easily operable.
- 4** Adjust the tilt and telescopic positions of the steering wheel downward so the airbag is facing your chest. ( P. 77 )
- 5** Lock the head restraint in place with the center of the head restraint closest to the top of your ears. ( P. 65 )
- 6** Wear the seat belt correctly. ( P. 69 )

**⚠ CAUTION****n While driving**

- I** Do not adjust the position of the driver's seat.  
Doing so could cause the driver to lose control of the vehicle.
- I** Do not place a cushion between the driver or passenger and the seatback.  
A cushion may prevent correct posture from being achieved, and reduce the effectiveness of the seat belt and head restraint, increasing the risk of death or serious injury to the driver or passenger.
- I** Do not place anything under the front seats.  
Objects placed under the front seats may become jammed in the seat tracks and stop the seat from locking in place. This may lead to an accident. The adjustment mechanism may also be damaged.

**n Adjusting the seat position**

- I** Do not recline the seat more than necessary when the vehicle is in motion, to reduce the risk of sliding under the lap belt.  
If the seat is too reclined during an accident, the lap belt may slide past the hips and apply restraint forces directly to the abdomen or your neck may contact the shoulder belt, increasing the risk of death or serious injury.
- I** Take care when adjusting the seat position to ensure that other passengers are not injured by the moving seat.
- I** Do not put your hands under the seat or near the moving parts to avoid injury.  
Fingers or hands may become jammed in the seat mechanism.

## 1-7. Safety information

### SRS airbags

The SRS airbags inflate when the vehicle is subjected to certain types of severe impacts that may cause significant injury to the occupants. They work together with the seat belts to help reduce the risk of death or serious injury.

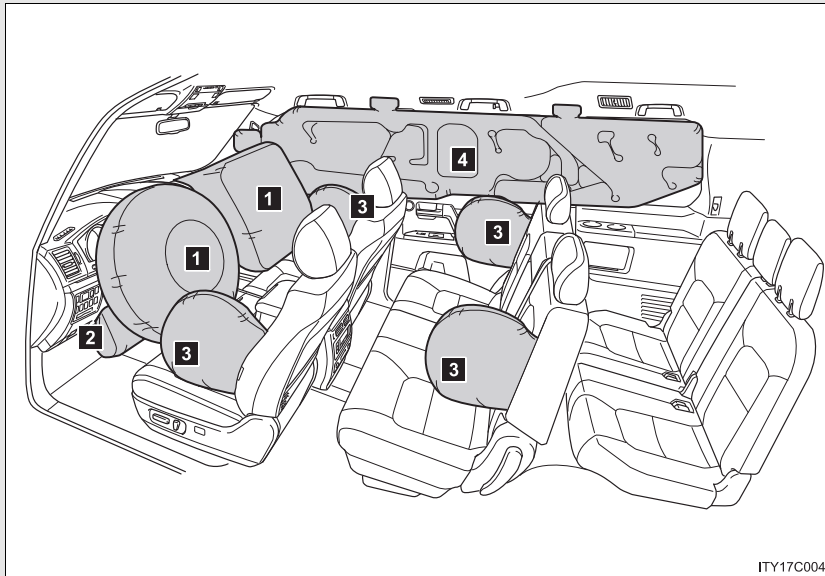

#### ► Front airbags

##### 1 Driver airbag/front passenger airbag

Can help protect the head and chest of the driver and front passenger from impact with interior components.

##### 2 Knee airbags

Can help provide driver and front passenger protection.

► Side and curtain shield airbags

3 Side airbags

Can help protect the torso of the front seat occupants second outboard seat occupants.

4 Curtain shield airbags

Can help protect primarily the head of front seat occupants, second and third outboard seat occupants.

1

Before driving

### Airbag system components

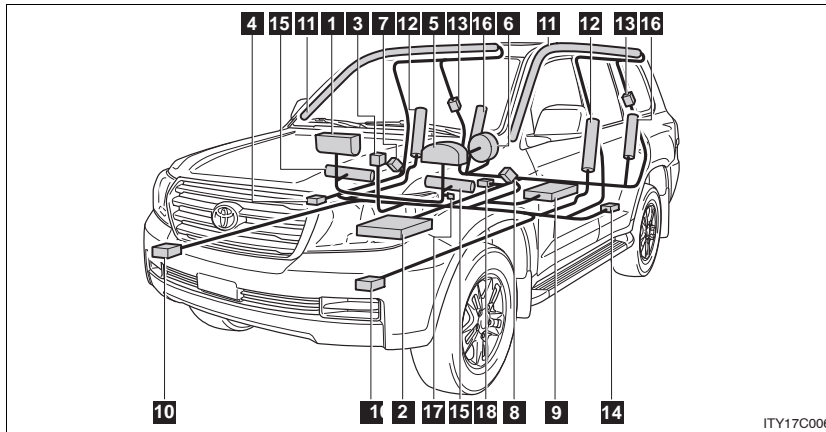

- |  |   |
|--|---|
| <b>1</b> Front passenger airbag                                  | <b>10</b> Front airbag sensor                               |
| <b>2</b> Airbag sensor assembly                                  | <b>11</b> Curtain shield airbag                             |
| <b>3</b> Front passenger occupant classification indicator light | <b>12</b> Side airbag (front seat)                          |
| <b>4</b> Occupant detection sensor                               | <b>13</b> Curtain shield airbag sensor                      |
| <b>5</b> SRS warning light and "RSCA OFF" indicator light        | <b>14</b> Side and curtain shield airbag sensor             |
| <b>6</b> Driver airbag   | <b>15</b> Knee airbag                                       |
| <b>7</b> Front passenger's seat belt buckle switch               | <b>16</b> Side airbag (second outboard seat)                |
| <b>8</b> Driver's seat belt buckle switch                        | <b>17</b> Roll sensing of curtain shield airbags off switch |
| <b>9</b> Driver's seat position sensor                           | <b>18</b> Floor sensor                                      |

Your vehicle is equipped with ADVANCED AIRBAGS designed based on US motor vehicle safety standards (FMVSS208). The airbag system controls airbag deployment power for the driver and front passenger. The driver airbag system consists of the driver seat's position sensor etc. The front passenger's airbag system consists of the front passenger occupant classification sensor etc.

The main SRS airbag system components are shown above. The SRS airbag system is controlled by the airbag sensor assembly. The airbag sensor assembly consists of a safing sensor and an airbag sensor.

In certain types of severe frontal or side impacts, the SRS airbag system triggers the airbag inflators. A chemical reaction in the inflators quickly fills the airbags with non-toxic gas to help restrain the motion of the occupants.

1

Before driving

#### ■ If the SRS airbags deploy (inflate)

- ┆ Bruising and slight abrasions may result from contact with a deploying (inflating) SRS airbag.
- ┆ A loud noise and white powder will be emitted.
- ┆ Parts of the airbag module (steering wheel hub, airbag cover and inflator) as well as the front seats, second seats may be hot for several minutes. The airbag itself may also be hot.
- ┆ The windshield may crack.



**n Operating conditions (front airbags)**

- l The SRS front airbags will deploy if the severity of the frontal impact is above the designed threshold level, comparable to an approximate 15 mph (25 km/h) collision when the vehicle impacts straight into a fixed barrier that does not move or deform.

However, this threshold velocity will be considerably higher if the vehicle strikes an object, such as a parked vehicle or sign pole, which can move or deform on impact, or if the vehicle is involved in an underride collision (e.g. a collision in which the front of the vehicle “underrides”, or goes under, the bed of a truck, etc.).

- l It is possible that in some collisions where the forward deceleration of the vehicle is very close to the designed threshold level, the SRS front airbags and the seat belt pretensioners may not activate together.
- l The SRS front passenger airbag will not activate if there is not passenger sitting in the front passenger seat. However, the front passenger airbag may deploy if luggage is put in the seat or the seat belt is fastened, even if the seat is unoccupied.

**n Operating conditions (side airbags and curtain shield airbags)**

- l The SRS side airbags and curtain shield airbags are designed to inflate when the passenger compartment is subjected to a severe impact from the side.
- l The SRS side airbag on the passenger seat will not activate if there is no passenger sitting in the front passenger seat. However, the side airbag on the passenger seat may deploy if luggage is put in the seat or the seat belt is fastened, even if the seat is unoccupied.

**n Conditions under which the SRS airbags may deploy (inflate), other than a collision**

The SRS front, side and curtain shield airbags may also deploy if a serious impact occurs to the underside of your vehicle. Some examples are shown in the illustration.

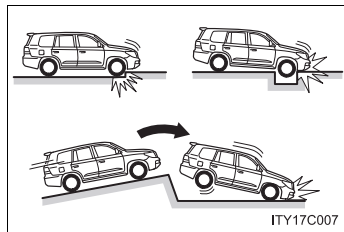

- | Hitting a curb, edge of pavement or hard surface
- | Falling into or jumping over a deep hole
- | Landing hard or vehicle falling

The SRS curtain shield airbags may also deploy under the situations shown in the illustration.

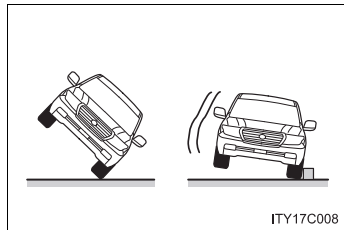

- | The angle of vehicle tip-up is marginal.
- | The vehicle skids and hits a curb stone.

**n Types of collisions that may not deploy the SRS airbag (front airbags)**

The SRS front airbags are generally not designed to inflate if the vehicle is involved in a side or rear collision, if it rolls over, or if it is involved in a low-speed frontal collision. But, whenever a collision of any type causes sufficient forward deceleration of the vehicle, deployment of the SRS front airbags may occur.

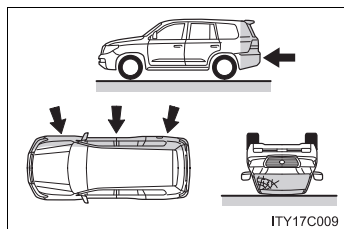

- | Collision from the side
- | Collision from the rear
- | Vehicle rollover

**n Types of collisions that may not deploy the SRS airbag (side and curtain shield airbags)**

The SRS side airbag and curtain shield airbag system may not activate if the vehicle is subjected to a collision from the side at certain angles, or a collision to the side of the vehicle body other than the passenger compartment.

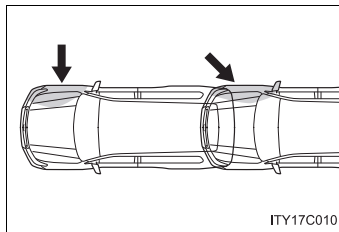

- | Collision from the side to the vehicle body other than the passenger compartment
- | Collision from the side at an angle

The SRS side airbags are not generally designed to inflate if the vehicle is involved in a frontal or rear collision, if it rolls over, or if it is involved in a low-speed side collision.

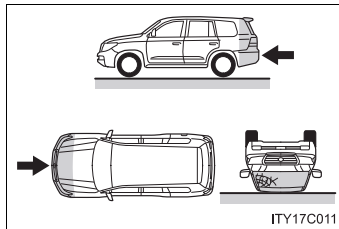

- | Collision from the front
- | Collision from the rear
- | Vehicle rollover

The SRS curtain shield airbags are not generally designed to inflate if the vehicle is involved in a frontal or rear collision, if it pitches end over end, or if it is involved in a low-speed side collision.

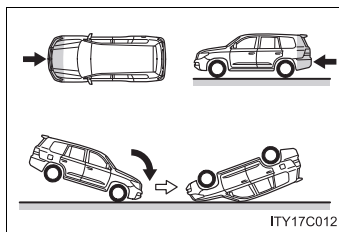

- | Collision from the front
- | Collision from the rear
- | Pitching end over end

**When to contact your Toyota dealer**

In the following cases, contact your Toyota dealer as soon as possible. Do not disconnect the battery cables before contacting your Toyota dealer.

- 1 Any of the SRS airbags have been inflated.

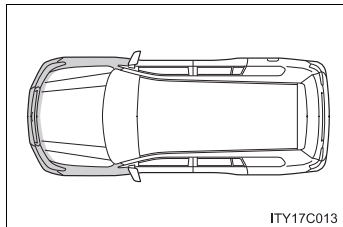

- 1 The front of the vehicle is damaged or deformed, or the vehicle was involved in an accident that was not severe enough to cause the SRS airbags to inflate.

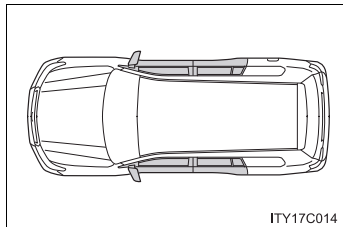

- 1 A portion of the doors is damaged or deformed, or the vehicle was involved in an accident that was not severe enough to cause the SRS side airbags and curtain shield airbags to inflate.

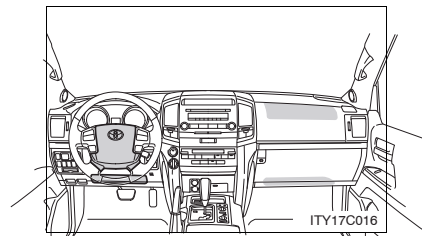

- 1 The pad section of the steering wheel, dashboard near the front passenger airbag or lower portion of the instrument panel is scratched, cracked or otherwise damaged.

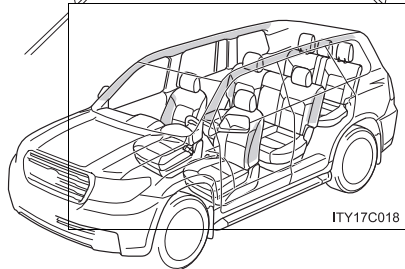

- 1 The surface of the seats with the side airbag is scratched, cracked, or otherwise damaged.
- 1 The portion of the front, center and rear pillar garnish, or roof interior containing the curtain shield airbags inside is scratched, cracked or otherwise damaged.

1  
Before driving

 CAUTION

**n SRS airbag precautions**

Observe the following precautions regarding the airbags.  
Failure to do so may cause death or serious injury.

- I** The driver and all passengers in the vehicle must wear their seat belts properly.  
The SRS airbags are supplemental devices to be used with the seat belts.
- I** The SRS driver airbag deploys with considerable force, and can cause death or serious injury especially if the driver is very close to the airbag. The National Highway Traffic Safety Administration (“NHTSA”) advises:  
Since the risk zone for driver airbag is the first 2 – 3 in. (50 – 75 mm) of inflation, placing yourself 10 in. (250 mm) from your driver airbag provides you with a clear margin of safety. This distance is measured from the center of the steering wheel to your breastbone. If you sit less than 10 in. (250 mm) away now, you can change your driving position in several ways:
  - Move your seat to the rear as far as you can while still reaching the pedals comfortably.
  - Slightly recline the back of the seat.  
Although vehicle designs vary, many drivers can achieve the 10 in. (250 mm) distance, even with the driver seat all the way forward, simply by reclining the back of the seat somewhat. If reclining the back of your seat makes it hard to see the road, raise yourself by using a firm, non-slippery cushion, or raise the seat if your vehicle has that feature.
  - If your steering wheel is adjustable, tilt it downward. This points the airbag toward your chest instead of your head and neck.

The seat should be adjusted as recommended by NHTSA above, while still maintaining control of the foot pedals, steering wheel, and your view of the instrument panel controls.

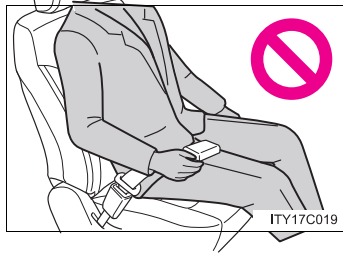
**⚠ CAUTION****n SRS airbag precautions**

**I** If the seat belt extender has been connected to the driver's seat belt buckle but the seat belt extender has not also been fastened to the latch plate of the driver's seat belt, the SRS driver's airbag system will judge that the driver is wearing the seat belt even though the seat belt has not been connected. In this case, the driver's airbag may not activate correctly in a collision, resulting in death or serious injury in the event of collision. Be sure to wear the seat belt with the seat belt extender.

**I** The SRS front passenger airbag also deploys with considerable force, and can cause death or serious injury especially if the front passenger is very close to the airbag. The front passenger seat should be as far from the airbag as possible with the seatback adjusted, so the front passenger sits upright.

**I** Improperly seated and/or restrained infants and children can be killed or seriously injured by a deploying airbag. An infant or child who is too small to use a seat belt should be properly secured using a child restraint system. Toyota strongly recommends that all infants and children be placed in the rear seats of the vehicle and properly restrained. The rear seats are the safest for infants and children. ( P. 123)

**⚠ CAUTION**

**n SRS airbag precautions**

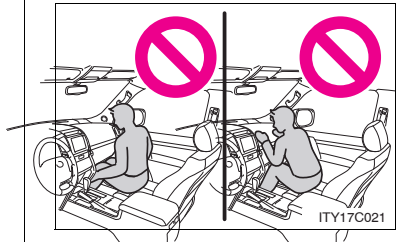

I Do not sit on the edge of the seat or lean against the dashboard.

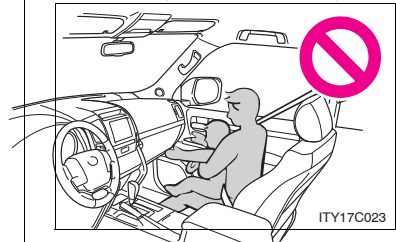

I Do not allow a child to sit on the knees of a front passenger while the vehicle is moving.

I Do not drive the vehicle while the driver or passenger have items resting on their knees.

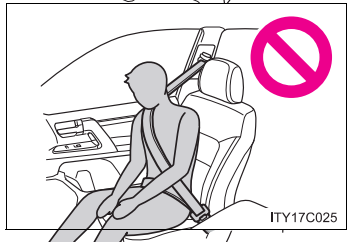

I Do not lean against the door, the roof side rail or the front, center and rear pillars.



I Do not allow anyone to kneel on the passenger seats toward the door or put their head or hands outside the vehicle.

**CAUTION**

**SRS airbag precautions**

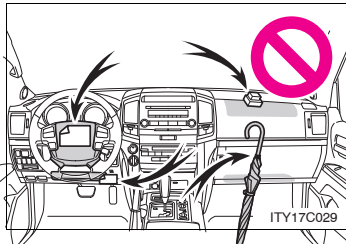

Do not attach anything to or lean anything against areas such as the dashboard or steering wheel pad or lower portion of the instrument panel. These items can become projectiles when SRS driver, front passenger and knee airbags deploy.

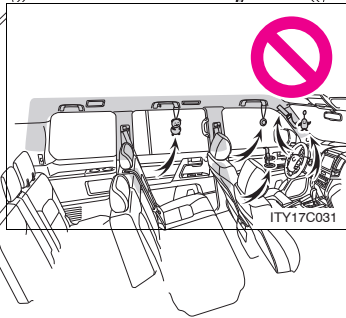

Do not attach anything to areas such as the door, windshield glass, side door glass, front, center and rear pillars, roof side rail or assist grip.

Do not hang coat hangers or other hard objects on the coat hooks. All of these items could become projectiles and seriously injure or kill you, should the SRS curtain shield airbag deploy.

1  
Before driving



 CAUTION

- I If the vinyl cover is put on the area where the SRS knee airbag will deploy, be sure to remove it.
- I Do not use seat accessories which cover the front seat as they may interfere with inflation of the front passenger airbag.
- I Do not use seat accessories which cover the parts where the SRS side airbags inflate as they may interfere with inflation of the airbags.
- I Do not strike or apply significant levels of force to the area of the SRS airbag components shown on P. 104. Doing so can cause the SRS airbags to malfunction.
- I Do not touch any of the component parts immediately after the SRS airbags have deployed (inflated) as they may be hot.
- I If breathing becomes difficult after the SRS airbag has deployed, open a door or window to allow fresh air in, or leave the vehicle if it is safe to do so. Wash off any residue as soon as possible to prevent skin irritation.
- I If the areas where the SRS airbags are stored, such as the steering wheel pad and front pillar garnish, are damaged or cracked, have them replaced by your Toyota dealer.

**⚠ CAUTION****n Modification and disposal of SRS airbag system components**

Do not dispose of your vehicle or perform any of the following modifications without consulting your Toyota dealer. The SRS airbag may malfunction or deploy (inflate) accidentally, causing death or serious injury.

- ! Installation, removal, disassembly and repair of the SRS airbags
- ! Repairs, modifications, removal or replacement of the steering wheel, instrument panel, dashboard, seats or seat upholstery, front, center and rear pillars or roof side rail
- ! Repairs or modifications of the front fender, front bumper, or side of the occupant compartment
- ! Installation of snow plows, winches, etc. to the front grille (bull bars, kangaroo bar etc.)
- ! Modifications to the vehicle's suspension system
- ! Installation of electronic devices such as mobile two-way radios or CD players
- ! Modifications to your vehicle for a person with a physical disability.

1

Before driving

### Deactivating the curtain shield airbags in a vehicle rollover

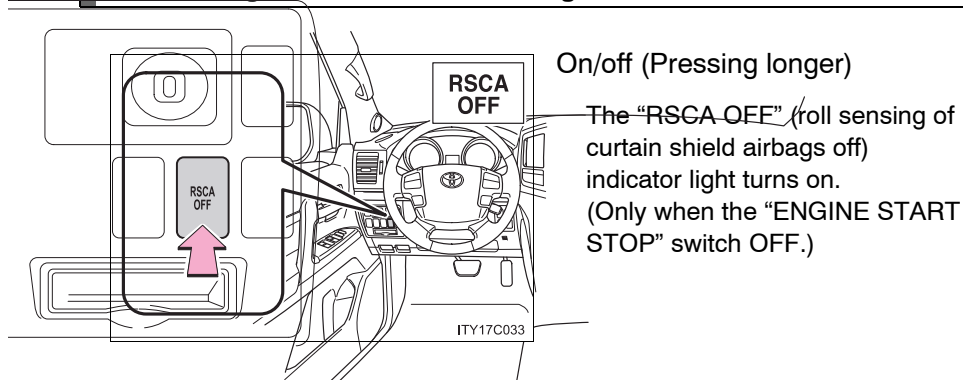

**n This switch only should be used**

In a situation where the inflation is not desired (such as during extreme off road driving).

**n Operating conditions when the "RSCA OFF" indicator turns on**

- l The curtain shield airbag and seat belt pretensioner will not activate in a vehicle rollover.
- l The curtain shield airbag will activate in a severe side impact.

**! CAUTION**

**n While normal driving**

Make sure the "RSCA OFF" indicator light is not turned on. If it is left on, the curtain shield airbag will not activate in the event of an accident, which may cause death or serious injury.

## Front passenger occupant classification system

Your vehicle is equipped with a front passenger occupant classification system. This system detects the conditions of the front passenger seat and activates or deactivates the devices for front passenger.

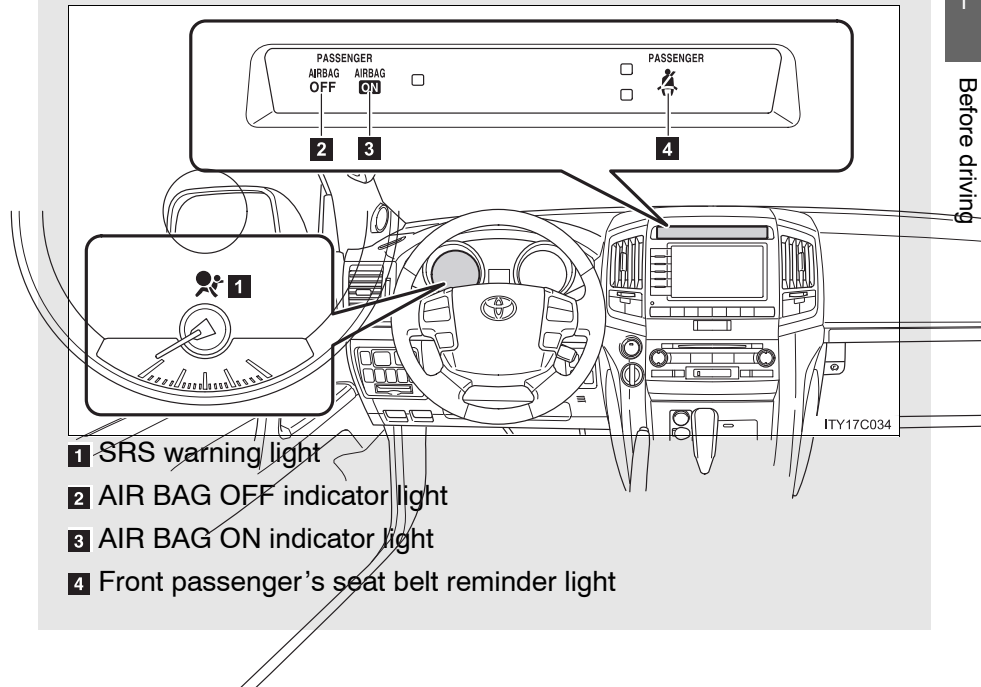

- 1 SRS warning light
- 2 AIR BAG OFF indicator light
- 3 AIR BAG ON indicator light
- 4 Front passenger's seat belt reminder light

**Condition and operation in the front passenger occupant classification system**

n **Adult\*1**

Indicator/ warning light	AIR BAG ON and AIR BAG OFF indicator lights	On
	SRS warning light	Off
	Front passenger's seat belt reminder light	Flashing*2
Devices	Front passenger airbag and knee airbag	Activated
	Side airbag in the front passenger seat	
	Curtain shield airbag on the front passenger side	
	Front passenger's seat belt pretensioner	

n **Child\*3 or child restraint system\*4**

Indicator/ warning light	AIR BAG ON and AIR BAG OFF indicator lights	Off*5
	SRS warning light	Off
	Front passenger's seat belt reminder light	Flashing*2
Devices	Front passenger airbag and knee airbag	Deactivated
	Side airbag in the front passenger seat	
	Curtain shield airbag on the front passenger side	Activated
	Front passenger's seat belt pretensioner	

n **Unoccupied**

Indicator/ warning light	AIR BAG ON and AIR BAG OFF indicator lights	Not illumi- nated
	SRS warning light	Off
	Front passenger's seat belt reminder light	
Devices	Front passenger airbag and knee airbag	Deactivated
	Side airbag in the front passenger seat	
	Curtain shield airbag on the front passenger side	Activated
	Front passenger's seat belt pretensioner	Deactivated

1  
Before driving

n **System malfunction**

Indicator/ warning light	AIR BAG ON and AIR BAG OFF indicator lights	Off
	SRS warning light	On
	Front passenger's seat belt reminder light	Off
Devices	Front passenger airbag and knee airbag	Deactivated
	Side airbag in the front passenger seat	
	Curtain shield airbag on the front passenger side	Activated
	Front passenger's seat belt pretensioner	

- \*1: The system judges a person of adult size as an adult. When a smaller adult sits in the front passenger seat, the system may recognize him/her as a child depending on his/her physique and posture.
- \*2: In the event the front passenger does not wear a seat belt.
- \*3: When a larger child who has outgrown a child restraint system sits in the front passenger seat, the system may recognize him/her as an adult depending on his/her physique or posture.
- \*4: Never install a rear-facing child restraint system on the front passenger seat. A rear-facing child restraint system should only be installed on the front passenger seat when it is unavoidable.  
( P. 123)
- \*5: In case the indicator is not illuminated, consult this manual as for installing the child restraint system properly. ( P. 127)

**⚠ CAUTION****n Front passenger occupant classification system precautions**

Observe the following precautions regarding front passenger occupant classification system.

Failure to do so may cause death or serious injury.

- I Wear the seat belt properly.
- I Make sure the front passenger's seat belt tab has not been left inserted into the buckle before someone sits in the front passenger seat.
- I Make sure the AIR BAG OFF indicator light is not illuminated when using the seat belt extender for the front passenger seat. If the AIR BAG OFF indicator light is illuminated, disconnect the extender tongue from the seat belt buckle, then reconnect the seat belt. Reconnect the seat belt extender after making sure the AIR BAG ON indicator light is illuminated. If you use the seat belt extender while the AIR BAG OFF indicator light is illuminated, the front passenger airbag and side airbag on the front passenger side may not activate correctly, which could cause death or serious injury in the event of collision.
- I Do not apply a heavy load to the front passenger seat.
- I Do not put weight on the front passenger seat by putting your hands or feet on the front passenger seat seatback from the second seat.
- I Do not let a second seat passenger lift the front passenger seat with their feet or press on the seatback with their legs.
- I Do not put objects under the front passenger seat.
- I Do not recline the front passenger seatback so far that it touches a second seat. This may cause the AIR BAG OFF indicator light to be illuminated, which indicates that the passenger's airbags will not deploy in the event of a severe accident. If the seatback touches the second seat, return the seatback to a position where it does not touch the second seat. Keep the front passenger seatback as upright as possible when the vehicle is moving. Reclining the seatback excessively may lessen the effectiveness of the seat belt system.

1

Before driving



 CAUTION

**n Front passenger occupant classification system precautions**

- I** If an adult sits in the front passenger seat, the AIR BAG ON indicator light is illuminated. If the AIR BAG OFF indicator is illuminated, ask the passenger to sit up straight, well back in the seat, feet on the floor, and with the seat belt worn correctly. If the AIR BAG OFF indicator still remain illuminated, either ask the passenger to move to the second seat, or if that is not possible, move the front passenger seat fully rearward.
- I** When it is unavoidable to install the forward-facing child restraint system on the front passenger seat, install the child restraint system on the front passenger seat in the proper order. ( P. 127)
- I** Do not modify or remove the front seat.
- I** Do not kick the front passenger seat or subject it to severe impact. Otherwise, the SRS warning light may come on to indicate a malfunction in the detection system. In this case, contact your Toyota dealer immediately.
- I** Do not use a seat accessory, such as a cushion or seat cover, that covers the seat cushion surface.
- I** Child restraint systems installed on the second seat should not contact the front seat backs.

1-7. Safety information  
Child restraint systems

**A child restraint system for a small child or baby must itself be properly restrained on the seat with the lap portion of the lap/shoulder belt.**

**The laws of all 50 states of the U. S.A. now require the use of child restraint systems.**

1

Before driving

**Points to remember**

Studies have shown that installing a child restraint on a rear seat is much safer than installing one to the front passenger seat.

1 Choose a child restraint system appropriate to the age and size of the child.

1 For installation details, follow the instructions provided with the child restraint system.

General installation instructions are provided in this manual.

( P. 127)

### Types of child restraints

Child restraint systems are classified into the following 3 types according to the age and size of the child.

▶ Infant seat

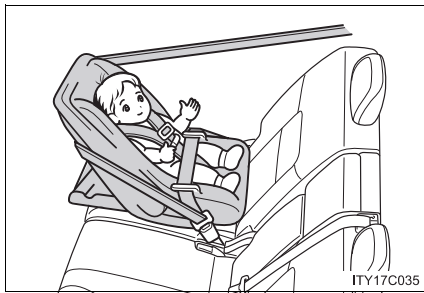

▶ Convertible seat

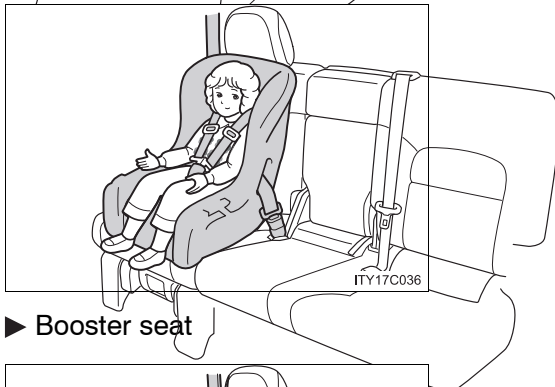

▶ Booster seat

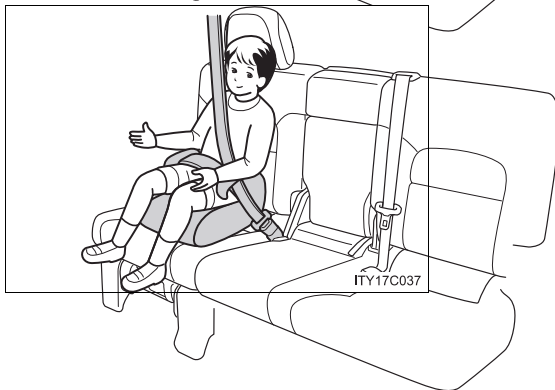

### ■ When installing the child restraint system on the front passenger seat

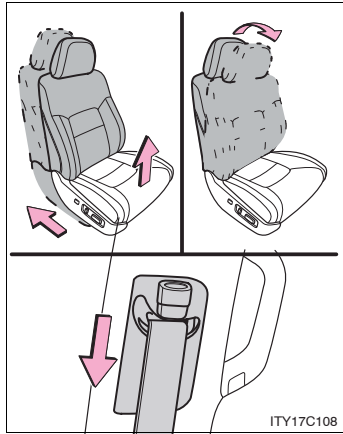

When you have to use a child restraint system on the front passenger seat, adjust the following:

- 1 The seatback to the most upright position
- 1 The seat cushion to the fully rearward and highest position
- 1 The seat belt height to the lowest position

1  
Before driving

### ■ When the child restraint system is not in use

Leave the child restraint system properly secured on the seat. Do not store the restraint loosely on a passenger seat or in the luggage compartment.

### ■ Selecting an appropriate child restraint system

Get an appropriate child restraint system for the child. If a child is too large for a child restraint system, sit the child on a rear seat and use the vehicle's seat belt. ( P. 69)

### ⚠ CAUTION

#### ■ Using a child restraint system

The use of a child restraint system not suitable for the vehicle may not properly secure the infant or child, resulting in serious injury or even death.

 CAUTION

**n Child restraint precautions**

- I** For effective protection in automobile accidents and sudden stops, a child must be properly restrained, using a seat belt or child restraint system depending on the age and size of the child. Holding a child in your arms is not a substitute for a child restraint system. In an accident, the child can be crushed against the windshield, or between you and the vehicle's interior.
- I** Toyota strongly urges the use of a proper child restraint system that conforms to the size of the child, installed on the rear seat. According to accident statistics, the child is safer when properly restrained in the rear seat than in the front seat.
- I** Never install a rear-facing child restraint system on the front passenger seat even if the AIR BAG OFF indicator light illuminates. In the event of an accident, the force of the rapid inflation of the front passenger airbag can cause death or serious injury to the child if the rear-facing child restraint system is installed on the front passenger seat.
- I** A forward-facing child restraint system should allowed to be installed on the front passenger seat only when it is unavoidable. Always move the seat as far back as possible even if the AIR BAG OFF indicator light illuminates, because the front passenger airbag could inflate with considerable speed and force. Otherwise, the child may be killed or seriously injured.
- I** Do not use the seat belt extender when installing a child restraint system on the front or rear passenger seat. If installing a child restraint system with the seat belt extender connected to the seat belt, the seat belt will not securely hold the child restraint system, which could cause death or serious injury to the child or other passengers in the event of collision.
- I** Do not allow the child to lean his/her head or any part of his/her body against the door or the area of the seat, front pillar or roof side rail from which the side airbags or curtain shield airbags deploy even if the child is seated in the child restraint system. It is dangerous if the side airbags and curtain shield airbags inflate, and the impact could cause death or serious injury to the child.
- I** Make sure you have complied with all installation instructions provided by the child restraint manufacturer and that the system is properly secured. If it is not secured properly, it may cause death or serious injury to the child in the event of a sudden stop or accident.

1-7. Safety information  
Installing child restraints

Follow the child restraint system manufacturer's instructions. Firmly secure the child restraints using the seat belt or a child restraint lower anchor belt. Attach the top strap when installing a child restraint.

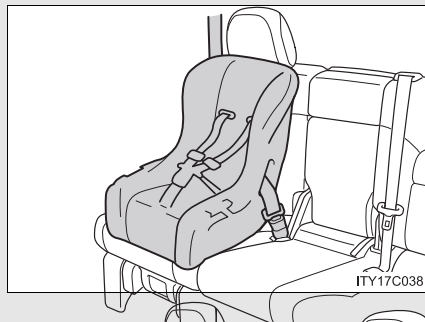

Seat belts equipped with a child restraint locking mechanism (ALR/ELR belts except driver's seat belt) ( P. 69)

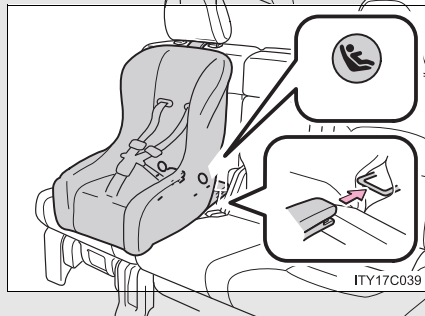

Child restraint lower anchors

Lower anchors are provided for the outside second seat. (Buttons displaying the location of the anchors are attached to the seats.)

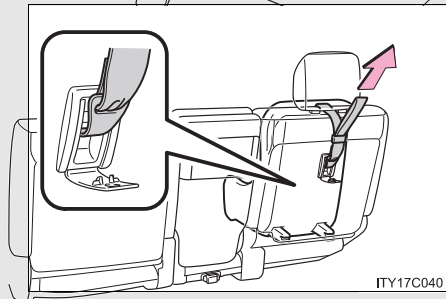

Anchor bracket (for top strap)

Anchor brackets are provided for all second seats.

**Installing child restraints using a seat belt (child restraint lock function belt)**

**n Rear-facing child restraint system      Infant seat/convertible seat**

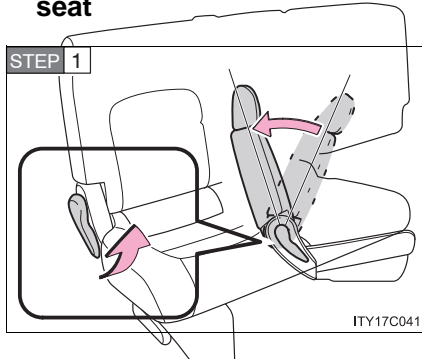

Fold the seatback while pulling the seatback angle lever. Return the seatback and secure it at the first lock position. ( P. 53)

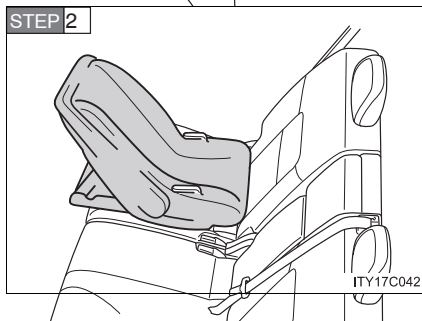

Place the infant seat/convertible seat on the second or third seat facing the rear of the vehicle.

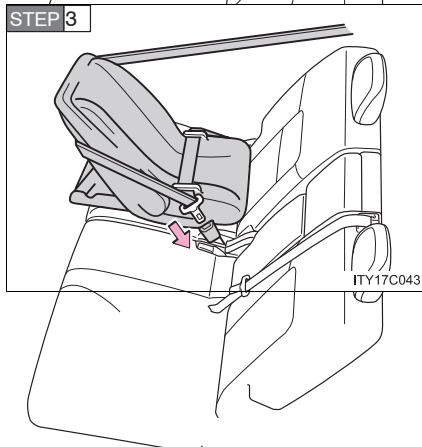

Run the seat belt through the infant seat/convertible seat and insert the plate into the buckle. Make sure that the belt is not twisted.

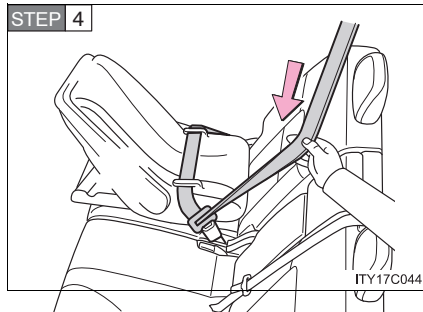

Fully extend the shoulder belt and then allow it to retract slightly in order to activate the ALR lock mode.

Lock mode allows the seat belt to retract only.

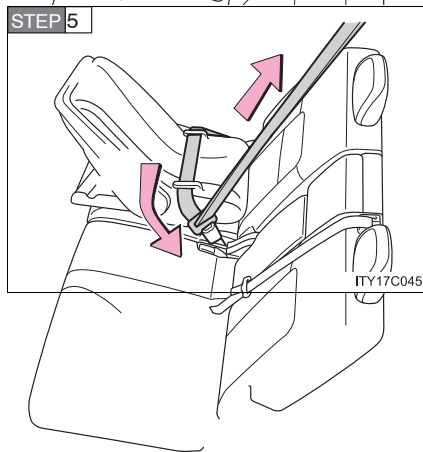

While pushing the infant seat/convertible seat down into the seat, allow the shoulder belt to retract until the infant seat/convertible seat is securely in place.

After the shoulder belt has retracted to a point where there is no slack in the belt, pull the belt to check that it cannot be extended.

1  
Before driving



n **Forward-facing Convertible seat**

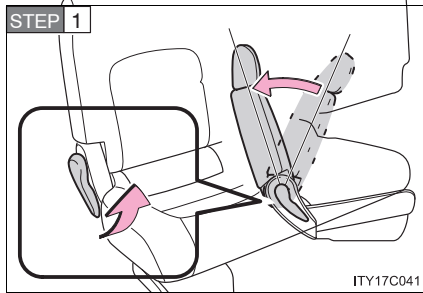

Fold the seatback while pulling the seatback angle lever. Return the seatback and secure it at the first lock position. ( P. 53)

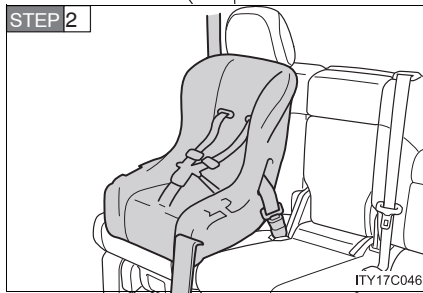

Place the convertible seat on the seat facing the front of the vehicle.

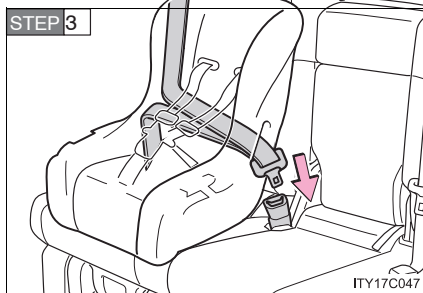

Run the seat belt through the convertible seat and insert the plate into the buckle. Make sure that the belt is not twisted.

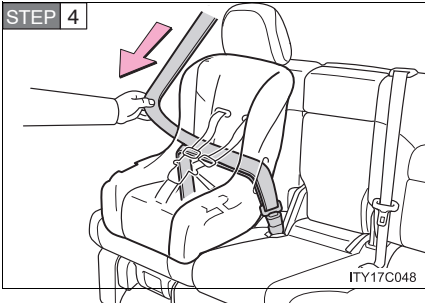

Fully extend the shoulder strap and then allow it to retract slightly into the ALR lock mode.

Lock mode allows the seat belt to retract only.

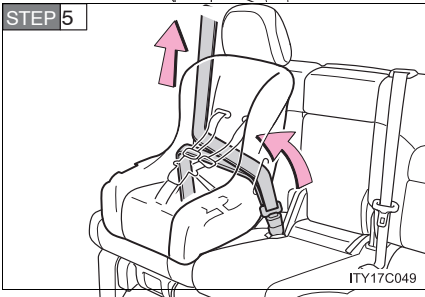

While pushing the convertible seat into the seat, allow the shoulder belt to retract until the convertible seat is securely in place.

After the shoulder belt has retracted to a point where there is no slack in the belt, pull the belt to check that it cannot be extended.

1

Before driving

1-7. Safety information

n **Booster seat**

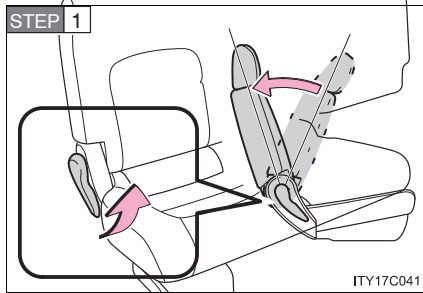

Fold the seatback while pulling the seatback angle lever. Return the seatback and secure it at the first lock position. ( P. 53)

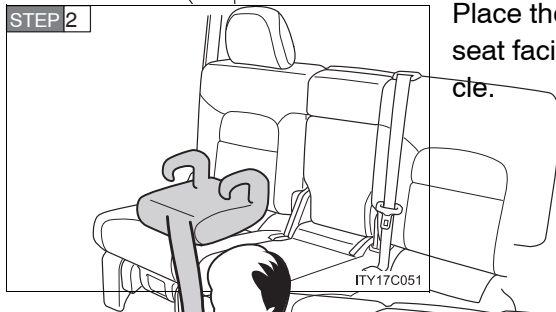

Place the booster seat on the seat facing the front of the vehicle.



Sit the child in the booster seat. Fit the seat belt to the booster seat according to the manufacturer's instructions and insert the plate into the buckle. Make sure that the belt is not twisted.

Check that the shoulder belt is correctly positioned over the child's shoulder, and that the lap belt is as low as possible. ( P. 69)

**Removing a child restraint installed with a seat belt**

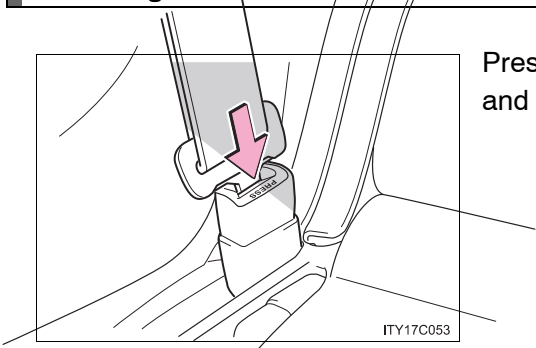

Press the buckle release button and fully retract the seat belt.

1  
Before driving

**Installation with child restraint lower anchors**

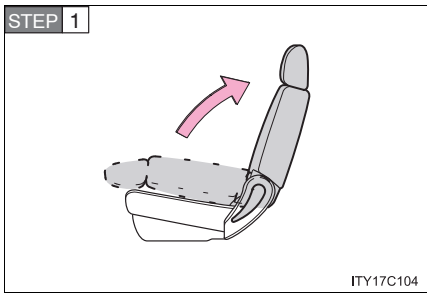

Fold the seatback forward and then back to the 1st lock position (most upright position) until it locks into place.

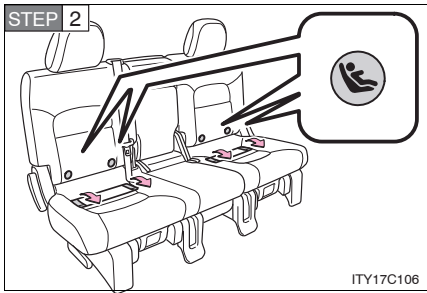

Take off the covers between the seat cushion and seatback, then confirm the position of the lower anchors below the symbol in the seatback.

► Type A

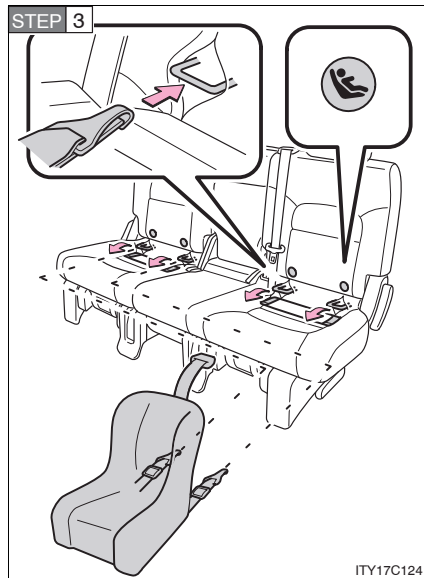

Latch the hooks of the lower straps onto the anchors.

If the child restraint has a top strap, the top strap should be latched onto the anchor.

► Type B

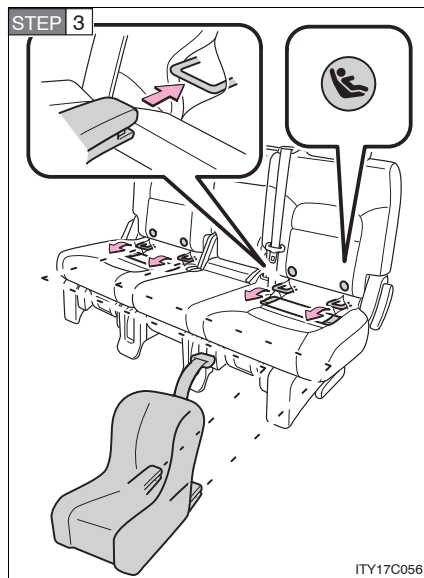

Latch the buckles onto the anchors.

If the child restraint has a top strap, the top strap should be latched onto the anchor.

### Child restraint systems with a top strap

**STEP 1** Secure the child restraint using a seat belt or ISOFIX rigid anchors, and do the following.

► Outside

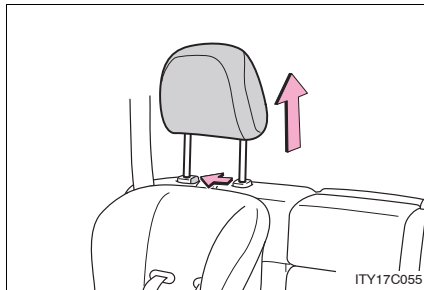

Adjust the head restraint to the upmost position.

► Center

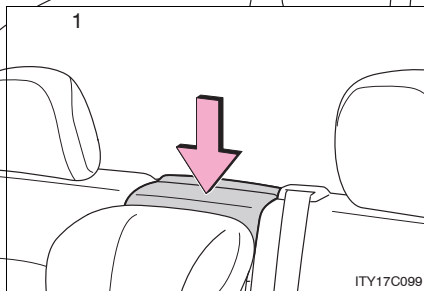

Lower the head restraint to the lowest position.

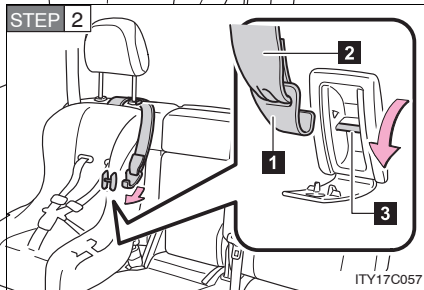

**STEP 2** Open the anchor bracket cover, latch the hook onto the anchor bracket and tighten the top strap.

Make sure the top strap is securely latched.

- 1** Hook
- 2** Top strap
- 3** Anchor bracket

1  
Before driving

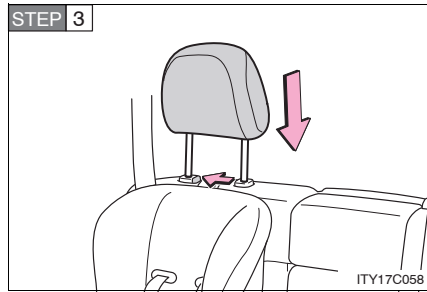

Outside only: Adjust the head restraint to the downmost position.

**n Laws and regulations pertaining to Anchors**

Anchors conform to FMVSS225.

Child restraint systems conforming to FMVSS213 specifications can be used.

This vehicle is designed to conform to the SAE J1819.

**⚠ CAUTION**

**n When installing a booster seat**

Do not fully extend the shoulder belt to prevent the belt from going to ALR lock mode: ( P. 72)

**I** ALR mode causes the belt to tighten only which could cause injury or discomfort to the child.

**I** Do not allow the child to play with the seat belt or the child could be killed or serious injured.

**⚠ CAUTION****n When installing a child restraint system**

Follow the directions given in the child restraint system installation manual and fix the child restraint system securely in place.

If the child restraint system is not correctly fixed in place, the child may be seriously injured or even killed in the event of sudden braking or an accident.

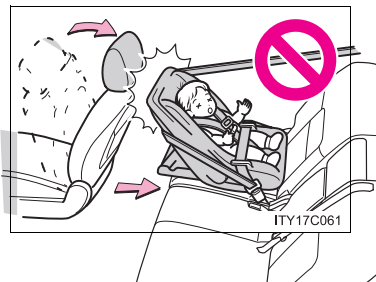

**I** If the driver's seat interferes with the child restraint system and prevents it from being attached correctly, attach the child restraint system to the right-hand rear seat.

**I** Child restraint system installed on the third seat should not contact the second seatbacks.

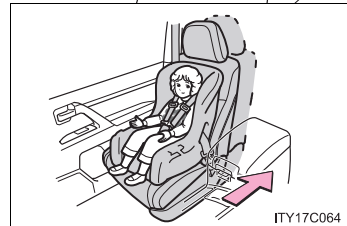

**I** Only put a forward facing or booster child seat on the front seat when unavoidable. When installing a forward facing or booster child restraint on the front passenger seat, move the seat as far back as possible even if the AIR BAG OFF indicator light illuminates. Failing to do so may result in death or serious injury if the airbags deploy (inflate).

**I** When a booster seat is installed, always ensure that the shoulder belt is positioned across the center of the child's shoulder. The belt should be kept away from the child's neck, but not so that it could fall off the child's shoulder. Failing to do so may result in death or serious injury in the event of an accident or sudden braking.

**I** Ensure the belt and tab are securely locked and that the seat belt is not twisted.

**I** Push and pull the child seat in different directions to be sure it is secure.

**I** Follow all installation instructions provided by the child restraint system manufacturer.



**⚠ CAUTION**

**n Do not use a seat belt extender**

If a seat belt extender is used when installing a child restraint system, the seat belt will not securely hold the child restraint system, which could cause death or serious injury to the child or other passengers in the event of a collision.

**n To correctly attach a child restraint system to the anchors**

**I** When using the lower anchors, be sure that there are no foreign objects around the anchors and that the seat belt is not caught behind the child seat. Make sure the child restraint system is securely attached, or it may cause death or serious injury to the child in the event of a sudden stop or accident.

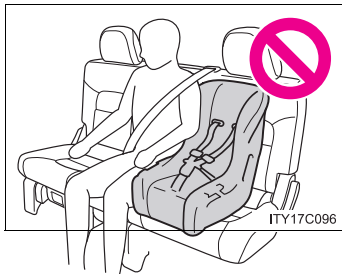

**I** When using the left side lower anchors for the child restraint system, do not sit in the center seat. Seat belt function may be impaired, such as being positioned overly high or loose-fitting, which may result in death or serious injury in the event of a collision.

The following procedures should be observed to ensure safe driving.

n **Starting the engine ( P. 150)**

n **Driving**

**STEP 1** With the brake pedal depressed, shift the shift lever to “D”.  
( P. 153)

**STEP 2** Release the parking brake.  
( P. 159)

**STEP 3** Gradually release the brake pedal and gently push the accelerator pedal to accelerate the vehicle.

n **Stopping**

**STEP 1** With the shift lever in “D”, push the brake pedal.

**STEP 2** If necessary, set the parking brake.

When the vehicle is stopped for an extended period of time, shift the shift lever to “P” or “N”.  
( P. 153)

n **Parking the vehicle**

**STEP 1** With the shift lever in “D”, push the brake pedal.

**STEP 2** Set the parking brake.  
( P. 159)

**STEP 3** Shift the shift lever to “P”.  
( P. 153)

**STEP 4** Press the “ENGINE START STOP” switch and stop the engine.

**STEP 5** Lock the door, making sure that you have the key on your person.

**Starting on a steep incline**

**STEP 1** Firmly set the parking brake and shift the shift lever to “D”.

**STEP 2** Gently depress the accelerator pedal.

**STEP 3** Release the parking brake.

### ■ **Driving in the rain**

- 1 Drive carefully when it is raining, because visibility will be reduced, the windows may become fogged-up, and the road will be slippery.
- 1 Drive carefully when it starts to rain, because the road surface will be especially slippery.
- 1 Refrain from high speeds when driving on an expressway in the rain, because there may be a layer of water between the tires and the road surface, preventing the steering and brakes from operating properly.

### ■ **Breaking in your new Toyota**

To extend the life of the vehicle, the following precautions are recommended to observe:

- 1 For the first 200 miles (300 km):  
Avoid sudden stops.
- 1 For the first 500 miles (800 km):  
Do not tow a trailer.
- 1 For the first 1000 miles (1600 km):
  - Do not drive at extremely high speeds.
  - Avoid sudden acceleration.
  - Do not drive continuously in the low gears.
  - Do not drive at a constant speed for extended periods.

### ■ **Drum-in-disc type parking brake system**

Your vehicle has a drum-in-disc type parking brake system.

This type of brake system needs bedding-down of the brake shoes periodically or whenever the parking brake shoes and/or drums are replaced.

Have your Toyota dealer perform the bedding-down.

### ■ **Operating your vehicle in a foreign country**

Comply with the relevant vehicle registration laws and confirm the availability of the correct fuel. ( P. 496)

 CAUTION

**n When starting the vehicle**

Always keep your foot on the brake pedal while stopped with the engine running. This prevents the vehicle from creeping.

**n When driving the vehicle**

- I** Do not drive if you are unfamiliar with the location of the brake and accelerator pedals to avoid depressing the wrong pedal.
  - Accidentally depressing the accelerator pedal instead of the brake pedal will result in sudden acceleration that may lead to an accident that could result in death or serious injury.
  - When backing up, you may twist your body around, leading to a difficulty in operating the pedals. Make sure to operate the pedals properly.
  - Make sure to keep a correct driving posture even when moving the vehicle only slightly, allowing you to depress the brake and accelerator pedals properly.
  - Depress the brake pedal using your right foot. Depressing the brake pedal using your left foot may delay response in an emergency, resulting in an accident.
- I** Do not drive the vehicle over or stop the vehicle near flammable materials. The exhaust system and exhaust gases can be extremely hot. This may cause a fire if there is any flammable material nearby.
- I** Do not let the vehicle roll backwards while the shift lever is in a driving position, or roll forward while the shift lever is in "R". Doing so may cause the engine to stall and lead to poor steering performance, resulting in an accident or damage to the vehicle.
- I** If the smell of exhaust is noticed inside the vehicle, open the windows and check that the back door is closed. Large amounts of exhaust in the vehicle can cause driver drowsiness and an accident, resulting in death or a serious health hazard. Have the cause of the problem inspected immediately.

**⚠ CAUTION**

- I Do not under any circumstances shift the shift lever to “P” or “R” while the vehicle is moving.  
Doing so can cause significant damage to the transmission and may result in a loss of vehicle control.
- I Do not shift the shift lever to “N” while the vehicle is moving.  
Doing so may cause the engine brake not to operate properly and lead to an accident.
- I Do not turn the engine off while driving.  
The power steering and brake actuator will not operate properly if the engine is not running.
- I Use engine braking (downshift) to maintain a safe speed when driving down a steep hill.  
Using the brakes continuously may cause the brakes to overheat and lose effectiveness. ( P. 154)
- I When stopped on an inclined surface, use the brake pedal and parking brake to prevent the vehicle from rolling backward or forward and causing an accident.
- I Do not adjust the position of the steering wheel, the seat, or the inside or outside rear view mirrors while driving.  
Doing so may result in a loss of vehicle control that can cause accidents that may result in death or serious injury.
- I Always check that all passengers’ arms, heads or other parts of their bodies are not outside the vehicle, as this may result in death or serious injury.
- I Do not drive in excess of the speed limit. Even if the legal speed limit permits it, do not drive over 85 mph (140 km/h) unless your vehicle has high-speed capability tires. Driving over 85 mph (140 km/h) may result in tire failure, loss of control and possible injury. Be sure to consult a tire dealer to determine whether the tires on your vehicle are high-speed capability tires or not before driving at such speeds.

 **CAUTION**

**n When driving on slippery road surfaces**

- I** Sudden braking, acceleration and steering may cause tire slippage and reduce your ability to control the vehicle, resulting in an accident.
- I** Sudden changes in engine speed, such as engine braking caused by up-shifting or down-shifting, may cause the vehicle to skid, resulting in an accident.
- I** After driving through a puddle, lightly depress the brake pedal to make sure that the brakes are functioning properly. Wet brake pads may prevent the brakes from functioning properly. If the brakes on only one side are wet and not functioning properly, steering control may be affected, resulting in an accident.

**n When shifting the shift lever**

Be careful not to shift the shift lever with the accelerator pedal depressed. This may lead to unexpected rapid acceleration of the vehicle that may cause an accident and result in death or serious injury.

**n When the vehicle is stopped**

- I** Do not race the engine.  
If the vehicle is in any gear other than “P” or “N”, the vehicle may accelerate suddenly and unexpectedly, and may cause an accident.
- I** Do not leave the vehicle with the engine running for a long time.  
If such a situation cannot be avoided, park the vehicle in an open space and check that exhaust fumes do not enter the vehicle interior.
- I** Always keep a foot on the brake pedal while the engine is running to prevent an accident caused by the vehicle moving.

**⚠ CAUTION****n When the vehicle is parked**

- I Do not leave glasses, cigarette lighters, spray cans, or soft drink cans in the vehicle when it is in the sun.

Failure to do so may result in the following:

- Gas may leak from a cigarette lighter or spray can, and may lead to a fire.
- The temperature inside the vehicle may cause the plastic lenses and plastic material of eye glasses to deform or crack.
- Soft drink cans may fracture, causing the contents to spray over the interior of the vehicle, and may also cause a short circuit in the vehicle's electrical components.

- I Always apply the parking brake, shift the shift lever to "P", stop the engine and lock the vehicle.

Do not leave the vehicle unattended while the engine is running.

- I Do not touch the exhaust pipe while the engine is running or immediately after turning the engine off.

Doing so may cause burns.

- I Do not leave the engine running in an area with snow build up, or where it is snowing. If snowbanks build up around the vehicle while the engine is running, exhaust gases may collect and enter the vehicle. This may lead to death or a serious health hazard.

**n Exhaust gases**

Exhaust gases include harmful carbon monoxide (CO) that is colorless and odorless. Inhaling exhaust gases may lead to death or a serious health hazard.

- I If the vehicle is in a poorly ventilated area, stop the engine. In a closed area, such as a garage, exhaust gases may collect and enter the vehicle. This may lead to death or a serious health hazard.

- I The exhaust system should be checked occasionally. If there is a hole or crack caused by corrosion, damage to a joint or abnormal exhaust noise, make sure to have the vehicle inspected and repaired by your Toyota dealer. Failure to do so may allow exhaust gases to enter the vehicle, resulting in death or a serious health hazard.

 **CAUTION**

**n When taking a nap in the vehicle**

Always turn the engine off.

Otherwise, you may accidentally move the shift lever or depress the accelerator pedal, which could cause an accident or fire due to abnormal engine overheating. Additionally, if the vehicle is parked in a poorly ventilated area, exhaust fumes may enter the vehicle and cause death or a serious health hazard.

**n When braking the vehicle**

**I** If the power brake assist function does not operate, do not follow other vehicles closely and avoid downhill or sharp turns that require braking. In this case, braking is still possible, but it will require more force on the pedal than usual. Braking distance may also increase.

**I** Do not pump the brake pedal if the engine stalls.  
Each push on the pedal uses up the reserve for the power-assisted brakes.

**I** The brake system consists of 2 individual hydraulic systems: if one of the systems fails, the other will still operate. In this case, the brake pedal should be depressed more firmly than usual and braking distance becomes longer.

Do not drive your vehicle with only a single brake system. Have your brakes fixed immediately.



 NOTICE

**n While driving the vehicle**

Do not use the accelerator pedal or depress accelerator and brake pedals together to hold the vehicle on a hill.

**n When parking the vehicle**

Always put the shift lever in "P". Failure to do so may cause the vehicle to move or the vehicle may accelerate suddenly if the accelerator pedal is accidentally depressed.

**n Avoiding damage to vehicle parts**

**I** Do not turn the steering wheel fully in either direction and hold it there for a long time.

Doing so may damage the power steering pump.

**I** When driving over bumps in the road, drive as slowly as possible to avoid damaging the wheels, underside of the vehicle, etc.

**n If you hear a squealing or scraping noise (brake pad wear limit indicators)**

Have your Toyota dealer check and replace the brake pads as soon as possible.

The rotor damage can result if the pads are not replaced when needed.

It is dangerous to drive the vehicle when the wear limits of the brake pads and/or that of the brake discs are exceeded.

 NOTICE

**n If you get a flat tire while driving**

A flat or damaged tire may cause the following situations. Hold the steering wheel firmly and gradually press the brake pedal to slow down the vehicle.

- | It may be difficult to control your vehicle.
- | The vehicle will make abnormal sounds.
- | The vehicle will behave abnormally.

Replace a flat tire with a new one. ( P. 463)

**n When encountering flooded roads**

Do not drive on a road that has flooded after heavy rain etc. Doing so may cause the following serious damage to the vehicle.

- | Engine stalling
- | Short in electrical components
- | Engine damage caused by water immersion

In the event that you drive on a flooded road and the vehicle is flooded, be sure to have your Toyota dealer check the following.

- | Brake function
- | Changes in quantity and quality of oil and fluid used for the engine, transmission, transfer, differentials, etc.
- | Lubricant condition for the propeller shaft, bearings and suspension joints (where possible) and the function of all joints, bearings, etc.

## 2-1. Driving procedures

### Engine (ignition) switch

Modes can be switched by pressing the “ENGINE START STOP” switch when carrying the electronic key on your person. (The engine can be started in any mode by operating the switch at the same time as depressing the brake pedal.)

#### n Changing engine (ignition) switch mode

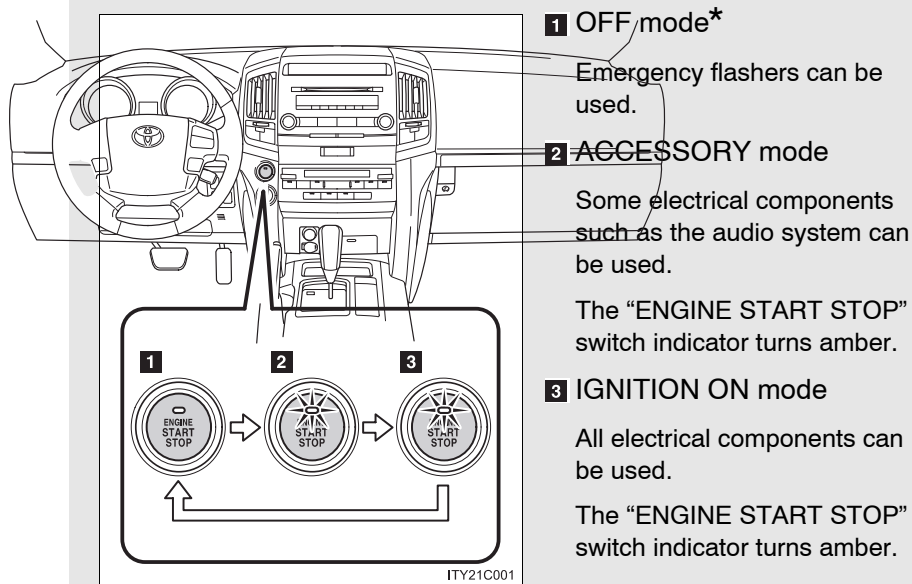

\*: If the shift lever is in a position other than “P” when turning off the engine, the “ENGINE START STOP” switch will be turned to ACCESSORY mode, not to OFF mode.

n **Starting the engine**

**STEP 1** Check that the parking brake is set.

**STEP 2** Check that the shift lever is set in “P”.

**STEP 3** Sit in the driver’s seat and firmly depress the brake pedal.

The “ENGINE START STOP” switch indicator turns green.

**STEP 4**

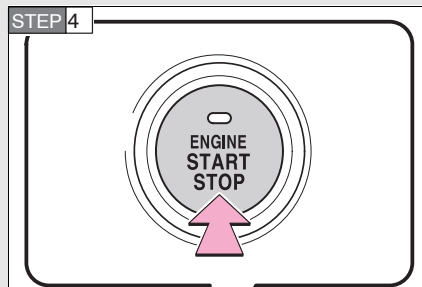

Press the “ENGINE START STOP” switch.

Continue depressing the brake pedal until the engine is completely started. The engine will crank until it starts or for up to 30 seconds, whichever is less.

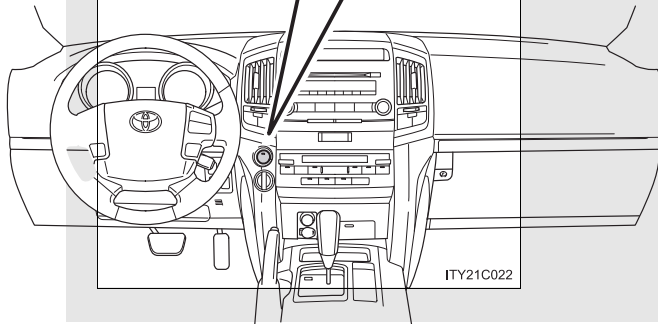

ITY21C022

ⓘ **When the steering lock cannot be released**

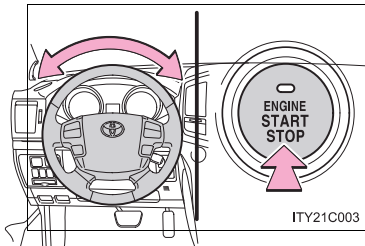

The green indicator light on the “ENGINE START STOP” switch will flash and a message will be shown on the multi-information display. Press the “ENGINE START STOP” switch again while turning the steering wheel left and right.

ⓘ **If the engine does not start**

The engine immobilizer system may not have been deactivated. ( P. 93)

ⓘ **When the “ENGINE START STOP” switch indicator flashes in amber**

The system may be malfunctioning. Have the vehicle inspected by your Toyota dealer immediately.

ⓘ **Auto power off function**

If the vehicle is left in ACCESSORY mode for more than an hour with the shift lever in “P”, the “ENGINE START STOP” switch will automatically turn off.

ⓘ

P. 32

ⓘ

P. 481

ⓘ

P. 30

ⓘ

P. 33

 CAUTION

**n When starting the engine**

Always start the engine while sitting in the driver's seat. Do not depress the accelerator while starting the engine under any circumstances. Doing so may cause an accident resulting in death or serious injury.

**n Caution when driving**

Do not touch the "ENGINE START STOP" switch while driving. Pressing and holding the "ENGINE START STOP" switch will stop the engine, which may lead to an unexpected accident.

 NOTICE

**n To prevent battery discharge**

Do not leave the "ENGINE START STOP" switch in ACCESSORY or IGNITION ON mode for long periods without the engine running.

**n When starting the engine**

- l** Do not race a cold engine.
- l** If the engine becomes difficult to start or stalls frequently, have the engine checked immediately.

2-1. Driving procedures  
Automatic transmission

Select a shift position appropriate for the driving conditions.

n Shifting the shift lever

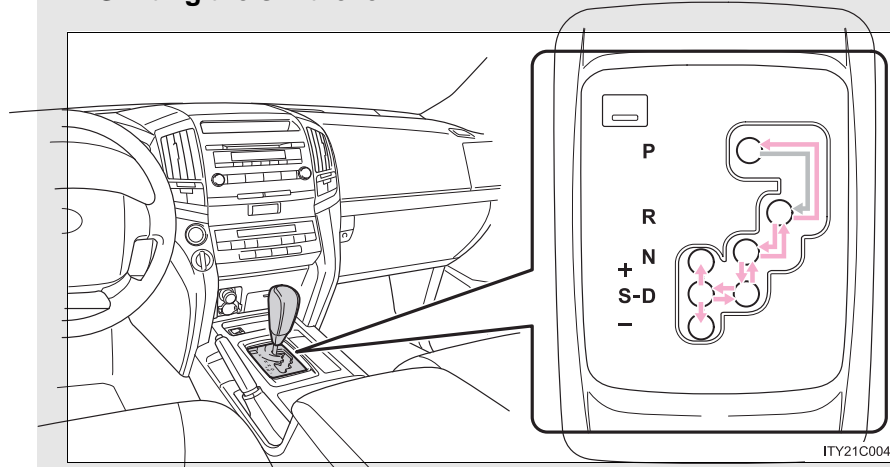

← While the “ENGINE START STOP” switch is in IGNITION ON mode, depress the brake pedal and move the shift lever.

n **Shift position uses**

Shift position	Function
P	Parking the vehicle or starting the engine
R	Reversing
N	Neutral
D	Normal driving*1
S	"S" mode driving *2

\*1: To improve fuel consumption and reduce noises, set the shift lever in the "D" position for normal driving.

\*2: By selecting shift ranges using "S" mode, you can control engine braking forces.

n **Selecting a driving mode**

The following patterns can be selected to suit current driving and operating conditions.

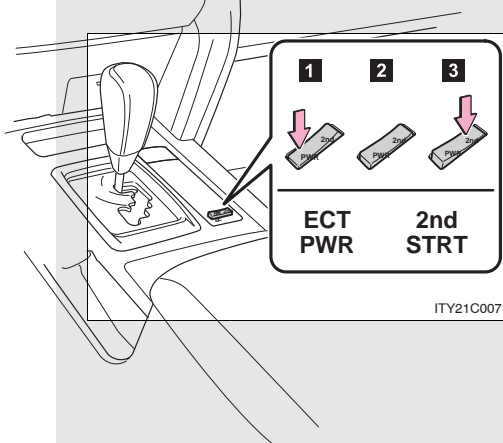

**1 Power mode**

For powerful acceleration and driving in mountainous regions.

**2 Normal mode**

**3 Second start mode**

For starting on slippery road surfaces, such as on snow.

Press "2nd" to return to normal mode.



**Changing shift ranges in “S” mode**

Shift the shift lever to the “S” position and operate the shift lever.

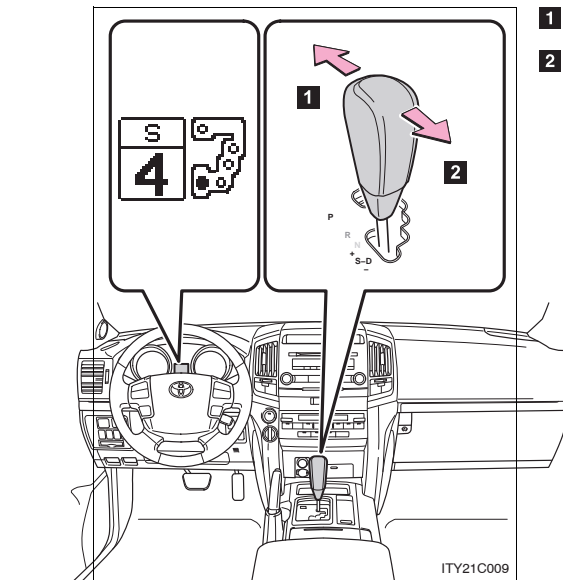

- 1** Upshifting
- 2** Downshifting

The initial shift range in “S” mode is automatically set to “5” or “4” according to the vehicle’s speed. However, the initial shift range may be set to “3” or “2” if the AI-SHIFT has operated while the shift lever was in the “D” position. ( P. 157)

2  
When driving

n **Shift ranges and their functions**

Shift range	Function
6	Automatically selecting gears between 1 and 6 according to vehicle speed and driving conditions.
5	Automatically selecting gears between 1 and 5 according to vehicle speed and driving conditions.
4	Automatically selecting gears between 1 and 4 according to vehicle speed and driving conditions.
3	Automatically selecting gears between 1 and 3 according to vehicle speed and driving conditions.
2	Automatically selecting gears between 1 and 2 according to vehicle speed and driving conditions.
1	Setting the gear at 1.

A lower shift range will provide greater engine braking force than a higher shift range, and the engine revolutions will also increase.

□ **“S” mode**

When the shift range is “5” or lower, holding the shift lever toward “+” sets the shift range to “6”.

□ **Downshifting restrictions warning buzzer (in the “S” mode)**

To help ensure safety and driving performance, downshifting operation may sometimes be restricted. In some circumstances, downshifting may not be possible even when the shift lever is operated. (The warning buzzer will sound twice.)

□ **When driving with the cruise control system**

The engine brake will not operate in the “S” mode, even when downshifting to “5” or “4”. ( P. 178)

□ **Second start mode automatic deactivation**

Second start mode is automatically deactivated if the engine is turned off after driving in second start mode.

□ **If the shift lever cannot be shifted from “P”**

P. 4 7 8

□ **If the “S” indicator does not come on even after shifting the shift lever to “S”**

This may indicate a malfunction in the automatic transmission system. Have the vehicle inspected by your Toyota dealer immediately.  
(In this situation, the vehicle will operate as if the shift lever is in “D”.)

□ **AI-SHIFT**

The AI-SHIFT automatically shifts the gear to the optimal position according to the driver performance and driving conditions.

The AI-SHIFT automatically operates when the shift lever is in the “D” position. (Shifting the shift lever to the “S” position cancels the function.)

## 2-1. Driving procedures

### Turn signal lever

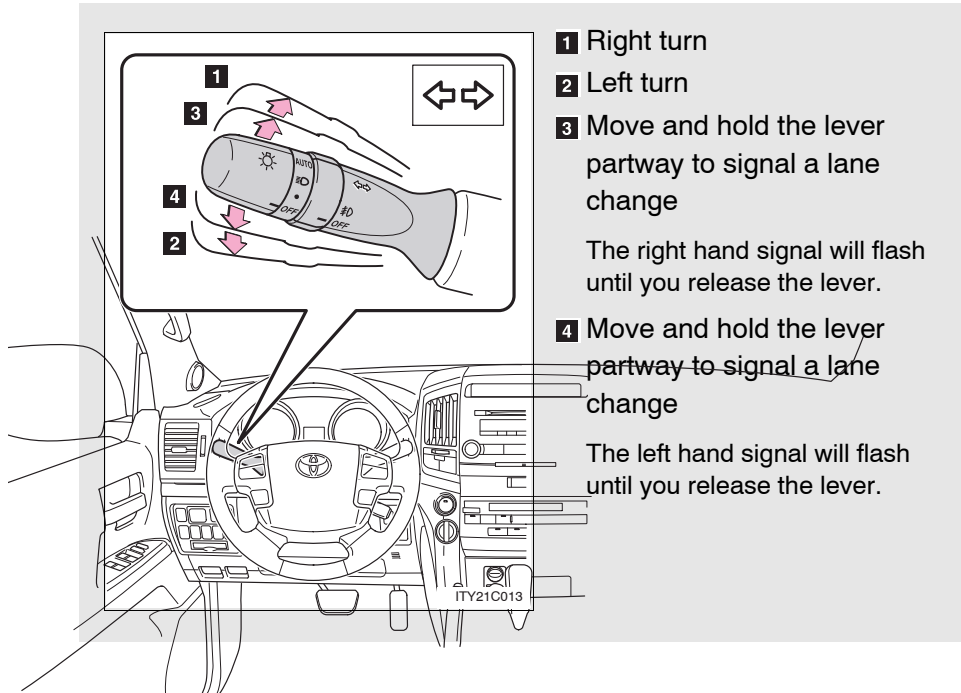

□ **Turn signals can be operated when**

The "ENGINE START STOP" switch is in IGNITION ON mode.

□ **If the indicators flash faster than usual**

Check that a light bulb in the front or rear turn signal lights has not burned out.

2-1. Driving procedures  
Parking brake

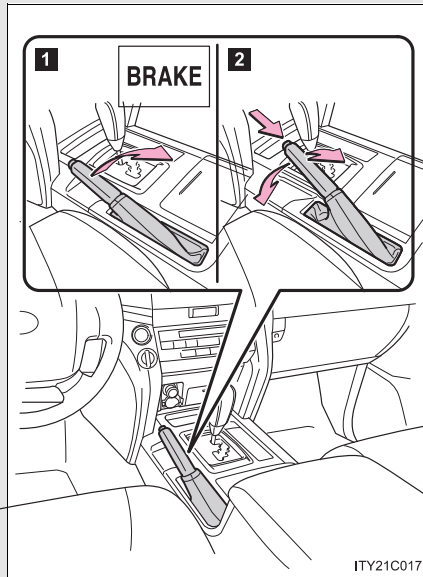

**1** Sets the parking brake

Fully set the parking brake while depressing the brake pedal.

**2** Releases the parking brake

Slightly raise the lever and lower it completely while pressing the button.

2

When driving

 NOTICE

**n Before driving**

Fully release the parking brake.

Driving the vehicle with the parking brake set will lead to brake components overheating, which may affect braking performance and increase brake wear.

## 2-2. Instrument cluster Gauges and meters

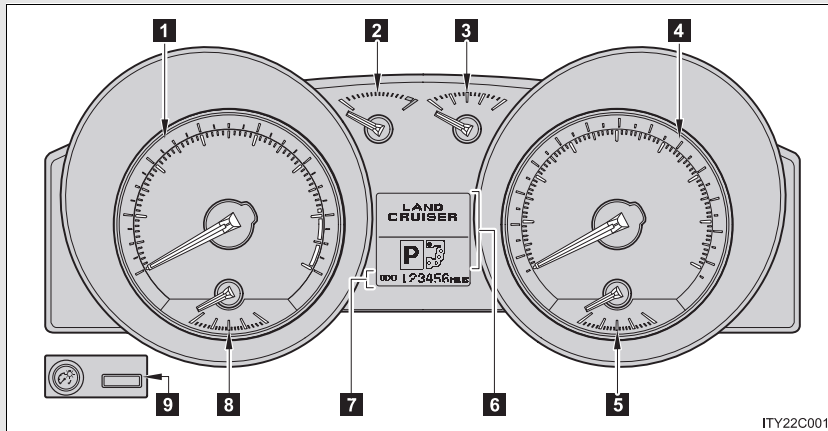

The following gauges, meters and display illuminate when the “ENGINE START STOP” switch is in IGNITION ON mode.

- 1** Tachometer  
Displays the engine speed in revolutions per minute.
- 2** Engine coolant temperature gauge  
Displays the engine coolant temperature.
- 3** Fuel gauge  
Displays the quantity of fuel remaining in the tank.
- 4** Speedometer  
Displays the vehicle speed.
- 5** Voltmeter  
Displays the charge state.
- 6** Multi-information display

P. 166

**7** Odometer and trip meter

Odometer: Displays the total distance the vehicle has been driven.

Trip meter: Displays the distance the vehicle has been driven since the meter was last reset. Trip meters A and B can be used to record and display different distances independently.

**8** Engine oil pressure gauge

Displays the engine oil pressure.

**9** Odometer/trip meter and trip meter reset button

Switches between odometer and trip meter displays. Pushing and holding the button will reset the trip meter when the trip meter is being displayed.

2

When driving

**Instrument panel light control**

The brightness of the instrument panel lights can be adjusted.

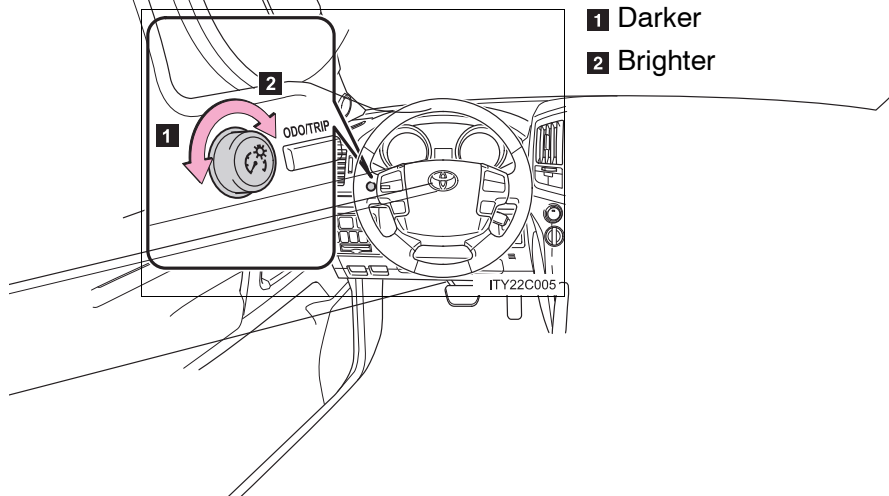

 NOTICE

**n To prevent damage to the engine and its components**

- I** Do not let the indicator needle of the tachometer enter the red zone, which indicates the maximum engine speed.
- I** The engine may be overheating if the engine coolant temperature gauge is in the red zone ("H"). In this case, immediately stop the vehicle in a safe place, and check the engine after it has cooled completely. ( P. 488)

**n While driving**

- I** When the voltmeter indicates more than 19 V or less than 9 V, the battery may be malfunctioning. Have your vehicle checked at your Toyota dealer.
- I** When the engine oil pressure gauge does not work properly, immediately stop the engine and contact your Toyota dealer.



## 2-2. Instrument cluster Indicators and warning lights

The indicator and warning lights on the instrument cluster and center panel inform the driver of the status of the vehicle's various systems.

### ► Instrument cluster

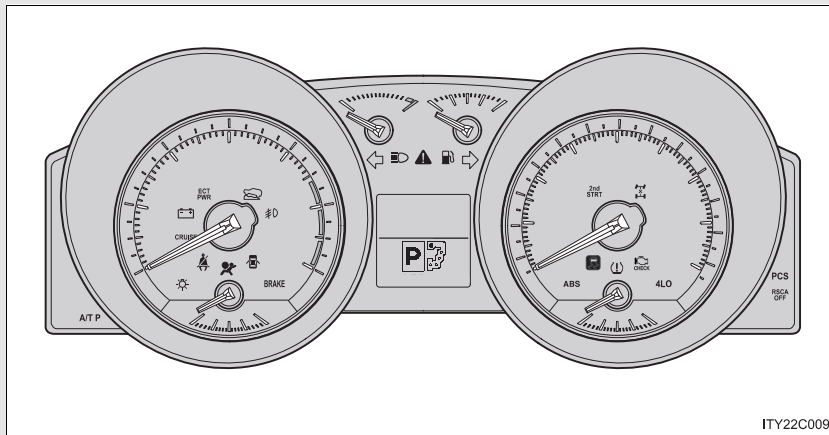



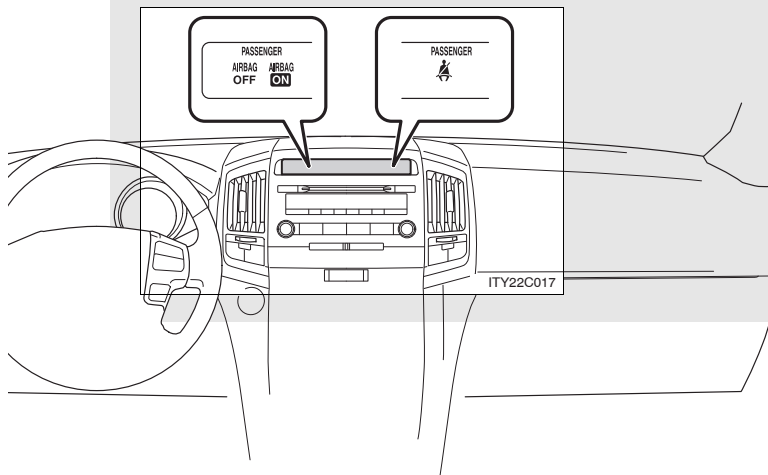









### ► Center panel



**n Indicators**

The indicators inform the driver of the operating state of the vehicle's various systems.

	Turn signal indicator ( P. 158)		* Roll sensing of curtain shield airbags off indicator ( P. 116)
	Headlight high beam indicator ( P. 170)		"PWR" mode indicator ( P. 154)
	Headlight indicator ( P. 170)		Automatic transmission second start indicator ( P. 154)
	Fog light indicator ( P. 172)		Low speed four-wheel drive indicator light ( P. 190)
	Cruise control indicator ( P. 178)		Center differential lock indicator ( P. 203)
	* Slip indicator ( P. 202)		* "AIR BAG ON/OFF" indicator ( P. 117)
	* Crawl control indicator ( P. 197)		

### n Warning lights

Warning lights inform the driver of malfunctions in the indicated vehicle's systems. ( P. 449)

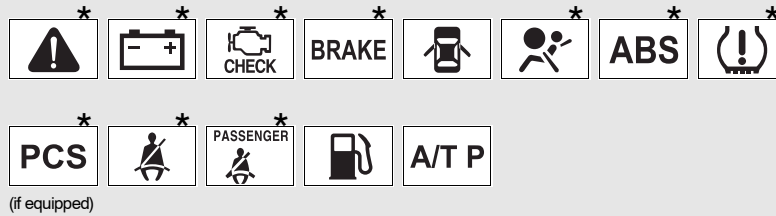

\*: These lights turn on when the “ENGINE START STOP” switch is turned to IGNITION ON mode to indicate that a system check is being performed. They will turn off after the engine is started, or after a few seconds. There may be a malfunction in a system if the lights do not come on, or if the lights do not turn off. Have the vehicle inspected by your Toyota dealer.

2

When driving

### ⚠ CAUTION

#### n If a safety system warning light does not come on

Should a safety system light such as Multi Terrain ABS and the SRS airbag warning lights not come on when you start the engine, this could mean that these systems are not available to help protect you in an accident, which could result in death or serious injury. Have the vehicle inspected by your Toyota dealer immediately if this occurs.

## 2-2. Instrument cluster

### Multi-information display

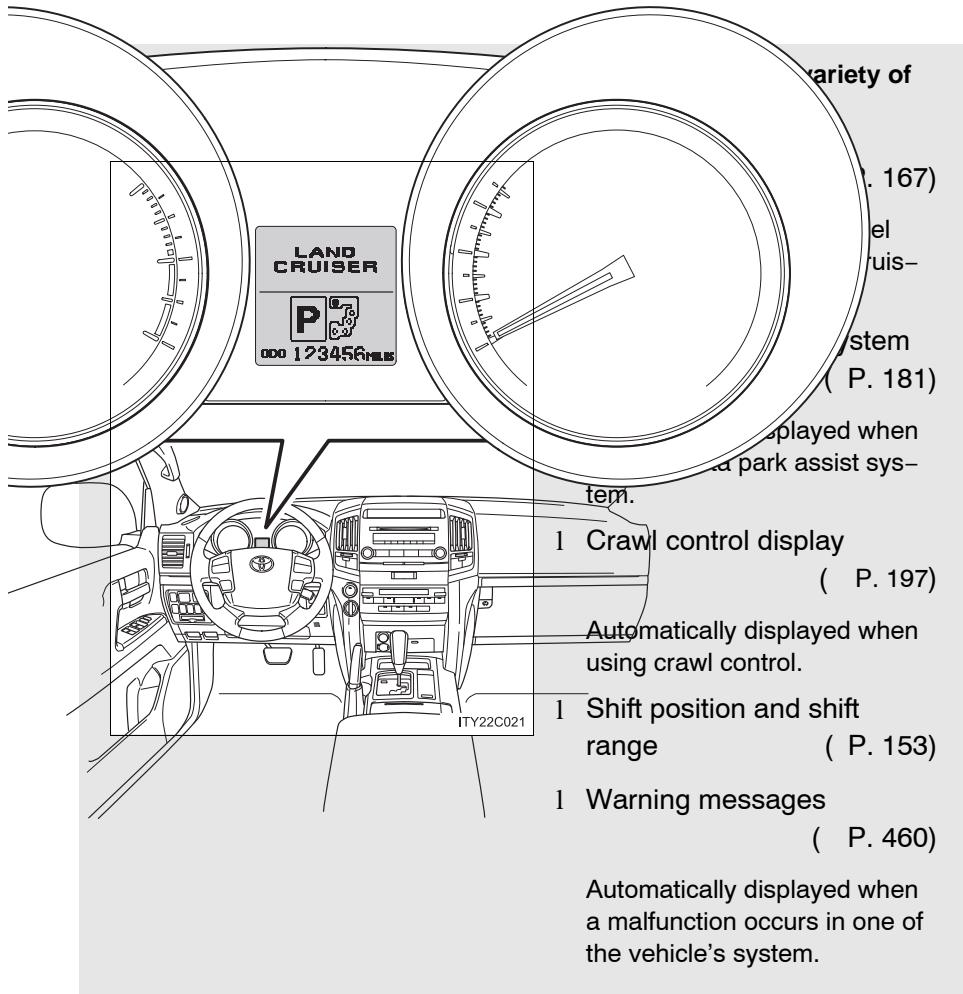

**Switch the display**

Display items can be switched by pressing the "DISP" button.

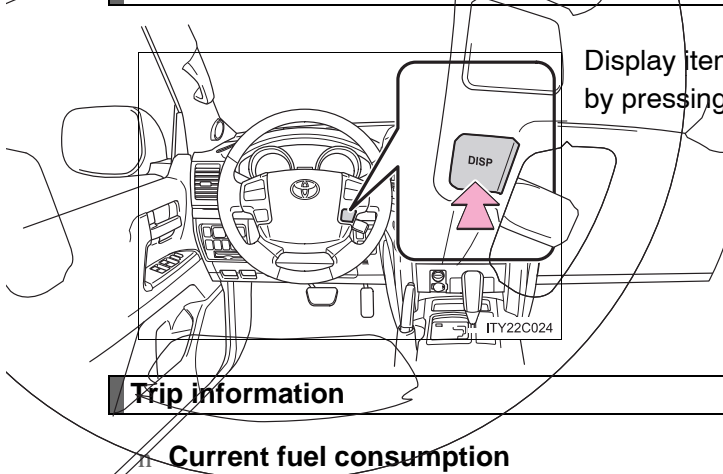

**Trip information**

**n Current fuel consumption**

Displays the current rate of fuel consumption.

**n Average fuel consumption**

Displays the average fuel consumption since the vehicle was last refueled.

n **Driving range**

Displays the estimated maximum distance that can be driven with the quantity of fuel remaining.

I This distance is computed based on your average fuel consumption. As a result, the actual distance that can be driven may differ from that displayed.

I When only a small amount of fuel is added to the tank, the display may not be updated.

n **Average vehicle speed**

Displays the average vehicle speed since the engine was started.

n **Driving distance**

Displays the driving distance since the engine was started.

n **Tire inflation pressure (If equipped)**

Displays inflation pressure of each tire. There is no correlation between the order of the displayed values and the tire positions.

It may take a few minutes to display the tire inflation pressure after the "ENGINE START STOP" switch is turned to IGNITION ON mode. It may also take a few minutes to display the tire inflation pressure after inflation pressure has been adjusted.

■ **System check display**

After switching the “ENGINE START STOP” switch to IGNITION ON mode, “LAND CRUISER” is displayed while system operation is checked. When the system check is complete, the normal screen will return.

■ **Tire inflation pressure**

Tire inflation pressure changes with temperature. The displayed values may also be different from the values measured using other gauges.

■ **Liquid crystal display**

Small spots or light spots may appear on the display. This phenomenon is characteristic of liquid crystal displays, and there is no problem to continue using the display.

 **NOTICE**

■ **The multi-information display at low temperatures**

Allow the interior of the vehicle to warm up before using the liquid crystal information display. At extremely low temperatures, the information display monitor may respond slowly, and display changes may be delayed.

## 2-3. Operating the lights and wipers Headlight switch

The headlights can be operated manually or automatically.

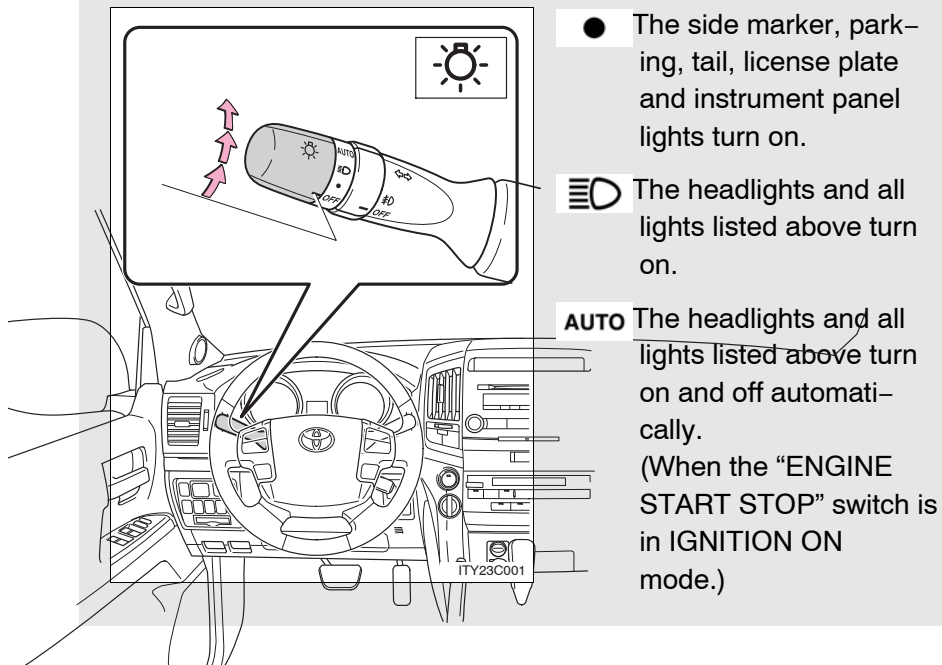

### Turning on the high beam headlights

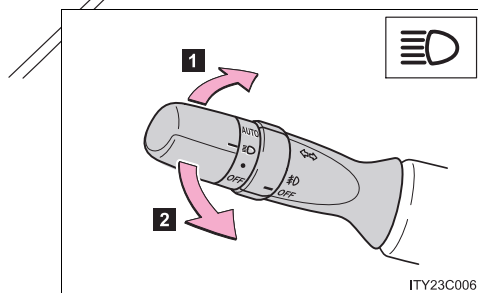

- 1 With the headlights on, push the lever forward to turn on the high beams.

Pull the lever back to the center position to turn the high beams off.

- 2 Pull the lever toward you to turn on the high beams.

Release the lever to turn them off. You can flash the high beams with the headlights on or off.



### n Daytime running light system

To make your vehicle more visible to other drivers, the headlights turn on automatically (at a reduced intensity) whenever the engine is started and the parking brake is released. Daytime running lights are not designed for use at night.

### n Headlight control sensor

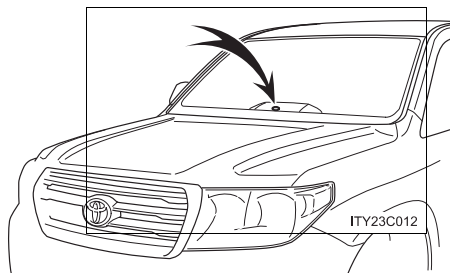

The sensor may not function properly if an object is placed on the sensor, or anything that blocks the sensor is affixed to the windshield.

Doing so interferes with the sensor detecting the level of ambient light and may cause the automatic headlight system to malfunction.

2

When driving

### n Automatic light off system

- I When the headlights are on: The headlights and tail lights turn off 30 seconds after a door is opened and closed if the “ENGINE START STOP” switch has been switched to ACCESSORY or OFF mode.
- I When only the tail lights are on: The tail lights turn off automatically if the “ENGINE START STOP” switch is switched to ACCESSORY or OFF mode and driver’s door is opened.

To turn the lights on again, turn the “ENGINE START STOP” switch to IGNITION ON mode, or turn the light switch off once and then back to the ● or ☰ position.

### n Customization

Settings (e.g. light sensor sensitivity) can be changed. ( P. 519)

### ⚠ NOTICE

#### n To prevent battery discharge

Do not leave the lights on longer than necessary when the engine is not running.

2-3. Operating the lights and wipers  
Fog light switch

The fog lights improve visibility in difficult driving conditions, such as in rain or fog. The fog lights can be used when the headlights are on low beam.

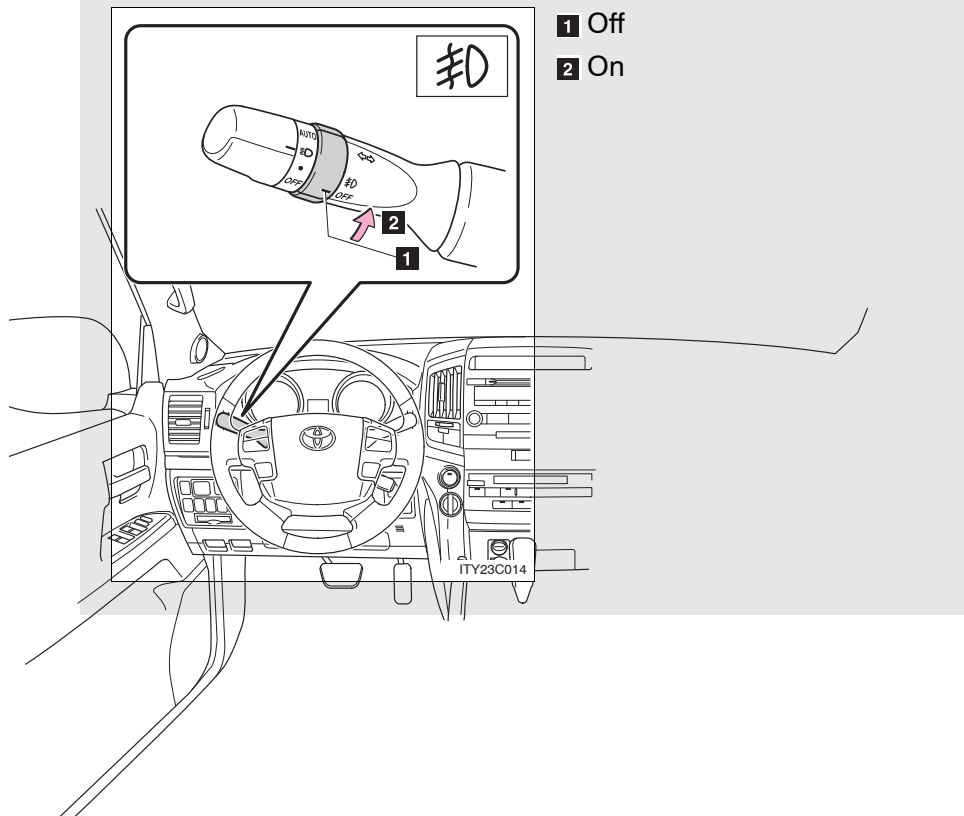

2-3. Operating the lights and wipers  
Windshield wipers and washer

Wiper intervals can be adjusted for intermittent operation (when "INT" is selected).

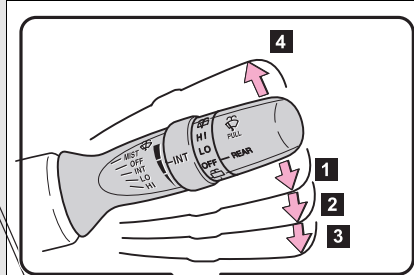

- 1 Intermittent wiper operation
- 2 Low speed wiper operation
- 3 High speed wiper operation
- 4 Temporary operation

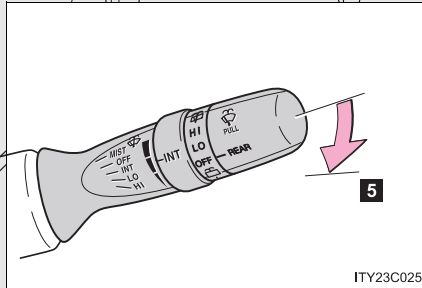
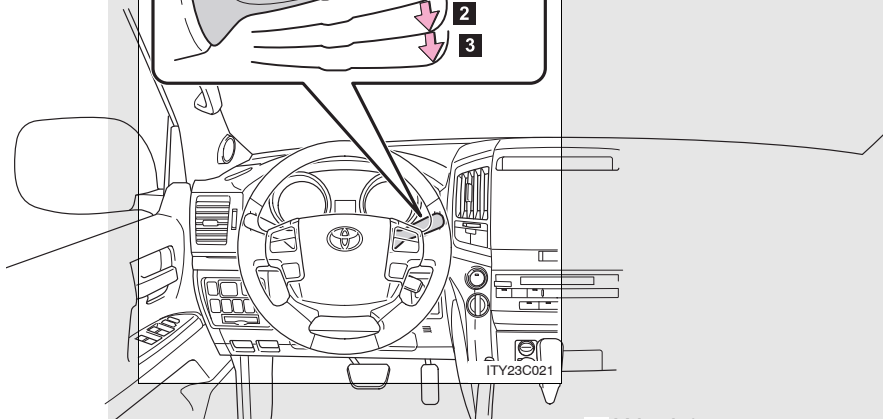

- 5 Wash/wipe operation  
Wipers operate automatically.

## 2-3. Operating the lights and wipers

- **The windshield wiper and washer can be operated when**  
The “ENGINE START STOP” switch is in IGNITION ON mode.
- **“INT” mode**

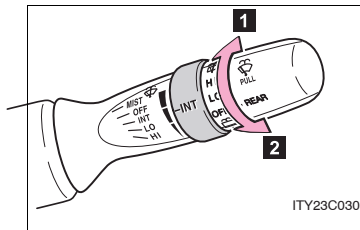

- 1** Intermittent wiper interval adjustment (increase)
- 2** Intermittent wiper interval adjustment (decrease)

- **If no windshield washer fluid sprays**  
Check that the washer nozzles are not blocked if there is washer fluid in the windshield washer fluid reservoir.
- **In extremely hot or cold weather**  
The system will turn off if the windshield gets extremely hot (at more than 176 F [80 C]) or cold (at less than -14 F [-10 C]).
- **Windshield wiper features**  
The rear window and outside rear view mirror defoggers automatically turn on when you operate the wipers.
- **Customization**  
Settings (e.g. drip prevention function) can be changed. ( P. 519)

 NOTICE

**n When the windshield is dry**

Do not use the wipers, as they may damage the windshield.

**n When there is no washer fluid spray from the nozzle**

Damage to the washer fluid pump may be caused if the lever is pulled toward you and held continually.

**n When a nozzle becomes block**

Do not try to clear it with a pin or other object. The nozzle will be damaged.

## 2-3. Operating the lights and wipers

### Rear window wiper and washer

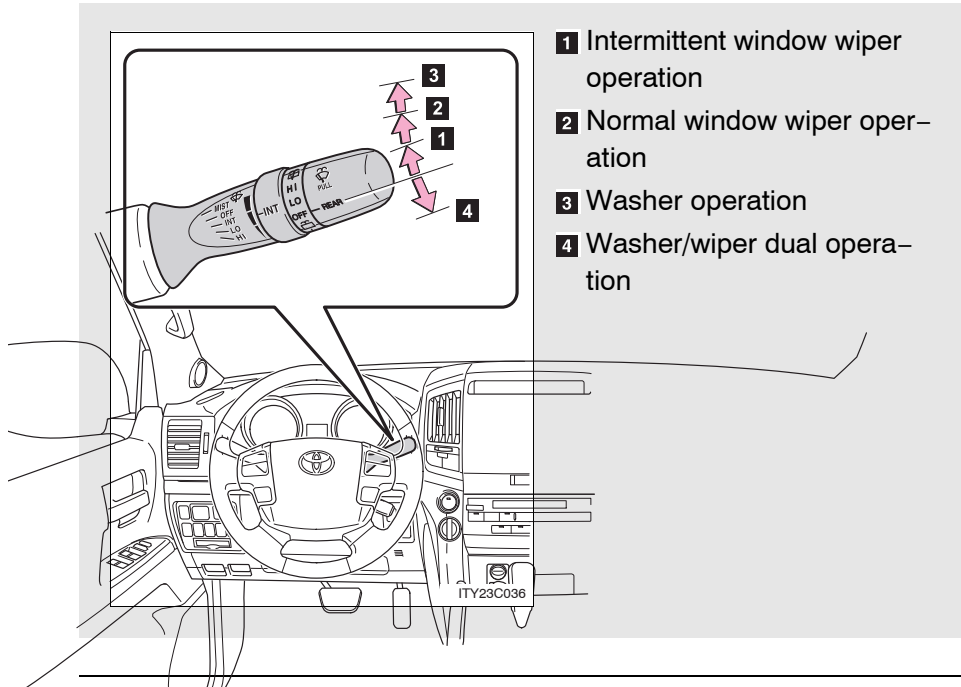

- **The rear window wiper and washer can be operated when**  
The "ENGINE START STOP" switch is in IGNITION ON mode.

#### NOTICE

- **When the rear window is dry**  
Do not use the wipers, as they may damage the rear window.

2-3. Operating the lights and wipers  
Headlight cleaner switch (if equipped)

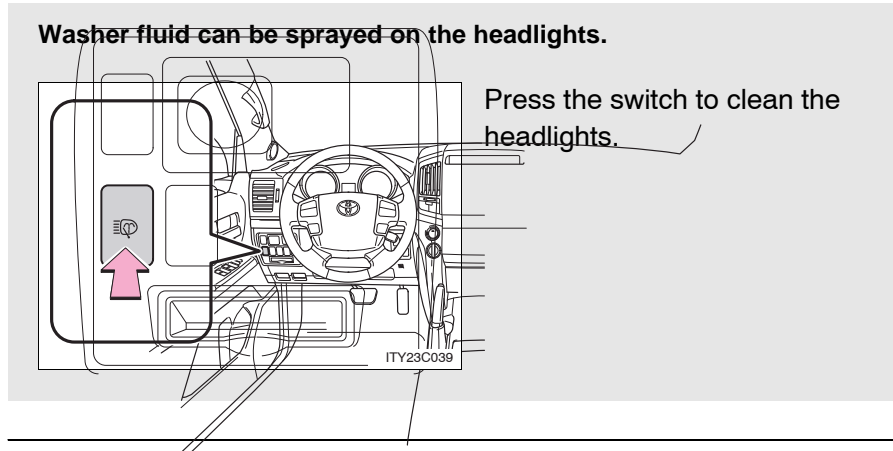

2

When driving

**n The headlight cleaner can be operated when**

The “ENGINE START STOP” switch is in IGNITION ON mode and the headlight switch is turned on.

**⚠ NOTICE**

**n When the washer fluid tank is empty**

Do not use this function when the washer fluid tank is empty. This may cause the washer fluid pump to overheat.

2-4. Using other driving systems  
Cruise control

Use the cruise control to maintain a set speed without using the accelerator.

**n Set the vehicle speed**

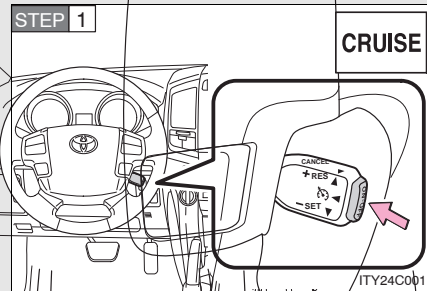

Press the "ON-OFF" switch to operate the cruise control.

Press the switch once more to deactivate the cruise control.

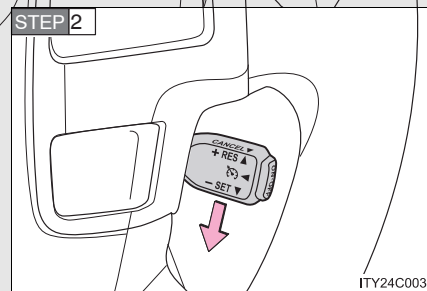

Accelerate or decelerate to the desired speed and push the lever down to set the cruise control speed.

**n Adjusting the speed setting**

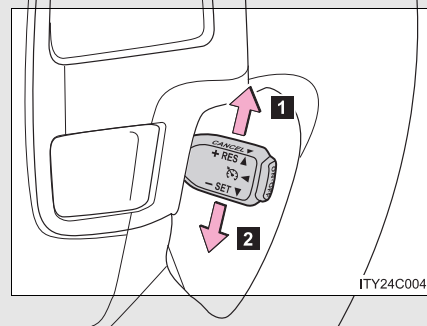

**1** Increase speed

**2** Decrease speed

Hold the lever until the desired speed setting is obtained.

Fine adjustment of the set speed (approximately 1.0 mph [1.6 km/h]) can be made by lightly pushing the lever up or down and releasing it.



### Canceling and resuming regular acceleration

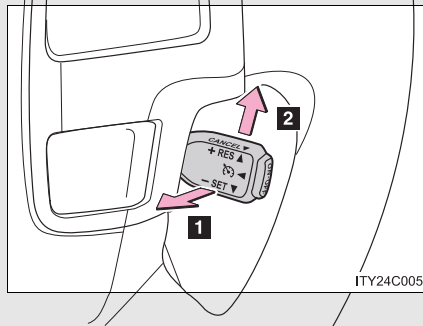

#### 1 Cancel

Push the lever towards you to cancel cruise control.

The speed setting is also canceled when the brakes are applied.

#### 2 Resume

To resume cruise control and return to the set speed, push the lever up.

2

When driving

#### When Cruise control can be set when

- 1 The shift lever is in the "D" or "4", "5" or "6" range of "S".
- 1 Vehicle speed is more than approximately 25 mph (40 km/h).

#### When Accelerating

The vehicle can be accelerated normally. After acceleration, the set speed resumes.

#### When Automatic cruise control cancelation

The set speed is automatically canceled in any of the following situations.

- 1 Actual vehicle speed falls more than 10 mph (16 km/h) below the preset vehicle speed.  
At this time, the memorized set speed is not retained.
- 1 Actual vehicle speed is below 25 mph (40 km/h).
- 1 VSC is activated.

**n If the cruise control indicator light flashes**

Turn the “ON-OFF” button off once, and then reactivate the system.

If the cruise control speed cannot be set or if the cruise control cancels immediately after being activated, there may be a malfunction in the cruise control system. Contact your Toyota dealer, and have your Toyota inspected.

**⚠ CAUTION**

**n To avoid operating the cruise control by mistake**

Keep the “ON-OFF” button off when not in use.

**n Situations unsuitable for cruise control**

Do not use cruise control in any of the following situations.

Doing so may result in control of the vehicle being lost and could cause serious or fatal accident.

**I** In heavy traffic

**I** On roads with sharp bends

**I** On slippery roads, such as those covered with rain, ice or snow

**I** On steep hills

Vehicle speed may exceed the set speed when driving down a steep hill.

**I** On winding roads

## 2-4. Using other driving systems

### Toyota park assist system (if equipped)

Toyota park assist system uses sensors in the corners and rear of the vehicle to detect the distance between the vehicle and any obstacles, and informs the driver of this distance using the multi-information display, the touch screen, and warning beeps.

#### ■ Sensor types

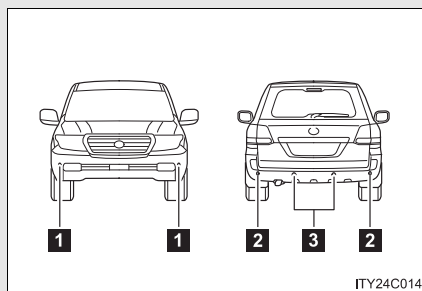

- 1 Front corner sensors
- 2 Rear corner sensors
- 3 Back sensors

#### ■ Toyota park assist system switch

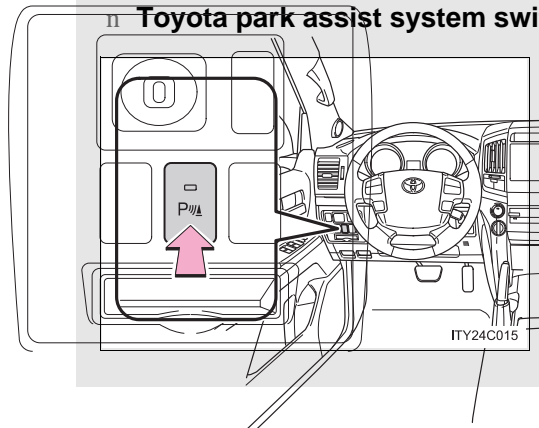

#### On/off

To turn the system on, press the switch. The indicator light comes on to inform the driver that the system is operational.

To turn the system off, press the switch again.

n **Multi-information display**

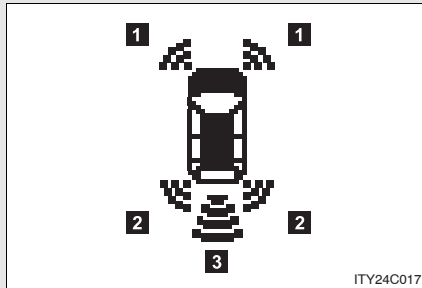

- 1 Front corner sensor detection
- 2 Rear corner sensor detection
- 3 Back sensor detection

n **Touch screen (with navigation system)**

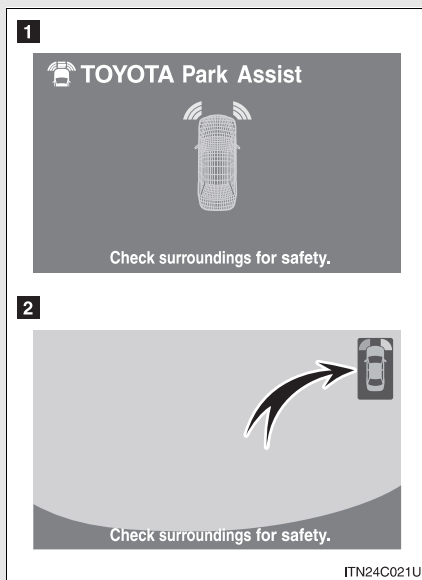

- 1 When the vehicle is moving forward







The graphic is automatically displayed when an obstacle is detected. The screen can be set so that the graphic is not displayed. ( P. 187)

- 2 When the vehicle is moving backward (insert display)

A simplified image is displayed on the touch screen when an obstacle is detected.

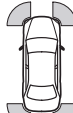
**Sensor detection display, obstacle distance**

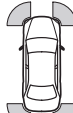

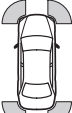





**n Corner sensors**

Approximate distance to obstacle	Multi-information display	Touch screen	
			Insert display
Front: 2.0 ft. (60 cm) to 1.6 ft. (47.5 cm) Rear: 2.0 ft. (60 cm) to 1.1 ft. (37.5 cm)	 (continuous)	 (continuous)	 (blinking)
Front: 1.6 ft. (47.5 cm) to 1.1 ft. (35 cm) Rear: 1.1 ft. (37.5 cm) to 1.0 ft. (30 cm)	 (continuous)	 (continuous)	 (blinking rapidly)
Front: Less than 1.1 ft. (35 cm) Rear: Less than 1.0 ft. (30 cm)	 (blinking)	 (continuous)	 (continuous)

2  
When driving

2-4. Using other driving systems

n **Back sensors**

Approximate distance to obstacle	Multi-information display	Touch screen (insert display)
5.0 ft. (150 cm) to 2.0 ft. (60 cm)	 (continuous)	 (blinking slowly)
2.0 ft. (60 cm) to 1.4 ft. (45 cm)	 (continuous)	 (blinking)
1.4 ft. (45 cm) to 1.1 ft. (35 cm)	 (continuous)	 (blinking rapidly)
Less than 1.1 ft. (35 cm)	 (blinking)	 (continuous)

### Beeps and obstacle distance

A beep sounds when the corner sensors and back sensors are operating.

- I The beep sounds faster as the vehicle approaches an obstacle. When the vehicle comes within the following distance of the obstacle, the beep sounds continuously.
  - Front corner and back sensors: Approximately 1.1 ft. (35 cm)
  - Rear corner sensors: Approximately 1.0 ft. (30 cm)
- I When two or more obstacles are detected simultaneously, the beep system responds to the nearest obstacle. If one or both come within the above distances, the beep will repeat a long tone, followed by fast beeps.
- I You can change the volume of the warning beeps. ( P. 187)

2

When driving

### Obstacle detection range

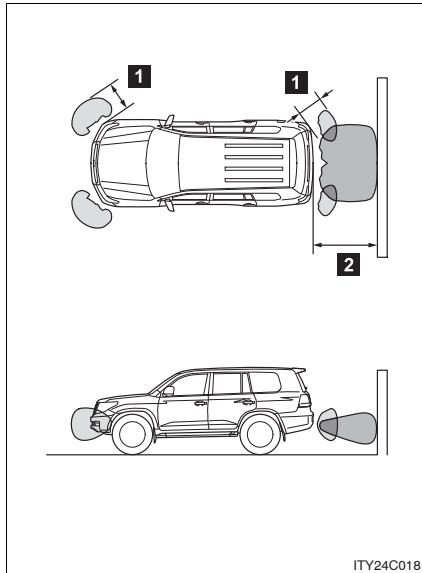

**1** About 1.8 ft. (60 cm)

**2** About 5.0 ft. (150 cm)

The detection area of the sensors is shown to the left. If obstacles move too close to the sensors, they will not be detected.

The range of the sensors may change depending on the shape of the object etc.

### Warning beep volume and touch screen settings (vehicles with navigation system only)

You can change the warning beep volume and touch screen operating conditions.

**STEP 1** Press  to display the "Information" screen.

**STEP 2** To use 



**n Changing the warning beep volume**

- STEP 1** Touch **Volume**
- STEP 2** Adjust the beep volume, then touch **OK**.

**n Changing display and alert settings**

- STEP 1** Touch **Distance**
- STEP 2** Touch **Rear** to change the distance for the back sensors display and tone indication, then touch **OK**.

**n Display off setting**

Touch **Display OFF**

When an obstacle is detected while the rear view monitor is in use, the warning indicator will appear in the top right of the screen even

**Display OFF** has been selected.

2

When driving

**n The Toyota park assist system can be operated when**

- l Front corner sensors:
- The “ENGINE START STOP” switch is in IGNITION ON mode.
  - The shift lever is in a position other than “P”.
  - The vehicle speed is less than about 6 mph (10 km/h).
- l Rear corner and back sensors:
- The “ENGINE START STOP” switch is in IGNITION ON mode.
  - The shift lever is in “R”.

**n Sensor detection information**

- 1 Certain vehicle conditions and the surrounding environment may affect the ability of the sensor to correctly detect obstacles. Particular instances where this may occur are listed below.
  - There is dirt, snow or ice on the sensor. (Wiping the sensor will resolve this problem.)
  - The sensor is frozen. (Thawing the sensor will resolve this problem.)
  - The sensor is covered in any way.
  - In harsh sunlight or intense cold weather.
  - When driving on bumpy, sloped or gravel roads, or over grass.
  - If there is something producing ultrasonic waves nearby, such as another vehicle's horn, motorcycle engine noise, air braking sound from heavy-duty vehicles, or another vehicle using the park assist system.
  - In heavy rain, or if water is splashed on the sensors.
  - The vehicle is leaning considerably to one side.
  - If a commercial fender pole or radio antenna is installed.
  - If moving towards a high curb or a curb corner.
  - If towing eyelet is installed on your vehicle.
  - The bumper or sensor receives a strong impact.
  - A non-genuine Toyota suspension (lowered suspension etc.) is installed.

In addition to the examples above, there are instances in which, because of their shapes, signs and other objects may be judged by the sensor to be closer than they are.

- 1 The shape of the obstacle may prevent the sensor from detecting it. Pay particular attention to the following obstacles.
  - Thin objects such as wire, fencing or rope.
  - Objects that absorb sound waves, such as cotton or snow.
  - Objects with sharp corners.
  - Low objects.
  - Objects where the upper section projects out over the lower section.

n

P. 460

n **Certification**

This device complies with Part 15 of the FCC Rules.  
Operation is subject to the following two conditions;  
(1) This device may not cause harmful interference, and  
(2) This device must accept any interference received, including interference that may cause undesired operation.

2

When driving

 **CAUTION**

n **When using the Toyota park assist system**

Observe the following precautions.

Failing to do so may result in the vehicle being unable to be driven safely and possibly cause an accident.

- I Do not use the sensor at speeds in excess of 6 mph (10 km/h).
- I When moving forward or reversing, always check your surroundings for safety and drive carefully.
- I Do not install accessories within the sensors' detection areas.

 **NOTICE**

n **When washing the vehicle**

Do not apply intensive bursts of water or steam to the sensor area.  
Doing so may result in the sensor malfunctioning.

## 2-4. Using other driving systems Four-wheel drive system

Use the four-wheel drive control switch and center differential lock/unlock switch to select the following transfer and center differential modes.

### n Four-wheel drive control switch

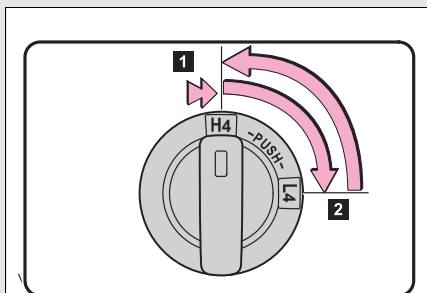

#### 1 "H4" (high speed position)

Normal driving on all types of roads.

#### 2 "L4" (low speed position)

Driving requiring maximum power and traction such as climbing or descending steep hills, off-road driving, and hard pulling in sand or mud, etc.

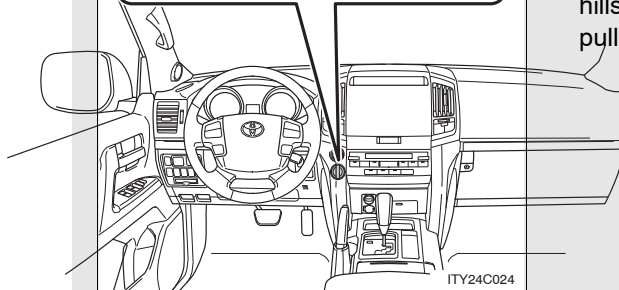

### n Center differential lock/unlock switch

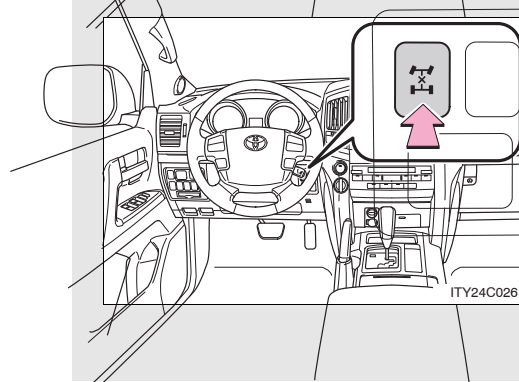

Lock the center differential when your vehicle's wheels get stuck in a ditch or when driving on a slippery or bumpy surface.

Unlock the center differential after the wheels have been freed, or after moving to a flat, non-slippery surface.

### Shifting between “H4” and “L4”

#### n Shifting from “H4” to “L4”

**STEP 1** Stop the vehicle completely.

**STEP 2** Shift the shift lever to “N”.

**STEP 3** Push and turn the four-wheel drive control switch fully clockwise.

Maintain this condition until the low speed four-wheel drive indicator light turns on.

#### n Shifting from “L4” to “H4”

**STEP 1** Stop the vehicle completely.

**STEP 2** Shift the shift lever to “N”.

**STEP 3** Turn the four-wheel drive control switch fully counterclockwise.

Maintain this condition until the low speed four-wheel drive indicator light turns off.

2

When driving

### Neutral position

Shifting to the neutral position cuts drive power to the wheels.

#### n Shifting from “H4” to the neutral position

**STEP 1** Stop the vehicle completely.

Make sure the vehicle is stopped in a safe place while carrying out the following procedure.

**STEP 2** Confirm the following:

1The four wheel-drive control switch is in “H4”. (The low speed four-wheel drive indicator light is not illuminated.)

If the switch is in “L4”, turn it to “H4”. ( P. 190)

1The center differential is unlocked. (The center differential lock indicator light is not illuminated.)

If the center differential is locked, press the center differential lock/unlock switch to unlock the center differential. ( P. 190)

**STEP 3** Set the parking brake firmly and put the shift lever in “N”.

**STEP 4** Turn the engine off if the engine is running, then turn the “ENGINE START STOP” switch to the IGNITION ON mode.

Do not start the engine till the end of the procedure.

**STEP 5** Shift the shift lever to “P”.

**STEP 6** Depress and release the brake pedal 3 times.

Depress the pedal firmly each time, then keep the pedal depressed the third time.

**STEP 7** Shift the shift lever to “N”.

**STEP 8** Depress and release the brake pedal 3 times.

Release the brake pedal once and then depress and release the brake pedal 3 times.

Depress the pedal firmly each time, then keep the pedal depressed the third time.

**STEP 9** Shift the four-wheel drive control switch to “L4”, then shift to “H4” again.

When shifting the four-wheel drive control switch, push the switch down while turning it.

The low speed four-wheel drive indicator light will flash slowly (turns on and off every 2 seconds).

**STEP 10** Shift the shift lever to “P”.

Shifting to the neutral position is completed with above procedure.

The unengaged “Park” warning light will turn on when the shift lever is shifted to the “P” position.

To return to “H4” when the vehicle is in this condition, carry out the following procedure.

#### **n Shifting from neutral position to “H4”**

**STEP 1** Stop the vehicle completely.

Make sure the vehicle is stopped in a safe place while carrying out the following procedure.

**STEP 2** Set the parking brake firmly.

**STEP 3** Turn the “ENGINE START STOP” switch to the IGNITION ON mode.

Do not start the engine at this time.

**STEP 4** Depress the brake pedal firmly.

Keep the brake pedal depressed till the end of the procedure.

**STEP 5** Shift the shift lever to “N”.

**STEP 6** Shift the four-wheel drive control switch to “L4”, and then shift to “H4” again.

When shifting the four-wheel drive control switch, push the switch down while turning it.

The low speed four-wheel drive indicator light will turn off.

Shifting to “H4” is completed when the low speed four-wheel drive indicator light turns off.

---

n **The four-wheel drive control switch can be operated when**

- l The “ENGINE START STOP” switch is in IGNITION ON mode.
- l The shift lever is in the “N” position.
- l The vehicle is stopped completely.

n **Advice for driving on slippery roads in “L4” (low speed position)**

- l If you shift the four-wheel drive control switch to “L4” and the shift lever to the “2” range of “S” while driving in steep off-road areas, the output of the brake can be controlled effectively by the active traction control system, which assists the driver to control the driving power of 4 wheels.
- l Use the “1” range of “S” of the shift lever for maximum power and traction when your wheels get stuck or when driving down a steep incline. In the following cases, the output of the brake can be controlled by the active traction control system if the engine speed is under 3,000 rpm (normally under 3,000 rpm when the wheels get unstuck).
  - The four-wheel drive control switch is in the “L4” position and the shift lever is in the “1” range of “S” or the shift lever is in “D” or “S” with the transmission downshifted to first gear.
  - The four-wheel drive control switch is in the “L4” position and the shift lever is in the “R” position.

n **The center differential lock/unlock button can be operated when**

- l The “ENGINE START STOP” switch is in IGNITION ON mode.
- l The vehicle speed is less than 60 mph (100 km/h).

n **Locking/unlocking the center differential**

- l When the center differential is locked, VSC (vehicle stability control) is automatically turned off. (The center differential lock and “VSC OFF” indicator lights come on.)
- l If the operation is not completed, the center differential lock indicator blinks. If the indicator light does not turn off when unlocking the center differential, drive straight ahead while accelerating or decelerating, or drive in reverse.
- l If the center differential lock/unlock is not completed within 5 seconds while the cruise control system is on, cancel the cruise control system.



**n If the low speed four-wheel drive indicator light or the center differential lock indicator light blinks**

- 1 If the low speed four-wheel drive indicator light continues to blink when using the four-wheel drive control switch, stop the vehicle completely, move the shift lever to “N” and operate the switch again.
- 1 If the shift lever is moved before the low speed four-wheel drive indicator light has turned on/off, a beep sounds and the transfer position may not successfully change. In this case, stop the vehicle completely, return the shift lever to “N” and operate the switch again.
- 1 If the engine coolant temperature is too low, the four-wheel drive control system may not be able to shift. When the engine is warmer press the switch again.

If the low speed four-wheel drive indicator light or the center differential lock indicator light continues to blink even after attempting the above, there may be a malfunction in the engine, the brake system or the four-wheel drive system. In this case, you may not be able to shift between “H4” and “L4”, and the center differential lock may not be operable. Have the vehicle inspected by your Toyota dealer immediately.

## 2-4. Using other driving systems

### CAUTION

#### **n While driving**

Never move the four-wheel drive control switch if the wheels have lost traction. Doing so may cause an accident resulting in death or serious injury.

### NOTICE

#### **n To prevent damage to the center differential**

- I** For normal driving on dry and hard surface roads, unlock the center differential.
- I** Unlock the center differential after the wheels are out of the ditch or off the slippery or bumpy surface.
- I** Do not push the center differential lock/unlock button when the vehicle is turning or when its wheels are spinning freely off the ground.

2-4. Using other driving systems  
Crawl control

Allows travel on extremely rough off-road surfaces at a fixed low speed without pressing the accelerator or brake pedal. Minimizes loss of traction or vehicle slip when driving on slippery road surfaces, allowing for stable driving.

n Crawl control switch

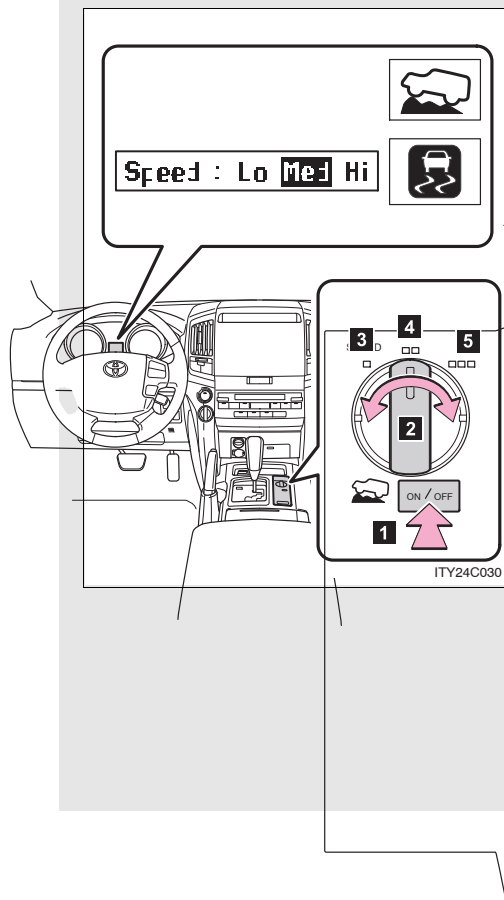

- 1 On/off**  
The crawl control indicator is lit and the slip indicator flashes when operating.
  - 2 Speed selection switch**
  - 3 Low mode**  
Effective when traveling on rocks and pebbles.\*
  - 4 Medium mode**  
Effective when traveling on snow mounds or descending a slope of rubble.\*
  - 5 High mode**  
Effective when ascending a slope of rubble, or traveling on snow, dirt, mud, sand, gravel, grass etc.\*
- \*: Depending on the road surface, may not be the most effective.

### **When the system is turned off**

If the system is turned off when crawl control is operating, a buzzer will sound for 3 seconds, the slip indicator turns off, and the crawl control indicator flashes until the system has turned off completely. When turning off crawl control while traveling, stop the vehicle before the crawl control indicator turns off, or drive extremely carefully.

---

#### **n The crawl control can be operated when**

- l The engine is running.
- l The shift lever is in any gear other than "P" or "N".
- l The four-wheel drive control switch is in "L4".
- l The parking brake is released.
- l The driver's door is closed.
- l When the driving mode is not set to second start mode.

**n Automatic system cancelation**

In the following situations, the system is canceled automatically, and the crawl control indicator will turn off:

- l When the shift lever is moved to “P”.
- l When the four-wheel drive control switch is in “H4”.

In the following situations, it is possible to descend a slope at a fixed low speed, however when traveling the system is canceled automatically, and the crawl indicator will turn off.

- l When the shift lever is moved to “N”.
- l When the vehicle speed exceeds 6 mph (10 km/h).
- l When the brake pedal is depressed firmly.
- l When the parking brake is engaged.
- l If the driver’s door is opened.
- l When the driving mode is set to second start mode.

**n If the brake system overheats**

The system will cease operation and a buzzer will sound to alert the driver. Stop the vehicle in a safe place. (There is no problem with continuing normal driving.)

**n If the automatic transmission system overheats**

The system will cease operation, a buzzer will sound and a warning message will be displayed to alert the driver. Stop the vehicle in a safe place until the warning message turns off.

## 2-4. Using other driving systems

### CAUTION

#### **n When using crawl control**

Do not rely overmuch on the crawl control. This function does not extend the vehicle's performance limitations. Always thoroughly check the road conditions, and drive safely.

#### **n Conditions under which the system may not operate correctly**

When driving on the following surfaces, the system may not be able to maintain a fixed low speed, which may result in an accident:

- l Extremely steep inclines.
- l Extremely uneven surfaces.
- l Snow-covered roads, or other slippery surfaces.

## 2-4. Using other driving systems

### Driving assist systems

To help enhance driving safety and performance, the following systems operate automatically in response to various driving situations. Be aware, however, that these systems are supplementary and should not be relied upon too heavily when operating the vehicle.

n **Multi Terrain ABS (Anti-lock Brake System)**

Restrains the vehicle from slipping when driving on sand, gravel, dirt, mud, snow, ice or slick road surfaces, or in the event of sudden braking.

n **Brake assist**

Generates an increased level of braking force after the brake pedal is depressed, when the system detects a panic stop situation.

n **VSC (Vehicle Stability Control)**

Helps the driver to control skidding when swerving suddenly or turning on slippery road surfaces.

n **Active TRAC (Traction Control)**

Maintains drive power and prevents the 4 wheels from spinning when starting the vehicle or accelerating on slippery roads.

n **Hill-start assist control**

Helps prevent the vehicle from rolling backwards when starting on an incline or slippery slope. It operates for approximately 5 seconds at maximum.

n **KDSS (Kinetic Dynamic Suspension System)**

KDSS enhances ride comfort and handling response by using a hydraulic control system to control the suspension stabilizer bars in response to road surface and driving conditions during cornering or off-road driving.

n **PCS (Pre-Collision System) (if equipped)**

P. 208

**When the VSC/Active TRAC/hill-start assist control systems are operating**

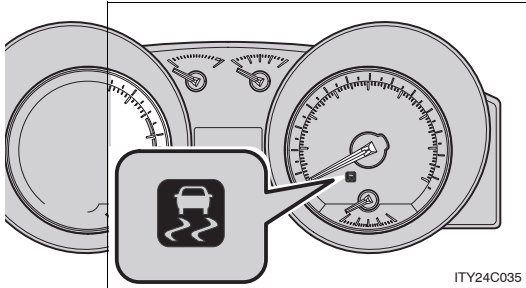

If the vehicle is in danger of slipping, rolling backwards when starting on an incline, or if the rear wheels spin, the slip indicator light flashes to indicate that the VSC/Active TRAC/hill-start assist control systems have been engaged.

A buzzer (intermittent) sounds to indicate that VSC is operating.

The stop lights and high mounted stoplight turn on when the hill-start assist control system is operating.





## 2-4. Using other driving systems

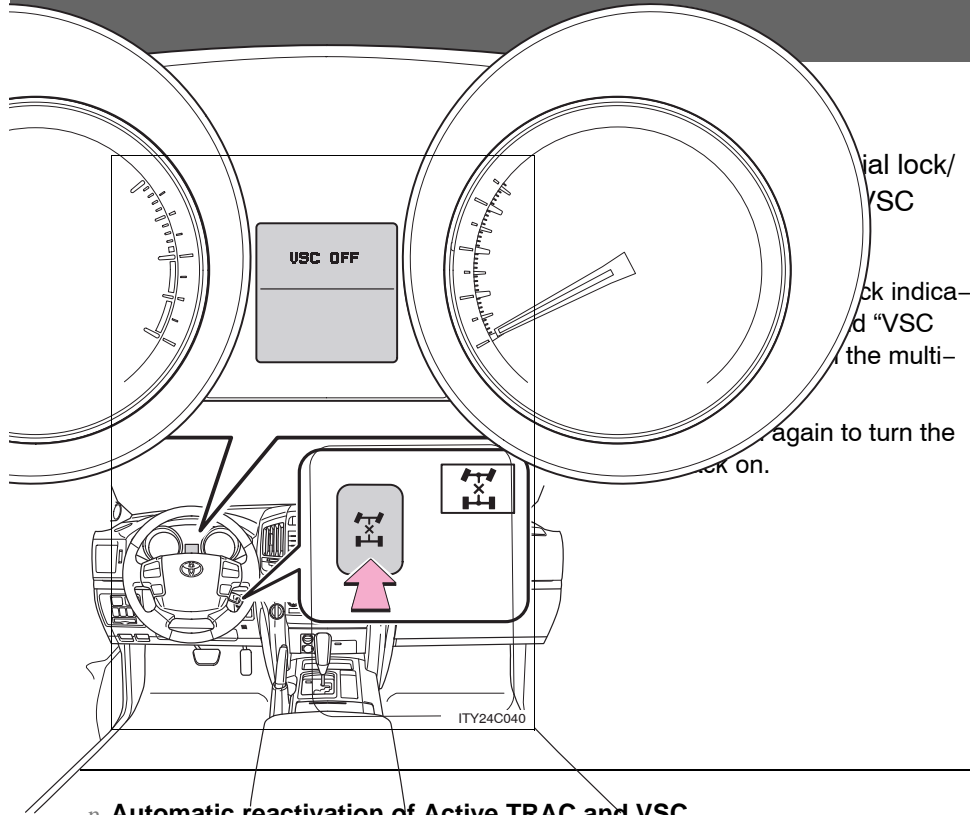

ial lock/  
VSC

ck indica-  
d "VSC"  
the multi-

again to turn the  
ck on.

### ■ Automatic reactivation of Active TRAC and VSC

Turning the "ENGINE START STOP" switch off after turning off the Active TRAC and VSC systems will automatically re-enable them.

### ■ Automatic Active TRAC reactivation

If only the Active TRAC system is turned off, the Active TRAC system will turn on when vehicle speed increases.

### ■ Automatic Active TRAC and VSC reactivation

If the Active TRAC and VSC systems are turned off, the systems will not turn on even when vehicle speed.

n **Sounds and vibrations caused by the Multi Terrain ABS, brake assist, Active TRAC, VSC and hill-start assist control**

- l A sound may be heard from the engine compartment when the engine is started or just after the vehicle begins to move. This sound does not indicate that a malfunction has occurred in any of these systems.
- l Any of the following conditions may occur when the above systems are operating. None of these indicates that a malfunction has occurred.
  - Vibrations may be felt through the vehicle body and steering.
  - A motor sound may be heard after the vehicle comes to a stop.
  - The brake pedal may pulsate slightly after the Multi Terrain ABS is activated.
  - The brake pedal may move down slightly after the Multi Terrain ABS is activated.

n **Hill-start assist control is operational when**

- l The shift lever is in "D" or "S".
- l The brake pedal is not depressed.

 CAUTION

Any of the following conditions may result in an accident which could cause death or serious injury:

**n The Multi Terrain ABS does not operate effectively when**

- l The limits of tire gripping performance have been exceeded.
- l The vehicle hydroplanes while driving at high speed on the wet or slick road.

**n Stopping distance when the Multi Terrain ABS is operating on the wet or slick roads**

The Multi Terrain ABS is not designed to shorten the vehicle's stopping distance. Always maintain a safe distance from the vehicle in front of you in the following situations.

- l When driving on dirt, gravel or snow-covered roads
- l When driving with tire chains
- l When driving over bumps in the road
- l When driving over roads with potholes or roads with uneven roads

**n Active TRAC may not operate effectively when**

Directional control and power may not be achievable while driving on slippery road surfaces, even if the Active TRAC is operating. Do not drive the vehicle in conditions where stability and power may be lost.

**n If the hill-start assist control does not operate effectively**

The hill-start assist control may not operate effectively on steep inclines and roads covered in ice.

**n When Active TRAC and VSC are off**

Be especially careful and drive at a speed appropriate to the road conditions. As there are systems to ensure vehicle stability and driving force, do not turn off Active TRAC and VSC unless necessary.

**⚠ CAUTION****n When the VSC is activated**

The slip indicator light flashes and a warning buzzer sounds. Always drive carefully. Reckless driving may cause an accident. Exercise particular care when the indicator light flashes and a buzzer sounds.

**n Replacing tires**

Make sure that all tires are of the same size, brand, tread pattern and total load capacity. In addition, make sure that the tires are inflated to the specified tire pressure level.

The Multi Terrain ABS and VSC will not function correctly if different tires are fitted on the vehicle.

Contact your Toyota dealer for further information when replacing tires or wheels.

2

When driving

**⚠ NOTICE****n KDSS**

In the following situations, there is the possibility that a system malfunction has occurred, and drive comfort and the vehicle's ability to travel on poor road surfaces may be reduced. Take the vehicle to your Toyota dealer immediately.

**I** When turning a corner, the vehicle's body seems to roll further than normal.

**I** If after the vehicle has been left in a slanted position for a long time, for example with the wheels of one side parked on a curb, the vehicle does not return to level when driving (the vehicle remains slanted to one side after returning the vehicle to level ground).

## Pre-Collision System (if equipped)

The system detects emergency braking from the speed and force with which the driver presses the brake pedal, and quickly tightens the seat belt to improve the effectiveness of the seat belt pretensioners ( P. 72). This system also operates in the same manner when the vehicle slips sideways.

---

**n The pre-collision system is operational when**

- l Vehicle speed exceeds 19 mph (30 km/h).
- l The system detects sudden braking or skidding.
- l The front occupants are wearing a seat belt.

**n When there is a malfunction in the system**

Warning message will be displayed on the multi-information display.  
( P. 460)

 **CAUTION**

**n Limitations of the pre-collision system**

Do not rely on the pre-collision system. Always drive safely, taking care to observe your surroundings and checking for any obstacles or other road hazards.

## Off-road precautions

This vehicle belongs to the utility vehicle class, which has higher ground clearance and narrower tread in relation to the height of its center of gravity to make it capable of performing in a wide variety of off-road applications.

### Off-road vehicle feature

- 1 Specific design characteristics give it a higher center of gravity than ordinary passenger cars. This vehicle design feature causes this type of vehicle to be more likely to rollover. And, utility vehicles have a significantly higher rollover rate than other types of vehicles.
- 1 An advantage of the higher ground clearance is a better view of the road allowing you to anticipate problems.
- 1 It is not designed for cornering at the same speeds as ordinary passenger cars any more than low-slung sports cars designed to perform satisfactorily under off-road conditions. Therefore, sharp turns at excessive speeds may cause rollover.

 CAUTION

**n Off-road vehicle precautions**

Always observe the following precautions to help minimize the risk of serious personal injury or damage to your vehicle:

- I** In a rollover crash, an unbelted person is significantly more likely to die than a person wearing a seat belt. Therefore, the driver and all passengers should fasten their seat belts whenever the vehicle is moving.
- I** Avoid sharp turns or abrupt maneuvers, if at all possible. Failure to operate this vehicle correctly may result in loss of control or vehicle rollover causing death or serious injury.
- I** Loading cargo on the roof luggage carrier will make the center of the vehicle gravity higher. Avoid high speeds, sudden starts, sharp turns, sudden braking or abrupt maneuvers, otherwise it may result in loss of control or vehicle rollover due to failure to operate this vehicle correctly.
- I** Always slow down in gusty crosswinds. Because of its profile and higher center of gravity, your vehicle is more sensitive to side winds than an ordinary passenger car. Slowing down will allow you to have better control.
- I** Do not drive horizontally across steep slopes. Driving straight up or straight down is preferred. Your vehicle (or any similar off-road vehicle) can tip over sideways much more easily than forward or backward.



**Off-road driving**

When driving your vehicle off-road, please observe the following precautions to ensure your driving enjoyment and to help prevent the closure of areas to off-road vehicles.

- 1 Drive your vehicle only in areas where off-road vehicles are permitted to travel.
- 1 Respect private property. Get owner's permission before entering private property.
- 1 Do not enter areas that are closed. Honor gates, barriers and signs that restrict travel.
- 1 Stay on established roads. When conditions are wet, driving techniques should be changed or travel delayed to prevent damage to roads.

2

When driving

**n Additional information for off-road driving**

- ▶ For owners in U.S. mainland, Hawaii and Puerto Rico:

To obtain additional information pertaining to driving your vehicle off-road, consult the following organizations.

- 1 State and Local Parks and Recreation Departments
- 1 State Motor Vehicle Bureau
- 1 Recreational Vehicle Clubs
- 1 U.S. Forest Service and Bureau of Land Management

 CAUTION

**n Off-road driving precautions**

Always observe the following precautions to help minimize the risk of serious personal injury or damage to your vehicle:

- I** Drive carefully when off the road. Do not take unnecessary risks by driving in dangerous places.
- I** Do not grip the steering wheel spokes when driving off-road. A bad bump could jerk the wheel and injure your hands. Keep both hands and especially your thumbs on the outside of the rim.
- I** Always check your brakes for effectiveness immediately after driving in sand, mud, water or snow.
- I** After driving through tall grass, mud, rock, sand, rivers, etc., check that there is no grass, bush, paper, rags, stone, sand, etc. adhering or trapped on the underbody. Clear off any such matter from the underbody. If the vehicle is used with these materials trapped or adhering to the underbody, a breakdown or fire could occur.
- I** When driving off-road or in rugged terrain, do not drive at excessive speeds, jump, make sharp turns, strike objects, etc. This may cause loss of control or vehicle rollover causing death or serious injury. You are also risking expensive damage to your vehicle's suspension and chassis.

 NOTICE

**n To prevent the water damage**

Take all necessary safety measures to ensure that water damage to the engine or other components does not occur.

- I** Water entering the engine air intake will cause severe engine damage.
- I** Water entering the automatic transmission will cause deterioration in shift quality, locking up of your transmission accompanied by vibration, and ultimately damage.
- I** Water can wash the grease from wheel bearings, causing rusting and premature failure, and may also enter the differentials, transmission and transfer case, reducing the gear oil's lubricating qualities.

**n When you drive through water**

If driving through water, such as when crossing shallow streams, first check the depth of the water and the bottom of the river bed for firmness. Drive slowly and avoid deep water.

**n Inspection after off-road driving**

- I** Sand and mud that has accumulated in brake drums and around brake discs may affect braking efficiency and may damage brake system components.
- I** Always perform a maintenance inspection after each day of off-road driving that has taken you through rough terrain, sand, mud, or water. For scheduled maintenance information, refer to the "Scheduled Maintenance Guide" or "Owner's Manual Supplement".

2-5. Driving information  
Cargo and luggage

**Take notice of the following information about storage precautions, cargo capacity and load.**

- 1 Stow cargo and luggage in the luggage compartment whenever possible. Be sure all items are secured in place.
- 1 Be careful to keep the vehicle level. Placing the weight as far forward as possible helps maintain vehicle balance.
- 1 For better fuel economy, do not carry unnecessary weight.

**n Roof luggage carrier**

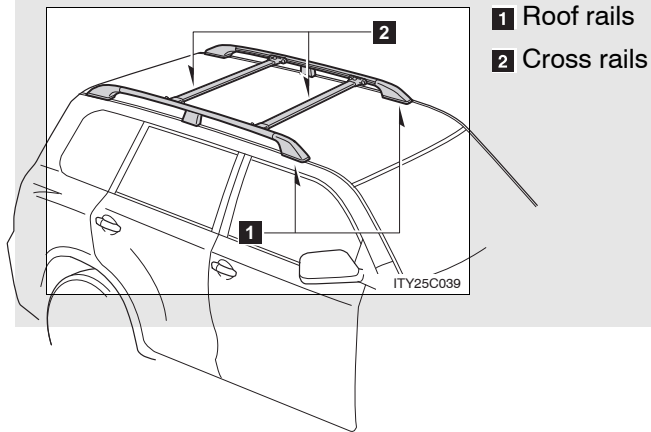

### Adjusting the position of cross rails

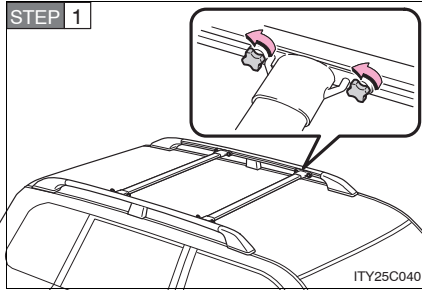

Turn the knobs counterclockwise to release the cross rails.

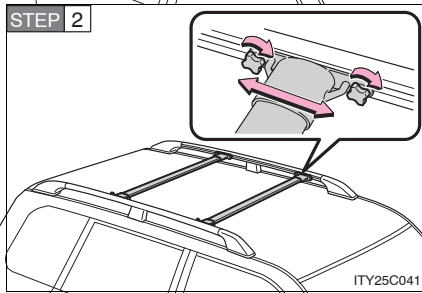

Slide the cross rails to the appropriate position for loading luggage and turn the knobs clockwise to tighten the cross rails securely.

2

When driving

### Capacity and distribution

Cargo capacity depends on the total weight of the occupants.

(Cargo capacity) = (Total load capacity) — (Total weight of occupants)

#### Steps for Determining Correct Load Limit—

- (1) Locate the statement “The combined weight of occupants and cargo should never exceed XXX kg or XXX lbs.” on your vehicle’s placard.
- (2) Determine the combined weight of the driver and passengers that will be riding in your vehicle.
- (3) Subtract the combined weight of the driver and passengers from XXX kg or XXX lbs.
- (4) The resulting figure equals the available amount of cargo and luggage load capacity.

For example, if the “XXX” amount equals 1400 lbs. and there will be five 150 lb passengers in your vehicle, the amount of avail-

150) = 650 lbs.)

- (5) Determine the combined weight of luggage and cargo being loaded on the vehicle.

That weight may not safely exceed the available cargo and luggage load capacity calculated in Step 4.

- (6) If your vehicle will be towing a trailer, load from your trailer will be transferred to your vehicle. Consult this manual to determine how this reduces the available cargo and luggage load capacity of your vehicle. ( P. 221)

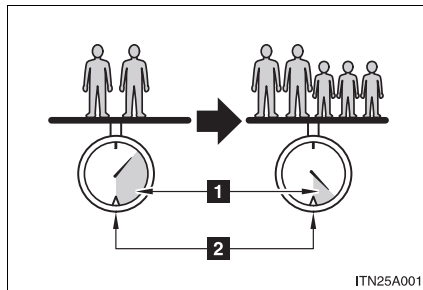
**Example on your vehicle**

- 1** Cargo capacity
- 2** Total load capacity

When 2 people with the combined weight of 366 lb. (166 kg) are riding in your vehicle, which has a total load capacity of 1235 lb. (560 kg), the available amount of cargo and luggage load capacity will be as follows:

$$1235 \text{ lb.} - 366 \text{ lb.} = 869 \text{ lb.} \quad (560 \text{ kg} - 166 \text{ kg} = 394 \text{ kg})$$

In this condition, if 3 more passengers with the combined weight of 388 lb. (176 kg) get on, the available cargo and luggage load will be reduced as follows:

$$869 \text{ lb.} - 388 \text{ lb.} = 481 \text{ lb.} \quad (394 \text{ kg} - 176 \text{ kg} = 218 \text{ kg})$$

As shown in the above example, if the number of occupants increases, the cargo and luggage load equaling the combined weight of the occupants who got on later, by an amount. In other words, if an increase in the number of occupants causes an excess of the total load capacity (combined weight of occupants plus cargo and luggage load), you must reduce the cargo and luggage on your vehicle.

 **CAUTION**

**n Things that must not be carried in the luggage compartment**

The following things may cause a fire if loaded in the luggage compartment.

- I Receptacles containing gasoline
- I Aerosol cans

**n Storage precautions**

- I Do not stack anything in the luggage compartment higher than the seatbacks.  
Such items may be thrown about and possibly injure people in the vehicle during sudden braking or in an accident.
- I Do not place cargo or luggage in or on the following locations as the item may get under the brake or accelerator pedal and prevent the pedals from being depressed properly, block the driver's vision, or hit the driver or passengers, causing an accident.
  - Feet of the driver
  - Front passenger or rear seats (when stacking items)
  - Instrument panel
  - Dashboard
  - Auxiliary box or tray that has no lid
- I Secure all items in the occupant compartment, as they may shift and injure someone during an accident or sudden braking.
- I Never allow anyone to ride in the luggage compartment. It is not designed for passengers. They should ride in their seats with their seat belts properly fastened. Otherwise, they are much more likely to suffer death or serious injury, in the event of sudden braking or a collision.



**⚠ CAUTION****n Weight of the load**

- ! Do not exceed the maximum axle weight rating or the total vehicle weight rating.
- ! Even if the total load of occupant's weight and the cargo load is less than the total load capacity, do not apply the load unevenly. Improper loading may cause deterioration of steering or braking control which may cause death or serious injury.

**n Roof luggage carrier precautions**

To use the roof rails as a roof luggage carrier, you must fit the roof rails with two or more genuine Toyota cross rails or their equivalent.

When you load cargo on the roof luggage carrier, observe the following:

- ! Place the cargo so that its weight is distributed evenly between the front and rear axles.
- ! If loading long or wide cargo, never exceed the vehicle overall length or width. ( P. 430)
- ! Before driving, make sure the cargo is securely fastened on the roof luggage carrier.
- ! Loading cargo on the roof luggage carrier will make the center of the vehicle gravity higher. Avoid high speeds, sudden starts, sharp turns, sudden braking or abrupt maneuvers, otherwise it may result in loss of control or vehicle rollover due to failure to operate this vehicle correctly.
- ! If driving for a long distance, on rough roads, or at high speeds, stop the vehicle now and then during the trip to make sure the cargo remains in its place.
- ! Do not exceed 154 lb. (70 kg) cargo weight on the roof luggage carrier.

 CAUTION

**n Cross rail adjustment**

Make sure the cross rails are locked securely by pushing forward and rearward them.  
Failure to do so may cause an accident or severe injury in the event of emergency braking or a collision.

 NOTICE

**n Cross rail adjustment**

Do not remove the cross rail stoppers, or the moon roof may be damage when it is tilted.

**n When loading the luggage**

Be careful not to scratch the surface of the moon roof.

2-5. Driving information  
Vehicle load limits

**Vehicle load limits include total load capacity, seating capacity, towing capacity and cargo capacity.**

**n Total load capacity: 1235 lb. (560 kg)**

Total load capacity means the combined weight of occupants, cargo and luggage.

**n Seating capacity: 8 occupants (Front 2, Rear 6)**

Seating capacity means the maximum number of occupants whose estimated average weight is 150 lb. (68 kg) per person.

Even if the number of occupants are within the seating capacity, do not exceed the total load capacity.

**n Towing capacity: 8500 lb. (3855 kg)**

Towing capacity means the maximum gross trailer weight (trailer weight plus its cargo weight) that you vehicle is able to tow.

**n Cargo capacity**

Cargo capacity may increase or decrease depending on the weight and the number of occupants.

2

When driving

**n Total load capacity and seating capacity**

These details are also described on the tire and loading information label. ( P. 401)

**⚠ CAUTION**

**n Overloading the vehicle**

Do not overload the vehicle.

It may not only cause damage to the tires, but also degrade steering and braking ability, resulting in an accident.

**Carry out the necessary preparations and inspections before driving the vehicle in winter. Always drive the vehicle in a manner appropriate to the prevailing weather conditions.**

**n Pre-winter preparations**

- 1 Use fluids that are appropriate to the prevailing outside temperatures.
  - Engine oil
  - Engine coolant
  - Washer fluid
- 1 Have a service technician inspect the level and specific gravity of battery electrolyte.
- 1 Have the vehicle fitted with four snow tires or purchase a set of tire chains for the rear tires.

Ensure that all tires are the same size and brand, and that chains match the size of the tires.

n **Before driving the vehicle**

Perform the following according to the driving conditions.

- l Do not try to forcibly open a window or move a wiper that is frozen. Pour warm water over the frozen area to melt the ice. Wipe away the water immediately to prevent it from freezing.
- l To ensure proper operation of the climate control system fan, remove any snow that has accumulated on the air inlet vents in front of the windshield.
- l Remove any ice that has accumulated on the vehicle chassis.
- l Periodically check for and remove any excess ice or snow that may have accumulated in the wheel well or on the brakes.

n **When driving the vehicle**

Accelerate the vehicle slowly and drive at a reduced speed suitable to road conditions.

n **When parking the vehicle**

Park the vehicle and move the shift lever to "P" without setting the parking brake. The parking brake may freeze up, preventing it from being released.

### Selection tire chains

Use the correct tire chain size when mounting the snow chains.  
Chain size is regulated for each tire size.

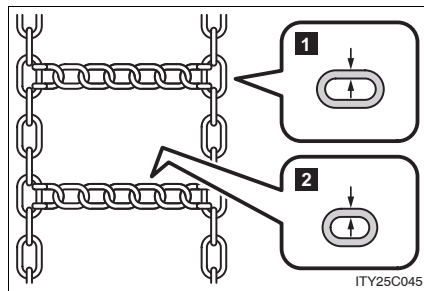

- 1** Side chain  
(0.20 in. [5 mm] in diameter)
- 2** Cross chain  
(0.25 in. [6.3 mm] in diameter)

### Regulations on the use of tire chains

- 1 Regulations regarding the use of tire chains vary according to location and type of road. Always check local regulations before installing chains.
- 1 Retighten the chains after driving 1/4 – 1/2 mile (0.5 – 1.0 km).

#### n Tire chains

Observe the following precautions when installing and removing chains.

- 1 Install and remove tire chains in a safe location.
- 1 Install tire chains on the rear tires.
- 1 Install tire chains following the instructions provided in the accompanying manual.

**⚠ CAUTION****n Driving with snow tires**

Observe the following precautions to reduce the risk of accidents. Failing to do so may result in a loss of vehicle control and cause death or serious injury.

- l Use tires of the size specified for your vehicle.
- l Maintain the recommended level of tire inflation pressure.
- l Do not drive in excess of 75 mph (120 km/h), regardless of the type of snow tires being used.
- l Snow tires should be installed on all wheels.

**n Driving with tire chains**

Observe the following precautions to reduce the risk of accidents. Failing to do so may result in the vehicle being unable to be driven safely, and may cause death or serious injury.

- l Do not drive in excess of the speed limit specified for the tire chains being used, or 30 mph (50 km/h), whichever is lower.
- l Avoid driving on bumpy road surfaces or over potholes.
- l Avoid sudden turns and braking, as use of chains may adversely affect vehicle handling.
- l Slow down sufficiently before entering a curve to ensure that vehicle control is maintained.

 NOTICE

**n Repairing or replacing snow tires**

Request repairs of and obtain replacement snow tires from Toyota dealers or legitimate tire retailers.

This is because the removal and attachment of snow tires affects the operation of the tire pressure warning valves and transmitters.

**n Fitting tire chains**

The tire pressure warning valves and transmitters may not function correctly when tire chains are fitted.



## Trailer towing

**Your vehicle is designed primarily as a passenger-and-load carrying vehicle. Towing a trailer will have an adverse effect on handling, performance, braking, durability, and fuel consumption. For your safety and the safety of others, do not overload the vehicle or trailer.**

**To tow a trailer safely, use extreme care and drive the vehicle in accordance with the trailer's characteristics and operating conditions.**

**The vehicle stability and braking performance are affected by trailer stability, brake setting and performance, and the hitch.**

**Toyota warranties do not apply to damage or malfunction caused by towing a trailer for commercial purposes.**

Contact your Toyota dealer for further information about additional requirements such as a towing kits, etc.



**Towing related term**

Towing related term	Meaning
GVWR (Gross Vehicle Weight Rating)	The maximum allowable gross vehicle weight. The gross vehicle weight is the total weight of the vehicle. When towing a trailer, it is the sum of the vehicle weight (including the occupants, cargo and any optional equipment installed on the vehicle) and the tongue load.
GAWR (Gross Axle Weight Rating)	The maximum allowable gross axle weight. The gross axle weight is the load placed on each axle (front and rear).
GCWR (Gross Combination Weight Rating)	The maximum allowable gross combination weight. The gross combination weight is the sum of the total vehicle weight (including the occupants, cargo and any optional equipment installed on the vehicle) and the weight of the trailer being towed (including the cargo in the trailer).
Gross trailer weight	The sum of the trailer weight and the weight of the cargo in the trailer.
Towing capacity	The maximum allowable gross trailer weight. Towing capacity is calculated considering base vehicle with necessary vehicle equipment and occupants. Additional optional equipment, passengers and cargo in the vehicle will reduce the towing capacity, gross trailer weight includes the trailer, cargo and necessary equipment for towing.
Tongue load	The load placed on the trailer hitch ball.

### Trailer tongue load

- 1 A recommended tongue load varies in accordance with the types of trailers or towing as described below.
- 1 In order to ensure the recommended values shown below, the trailer must be loaded by referring to the following instructions. The trailer cargo load should be distributed so that the tongue load is 9 to 11 %.  
(Tongue load / Gross trailer weight  $\times$  100 = 9 to 11 %)  
If the gross trailer weight is over 5000 lb. (2268 kg), it is necessary to use a sway control device with sufficient capacity.

The gross trailer weight and tongue load can be measured with platform scales found at a highway weighing station, building supply company, trucking company, junk yard, etc.

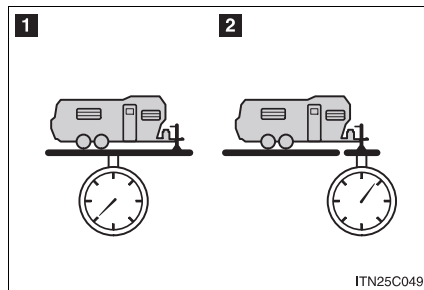

- 1 Gross trailer weight
- 2 Tongue load

**Removing hitch cover**

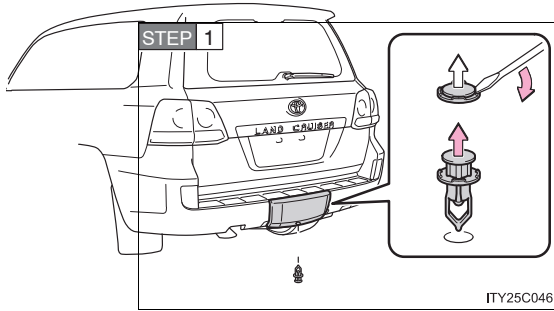

Remove the clip.

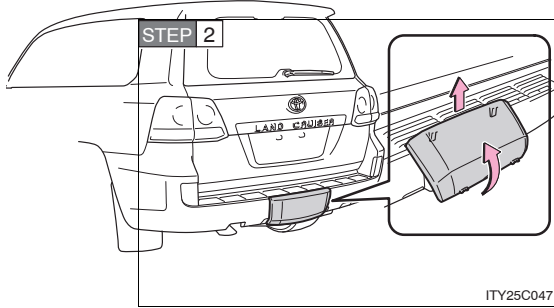

Grasp the lower edge of the hitch cover and raise the cover.

When reattaching the cover, reverse the steps listed.

2

When driving

### Selecting trailer ball

Use the correct trailer ball for your application.

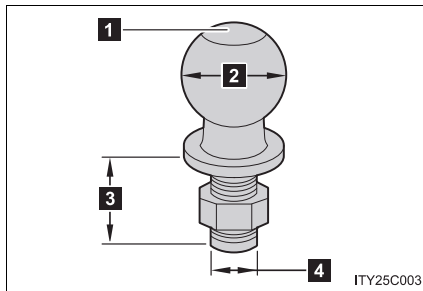

**1** Trailer ball load rating

Matches or exceeds the gross trailer weight rating of the trailer.

**2** Ball diameter

Matches the size of the trailer coupler. Most couplers are stamped with the required trailer ball size.

**3** Shank length

Protrudes beyond the bottom of the lock washer and nut at least 2 threads.

**4** Shank diameter

Matches the ball mount hole diameter size.

### Connecting trailer lights

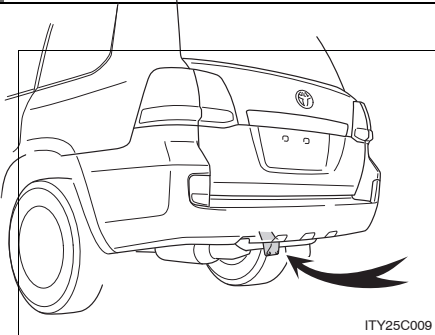

Use the wire harness stored in the rear end under body.

**Trailer towing tips**

Your vehicle will handle differently when towing a trailer. The 3 main causes of vehicle-trailer accidents are driver error, excessive speed and improper trailer loading. Keep the following in mind when towing.

- 1 Before starting out, check the trailer lights and the vehicle-trailer connections. Recheck after driving a short distance.
- 1 Practice turning, stopping and reversing with the trailer attached in an area away from traffic until you become accustomed to the feel of the vehicle.
- 1 Reversing with a trailer attached is difficult and requires practice. Grip the bottom of the steering wheel and move your hand to the left to move the trailer to the left. Move your hand to the right to move the trailer to right. (This is generally opposite to reversing without a trailer attached.) Avoid sharp or prolonged turning. Have someone guide you when reversing to reduce the risk of an accident.
- 1 As stopping distance is increased when towing a trailer, vehicle-to-vehicle distance should be increased. For each 10 mph (16 km/h) of speed, allow at least one vehicle and trailer length.
- 1 Avoid sudden braking as you may skid, resulting in jackknifing and loss of control. This is especially true on wet or slippery surfaces.
- 1 Avoid jerky starts or sudden acceleration.
- 1 Avoid jerky steering and sharp turns, and slow down before making turns.

2

When driving

## 2-5. Driving information

- 1 Note that when making a turn, the trailer wheels will be closer than the vehicle wheels to the inside of the turn. Compensate by making a larger than normal turning radius.
- 1 Crosswinds and rough roads will adversely affect handling of your vehicle and trailer, causing sway . Periodically check the rear to prepare for being passed by large trucks or buses, which may cause your vehicle and trailer to sway. If swaying occurs, firmly grip the steering wheel, reduce speed immediately but gradually, and steer straight ahead. Never increase speed. If you make no extreme correction with the steering or brakes, your vehicle and trailer will stabilize.
- 1 Take care when passing other vehicles. Passing requires considerable distance. After passing a vehicle, do not forget the length of your trailer, and be sure you have plenty of room before changing lanes.
- 1 In order to maintain engine braking efficiency when driving on a long steep downgrade, do not use overdrive. Transmission shift range position must be in "4", in "S" mode.
- 1 Due to the added load of the trailer, your vehicle's engine may overheat on hot days (at temperatures over 85°F [30°C] when driving up a long or steep grade. If the engine coolant temperature gauge indicates overheating, immediately turn off the air conditioning (if in use), pull your vehicle off the road and stop in a safe spot. ( P. 488)



- 1 Always place wheel blocks under both the vehicle and the trailer wheels when parking. Apply the parking brake firmly, and put the transmission in "P". Avoid parking on a slope, but if unavoidable, do so only after performing the following:

**STEP 1** Apply the brakes and keep them applied.

**STEP 2** Have someone place wheel blocks under both the vehicle and trailer wheels.

**STEP 3** When the wheel blocks are in place, release the brakes slowly until the blocks absorb the load.

**STEP 4** Apply the parking brake firmly.

**STEP 5** Shift into "P" and turn off the engine.

- 1 When restarting after parking on a slope:

**STEP 1** With the transmission in the "P" position, start the engine. Be sure to keep the brake pedal pressed.

**STEP 2** Shift into "3", "2", "1", or "R" position (if reversing).

**STEP 3** Release the parking brake and brake pedal, and slowly pull or back away from the wheel blocks. Stop and apply the brakes.

**STEP 4** Have someone retrieve the blocks.

---

**n Before towing**

Check that the following conditions are met:

- | The vehicle's tires are properly inflated.
- | Trailer tires are inflated according to the trailer manufacturer's recommendation.
- | All trailer lights work.
- | All lights work each time you connect them.
- | The trailer ball is set up at the proper height for the coupler on the trailer.
- | The vehicle remains level when a loaded or unloaded trailer is hitched. Do not drive if the vehicle is not level, and check for improper tongue load, overloading, worn suspension, or other possible causes.
- | The trailer cargo is securely loaded.
- | The rear view mirrors conform to all applicable federal, state/provincial or local regulations. If they do not, install rear view mirrors appropriate for towing purposes.

**n Break-in schedule**

Toyota recommends that you do not use a new vehicle or a vehicle with any new power train components (engine, transmission, differential, wheel bearings, etc.) to tow a trailer for the first 500 miles (800 km) of driving.

**n Maintenance**

- | If you tow a trailer, your vehicle will require more frequent maintenance due to the additional load. (See "Scheduled Maintenance Guide" or "Owner's Manual Supplement".)
- | Retighten the fixing bolts of the towing ball after approximately 600 miles (1000 km) of trailer towing.

**⚠ CAUTION****n Trailer towing precautions**

- I Follow all the instructions described in this section. Failure to do so could cause an accident resulting in death or serious injury.
- I Exceeding the towing capacity, GVWR, GCWR and GAWR can cause an accident resulting in death or serious personal injuries.

**n To avoid accident or injury**

- I Do not exceed 45 mph (72 km/h) or the posted towing speed limit, whichever is lower. As instability (swaying) of the towing vehicle-trailer combination increases as speed increases, exceeding 45 mph (72 km/h) may cause loss of control.
- I Slow down and downshift before descending steep or long downhill grades. Do not make sudden downshifts.
- I Avoid holding the brake pedal down too long or applying the brakes too frequently. This could cause the brakes to overheat and result in reduced braking efficiency.
- I Do not exceed the trailer hitch assembly weight, gross vehicle weight, gross axle weight and trailer tongue load capacities.
- I Never load more weight in the back than in the front of the trailer. About 60% of the load should be in the front half of the trailer, and the remaining 40% in the rear.
- I Do not use cruise control when you are towing.

 **CAUTION**

**n Hitches**

- I** Lubricate the hitch ball with a light coat of grease.
- I** If using a weight distributing hitch when towing, keep your vehicle level with the ground.

**n When towing a trailer**

- I** If the gross trailer weight exceeds 1000 lb. (453 kg), trailer brakes are required. Toyota recommends trailers with brakes that conform to all applicable federal and state/provincial regulations.
- I** Never tap into your vehicle's hydraulic system, as this will lower the vehicle's braking effectiveness.
- I** Never tow a trailer without using a safety chain securely attached to both the trailer and the vehicle. If damage occurs to the coupling unit or hitch ball, there is danger of the trailer wandering into another lane.

 **NOTICE**

**n When installing a trailer hitch**

- I** Use only the position recommended by your Toyota dealer. Do not install the trailer hitch on the bumper; this may cause body damage.
- I** Do not use axle-mounted hitches, as they can cause damage to the axle housing, wheel bearings, wheels or tires.

**n Safety chain**

A safety chain must always be used between the towing vehicle and the trailer. Leave sufficient slack in the chain for turns. The chain should cross under the trailer tongue to prevent the tongue from dropping to the ground in the case that it becomes damaged or separated. For the correct safety chain installation procedure, ask your Toyota dealer.

**n Do not directly splice trailer lights**

Directly splicing trailer lights may damage your vehicle's electrical system and cause a malfunction.

2-5. Driving information  
Dinghy towing

Your vehicle is not designed to be dinghy towed (with 4 wheels on the ground) behind a motor home.

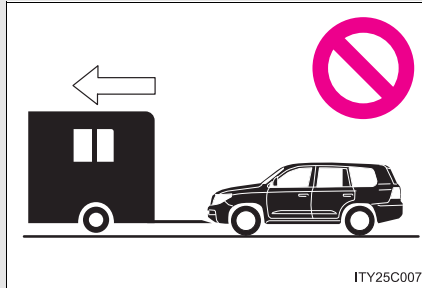

 NOTICE

**n To avoid serious damage to your vehicle**

Do not tow your vehicle with four wheels on the ground.

### 3-1. Using the air conditioning system and defogger Front air conditioning system

**Airflow and outlets are automatically adjusted according to the temperature setting.**

► With navigation system

Owners of models equipped with a navigation system should refer to the “Navigation System Owner’s Manual”.

► Without navigation system

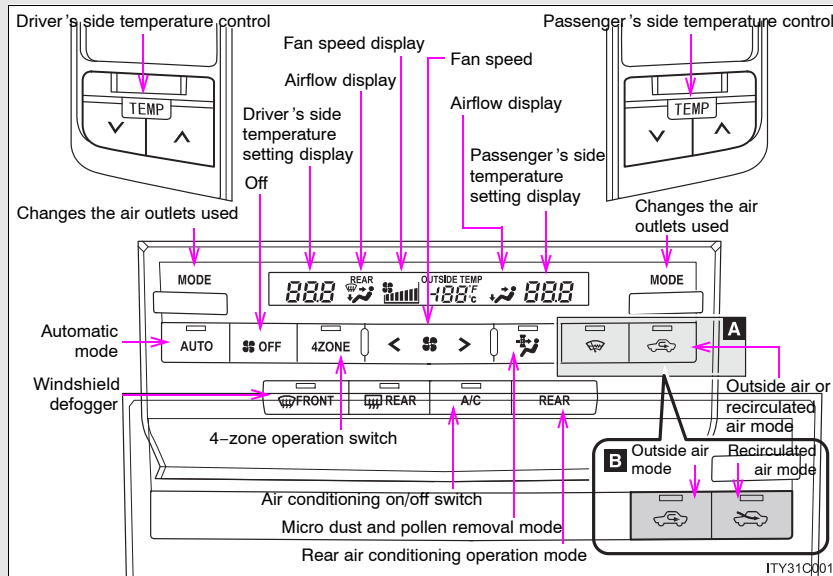

**A** Vehicles with windshield wiper de-icer

**B** Vehicles without windshield wiper de-icer

### Using the automatic mode

**STEP 1** Press 

The air conditioning system will begin to operate. Air outlets and fan speed are automatically adjusted according to the temperature setting.

**STEP 2** Press “ ” to increase the temperature and “ ” to decrease the

temperature on  .

The temperature for the driver's and front passenger's seats can be set separately.



## Adjusting the settings

### n Adjusting the temperature setting

Press “ ” to increase the temperature and “ ” to decrease the temperature on .

The air conditioning system switches between individual and simultaneous modes each time  is pressed.

Individual mode (the indicator on  is on.): The temperature for the driver's, front passenger's and rear seats ( P. 247) can be set separately. Operating the passenger's side or rear temperature control will enter individual mode.

Simultaneous mode (the indicator on  is off.): Only  (driver's side) can be used to adjust the temperature for all seats.

### n Adjusting the fan speed

Press “ ” (increase) or “ ” (decrease) on .

The fan speed is shown on the display. (7 levels)

Press  to turn the fan off.



3-1. Using the air conditioning system and defogger

n Changing the air outlets

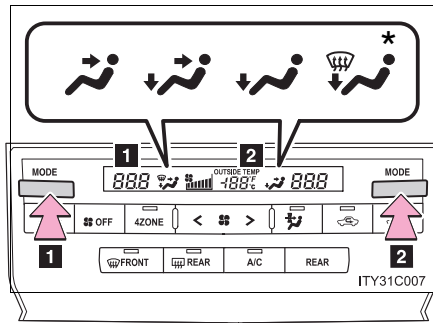

Press

- 1 For driver's seat
- 2 For front passenger's seat

The air outlets switch each time the button is pressed.

Different air outlets for the driver's and front passenger's seats can be chosen.

\*: Driver side only

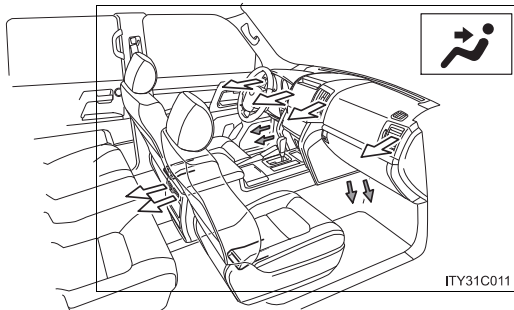

Air flows to the upper body.

← : Only in the automatic mode

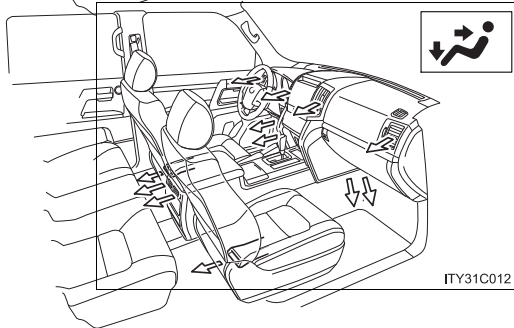

Air flows to the upper body and feet.

### 3-1. Using the air conditioning system and defogger

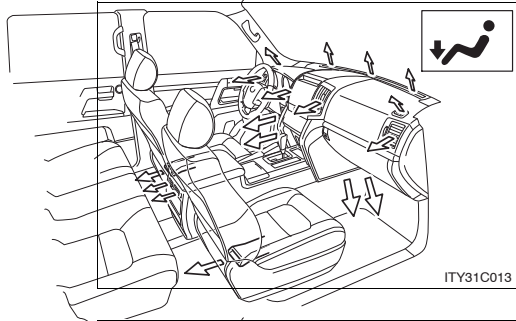

Air flows to the feet.

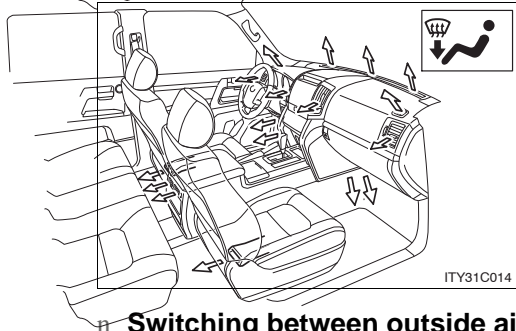

Air flows to the feet and the windshield defogger operates.

#### Switching between outside air and recirculated air modes

- ▶ Vehicles with windshield wiper de-icer

Press 

The mode switches between outside air mode (indicator off) and recirculated air mode (indicator on) each time the button is pressed.

- ▶ Vehicles without windshield wiper de-icer

Press  to switch to recirculated air mode and press

 to switch to outside air mode.

### Changing the rear seat settings from the front seat

#### n Adjusting the temperature setting

**STEP 1** Press 

**STEP 2** Press “ ” to increase the temperature and “ ” to decrease the temperature on  (for left-hand rear seat) and

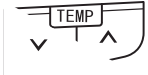
 (for right-hand rear seat).

The temperature for the right-hand and left-hand rear seats can be adjusted separately. Operating the switch will enter individual mode.

The air conditioning system switches between individual and simultaneous modes each time  is pressed.

#### n Adjusting the fan speed

**STEP 1** Press 

**STEP 2** Press “ ” (increase) or “ ” (decrease) on .

The fan speed is shown on the display. (7 levels)

Press  to turn the fan off.

### 3-1. Using the air conditioning system and defogger

#### n Changing the air outlets

STEP 1 Press 

STEP 2 Press 

The air outlets switch each time the button is pressed. ( P. 245)

#### Defogging the windshield

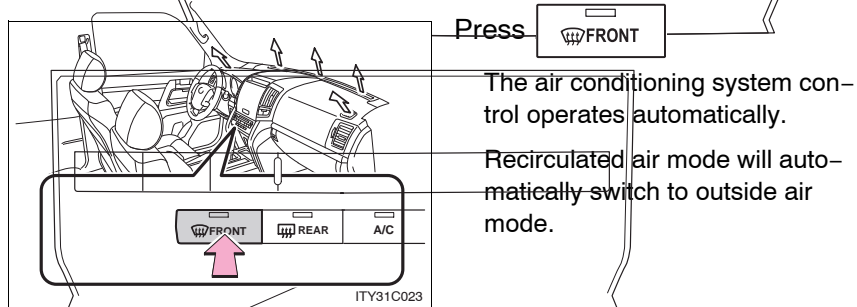

#### Micro dust and pollen filter

Press 

Outside air mode switches to recirculated air mode. Pollen is removed from the air and the air flows to the upper part of the body.

Usually the system will turn off automatically approximately 3 minutes later.

To stop the operation, press  again.

**Adjusting the position and opening and closing the air outlets**

► Front center outlets

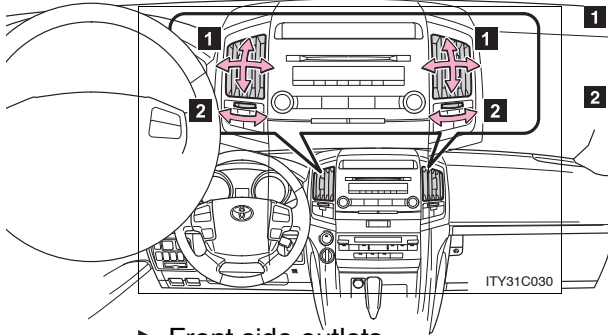

- 1 Direct air flow to the left or right, up or down.
- 2 Turn the knob to open or close the vent.

► Front side outlets

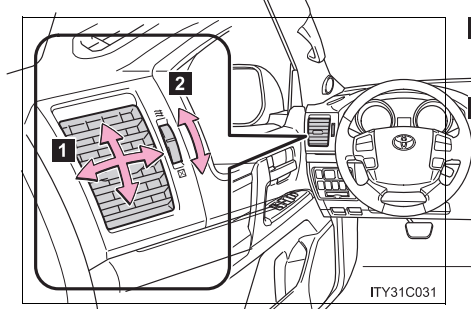

- 1 Direct air flow to the left or right, up or down.
- 2 Turn the knob to open or close the vent.

► Rear center outlets

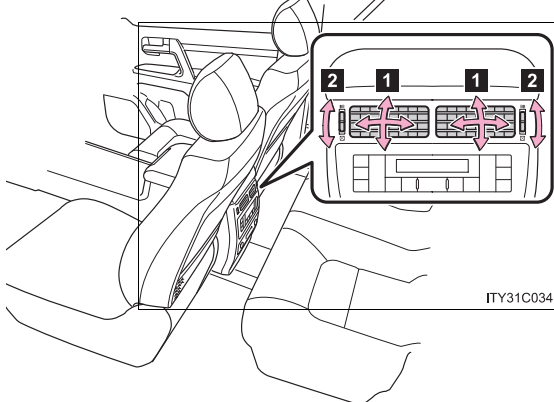

- 1 Direct air flow to the left or right, up or down.
- 2 Turn the knob to open or close the vent.

n **Using the automatic mode**

Fan speed is adjusted automatically in accordance with the temperature setting and ambient conditions. As a result, the following may occur.

- l The system may switch automatically to recirculated air mode when the coolest temperature setting is selected in summer.
- l Immediately after  is pressed, the fan may stop for a while until warm or cool air is ready to flow.
- l Cool air may flow to the area around the upper body when the heater is on.

n **Using the system in recirculated air mode**

The windows will fog up more easily if the recirculated air mode is used for an extended period.

n **Window defogger feature**

Recirculated air mode may automatically switch to outside air mode in situations where the windows need to be defogged.

n **When outside temperature approaches 32°F (0°C).**

The air conditioning system may not operate even when pressed.

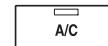

n **Micro dust and pollen filter**

l In order to prevent the windows from fogging up when the outside air is cold, the following may occur.

- Outside air mode does not switch to recirculated air mode.
- The air conditioning system operates automatically.
- The operation cancels after 1 minute.

l In rainy weather, the windows may fog up. press  .

 CAUTION

**n To prevent the windshield from fogging up**

Do not use  during cool air operation in extremely humid weather. The difference between the temperature of the outside air and that of the windshield can cause the outer surface of the windshield to fog up, blocking your vision.

 NOTICE

**n To prevent battery discharge**

Do not leave the air conditioning system on longer than necessary when the engine is stopped.

### 3-1. Using the air conditioning system and defogger

## Rear air conditioning system

**Airflow and outlets are automatically adjusted according to the temperature setting.**

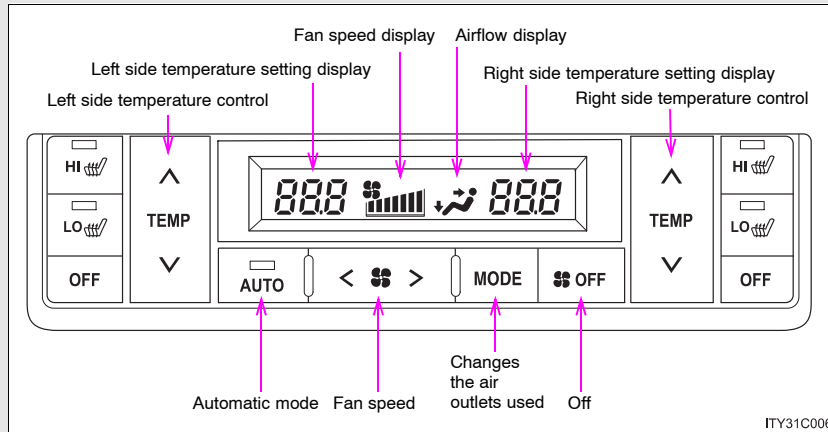

### Using the automatic mode

**STEP 1** Press 

The air conditioning system will begin to operate. Air outlets and fan speed are automatically adjusted according to the temperature setting.

**STEP 2** Press “ ” to increase the temperature and “ ” to decrease the

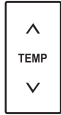
temperature on  .

The temperature for the right-hand and left-hand rear seats can be set separately.



## Adjusting the settings

### n Adjusting the temperature setting

Press “ ” to increase the temperature and “ ” to decrease the tem-

perature on  .

The temperature for the right-hand and left-hand rear seats can be set separately.

### n Adjusting the fan speed

Press “ ” (increase) or “ ” (decrease) on  .

The fan speed is shown on the display. (7 levels)

Press  to turn the fan off.

### n Changing the air outlets

Press  .

The air outlets switch each time the button is pressed.

3-1. Using the air conditioning system and defogger

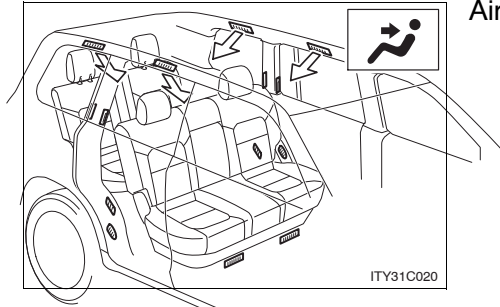

Air flows to the upper body.

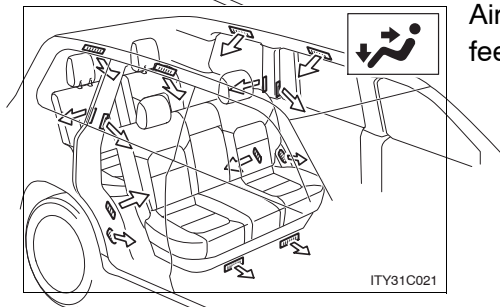

Air flows to the upper body and feet.

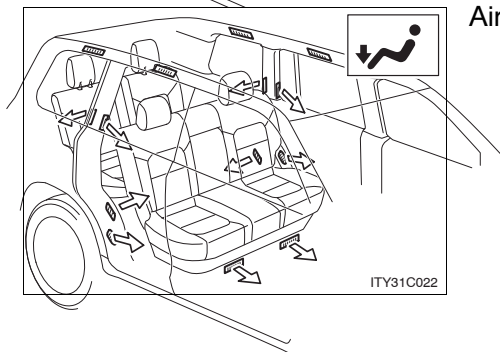

Air flows to the feet.

**Adjusting the position and opening and closing the air outlets**

▶ Rear center outlets

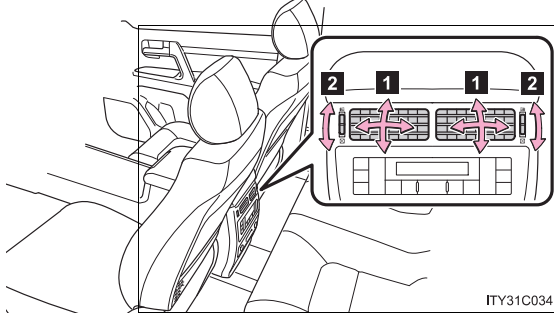

- 1 Direct air flow to the left or right, up or down.
- 2 Turn the knob to open or close the vent.

▶ Roof side outlets

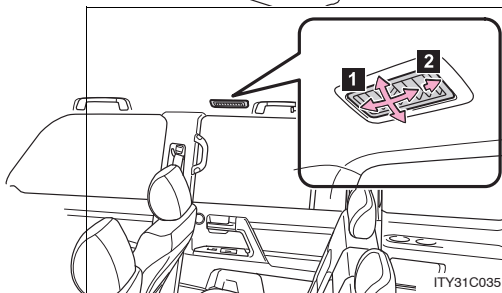

- 1 Direct air flow to the left or right, up or down.
- 2 Turn the knob fully to the back of the vehicle to close the vent.

**⚠ NOTICE**

**■ To prevent battery discharge**

Do not leave the air conditioning system on longer than necessary when the engine is stopped.

### 3-1. Using the air conditioning system and defogger Rear window and outside rear view mirror defoggers

These features are used to defog the rear window, and to remove raindrops, dew and frost from the outside rear view mirrors.

#### ► With navigation system

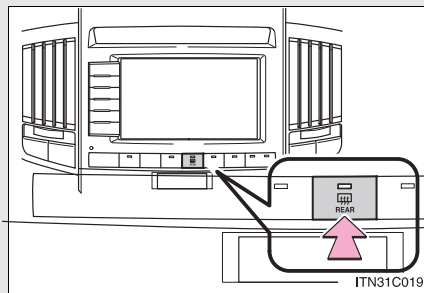

#### On/off

The defoggers will automatically turn off after 15 to 225 minutes. The operation time changes according to the ambient temperature and vehicle speed. Pressing the switch again also turns the defoggers off.

#### ► Without navigation system

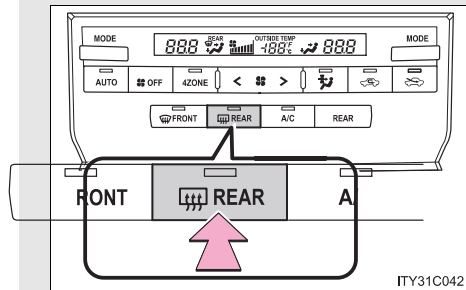

#### ⓘ The rear window and outside rear view mirror defoggers can be operated when

The “ENGINE START STOP” switch is in IGNITION ON mode.

#### ⚠ CAUTION

#### ⓘ When the outside rear view mirror defoggers are on

Do not touch the rear view mirror surfaces, as they can become very hot and burn you.

### 3-1. Using the air conditioning system and defogger Windshield wiper de-icer

This feature is used to prevent ice from building up on the windshield and wiper blades.

► With navigation system

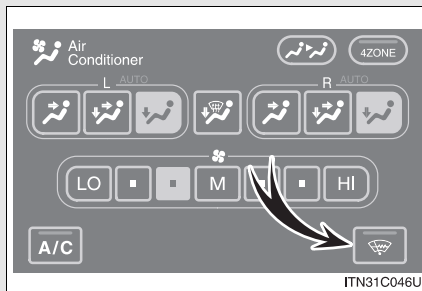

On/off

The windshield wiper de-icer will automatically turn off after approximately 15 minutes. Pressing the switch again also turns the de-icer off.

► Without navigation system

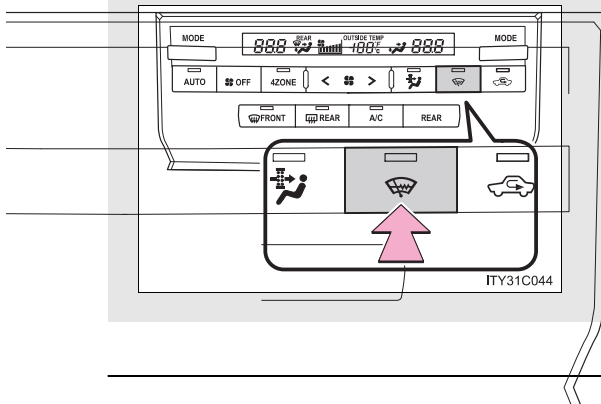

■ The windshield wiper de-icer can be operated when

The “ENGINE START STOP” switch is in IGNITION ON mode.

**⚠ CAUTION**

■ When the windshield wiper de-icer is on

Do not touch the glass at the lower part of the windshield or to the side of the front pillars as the surfaces can become very hot and burn you.

## 3-2. Using the audio system

### Audio system type

- ▶ With navigation system  
Owners of models equipped with a navigation system should refer to the “Navigation System Owner’s Manual”.
- ▶ Without navigation system  
CD player with changer and AM/FM radio.

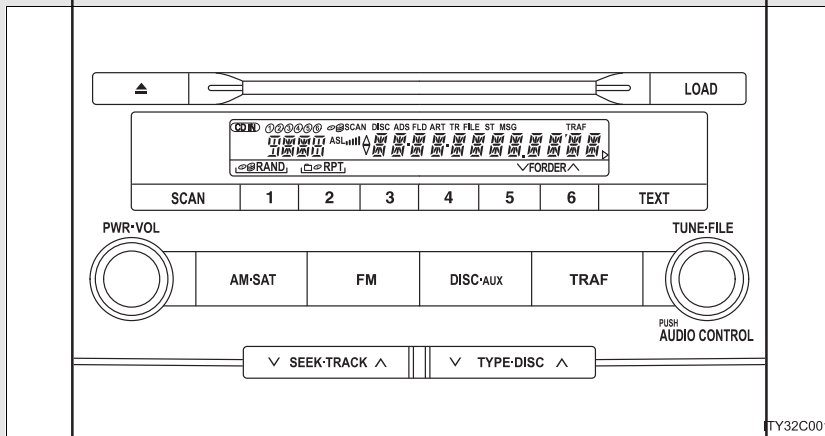

Title	Page
Using the radio	P. 260
Using the CD player	P. 265
Playing back MP3 and WMA discs	P. 273
Optimal use of the audio system	P. 280
Using the AUX adapter	P. 282
Using the steering switches	P. 283

**n Using cellular phones**

Interference may be heard through the audio system's speakers if a cellular phone is being used inside or close to the vehicle while the audio system is operating.

**⚠ CAUTION****n For vehicles sold in the U.S.A.****I Part 15 of the FCC Rules**

FCC Warning:

Any unauthorized changes or modifications to this equipment will void the user's authority to operate this device.

**I Laser products**

- Do not take this unit apart or attempt to make any changes yourself. This is an intricate unit that uses a laser pickup to retrieve information from the surface of compact discs. The laser is carefully shielded so that its rays remain inside the cabinet. Therefore, never try to disassemble the player or alter any of its parts since you may be exposed to laser rays and dangerous voltages.
- This product utilizes a laser. Use of controls or adjustments or performance of procedures other than those specified herein may result in hazardous radiation exposure.

**⚠ NOTICE****n To prevent battery discharge**

Do not leave the audio system on longer than necessary with the engine off.

**n To avoid damaging the audio system**

Take care not to spill drinks or other fluids over the audio system.

### 3-2. Using the audio system Using the radio

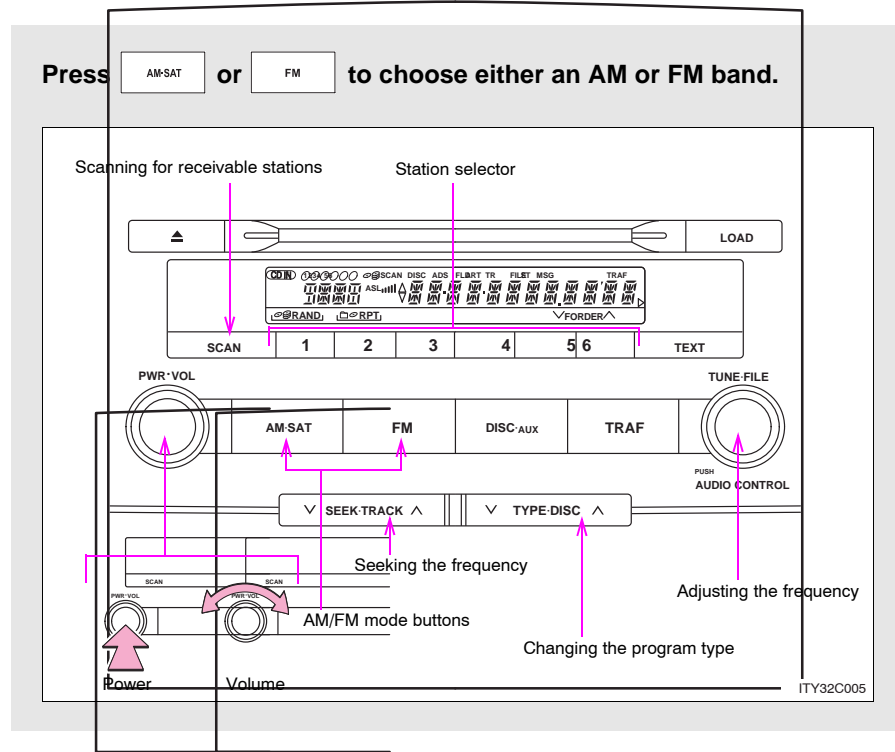





### Setting station presets

**STEP 1** Search for desired stations by turning  or pressing “ ” or

“ ” on .

**STEP 2** Press and hold the button (from  to  the station is to be set to, and you hear a beep.

### Scanning radio stations

#### n Scanning the preset radio stations

**STEP 1** Press and hold  until you hear a beep.

Preset stations will be played for a few seconds each.

**STEP 2** When the desired station is reached, press  once again.

#### n Scanning all radio stations within range

**STEP 1** Press  “SCAN” appears on the display and all stations with reception will be played for a few seconds each.

**STEP 2** When the desired station is reached, press  once again.

## RDS (Radio Data System)

This feature allows your radio to receive station identification information and program information (classical, jazz, etc.) from radio stations which broadcast this information.

### n Receiving RDS broadcasts

**STEP 1** Press “ ” or “ ” on the  during FM reception. The type of program changes each time the button is pressed.

- 1 ROCK
- 1 EASYLIS (Easy listening)
- 1 CLS/JAZZ (Classical music and Jazz)
- 1 R & B (Rhythm and Blues)
- 1 INFORM (Information)
- 1 RELIGION
- 1 MISC (Miscellaneous)
- 1 ALERT (Emergency messages)

If the system receives no RDS stations, “NO PTY” appears on the display.

**STEP 2** Press  or “ ” or “ ” on .

The radio seeks scans the station by the relevant program type.

If no radio station of that type is found, “NOTHING” appears on the display.

### n Displaying radio station names

Press

### n **Displaying radio text messages**

Press

If MSG is shown on the display, a text message will be displayed.

If the text continues past the end of the display, ► is displayed. Press and hold  until you hear a beep.

### n **Traffic announcement**

Press

“TRAF SEEK” appears on the display, and the radio will start seeking any station broadcasting traffic program information.

If no traffic program station is found, “NO TRAF INFO” appears on the display.

---

### n **When the battery is disconnected**

All preset stations are erased.

### n **Reception sensitivity**

- l Maintaining perfect radio reception at all times is difficult due to the continually changing position of the antenna, differences in signal strength and surrounding objects, such as trains, transmitters, etc.
- l The radio antenna is mounted inside the rear quarter window. To maintain clear radio reception, do not attach metallic window tinting or other metallic objects to the antenna wire mounted inside the rear quarter window.

**n Certifications for the radio tuner**

This equipment has been tested and found to comply with the limits for a class B digital device, pursuant to Part 15 of the FCC Rules. These limits are designed to provide reasonable protection against harmful interference in a residential installation. This equipment generates, uses and can radiate radio frequency energy and, if not installed and used in accordance with the instructions, may cause harmful interference to radio communications. However, there is no guarantee that interference will not occur in a particular installation.

If this equipment does cause harmful interference to radio or television reception, which can be determined by turning the equipment off and on, the user is encouraged to try to correct the interference by trying one or more of the following:

- 1 Reorienting or relocating the receiving antenna.
- 1 Increasing the separation between the equipment and receiver.
- 1 Connecting the equipment into an outlet on a circuit different from that to which the receiver is connected.
- 1 Consulting the dealer or an experienced radio/TV technician for help.

### 3-2. Using the audio system Using the CD player

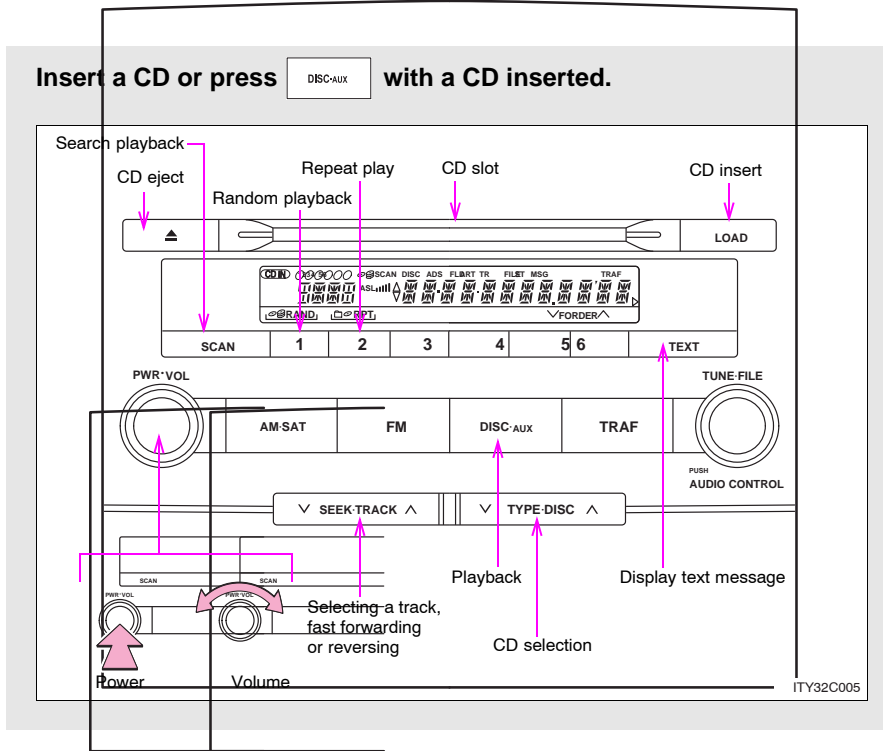

## Loading a CDs

### n Loading a single CD

**STEP 1** Press

“WAIT” appears on the display.

**STEP 2** Insert a CD when the indicator on the slot turns from amber to green.

The display changes from “WAIT” to “LOAD”.

### n Loading multiple CDs

**STEP 1** Press and hold  until you hear a beep.

“WAIT” appears on the display.

**STEP 2** Insert a CD when the indicator on the slot turns from amber to green.

The display changes from “WAIT” to “LOAD”.

The indicator on the slot turns to amber when the CD is inserted.

**STEP 3** Insert the next CD when the indicator on the slot turns from amber to green again.

Repeat the procedure for the remaining CDs.

To cancel the operation, press  or . If you do not insert a CD within 15 seconds, loading will be canceled automatically.

## Ejecting CDs

### n Ejecting a CD

**STEP 1** To select the CD to be ejected, press “ ” or “ ” on



. The number of the CD selected is shown on the display.

**STEP 2** Press  and remove the CD.

### n Ejecting all CDs

Press and hold  until you hear a beep, then remove the CDs.

## Selecting a CD

### n To select a CD to play

Press “ ” or “ ” on  until the desired CD number appears on the display.

### n To scan loaded CDs

**STEP 1** Press and hold  until you hear a beep.

The first 10 seconds of the first track on each CD will be played.

**STEP 2** Press  once again when the desired CD is reached.

## Selecting a track

Press “ ” to move up or “ ” to move down using  until the desired track number appears on the display.

### Fast forwarding and rewinding tracks

Press and hold “ ” or “ ” on  .

### Scanning a CD

**STEP 1** Press

“SCAN” appears on the display.

The first 10 seconds of each track will be played.

**STEP 2** Press  once again when the desired track is reached.

### Random playback

#### n Current CD

Touch  (ND) .

Tracks are played in random order until the button is pressed once again.

#### n All CDs

Press and hold  (RAND) until you hear a beep.

Tracks on all loaded CDs are played in random order until the button is pressed once again.

### Repeating a track or a disc

#### n Repeating a track

Press

#### n Repeating a disc

Press and hold  (RPT) until you hear a beep.



### Switching the display

Press

Each time the button is pressed, the display changes in the order of Track no./Elapsed time CD title Track name.

## 3-2. Using the audio system

### Display

Up to 12 characters can be displayed at a time.

If there are 13 characters or more, pressing and holding  for 1 second or more will display the remaining characters.

A maximum of 24 characters can be displayed.

If  is pressed for 1 second or more again or has not been pressed for 6 seconds or more, the display will return to the first 12 characters.

Depending on the contents recorded, the characters may not be displayed properly or may not be displayed at all.

### Canceling random, repeat and scan playback

Press  (RAND),  (RPT) or  again.

### Error messages

“ERROR”: This indicates a trouble either in the CD or inside the player.  
The CD may be dirty, damaged or inserted up-side down.

### Discs that can be used

Discs with the marks shown below can be used.

Playback may not be possible depending on recording format or disc features, or due to scratches, dirt or deterioration.



CDs with copy-protect features may not play correctly.

### CD player protection feature

To protect the internal components, playback is automatically stopped when a problem is detected.

### If CDs are left inside the CD player or in the ejected position for extended periods

CDs may be damaged and may not play properly.

### Lens cleaners

Do not use lens cleaners. Doing so may damage the CD player.

 NOTICE

**n CDs and adapters that cannot be used**

Do not use the following types of CDs, 3 in. (8 cm) CD adapters or Dual Disc.

Doing so may damage the player and/or the CD insert/eject function.

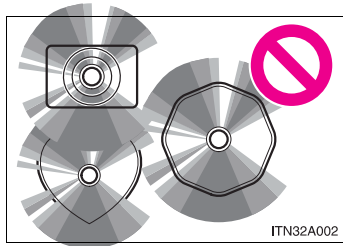

! CDs that have a diameter that is not 4.7 in. (12 cm).

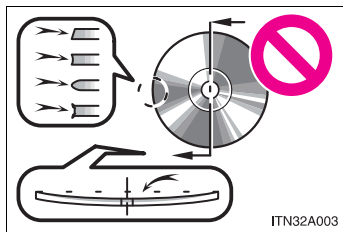

! Low-quality and deformed CDs.

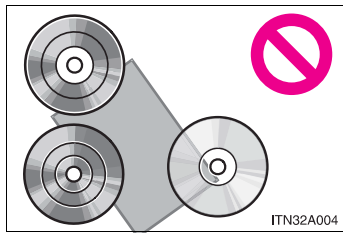

! CDs with a transparent or translucent recording area.

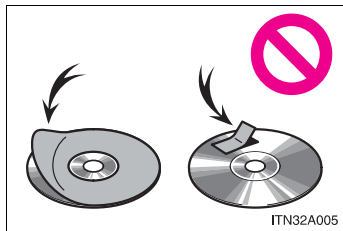

! CDs that have tape, stickers or CD-R labels attached to them, or that have the label peeled off.

 NOTICE

**n Player precautions**

Failure to follow the precautions below may result in damage to the CDs or the player itself.

- | Do not insert anything other than CDs into the CD slot.
  - | Do not apply oil to the player.
  - | Store CDs away from direct sunlight.
  - | Never try to disassemble any part of the player.
- 
- | Do not insert more than one CD at a time.

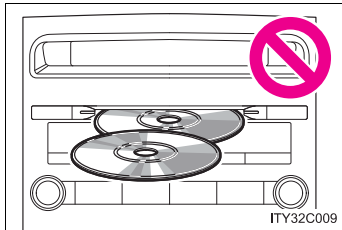

### 3-2. Using the audio system Playing back MP3 and WMA discs

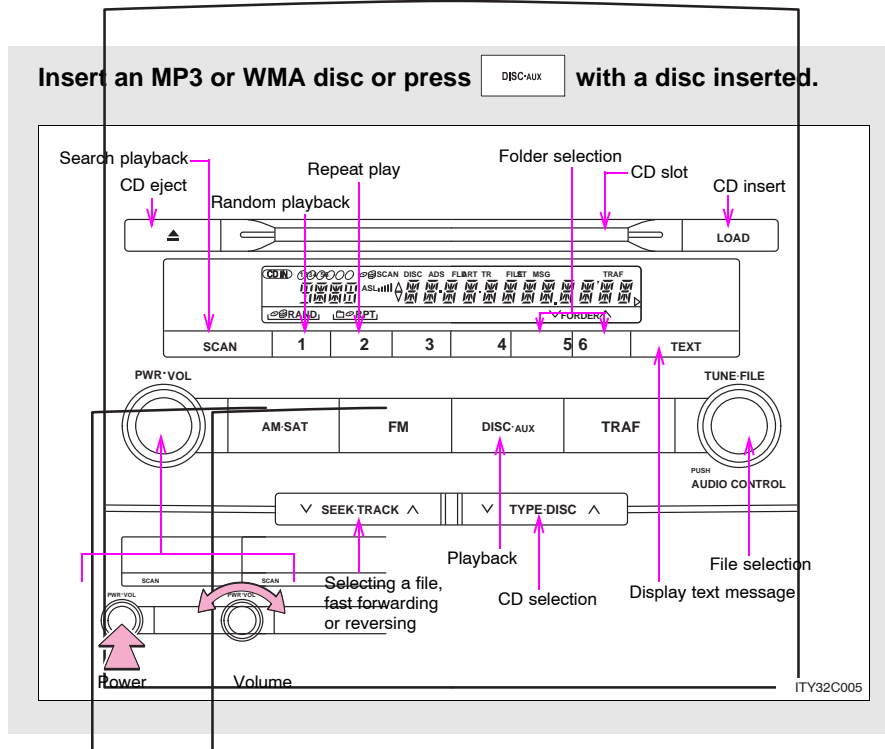

#### Loading and ejecting MP3 and WMA discs

Refer to the section entitled "Using the CD player" for details.  
( P. 265)

#### Selecting a CD

Refer to the section entitled "Using the CD player" for details.  
( P. 265)

### Selecting and scanning a folder

n **Selecting folders one at a time**

Press  ( ) or  ( ) to select the desired folder.

To return to the first folder, press and hold  ( ) until you hear a beep.

n **Selecting the desired folder by cueing the first file of each folder**

Press and hold  until you hear a beep.

When the desired folder is reached, press the switch once again.

### Selecting and scanning a file

n **Selecting one file at a time**

Turn the  dial or press “ ” or “ ” on  to select the desired file.

n **Selecting the desired file by cueing the files in the folder**

Press

When the desired file is reached, press  once again.

### Fast forwarding and reversing files

Press and hold “ ” or “ ” on  .

### Random playback

- n **To play files from a particular folder in random order**

Press ).

- n **To play all of the files on a disc in random order**

Press and hold  (RAND) until you hear a beep.

### Repeating a file or a folder

- n **Repeating a file**

Press

- n **Repeating a folder**

Press and hold  (RPT) until you hear a beep.

### Switching the display

Press

Each time the switch is pressed, the display changes in the order of  
Folder no./File no./Elapsed time Folder name File name Album title  
(MP3 only) Track title Artist name.

**n Display**

Up to 12 characters can be displayed at a time.

If there are 13 characters or more, pressing and holding  for 1 second or more will display the remaining characters.

A maximum of 24 characters can be displayed.

If  is pressed for 1 second or more again or has not been pressed for 6 seconds or more, the display will return to the first 12 characters.

Depending on the contents recorded, the characters may not be displayed properly or may not be displayed at all.

**n Canceling random, repeat and scan playback**

Press  (RAND),  (RPT) or  again.

**n Error messages**

“ERROR”: This indicates a trouble either in the CD or inside the player. The CD may be dirty, damaged or inserted up-side down.

“NO MUSIC”: This indicates that the MP3/WMA file is not included in the CD.

**n Discs that can be used**

Discs with the marks shown below can be used.

Playback may not be possible depending on recording format or disc features, or due to scratches, dirt or deterioration.



**n CD player protection feature**

To protect the internal components, playback is automatically stopped when a problem is detected.

**n If CDs are left inside the CD player or in the ejected position for extended periods**

CDs may be damaged and may not play properly.



### ■ **Lens cleaners**

Do not use lens cleaners. Doing so may damage the CD player.

### ■ **MP3 and WMA files**

MP3 (MPEG Audio LAYER3) is a standard audio compression format.

Files can be compressed to approximately 1/10 of their original size by using MP3 compression.

WMA (Windows Media™ Audio) is a Microsoft audio compression format.

This format compresses audio data to a size smaller than that of the MP3 format.

There is a limit to the MP3 and WMA file standards and to the media/formats recorded by them that can be used.

#### ┆ MP3 file compatibility

- Compatible standards  
MP3 (MPEG1 LAYER3, MPEG2 LSF LAYER3)
- Compatible sampling frequencies  
MPEG1 LAYER3: 32, 44.1, 48 (kHz)  
MPEG2 LSF LAYER3: 16, 22.05, 24 (kHz)
- Compatible bit rates  
MPEG1 LAYER3: 64, 80, 96, 112, 128, 160, 192, 224, 256, 320 (kbps)
- MPEG2 LSF LAYER3: 64, 80, 96, 112, 128, 144, 160 (kbps)  
\* Compatible with VBR
- Compatible channel modes: stereo, joint stereo, dual channel and monaural

#### ┆ WMA file compatibility

- Compatible standards  
WMA Ver. 7, 8, 9
- Compatible sampling frequencies  
32, 44.1, 48 (kHz)
- Compatible bit rates  
Ver. 7, 8: CBR 48, 64, 80, 96, 128, 160, 192 (kbps)  
Ver. 9: CBR 48, 64, 80, 96, 128, 160, 192, 256, 320 (kbps)  
\* Only compatible with 2-channel playback

## 3-2. Using the audio system

### I Compatible media

Media that can be used for MP3 and WMA playback are CD-Rs and CD-RWs.

Playback in some instances may not be possible, depending on the status of the CD-R or CD-RW. Playback may not be possible or the audio may jump if the disc is scratched or marked with fingerprints.

### I Compatible disc formats

The following disc formats can be used.

- Disc formats: CD-ROM Mode 1 and Mode 2  
CD-ROM XA Mode 2, Form 1 and Form 2
- File formats: ISO9660 Level 1, Level 2, (Romeo, Joliet)  
MP3 and WMA files written in any format other than those listed above may not play correctly, and their file names and folder names may not be displayed correctly.

Items related to standards and limitations are as follows.

- Maximum directory hierarchy: 8 levels
- Maximum length of folder names/file names: 32 characters
- Maximum number of folders: 192 (including the root)
- Maximum number of files per disc: 255

### I File names

The only files that can be recognized as MP3/WMA and played are those with the extension .mp3 or .wma.

### I Multi-sessions

As the audio system is compatible with multi-sessions, it is possible to play discs that contain MP3 and WMA files. However, only the first session can be played.

### I ID3 and WMA tags

ID3 tags can be added to MP3 files, making it possible to record the track title and artist name, etc.

The system is compatible with ID3 Ver. 1.0, 1.1, and Ver. 2.2, 2.3 ID3 tags. (The number of characters is based on ID3 Ver. 1.0 and 1.1.)

WMA tags can be added to WMA files, making it possible to record the track title and artist name in the same way as with ID3 tags.

### I MP3 and WMA playback

When a disc containing MP3 or WMA files is inserted, all files on the disc are first checked. Once the file check is finished, the first MP3 or WMA file is played. To make the file check finish more quickly, we recommend you do not write in any files other than MP3 or WMA files or create any unnecessary folders.

If the discs contain a mixture of music data and MP3 or WMA format data, only music data can be played.

### I Extensions

If the file extensions .mp3 and .wma are used for files other than MP3 and WMA files, they will be mistakenly recognized and played as MP3 and WMA files. This may result in large amounts of interference and damage to the speakers.

### I Playback

- To play MP3 file with steady sound quality, we recommend a fixed bit rate of 128 kbps and a sampling frequency of 44.1 kHz.
- CD-R or CD-RW playback may not be possible in some instances, depending on the characteristics of the disc.
- There is a wide variety of freeware and other encoding software for MP3 and WMA files on the market, and depending on the status of the encoding and the file format, poor sound quality or noise at the start of playback may result. In some cases, playback may not be possible at all.
- When files other than MP3 or WMA files are recorded on a disc, it may take more time to recognize the disc and in some cases, playback may not be possible at all.
- Microsoft, Windows, and Windows Media are the registered trademarks of Microsoft Corporation in the U.S. and other countries.

#### NOTICE

**n CDs and adapters that cannot be used ( P. 271)**

**n Player precautions ( P. 272)**

### 3-2. Using the audio system

## Optimal use of the audio system

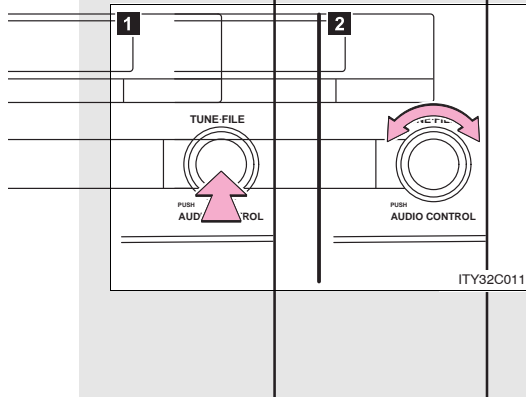

- 1 Displays the current mode
- 2 Changes the following settings

- Sound quality and volume balance

The sound quality and balance setting can be changed to produce the best sound.

- Automatic Sound Levelizer on/off

### Using the AUDIO CONTROL function

#### n Changing modes

Pressing  selects the mode to be change in the following order.

“BAS” “MID” “TRE” “FAD” “BAL” “ASL”



**n Adjusting sound quality**

Turning  adjusts the level.

Sound quality mode	Mode displayed	Level	Turn to the left	Turn to the right
Low-pitched tones*	BAS	-5 to 5	Low	High
Mid-pitched tones*	MID	-5 to 5		
High pitched tones*	TRE	-5 to 5		
Front/rear volume balance	FAD	F7 to R7	Shifts to rear	Shifts to front
Left/right volume balance	BAL	L7 to R7	Shifts to left	Shifts to right

\*: The sound quality level is adjusted individually in each radio, cassette tape or CD mode.

**n Adjusting the Automatic Sound Levelizer (ASL)**

Turning  to the right turns on the ASL, and turning  to the left turns off the ASL.

ASL automatically adjusts the volume and tone quality according to the noise level as you drive your vehicle.

3-2. Using the audio system  
Using the AUX adapter

This adapter can be used to connect a portable audio device and listen to it using the vehicle's speakers.

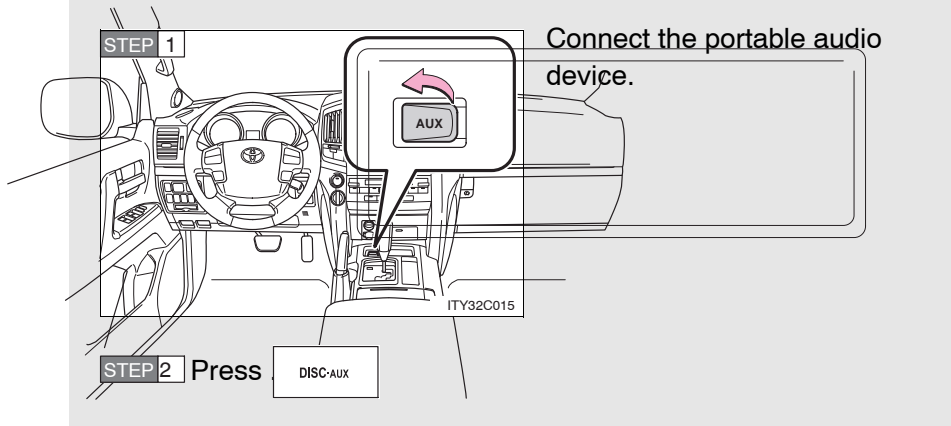

11 **Operating portable audio devices connected to the audio system**

The volume can be adjusted using the vehicle's audio controls. All other adjustments must be made on the portable audio device itself.

### 3-2. Using the audio system Using the steering switches

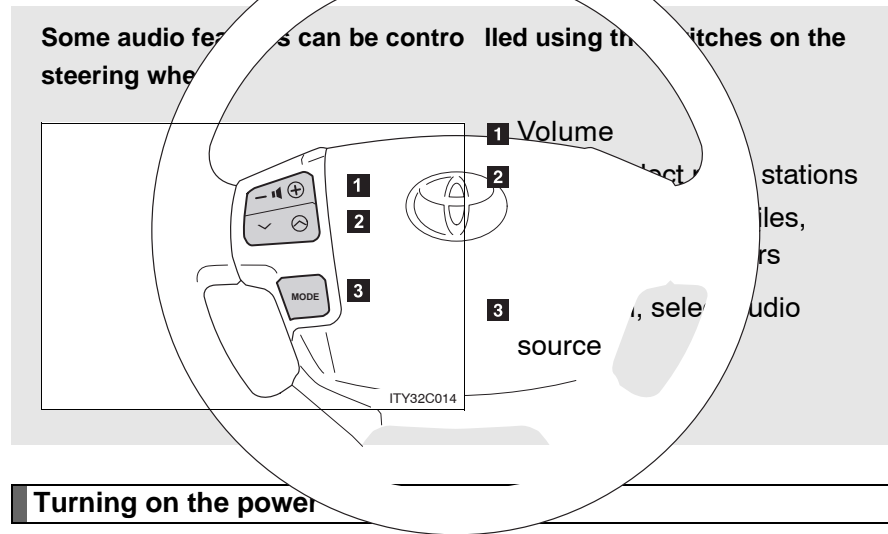

#### Turning on the power

Press  when the audio system is turned off.

The audio system can be turned off by holding the switch down until you hear a beep.

#### Changing the audio source

Press  when the audio system is turned on. The audio source changes as follows each time the button is pressed. If a cassette tape or CD is not inserted, that mode will be skipped.

FM (1, 2) CD player AUX AM

### Adjusting the volume

Press “+” on  to increase the volume and “-” to decrease the volume.

Hold down the button to continue increasing or decreasing the volume.

### Selecting a radio station

**STEP 1** Press  to select the radio mode.

**STEP 2** Press “ ” or “ ” on  to select a radio station.

To scan for receivable stations, press and hold the switch until you hear a beep.

To step up or down the frequency, press and hold the switch ever after you hear a beep.

### Selecting a track/file

**STEP 1** Press  to select the cassette mode, CD or DVD mode.

**STEP 2** Press “ ” or “ ” on  to select the desired track/file.

### Selecting a disc in the CD player

**STEP 1** Press  to select the CD mode.

**STEP 2** Press and hold “ ” or “ ” on  until you hear a beep.

### CAUTION

#### **n To reduce the risk of an accident**

Exercise care when operating the audio switches on the steering wheel.



3-3. Using the rear seat entertainment system  
Rear seat entertainment system features (if equipped)

The rear seat entertainment system is designed for the rear passengers to enjoy audio and DVD video separately from the front audio system.

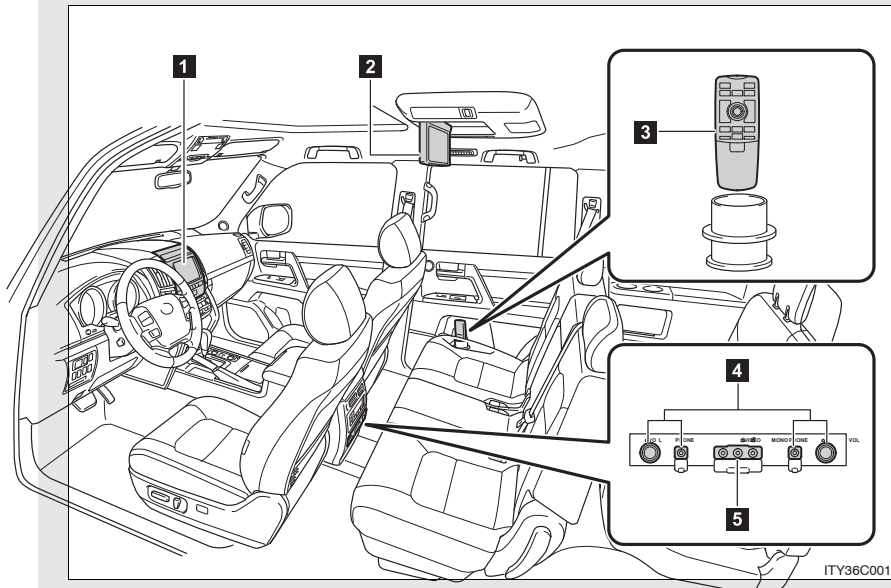

- 1 Front audio system
- 2 Display
- 3 Rear seat entertainment system controller
- 4 Headphone volume control knobs and headphone jacks
- 5 A/V input adapter

### 3-3. Using the rear seat entertainment system

#### Rear seat entertainment system controller

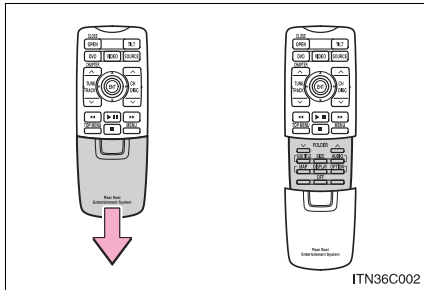

To use the buttons under the cover, slide the cover down.

#### Opening and closing the display

##### n Opening and closing the display

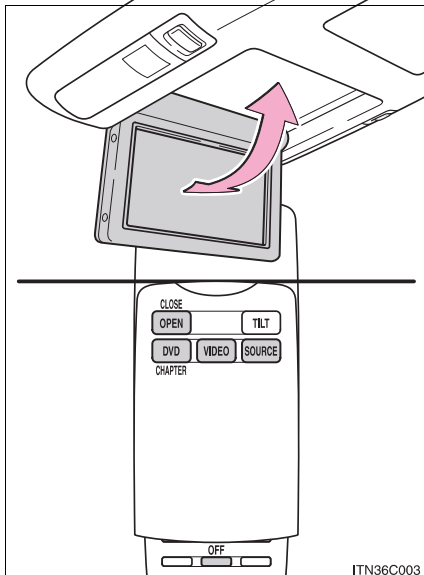

##### 1 Open

Press ,     or  .

##### 1 Close

Press  .

If the display is closed with an image shown, the image will automatically turn off. (The sound will not be turned off.)

Opening and closing operations can be performed from the front seat. ( "Navigation System Owner's Manual")

**n Tilting the display**

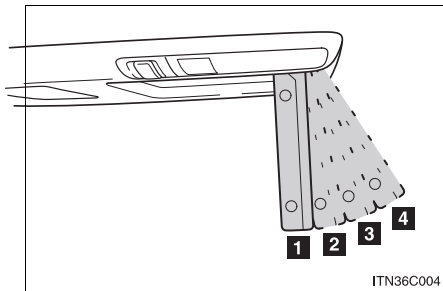

The display angles change as follows each time **TILT** is pressed.



The display angle is memorized and will be recalled when the "ENGINE START STOP" switch is turned to ACCESSORY or IGNITION ON mode again.

**n Caution screen**



This screen appears for a few seconds when the rear display is opened. During this time, only

**CLOSE** **OPEN** can be operated.

**Headphone jacks**

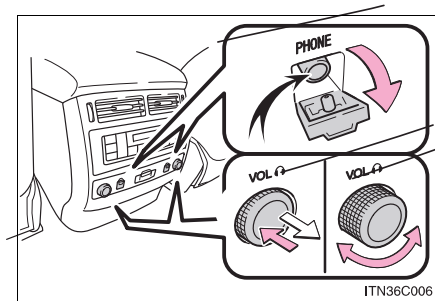

To listen to the rear audio, use headphones.

- 1** To use the headphones  
Connect them to the jack.
- 2** To adjust the volume  
Turn the knob clockwise to increase the volume. Turn the knob counterclockwise to decrease the volume.

### 3-3. Using the rear seat entertainment system

#### Changing the source

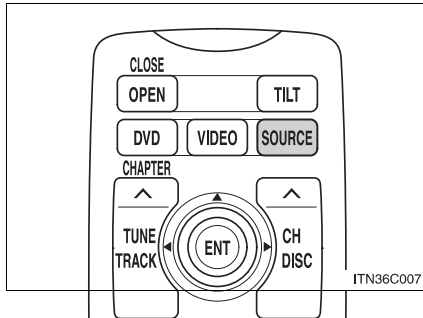

Press **SOURCE** to display the audio source selection screen.

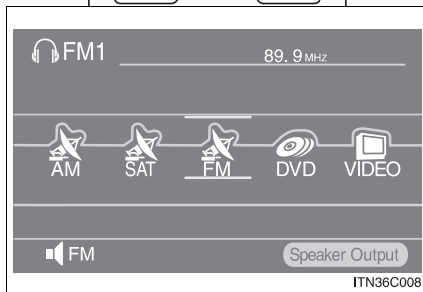

Select an audio source.

#### Changing the speaker output

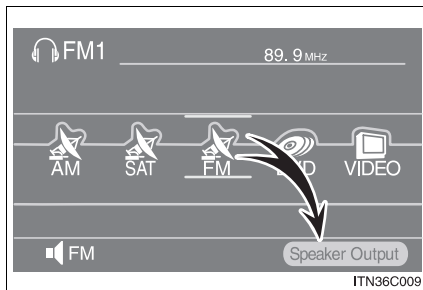

To play the rear audio over the speakers in the vehicle, turn

**Speaker Output** on.

ⓘ **The rear seat entertainment system can be used when**

The “ENGINE START STOP” switch is in ACCESSORY or IGNITION ON mode.

ⓘ **Jam protection function**

The display will stop closing and return to its previous position if something gets in the way of it closing.

ⓘ **When  appears on the screen**

It indicates that the selected icon cannot be used at this time.

ⓘ

”Navigation System Owner’s Manual”

ⓘ **Before using the controller (for new vehicle owners)**

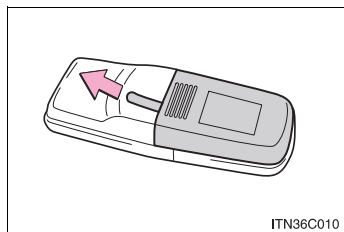

An insulating sheet is set to prevent the batteries from being depleted. Remove the insulating sheet before using the remote control.

ⓘ **When the controller batteries are fully depleted**

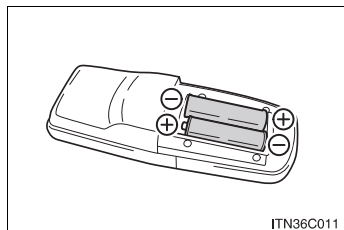

Remove the depleted batteries and install new batteries.

ⓘ **Headphones**

With some headphones generally available in the market, it may be difficult to catch signals properly. Toyota recommends the use of Toyota genuine wireless headphones.

Contact your Toyota dealer for further details.

### 3-3. Using the rear seat entertainment system

#### n **Volume**

- I Adjust the volume when you connect the headphones to the jack. Loud sounds may have a significant impact on the human body.
- I Conversational speech on some DVDs is recorded at a low volume to emphasize the impact of sound effects. If you adjust the volume assuming that the conversations represent the maximum volume level that the DVD will play, you may be startled by louder sound effects or when you change to a different audio source. Be sure to adjust the volume with this in mind.

#### **CAUTION**

##### n **When the rear seat entertainment system is not used**

Keep the display closed.

In the event of an accident or sudden braking, an occupant may hit the opened display, resulting in injury.

##### n **To prevent accidents and electric shock**

Do not disassemble or modify the remote control.

##### n **When the remote controller is not used**

Stow the remote controller.

Injuries may result in the event of an accident or sudden braking.

##### n **Closing the display**

Never use any part of your body to intentionally activate the jam protection function.

 NOTICE

**n Cleaning the display**

Wipe the display with a dry soft cloth.

If the screen is wiped with a rough cloth, the surface of the screen may be scratched.

**n To prevent damage to the remote control**

**I** Keep the remote control away from direct sunlight, high temperature and high humidity.

**I** Do not drop or knock the remote control against hard objects.

**I** Do not sit on or place heavy objects on the remote control.

**n DVD player**

Never try to disassemble or oil any part of the DVD player. Do not insert anything other than a disc into the slot.

**n Closing the display**

Do not close the display using your hand. Doing so may result in a malfunction.

### 3-3. Using the rear seat entertainment system

## Using the radio

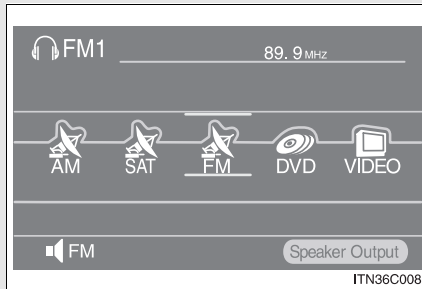



Select radio mode on the source screen to display the control screen.

#### Selecting a preset station

Press **or** on  until the desired station band appears on the screen.

#### Tuning the station

Press **or** on  until the desired station appears on the screen.

Press **or** on  and the stations will be searched automatically one after another.



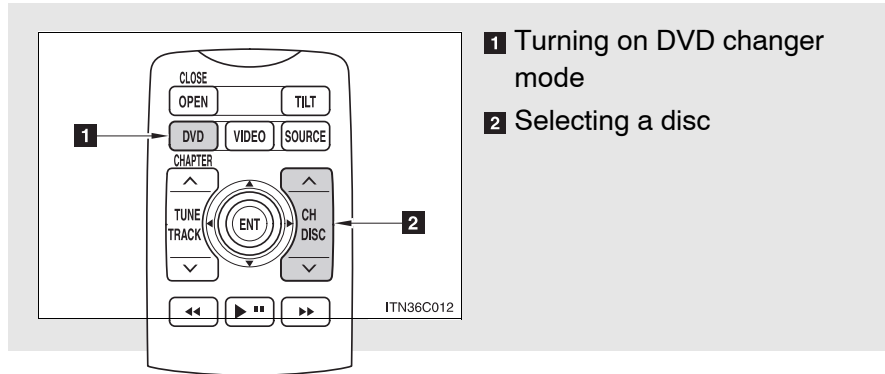

### 3-3. Using the rear seat entertainment system Using the DVD changer

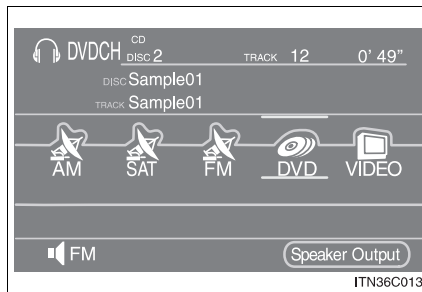

#### Selecting a disc



Press  or  on  until the desired slot number appears on the screen.



- 1 Audio CD, CD text P. 294
- 1 MP3/WMA disc P. 295
- 1 DVD video/audio P. 296
- 1 Video CD P. 310

### 3-3. Using the rear seat entertainment system

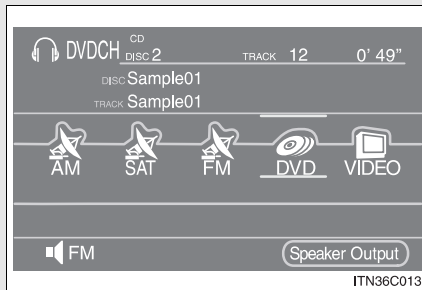

## Playing an audio CD/CD text

#### n **Selecting a track**



Press  or  on  until the desired track number appears on the screen.



#### n **Fast forwarding or reversing a track**

Press and hold  or  on  .

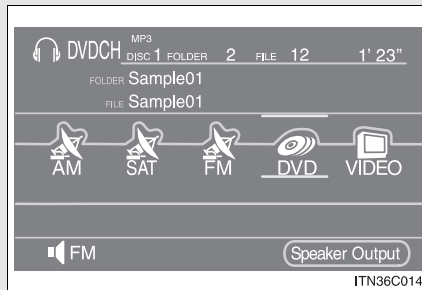

### 3-3. Using the rear seat entertainment system Playing WMA/MP3 discs

#### n **Selecting a file**





Press  or  on  until the desired file number appears on the screen.

#### n **Selecting a folder**

Press  or  on  until the desired folder number appears on the screen.

#### n **Fast forwarding or reversing a file**

Press  or  on  .

3-3. Using the rear seat entertainment system  
**Playing DVD video/audio**

n **Controller**

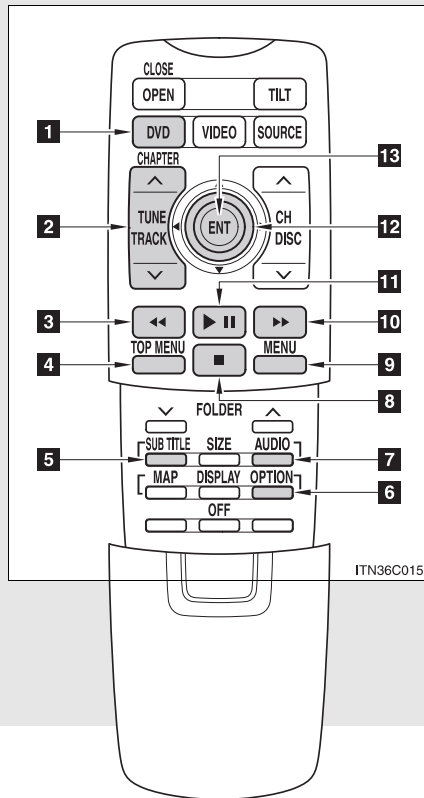



- 1** Turning on the DVD mode
- 2** Selecting a chapter/track
- 3** Reversing a disc
- 4** Turning on the title selection screen
- 5** Changing the subtitle language
- 6** Turning on the control icon screen
- 7** Changing the audio language
- 8** Stopping a disc
- 9** Turning on the menu disc
- 10** Fast forwarding a disc
- 11** Playing/pausing a disc
- 12** Selecting an icon
- 13** Inputting the selected icon

n **Control icon screen**

Press **OPTION** if no icons are shown while watching a DVD video, and the following screen appears.

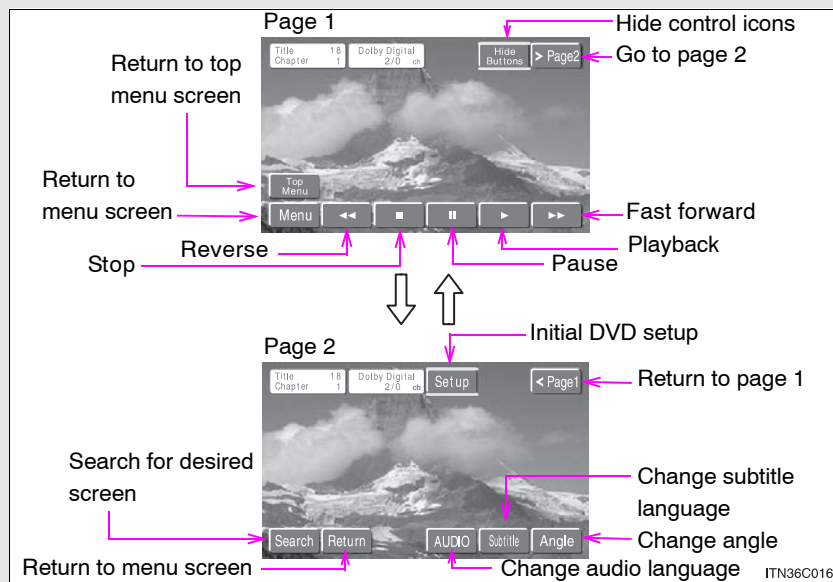
► DVD video mode



If  appears on the screen when you select an icon, the operation relevant to that control is not permitted.

### 3-3. Using the rear seat entertainment system

#### ► DVD audio mode

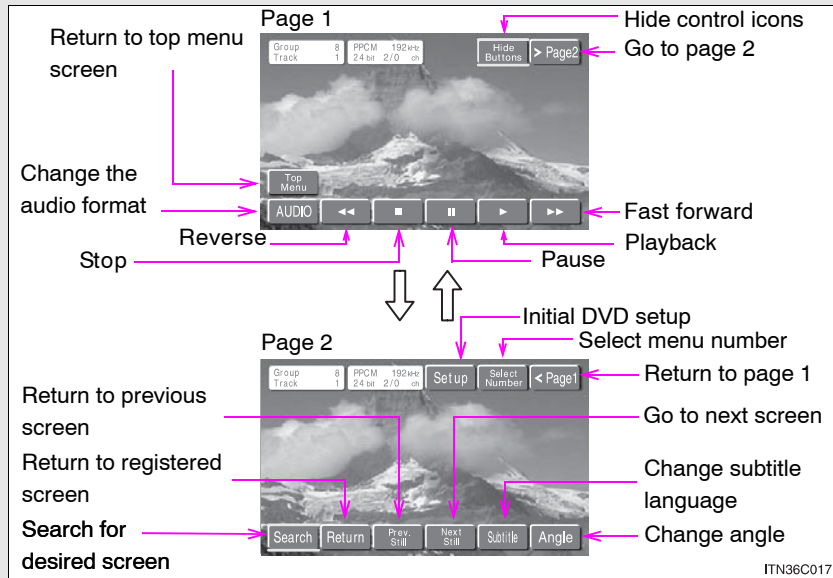



If  appears on the screen when you select an icon, the operation relevant to that control is not permitted.

**Turning on or off the control icons**



Press **OPTION**  to turn on the control icons.

Press **OPTION**  once again or select  to turn off the control icon.

**Turning on the title selection screen**



Press **TOP MENU**  or select  to turn on the title selection screen. For the operation of the title selection screen, see the separate manual for the DVD disc.

**Turning on the menu screen (DVD video mode only)**

Press **MENU**  or select  to turn on the menu screen. For the operation of the menu screen, see the separate manual for the DVD disc.

**Fast forwarding/reversing a disc**





Perform either of the following:

- 1 Select  or  on the screen by pressing and holding



- 1 Press and hold  or  on

**Slow playback**

Select  and then select . Video is played slowly when you select  by pressing and holding .

### Returning to the previous screen

Select **Return** to return to the previous screen. For the operation of the menu screen, see the separate manual for the DVD disc.

### Searching for a desired screen

#### n Searching by title (DVD video mode)

**STEP 1** Select **Search** on the control icon screen.

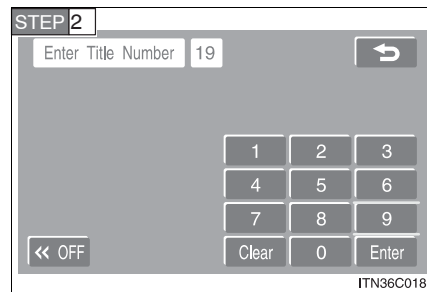

Input the desired title number and then select **Enter**.

**Clear**: deletes the last input number

**<< OFF**: hides the icons. To display the icons, select **>> ON**.

**Return Arrow**: returns to the previous screen

#### n Searching by group (DVD audio mode)

**STEP 1** Select **Search** on the control icon screen.

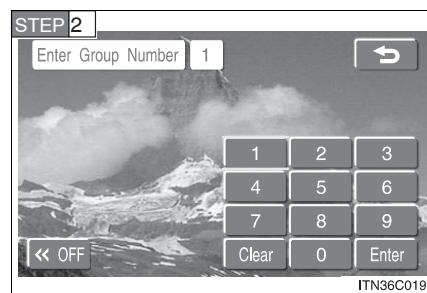

Input the group number and then select **Enter**.

**Clear**: deletes the last input number

**<< OFF**: hides the icons. To display the icons, select **>> ON**.

**Return Arrow**: returns to the previous screen



n **Playing a bonus group (DVD audio mode only, if the DVD has bonus options)**

**STEP 1** Select **Search** on the control icon screen.

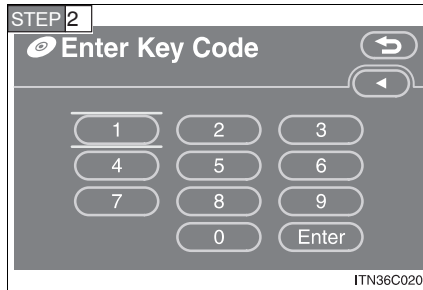

Input the desired bonus group number on the group search screen and select **Enter** .

: deletes the number

: returns to the previous screen

n **Searching by chapter/track**

Press or on to select a chapter/track.

n **Selecting a menu number (DVD audio mode only)**

**STEP 1** Select **Select Number** on the control icon screen.

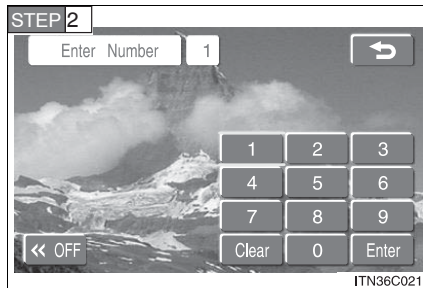

Input the desired menu number on the screen and select **Enter** .

### 3-3. Using the rear seat entertainment system

#### Changing the subtitle language

**STEP 1** Press **SUB TITLE** or select **Subtitle** on the control icon screen.

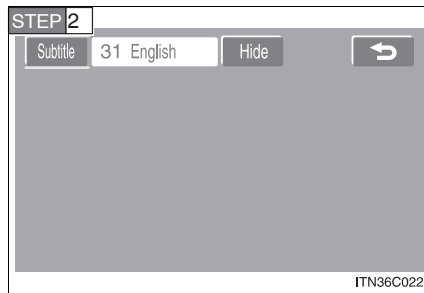

Select **Subtitle**

Each time you press **ENT** the next available language is selected.

**Hide** : hides the control icons

**↩** : returns to the previous screen

#### Changing the audio language (DVD video only)

**STEP 1** Press **AUDIO** or select **AUDIO** on the control icon screen.

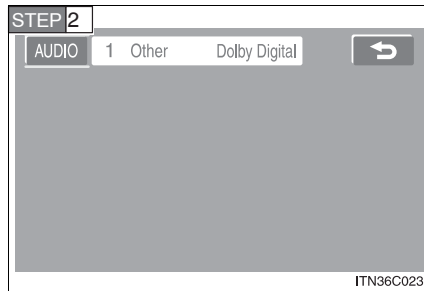

Select **AUDIO**

Each time you press **ENT** the next available language is selected.

**↩** : returns to the previous screen

### Changing the audio format (DVD audio only)

**STEP 1** Press **AUDIO** or select **AUDIO** on the control icon screen.

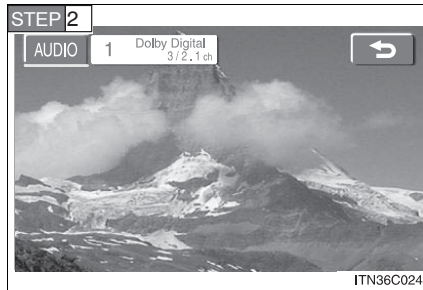

Select **AUDIO**

Each time you press  the next available audio format is selected.

 : returns to the previous screen

### Changing the angle (If the angle option is available)

**STEP 1** Select **Angle** on the control icon screen.

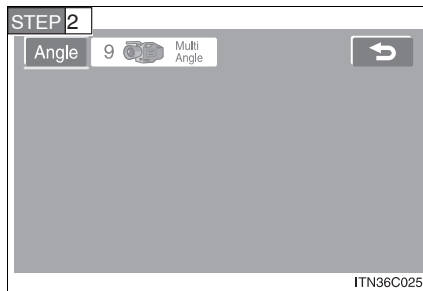

Select **Angle**

Each time you press  the next available angle is selected.

 : returns to the previous screen

## Initial DVD setup

### n Displaying “Setup Menu” screen

**STEP 1** Select **Setup** on the control icon screen.

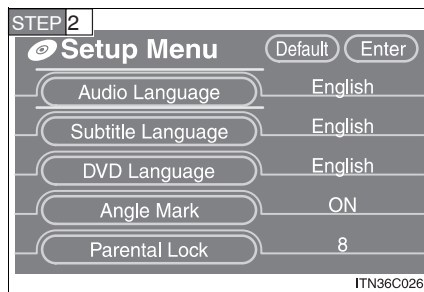

After you change the initial settings, select **Enter**.

**Default** : restores default settings

### n Setting audio language

**STEP 1** Select **Audio Language** on the “Setup Menu” screen.

**STEP 2** Select the desired language.

If you cannot find the desired language, select “Other” and input the desired language code. ( P. 307)

 : returns to the previous screen

### n Setting subtitle language

**STEP 1** Select **Subtitle Language** on the “Setup Menu” screen.

**STEP 2** Select the desired language.

If you cannot find the desired language, select “Other” and input the desired language code. ( P. 307)

 : returns to the previous screen

### n Setting menu language

**STEP 1** Select **DVD Language** on the “Setup Menu” screen.



**STEP 2** Select the desired language.

If you cannot find the desired language, select “Other” and input the desired language code. ( P. 307)

 : returns to the previous screen

### n **Setting angle mark “ON” or “OFF”**

If the DVD has angle options, you can turn the angle mark on or off.

Select  on the “Setup Menu” screen. Each time you press , the multi angle mark on the screen turns on or off alternately.

### n **Parental lock**

**STEP 1** Select  on the “Setup Menu” screen.

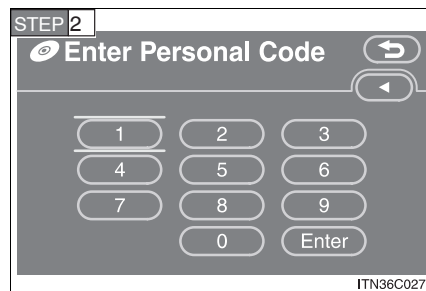

Input the 4-digit password and then select .

If you enter wrong numbers, select  to delete the numbers.

Select  10 times to initialize the personal code.

**STEP 3** Select a parental level (1 – 8). ( “Navigation System Owner’s Manual”)

: returns to the previous screen

### n **Entering a language code**

If you select “Other” on the “Select Audio Language” screen, “Select Subtitle Language” screen or “DVD Language” screen, you can select a language by entering the 4-digit language code if that language is available.

### 3-3. Using the rear seat entertainment system

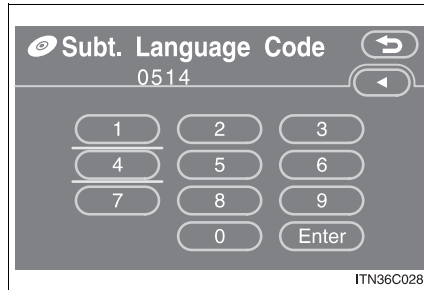

Input the 4-digit language code and then select **Enter** .

 : deletes the last input digit

 : returns to the previous screen

## 1 Language codes

Code	Language	Code	Language	Code	Language
0514	English	0207	Bulgarian	0712	Galician
0618	French	0208	Bihari	0714	Guarani
0405	German	0209	Bislama	0721	Gujarati
0920	Italian	0214	Bengali	0801	Hausa
0519	Spanish	0215	Tibetan	0809	Hindi
2608	Chinese	0218	Breton	0818	Croatian
1412	Dutch	0301	Catalan	0821	Hungarian
1620	Portuguese	0315	Corsican	0825	Armenian
1922	Swedish	0319	Czech	0901	Interlingua
1821	Russian	0325	Welsh	0905	Interlingue
1115	Korean	0401	Danish	0911	Inupiak
0512	Greek	0426	Bhutani	0914	Indonesian
0101	Afar	0515	Esperanto	0919	Icelandic
0102	Abkhazian	0520	Estonian	0923	Hebrew
0106	Afrikaans	0521	Basque	1001	Japanese
0113	Amharic	0601	Persian	1009	Yiddish
0118	Arabic	0609	Finnish	1023	Javanese
0119	Assamese	0610	Fiji	1101	Georgian
0125	Aymara	0615	Faroese	1111	Kazakh
0126	Azerbaijani	0625	Frisian	1112	Greenlandic
0201	Bashkir	0701	Irish	1113	Cambodian
0205	Byelorussian	0704	Scots-Gaelic	1114	Kannada

3-3. Using the rear seat entertainment system

Code	Language	Code	Language	Code	Language
1119	Kashmiri	1415	Norwegian	1914	Shona
1121	Kurdish	1503	Occitan	1915	Somali
1125	Kirghiz	1513	(Afan) Oromo	1917	Albanian
1201	Latin	1518	Oriya	1918	Serbian
1214	Lingala	1601	Panjabi	1919	Siswati
1215	Laothian	1612	Polish	1920	Sesotho
1220	Lithuanian	1619	Pashto, Pushto	1921	Sundanese
1222	Latvian	1721	Quechua	1923	Swahili
1307	Malagasy	1813	Rhaeto- Romance	2001	Tamil
1309	Maori	1814	Kirundi	2005	Telugu
1311	Mace- donian	1815	Romanian	2007	Tajik
1312	Malayalam	1823	Kin- yarwanda	2008	Thai
1314	Mongolian	1901	Sanskrit	2009	Tigrinya
1315	Moldavian	1904	Sindhi	2011	Turkmen
1318	Marathi	1907	Sangho	2012	Tagalog
1319	Malay	1908	Serbo- Croatian	2014	Setswana
1320	Maltese	1909	Sinhalese	2015	Tonga
1325	Burmese	1911	Slovak	2018	Turkish
1401	Nauru	1912	Slovenian	2019	Tsonga
1405	Nepali	1913	Samoan	2020	Tatar



### 3-3. Using the rear seat entertainment system

Code	Language	Code	Language	Code	Language
2023	Twi	2209	Vietnamese	2515	Yoruba
2111	Ukrainian	2215	Volapük	2621	Zulu
2118	Urdu	2315	Wolof		
2126	Uzbek	2408	Xhosa		

#### n Error messages

If “Region Code Error” is displayed, check if the region code printed on the DVD matches the player’s region code.

If a different message is displayed: P. 314

### 3-3. Using the rear seat entertainment system Playing a video CD

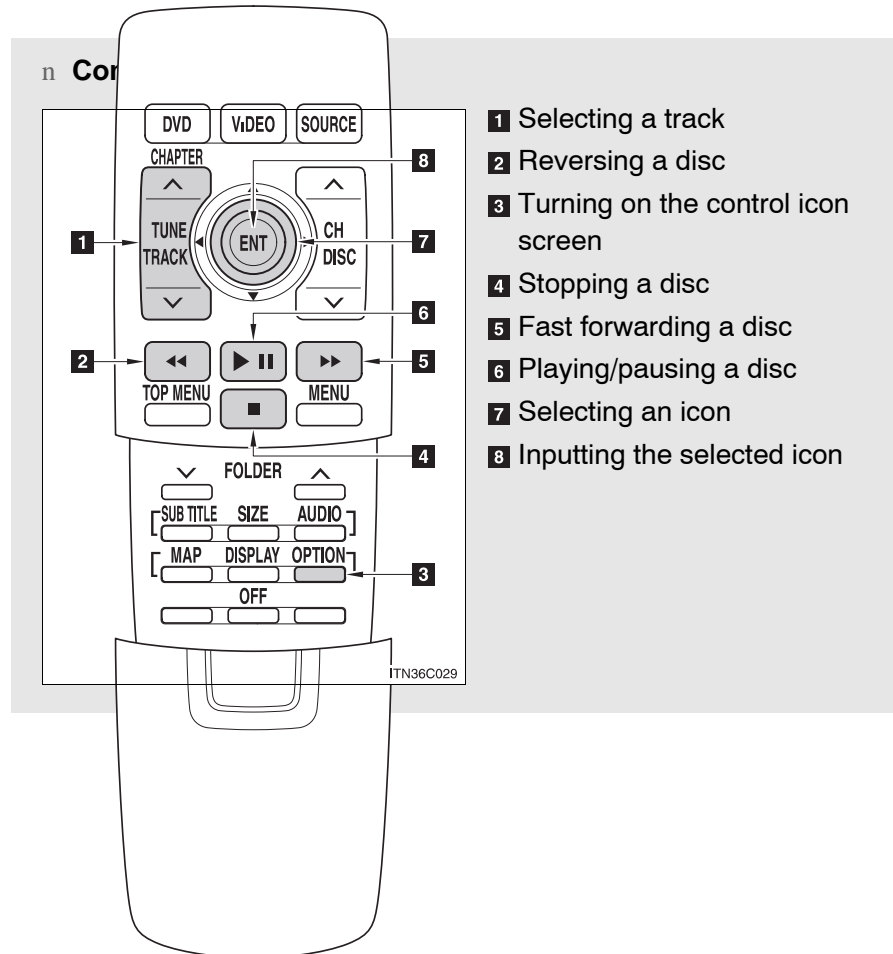

### 3-3. Using the rear seat entertainment system

#### n Control icon screen

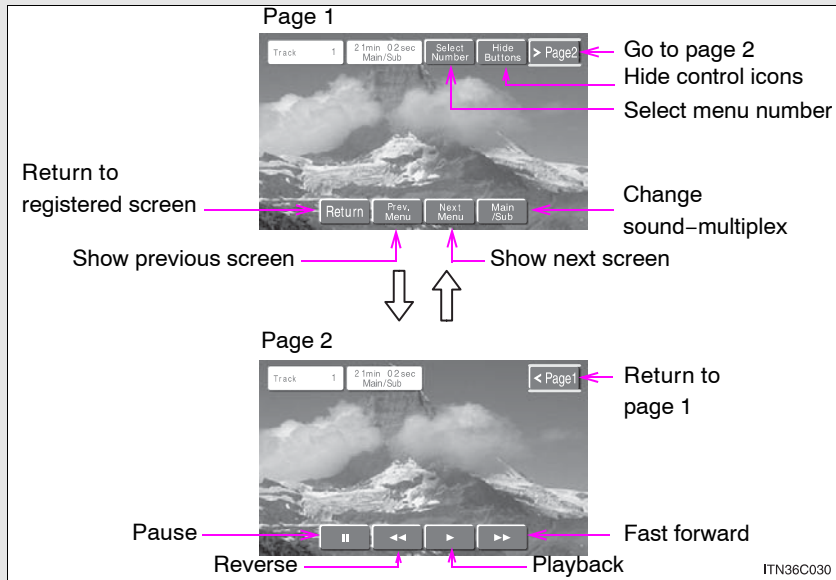

Press **OPTION** if no icons are shown while watching a video CD, and the following screen appears.





If  appears on the screen when you select an icon, the operation relevant to that control is not permitted.

### Fast forwarding/reversing the video CD

Perform either of the following:





- 1 Select  or  on the screen by pressing and holding



- 1 Press and hold  or  on



### Slow playback

Select  and then select  . Video is played slowly when you select  by pressing and holding  .

### Using the video CD menu

Select  .

Refer to the manual that comes with the video CD for specific menu items.

**Selecting a desired screen**

**n Selecting a menu number**

**STEP 1** Select **Select Number** on the control icon screen.

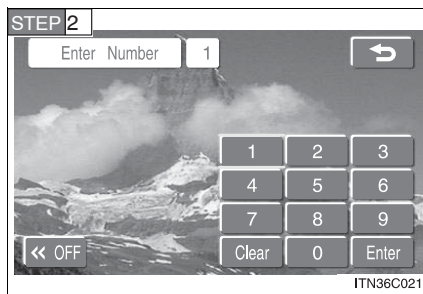

Input the desired menu number on the screen and select **Enter**.

**n Searching manually**

Select **Prev. Menu** or **Next Menu** on the screen, or press or  until the desired screen appears.

3 Interior features

**Changing the sound-multiplex mode**

Select **Main /Sub** on the control icon screen. The mode cycles through each time the  is pressed.

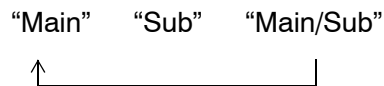

### 3-3. Using the rear seat entertainment system DVD player and DVD video disc information

#### n Error messages







Message	Cause	Correction Procedures
No Disc	There is no disc in the CD or DVD changer	Insert a disc
DISC X Check	<ul style="list-style-type: none"> <li>• The disc X is dirty or damaged</li> <li>• The disc X is inserted upside down</li> <li>• The disc X is not playable with the player</li> </ul>	<ul style="list-style-type: none"> <li>• Clean the disc</li> <li>• Insert the disc correctly</li> <li>• Confirm the disc is playable with the player</li> </ul>
DVD Error	<ul style="list-style-type: none"> <li>• There is a malfunction within the system</li> <li>• Operation is stopped due to a high temperature inside the player</li> </ul>	<ul style="list-style-type: none"> <li>• Eject the disc</li> <li>• Eject the disc and allow the player to cool down</li> </ul>
NO MUSIC FILE	This indicates that no playable data is included in the disc	Eject the disc

n **DVD video discs**

- l The DVD player conforms to NTSC color TV formats.
- l **Region code:** Some DVD video discs have a region code indicating the region in which you can use the DVD video disc. If the DVD video disc is not labeled as “ALL” or “1”, you cannot use it on this DVD player. If you attempt to play an inappropriate DVD video disc on this player, “Region Code Error” appears on the screen. Even if the DVD video disc does not have a region code, you may not be able to use it.
- l The front DVD player supports multi-channel surround sound. The rear DVD player does not support multi-channel surround sound. (only 2-channel sound is output.)

### 3-3. Using the rear seat entertainment system

#### n Symbols shown on DVD video discs

Symbol	Meaning
	Indicates NTSC format.
	Indicates the number of audio tracks.
	Indicates the number of language subtitles.
	Indicates the number of angles.
	Indicates the screen display ratios available. Wide screen: 16:9 Standard: 4:3
	Indicates the disc's region code. ALL: in all countries Number: region code



□ **Discs that can be used**

Discs with the marks shown below can be used.  
Playback may not be possible depending on recording format or disc features, or due to scratches, dirt or deterioration.



□ **DVD video disc information**

□ **DVD video discs**

Digital Versatile Disc that holds video. DVD video discs have adopted “MPEG2”, one of the world standards of digital compression technologies. The picture data is compressed by 1/40 on average and stored. Variable rate encoding technology in which the volume of data assigned to the picture is changed depending on the picture format has also been adopted. Audio data is stored using PCM and Dolby digital, which enables higher quality of sound. Furthermore, multi-angle and multi-language features will also help you enjoy the more advanced technology of DVD video.

### 3-3. Using the rear seat entertainment system

#### I Viewer restrictions

This feature limits what can be viewed in conformity with the level of restrictions of the country. The level of restrictions varies depending on the DVD video disc. Some DVD video discs cannot be played at all, or violent scenes are skipped or replaced with other scenes.

Level 1: DVD video discs for children can be played.

Level 2-7: DVD video discs for children and G-rated movies can be played.

Level 8: All types of DVD video discs can be played.

#### I Multi-angle option

You can enjoy the same scene from different angles.

#### I Multi-language option

You can select the subtitle and audio languages.

#### I Region codes

The region codes are found on DVD players and DVD discs. If a DVD video disc does not have the same region code as the DVD player, you cannot play the disc on that DVD player. ( P. 315)

#### I Audio

This DVD player can play linear PCM, Dolby Digital and MPEG audio format DVD. Other decoded types cannot be played.

#### I Title and chapter

Video and audio programs stored in DVD video discs are divided into parts by title and chapter.

Title: The largest unit of the video and audio programs stored on DVD video discs. Usually, one movie, one album, or one audio program is assigned as a title.

Chapter: A title is comprised of one or more chapters.

n **Sound**

l **Dolby Digital**

Manufactured under license from Dolby Laboratories.

“Dolby”, “Pro Logic”, and the double-D symbol are trademarks of Dolby Laboratories. Confidential unpublished works.

©1992–1997 Dolby Laboratories. All rights reserved.

This product incorporates copyright protection technology that is protected by method claims of certain U. S. patents and other intellectual property rights owned by Macrovision Corporation and other rights owners. Use of this copyright protection technology must be authorized by Macrovision Corporation, and is intended for home and other limited viewing uses only unless otherwise authorized by Macrovision Corporation.

Reverse engineering or disassembly is prohibited.

l **DTS**

“DTS” and “DTS Digital Surround” are registered trademarks of Digital Theater System, Inc.

n

P. 277

 **CAUTION**

n **DVD video precaution**

Conversational speech on some DVDs is recorded at a low volume to emphasize the impact of sound effects. If you adjust the volume assuming that the conversations represent the maximum volume level that the DVD will play, you may be startled by louder sound effects or when you change to a different audio source.

Loud sounds may have a significant impact on the human body or pose a driving hazard. Keep this in mind when you adjust the volume.

 NOTICE

n

P. 271

n **Player precautions**

Failure to follow the precautions below may result in damage to the discs or the player itself.

- l Do not insert anything other than discs into the disc slot.
- l Do not apply oil to the player.
- l Store discs away from direct sunlight.
- l Never try to disassemble any part of the player.

### 3-3. Using the rear seat entertainment system

## Using the video mode

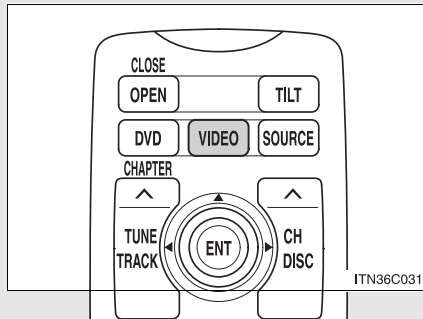

Press **VIDEO** to select the video mode.

Before switching to the video mode, connect the audio-video equipment to the A/V input adapter.

Using t

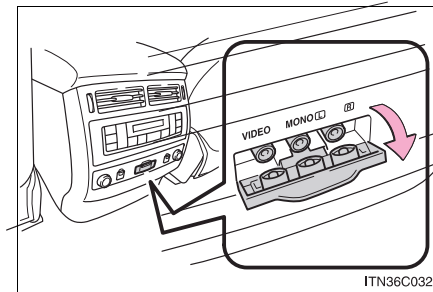

Open the cover.

The A/V input adapter is composed of 3 input adapters.

Yellow: Image input adapter

White: Left channel audio input adapter

Red: Right channel audio input adapter

3

Interior features

## Chan

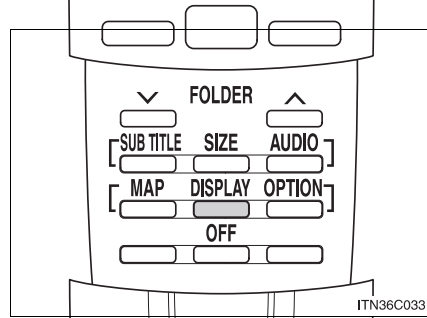

Press **DISPLAY**

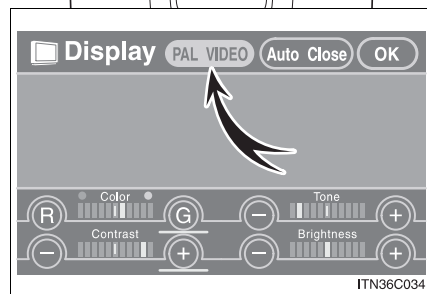

If the video does not appear, turn

**PAL VIDEO** on.

**PAL VIDEO** will be displayed when the audio–video equipment is connected to the A/V input adapter.

#### ■ **A/V input adapter**

The rear seat entertainment system plays videos and sound when audio–video equipment is connected to the A/V input adapter. For details, refer to the manufacturer’s instructions.

#### ■ **Power outlet**

The power outlet is used to connect the audio–video equipment. ( P. 344)

#### **NOTICE**

##### ■ **When the A/V input adapter is not in use**

Keep the A/V input adapter cover closed.  
Inserting anything other than an appropriate plug may cause electrical failure or a short circuit.

**Setti**

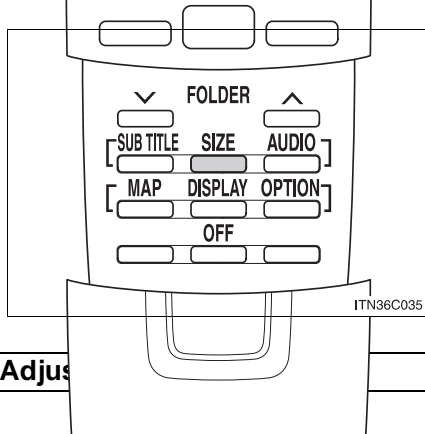

Pressing **SIZE** changes the display modes sequentially as follows:

Normal    Wide 1    Wide 2



**Adjus**

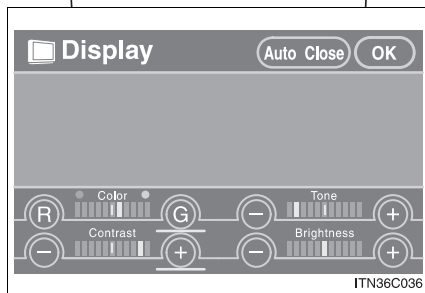

Press **DISPLAY**

Select the brightness, contrast, tone or color, and make adjustments. Press **DISPLAY** or **ENT** to input it.

	<b>(R)</b>	<b>(G)</b>
"Color"	Red	Green
	<b>(-)</b>	<b>(+)</b>
"Tone"	Lighter	Darker
"Contrast"	Weaker	Stronger
"Brightness"	Darker	Brighter

### Automatic closing of the rear display

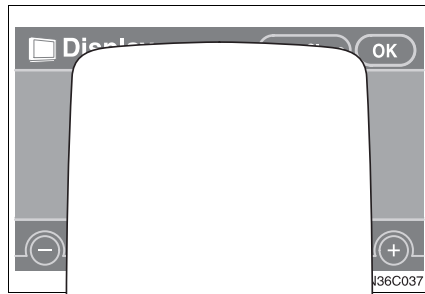

Press **DISPLAY**

If **Auto Close** is on, the display will automatically close when the "ENGINE START STOP" switch is turned to OFF mode.

The display will automatically open when the "ENGINE START STOP" switch is turned to ACCESSORY or IGNITION ON mode.

### Display

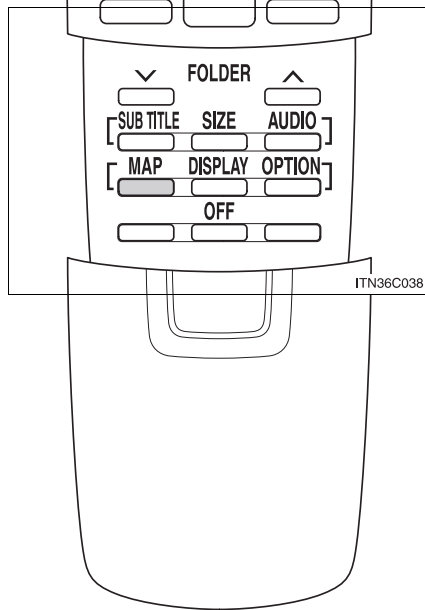

Press **MAP**

The map screen will appear.



### 3-4. Using the interior lights

## Interior lights list

Your Toyota is equipped with the illuminated entry system to assist in entering the vehicle. Owing to the function of the system, the lights shown in the following illustration automatically turn on/off according to the presence of the electronic key, whether the doors are locked/unlocked, whether the doors are opened/closed, and the “ENGINE START STOP” switch mode.

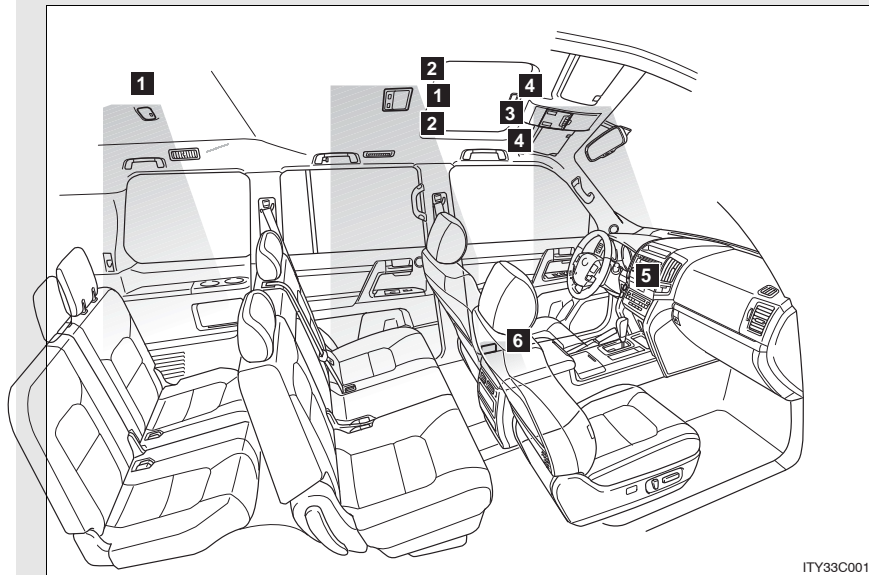

- 1** Rear interior lights ( P. 326)
- 2** Rear personal lights ( P. 327)
- 3** Front interior light ( P. 326)
- 4** Front personal lights ( P. 327)
- 5** “ENGINE START STOP” switch light
- 6** Door courtesy lights

**n To prevent the battery from being discharged**

If the interior lights and “ENGINE START STOP” switch light remain on when the door is not fully closed and the interior light switch is in the “DOOR” position, the lights will go off automatically after 20 minutes.

**n Customization**

Settings (e.g. The time elapsed before lights turn off) can be changed.  
( P. 519)

**Interior lights**

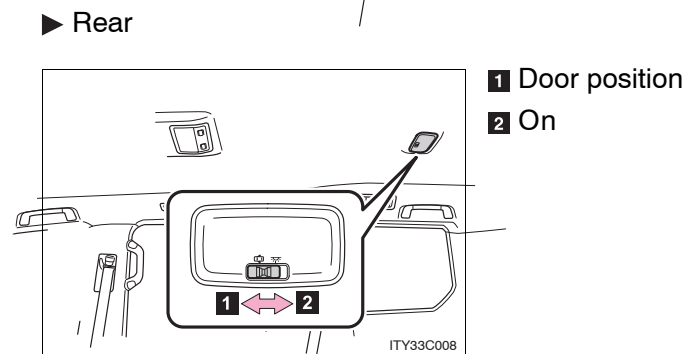
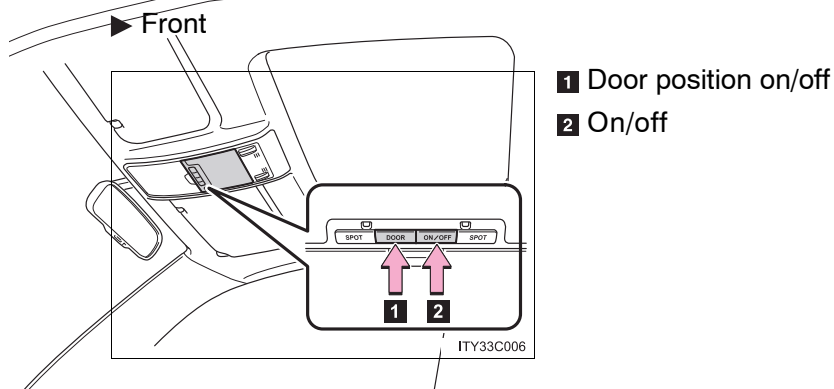

**Personal lights**

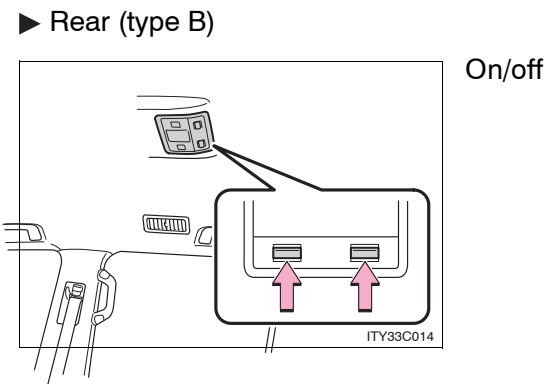
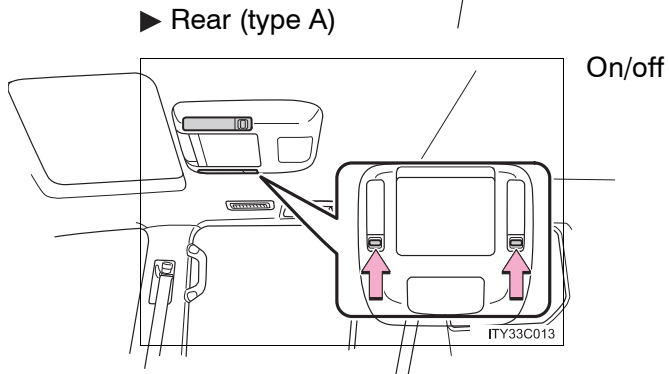
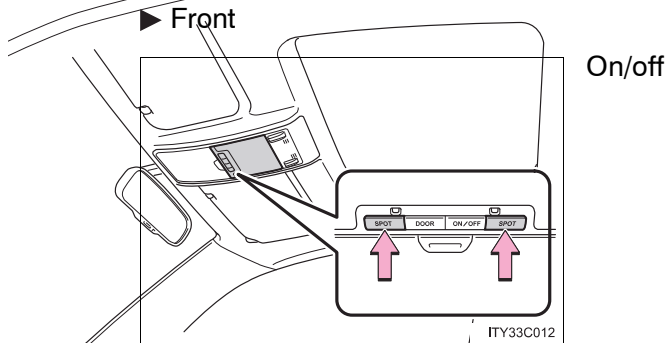

3-5. Using the interior lights  
List of storage features

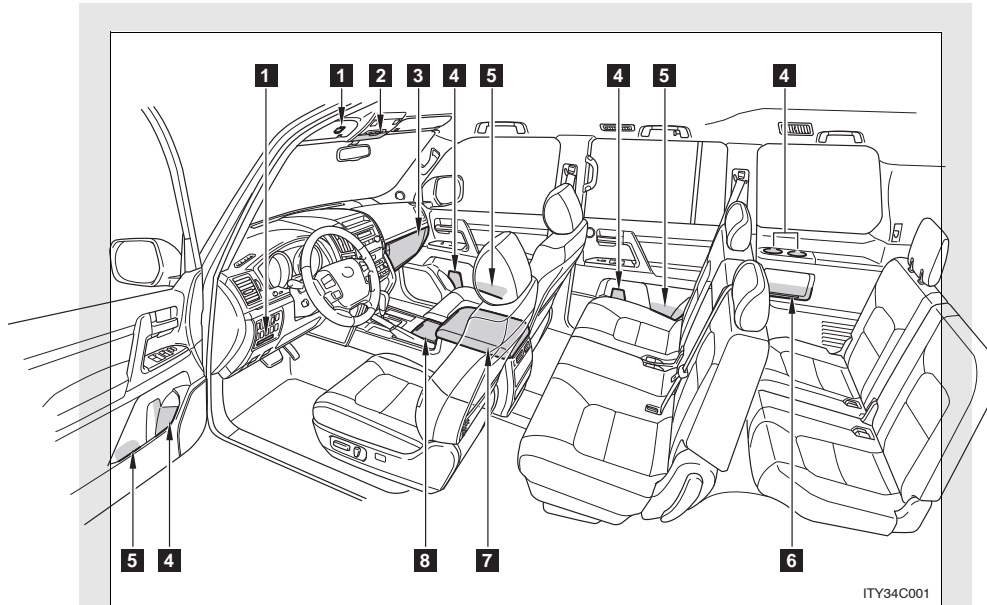

- 1** Card holders
- 2** Overhead console
- 3** Glove box
- 4** Bottle holders
- 5** Door pockets
- 6** Auxiliary box
- 7** Console box/cool box
- 8** Cup holders

**Glove box**

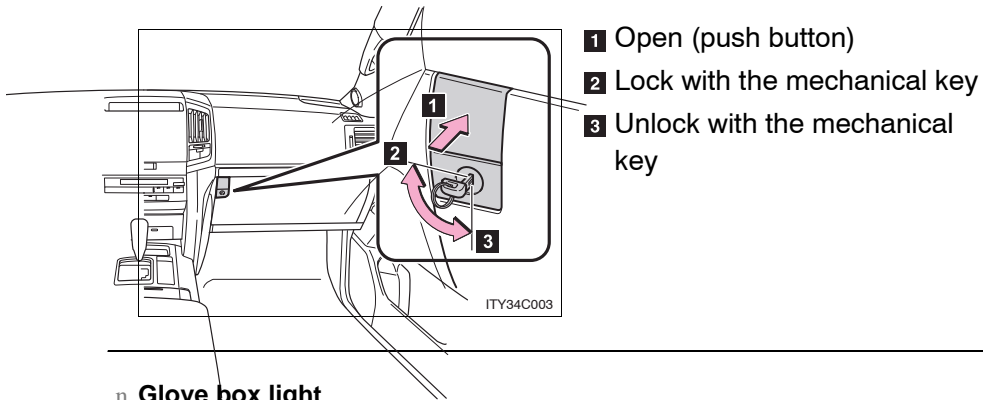

**Glove box light**

The glove box light turns on when the tail lights are on.

**CAUTION**

**While driving**

Keep the glove box closed.  
Injuries may result in the event of an accident or sudden braking.

**Console box/cool box**

Your vehicle is equipped with either a lower console box or cool box.

► Upper console box

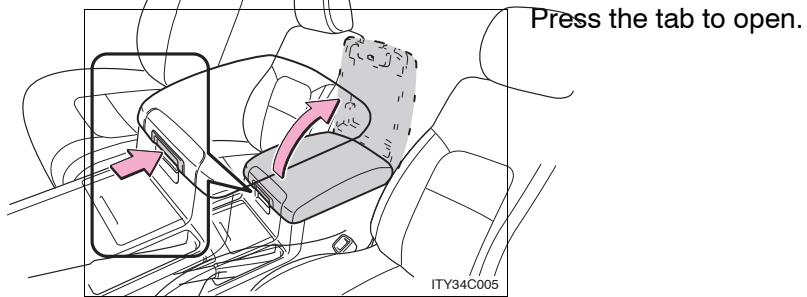

► Lower console box

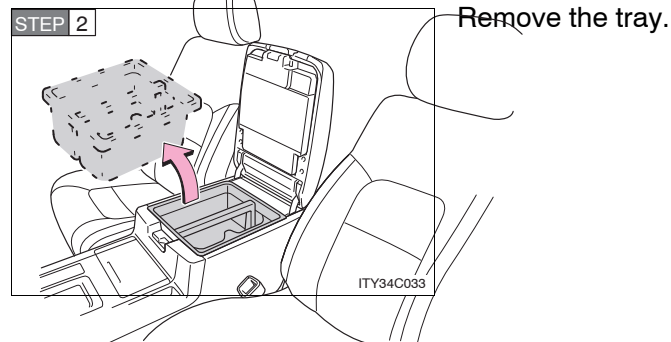
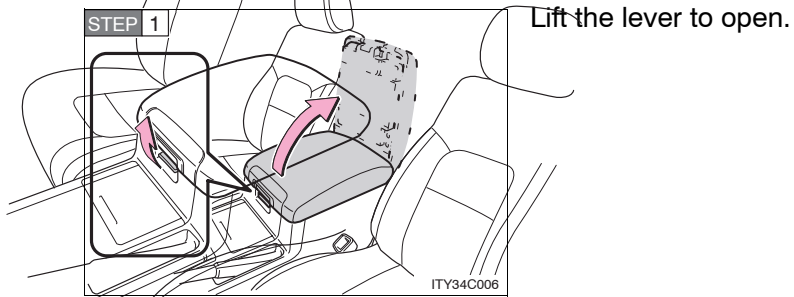

3-5. Using the interior lights

Console box/cool box

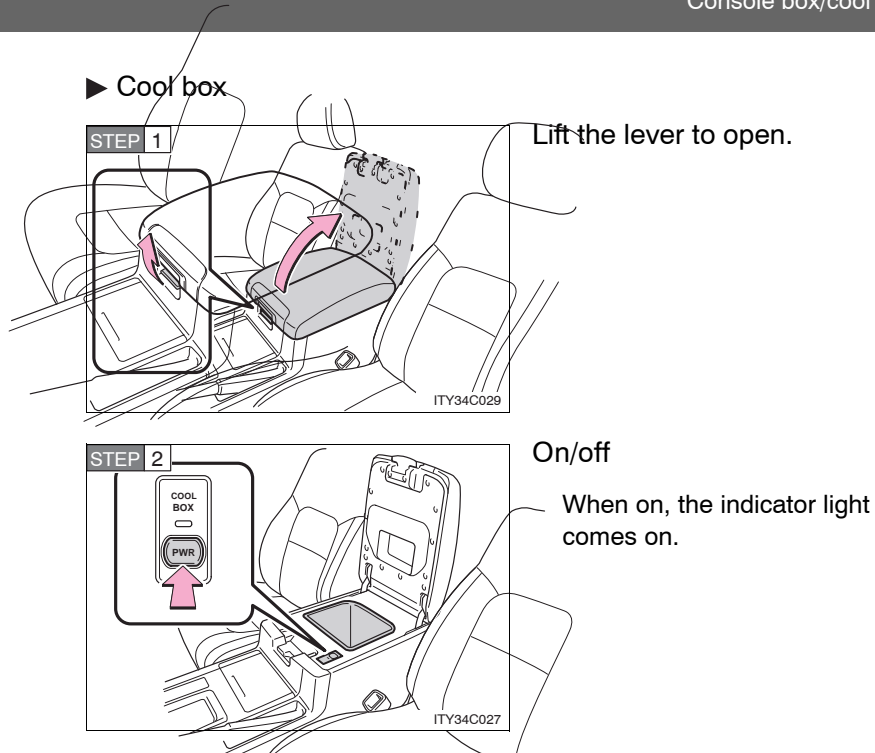

**CAUTION**

**While driving**

Keep the box closed.  
Injuries may result in the event of an accident or sudden braking.

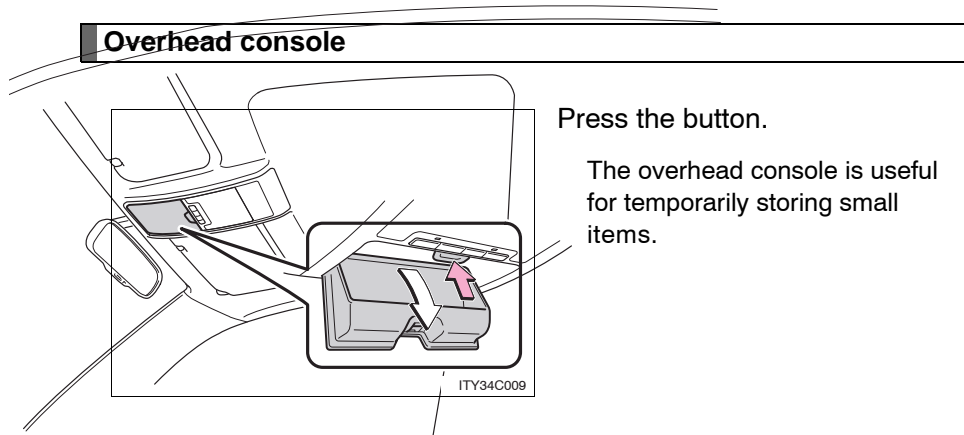

**⚠ CAUTION**

**n Items that should not be left in the overhead console**

Do not leave glasses or lighters in the console.  
If the interior of the vehicle becomes hot, lighters may explode and glasses may warp or become cracked.

**n While driving**

Do not leave the overhead console open. Items may fall out and cause injury.



**Cup holders**

► Front (type A)

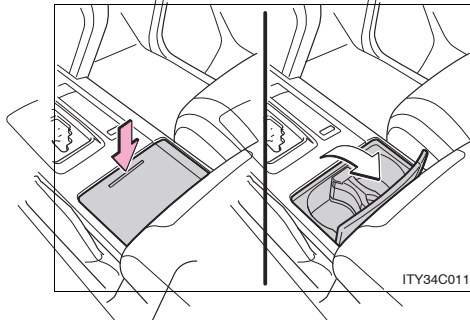

Press down and release the lid.

You can adjust or remove the separator inside.

► Front (type B)

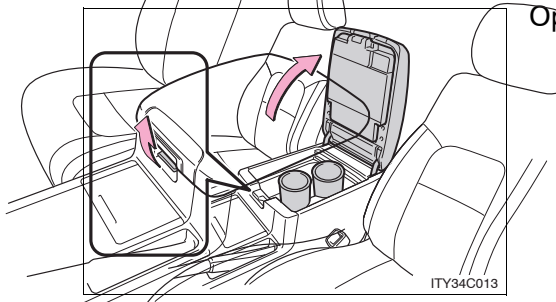

Open the lower console box lid.

► Rear

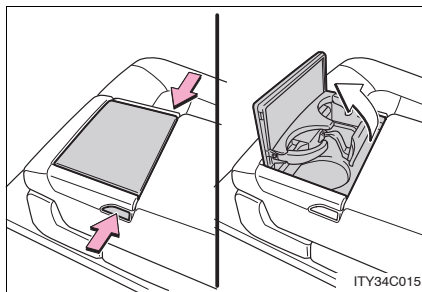

Pull the armrest down.

**⚠ CAUTION**

**n Items unsuitable for the cup holder**

Do not place anything other than cups or aluminum cans in the cup holders. Other items may be thrown out of the holders in the event of an accident or sudden braking and cause injury. If possible, cover hot drinks to prevent burns.

**n When not in use**

Keep the cup holders closed.  
Injuries may result in the event of an accident or sudden braking.

**Bottle holders**

► For front seats

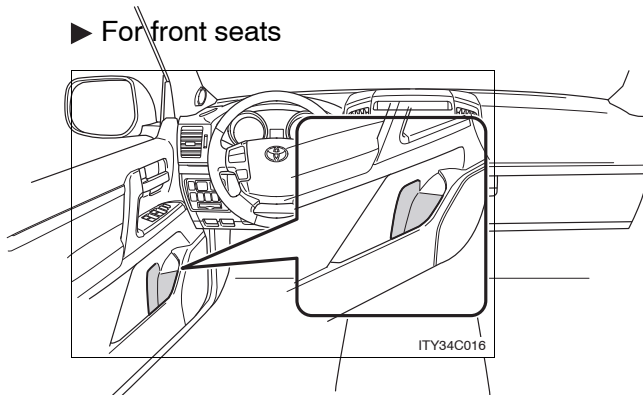

► For second seats

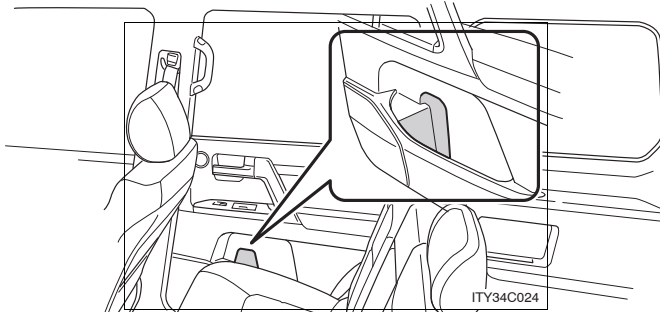

► For third seats

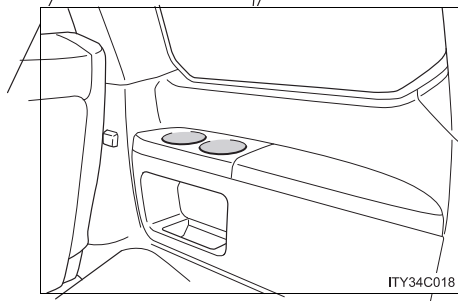

 **NOTICE**

**n Items that should not be stowed in the bottle holders**

Put the cap on before stowing a bottle. Do not place open bottles in the bottle holders, or glasses and paper cups containing liquid. The contents may spill and glasses may break.

### Card holders

#### ► Sun visor

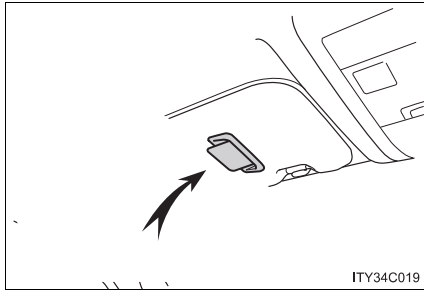

#### ► Instrument panel

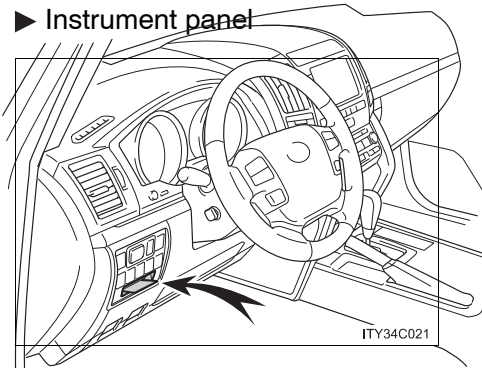

### Auxiliary box

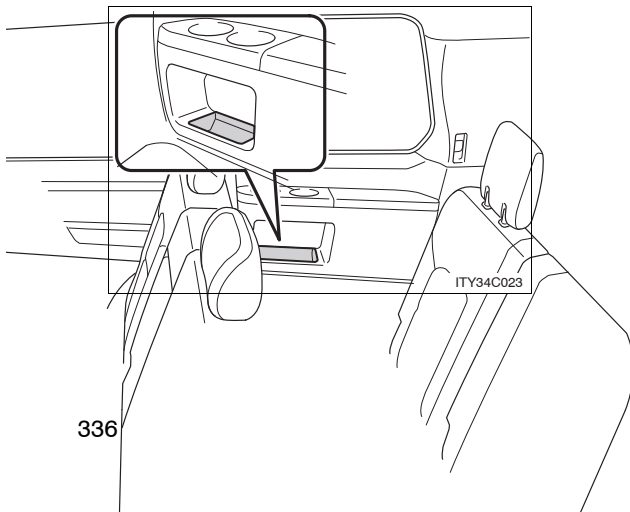

3-6. Other interior features  
Sun visors

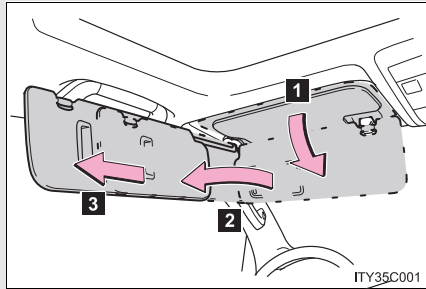

- 1** Forward position:  
Flip down.
- 2** Side position:  
Flip down, unhook, and  
swing to the side.
- 3** Side extender:  
Place in side position, then  
slide backwards.

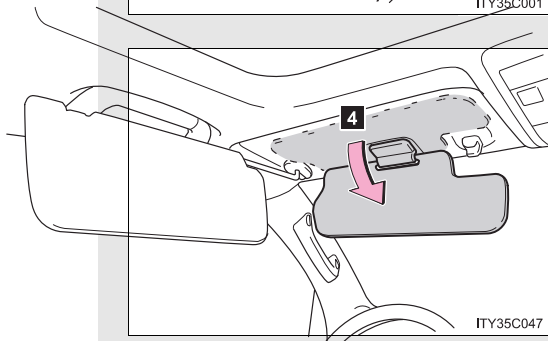

- 4** Forward position with the  
sun visor in the position **2**  
or **3**  
Flip down

3-6. Other interior features

Vanity mirror

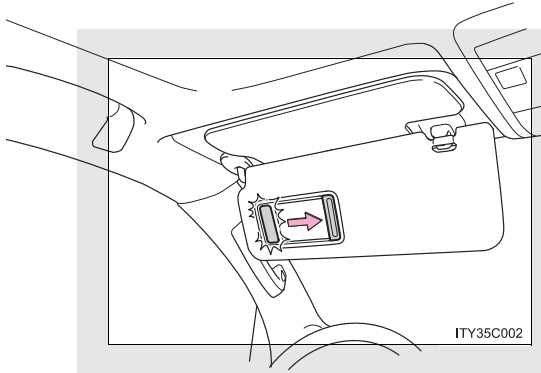

Slide the cover.

The light turns on when the cover is opened.

## 3-6. Other interior features

### Clock

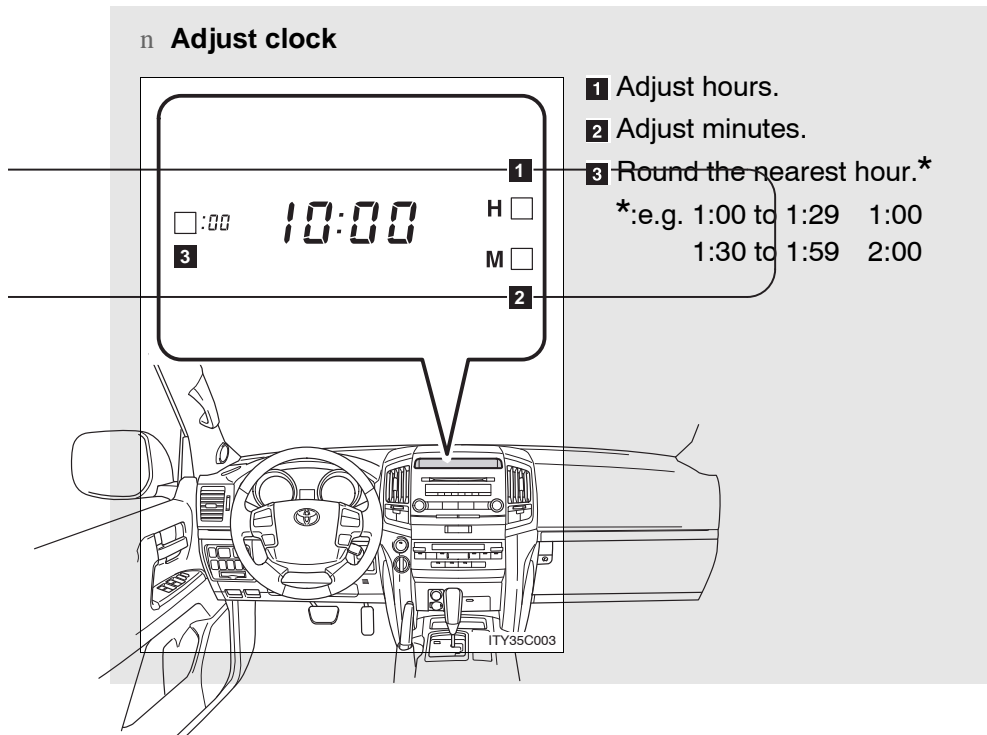

n **The clock is displayed when**

The "ENGINE START STOP" switch is in ACCESSORY or IGNITION ON mode.

n **When the battery is disconnected**

The time display will automatically be set to 1:00.

### 3-6. Other interior features

## Outside temperature display

The displayed temperature ranges from  $-22^{\circ}\text{F}$  ( $-30^{\circ}\text{C}$ ) up to  $122^{\circ}\text{F}$  ( $50^{\circ}\text{C}$ ).

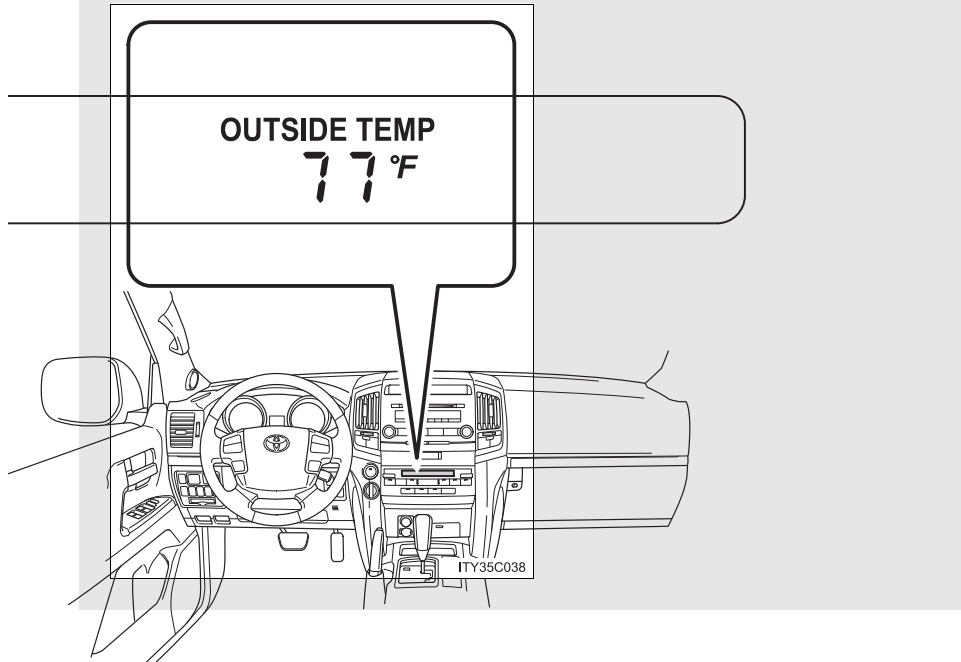

#### Operating conditions

The "ENGINE START STOP" switch is in IGNITION ON mode.

#### When ---- is displayed

The system may be malfunctioning. Take your vehicle to your Toyota dealer.

#### Display

In the following situations, the correct outside temperature may not be displayed, or the display may take longer than normal to change.

- When stopped, or driving at low speeds (less than 20 km/h (12 mph))
- When the outside temperature has changed suddenly (at the entrance/exit of a garage or tunnel etc.)



3-6. Other interior features  
Ashtrays

► Front

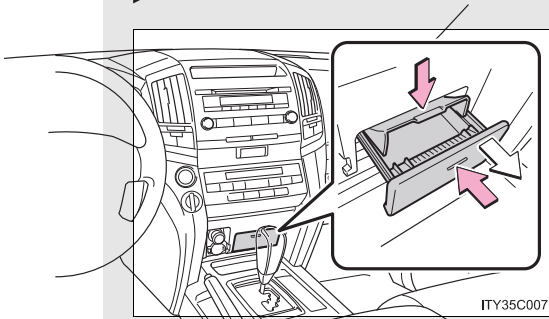

Press in and release the lid to open.

Press down on the lock spring plate to remove.

Push the lid to close.

► Rear

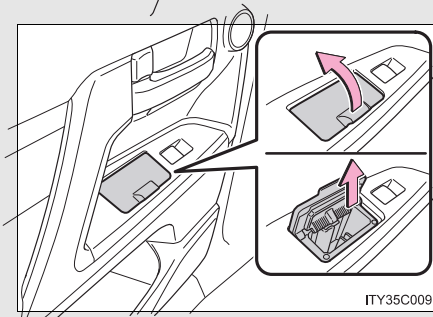

Pull the ashtray lid to open.

Pull the ashtray upwards to remove.

 **CAUTION**

**n When not in use**

Keep the ashtray closed.  
Injuries may result in the event of an accident or sudden braking.

**n To prevent fire**

- l** Fully extinguish matches and cigarettes before putting them in the ashtray, then make sure the ashtray is fully closed.
- l** Do not place paper or any other type of flammable object in the ashtray.

3-6. Other interior features  
Cigarette lighter

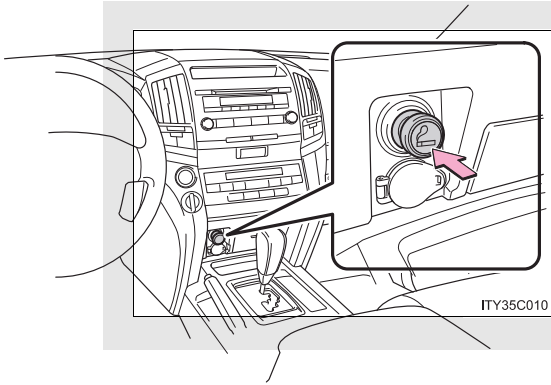

Push the cigarette lighter in.

The cigarette lighter will pop up when ready for use.

**n The cigarette lighter can be used when**

The “ENGINE START STOP” switch is in ACCESSORY or IGNITION ON mode.

**⚠ CAUTION**

**n To avoid burns or fires**

- I** Do not touch the metal parts of the cigarette lighter.
- I** Do not hold the cigarette lighter down. It could overheat and cause a fire.
- I** Do not insert anything other than the cigarette lighter into the outlet.

### 3-6. Other interior features

## Power outlets

The power outlets can be used for a following component.

Instrument panel (12V): Accessories that run on less than 10A.

Luggage compartment (115V AC): Audio device that use less than 100W.

#### ► Instrument panel (12V)

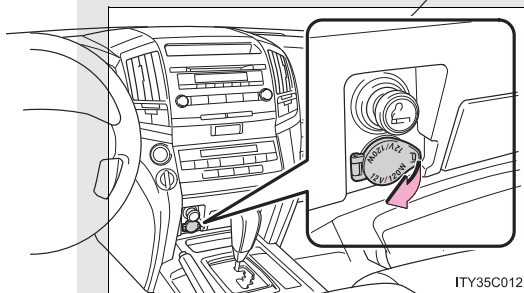

#### ► Luggage compartment (115V AC)

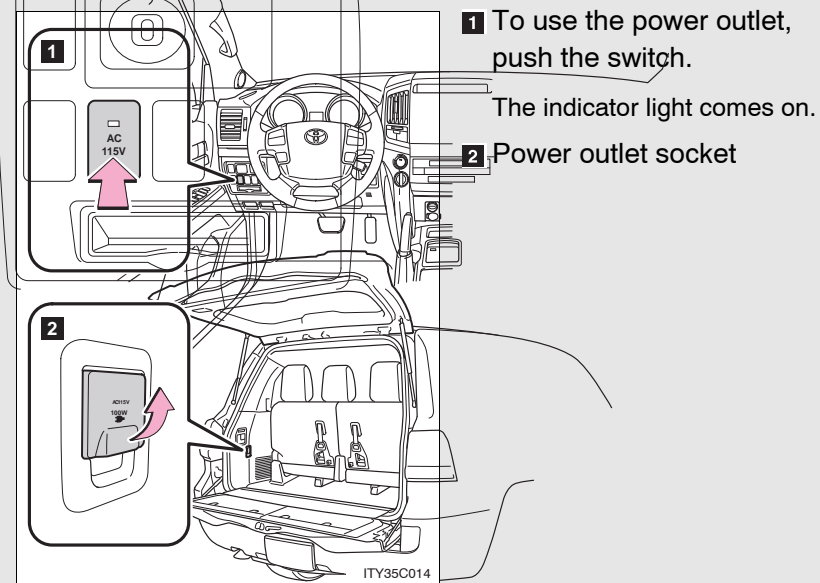

**n The power outlets can be used when**

12V: The “ENGINE START STOP” switch is in ACCESSORY or IGNITION ON mode.

115V: The “ENGINE START STOP” switch is in IGNITION ON mode.

 **NOTICE**

**n To avoid damaging the power outlets**

Close the power outlet lid when not in use.

Foreign objects or liquids that enter the power outlet may cause a short circuit.

**n To prevent the fuse from being blown**

12V: Do not use an accessory that uses more than 12V/10A.

115V: Do not use a 115V AC appliance that requires more than 100W.

If a 115V AC appliance that consumes more than 100W is used, the protection circuit will cut the power supply.

**n To prevent the battery from being discharged**

Do not use the power outlet longer than necessary when the engine is not running.

**n Appliances that may not operate properly (115V AC)**

The following 115V AC appliances may not operate even if their power consumption is under 100W.

l Appliances with high initial peak wattage

l Measuring devices that process precise data

l Other appliances that require an extremely stable power supply

3-6. Other interior features  
**Seat heaters**

► For front seats

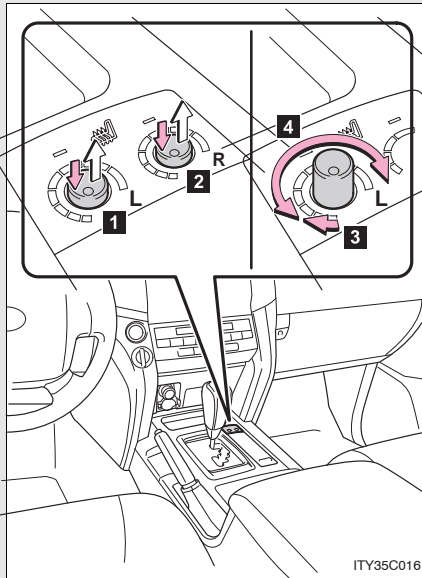

- 1** For driver's seat  
Pops the switch out.
- 2** For front passenger's seat  
Pops the switch out.
- 3** On  
The indicator light comes on.
- 4** Adjusts the seat temperature  
The further you turn the knob clockwise, the warmer the seat becomes.  
Raise the knob when you wish to adjust the seat warmth, and push the knob back in when finished.

► For second seats (if equipped)

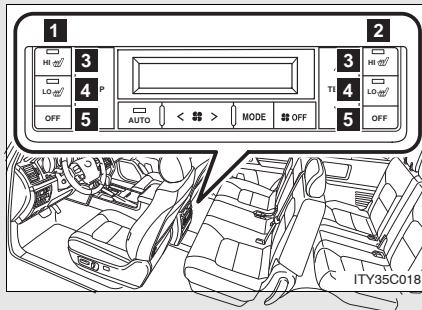

- 1** For left second seat
  - 2** For right second seat
  - 3** High heating temperature
  - 4** Low heating temperature
  - 5** Off
- To turn on the seat heater, press "HI" or "LO".  
 To turn off, press "OFF".
- The indicator light on "HI" or "LO" switch indicates that the seat heater is on.

**n The seat heaters can be used when**

The “ENGINE START STOP” switch is in IGNITION ON mode.

**⚠ CAUTION**

**n Burns**

**I** Use caution when seating the following persons in a seat with the seat heater on to avoid the possibility of burns:

- Babies, small children, the elderly, the sick and the disabled
- Persons with sensitive skin
- Persons who are fatigued
- Persons who have taken alcohol or drugs that induce sleep (sleeping drugs, cold remedies, etc.)

**I** Do not cover the seat with anything when using the seat heater. Using the seat heater with a blanket or cushion increases the temperature of the seat and may lead to overheating.

**⚠ NOTICE**

**n To prevent seat heater damage**

Do not put unevenly weighted objects on the seat and do not stick sharp objects (needles, nails, etc.) into the seat.

**n To prevent battery discharge**

Turn the switches off when the engine is not running.

3-6. Other interior features

Armrest

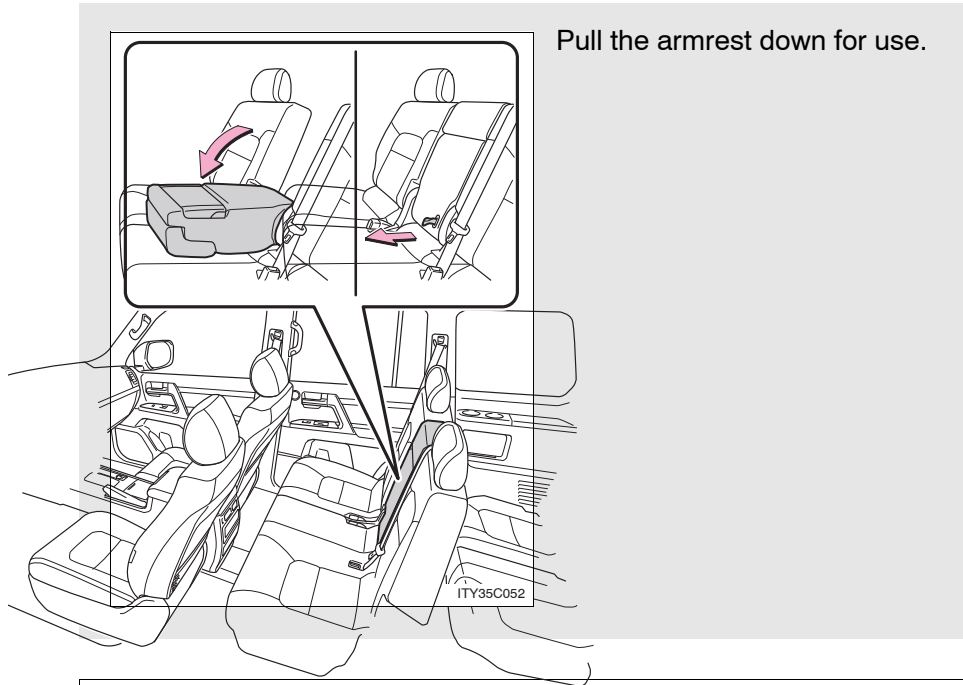

 NOTICE

- n To prevent damage to the armrest**  
Do not place too much strain on the armrest.



## Floor mats

Securely place a mat that matches the size of the space on the carpet.

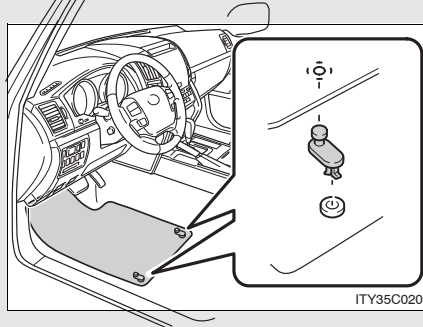

Secure the floor mat using the hooks provided.

### CAUTION

#### **n** When inserting the floor mat

Observe the following precautions.

Failure to do so may result in the floor mat slipping and interfering with the movement of the pedals during driving, resulting in an accident.

- I** Make sure the floor mat is properly placed on the vehicle carpet and the correct side faces upward.
- I** Do not place floor mats on top of existing mats.

3-6. Other interior features

Luggage compartment features

n **Cargo hooks**

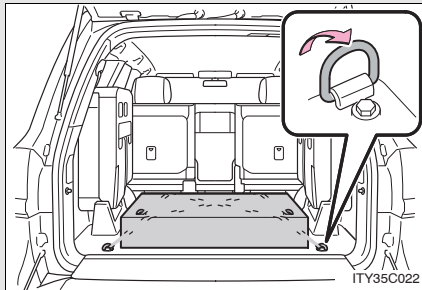

Cargo hooks are provided for securing loose items.

n **Cargo net hooks**

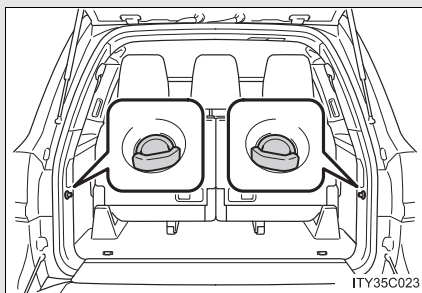

To hang the cargo net, use the cargo net hooks and rear tie-down hooks.

The cargo net itself is not included as an original equipment.

n **Storage compartment**

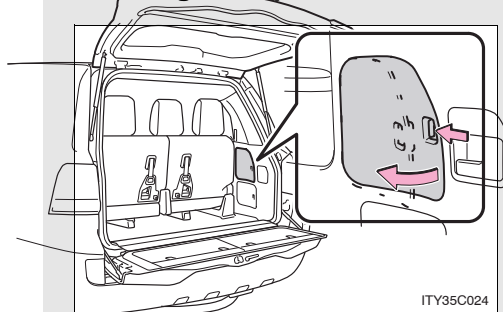

Open the storage compartment as shown.

**n Warning reflector holder**

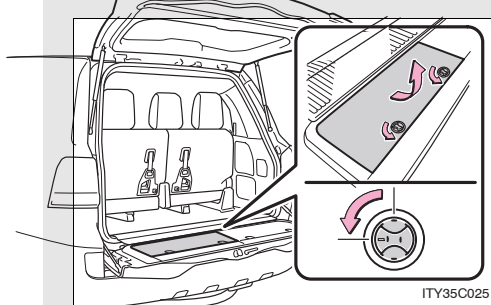

Hold the warning reflector with a band.

The warning reflector itself is not included as an original equipment.

**n First-aid kit holder**

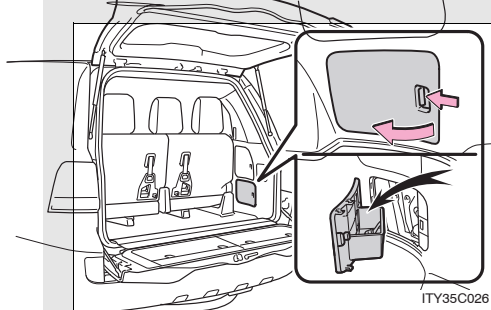

Hold the first-aid kit with a band.

The first-aid kit itself is not included as an original equipment.

**⚠ CAUTION**

**n When the cargo hooks are not in use**

To avoid injury, always return the cargo hooks to their positions when they are not in use.

**⚠ NOTICE**

**n To prevent damage to the cargo net hooks**

Avoid hanging things other than a cargo net on it.

### 3-6. Other interior features

## Garage door opener

The garage door opener can be programmed to operate garage doors, gates, entry doors, door locks, home lighting systems, security systems, and other devices.

The garage door opener (HomeLink Universal Transceiver) is manufactured under license from HomeLink .

### Programming HomeLink (for U.S.A. owners)

The HomeLink compatible transceiver in your vehicle has 3 buttons which can be programmed to operate 3 different devices. Refer to the programming method below appropriate for the device.

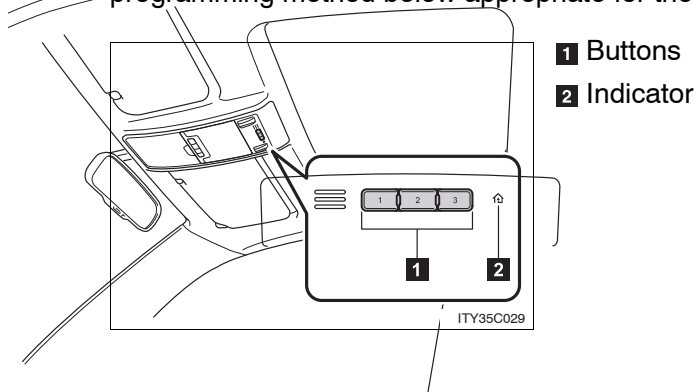

## n Programming HomeLink

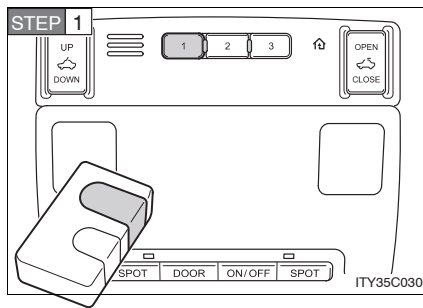

Point the remote control transmitter for the device 1 to 3 in. (25 to 75 mm) from the HomeLink buttons.

Keep the HomeLink indicator light in view while programming.

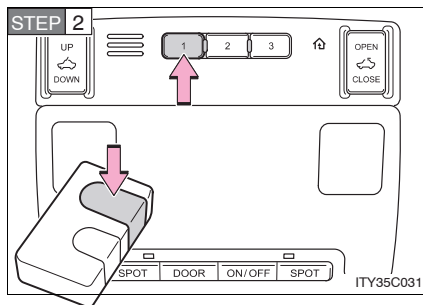

Press and hold one of the HomeLink buttons and the transmitter button. When the HomeLink indicator light changes from a slow to a rapid flash, you can release both buttons.

If the HomeLink indicator light comes on but does not flash, flashes rapidly for 2 seconds and remains lit, the HomeLink button is already programmed. Use the other buttons or follow the “Reprogramming a HomeLink button” instructions. ( P. 357)

### 3-6. Other interior features

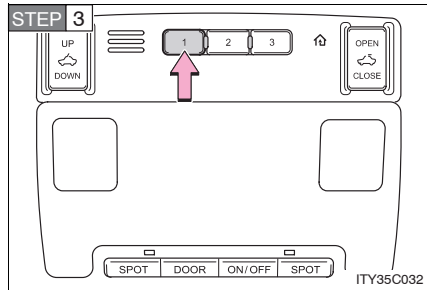

Test the HomeLink operation by pressing the newly programmed button.

If a HomeLink button has been programmed for a garage door, check to see if the garage door opens and closes. If the garage door does not operate, see if your remote control transmitter is of the rolling code type. Press and hold the programmed HomeLink button. The remote control transmitter is of the rolling code type if the HomeLink indicator light flashes rapidly for 2 seconds and then remains lit. If your transmitter is of the rolling code type, proceed to the heading "Programming a rolling code system".

**STEP 4** Repeat the steps above to program another device for each of the remaining HomeLink buttons.

### n **Programming a rolling code system**

If your device is rolling code equipped, follow the steps under the heading “Programming HomeLink” before proceeding with the steps listed below.

**STEP 1** Locate the training button on the ceiling mounted garage door opener motor. The exact location and color of the button may vary by brand of garage door opener motor.

Refer to the operation manual supplied with the garage door opener motor for the location of the training button.

**STEP 2** Press the training button.

Following this step, you have 30 seconds in which to initiate step 3 below.

**STEP 3** Press and hold the vehicle’s programmed HomeLink button for 2 seconds and release it. Repeat this step once again. The garage door may open.

If the garage door opens, the programming process is complete. If the door does not open, press and release the button a third time. This third press and release will complete the programming process by opening the garage door.

The ceiling mounted garage door opener motor should now recognize the HomeLink signal and operate the garage door.

**STEP 4** Repeat the steps above to program another rolling code system for any of the remaining HomeLink buttons.

n **Programming an entry gate (for U.S.A. owners)/Programming all devices in the Canadian market**

- STEP 1 Place your transmitter 1 to 3 in. (25 to 75 mm) away from the surface of the HomeLink .  
Keep the HomeLink indicator light in view while programming.
- STEP 2 Press and hold the selected HomeLink button.
- STEP 3 Repeatedly press and release (cycle) the device's remote control button for two seconds each until step 4 is completed.
- STEP 4 When the indicator light on the HomeLink compatible transmitter starts to flash rapidly, release the buttons.
- STEP 5 Test the operation of the HomeLink by pressing the newly programmed button. Check to see if the gate/device operates correctly.
- STEP 6 Repeat the steps above to program another device for each of the remaining HomeLink buttons.

n **Programming other devices**

To program other devices such as home security systems, home door locks or lighting, contact your authorized Toyota dealer for assistance.

n **Reprogramming a button**

The individual HomeLink buttons cannot be erased but can be reprogrammed. To reprogram a button, follow the "Reprogramming a HomeLink button" instructions.



### Operating HomeLink

Press the appropriate HomeLink button. The HomeLink indicator light should come on.

The HomeLink compatible transceiver in your vehicle continues to send a signal for up to 20 seconds as long as the button is pressed.

### Reprogramming a HomeLink button

Press and hold the desired HomeLink button. After 20 seconds, the HomeLink indicator light will start flashing slowly. Next, while still pressing and holding the HomeLink button, press and hold the button on the transmitter until the HomeLink indicator light changes from a slow to a rapid flash.

### Erasing the entire HomeLink memory (all three programs)

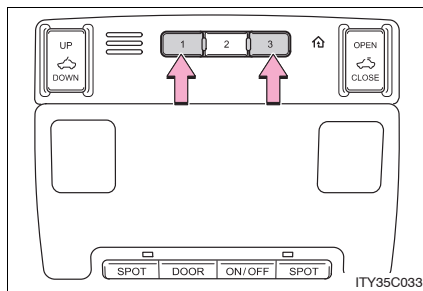

Press and hold the 2 outside buttons for 10 seconds until the indicator light flashes.

If you sell your vehicle, be sure to erase the programs stored in the HomeLink memory.

---

**n Before programming**

- l Install a new battery in the remote control transmitter.
- l The battery side of the remote control transmitter must be pointed away from the HomeLink button.

**n Certification for the garage door opener**

This device complies with Part 15 of the FCC Rules and with RSS-210 of the IC Rules.

Operation is subject to the following two conditions: (1) this device may not cause harmful interference, and (2) this device must accept any interference received, including interference that may cause undesired operation.

**WARNING:** This transmitter has been tested and complies with FCC and IC rules. Changes or modifications not expressly approved by the party responsible for compliance could void the user's authority to operate the device.

 **CAUTION**

**n When programming a garage door or other remote control devices**

The garage door or other devices may operate, so ensure people and objects are out of danger to prevent potential harm.

**n Conforming to federal safety standards**

Do not use the HomeLink compatible transceiver with any garage door opener or device that lacks safety stop and reverse features as required by federal safety standards.

This includes any garage door that cannot detect an interfering object. A door or device without these features increases the risk of death or serious injury.

## Cleaning and protecting the vehicle exterior

**Perform the following to protect the vehicle and maintain it in prime condition.**

- 1 Working from top to bottom, liberally apply water to the vehicle body, wheel wells and underside of the vehicle to remove any dirt and dust.

Wash the vehicle body using a sponge or soft cloth, such as a cham-  
ois.

- 1 For hard-to-remove marks, use car wash soap and rinse thoroughly with water.
- 1 Wipe away any water.
- 1 Wax the vehicle when the waterproof coating deteriorates.

If water does not bead on a clean surface, apply wax when the vehi-  
cle body is cool.

---

### **n Automatic car washes**

- 1 Fold the mirrors back and retract the antenna before washing the vehicle.
- 1 Brushes used in automatic car washes may scratch the vehicle surface and harm your vehicle's paint.

### **n High pressure car washes**

- 1 Do not allow the nozzles of the car wash to come within close proximity of the windows.
- 1 Before car wash, check that the fuel filler door is closed.

### **n Aluminum wheels**

Remove any dirt immediately by using a neutral detergent. Do not use hard brushes or abrasive cleaners. Do not use strong or harsh chemical cleaners. Use the same mild detergent and wax as used on the paint.

### **n Bumpers and side moldings**

Do not scrub with abrasive cleaners.

**n To prevent paint deterioration and corrosion on the body**

- l Wash the vehicle immediately in the following cases:
  - After driving near the sea coast
  - After driving on salted roads
  - If you see coal tar or tree sap on the paint surface
  - If you see dead insects or insect droppings on the paint
  - After driving in an area contaminated with soot, oily smoke, mine dust, iron powder or chemical substances
  - If the vehicle becomes heavily soiled in dust or mud
  - If liquids such as benzene and gasoline are spilled on the paint surface
- l If the paint is chipped or scratched, have it repaired immediately.

**! CAUTION**

**n Caution about the exhaust pipe**

Exhaust gasses cause the exhaust pipe to become quite hot. When washing the vehicle, be careful not to touch the pipe until it has cooled sufficiently, as touching a hot exhaust pipe can cause burns.

**! NOTICE**

**n To protect your vehicle's painted surfaces**

Do not use organic cleaners such as benzene or gasoline.

**n Cleaning the exterior lights**

- l Wash carefully. Do not use organic substances or scrub with a hard brush. This may damage the surfaces of the lights.
- l Do not apply wax on the surface of the lights. Wax may cause damage to the lenses.

## Cleaning and protecting the vehicle interior

**The following procedures will help protect your vehicle's interior and keep it in top condition:**

**n Protecting the vehicle interior**

Remove dirt and dust using a vacuum cleaner. Wipe dirty surfaces with a cloth dampened with lukewarm water.

**n Cleaning the leather areas**

1 Remove dirt and dust using a vacuum cleaner.

1 Wipe any excess dirt and dust with a soft cloth dampened with diluted detergent.

Use a diluted water solution of approximately 5% neutral wool detergent.

1 Wring out any excess water from the cloth and thoroughly wipe off all remaining traces of detergent.

1 Wipe the surface with a dry, soft cloth to remove any remaining moisture. Allow the leather to dry in shaded and ventilated area.

**n Synthetic leather areas**

1 Remove loose dirt using a vacuum cleaner.

1 Apply a mild soap solution to the synthetic leather using a sponge or soft cloth.

1 Allow the solution to soak in for a few minutes. Remove the dirt and wipe off the solution with a clean, damp cloth.

#### n **Cleaning the inside of the rear window**

Do not use glass cleaner to clean the rear window, as this may cause damage to the rear window defogger heater wires. Use a cloth dampened with lukewarm water to gently wipe the window clean. Wipe the window in strokes running parallel to the heater wires or antenna.

#### n **Caring for leather areas**

Toyota recommends cleaning the interior of the vehicle at least twice a year to maintain the quality of the vehicle's interior.

#### n **Shampooing the carpets**

There are several commercial foaming-type cleaners available. Use a sponge or brush to apply the foam. Rub in overlapping circles. Do not apply water. The excellent results are obtained by keeping the carpet as dry as possible.

#### n **Seat belts**

Clean with mild soap and lukewarm water using a cloth or sponge. Also check the belts periodically for excessive wear, fraying or cuts.

### CAUTION

#### n **Water in the vehicle**

- I Be careful not to splash or spill liquid on the floor.
- I Do not get any of the SRS components or wiring in the vehicle interior wet. ( P. 104)  
Electrical malfunction may cause the airbags to deploy or not function properly, resulting in death or serious injury.

 NOTICE

**n Cleaning detergents**

Do not use the following types of detergent, as they may discolor the vehicle interior or cause streaks or damage to painted surfaces.

- l Non-seat portions: Organic substances such as benzene or gasoline, alkaline or acidic solutions, dye, or bleach.
- l Seats: Acidic solutions, such as thinner, benzene, or alcohol.

**n Preventing damage to leather surfaces**

Observe the following precautions to avoid damage to and deterioration of leather surfaces.

- l Remove any dust or dirt on leather surfaces immediately.
- l Do not expose the vehicle to direct sunlight for extended periods of time. Park the vehicle in the shade, especially during summer.
- l Do not place items made of vinyl, plastic, or that contain wax on the upholstery, as they may stick to the leather surface if the vehicle interior heats up significantly.

**n Water on the floor**

Do not wash the vehicle floor with water.

Vehicle systems such as the audio system may be damaged if water comes into contact with electrical components under the floor of the vehicle, and may also cause the body to rust.

**n Cleaning the inside of the rear window**

Be careful not to scratch or damage the heater wires or antenna.

## Maintenance requirements

**To ensure safe and economical driving, day-to-day care and regular maintenance is essential. Toyota recommends the following maintenance.**

n **General maintenance**

Should be performed on a daily basis. This can be done by yourself or by a Toyota dealer.

n **Scheduled maintenance**

Should be performed at specified intervals according to the maintenance schedule.

For details about maintenance items and schedules, read the “Scheduled Maintenance Guide”, “Owner’s Manual Supplement”.

n **Do-it-yourself maintenance**

You can perform some maintenance procedures yourself. Please be aware that do-it-yourself maintenance may affect warranty coverage.

The use of Toyota service and repair manuals is recommended.

For details about warranty coverage, see the “Owner’s Warranty Information Booklet”, “Owner’s Manual Supplement”.

---

n **Repair and replacement**

It is recommended that genuine Toyota parts be used for repair to ensure performance of each system. If non-Toyota parts are used in replacement or if a repair shop other than a Toyota dealer performs repairs, confirm the warranty coverage.



**n Allow inspection and repairs to be performed by a Toyota dealer**

- I Toyota technicians are well-trained specialists and are kept up to date with the latest service information. They are well informed about the operations of all systems on your vehicle.
- I Keep a copy of the repair order. It proves that the maintenance that has been performed is under warranty coverage. If any problem should arise while your vehicle is under warranty, your Toyota dealer will promptly take care of it.

**⚠ CAUTION**

**n Warning in handling of battery, oils, fuels, and fluids**

- I Engine exhaust, some of its constituents, and a wide variety of automobile components contain or emit chemicals known to the State of California to cause cancer and birth defects and other reproductive harm. Work in a well ventilated area.
- I Oils, fuels and fluids contained in vehicles as well as waste produced by component wear contain or emit chemicals known to the State of California to cause cancer and birth defects or other reproductive harm. Avoid exposure and wash any affected area immediately.
- I Battery posts, terminals and related accessories contain lead and lead compounds which are known to cause brain damage. Wash your hands after handling. ( P. 387)

## 4-2. Maintenance

### General maintenance

Listed below are the general maintenance items that should be performed at the intervals specified in the “Owner’s Warranty Information Booklet”, “Owner’s Manual Supplement”. It is recommended that any problem you notice should be brought to the attention of your Toyota dealer or qualified service shop for advice.

#### Engine compartment

Items	Check points
Battery	• Maintenance-free (P. 387)
Brake fluid	• At the correct level? (P. 384)
Engine coolant	• At the correct level? (P. 382)
Engine oil	• At the correct level? (P. 377)
Exhaust system	• No fumes or strange sounds?
Power steering fluid	• At the correct level? (P. 386)
Radiator/condenser/hoses	• Not blocked with foreign matter? (P. 383)
Washer fluid	• At the correct level? (P. 338)

**Vehicle interior**

Items	Check points
Accelerator pedal	<ul style="list-style-type: none"> <li>Moves smoothly (without uneven pedal effort or catching)?</li> </ul>
Automatic transmission "Park" mechanism	<ul style="list-style-type: none"> <li>Can the vehicle be hold securely on an incline with the shift lever in "P"?</li> </ul>
Brake pedal	<ul style="list-style-type: none"> <li>Moves smoothly?</li> <li>Does it have appropriate clearance and correct amount of free play?</li> </ul>
Brakes	<ul style="list-style-type: none"> <li>Pulls to one side when applied?</li> <li>Loss of brake effectiveness?</li> <li>Spongy feeling brake pedal?</li> <li>Pedal almost touches floor?</li> </ul>
Head restraints	<ul style="list-style-type: none"> <li>Move smoothly and lock securely?</li> </ul>
Indicators/buzzers	<ul style="list-style-type: none"> <li>Function properly?</li> </ul>
Lights	<ul style="list-style-type: none"> <li>Do all the lights come on?</li> <li>Headlights aimed correctly?</li> </ul>
Parking brake	<ul style="list-style-type: none"> <li>Moves smoothly?</li> <li>Can hold the vehicle securely on an incline?</li> </ul>
Seat belts	<ul style="list-style-type: none"> <li>Does the seat belt system operate smoothly?</li> <li>Are the belts undamaged?</li> </ul>
Seats	<ul style="list-style-type: none"> <li>Do the seat controls operate properly?</li> </ul>
Steering wheel	<ul style="list-style-type: none"> <li>Moves smoothly?</li> <li>Has correct free play?</li> <li>No strange noises?</li> </ul>

**Vehicle exterior**

Items	Check points
Doors	<ul style="list-style-type: none"> <li>• Operate smoothly?</li> </ul>
Engine hood	<ul style="list-style-type: none"> <li>• The lock system works properly?</li> </ul>
Fluid leaks	<ul style="list-style-type: none"> <li>• Is there any leakage after parking?</li> </ul>
Tire	<ul style="list-style-type: none"> <li>• Inflation pressure is correct?</li> <li>• Tire surfaces not worn or damaged?</li> <li>• Tires rotated according to the maintenance schedule?</li> <li>• Wheel nuts are not loose?</li> </ul>

**⚠ CAUTION****n If the engine is running**

Turn off the engine and ensure that there is adequate ventilation before performing maintenance checks.

**Some states have vehicle emission inspection programs which include OBD (On Board Diagnostics) checks. The OBD system monitors the operation of the emission control system.**

**n If the malfunction indicator lamp comes on**

The OBD system determines that a problem exists somewhere in the emission control system. Your vehicle may not pass the I/M test and may need to be repaired. Contact your Toyota dealer to service the vehicle.

**n Your vehicle may not pass the I/M test:**

**l When the battery is disconnected or discharged**

Readiness codes that are set during ordinary driving are erased.

Also, depending on your driving habits, the readiness codes may not be completely set.

**l When the fuel tank cap is loose**

The malfunction indicator lamp comes on as a temporary malfunction and your vehicle may not pass the I/M test.

**n When the malfunction indicator lamp goes off after several driving trips**

The error code in the OBD system will not be cleared unless the vehicle is driven 40 or more times.

**n If your vehicle does not pass the I/M test**

Contact your Toyota dealer to prepare the vehicle for re-testing.

4-3. Do-it-yourself maintenance

Do-it-yourself service precautions

**If you perform maintenance yourself, be sure to follow the correct procedure given in these sections.**

Items	Parts and tools
Battery condition ( P. 387)	<ul style="list-style-type: none"> <li>• Warm water</li> <li>• Baking soda</li> <li>• Grease</li> <li>• Conventional wrench (for terminal clamp bolts)</li> </ul>
Brake fluid level ( P. 384)	<ul style="list-style-type: none"> <li>• FMVSS No.116 DOT 3 or SAE J1703 brake fluid</li> <li>• Rag or paper towel</li> <li>• Funnel (used only for adding brake fluid)</li> </ul>
Engine coolant level ( P. 382)	<ul style="list-style-type: none"> <li>• “Toyota Super Long Life Coolant” or similar high quality ethylene glycol based non-silicate, non-amine, non-nitrite and non-borate coolant with long-life hybrid organic acid technology. “Toyota Super Long Life Coolant” is pre-mixed with 50% coolant and 50% deionized water.</li> <li>• Funnel (used only for adding coolant)</li> </ul>
Engine oil level ( P. 377)	<ul style="list-style-type: none"> <li>• “Toyota Genuine Motor Oil” or equivalent</li> <li>• Rag or paper towel</li> <li>• Funnel (used only for adding engine oil)</li> </ul>
Fuses ( P. 413)	<ul style="list-style-type: none"> <li>• Fuse with same amperage rating as original</li> </ul>

#### 4-3. Do-it-yourself maintenance

Items	Parts and tools
Power steering fluid ( P. 386)	<ul style="list-style-type: none"><li>• Automatic transmission fluid DEXRON®II or III</li><li>• Rag or paper towel</li><li>• Funnel (used only for adding power steering fluid)</li></ul>
Radiator and condenser ( P. 383)	
Tire inflation pressure ( P. 401)	<ul style="list-style-type: none"><li>• Tire pressure gauge</li><li>• Compressed air source</li></ul>
Washer fluid ( P. 390)	<ul style="list-style-type: none"><li>• Water</li><li>• Washer fluid containing antifreeze (for winter use)</li><li>• Funnel (used only for adding washer fluid)</li></ul>

**⚠ CAUTION**

The engine compartment contains many mechanisms and fluids that may move suddenly, become hot, or become electrically energized. To avoid death or serious injury.

**n When working on the engine compartment**

- I** Keep hands, clothing, and tools away from the moving fan and engine drive belt.
- I** Be careful not to touch the engine, inverter, radiator, exhaust manifold, etc. right after driving as they may be hot. Oil and other fluids may also be hot.
- I** Do not leave anything that may burn easily, such as paper or rags, in the engine compartment.
- I** Do not smoke, cause sparks or expose an open flame to fuel or the battery. Fuel and battery fumes are flammable.
- I** Be extremely cautious when working on the battery. It contains poisonous and corrosive sulfuric acid.

**n When working near the electric cooling fan or radiator grille**

Be sure the ignition is off. With the “ENGINE START STOP” switch in IGNITION ON mode, the electric cooling fan may automatically start to run if the air conditioning is on and/or if the coolant temperature is high.

( P. 383)

**n When working on or under the vehicle**

- I** Do not get under the vehicle with just the jack supporting it. Always use automotive jack stands or other solid supports.
- I** Use eye protection to prevent flying or falling material, fluid spray, etc. from getting in your eyes.

4

Maintenance and care

**⚠ NOTICE****n If you remove the air cleaner filter**

Driving with the air cleaner filter removed may cause excessive engine wear due to dirt in the air. Also a backfire could cause a fire in the engine compartment.



4-3. Do-it-yourself maintenance  
Hood

Release the lock from the inside of the vehicle to open the hood.

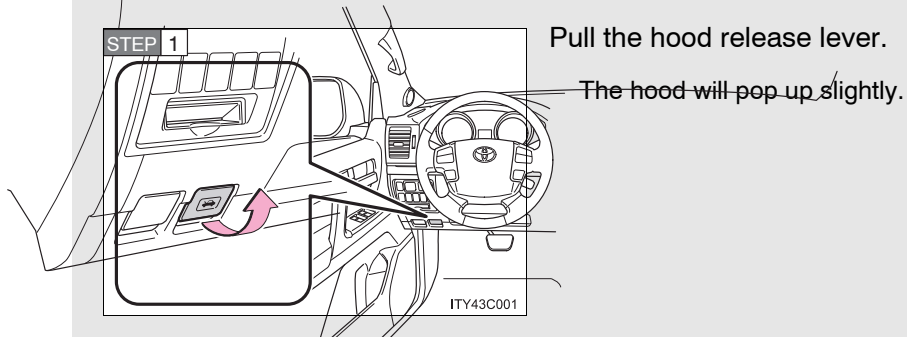

**STEP 2**

Lift the hood catch and lift the hood.

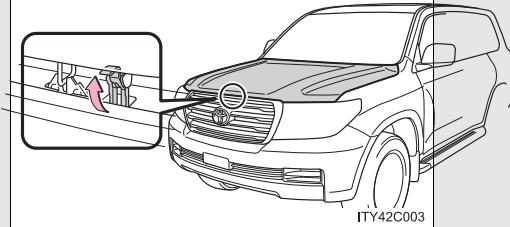

**⚠ CAUTION**

**n Pre-driving check**

Check that the hood is fully closed and locked.  
If the hood is not locked properly it may open while the vehicle is in motion and cause an accident, which may result in death or serious injury.

4-3. Do-it-yourself maintenance  
Engine compartment

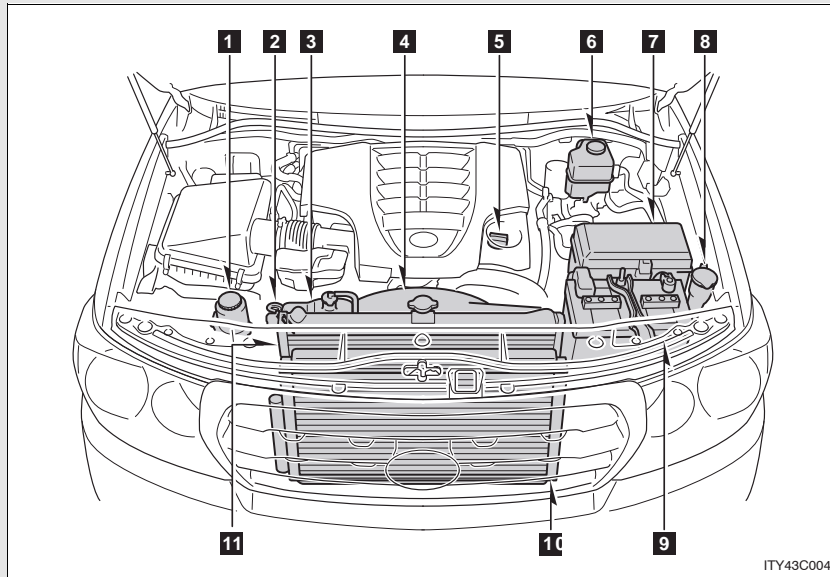

- |   |  |
|---|--|
| <b>1</b> Power steering fluid reservoir ( P. 386) | <b>6</b> Brake fluid reservoir ( P. 384) |
| <b>2</b> Engine oil level dipstick ( P. 377)      | <b>7</b> Fuse box ( P. 413)              |
| <b>3</b> Engine coolant reservoir ( P. 382)       | <b>8</b> Washer fluid tank               |
| <b>4</b> Cooling fan                              | <b>9</b> Battery ( P. 387)               |
| <b>5</b> Engine oil filler cap ( P. 378)          | <b>10</b> Condenser ( P. 383)            |
|   | <b>11</b> Radiator ( P. 383)             |

### Engine compartment cover

#### n Removing the engine compartment cover

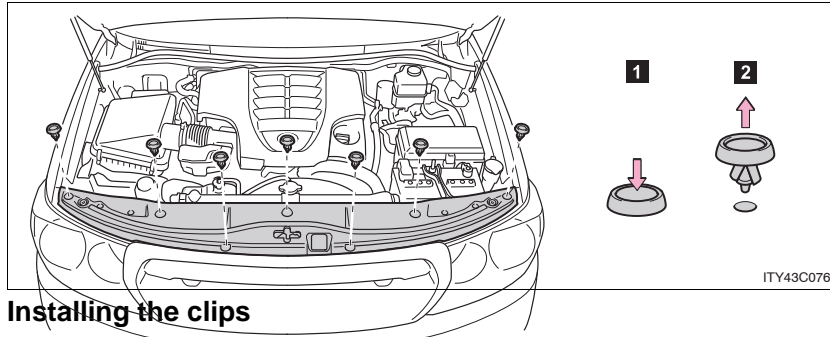

#### n Installing the clips

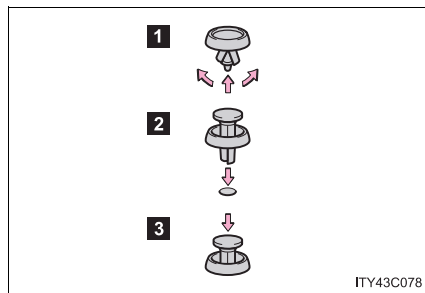

## Engine oil

With the engine at operating temperature and turned off, check the oil level on the dipstick.

### n Checking the engine oil

**STEP 1** Park the vehicle on level ground. After turning off the engine, wait a few minutes for the oil to drain back into the bottom of the engine.

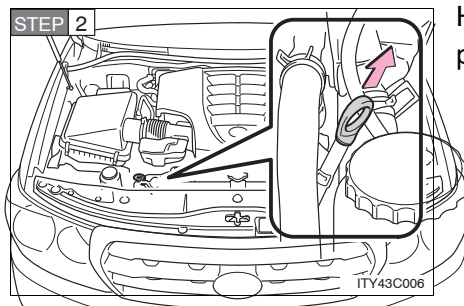

Hold a rag under the end and pull the dipstick out.

**STEP 3** Wipe the dipstick clean.

**STEP 4** Reinsert the dipstick fully.

**STEP 5** Holding a rag under the end, pull the dipstick out and check the oil level.

**STEP 6** Wipe the dipstick and reinsert it fully.

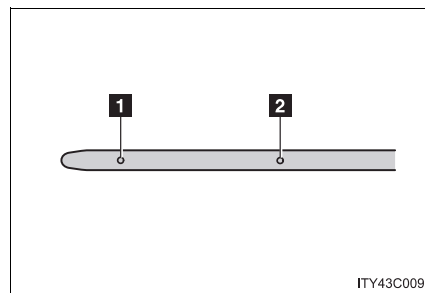

**1** Low

**2** Full

n **Adding engine oil**

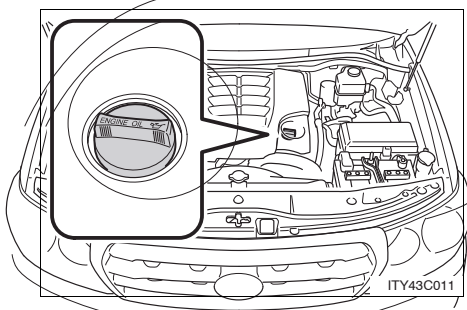

If the oil level is below or near the low level mark, add engine oil of the same type as already in the engine.

Make sure to check the oil type and prepare the items needed before adding oil.

Oil grade	ILSAC multigrade engine oil
Oil quantity (Low Full)	1.2 qt. (1.1 L, 1.0 Imp. qt.)
Items	Clean funnel

**STEP 1** Remove the oil filler cap.

**STEP 2** Add engine oil slowly, checking the dipstick.

**STEP 3** Install the filler cap, turning it clockwise.

**n Recommended viscosity**

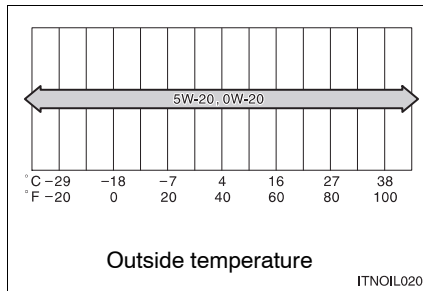

SAE 5W-20 or 0W-20 engine oil may be used. However, SAE 0W-20 is the best choice for good fuel economy and good starting in cold weather.

**n How to read oil container labels**

The ILSAC (International Lubricant Standardization and Approval Committee) Certification Mark is added to some oil containers to help you select the oil you should use.



---

n **Engine oil consumption**

- l The amount of engine oil consumed depends on the oil viscosity, the quality of the oil and the way the vehicle is driven.
- l More oil is consumed under driving conditions such as high speeds and frequent acceleration and deceleration.
- l A new engine consumes more oil.
- l When judging the amount of oil consumption, keep in mind that the oil may have become diluted, making it difficult to judge the true level accurately.

n **Resetting the engine oil maintenance data**

The oil change system should be reset. Perform the following procedures:

- STEP 1** Switch the display to the trip meter A when the engine is running.  
( P. 161)
- STEP 2** Turn the “ENGINE START STOP” switch OFF.
- STEP 3** While pressing the trip meter reset button, set the “ENGINE START STOP” switch to IGNITION ON mode (but do not start the engine because otherwise the reset mode will be cancelled). Continue to press and hold the button until the multi-information display indicates that the reset is complete.

**⚠ CAUTION****n Used engine oil**

- l Used engine oil contains potentially harmful contaminants which may cause skin disorders such as inflammation or skin cancer, so care should be taken to avoid prolonged and repeated contact. To remove used engine oil from your skin, wash thoroughly with soap and water.
- l Dispose of used oil and filters only in a safe and acceptable manner. Do not dispose of used oil and filters in household trash, in sewers or onto the ground.  
Call your Toyota dealer, service station or auto parts store for information concerning recycling or disposal.
- l Do not leave used engine oil within the reach of children.

**⚠ NOTICE****n To prevent serious engine damage**

Check the oil level on regular basis.

**n When replacing the engine oil**

- l Be careful not to spill engine oil on the vehicle components.
- l Avoid overfilling, or the engine could be damaged.
- l Check the oil level on the dipstick every time you refill the vehicle.
- l Be sure the engine oil filler cap is properly retightened.



## Engine coolant

The coolant level is satisfactory if it is between the “F” and “L” lines on the reservoir when the engine is cold.

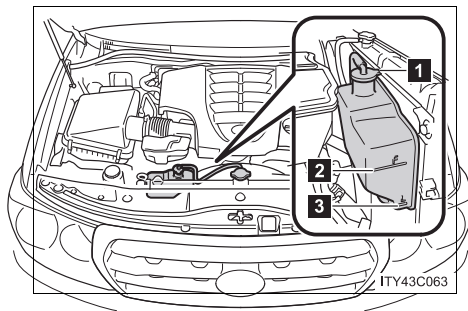

**1** Reservoir cap

**2** Full

**3** Low

If the level is on or below the “L” line, add coolant up to the “F” line.

### **n If the coolant level drops within a short time after replenishing**

Visually check the radiator, hoses, reservoir cap, radiator cap, drain cock and water pump.

If you cannot find a leak, have your Toyota dealer pressure test the cap and check for leaks in the cooling system.

### **n Coolant selection**

Only use “Toyota Super Long Life Coolant” or similar high quality ethylene glycol based non-silicate, non-amine, non-nitrite, and non-borate coolant with long-life hybrid organic acid technology.

“Toyota Super Long Life Coolant” is a mixture of 50% coolant and 50% deionized water. (Enabled: -31 F [-35 C])

For more details about engine coolant, contact your Toyota dealer.

**⚠ CAUTION****n When the engine is hot**

Do not remove the radiator cap.

The cooling system may be under pressure and may spray hot coolant if the cap is removed, causing burns or other injuries.

**⚠ NOTICE****n When adding the engine coolant**

Coolant is neither plain water nor straight antifreeze. The correct mixture of water and antifreeze must be used to provide proper lubrication, corrosion protection and cooling. Be sure to read the antifreeze or coolant label.

**n If you spill coolant**

Be sure to wash it off with water to prevent it damage to parts or paint.

**Radiator and condenser**

Check the radiator and condenser and clear any foreign objects. If either of the above parts are extremely dirty or you are not sure of their condition, have your vehicle checked by your Toyota dealer.

**⚠ CAUTION****n When the engine is hot**

Do not touch the radiator or condenser as they may be hot and you may be burned.

## Brake fluid

### n Checking fluid level

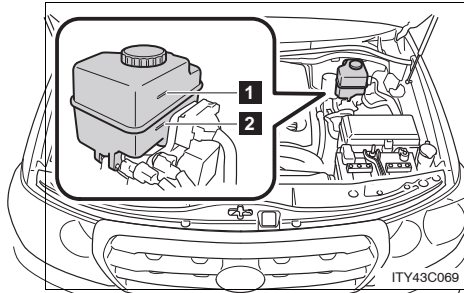

The brake fluid level should be between the “MAX” and “MIN” lines on the tank.

**1** MAX

**2** MIN

Make sure to check the fluid type and prepare the necessary items.

### n Adding fluid

Fluid type	FMVSS No.116 DOT 3 or SAE J1703 brake fluid
Items	Clean funnel

### n Refilling brake fluid

**STEP 1** Turn the “ENGINE START STOP” switch OFF.

**STEP 2** Depress the brake pedal more than 40 times.

**STEP 3** Remove the reservoir cap by hand. Add brake fluid up to the “MAX” line.

If you do not follow the procedure above, the reservoir may overflow.

**n Brake fluid can absorb moisture from the air**

Excess moisture in the fluid can cause a dangerous loss of braking efficiency. Use only newly opened brake fluid.

**⚠ CAUTION**

**n When filling the reservoir**

Take care because brake fluid can harm your hands or eyes and damage painted surfaces.

If fluid gets in your eyes, flush your eyes with clean water immediately.

If you still experience discomfort, see a doctor.

**⚠ NOTICE**

**n If the fluid level is low or high**

It is normal for the brake fluid level to go down slightly as the brake pads wear or when the fluid level in the accumulator is high.

If the reservoir needs frequent refilling, it may indicate a serious problem.

## Power steering fluid

### n Fluid level

The fluid level should be within the appropriate range.

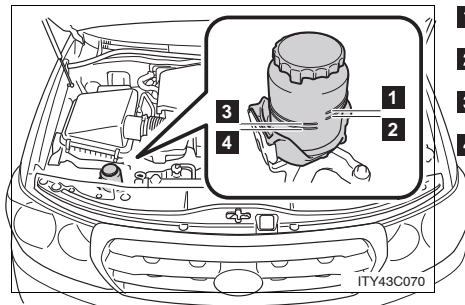

- 1 Full (when hot)
- 2 Add fluid (when hot)
- 3 Full (when cold)
- 4 Add fluid (when cold)

**Hot:** Vehicle has been driven around 50 mph (80 km/h) for 20 minutes, or slightly longer in frigid temperatures. (Fluid temperature, 140°F – 175°F [60°C – 80°C]).

**Cold:** Engine has not been run for about five hours. (Room temperature, 50°F – 85°F [10°C – 30°C]).

### n Checking the fluid level

Make sure to check the fluid type and prepare the necessary items.

Fluid type	Automatic transmission fluid DEXRON® II or III
Items	Rag or paper, Clean funnel (only for adding fluid)

- STEP 1** Clean all dirt off the reservoir.
- STEP 2** Remove the cap by turning it counterclockwise.
- STEP 3** Wipe the dipstick clean.
- STEP 4** Reinstall and remove the reservoir cap again.
- STEP 5** Check the fluid level.

**⚠ CAUTION**

**n When checking the reservoir**

Take care, as the reservoir may be hot.

**⚠ NOTICE**

**n When adding fluid**

Avoid overfilling, or the power steering may be damaged.

**n After replacing the reservoir cap**

Check the steering box case, vane pump and hose connections for leaks or damage.

**Battery**

**n Exterior**

Make sure that the battery terminals are not corroded and that there are no loose connections, cracks, or loose clamps.

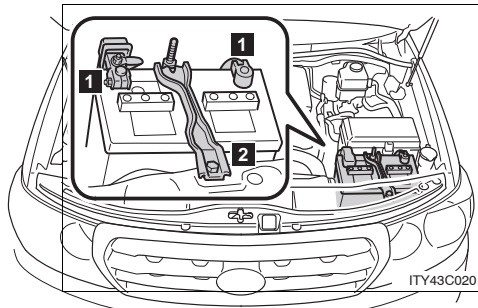

**1** Terminals

**2** Hold-down clamp

### n **Checking battery condition**

Check the battery condition using the indicator color.

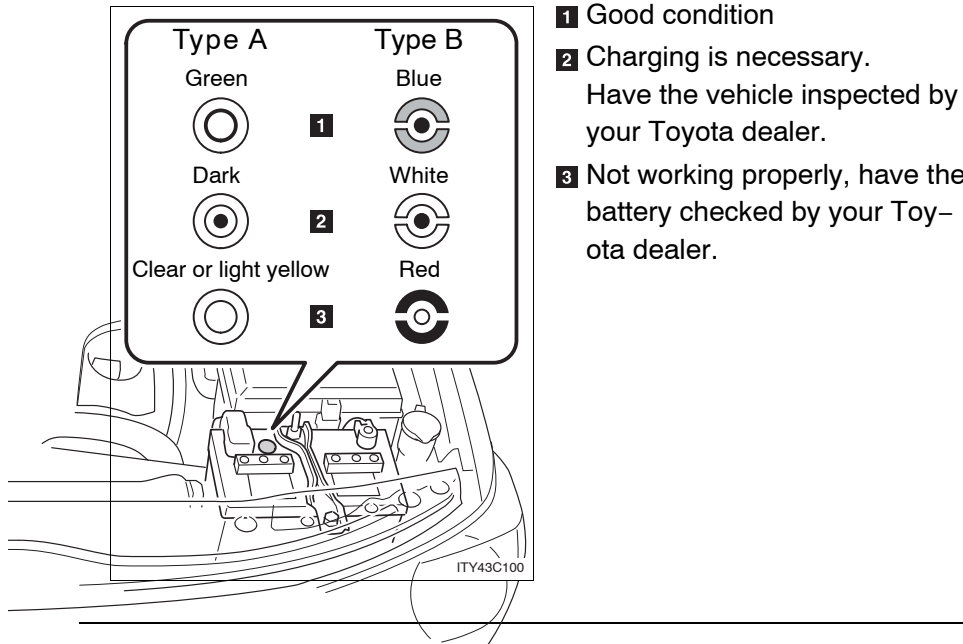

### n **Before recharging**

When recharging, the battery produces hydrogen gas which is flammable and explosive. Therefore, before recharging:

- 1 If recharging with the battery installed on the vehicle, be sure to disconnect the ground cable.
- 1 Make sure the power switch on the charger is off when connecting and disconnecting the charger cables to the battery.

### n **After recharging the battery**

The engine may not start. Follow the procedure below to initialize the system.

1. Depress the brake pedal with the shift lever in "N".
2. Open and close any of the doors.
3. Restart the engine.

**⚠ CAUTION****n Chemicals in the battery**

A battery contains poisonous and corrosive sulfuric acid and may produce hydrogen gas which is flammable and explosive. To reduce the risk of death or serious injury, take the following precautions while working on or near battery:

- l Do not cause sparks by touching the battery terminals with tools.
- l Do not smoke or light a match near the battery.
- l Avoid contact with eyes, skin and clothes.
- l Never inhale or swallow electrolyte.
- l Wear protective safety glasses when working near the battery.
- l Keep children away from the battery.

**n Where to safety charge the battery**

Always charge the battery in an open area. Do not charge the battery in a garage or closed room where there is not sufficient ventilation.

**n How to recharge the battery**

Only perform a slow charge (5A or less). The battery may explode if charged at a quicker rate.

**n Emergency measures regarding electrolyte**

- l If electrolyte gets in your eyes  
Flush your eyes with clean water for at least 15 minutes and get immediate medical attention. If possible, continue to apply water with a sponge or cloth while traveling to the nearest medical facility.
- l If electrolyte gets on your skin  
Wash the affected area thoroughly. If you feel pain or a burning sensation, seek medical attention immediately.
- l If electrolyte gets on your clothes  
It can soak through clothing on to your skin. Immediately take off the clothing and follow the procedure above if necessary.
- l If you accidentally swallow electrolyte  
Drink a large quantity of water or milk. Follow with milk of magnesia, beaten raw egg or vegetable oil. Get emergency medical attention immediately.



 NOTICE

**n When recharging the battery**

Never recharge the battery while the engine is running. Also, be sure all accessories are turned off.

**Washer fluid**

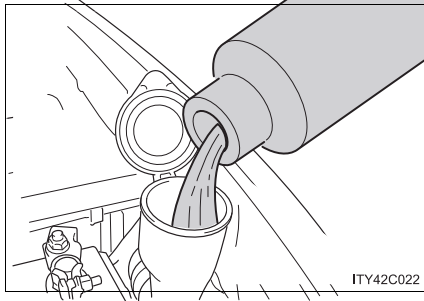

If any washer does not work or the warning message appears on the multi-information display, the washer tank may be empty. Add washer fluid.

 CAUTION

**n When refilling the washer fluid**

Do not refill the washer fluid when the engine is hot or running, as the washer fluid contains alcohol and may catch fire if spilled on the engine etc.

 NOTICE

**n Do not use any fluid other than washer fluid**

Do not use soapy water or engine antifreeze instead of washer fluid. Doing so may cause streaking on the vehicle's painted surfaces.

**n Diluting washer fluid**

Dilute washer fluid with water as necessary. Refer to the freezing temperatures listed on the washer fluid tank.

## 4-3. Do-it-yourself maintenance

### Tires

Replace or rotate tires in accordance with maintenance schedules and treadwear.

#### n Checking tires

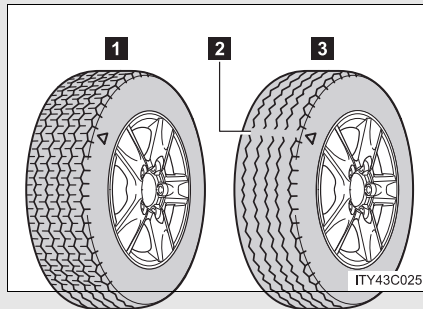

- 1 New tread
- 2 Treadwear indicator
- 3 Worn tread

The location of treadwear indicators is shown by the “TWI” or “ ” marks, etc., molded on the sidewall of each tire.

Check spare tire condition and inflation pressure if not rotated.

#### n Tire rotation

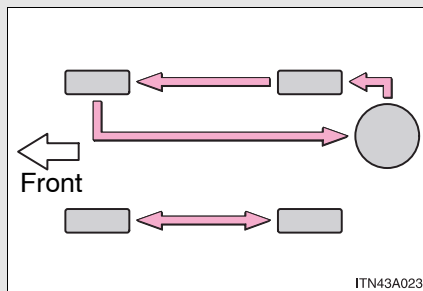

Rotate the tires in the order shown.

To equalize tire wear and extend tire life, Toyota recommends that tire rotation is carried out at the same interval as tire inspection.

Do not fail to initialize the tire pressure warning system after tire rotation.

#### n The tire pressure warning system

Your Toyota is equipped with a tire pressure warning system that uses tire pressure warning valves and transmitters to detect low tire inflation pressure before serious problems arise. ( P. 452)

### **Installing tire pressure warning valves and transmitters**

When replacing tires or wheels, tire pressure warning valves and transmitters must also be installed.

When new tire pressure warning valves and transmitters are installed, new tire pressure warning valve and transmitter ID codes must be registered in the tire pressure warning computer and tire pressure warning system must be initialized. Have tire pressure warning valve and transmitter ID codes registered by your Toyota dealer. ( P. 393, 395)

### Initializing the tire pressure warning system

**n The tire pressure warning system must be initialized in the following circumstances:**

- 1 When rotating the tires on vehicles differing with front and rear tire inflation pressures.
- 1 When changing the tire inflation pressure by changing traveling speed or load weight, etc.
- 1 When changing the tire size.

When the tire pressure warning system is initialized, the current tire inflation pressure is set as the pressure benchmark.

**n How to initialize the tire pressure warning system**

**STEP 1** Park the vehicle in safe place and turn the “ENGINE START STOP” switch to OFF mode.

While the vehicle is moving, initialization is not performed.

**STEP 2** Adjust the tire inflation pressure to the specified cold tire inflation pressure level. ( P. 502)

Make sure to adjust the tire pressure to the specified cold tire inflation pressure level. The tire pressure warning system will operate based on this pressure level.

**STEP 3** Turn the “ENGINE START STOP” switch to IGNITION ON mode.

4-3. Do-it-yourself maintenance

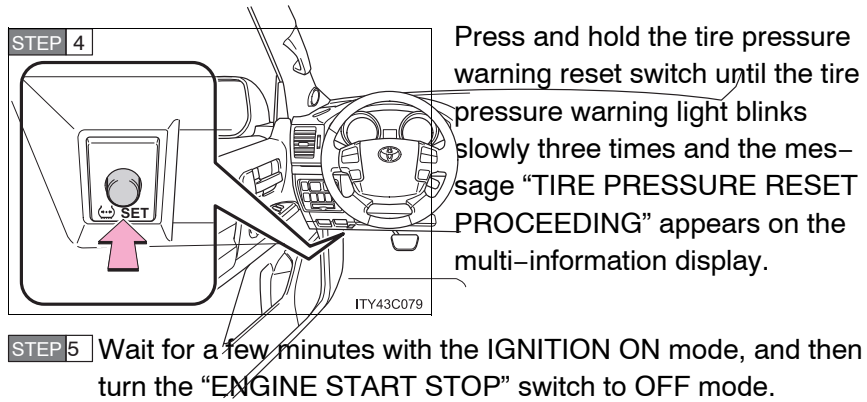

### Registering ID codes

The tire pressure warning valve and transmitter is equipped with a unique ID code. When replacing a tire pressure warning valve and transmitter, it is necessary to register the ID code of tire pressure warning valve and transmitter. Have the ID code registered by your Toyota dealer.

#### n **When to replace your vehicle's tires**

Tires should be replaced if:

- l You have tire damage such as cuts, splits, cracks deep enough to expose the fabric or bulges indicating internal damage
- l A tire goes flat repeatedly or cannot be properly repaired due to the size or location of a cut or other damage

If you are not sure, consult with your Toyota dealer.

#### n **Replacing tires and wheels**

If the ID code of the tire pressure warning valve and transmitter is not registered, the tire pressure warning system will not work properly. After driving for about 20 minutes, the tire pressure warning light comes on after blinking for 1 minute to indicate a system malfunction.

#### n **Tire life**

Any tire over 6 years old must be checked by a qualified technician even if they have seldom or never been used or damage is not obvious.

#### n **If the treadwears down below 0.16 in. (4 mm) on snow tires**

The effectiveness of snow tires is lost.

**n Maximum load of tire**

Check that the maximum load of the replaced tire is greater than 1/2 of the Gross Axle Weight Ratings (GAWR) of either the front axle or the rear axle, whichever is greater.

As for the maximum load of the tire, see the load limit at maximum cold tire inflation pressure mentioned on the sidewall of the tire, and as for the Gross Axle Weight Ratings (GAWR), see the Certification Label. ( P. 401, 507).

**n Tire types**

**1 Summer tires**

Summer tires are high-speed performance tires best suited to highway driving under dry conditions. Since summer tires do not have the same traction performance as snow tires, summer tires are inadequate for driving on snow-covered or icy roads. For driving on snow-covered roads or icy roads, the use of snow tires is recommended. When installing snow tires, be sure to replace all four tires.

**2 All season tires**

All season tires are designed to provide better traction in snow and to be adequate for driving in most winter conditions, as well as for use year round. All season tires, however, do not have adequate traction performance compared with snow tires in heavy or loose snow. Also, all season tires fall short in acceleration and handling performance compared with summer tires in highway driving.

**3 Snow tires**

For driving on snow-covered roads or icy roads, we recommend using snow tires. If you need snow tires, select tires of the same size, construction and load capacity as the originally installed tires. Since your vehicle has radial tires as original equipment, make sure your snow tires also have radial construction. Do not install studded tires without first checking local regulations for possible restriction. Snow tires should be installed on all wheels. ( P. 222)

■ **Initializing the tire pressure warning system**

Initialize the tires with the tire inflation pressure adjusted to the specified level.

■ **If you press the tire pressure reset switch accidentally**

If initialization is performed, adjust the tire inflation pressure to the specified level and initialize the tire pressure warning system again.

■ **When the initialization of the tire pressure warning system has failed**

Initialization can be completed in a few minutes. However, in the following cases, the settings have not been recorded and the system will not operate properly. If repeated attempts to record tire inflation pressure settings are unsuccessful, have the vehicle inspected by your Toyota dealer.

1 When operating the tire pressure warning reset switch, the warning light does not flash 3 times and the setting message does not appear on the multi-information display.

1 After carrying out the initialization procedure, the tire pressure warning light blinks for 1 minute then stays on after driving for about 20 minutes.

■ **Routine tire inflation pressure checks**

The tire pressure warning system does not replace routine tire inflation pressure checks. Make sure to check tire inflation pressure as part of your routine of daily vehicle checks.



**n Tire pressure warning system certification**

This device complies with Part 15 of the FCC Rules. Operation is subject to the following two conditions: (1) this device may not cause harmful interference, and (2) this device must accept any interference received, including interference that may cause undesired operation.

**NOTICE:**

This equipment has been tested and found to comply with the limits for a Class B digital device, pursuant to Part 15 of the FCC Rules. These limits are designed to provide reasonable protection against harmful interference in a residential installation. This equipment generates, uses and can radiate radio frequency energy and, if not installed and used in accordance with the instructions, may cause harmful interference to radio communications. However, there is no guarantee that interference will not occur in a particular installation. If this equipment does cause harmful interference to radio or television reception, which can be determined by turning the equipment off and on, the user is encouraged to try to correct the interference by one or more of the following measures:

- 1 Reorient or relocate the receiving antenna.
- 1 Increase the separation between the equipment and receiver.
- 1 Connect the equipment into an outlet on a circuit different from that to which the receiver is connected.
- 1 Consult the dealer or an experienced radio/TV technician for help.

**FCC WARNING:**

Changes or modifications not expressly approved by the party responsible for compliance could void the user's authority to operate the equipment.

**⚠ CAUTION****n Tire pressure warning system operation**

The tire pressure warning system may not provide warning immediately if a tire bursts or if sudden air leakage occurs.

**n When inspecting or replacing tires**

Observe the following precautions to prevent accidents. Failure to do so may cause damage to parts of the drive train, as well as dangerous handling characteristics, which may lead to fatal or injury accidents.

- l Do not mix tires of different makes, models, tread patterns or tread-wear.
- l Do not use tire sizes other than those recommended by Toyota.
- l Do not mix radial, bias-belted, or bias-ply tires.
- l Do not mix summer, all season and winter tires.
- l Do not use tire that have been used on another vehicle.  
Do not use tires if you do not know they were used previously.

**n When initializing the tire pressure warning system**

Do not press the tire pressure warning reset switch without first adjusting the tire inflation pressure to the specified level. Otherwise, the tire pressure warning light may not come on even if the tire inflation pressure is low, or it may come on when the tire inflation pressure is actually normal.

**⚠ NOTICE****n Repairing or replacing tires, wheels and tire pressure warning valves and transmitters**

When removing or fitting the wheels, tires or the tire pressure warning valve and transmitter, contact your Toyota dealer as the tire pressure warning valve and transmitter may be damaged if not handled correctly.

**n To avoid damaging the tire pressure warning valves and transmitters**

Do not use liquid sealants on flat tires.

 NOTICE

**n Driving on rough roads**

Take particular care when driving on roads with loose surfaces or pot-holes.

These conditions may cause losses in tire inflation pressure, reducing the cushioning ability of the tires. In addition driving on rough roads may cause damage to the tires themselves, as well as the vehicle's wheels and body.

**n If tire inflation pressures become low while driving**

Do not continue driving, or your tires and/or wheels may be ruined.

## 4-3. Do-it-yourself maintenance Tire inflation pressure

### n Tire inflation pressure

The recommended cold tire inflation pressure and tire size is displayed on the tire and loading information label. ( P. 502)

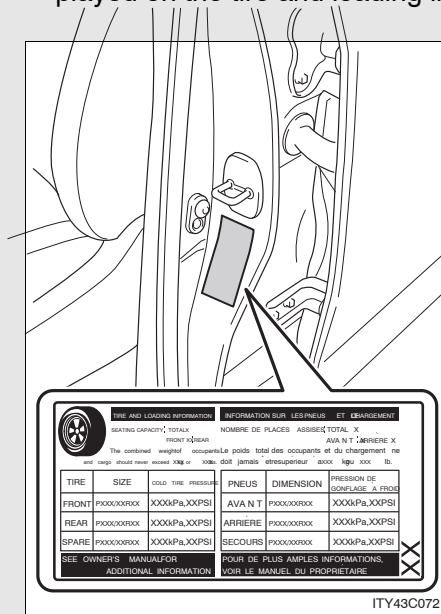

4-3. Do-it-

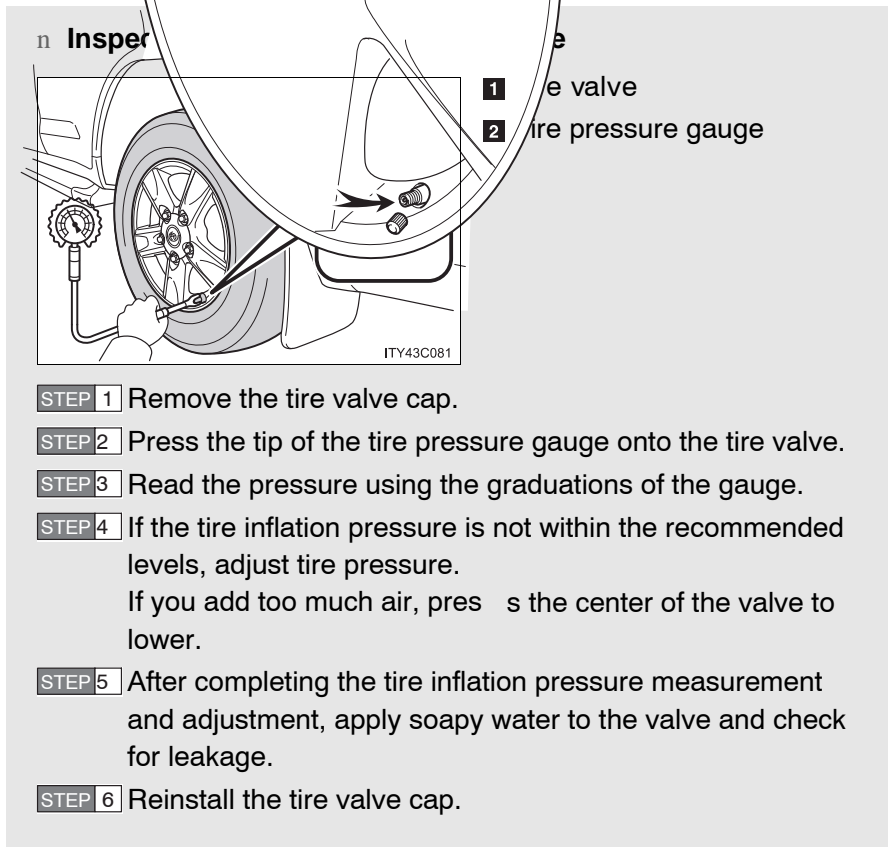

#### n **Tire inflation pressure check interval**

You should check tire inflation pressure every 2 weeks, or at least once a month.

Do not forget to check the spare.

**n Effects of incorrect tire inflation pressure**

Driving with incorrect tire inflation pressure may result in the following:

- | Reduced fuel efficiency
- | Reduced driving comfort and tire life
- | Reduced safety
- | Damage to the drive train

If a tire needs frequent refilling, have it checked by your Toyota dealer.

**n Instructions for checking tire inflation pressure**

When checking tire inflation pressure, observe the following:

- | Check only when the tires are cold.  
If your vehicle has been parked for at least 3 hours and has not been driven for more than 1 mile or 1.5 km, you will get an accurate cold tire inflation pressure reading.
- | Always use a tire pressure gauge.  
The appearance of the tire can be misleading. In addition, tire inflation pressures that are even just a few pounds off can degrade ride and handling.
- | Do not bleed or reduce tire inflation pressure after driving. It is normal for the tire inflation pressure to be higher after driving.
- | Never exceed the vehicle capacity weight.  
Passengers and luggage weight should be placed so that the vehicle is balanced.

 CAUTION

**n Proper inflation is critical to save tire performance**

Keep your tires properly inflated. Otherwise, the following conditions may occur and result in an accident causing death or serious injury.

- ! Excessive wear
- ! Uneven wear
- ! Poor handling
- ! Possibility of blowouts resulting from overheated tires
- ! Poor sealing of the tire bead
- ! Wheel deformation and/or tire separation
- ! A greater possibility of tire damage from road hazards

 NOTICE

**n When inspecting and adjusting tire inflation pressure**

Be sure to reinstall the tire valve caps.  
Without the valve caps, dirt or moisture could get into the valve and cause air leakage, which could result in an accident. If the caps have been lost, replace them as soon as possible.

## Wheels

**If a wheel is bent, cracked or heavily corroded, it should be replaced.**

**Otherwise, the tire may separate from the wheel or cause loss of handling control.**

**n Wheel selection**

When replacing wheels, care should be taken to ensure that they are equivalent to those removed in load capacity, diameter, rim width, and offset.

Replacement wheels are available at your Toyota dealer.

Toyota does not recommend using:

- 1 Wheels of different sizes or types
- 1 Used wheels
- 1 Bent wheels that have been straightened

**n Aluminum wheel precautions**

- 1 Use only Toyota wheel nuts and wrenches designed for use with your aluminum wheels.
- 1 When rotating, repairing or changing your tires, check that the wheel nuts are still tight after driving 1000 miles (1600 km).
- 1 Be careful not to damage the aluminum wheels when using tire chains.
- 1 Use only Toyota genuine balance weights or equivalent and a plastic or rubber hammer when balancing your wheels.



**n When replacing wheels**

The wheels of your Toyota are equipped with tire pressure warning valves and transmitters that allow the tire pressure warning system to provide advanced warning in the event of a loss in tire inflation pressure. Whenever wheels are replaced, the tire pressure warning valves and transmitters must be installed. ( P. 392)

**⚠ CAUTION**

**n When replacing wheels**

- I** Do not use wheels that are a different size from those recommended in the Owner's Manual, as this may result in loss of handling control.
- I** Never use an inner tube in a leaking wheel which is designed for a tube-less tire. Doing so may result in an accident, causing death or serious injury.

**⚠ NOTICE**

**n Replacing tire pressure warning valves and transmitters**

- I** Because tire repair or replacement may affect the tire pressure warning valves and transmitters, make sure to have tires serviced by your Toyota dealer or other qualified service shop. In addition, make sure to purchase your tire pressure warning valves and transmitters at your Toyota dealer.
- I** Ensure that only genuine Toyota wheels are used on your vehicle. Tire pressure warning valves and transmitters may not work properly with non-genuine wheels.

4-3. Do-it-yourself maintenance  
Air conditioning filter

The air conditioning filter must be changed regularly to maintain air conditioning efficiency.

**n Removal method**

**STEP 1** Turn the “ENGINE START STOP” switch IGNITION ON mode and switch to recirculated air mode, then turn the “ENGINE START STOP” switch off.

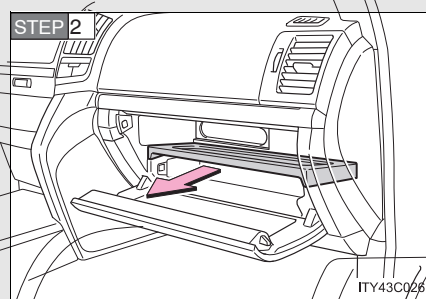

Open the glove box and remove the partition.

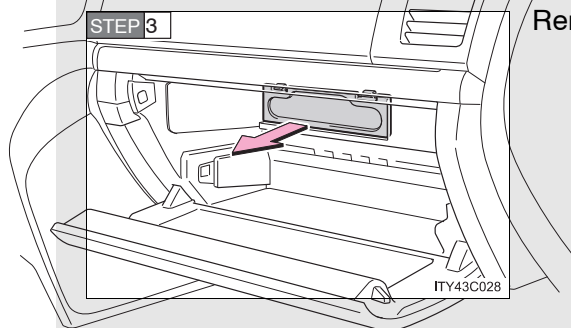

Remove the filter cover.

4-3. Do-it-yourself maintenance

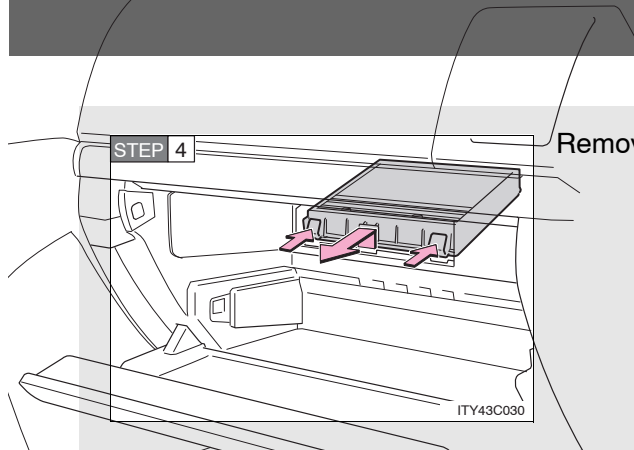

Remove the filter case.

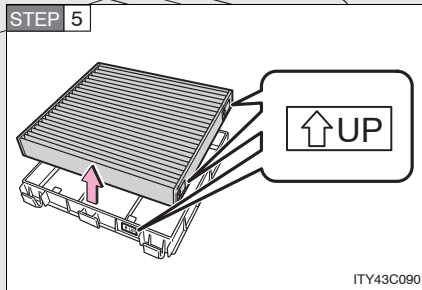

Remove the air conditioning filter and replace it with a new one.

The “ UP” marks shown on the filter should be pointing up.

n **Cleaning method**

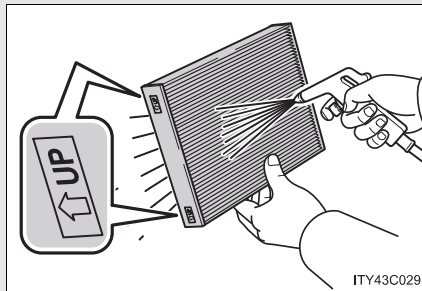

If the filter is dirty, clean by blowing compressed air through the filter from the downward side.

Hold the air gun 2 in. (5 cm) from the filter and blow for approximately 2 minutes at 72 psi (500 kpa, 5.0 kgf/cm<sup>2</sup> or bar).

If it is not available, have the filter cleaned by your Toyota dealer.

n **Changing interval**

Inspect and replace the air conditioning filter according to the maintenance schedule. In dusty areas or areas with heavy traffic flow, early replacement may be required. (For scheduled maintenance information, read the “Scheduled Maintenance Guide”, “Owner’s Manual Supplement”.)

n **If air flow from the vents decreases dramatically**

The filter may be clogged. Check the filter and replace if necessary.

 **NOTICE**

n **To prevent damage to the system**

- l When using the air conditioning system, make sure that a filter is always installed.
- l When cleaning the filter, do not clean the filter with water.

4-3. Do-it-yourself maintenance  
Electronic key battery

**Replace the battery with a new one if it is discharged.**

n **You will need the following items:**

- 1 Flathead screwdriver (To prevent damage to the key, cover the tip of the screwdriver with rag.)
- 1 Small Phillips-head screwdriver
- 1 Lithium battery CR1632

n **Replacing the battery**

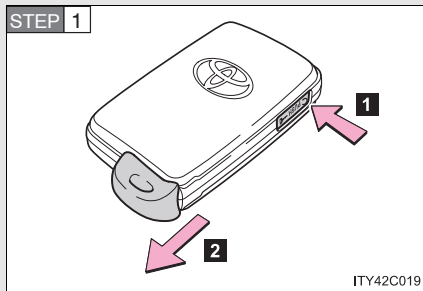

Take out the mechanical key.

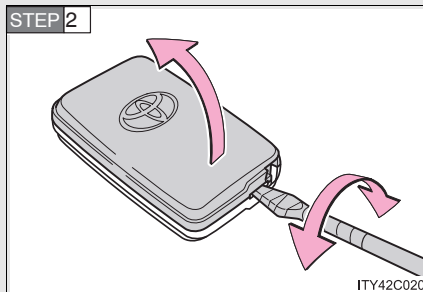

Remove the cover.

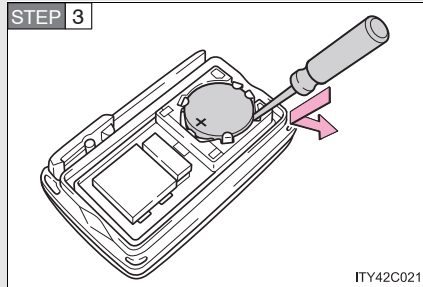

Remove the depleted battery.

Insert a new battery with the "+" terminal facing up.

■ **If the electronic key battery is discharged**

The following symptoms may occur.

- 1 The smart key system and wireless remote control will not function properly.
- 1 The operational range is reduced.

■ **Use a CR1632 lithium battery**

- 1 Batteries can be purchased at your Toyota dealer, jewelers, or camera stores.
- 1 Replace only with the same or equivalent type recommended by a Toyota dealer.
- 1 Dispose of used batteries according to the local laws.

 CAUTION

**n Removed battery and other parts**

Keep away from children.

These parts are small and if swallowed by a child they can cause choking.

 NOTICE

**n For normal operation after replacing the battery**

Observe the following precautions to prevent accidents.

- l** Always work with dry hands.  
Moisture may cause the battery to rust.
- l** Do not touch or move any other components inside the electronic key.
- l** Do not bend the battery terminals.

4-3. Do-it-yourself maintenance  
Checking and replacing fuses

If any of the electrical components do not operate, a fuse may have blown. If this happens, check and replace the fuses as necessary.

**STEP 1** Turn the "ENGINE START STOP" switch off.

**STEP 2** Open the fuse box cover.

► Engine compartment

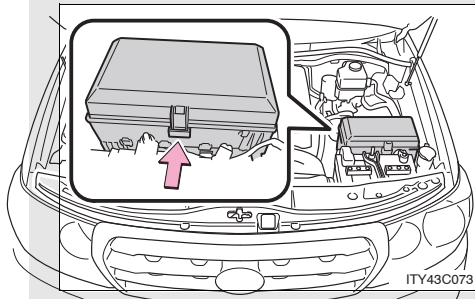

Push the tab in and lift the lid off.

► Driver's side instrument panel

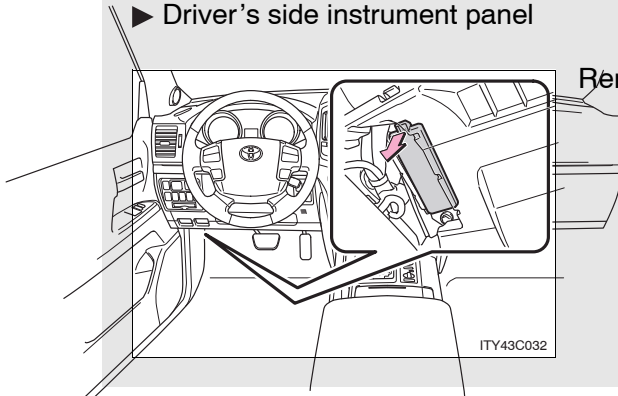

Remove the lid.



4-3. Do-it-yourself maintenance

► Passenger's side instrument panel

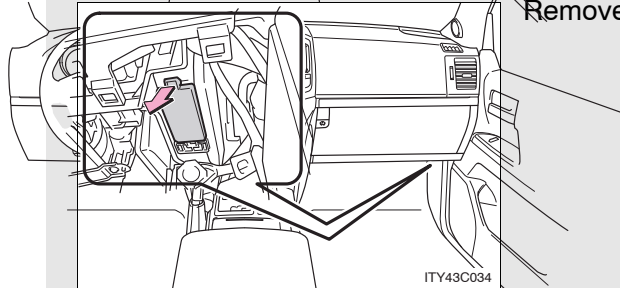
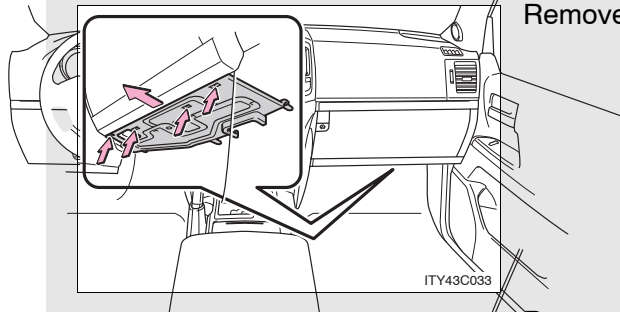

**STEP 3** After a system failure, see "Fuse layout and amperage ratings" ( P. 417) for details about which fuse to check.

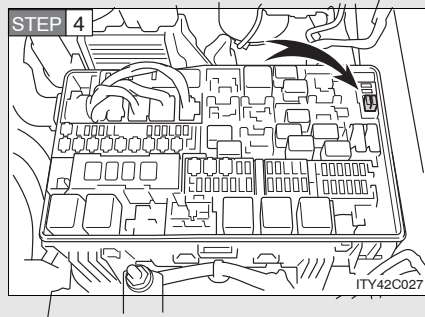

**STEP 5** Check if the fuse has blown.

► Type A and B

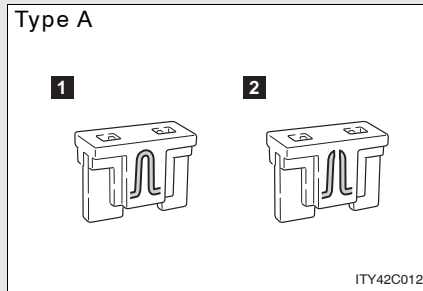

**1** Normal fuse

**2** Blown fuse

Replace it with one of an appropriate amperage rating. The amperage rating can be found on the fuse box lid.

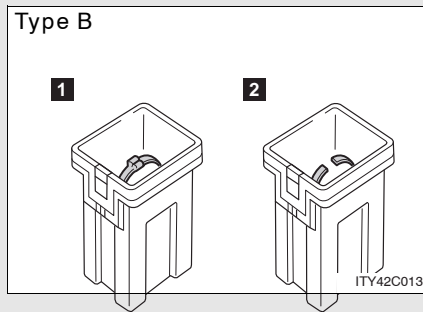

► Type C and D

Type C

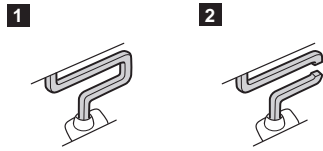

ITY42C014

Type D



ITY42C015

**1** Normal fuse

**2** Blown fuse

Contact your Toyota dealer.

**Fuse layout and amperage ratings**

**n Engine compartment**

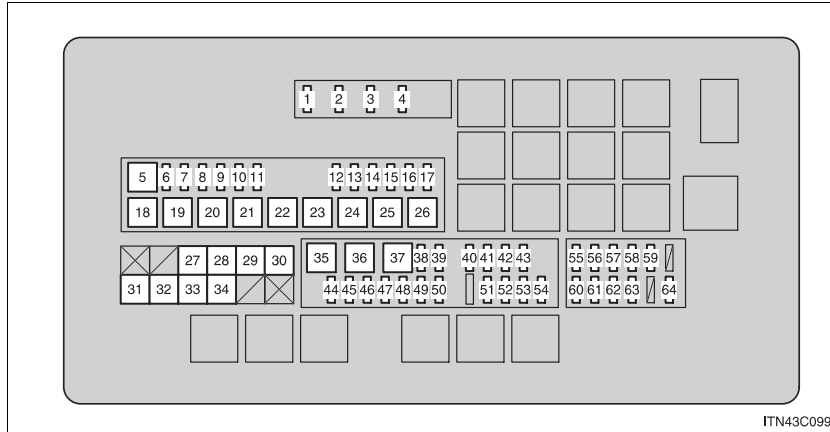

Fuse	Ampere	Circuit
1	15 A	A/F heater
2	10 A	Horn
3	25 A	EFI, A/F heater
4	30 A	Injector, ignition, meter
5	50 A	No circuit
6	25 A	No circuit
7	20 A	Rear seat heater
8	20 A	Windshield wiper de-icer
9	25 A	Condenser fan
10	30 A	Towing tail
11	30 A	No circuit
12	10 A	Alternator condenser
13	15 A	Front fog lights
14	5 A	Security horn
15	25 A	No circuit

4-3. Do-it-yourself maintenance

Fuse		Ampere	Circuit
16	STOP	15 A	Stoplights, high mounted stop-light, brake controller, towing converter, ABS, VSC, main body ECU, EFI
17	TOW BRK	30 A	Brake controller
18	RR AUTO A/C	50 A	Rear blower control
19	PTC-1	50 A	PTC heater
20	PTC-2	50 A	PTC heater
21	PTC-3	50 A	PTC heater
22	RH-J/B	40 A	No circuit
23	SUB BATT	40 A	To w i n g
24	VGRS	40 A	No circuit
25	H-LP CLN	30 A	Headlight cleaner
26	DEFOG	30 A	Rear window defogger
27	AHC	60 A	No circuit
28	HTR	50 A	Blower controller
29	PBD	30 A	No circuit
30	LH-J/B	150 A	Main body ECU
31	ALT	180 A	No circuit
32	A/PUMP NO.1	50 A	AI DRIVER
33	A/PUMP NO.2	50 A	AI DRIVER2
34	MAIN	40 A	Headlight, daytime running light system
35	ABS1	50 A	ABS
36	ABS2	30 A	ABS
37	ST	30 A	Starter system
38	IMB	7.5 A	ID code box, smart key system, GBS
39	AM2	5 A	Main body ECU
40	DOME2	7.5 A	Vanity lights, overhead module

Fuse		Ampere	Circuit
41	ECU-B2	5 A	Driving position memory system
42	TEL	5 A	No circuit
43	RSE	7.5 A	Rear seat entertainment
44	TOWING	30 A	Towing
45	DOOR NO.2	25 A	Main body ECU
46	STR LOCK	20 A	Steering lock system
47	TURN-HAZ	15 A	Meter, front turn signal lights, rear turn signal lights, towing converter
48	EFI MAIN2	20 A	Fuel pump
49	ETCS	10 A	EFI
50	ALT-S	5 A	IC-ALT
51	AMP	30 A	Audio system
52	RAD NO.1	10 A	Navigation system, radio receiver assembly
53	ECU-B1	5 A	smart key system, overhead module, tilt and telescopic steering, meter, cool box, gateway ECU, steering sensor
54	DOME1	5 A	Door courtesy lights, clock
55	HEAD LH	15 A	Headlight high beam (left)
56	HEAD LL	15 A	Headlight low beam (left)
57	INJ	10 A	Injector, ignition
58	MET	5 A	Meter
59	IGN	10 A	Circuit open, SRS airbag system, gateway ECU, occupant detection system, smart key system, ABS, VSC, steering lock system, GBS
60	HEAD RH	15 A	Headlight high beam (right)

4-3. Do-it-yourself maintenance

	Fuse	Ampere	Circuit
61	HEAD RL	15 A	Headlight low beam (right)
62	EFI NO.2	7.5 A	AFM, EVP VSV, 02 SSR, KEY OFF PMP, AI DRIVER, AI EX VSV, ACIS VSV
63	RR A/C NO.2	7.5 A	No circuit
64	DEF NO.2	5 A	Outside rear view mirror heater

n Driver's side instrument panel

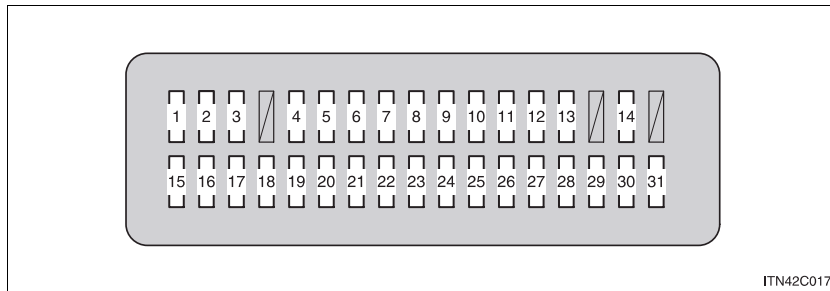

ITN42C017

Fuse		Ampere	Circuit
1	CIG	15 A	Cigarette lighter
2	BK/UP LP	10 A	Back-up lights, trailer
3	ACC	7.5 A	Stereo component amplifier assembly, multi-display assembly, gateway ECU, radio receiver assembly, main body ECU, mirror ECU, rear seat entertainment, smart key system, clock
4	PANEL	10 A	Four-wheel drive system, ash-tray, cigarette lighter, brake controller, cool box, cruise control, center differential lock, DAC, multi-display assembly, seat heater, air conditioning system, glove box light, emergency flasher, radio receiver assembly, headlight cleaner, inverter, driving position memory system, mirror ECU, overhead module, roll sensing of curtain shield airbags off switch, shift lever switch, steering switches, VSC, console switch



4-3. Do-it-yourself maintenance

Fuse		Ampere	Circuit
5	ECU-IG NO.2	10 A	Air conditioning system, heater, overhead module, ABS, VSC, steering sensor, yaw rate & G sensor, main body ECU, stoplights, moon roof, clock, EC mirror
6	WINCH	5 A	No circuit
7	A/C IG	10 A	Cool box, condenser fan, cooler compressor, MG CL, rear window defogger, RR MGC VLV
8	TAIL	15 A	Tail lights, license plate lights, front fog lights, front side marker lights, rear side marker lights, parking lights
9	WIPER	30 A	Windshield wiper
10	WSH	20 A	Windshield washer
11	RR WIPER	15 A	Rear wiper
12	4WD	20 A	4WD
13	LH-IG	5 A	Alternator, sub battery, seat heater, windshield wiper de-icer, seat belt pretensioners, emergency flasher, inverter, shift lever switch
14	ECU-IG NO.1	5 A	ABS, VSC, tilt and telescopic steering, gateway ECU, shift lock system, cruise control system, pre-collision seat belt, headlight cleaner, multi-display assembly, driving position memory system, power door lock system
15	S/ROOF	25 A	Moon roof

	Fuse	Ampere	Circuit
16	RR DOOR RH	20 A	Power windows
17	MIR	15 A	Mirror ECU, outside rear view mirror heater
18	RR DOOR LH	20 A	Power windows
19	FR DOOR LH	20 A	Power windows
20	FR DOOR RH	20 A	Power windows
21	RR FOG	7.5 A	No circuit
22	A/C	7.5 A	Air conditioning system
23	AM1	5 A	No circuit
24	TI & TE	15 A	Tilt and telescopic steering
25	FR P/SEAT RH	30 A	Front seat adjustment
26	PWR OUTLET	15 A	Power outlet
27	OBD	7.5 A	DLC3
28	PSB	30 A	Pre-collision seat belt
29	DOOR NO.1	25 A	Main body ECU
30	FR P/SEAT LH	30 A	Front seat adjustment
31	INVERTER	15 A	Inverter

4-3. Do-it-yourself maintenance

n Passenger's side instrument panel

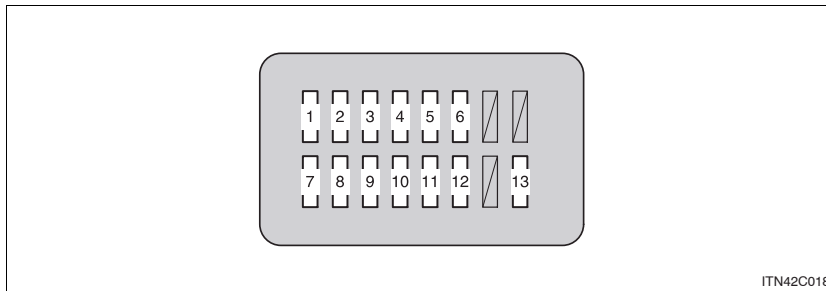

	Fuse	Ampere	Circuit
1	RSF LH	30 A	No circuit
2	B/DR CLSR RH	30 A	No circuit
3	B/DR CLSR LH	30 A	No circuit
4	RSF RH	30 A	No circuit
5	DOOR DL	15 A	No circuit
6	AHC-B	20 A	No circuit
7	AHC-B NO.2	10 A	No circuit
8	ECU-IG NO.4	5 A	Tire pressure warning system
9	SEAT-A/C FAN	10 A	No circuit
10	SEAT-HTR	20 A	Seat heater
11	AFS	5 A	No circuit
12	ECU-IG NO.3	5 A	No circuit
13	TV	10 A	Multi-display assembly

**n After a fuse is replaced**

- l If the lights do not turn on even after the fuse has been replaced, a bulb may need replacement. ( P. 426)
- l If the replaced fuse blows again, have the vehicle inspected by your Toyota dealer.

**n If there is an overload in the circuits**

- l The fuses are designed to blow the entire wiring harness is damaged.

**⚠ CAUTION**

**n To prevent system breakdowns and vehicle fire**

Observe the following precautions.

Failing to do so may cause damage, and possibly a fire or injury.

- l Never use a fuse of a higher amperage rating than indicated, or use any other object in place of a fuse.
- l Always use a genuine Toyota fuse or equivalent.  
Never replace a fuse with a wire, even as a temporary fix.  
This can cause extensive damage or even fire.
- l Do not modify fuses or the fuse box.

**⚠ NOTICE**

**n Before replacing fuses**

Have the cause of electrical overload determined and repaired by your Toyota dealer.

4-3. Do-it-yourself maintenance  
Light bulbs

You may replace the following bulb s yourself. For more information about replacing other light bulbs, contact your Toyota dealer.

n **Prepare a replacement light bulb.**

Check the wattage of the light bulb being replaced. ( P. 503)

n

P. 376

n **Front bulb locations**

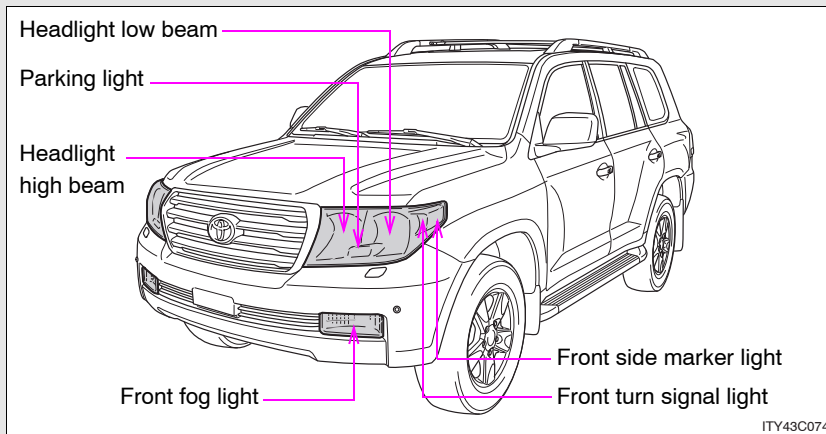

n **Rear bulb locations**

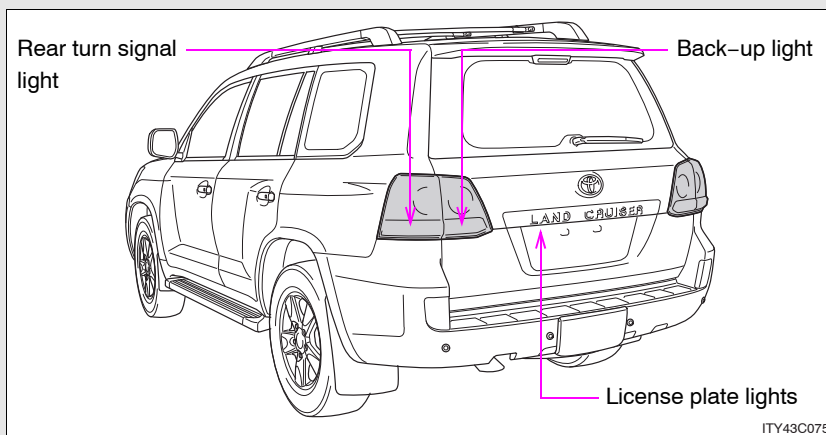

## Replacing light bulbs

### n Headlight low beam

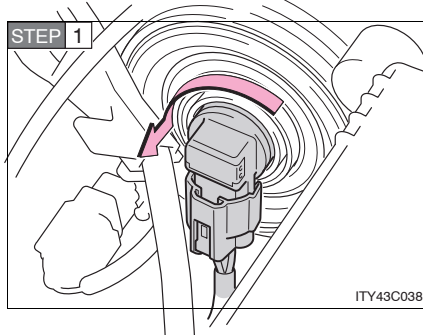

Turn the bulb base counterclockwise.

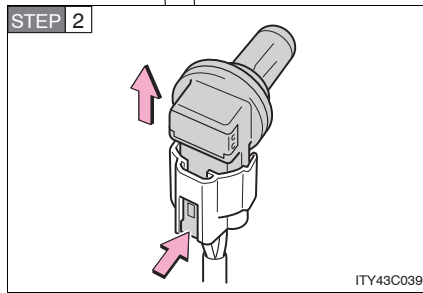

Unplug the connector while depressing the lock release.

n **Headlight high beam**

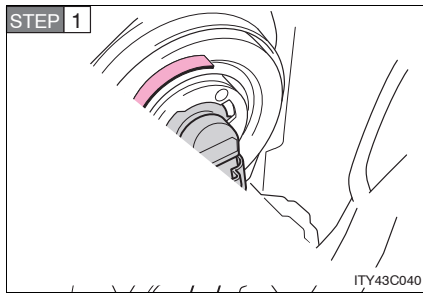

Turn the bulb base counterclockwise.

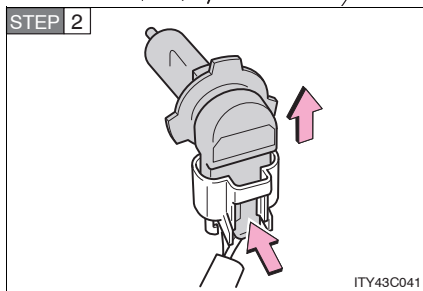

Unplug the connector while depressing the lock release.

### n Front fog light

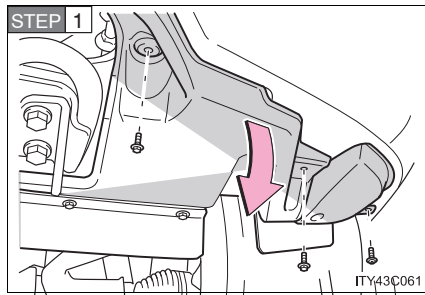

Remove the fender liner bolts and clip and remove the fender liner.

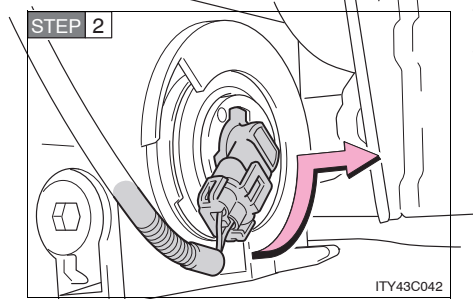

Turn the bulb base counterclockwise.

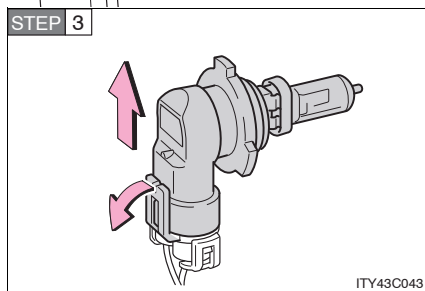

Unplug the connector while pulling the lock release.



n **Parking light**

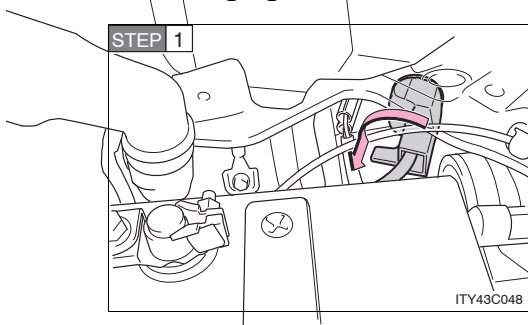

Turn the bulb base counterclockwise.

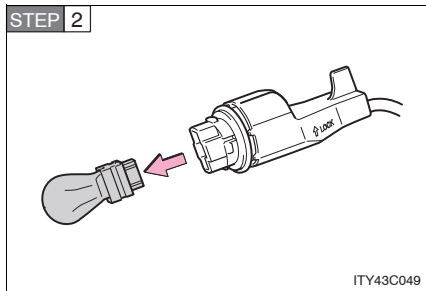

Remove the light bulb.

### n Front turn signal light

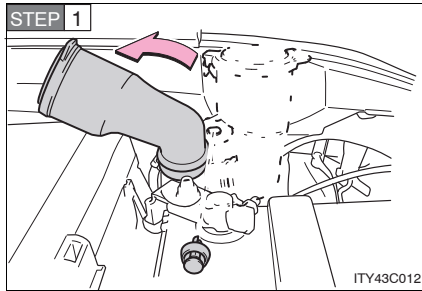

For the left side only: Remove the securing bolt and move the washer fluid filler opening.

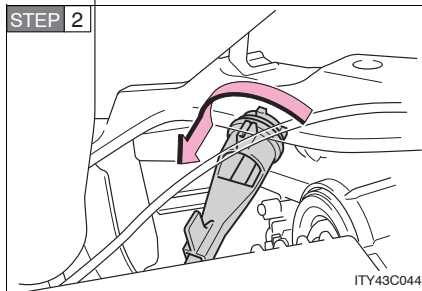

Turn the bulb base counterclockwise.

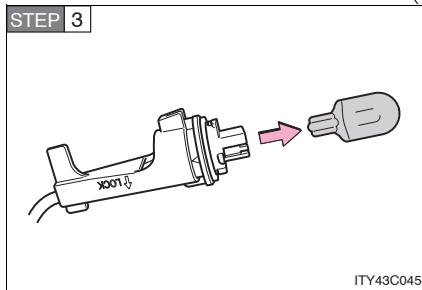

Remove the light bulb.

n **Front side marker light**

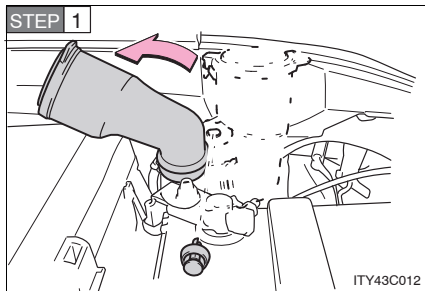

For the left side only: Remove the securing bolt and move the washer fluid filler opening.

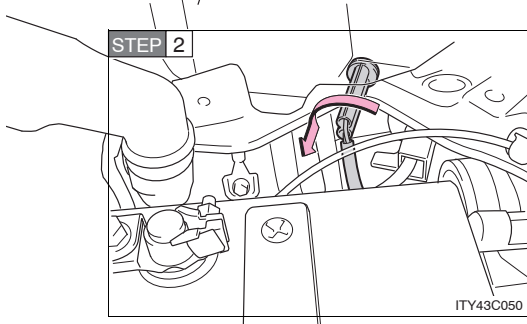

Turn the bulb base counterclockwise.

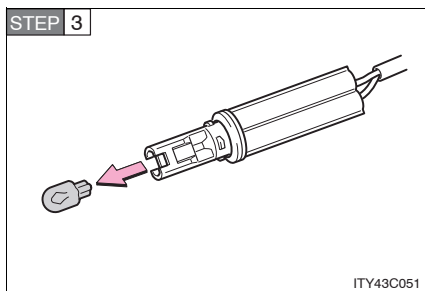

Remove the light bulb.

### n Back-up light

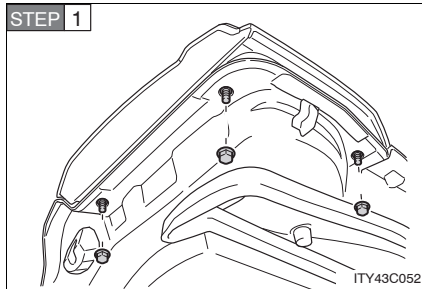

Open the back door and remove the cover.

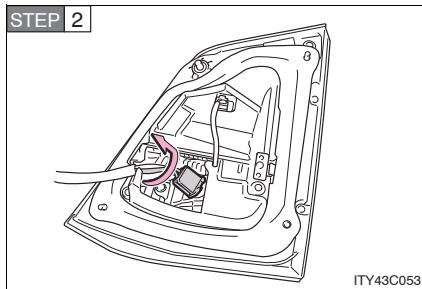

Turn the bulb bases counter-clockwise.

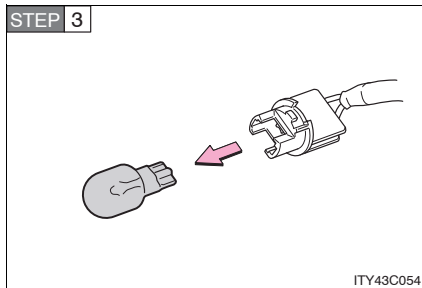

Remove the light bulb.

n **Rear turn signal light**

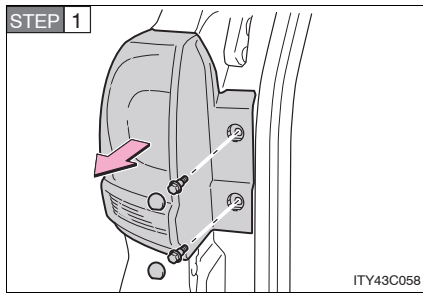

Open the back door and remove the cover.

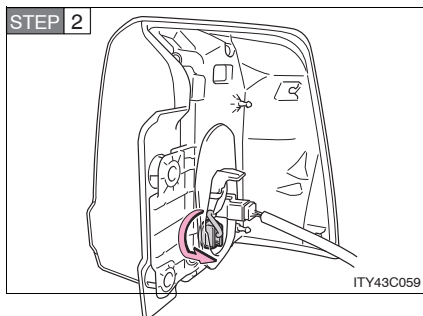

Turn the bulb bases counter-clockwise.

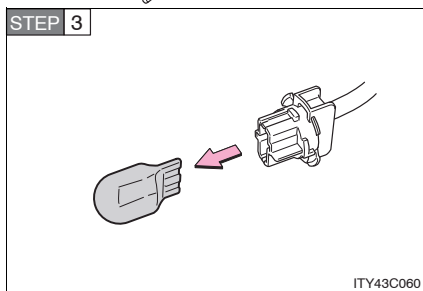

Remove the light bulb.

n License plate light

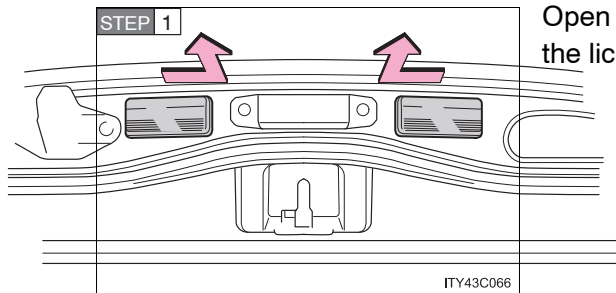

Open the back door and remove the license plate light unit.

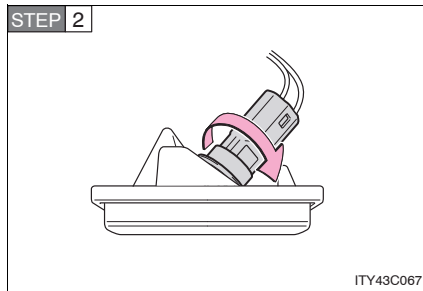

Turn the bulb base counterclockwise.

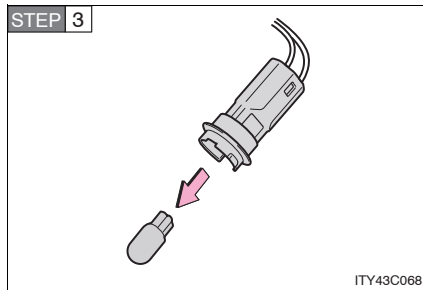

Remove the light bulb.

n **Bulbs other than the above**

If any of the bulbs listed below has burnt out, have your Toyota dealer replace it.

- l Stop/tail lights
- l Tail lights
- l High mounted stoplight
- l Rear side marker lights

---

n **Condensation build-up on the inside of the lens**

Contact your Toyota dealer for more information in the following situations. Temporary condensation build-up on the inside of the headlight lens does not indicate a malfunction.

- l Large drops of water are built up on the inside of the lens.
- l Water has built up inside the headlight.

n **LED light bulbs**

The stop/tail, tail, rear side marker and high mounted stoplight consist of a number of LEDs. If any LEDs burn out, take your vehicle to your Toyota dealer to have the light replaced.

If two or more LEDs in a stoplight burn out, your vehicle may not conform to local laws (SAE).

 CAUTION

**n Replacing light bulbs**

- I** Turn off the headlights. Do not attempt to replace the bulb immediately after turning off the headlights.  
The bulbs become very hot and may cause burns.
- I** Do not touch the glass portion of the light bulb with bare hands. Hold the bulb by the plastic or metal portion.  
If the bulb is scratched or dropped it may blow out or crack.
- I** Fully install light bulbs and any parts used to secure them. Failing to do so may result in heat damage, fire, or water entering the headlight unit. This may damage the headlights or cause condensation to build up on the lens.
- I** Do not attempt to repair or disassemble light bulbs, connectors, electric circuits or component parts.  
Doing so may result in death or serious injury due to electric shock.

**n To prevent damage or fire**

Make sure bulbs are fully seated and locked.



### 4-3. Do-it-yourself maintenance

## 5-1. Essential information

### If your vehicle needs to be towed

If towing is necessary, we recommend having your vehicle towed by your Toyota dealer or a commercial towing service, using a lift-type truck or a flat bed truck.

Use a safety chain system for all towing, and abide by all state/provincial and local laws.

Use a towing dolly or flat bed truck.

#### Before towing

The following may indicate a problem with your transmission. Contact your Toyota dealer before towing.

- 1 The engine is running, but the vehicle will not move.
- 1 The vehicle makes an abnormal sound.

#### Emergency towing

If a tow truck is not available in an emergency, your vehicle may be temporarily towed using a cable or chain secured to the following part. This should only be attempted on hard, surfaced roads for short distances at low speeds.

A driver must be in the vehicle to steer and operate the brakes. The vehicle's wheels, drive train, axles, steering and brakes must be in good condition.

##### ► Towing hook

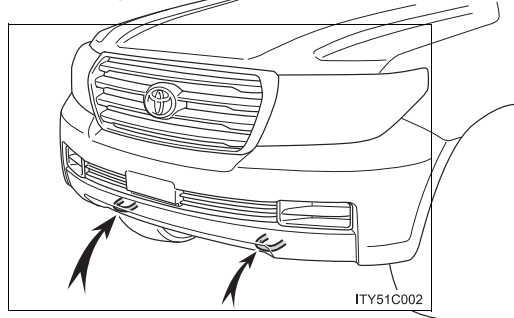

**n Emergency towing procedure**

- STEP 1** The engine must be in ACCESSORY mode (engine off) or IGNITION ON mode (engine running).
- STEP 2** Put the four-wheel drive control switch in "H4". (The center differential is unlocked.)
- STEP 3** Put the shift lever in "N".
- STEP 4** Release the parking brake.

**⚠ CAUTION****n While towing**

- I** Use extreme caution when towing the vehicle. Avoid sudden starts or erratic driving maneuvers which place excessive stress on the emergency towing hook and the cable or chain.
- I** If the engine is not running, the power assist for the brakes and steering will not function, making steering and braking more difficult.

**⚠ NOTICE****n To prevent causing serious damage to the transmission**

- I** Never tow this vehicle wheels on the ground.
- I** Use only the front emergency towing hooks or towing eyelets (depending on vehicles) when towing your vehicle.

### Towing with a sling-type truck

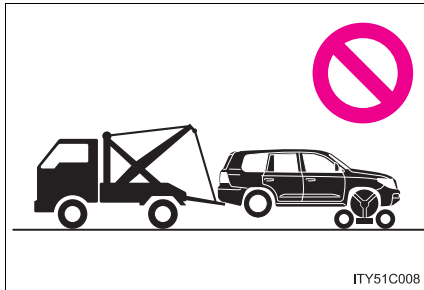

 NOTICE

**n To prevent body damage**

Do not tow with a sling type truck, either from the front or rear.

**Towing with a wheel lift-type truck**

## ▶ From front

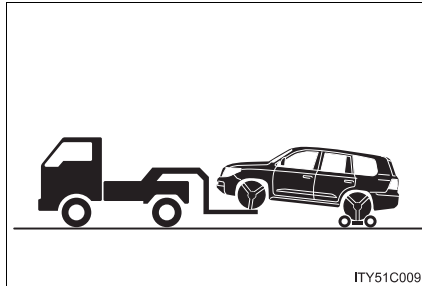

Use a towing dolly under the rear wheels.

## ▶ From rear

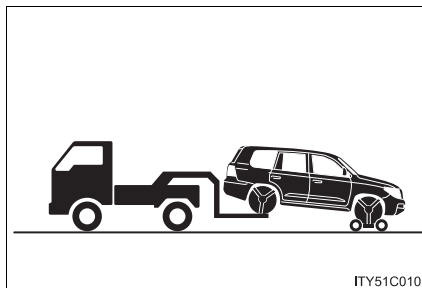

Use a towing dolly under the front wheels.

 **NOTICE**

**n To prevent causing serious damage to the transmission**

Never tow this vehicle wheels on the ground.

**n To prevent damaging the vehicle**

- I** Do not tow the vehicle with the “ENGINE START STOP” switch off. The steering lock mechanism is not strong enough to hold the front wheel straight.
- I** When raising the vehicle, ensure adequate ground clearance for towing at the opposite end of the raised vehicle. Without adequate clearance, the vehicle could be damaged while being towed.

### Using a flat bed truck

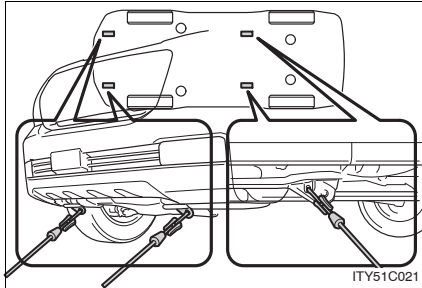

If your Toyota is transported by a flat bed truck, it should be tied down at the locations shown in the illustration.

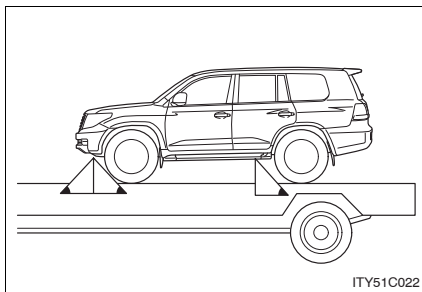

If you use chains or cables to tie down your vehicle, the angles shaded in black must be 45°.

Do not overly tighten the tie downs or the vehicle may be damaged.

#### NOTICE

**n To avoid serious damage to your vehicle**

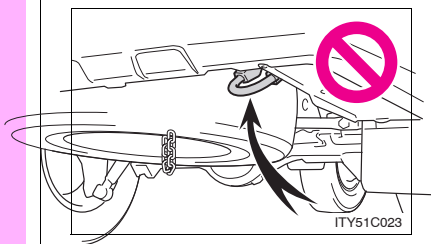

Do not use the rear emergency towing hook.

## If you think something is wrong

**If you notice any of the following symptoms, your vehicle probably needs adjustment or repair. Contact your Toyota dealer as soon as possible.**

### **n Visible symptoms**

- 1 Fluid leaks under the vehicle  
(Water dripping from the air conditioning after use is normal.)
- 1 Flat-looking tires or uneven tire wear
- 1 Engine coolant temperature gauge needle continually points higher than normal
- 1 Engine oil pressure gauge continually points lower than normal
- 1 Voltmeter continually points higher or lower than normal

### **n Audible symptoms**

- 1 Changes in exhaust sound
- 1 Excessive tire squeal when cornering
- 1 Strange noises related to the suspension system
- 1 Pinging or other noises related to the engine

### **n Operational symptoms**

- 1 Engine missing, stumbling or running rough
- 1 Appreciable loss of power
- 1 Vehicle pulls heavily to one side when braking
- 1 Vehicle pulls heavily to one side when driving on a level road
- 1 Loss of brake effectiveness, spongy feeling, pedal almost touches the floor

## 5-1. Essential information

### Fuel pump shut off system

**To minimize the risk of fuel leakage when the engine stalls or an air-bag inflates upon collision, the fuel pump shut off system stops supplying fuel to the engine.**

Follow the procedure below to restart the engine after the system is activated.

**STEP 1** Switch to ACCESSORY mode or OFF.

**STEP 2** Restart the engine.

#### NOTICE

##### **n Before starting the engine**

Inspect the ground under the vehicle.

If you find that fuel has leaked on to the ground, the fuel system has been damaged and is in need of repair. Do not restart the engine.



## 5-1. Essential information Event data recorder

**Your vehicle has computers that monitor and control certain aspects of your vehicle. These computers assist in driving and maintaining optimal vehicle performance.**

**Besides storing data useful for troubleshooting, there is a system to record data in a crash or a near car crash event. This is called an Event Data Recorder (EDR).**

### **In a crash or a near car crash event**

The SRS airbag sensor assembly contains the EDR. In a crash or a near car crash event, this device may record some or all of the following information:

- 1 Engine speed
- 1 Whether the brake pedal was applied or not
- 1 Vehicle speed
- 1 To what extent the accelerator pedal was depressed
- 1 Position of the transmission shift lever
- 1 Whether the driver and front passenger wore seat belts or not
- 1 Driver's seat position
- 1 Front passenger's occupant classification
- 1 SRS airbag deployment data
- 1 SRS airbag system diagnostic data

The information above is intended to be used for the purpose of improving vehicle safety performance. Unlike general data recorders, the EDR does not record sound data such as conversation between passengers.

### **Disclosure of the data**

Toyota will not disclose the data recorded in an EDR to a third party except when:

- 1 An agreement from the vehicle's owner (or the leasing company for a leased vehicle) is obtained
- 1 Officially requested by the police or other authorities
- 1 Used as a defense for Toyota in a law suit
- 1 Ordered by a court

However, if necessary Toyota will:

- 1 Use the data for research on Toyota vehicle safety performance
- 1 Disclose the data to a third party for research purposes without disclosing details of the vehicle owner, and only when it is deemed necessary
- 1 Disclose summarized data cleared of vehicle identification information to a non-Toyota organization for research purposes

## 5-2. Steps to take in an emergency

### If a warning light turns on or a warning sounds...

**Calmly perform the following actions if any of the warning lights turn on or flash. If a light turns on or flashes, but then turns off, this does not necessarily indicate a malfunction in the system.**

**Stop the vehicle immediately. Continuing to drive the vehicle may be dangerous.**

The following warning indicates a possible problem in the brake system. Immediately stop the vehicle in a safe place and contact your Toyota dealer.

Warning light	Warning light/Details
	<b>Brake system warning light (warning buzzer)*</b> <ul style="list-style-type: none"><li>• Low brake fluid</li><li>• Malfunction in the brake system</li></ul> This light also comes on when the parking brake is not released. If the light turns off after the parking brake is fully released, the system is operating normally.

\*: Parking brake engaged warning buzzer:

A buzzer will sound if the vehicle is driven at a speed of approximately 3 mph (5 km/h) or more.

## 5-2. Steps to take in an emergency



### Stop the vehicle immediately.



The following warning indicates the possibility of damage to the vehicle that may lead to an accident. Immediately stop the vehicle in a safe place and contact your Toyota dealer.

Warning light	Warning light/Details
	<p><b>Charging system warning light</b> Indicates a malfunction in the vehicle's charging system.</p>

### Have the vehicle inspected by your Toyota dealer immediately.

Failing to investigate the cause of the following warnings may lead to the system operating abnormally and possibly cause an accident. Have the vehicle inspected by your Toyota dealer immediately.

Warning light	Warning light/Details
	<p><b>Malfunction indicator lamp</b> Malfunction in:</p> <ul style="list-style-type: none"> <li>• The emission control system;</li> <li>• The electronic engine control system;</li> <li>• The electronic throttle control system; or</li> <li>• The electronic automatic transmission control system.</li> </ul>
	<p><b>SRS warning light</b> Malfunction in:</p> <ul style="list-style-type: none"> <li>• The SRS airbag system;</li> <li>• The front passenger occupant classification system; or</li> <li>• The seat belt pretensioner system.</li> </ul>





Warning light	Warning light/Details
	<b>ABS warning light</b> Malfunction in: <ul style="list-style-type: none"> <li>• The ABS; or</li> <li>• The brake assist system.</li> </ul>
	<b>Pre-collision system warning light (if equipped)</b> Malfunction in the pre-collision system.



**Have the malfunction repaired immediately.**

After taking the specified steps to correct the suspected problem, check that the warning light turns off.

Warning light	Warning light/Details	Correction procedure
	<b>Open door warning light (warning buzzer)*1</b> A door is not fully closed.	Check that all doors are closed.

5-2. Steps to take in an emergency

Warning light	Warning light/Details	Correction procedure
	<b>Driver's seat belt reminder light (warning buzzer)*2</b> Warns the driver to fasten his/her seat belt.	Fasten the seat belt.
 (On the center cluster)	<b>Front passenger's seat belt reminder light (warning buzzer)*2</b> Warns the front passenger to fasten his/her seat belt.	Fasten the seat belt.
	<b>Tire pressure warning light</b>	
	When the light comes on: Low tire inflation pressure.	Adjust the tire inflation pressure.
	When the light comes on after blinking for 1 minute: Malfunction in the tire pressure warning system.	Have the system checked by your Toyota dealer.
	<b>Unengaged "Park" warning light</b> The transmission "Park" mechanism is not engaged.	Shift four-wheel drive control out of "N". ( P. 190)

Warning light	Warning light/Details	Correction procedure
	<p><b>Low fuel level warning light</b> Indicates that remaining fuel is about 4.0 gal. (15.0 L, 3.3 Imp. gal.) or less</p>	Refuel the vehicle.
	<p><b>Master warning light</b> A buzzer sounds and the warning light comes on and flashes to indicate that the master warning system has detected a malfunction.</p>	Take appropriate action in accordance with the message displayed on the multi-information display.

**\*1: Open door warning buzzer:**

The open door warning buzzer sounds to alert one or more of the doors is not fully closed (with the vehicle having reached a speed of 3 mph [5 km/h]).

**\*2: Driver's and front passenger's seat belt reminder buzzer:**

The driver's and front passenger's seat belts reminder sounds to alert the driver and front passenger that his/her seat belt is not fastened. The buzzer sounds intermittently for 10 seconds after the vehicle had reached a speed of at least 12 mph (20 km/h). Then, if the seat belt is still unfastened, the buzzer will sound in a different tone for 20 more seconds.

---

n **If the malfunction indicator lamp comes on while driving**

The malfunction indicator lamp will come on if the fuel tank becomes completely empty. If the fuel tank is empty, refuel the vehicle immediately. The malfunction indicator lamp will go off after several trips.

If the malfunction indicator lamp does not go off, contact your Toyota dealer as soon as possible.

n **Front passenger detection sensor and passenger seat belt reminder**

l If luggage is placed on the front passenger seat, the front passenger detection sensor may cause the warning light to flash, even if a passenger is not sitting in the seat.

l If a cushion is placed on the seat, the sensor may not detect a passenger, and the warning light may not operate properly.

n **SRS warning light**

This warning light system monitors the following:

l The airbag sensor assembly

l Front airbag sensors

l The curtain shield airbag sensors

l The side and curtain shield airbag sensors

l The seat belt buckle switches

l The driver's seat position sensor

l The inflators

l The interconnecting wiring and power sources

l The front passenger occupant classification ECU

l "AIR BAG ON" and "AIR BAG OFF" indicator lights

l The seatbelt pretensioners

l The roll sensing of curtain shield airbags off indicator light

n **Changing the engine oil**

l Make sure to reset oil change system



■ **When the tire pressure warning light comes on**

Check the tire inflation pressure and adjust to the appropriate level. Pushing the tire pressure warning reset switch does not turn off the tire pressure warning light.

■ **The tire pressure warning light may come on due to natural causes**

The tire pressure warning light may come on due to natural causes such as natural air leaks or tire inflation pressure changes caused by temperature. In this case, adjusting the tire inflation pressure will turn off the warning light (after a few minutes).

■ **When a tire is replaced with a spare tire**

The spare tire is also equipped with the tire pressure warning valve and transmitter. The tire pressure warning light will turn on if the tire inflation pressure of the spare tire is low. If a tire goes flat, even though the flat tire is replaced with the spare tire, the tire pressure warning light does not turn off. Replace the spare tire with the repaired tire and adjust the proper tire inflation pressure. The tire pressure warning light will turn off after a few minutes.

## 5-2. Steps to take in an emergency

### **n If the tire pressure warning system is inoperative**

The tire pressure warning system will become inoperative in the following conditions:

(When the condition becomes normal, the system will work properly.)

- 1 If tires not equipped with tire pressure warning valves and transmitters are used.
- 1 If the ID code on the tire pressure warning valves and transmitters is not registered in the tire pressure warning computer.
- 1 If the tire inflation pressure is more than 73 psi (500 kPa, 5.1 kgf/cm<sup>2</sup> or bar).

The tire pressure warning system may become inoperative in the following conditions:

(When the condition becomes normal, the system will work properly.)

- 1 If electronic devices or facilities using similar radio wave frequencies are nearby.
- 1 If a radio set at similar frequencies is in use in the vehicle.
- 1 If a window tint that affects the radio wave signals is installed.
- 1 If there is a lot of snow or ice on the vehicle, in particular around the wheels or wheel housings.
- 1 If non-genuine Toyota wheels are used. (Even if you use Toyota wheels, the tire pressure warning system may not work properly with some types of tires.)
- 1 If tire chains are used.
- 1 If the spare tire is in a location subject to poor radio wave signal reception.
- 1 If a large metallic object which can interfere with signal reception is put in the luggage compartment.

### **n If the tire pressure warning light comes on after blinking for 1 minute frequently**

If the tire pressure warning light comes on after blinking 1 minute frequently when the "ENGINE START STOP" switch is turned to IGNITION ON mode, have it checked by Toyota dealer.

 CAUTION

**n If the tire pressure warning light comes on**

Be sure to observe the following precautions. Failure to do so could cause loss of vehicle control and result in death or serious injury.

- i** Stop your vehicle in a safe place as soon as possible. Adjust the tire inflation pressure immediately.
- i** If the tire pressure warning light comes on even after tire inflation pressure adjustment, it is probable that you have a flat tire. Check the tires. If the tire is flat, change to the spare tire and have the flat tire repaired by the nearest Toyota dealer.
- i** Avoid abrupt maneuvering and braking. If the vehicle tires deteriorate, you could lose control of the steering wheel or the brakes.

**n If a blowout or sudden air loss should occur**

The tire pressure warning system may not activate immediately.

 CAUTION

**n Maintenance of the tires**

Each tire, including the spare (if provided), should be checked monthly when cold and inflated to the inflation pressure recommended by the vehicle manufacturer on the vehicle placard or tire inflation pressure label (tire and load information label). (If your vehicle has tires of a different size than the size indicated on the vehicle placard or tire inflation pressure label [tire and load information label], you should determine the proper tire inflation pressure for those tires.)

As an added safety feature, your vehicle has been equipped with a tire pressure monitoring system (TPMS—tire pressure warning system) that illuminates a low tire pressure telltale (tire pressure warning light) when one or more of your tires is significantly under-inflated. Accordingly, when the low tire pressure telltale (tire pressure warning light) illuminates, you should stop and check your tires as soon as possible, and inflate them to the proper pressure. Driving on a significantly under-inflated tire causes the tire to overheat and can lead to tire failure. Under-inflation also reduces fuel efficiency and tire tread life, and may affect the vehicle's handling and stopping ability.

Please note that the TPMS (tire pressure warning system) is not a substitute for proper tire maintenance, and it is the driver's responsibility to maintain correct tire pressure, even if under-inflation has not reached the level to trigger illumination of the TPMS low tire pressure telltale (tire pressure warning light).

 CAUTION

Your vehicle has also been equipped with a TPMS (tire pressure warning system) malfunction indicator to indicate when the system is not operating properly. The TPMS (tire pressure warning system) malfunction indicator is combined with the low tire pressure telltale (tire pressure warning light). When the system detects a malfunction, the telltale will flash for approximately one minute and then remain continuously illuminated. This sequence will continue upon subsequent vehicle start-ups as long as the malfunction exists. When the malfunction indicator is illuminated, the system may not be able to detect or signal low tire pressure as intended.

TPMS (tire pressure warning system) malfunctions may occur for a variety of reasons, including the installation of replacement or alternate tires or wheels on the vehicle that prevent the TPMS (tire pressure warning system) from functioning properly. Always check the TPMS (tire pressure warning system) malfunction telltale after replacing one or more tires or wheels on your vehicle to ensure that the replacement or alternate tires and wheels allow the TPMS (tire pressure warning system) to continue to function properly.

 NOTICE**n Precaution when installing a different tire**

When a tire of a different specification or maker is installed, the tire pressure warning system may not operate properly.

## 5-2. Steps to take in an emergency

### If a warning message is displayed

The multi-information display shows warnings of system malfunctions, incorrectly performed operations, or shows messages that indicate a need for maintenance. When a message is shown, perform the correction procedure appropriate to the message.

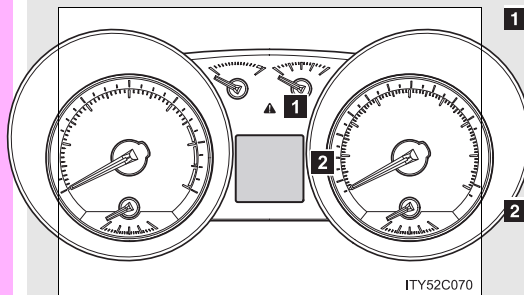

#### 1 Master warning light

The master warning light comes on or flashes when a message is being shown on the multi-information display.

#### 2 Multi-information display

If any of the warning messages is shown again after its correction procedure has been performed, contact your Toyota dealer.

### Messages and warnings

The warning lights and warning buzzers operate as follows depending on the content of the message. If a message indicates the need for inspection by a dealer, have the vehicle inspected immediately by your Toyota dealer.

	System warning light	Warning buzzer*	Warning
Comes on		Sounds	Indicates an important situation, such as when a system related to driving is malfunctioning or that danger may result if the correction procedure is not performed.
	Comes on or flashes	Sounds	Indicates an important situation, such as when the system shown on the multi-information display may be malfunctioning.
Comes on		Does not sound	Indicates a condition, such as malfunction of electrical components, their condition, or indicates the need for maintenance.
Flashes		Does not sound	Indicates a situation, such as when an operation has been performed incorrectly, or indicates how to perform an operation correctly.

\*: A buzzer sounds first time a message is shown on the multi-information display.

---

**n Resetting the tire pressure warning data**

After adjusting the tire inflation pressure, be sure to initialize the data.  
( P. 393)

If the message remains on, the system may have malfunctioned. Have the vehicle inspected by your Toyota dealer as soon as possible.

**n Warning messages in the cruise control mode**

In the following instances, there is a possibility that the approach warning will not illuminate even when vehicle-to-vehicle distance is closing.

- l When the speed of the vehicle ahead matches or exceeds your vehicle's speed.
- l When the vehicle ahead is traveling at an extremely slow speed.
- l Immediately after the cruise control speed has been set.
- l At the instant the accelerator is applied.

 **NOTICE**

**n Engine oil maintenance message**

The warning message is based on the projected driving range after engine oil maintenance message is reset.

The system does not monitor the purity of the engine oil.



5-2. Steps to take in an emergency  
If you have a flat tire

**Remove the flat tire and replace it with the spare provided.**

**n Before jacking up the vehicle**

- 1 Stop the vehicle on a hard, flat surface.
- 1 Set the parking brake.
- 1 Shift the shift lever to "P".
- 1 Stop the engine.
- 1 Turn on the emergency flashers.

**n Location of the spare tire, jack and tools**

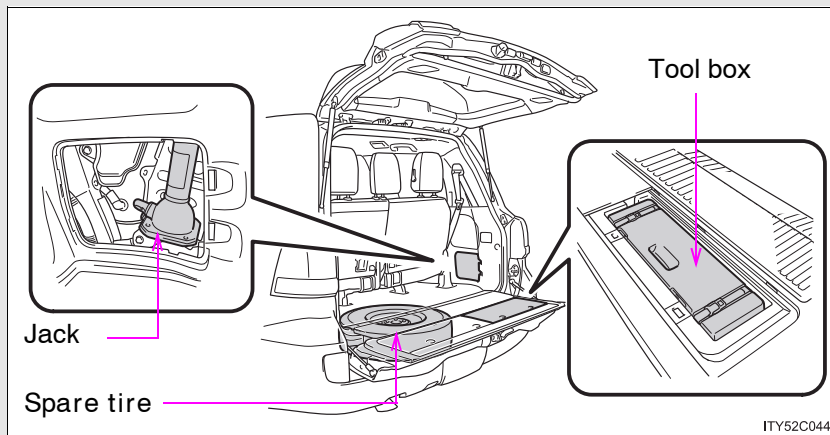

5-2. Steps to take in an emergency

**Taking out the jack**

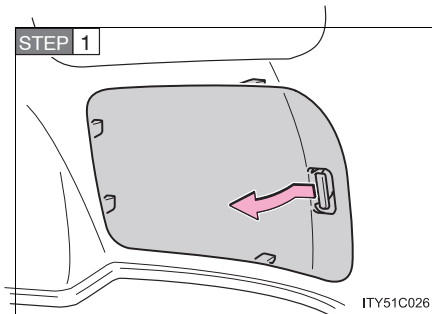

Remove the cover.

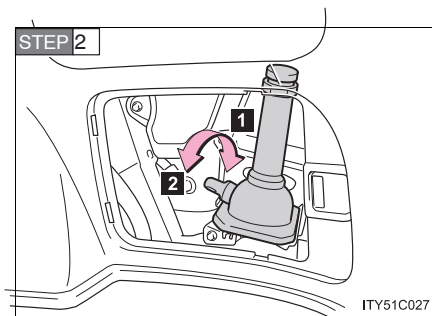

**1** Loosen

**2** Tighten

Loosen and remove the jack.

**Taking out the tool box**

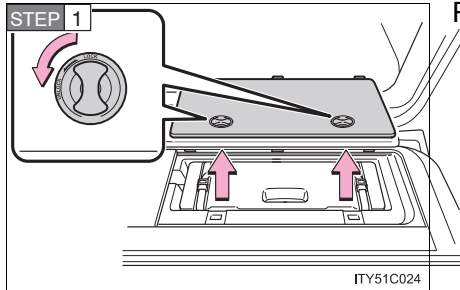

Remove the cover.

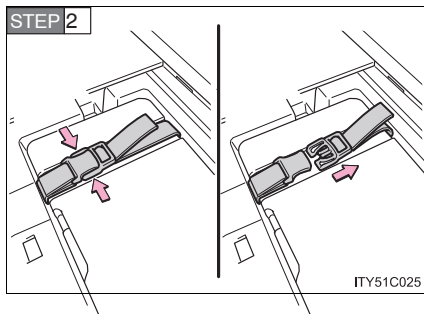

Take out the tool box.

**Assemble the jack handle (in the tool box)**

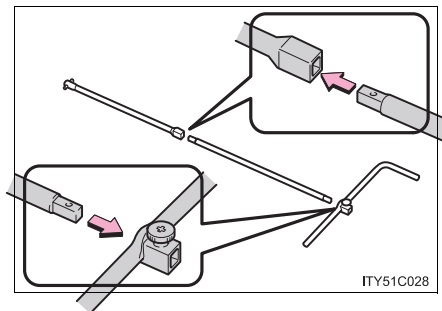

Assemble the jack handle extension as shown. Be sure to tighten each bolt securely.

5-2. Steps to take in an emergency

**Taking out the spare tire**

STEP 1

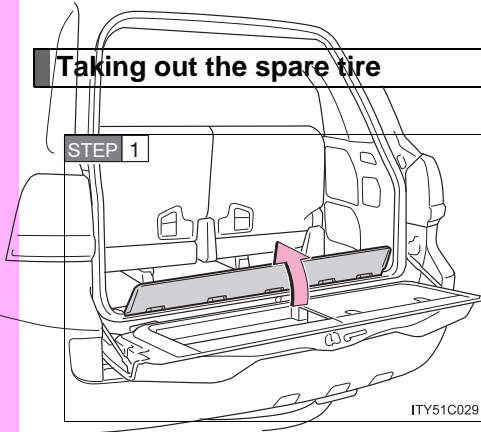

Remove the cover.

STEP 2

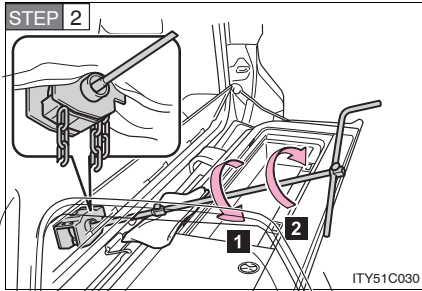

Insert the jack handle extension into the lowering screw.

**1** Lower

**2** Raise

STEP 3

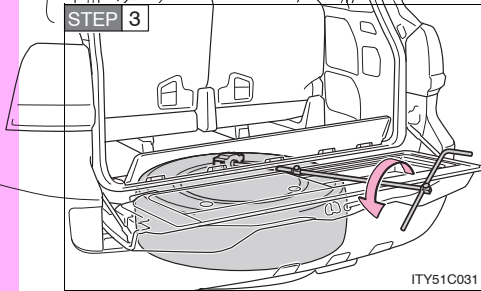

Lower the spare tire completely to the ground.

5-2. Steps to take in an emergency

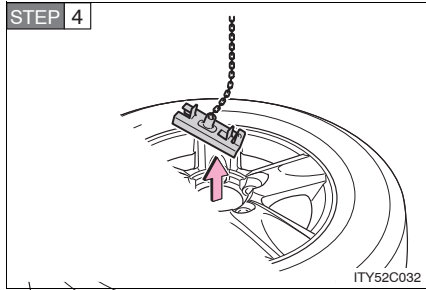

Pull out the spare tire and remove the holding bracket.

5-2. Steps to take in an emergency

**Replacing a flat tire**

**STEP 1**

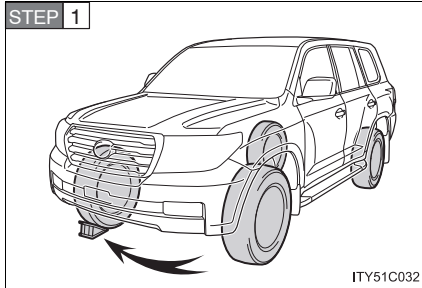

Chock the tires.

Flat tire		Wheel chock position
Front	Left-hand side	Behind the rear right-hand side tire
	Right-hand side	Behind the rear left-hand side tire
Rear	Left-hand side	In front of the front right-hand side tire
	Right-hand side	In front of the front left-hand side tire

**STEP 2**

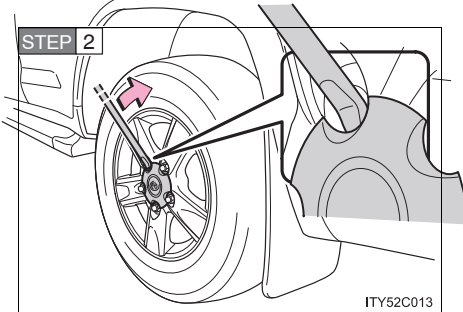

Pry off the wheel ornament, using the beveled end of the wheel ornament remover as shown.

5-2. Steps to take in an emergency

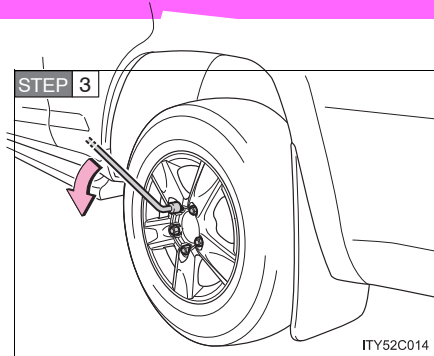

ightly loosen the wheel nuts  
(one turn).

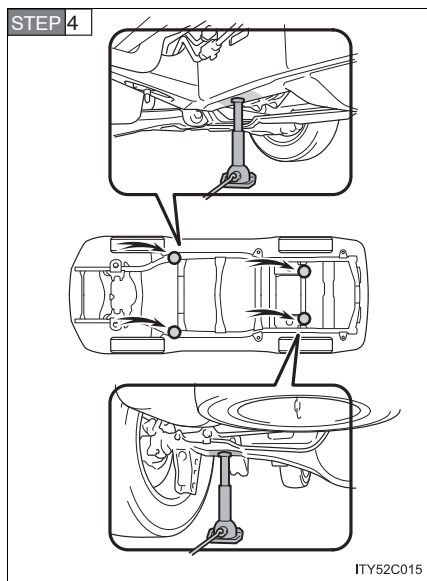

Position the jack at the jack  
points as shown.

Front – Under the chassis frame  
side rail

Rear – Under the rear axle hous-  
ing

5-2. Steps to take in an emergency

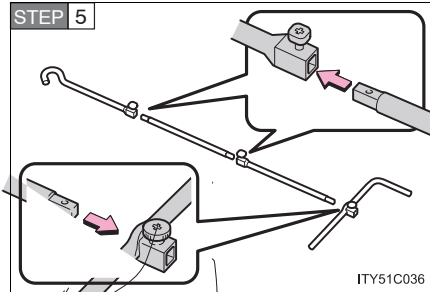

Assemble the jack handle extension as shown. Be sure to tighten each bolt securely.

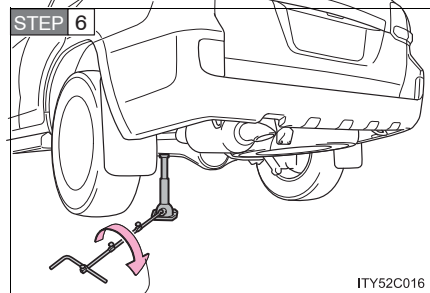

Raise the vehicle until the tire is slightly raised off the ground.

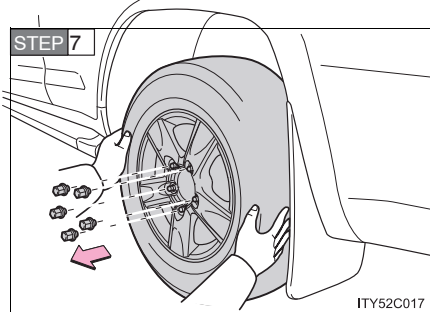

Remove all the wheel nuts and the tire.

When resting the tire on the ground, place the tire so that the wheel design faces up to avoid scratching the wheel surface.



### Installing the spare tire

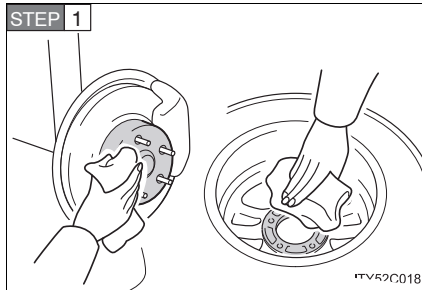

Remove any dirt or foreign matter from the wheel contact surface.

If foreign matter is on the wheel contact surface, the wheel nuts may loosen while the vehicle is in motion, and the tire may come off the vehicle.

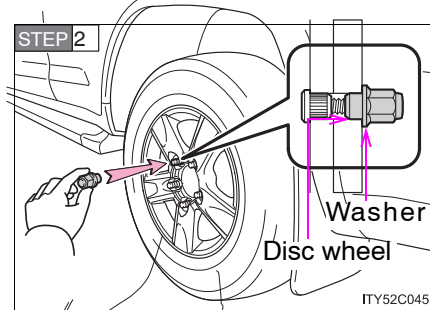

Install the spare tire and loosely tighten each nut by hand to approximately the same amount.

Turn the nut washers until they come into contact with the disc wheel.

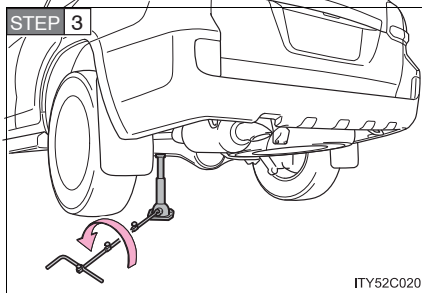

Lower the vehicle.

## 5-2. Steps to take in an emergency

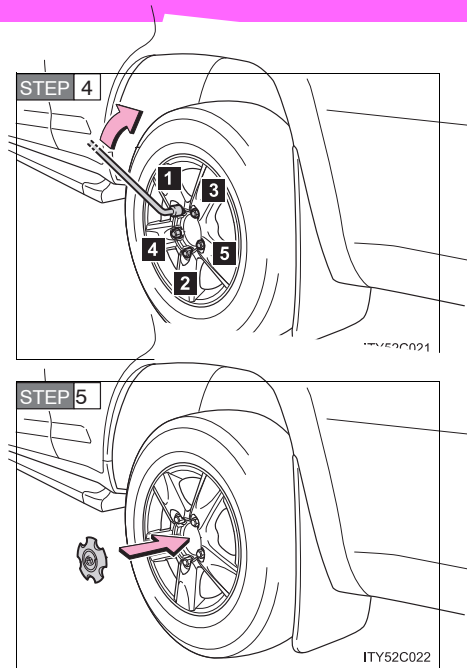

firmly tighten each nut two or three times in the order shown in the illustration.

**Tightening torque:**  
97 ft•lbf (131 N•m, 13.4 kgf•m)

Reinstall the wheel ornament.

### Stowing the flat/spare tire, jack and tools

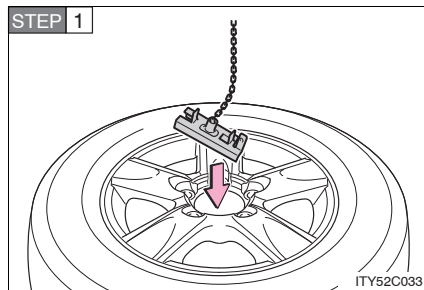

Lay down the tire with the outer side facing up, and install the holding bracket.

**STEP 2** Raise the tire.

Pull the tire towards the rear of the vehicle when raising. After raising, visually check that tire is not interfering with components.

**STEP 3** Stow the tools and jack securely, and replace all covers.

**n After completing the tire change**

The tire pressure warning system must be reset. ( P. 393)

**⚠ CAUTION**

**n Using the tire jack**

Improper use of the tire jack may lead to death or injuries due to the vehicle suddenly falling off the jack.

**I** Do not use the tire jack for any purpose other than replacing tires or installing and removing tire chains.

**I** Only use the tire jack that comes with this vehicle for replacing a flat tire.

Do not use it on other vehicles, and do not use other tire jacks for replacing tires on this vehicle.

**I** Always check that the tire jack is securely set to the jack point.

**I** Do not raise the vehicle while someone is in it.

**I** When raising the vehicle, do not put an object on or under the jack.

**I** Do not raise the vehicle to a height greater than that required to replace the tire.

**I** Use a jack stand if it is necessary to get under the vehicle.

**I** Do not put any part of your body under the vehicle supported by a jack.

**I** Do not start or run the engine while your vehicle is supported by the jack.

Take particular care when lowering the vehicle to ensure that no one working on or near the vehicle may be injured.

**n Using the jack handle**

Tighten all the jack handle bolts securely using a Phillips-head screwdriver, to prevent the extension parts from coming apart unexpectedly.

 CAUTION

**n Replacing a flat tire**

Observe the following precautions to reduce the risk of injury.

- I Lower the spare tire completely to the ground before removing it from under the vehicle.
- I Do not try to remove the wheel ornament by hand. Take due care in handling the ornament to avoid unexpected personal injury.
- I Never use oil or grease on the wheel bolts or wheel nuts.  
The oil or grease can cause the wheel nuts to loosen, causing a serious accident. Remove any oil or grease on the wheel bolts or wheel nuts.
- I Have the wheel nuts tightened with a torque wrench to 97 ft•lbf (131 N•m, 13.4 kgf•m) as soon as possible after changing wheels.  
Failure to follow these precautions could cause the nuts to loosen and the wheels may fall off, which could lead to an accident causing death or serious injury.
- I Do not attach a heavily damaged wheel ornament, as it may fly off the wheel while the vehicle is moving.

 NOTICE

**n Do not drive the vehicle with a flat tire**

Do not continue driving with a flat tire.  
Driving even a short distance with a flat tire can damage the tire and the wheel beyond repair.

**n When stowing the flat tire**

Ensure that there is no object caught between the tire and the vehicle underbody.

**n When replacing the tires**

**I** When removing or fitting the wheels, tires or the tire pressure warning valve and transmitter, contact your Toyota dealer as the tire pressure warning valve and transmitter may be damaged if not handled correctly.

**I** Replace the grommets for the tire pressure warning valves and transmitters as well.

**n To avoid damaging the tire pressure warning valves and transmitters**

Do not use liquid sealants on flat tires.

## 5-2. Steps to take in an emergency

### If the engine will not start

**If the engine still does not start after following the correct starting procedure ( P. 149) or releasing the steering lock ( P. 151), confirm the following points.**

**n The engine will not start when the starter motor operates normally.**

One of the following may be the cause of the problem.

- 1 There may not be sufficient fuel in the vehicle's tank.  
Refuel the vehicle.
- 1 The engine may be flooded.  
Try to restart the engine once more following correct starting procedures. ( P. 150)
- 1 There may be a malfunction in the engine immobilizer system.  
( P. 93)

**n The starter motor turn over slowly, the interior lights and headlights are dim, or the horn does not sound or sounds at a low volume.**

One of the following may be the cause of the problem.

- 1 The battery may be discharged. ( P. 484)
- 1 The battery terminal connections may be loose or corroded.

**n The starter motor does not turn over.**

The engine starting system may be malfunctioning due to an electrical problem such as an open circuit or a blown fuse. However, an interim measure is available to start the engine.

( P. 477)

**n The starter motor does not turn over, the interior lights and headlights do not turn on, or the horn does not sound.**

One of the following may be the cause of the problem.

- 1 One or both of the battery terminals may be disconnected.
- 1 The battery may be discharged. ( P. 484)
- 1 There may be a malfunction in the steering lock system.

Contact your Toyota dealer if the problem cannot be repaired, or if repair procedures are unknown.

### Emergency start function

When the engine does not start, the following steps can be used as an interim measure to start the engine if the “ENGINE START STOP” switch is functioning normally.

**STEP 1** Set the parking brake.

**STEP 2** Put the shift lever in “P”.

**STEP 3** Set the “ENGINE START STOP” switch to ACCESSORY mode.

**STEP 4** Press and hold the “ENGINE START STOP” switch about 15 seconds while depressing the brake pedal firmly.

Even if the engine can be started using the above steps, the system may be malfunctioning. Have the vehicle checked by your Toyota dealer.

## 5-2. Steps to take in an emergency

### If the shift lever cannot be shifted from P

If the shift lever cannot be shifted with your foot on the brake, there may be a problem with the shift lock system (a system to prevent accidental operation of the shift lever). Have the vehicle inspected by your Toyota dealer immediately.

The following steps may be used as an emergency measure to ensure that the shift lever can be shifted.

**STEP 1** Set the parking brake.

**STEP 2** Set the “ENGINE START STOP” switch to the ACCESSORY mode.

**STEP 3** Depress the brake pedal.

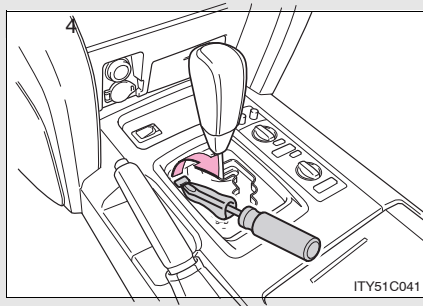

Pry the cover up with a flat-head screwdriver or equivalent.

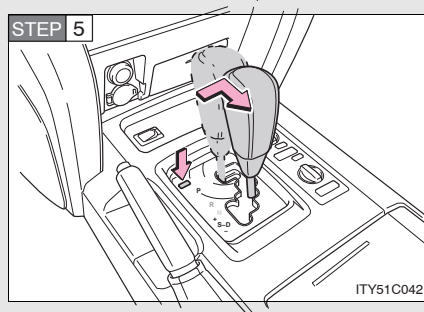

Press the shift lock override button.

The shift lever can be shifted while the button is pressed.



5-2. Steps to take in an emergency  
If you lose your keys

**New genuine Toyota keys can be made by your Toyota dealer using one of the other keys and the key number stamped on your key number plate.**

## 5-2. Steps to take in an emergency

### If you cannot operate back door opener

If the back door opener does not operate, there may be a problem with the back door opener system. Have the vehicle inspected by your Toyota dealer immediately.

The following steps may be used as an emergency measure to ensure that the back door can be opened from the inside.

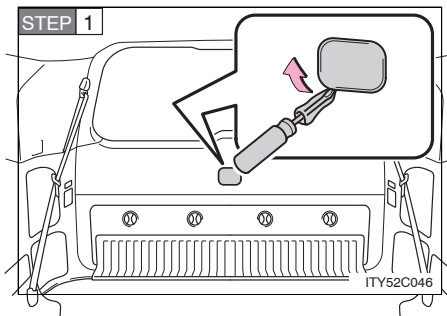

Remove the cover on the back door trim.

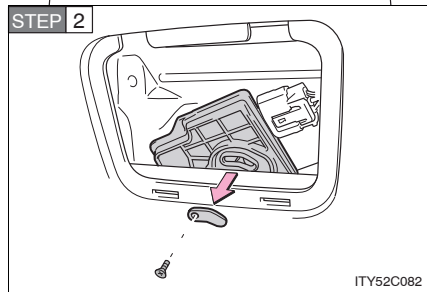

Remove the screw and cover.

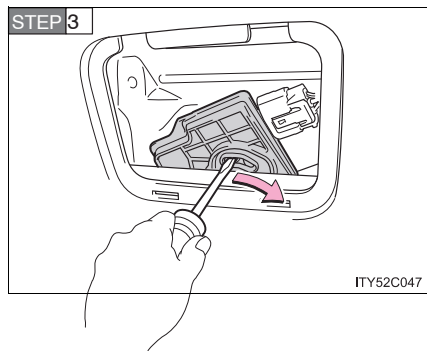

Push the lever with the back door motor, open the back door.

## 5-2. Steps to take in an emergency

If the electronic key does not operate properly

If communication between the electronic key and vehicle is interrupted ( P. 26) or the electronic key cannot be used because the battery is depleted, the smart key system and wireless remote control cannot be used. In such cases, the doors can be opened or the engine can be started by following the procedure below.

### Locking and unlocking the doors and key linked functions

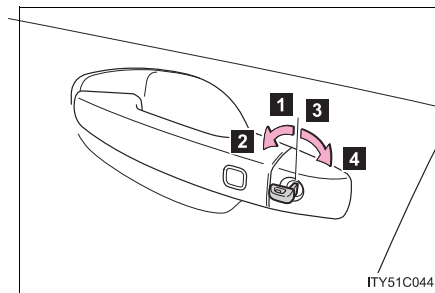

- 1 Locks all doors
- 2 Closes the windows/moon roof (turn and hold)
- 3 Unlocks all doors  
Turning the key rearward unlocks the driver's door.  
Turning the key once again unlocks the other doors.
- 4 Opens the windows/moon roof (turn and hold)

5

When trouble arises

### Changing “ENGINE START STOP” switch modes and starting the engine

**STEP 1** Shift the shift lever to “P” and apply the brakes.

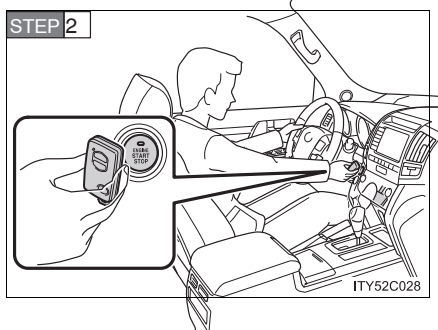

Touch the Toyota emblem side of the electronic key to the “ENGINE START STOP” switch.

An alarm will sound to indicate that the start function cannot detect the electronic key that is touched to the “ENGINE START STOP” switch if any of the doors is opened while the key is touched to the switch.

**STEP 3** To change “ENGINE START STOP” switch modes: Within 10 seconds of the buzzer sounding, release the brake pedal and press the “ENGINE START STOP” switch. Modes can be changed each time the switch is pressed. ( P. 149)  
To start the engine: Press the “ENGINE START STOP” switch within 10 seconds after the buzzer sounds, keeping the brake pedal depressed.

If the “ENGINE START STOP” switch cannot be operated, contact your Toyota dealer.

---

■ **Stopping the engine**

Shift the shift lever to “P” and press the “ENGINE START STOP” switch as you normally do when stopping the engine.

■ **Replacing the key battery**

As this procedure is a temporary measure, it is recommended that the electronic battery be replaced immediately when the battery depletes. ( P. 410)

■ **Alarm**

Using the mechanical key to lock the doors will not set the alarm system. If a door is unlocked using the mechanical key when the alarm system is set, the alarm may be triggered. ( P. 97)

## 5-2. Steps to take in an emergency If the battery is discharged

The following procedures may be used to start the engine if the battery is discharged.

You can call your Toyota dealer, Roadside Assistance or Toyota Customer Service.

If you have a set of jumper (or booster) cables and a second vehicle with a 12 volt battery, you can jump start your Toyota following the steps below.

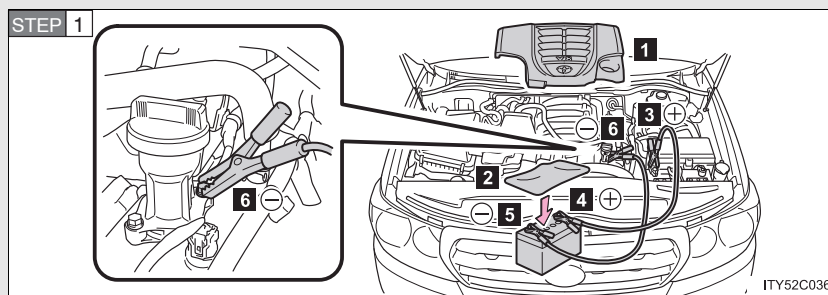

Connecting the jumper cables.

- 1** Remove the engine cover.
- 2** If required, remove all vent plugs from the booster battery. Lay a cloth over the open vents on the booster battery. (This helps reduce the explosion hazard, personal injuries and burns.)
- 3** Positive (+) battery terminal on your vehicle.
- 4** Positive (+) battery terminal on the second vehicle.
- 5** Negative (-) battery terminal on the second vehicle.
- 6** Connect the jumper cable to ground on your vehicles as shown in the illustration.

**STEP 2** Start the engine of the second vehicle. Increase the engine speed slightly and maintain at that level for approximately 5 minutes to recharge the battery of your vehicle.

**STEP 3** Open and close any of the doors with the “ENGINE START STOP” switch off.

**STEP 4** Maintain the engine speed of the second vehicle and start your vehicle’s engine.

**STEP 5** Once the vehicle’s engine has started, remove the jumper cables in the exact reverse order in which they were connected.

Once the engine starts, have the vehicle checked at your Toyota dealer as soon as possible.

---

n **Avoiding a discharged battery**

- l Turn off the headlights and the audio system while the engine is turned off.
- l Turn off any unnecessary electrical components when the vehicle is running at a low speed for an extended period, such as in heavy traffic, etc.

 **CAUTION**

**n Avoiding battery fires or explosions**

Observe the following precautions to prevent accidentally igniting the flammable gas that may be emitted from the battery.

- I** Make sure the jumper cable is connected to the correct terminal and that it is not unintentionally in contact with any part other than the intended terminal.
- I** Do not allow the jumper cables to come into contact with the “+” and “-” terminals.
- I** Do not allow open flame or use matches, cigarette lighters or smoke near the battery.

**n Battery precautions**

The battery contains poisonous and corrosive acidic electrolyte, while related parts contain lead and lead compounds. Observe the following precautions when handling the battery:

- I** When working with the battery, always wear safety glasses and take care not to allow any battery fluids (acid) to come into contact with skin, clothing or the vehicle body.
- I** Do not lean over the battery.
- I** If the battery fluid comes into contact with the skin or eyes, immediately wash the affected area with water and seek medical attention. Place a wet sponge or cloth over the affected area until medical attention can be received.
- I** Always wash your hands after handling the battery support, terminals, and other battery-related parts.
- I** Do not allow children near the battery.



 NOTICE

**n To prevent damaging the vehicle**

Do not pull- or push-start the vehicle, because the three-way catalytic converter may overheat and become a fire hazard.

**n When handling jumper cables**

Be careful that the jumper cables do not become tangled in the cooling fan or any of the belts when connecting or disconnecting them.

## 5-2. Steps to take in an emergency If your vehicle overheats

### If your engine overheats

**STEP 1** Stop the vehicle in a safe place and turn off the air conditioning system.

**STEP 2** Check to see if steam is coming out from under the hood.

If you see steam:

Stop the engine and carefully lift the hood.

If you do not see steam:

Leave the engine running and carefully lift the hood.

**STEP 3** Remove the engine compartment cover. ( P. 376)

**STEP 4** Check to see if the cooling fan is operating.

If the fan is operating:

Wait until the engine coolant temperature gauge begins to fall and then stop the engine.

If the fan is not operating:

Stop the engine immediately and call your local Toyota dealer.

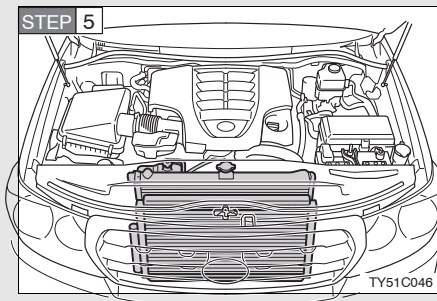

After the engine has cooled down sufficiently, check the coolant level and inspect the radiator core (radiator) for any leaks.

STEP 6

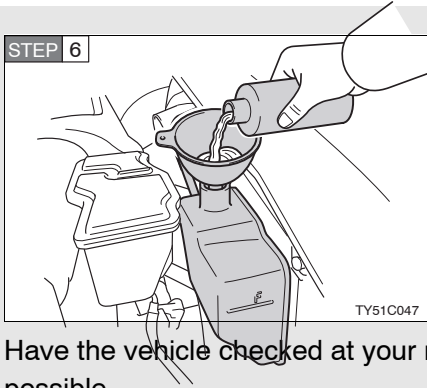

Add coolant if required.

Water can be used in an emergency measure if coolant is unavailable. ( P. 498)

Have the vehicle checked at your nearest Toyota dealer as soon as possible.

#### n Overheating

In the following situations, your vehicle may be overheating.

- l The engine coolant temperature gauge enters the red zone or a loss of power is experienced.
- l Steam is coming from under the hood.

#### ⚠ CAUTION

##### n To prevent an accident or injury when inspecting under the hood of your vehicle

- l Keep hands and clothing away from the fan and engine drive belt while the engine is running.
- l Do not loosen the radiator cap while the engine and radiator are hot. Serious injury, such as burns, may result from hot coolant and steam released under pressure.

5

When trouble arises

 NOTICE

**n When adding engine coolant**

Wait until the engine has cooled down before adding engine coolant. When adding coolant, do so slowly. Adding cool coolant to a hot engine too quickly can cause damage to the engine.

## 5-2. Steps to take in an emergency If the vehicle becomes stuck

**Carry out the following procedures if the tires spin or the vehicle becomes stuck in mud, dirt, or snow.**

- STEP 1** Stop the engine. Set the parking brake and shift the shift lever in "P".
- STEP 2** Remove the mud, snow or sand from around the stuck tire.
- STEP 3** Place wood, stones or some other material to help provide traction under the tires.
- STEP 4** Restart the engine.
- STEP 5** Turn off VSC. ( P. 203)
- STEP 6** Shift the shift lever to "D" or "R" position and carefully apply the accelerator to free the vehicle.

### CAUTION

#### **n When attempting to free a stuck vehicle**

If you choose to rock the vehicle back and forth to free it, make sure the surrounding area is clear, to avoid striking other vehicles, objects or persons. The vehicle may also lunge forward or lunge back suddenly as it becomes free. Use extreme caution.

#### **n When shifting the shift lever**

Be careful not to shift the shift lever with the accelerator pedal depressed. This may lead to unexpected rapid acceleration of the vehicle that may cause an accident and result in death or serious injury.

### NOTICE

#### **n To avoid damaging the transmission and other components**

- I** Avoid spinning the wheels and do not rev the engine.
- I** If the vehicle remains stuck after trying these procedures, the vehicle may require towing to be freed.

## 5-2. Steps to take in an emergency

6-1. Specifications

Maintenance data (fuel, oil level, etc.)

**Dimensions and weight**

Overall length	194.9 in. (4950 mm)	
Overall width	77.6 in. (1970 mm)	
Overall height *	74.0 in. (1880 mm)	
Wheelbase	112.2 in. (2850 mm)	
Tread	Front	64.6 in. (1640 mm)
	Rear	64.4 in. (1635 mm)
Vehicle capacity weight (Occupants + luggage)	1235 lb. (560 kg)	
Towing capacity (trailer weight + cargo weight)	8500 lb. (3856 kg)	

\*: Unladen vehicle

## Vehicle identification

### n Vehicle identification number

The vehicle identification number (VIN) is the legal identifier for your vehicle. This is the primary identification number for your Toyota. It is used in registering the ownership of your vehicle.

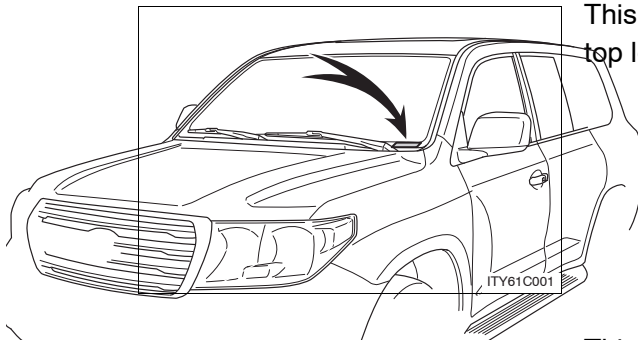

This number is stamped on the top left of the instrument panel.

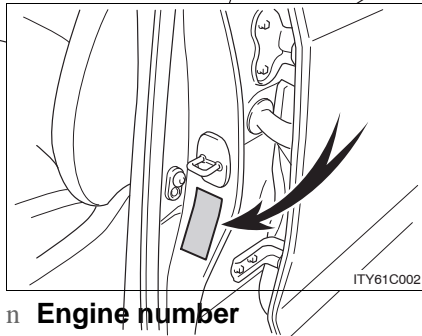

This number is also on the Certification Label.

### n Engine number

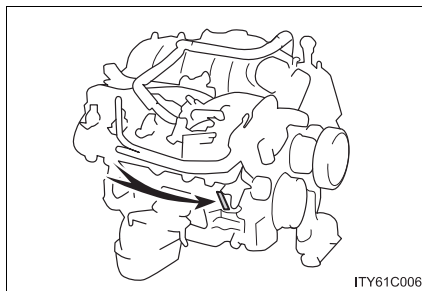

The engine number is stamped on the engine block as shown.



## 6-1. Specifications

### Engine

Model	3UR-FE
Type	8-cylinder V type, 4-cycle, gasoline
Bore and stroke	3.70 4.02 in. (94.0 102.0 mm)
Displacement	345.6 cu.in. (5663 cm <sup>3</sup> )
Valve clearance (engine cold)	Automatic adjustment
Drive belt tension	Automatic adjustment

### Fuel

Fuel type	Unleaded gasoline only
Octane rating	87 (Research octane number 91) or higher
Fuel tank capacity	24.6 gal. (93 L, 20.5 Imp.gal)

**Lubrication system**

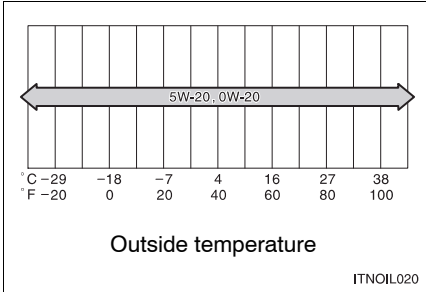
Oil capacity drain and refill (Reference)	
with filter	7.4 qt. (7.0 L, 6.2 Imp.qt.)
without filter	7.0 qt. (6.6 L, 5.8 Imp.qt.)
Oil grade	ILSAC multigrade engine oil
Recommended oil viscosity	<p>Use Toyota approved “Toyota Genuine Motor Oil” or equivalent to satisfy the above grade and viscosity.</p>  <p style="text-align: center;">Outside temperature</p> <p style="text-align: right; font-size: small;">ITNOIL020</p>

## Oil viscosity:

- The 0W portion of the oil viscosity rating indicates the characteristic of the oil which allows cold startability. Oils with a lower value before the W allow for easier starting of the engine in cold weather.
- The 20 in 0W-20 indicates the oil viscosity when the oil is at its operating temperature. An oil with a higher viscosity may be better suited if the vehicle is operated at high speeds, or under extreme load condition.

## 6-1. Specifications

### Cooling system

Capacity	16.3 qt. (15.4 L, 13.6 Imp.qt.)
Coolant type	Use either of the following: <ul style="list-style-type: none"><li>• “Toyota Super Long Life Coolant”</li><li>• Similar high-quality ethylene glycol-based non-silicate, non-amine, non-nitrite, and non-borate coolant with long-life hybrid organic acid technology</li></ul> Do not use plain water alone.

### Ignition system

Spark plug		
Make	DENSO	SK20HR11
Gap		0.043 in. (1.1 mm)

### NOTICE

#### Iridium-tipped spark plugs

Use only iridium-tipped spark plugs. Do not adjust gap when tuning engine.

**Electrical system**

Battery	
Open voltage at 68 F (20 C):	12.6 12.8 V Fully charged 12.2 12.4 V Half charged 11.8 12.0 V Discharged (Voltage is checked 20 minutes after the key is removed with all lights turned off.)
Charging rates	5 A max.

**Differential**

Oil capacity	
Front	2.00 qt. (1.90 L, 1.67 Imp.qt.)
Rear	4.39 qt. (4.15 L, 3.65 Imp.qt.)
Oil type and viscosity	Toyota Genuine Differential gear oil LT 75W-85 GL-5 or equivalent

“Toyota Genuine Differential Oil” is filled in your Toyota vehicle at factory fill.

Use Toyota approved “Toyota Genuine Differential Gear Oil” or an equivalent of matching quality to satisfy the above specification. Please contact your Toyota dealer for further details.

## 6-1. Specifications

### Automatic transmission

Fluid capacity	Without oil cooler	11.5 qt. (10.9 L, 9.6 Imp.qt.)
	With oil cooler	11.7 qt. (11.1 L, 9.8 Imp.qt.)
Fluid type	Toyota Genuine ATF WS	

### NOTICE

Using transmission fluid other than “Toyota Genuine ATF WS” may cause deterioration in shift quality, locking up of your transmission accompanied by vibration, and ultimately damage the transmission of your vehicle.

### Transfer

Oil capacity	1.53 qt. (1.45 L, 1.28 Imp.qt.)
Oil type	Gear oil API GL-5
Recommended oil viscosity	SAE75W-90

### Brakes

Pedal clearance <sup>*1</sup>	3.62 in. (92 mm) Min.
Pedal free play	0.04 0.24 in. (1.0 6.0 mm)
Brake pad wear limit	0.04 in. (1.0 mm)
Parking brake lining wear limit	0.04 in. (1.0 mm)
Parking brake adjustment <sup>*2</sup>	5 7 clicks
Fluid type	SAE J1703 or FMVSS No. 116 DOT 3

\*1: Minimum pedal clearance when depressed with a force of 110 lbf (490 N, 50 kgf) while the engine is running.

\*2: Parking brake pedal travel when pulled with a force of 45 lbf (200 N, 20 kgf).

**Chassis lubrication**

Propeller shafts	Lithium base chassis grease, NLGI No.2 Molybdenum–disulfide lithium base chassis grease, NLGI No.2 or lithium base chassis grease, NLGI No.2
Spider	
Slide yoke	

**Steering**

Free play	Less than 1.18 in. (30 mm)
Power steering fluid type	Automatic transmission fluid DEXRON® II or III

**Tires and wheels**

Tire size	P285/60R18 114V
Tire inflation pressure (Recommended cold tire inflation pressure)	<p>Normal driving</p> <p>Front tires: 33 psi (230 kPa, 2.3 kgf/cm<sup>2</sup> or bar)</p> <p>Rear tires: 33 psi (230 kPa, 2.3 kgf/cm<sup>2</sup> or bar)</p> <p>Spare tire: 33 psi (230 kPa, 2.3 kgf/cm<sup>2</sup> or bar)</p> <p>Trailer towing</p> <p>Front tires: 33 psi (230 kPa, 2.3 kgf/cm<sup>2</sup> or bar)</p> <p>Rear tires: 33 psi (230 kPa, 2.3 kgf/cm<sup>2</sup> or bar)</p> <p>Spare tire: 33 psi (230 kPa, 2.3 kgf/cm<sup>2</sup> or bar)</p>
Wheel size	18 8 J
Wheel nut torque	97 ft•lbf (131 N•m, 13.4 kgf•m)

**Light bulbs**

	Light Bulbs	Bulb No.	W	Type
Exterior	Headlights Low beam	9006	55	A
	High beam	9005	60	B
	Front turn signal lights		27	E
	Parking lights		5	E
	Front side marker lights		5	E
	Front fog lights		51	C
	Rear turn signal lights	7440	21	E
	Back-up lights	921	16	E
License plate lights	168	5	E	
Interior	Front interior light		8	E
	Rear interior lights With rear personal lights		8	E
	Without rear personal lights		8	F
	Front personal lights		8	E
	Rear personal lights		8	E
	Vanity lights		1.5	D
	Door courtesy lights		5	E
Glove box light		1.2	E	

- A: H11 halogen bulbs  
 B: HB3 halogen bulbs  
 C: HB4 halogen bulbs  
 D: Single end bulbs  
 E: Wedge base bulbs  
 F: Double end bulbs



**Your vehicle must use only unleaded gasoline.**

**Unleaded gasoline with an Octane Rating of 87 (Research Octane Number 91) or higher required for optimum engine performance.**

At minimum, the gasoline you use should meet the specifications of ASTM D4814 in the U.S.A.

---

**n Fuel tank opening for unleaded gasoline**

To help prevent incorrect fueling, your Toyota has a fuel tank opening that only accommodates the special nozzle on unleaded fuel pumps.

**n If your engine knocks**

l Consult your Toyota dealer.

l You may occasionally notice light knocking for a short time while accelerating or driving uphill. This is normal and there is no need for concern.

**n Gasoline quality**

In very few cases, driveability problems may be caused by the brand of gasoline you are using. If driveability problems persist, try changing the brand of gasoline. If this does not correct the problem, consult your Toyota dealer.

#### ■ **Gasoline quality standards**

- ┆ Automotive manufacturers in the US, Europe and Japan have developed a specification for fuel quality called World-Wide Fuel Charter (WWFC) that is expected to be applied worldwide.
- ┆ The WWFC consists of four categories that are based on required emission levels. In the US, category 4 has been adopted.
- ┆ The WWFC improves air quality by lowering emissions in vehicle fleets, and customer satisfaction through better performance.

#### ■ **Toyota recommends the use of gasoline containing detergent additives**

- ┆ Toyota recommends the use of gasoline that contains detergent additives to avoid build-up of engine deposits.
- ┆ All gasoline sold in the US contains detergent additives to clean and/or keep clean intake systems.

#### ■ **Toyota recommends the use of cleaner burning gasoline**

Cleaner burning gasoline, including reformulated gasoline that contains oxygenates such as ethanol or MTBE (Methyl Tertiary Butyl Ether) is available in many areas.

Toyota recommends the use of cleaner burning gasoline and appropriately blended reformulated gasoline. These types of gasoline provide excellent vehicle performance, reduce vehicle emissions and improve air quality.

#### ■ **Toyota does not recommend blended gasoline**

- ┆ Toyota allows the use of oxygenate blended gasoline where the oxygenate content is up to 10% ethanol or 15% MTBE.
- ┆ If you use gasohol in your Toyota, be sure that it has an octane rating no lower than 87.
- ┆ Toyota DOES NOT recommend the use of gasoline containing methanol.

## 6-1. Specifications

### **n Toyota does not recommend gasoline containing MMT**

Some gasoline contains octane enhancing additive called MMT (Methylcyclopentadienyl Manganese Tricarbonyl).

Toyota DOES NOT recommend the use of gasoline that contains MMT. If fuel containing MMT is used, your emission control system may be adversely affected.

The malfunction indicator lamp on the instrument cluster may come on. If this happens, contact your Toyota dealer for service.

### NOTICE

#### **n Notice on gasoline quality**

**I** Do not use leaded gasoline.

Leaded gasoline can cause damage to your vehicle's three-way catalytic converters causing the emission control system to malfunction.

**I** Do not use gasohol other than that stated here.

Other gasohol may cause fuel system damage or vehicle performance problems.

**I** Using unleaded gasoline with an octane number or rating lower than that stated here will cause persistent heavy knocking.

At worst, this will lead to engine damage.

#### **n Fuel-related poor driveability**

If after using a different type of fuel, poor driveability is encountered (poor hot starting, vaporization, engine knocking, etc.), discontinue the use of that type of fuel.

#### **n When refueling with gasohole**

Take care not to spill gasohol. It can damage your vehicle's paint.

## 6-1. Specifications

### Tire information

#### Typical tire symbols

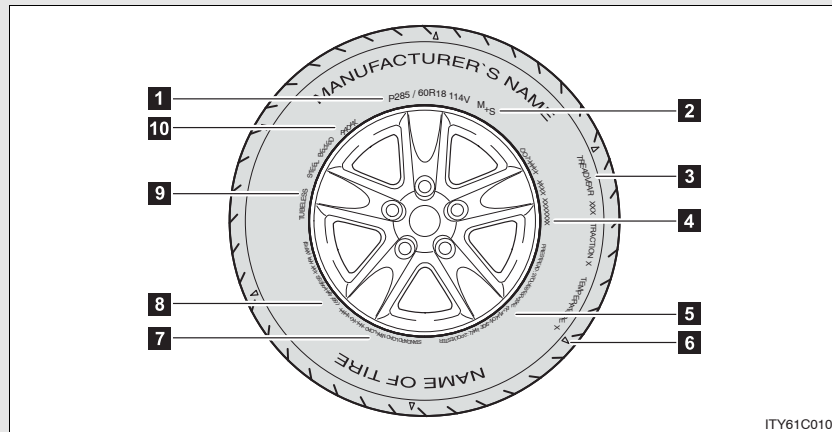

- 1** Tire size ( P. 509)
- 2** Summer tire or all season tire ( P. 396)  
An all season tire has "M+S" on the sidewall. A tire not marked "M+S" is a summer tire.
- 3** Uniform tire quality grading  
For details, see "Uniform Tire Quality Grading" that follows.
- 4** DOT and Tire Identification Number (TIN) ( P. 508)
- 5** Tire ply composition and materials  
Plies are layers of rubber-coated parallel cords. Cords are the strands which form the plies in a tire.
- 6** Location of treadwear indicators ( P. 510)
- 7** Load limit at maximum cold tire inflation pressure ( P. 512)

## 6-1. Specifications

### 8 Maximum cold tire inflation pressure ( P. 512)

This means the pressure to which a tire may be inflated.

### 9 TUBELESS or TUBE TYPE

A tubeless tire does not have a tube and air is directly filled in the tire. A tube type tire has a tube inside the tire and the tube maintains the air pressure.

### 10 Radial tires or bias-ply tires

A radial tire has RADIAL on the sidewall. A tire not marked RADIAL is a bias-ply tire.

## Typical DOT and tire identification number (TIN)

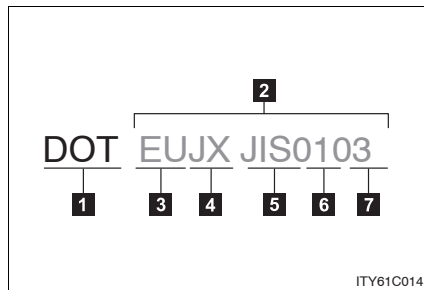

### 1 DOT symbol\*

### 2 Tire Identification Number (TIN)

### 3 Tire manufacturer's identification mark

### 4 Tire size code

### 5 Manufacturer's optional tire type code (3 or 4 letters)

### 6 Manufacturing week

### 7 Manufacturing year

\*:The DOT symbol certifies that the tire conforms to applicable Federal Motor Vehicle Safety Standards.

## Tire size

### n Typical tire size information

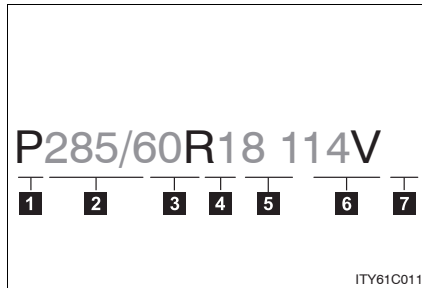

The illustration indicates typical tire size.

- 1** Tire use  
(P = Passenger car,  
T = Temporary use)
- 2** Section width (millimeters)
- 3** Aspect ratio  
(tire height to section width)
- 4** Tire construction code  
(R = Radial, D = Diagonal)
- 5** Wheel diameter (inches)
- 6** Load index (2 or 3 digits)
- 7** Speed symbol  
(alphabet with one letter)

### n Tire dimensions

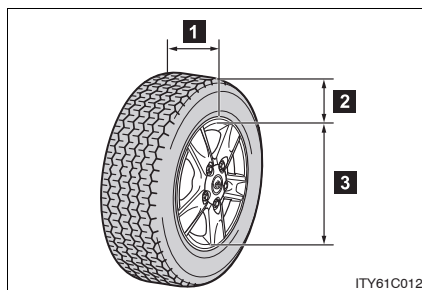

- 1** Section width
- 2** Tire height
- 3** Wheel diameter

### Tire section names

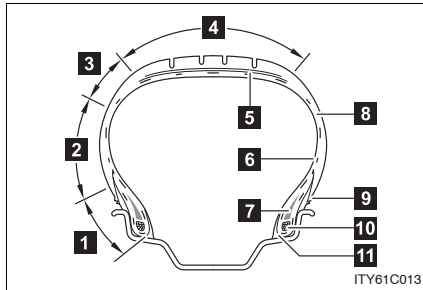

- 1 Bead
- 2 Sidewall
- 3 Shoulder
- 4 Tread
- 5 Belt
- 6 Inner liner
- 7 Reinforcing rubber
- 8 Carcass
- 9 Rim lines
- 10 Bead wires
- 11 Chafer

### Uniform Tire Quality Grading

This information has been prepared in accordance with regulations issued by the National Highway Traffic Safety Administration of the U.S.A. Department of Transportation.

It provides the purchasers and/or prospective purchasers of Toyota vehicles with information on uniform tire quality grading.

Your Toyota dealer will help answer any questions you may have as you read this information.

#### DOT quality grades

All passenger vehicle tires must conform to Federal Safety Requirements in addition to these grades. Quality grades can be found where applicable on the tire sidewall between tread shoulder and maximum section width.

For example: Treadwear 200 Traction AA Temperature A

### n **Treadwear**

The treadwear grade is a comparative rating based on the wear rate of the tire when tested under controlled conditions on a specified government test course.

For example, a tire graded 150 would wear one and a half (1 – 1/2) times as well on the government course as a tire graded 100.

The relative performance of tires depends upon the actual conditions of their use, however, and may depart significantly from the norm due to variations in driving habits, service practices and differences in road characteristics and climate.

### n **Traction AA, A, B, C**

The traction grades, from highest to lowest, are AA, A, B and C, and they represent the tire's ability to stop on wet pavement as measured under controlled conditions on specified government test surfaces of asphalt and concrete.

A tire marked C may have poor traction performance.

Warning: The traction grade assigned to this tire is based on braking (straight ahead) traction tests and does not include cornering (turning) traction.

### n **Temperature A, B, C**

The temperature grades are A (the highest), B, and C, representing the tire's resistance to the generation of heat and its ability to dissipate heat when tested under controlled conditions on a specified indoor laboratory test wheel.

Sustained high temperature can cause the material of the tire to degenerate and reduce tire life, and excessive temperature can lead to sudden tire failure.

The grade C corresponds to a level of performance which all passenger car tires must meet under the Federal Motor Vehicle Safety Standard No. 109.

Grades B and A represent higher levels of performance on the laboratory test wheel than the minimum required by law.



## 6-1. Specifications

**Warning:** The temperature grades for this tire are established for a tire that is properly inflated and not overloaded. Excessive speed, underinflation, or excessive loading, either separately or in combination, can cause heat buildup and possible tire failure.

### Glossary of tire terminology

Tire related term	Meaning
Cold tire inflation pressure	Tire pressure when the vehicle has been parked for three hours or more, or has not been driven more than 1 mile or 1.5 km under that condition
Maximum inflation pressure	The maximum cold inflated pressure to which a tire may be inflated, shown on the sidewall of the tire
Recommended inflation pressure	Cold tire inflation pressure recommended by a manufacturer.
Accessory weight	The combined weight (in excess of those standard items which may be replaced) of transmission, power steering, power brakes, power windows, power seats, radio and heater, to the extent that these items are available as factory-installed equipment (whether installed or not)
Curb weight	The weight of a motor vehicle with standard equipment, including the maximum capacity of fuel, oil and coolant, and if so equipped, air conditioning and additional weight optional engine
Maximum loaded vehicle weight	The sum of: (a) Curb weight (b) Accessory weight (c) Vehicle capacity weight (d) Production options weight

Tire related term	Meaning
Normal occupant weight	150 lb. (68 kg) times the number of occupants specified in the second column of Table 1* that follows
Occupant distribution	Distribution of occupants in a vehicle as specified in the third column of Table 1* below
Production options weight	The combined weight of installed regular production options weighing over 5 lb. (2.3 kg) in excess of the standard items which they replace, not previously considered in curb weight or accessory weight, including heavy duty brakes, ride levelers, roof rack, heavy duty battery, and special trim
Rim	A metal support for a tire or a tire and tube assembly upon which the tire beads are seated
Rim diameter (Wheel diameter)	Nominal diameter of the bead seat
Rim size designation	Rim diameter and width
Rim type designation	The industry manufacturer's designation for a rim by style or code
Rim width	Nominal distance between rim flanges
Vehicle capacity weight (Total load capacity)	The rated cargo and luggage load plus 150 lb. (68 kg) times the vehicle's designated seating capacity
Vehicle maximum load on the tire	The load on an individual tire that is determined by distributing to each axle its share of the maximum loaded vehicle weight, and dividing by two

6-1. Specifications

Tire related term	Meaning
Vehicle normal load on the tire	The load on an individual tire that is determined by distributing to each axle its share of curb weight, accessory weight, and normal occupant weight (distributed in accordance with Table 1* below), and dividing it by two
Weather side	The surface area of the rim not covered by the inflated tire
Bead	The part of the tire that is made of steel wires, wrapped or reinforced by ply cords and that is shaped to fit the rim
Bead separation	A breakdown of the bond between components in the bead
Bias ply tire	A pneumatic tire in which the ply cords that extend to the beads are laid at alternate angles substantially less than 90 degrees to the centerline of the tread
Carcass	The tire structure, except tread and sidewall rubber which, when inflated, bears the load
Chunking	The breaking away of pieces of the tread or sidewall
Cord	The strands forming the plies in the tire
Cord separation	The parting of cords from adjacent rubber compounds
Cracking	Any parting within the tread, sidewall, or innerliner of the tire extending to cord material
CT	A pneumatic tire with an inverted flange tire and rim system in which the rim is designed with rim flanges pointed radially inward and the tire is designed to fit on the underside of the rim in a manner that encloses the rim flanges inside the air cavity of the tire

Tire related term	Meaning
Extra load tire	A tire designed to operate at higher loads and at higher inflation pressures than the corresponding standard tire
Groove	The space between two adjacent tread ribs
Innerliner	The layer(s) forming the inside surface of a tubeless tire that contains the inflating medium within the tire
Innerliner separation	The parting of the innerliner from cord material in the carcass
Intended outboard sidewall	(a) The sidewall that contains a whitewall, bears white lettering, or bears manufacturer, brand, and/or model name molding that is higher or deeper than the same molding on the other sidewall of the tire, or (b) The outward facing sidewall of asymmetrical tire that has a particular side that must always face outward when mounted on a vehicle
Light truck (LT) tire	A tire designated by its manufacturer as primarily intended for use on lightweight trucks or multipurpose passenger vehicles
Load rating	The maximum load that a tire is rated to carry for a given inflation pressure
Maximum load rating	The load rating for a tire at the maximum permissible inflation pressure for that tire
Maximum permissible inflation pressure	The maximum cold inflation pressure to which a tire may be inflated
Measuring rim	The rim on which a tire is fitted for physical dimension requirements
Open splice	Any parting at any junction of tread, sidewall, or innerliner that extends to cord material
Outer diameter	The overall diameter of an inflated new tire

6-1. Specifications

Tire related term	Meaning
Overall width	The linear distance between the exteriors of the sidewalls of an inflated tire, including elevations due to labeling, decorations, or protective bands or ribs
Passenger car tire	A tire intended for use on passenger cars, multipurpose passenger vehicles, and trucks, that have a gross vehicle weight rating (GVWR) of 10,000 lb. or less
Ply	A layer of rubber-coated parallel cords
Ply separation	A parting of rubber compound between adjacent plies
Pneumatic tire	A mechanical device made of rubber, chemicals, fabric and steel or other materials, that, when mounted on an automotive wheel, provides the traction and contains the gas or fluid that sustains the load
Radial ply tire	A pneumatic tire in which the ply cords that extend to the beads are laid at substantially 90 degrees to the centerline of the tread
Reinforced tire	A tire designed to operate at higher loads and at higher inflation pressures than the corresponding standard tire
Section width	The linear distance between the exteriors of the sidewalls of an inflated tire, excluding elevations due to labeling, decoration, or protective bands
Sidewall	That portion of a tire between the tread and bead
Sidewall separation	The parting of the rubber compound from the cord material in the sidewall

Tire related term	Meaning
Snow tire	A tire that attains a traction index equal to or greater than 110, compared to the ASTM E-1136 Standard Reference Test Tire, when using the snow traction test as described in ASTM F-1805-00, Standard Test Method for Single Wheel Driving Traction in a Straight Line on Snow-and Ice-Covered Surfaces, and which is marked with an Alpine Symbol (  ) on at least one sidewall
Test rim	The rim on which a tire is fitted for testing, and may be any rim listed as appropriate for use with that tire
Tread	That portion of a tire that comes into contact with the road
Tread rib	A tread section running circumferentially around a tire
Tread separation	Pulling away of the tread from the tire carcass
Treadwear indicators (TWI)	The projections within the principal grooves designed to give a visual indication of the degrees of wear of the tread
Wheel-holding fixture	The fixture used to hold the wheel and tire assembly securely during testing

\*:Table 1 Occupant loading and distribution for vehicle normal load for various designated seating capacities

## 6-1. Specifications

Designated seating capacity, Number of occupants	Vehicle normal load, Number of occupants	Occupant distribution in a normally loaded vehicle
2 through 4	2	2 in front
5 through 10	3	2 in front, 1 in second seat
11 through 15	5	2 in front, 1 in second seat, 1 in third seat, 1 in fourth seat
16 through 20	7	2 in front, 2 in second seat, 2 in third seat, 1 in fourth seat

6-2. Customization

## Customizable features

**Your vehicle includes a variety of electronic features that can be personalized to your preferences. Programming these preferences requires specialized equipment and may be performed by an authorized Toyota dealership.**

Some function settings are changed simultaneously with other functions being customized. Contact your Toyota dealer for further details.

Item	Function	Default setting	Customized setting
Wireless remote control ( P. 40)	Wireless remote control	ON	OFF
	Operation signal (Emergency flashers)	ON	OFF
	Open door warning function (when locking the vehicle)	ON	OFF
	Unlocking operation	Driver's door unlocked in one step, all doors unlocked in two steps	All doors unlocked in one step
	Automatic door locking function (if a door is not opened after being unlocked)	ON	OFF
	Time elapsed before automatic door lock function is activated if door is not opened after being unlocked	60 seconds	30 seconds
			120 seconds



6-2. Customization

Item	Function	Default setting	Customized setting
Door lock ( P. 43)	Unlocking using a key	Driver's door unlocked in one step, all doors unlocked in two steps	All doors unlocked in one step
	Speed-detecting automatic door lock function	OFF	ON
	Shift the shift lever to position other than "P" locks all doors	ON	OFF
	Shift the shift lever to "P" unlocks all doors	ON	OFF
	Opening driver's door unlocks all doors	OFF	ON
Power windows ( P. 83)	Mechanical key linked operation (close)	ON	OFF
	Mechanical key linked operation (open)	ON	OFF
	Wireless remote control linked operation (open)	ON	OFF
	Linked entry function	ON	OFF
Automatic light control system ( P. 170)	Light sensor sensitivity	Level 3	Level 1 to 5
	Daytime running light system	ON	OFF
	Time elapsed before headlights automatically turn off after doors are closed	30 seconds	0 seconds
			60 seconds
90 seconds			

Item	Function	Default setting	Customized setting
Illumination ( P. 325)	Time period before lights turn off	15 seconds	7.5 seconds
			30 seconds
	Operation after the “ENGINE START STOP” switch is turned off	ON	OFF
	Operation when the doors are unlocked	ON	OFF
Moon roof ( P. 86)	Operation when you approach the vehicle with the electronic key on your person (When the interior light switch [ON/DOOR/OFF] is ON)	ON	OFF
	Mechanical key linked operation	On	Off
	Mechanical key linked operation	Open and close	Open only
			Close only
	Linked operation of components when door key is used	Slide only	Tilt only
	Wireless remote control linked operation	On	Off
Linked operation of components when wireless remote control used	Slide only	Tilt only	
Linked entry function	On	Off	

6-2. Customization

**Multi-information display ( P. 166)**

Available languages

English (U.S.A.), English (UK), French, German, Spanish, Italian, Japanese, Simplified Chinese and Traditional Chinese

### 6-3. Initialization Items to initialize

**The following items must be initialized for normal system operation in cases such as after the battery is reconnected, or maintenance is performed on the vehicle.**

Item	When to initialize	Reference
Engine oil maintenance data	After changing engine oil	P. 380
Tire pressure warning system	<ul style="list-style-type: none"><li>• When rotating the tires on vehicles differing with front and rear tire inflation pressures.</li><li>• When changing the tire inflation pressure by changing traveling speed or load weight, etc.</li><li>• When changing the tire size.</li></ul>	P. 393

### 6-3. Initialization

## Reporting safety defects for U.S. owners

If you believe that your vehicle has a defect which could cause a crash or could cause injury or death, you should immediately inform the National Highway Traffic Safety Administration (NHTSA) in addition to notifying Toyota Motor Sales, U.S.A., Inc. (Toll-free: 1-800-331-4331).

If NHTSA receives similar complaints, it may open an investigation, and if it finds that a safety defect exists in a group of vehicles, it may order a recall and remedy campaign. However, NHTSA cannot become involved in individual problems between you, your dealer, or Toyota Motor Sales, U.S.A., Inc.

To contact NHTSA, you may call the Vehicle Safety Hotline toll-free at 1-888-327-4236 (TTY: 1-800-424-9153); go to <http://www.safercar.gov> ; or write to: Administrator, NHTSA, 1200 New Jersey Ave, S.E., Washington, DC 20590. You can also obtain other information about motor vehicle safety from <http://www.safercar.gov>.

Abbreviation list

Abbreviation/Acronym list

ABBREVIATIONS	MEANING
ABS	Anti-lock Brake System
ALR	Automatic Locking Retractor
AUX	Auxiliary
CRS	Child Restraint System
DISP	Display
ECT	Electronic Controlled Transmission
ECU	Electronic Control Unit
EDR	Event Data Recorder
ELR	Emergency Locking Retractor
GAWR	Gross Axle Weight Rating
GVWR	Gross Vehicle Weight Rating
I/M	Emission inspection and maintenance
INT	Intermittent
KDSS	Kinetic Dynamic Suspension System
LED	Light Emitting Diode
MMT	Methylcy clopentadienyl Manganese Tricarbonyl
M+S	Mud and Snow
MTBE	Methyl Tertiary Butyl Ether
OBD	On Board Diagnostics
PWR	Power
RSCA	Roll Sensing of Curtain Shield airbag
SRS	Supplemental Restraint System
TIN	Tire Identification Number
TPMS	Tire Pressure Warning System
TRAC	Traction Control
VIN	Vehicle Identification Number
VSC	Vehicle Stability Control





**A**

**A/C**  
 Air conditioning filter ..... 407  
 Automatic air conditioning  
 system ..... 242  
**ABS** ..... 201  
**Active traction control**..... 201  
**Air conditioning filter**..... 407  
**Air conditioning system**  
 Air conditioning filter ..... 407  
 Automatic air conditioning  
 system ..... 242  
**Airbags**  
 Airbag operating conditions... 106  
 Airbag precautions for your  
 child ..... 110  
 Airbag warning light..... 450  
 Curtain shield airbag  
 operating conditions..... 106  
 Curtain shield airbag  
 precautions ..... 110  
 Front passenger occupant  
 classification system ..... 118  
 General airbag precautions... 110  
 Locations of airbags ..... 102  
 Modification and disposal of  
 airbags ..... 113  
 Proper driving posture... 100, 110  
 Roll sensing of curtain shield  
 airbags off switch ..... 116  
 Side airbag operating  
 conditions..... 106  
 Side airbag precautions ..... 110  
 SRS airbags ..... 102  
**Alarm**..... 97  
**Antenna**..... 263  
**Anti-lock brake system**..... 201  
**Armrest** ..... 348  
**Ashtrays**..... 341  
**Audio input** ..... 282  
**Audio system**  
 Antenna ..... 263

Audio input ..... 282  
 AUX adapter ..... 282  
 CD player/changer ..... 265  
 MP3/WMA disc ..... 273  
 Optimal use ..... 280  
 Portable music player ..... 282  
 Radio..... 260  
 Steering wheel audio  
 switch..... 283  
**Automatic air conditioning  
 system** ..... 242  
**Automatic light control  
 system** ..... 170  
**Automatic transmission**  
 Automatic transmission ..... 153  
 If the shift lever cannot be  
 shifted from P ..... 478  
 S mode..... 155  
**AUX adapter** ..... 282

**B**

**Back door**  
 Back door ..... 48  
 Wireless remote control key... 40  
**Back-up lights**  
 Replacing light bulbs ..... 426  
 Wattage..... 503  
**Battery**  
 Checking ..... 387  
 If the vehicle has discharged  
 battery ..... 484  
 Preparing and checking  
 before winter ..... 222  
**Bottle holder**..... 334  
**Brake**  
 Fluid ..... 384  
 Parking brake ..... 159  
**Brake assist**..... 201  
**Break-in tips** ..... 141  
**Brightness control**  
 Instrument light control..... 161

**C**

**Care**

- Exterior ..... 360
- Interior ..... 362
- Seat belts ..... 363

**Card holder ..... 336**

**Cargo capacity ..... 214**

**Cargo net hooks ..... 350**

**CD player/changer ..... 265**

**Center differential**

- lock/unlock switch ..... 190

**Chains ..... 224**

**Child-protectors ..... 44**

**Child restraint system**

- Booster seats, definition ..... 123
- Booster seats, installation .... 127
- Convertible seats, definition..... 123
- Convertible seats, installation ..... 127
- Front passenger occupant classification system ..... 117
- Infant seats, definition ..... 123
- Infant seats, installation ..... 127
- Installing CRS with lower anchorages ..... 133
- Installing CRS with seatbelts..... 128
- Installing CRS with top straps ..... 135

**Child safety**

- Airbag precautions ..... 110
- Battery precautions ..... 389, 412
- Child-protectors ..... 44
- Child restraint system ..... 123
- How your child should wear the seatbelt ..... 73
- Installing child restraints ..... 127
- Moon roof precautions..... 88
- Power window lock switch ..... 83
- Power window precautions..... 85
- Removed key battery precautions ..... 410

- Seat belt extender precautions ..... 76
- Seat belt precautions ..... 74
- Seat heater precautions ..... 346

**Cigarette lighter ..... 343**

**Cleaning**

- Exterior ..... 360
- Interior ..... 362
- Seat belts ..... 363

**Clock ..... 339**

**Condenser ..... 383**

**Console box ..... 330**

**Cool box..... 330**

**Cooling system**

- Engine overheating ..... 488

**Cruise control..... 178**

**Cup holder ..... 333**

**Crawl Control ..... 197**

**Curtain shield airbags ..... 102**

**Customizable features..... 519**

**D**

**Daytime running light system ..... 171**

**Defogger**

- Rear window ..... 256

**Dimension..... 494**

**Display**

- Crawl Control display ..... 197
- Trip information ..... 167
- Toyota park assist system display..... 181
- Shift position and shift range..... 155
- Warning messages ..... 460

**Do-it-yourself maintenance..... 371**

**Door courtesy lights**

- Door courtesy lights ..... 325
- Wattage ..... 503

**Door lock**

- Back door ..... 48
- Side door ..... 43
- Wireless remote control key .... 40

**Doors**

- Back door ..... 48
- Side door ..... 43
- Side mirrors ..... 80

**Driver's seat belt reminder**

- light ..... 452**

**Driving**

- Break-in tips ..... 141
- Correct posture ..... 100
- Off-road precautions ..... 209
- Procedures ..... 140
- Winter driving tips ..... 222

**Driving position memory ..... 62**

**E Electronic key**

- If your electronic key battery is discharged... 410, 481

**Emergency, in case of**

- If a warning message is displayed..... 460
- If the electronic key does not operate properly..... 481
- If the engine will not start ..... 476
- If the shift lever cannot be shifted from P..... 478
- If the vehicle has discharged battery ..... 484
- If the warning buzzer sounds ..... 449
- If the warning light turns on ... 449
- If you cannot operate back door opener ..... 480
- If you have a flat tire ..... 463
- If you lose your keys ..... 479
- If you think something is wrong ..... 445
- If your vehicle becomes stuck ..... 491
- If your vehicle needs to be towed ..... 440
- If your vehicle overheats ..... 488

**Engine**

- Compartment ..... 375
- Engine switch ..... 149
- Hood ..... 374
- How to start the engine ..... 149
- Identification number..... 495
- If the engine will not start ..... 476
- Ignition switch ..... 149
- Overheating ..... 488

**Engine coolant**

- Capacity ..... 498
- Checking ..... 382
- Preparing and checking before winter ..... 222

**Engine coolant temperature**

- gauge ..... 160**

**Engine immobilizer system ..... 93**

**Engine oil**

- Capacity ..... 497
- Checking ..... 377
- Preparing and checking before winter ..... 222

**Engine oil maintenance**

- data ..... 380**

**Engine switch ..... 149**

**Event data recorder ..... 447**

**F First-aid kit holder ..... 351**

**Floor mat ..... 349**

**Fluid**

- Brake..... 384
- Power steering ..... 386
- Washer..... 390

**Fog lights**

- Replacing light bulbs ..... 426
- Switch ..... 172
- Wattage..... 503

**Four-wheel drive system..... 190**

**Front fog lights**

- Replacing light bulbs ..... 426
- Switch ..... 172

Wattage .....	503	<b>Hill-start assist control .....</b>	<b>201</b>
<b>Front passenger's seat belt reminder light .....</b>	<b>452</b>	<b>Hood .....</b>	<b>374</b>
<b>Front seats</b>		<b>Hooks</b>	
Adjustment .....	51	Cargo hook.....	350
Driving position memory .....	62	Tie-down hooks .....	350
<b>Front side marker light</b>		<b>I</b>	
Replacing light bulbs .....	426	<b>I/M test.....</b>	<b>370</b>
Wattage .....	503	<b>Identification</b>	
<b>Front turn signal lights</b>		Engine .....	495
Replacing light bulbs .....	426	Vehicle .....	495
Wattage .....	503	<b>Ignition</b>	
<b>Fuel</b>		Engine switch .....	149
Capacity .....	496	Keys .....	24
Fuel gauge .....	160	Ignition switch.....	149
Fuel pump shut off system ...	446	<b>Ignition switch.....</b>	<b>149</b>
Gas station information .....	540	<b>Illuminated entry system .....</b>	<b>325</b>
Information .....	504	<b>Indicator lights .....</b>	<b>163</b>
Refueling .....	89	<b>Initialization</b>	
Type .....	504	Items to initialize.....	523
<b>Fuel door.....</b>	<b>89</b>	<b>Inside rear view mirror .....</b>	<b>79</b>
<b>Fuel filler door .....</b>	<b>89</b>	<b>Instrument panel light control .....</b>	<b>161</b>
<b>Fuel pump shut off system .....</b>	<b>446</b>	<b>Interior lights</b>	
<b>Fuses.....</b>	<b>413</b>	Interior lights.....	325
<b>G</b>		Switch.....	326
<b>Garage door opener .....</b>	<b>352</b>	Wattage.....	503
<b>Gas station information .....</b>	<b>540</b>	<b>J</b>	
<b>Gauges .....</b>	<b>160</b>	<b>Jack</b>	
<b>Glove box .....</b>	<b>329</b>	Replacing the wheel .....	463
<b>Glove box light .....</b>	<b>329</b>	<b>Jack handle .....</b>	<b>463</b>
<b>H</b>		<b>K</b>	
<b>Head restraints</b>		<b>KDSS .....</b>	<b>201</b>
Adjusting.....	65	<b>Keyless entry.....</b>	<b>26</b>
<b>Headlight cleaner .....</b>	<b>177</b>	<b>Keys</b>	
<b>Headlights</b>		Electronic key .....	24
Replacing light bulbs .....	426	If you lose your keys .....	479
Switch.....	170	If your electronic key battery is discharged... 410, 481	
Wattage .....	503	Ignition switch.....	149
<b>Heaters</b>		Keyless entry.....	26
Seat heaters .....	346	Key number .....	24

Keys ..... 24  
 Mechanical key ..... 24  
 Wireless remote control key .... 40

**L**

**Language**  
 Multi-information display..... 166, 522  
**Licence plate lights**  
 Replacing light bulbs ..... 426  
 Wattage ..... 503  
**Light bulbs**  
 Replacing ..... 426  
 Wattage ..... 503  
**Lights**  
 Door courtesy lights ..... 325  
 Fog light switch ..... 172  
 Headlights switch ..... 170  
 Interior light switch ..... 326  
 Personal light switch ..... 327  
 Replacing light bulbs ..... 426  
 Turn signal lever..... 158  
 Vanity lights ..... 338  
 Wattage ..... 503  
**Load capacity ..... 221**

**M**

**Maintenance**  
 Do-it-yourself maintenance ... 371  
 General maintenance ..... 367  
 Maintenance data..... 494  
 Maintenance requirements.... 365  
**Meter**  
 Instrument panel light control ..... 161  
 Meters ..... 160  
**Mirrors**  
 Inside rear view mirror..... 79  
 Side mirror heater ..... 256  
 Side mirrors ..... 80  
 Vanity mirrors ..... 338  
**Moon roof ..... 86**

**MP3 disc ..... 273**  
**Multi-information display ..... 166**

**O**

**Odometer ..... 160**  
**Off-road precautions ..... 209**  
**Oil**  
 Engine oil ..... 377  
**Opener**  
 Fuel filler door ..... 89  
 Hood ..... 374  
**Outside rear view mirrors**  
 Adjusting and folding..... 80  
 Mirror position memory ..... 62  
**Outside temperature display ..... 340**  
**Overhead console..... 332**  
**Overheating, Engine ..... 488**

**P**

**Parking brake ..... 159**  
**Parking lights**  
 Replacing light bulbs ..... 426  
 Switch ..... 170  
 Wattage..... 503  
**Personal lights**  
 Personal lights ..... 327  
 Switch ..... 327  
 Wattage..... 503  
**Pollen removal mode..... 248**  
**Power outlet ..... 344**  
**Power steering**  
 Fluid ..... 386  
**Power windows ..... 83**

**R**

**Radiator ..... 383**  
**Radio ..... 260**  
**RDS ..... 262**  
**Rear seats**  
 Adjustment ..... 53  
 Tumbling second seats ..... 54  
 Tumbling third seats..... 57

<b>Rear side marker lights</b>		
Wattage .....	503	
<b>Rear turn signal lights</b>		
Replacing light bulbs .....	426	
Wattage .....	503	
<b>Rear window defogger.....</b>	<b>256</b>	
<b>Rear window wiper.....</b>	<b>176</b>	
<b>Replacing</b>		
Fuses.....	413	
Key battery .....	410	
Light bulbs .....	426	
Tires .....	463	
<b>Reporting safety defects for U.S.A. owners.....</b>	<b>526</b>	
<b>Roll sensing of curtain shield airbags off switch .....</b>	<b>116</b>	
<b>Roof luggage carrier .....</b>	<b>214</b>	
<b>S</b>		
<b>Seat belts</b>		
Adjusting the seat belt .....	70	
Automatic Locking Retractor .....	72	
Child restraint system installation .....	127	
Cleaning and maintaining the seat belts.....	363	
Emergency Locking Retractor .....	72	
How to wear your seat belt.....	69	
How your child should wear the seat belt .....	73	
Pregnant women, proper seat belt use .....	73	
Reminder light .....	452	
Seat belt extenders .....	74	
Seat belt pretensioners .....	72	
<b>Seat heaters.....</b>	<b>346</b>	
<b>Seats</b>		
Adjustment precautions .....	52	
Child seats/child restraint system installation.....	127	
Cleaning .....	362	
Driver's seat position memory .....	62	
Front seat adjustment .....	51	
Head restraint.....	65	
Properly sitting in the seat.....	100	
Rear seat adjustment .....	53	
Seat heaters .....	346	
<b>Service reminder indicators .....</b>	<b>163</b>	
<b>Shift lever</b>		
Automatic transmission .....	153	
If the shift lever cannot be shifted from P.....	478	
<b>Side airbags.....</b>	<b>102</b>	
<b>Side marker lights</b>		
Replacing light bulbs .....	426	
Switch.....	170	
Wattage.....	503	
<b>Side mirror</b>		
Adjusting and folding.....	80	
Mirror position memory .....	62	
<b>Smart access system with push button start</b>		
Entry function .....	26	
Starting the engine .....	149	
<b>Spare tire</b>		
Inflation pressure.....	401	
Spare tire.....	463	
<b>Spark plug .....</b>	<b>498</b>	
<b>Specifications.....</b>	<b>494</b>	
<b>Speech command switch*</b>		
<b>Speedometer .....</b>	<b>160</b>	
<b>Steering</b>		
Column lock release.....	151	
Fluid .....	386	
<b>Steering wheel</b>		
Adjustment .....	77	
Audio switches .....	283	
Steering wheel position memory .....	62	

\*: Refer to the "Navigation System Owner's Manual".  
535

Alphabetical index

**Stop lights**  
 Replacing light bulbs ..... 426  
 Wattage ..... 503  
**Storage feature**..... 328  
**Storage precautions** ..... 214  
**Stuck**  
 If your vehicle becomes  
 stuck ..... 491  
**Sun visors**..... 337  
**Sunshade**  
 Roof..... 87  
**Switch**  
 ECT switch ..... 154  
 Driving mode select switch.... 154  
 Engine switch ..... 149  
 Fog light switch ..... 172  
 Ignition switch..... 149  
 Light switches..... 170  
 Power door lock switch ..... 43  
 Power window switch ..... 83  
 Rear window wiper and  
 washer switch ..... 176  
 Window lock switch ..... 83  
 Wipers and washer switch .... 173

**T**  
**Tachometer**  
 Tachometer ..... 160  
**Tail lights**  
 Switch..... 170  
 Wattage ..... 503  
**Talk switch\***  
**Telephone switch\***  
**Theft deterrent system**  
 Alarm ..... 97  
 Engine immobilizer system ..... 93  
**Theft prevention labels**..... 99  
**Tire inflation pressure** ..... 401  
**Tie-down hooks**..... 350  
**Tire information**  
 Glossary ..... 512  
 Size ..... 509

Tire identification number..... 508  
 Uniform tire quality grading ... 510  
**Tires**  
 Chains ..... 222  
 Checking ..... 391  
 If you have a flat tire..... 463  
 Inflation pressure ..... 401  
 Information ..... 507  
 Pressure warning system..... 391  
 Replacing ..... 463  
 Rotating tires ..... 391  
 Size ..... 502  
 Snow tires ..... 222  
 Spare tire ..... 463  
**Tools** ..... 463  
**Total load capacity** ..... 221  
**Towing**  
 Emergency towing ..... 440  
**Toyota park assist system** ..... 181  
**TRAC**..... 201  
**Traction control** ..... 201  
**Trip information display**..... 166  
**Trip meter** ..... 160  
**Turn signal lights**  
 Replacing light bulbs ..... 426  
 Switch ..... 158  
 Wattage..... 503

**V**  
**Vanity lights**  
 Vanity lights..... 338  
 Wattage..... 503  
**Vanity mirrors** ..... 338  
**Vehicle identification**  
 number ..... 495  
**Vehicle stability control** ..... 201  
**VSC** ..... 201

**W**  
**Warning buzzers**  
 Brake system ..... 449  
 Open door ..... 451  
 Seat belt reminder..... 452  
**Warning lights**

Anti-lock brake system .....	451
Brake system.....	449
Charging system .....	450
Low fuel level.....	453
Malfunction indicator lamp....	450
Master warning .....	453
Open door .....	451
Pre-collision.....	451
Seat belt reminder .....	452
SRS airbags .....	450
Tire pressure .....	452
Unengaged "Park" .....	452
<b>Warning messages .....</b>	<b>460</b>
<b>Warning reflector holder .....</b>	<b>351</b>
<b>Washer</b>	
Checking .....	390
Preparing and checking	
before winter .....	222
Switch.....	173
<b>Washing and waxing.....</b>	<b>360</b>
<b>Weight</b>	
Cargo capacity .....	214
Load limits .....	221
Weight .....	494
<b>Wheels.....</b>	<b>405</b>
<b>Window glasses .....</b>	<b>83</b>
<b>Window lock switch .....</b>	<b>83</b>
<b>Windows</b>	
Power windows .....	83
Rear window defogger .....	256
Washer .....	173
<b>Windshield wiper de-icer.....</b>	<b>257</b>
<b>Windshield wipers.....</b>	<b>173</b>
<b>Wireless remote control key</b>	
Replacing the battery .....	410
Wireless remote control key ...	40
<b>WMA disc .....</b>	<b>273</b>

\*. Refer to the "Navigation System Owner's Manual".  
537



What to do if...  
 What to do if...

A tire punctures	P. 463	If you have a flat tire
The engine does not start	P. 93	Engine immobilizer system
	P. 476	If the engine will not start
	P. 484	If the battery is discharged
The shift lever cannot be moved out	P. 478	If the shift lever cannot be shifted
The engine coolant temperature gauge enters the red zone	P. 488	If your vehicle overheats
Steam can be seen coming from under the hood		
The key is lost	P. 479	If you lose your keys
The battery runs out	P. 484	If the battery is discharged
The doors cannot be locked	P. 43	Side doors
	P. 48	Back doors
The horn begins to sound	P. 97	Alarm
The vehicle is stuck in mud or sand	P. 491	If the vehicle becomes stuck
The warning light or indicator light comes on	P. 449	If the warning light turns on

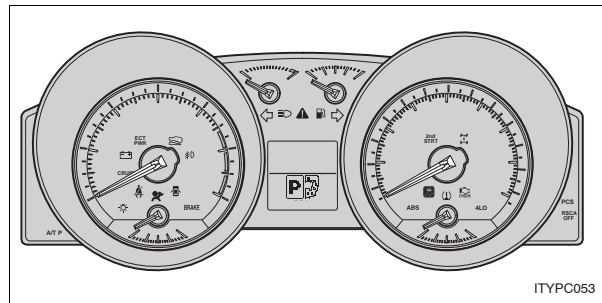

**nWarning lights**

<b>BRAKE</b>	Brake system warning light	P. 449		Driver's seat belt reminder light	P. 452
<b>ABS</b>	ABS warning light	P. 451	<b>PASSENGER</b> 	Front passenger's seat belt reminder light	
	SRS warning light	P. 450	OR <b>PASSENGER</b> 		P. 452
	Open door warning light	P. 451		Tire pressure warning light	P. 451
	Charging system warning light	P. 450	<b>PCS</b>	Pre-collision warning light	P. 450
<b>A/T P</b>	Unengaged "Park" warning light	P. 452		Low fuel level warning light	P. 451
	Malfunction indicator lamp	P. 450		Master warning light	P. 453

The warning message is displayed

P. 460 If a warning message is displayed

## GAS STATION INFORMATION

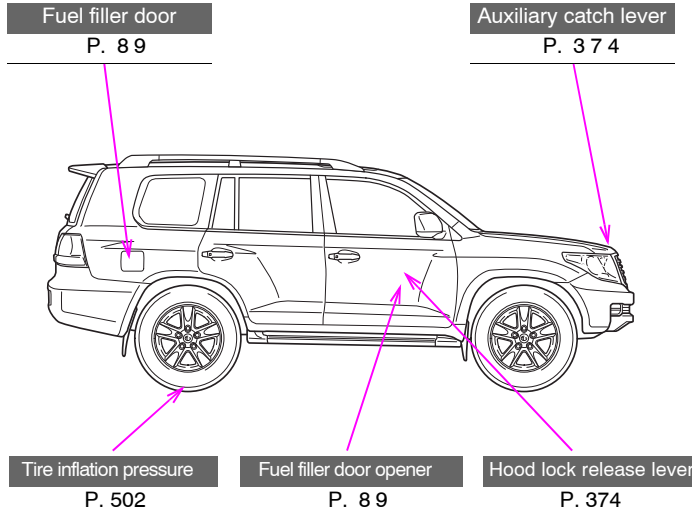

Fuel tank capacity	24.6 gal. (93 L, 20.5 Imp.gal.)	
Fuel type	Unleaded gasoline only	P. 90, 496
Cold tire inflation pressure		P. 502
Engine oil capacity drain and refill (Reference)	qt. (L, Imp.qt.) With filter 7.4 (7.0, 6.2) Without filter 7.0 (6.6, 5.8)	
Engine oil type	"Toyota Genuine Motor Oil" or equivalent Oil grade: ILSAC multigrade engine oil P. 497 Recommended oil viscosity: SAE 0W-20, 5W-20	