



*XC 90*

OWNER'S MANUAL



# VÄLKOMMEN!

We trust that you will enjoy many years of safe driving in your Volvo, an automobile designed with your safety and comfort in mind. To help get the most from your Volvo, we urge you to familiarize yourself with the instructions and maintenance information in this owner's manual. The owner's manual can also be found in a mobile app (Volvo manual) and on Volvo Car's support site at [support.volvocars.com](https://support.volvocars.com).

We also urge you and your passengers to wear seat belts at all times in this (or any other) vehicle. And, of course, please do not operate a vehi-

cle if you may be affected by alcohol, medication or any impairment that could hinder your ability to drive.

Your Volvo is designed to meet all applicable federal safety and emission standards. If you have any questions regarding your vehicle, please contact your Volvo retailer or see the article "Contacting Volvo" for information on getting in touch with Volvo in the United States and Canada.

# TABLE OF CONTENTS

## INTRODUCTION

Contacting Volvo	14
Volvo On Call Roadside Assistance	14
Additional information about your vehicle	14
Volvo and the environment	15
Owner's manual and the environment	16
IntelliSafe—driver support	16
Sensus	17
Owner's manual in mobile devices	20
Options, accessories and the On-board Diagnostic (OBDII) socket	21
Finding owner's information	23
Driver distraction	24
Volvo Structural Parts Statement	25
Crash event data	26
Volvo ID	27
Center display overview	28
Changing center display settings	30
Using the center display keyboard	31
Function view buttons	36
Navigating in the center display's views	38
Symbols in the center display status bar	43
Changing settings in different types of apps	43
Using the center display	44
Using the owner's manual	48

On-board digital owner's manual	50
Navigating in the digital owner's manual	51
Glass	53
Technician certification	53

## SAFETY

General safety information	56
Occupant safety	56
Reporting safety defects	57
Recall information	58
Safety during pregnancy	58
Whiplash protection system	59
Seat belts	60
Seat belt pretensioners	61
Buckling and unbuckling seat belts	62
Door and seat belt reminders	64
Airbag system	65
Driver/passenger side airbags	66
Occupant weight sensor	69
Side impact airbags	72
Inflatable curtains	73
Safety mode	74
Starting or moving a vehicle in safety mode	74
Child safety	75
Child restraints	77
Infant seats	79
Convertible seats	81
Booster cushions	83
ISOFIX/LATCH lower anchors	84
Lower child seat attachment points	85



Top tether anchors	86
Integrated booster cushion*	87
Raising the integrated booster cushion*	89
Stowing the integrated booster cushion*	90

## INSTRUMENTS AND CONTROLS

Instruments and controls	94	Voice control	119
Trip computer	95	Using voice commands	119
Displaying trip computer information	96	Voice control for cell phones	120
Displaying trip statistics	97	Voice control for radio and media	121
HomeLink® Wireless Control System*	98	Climate system voice commands	122
Programming the HomeLink® Wireless Control System*	99	Navigation system voice commands	123
Adjusting the power door mirrors	102	Voice control settings	124
Laminated panoramic roof*	103	Instrument panel	124
Operating the laminated panoramic roof*	104	Instrument panel settings	126
Power windows	107	Indicator symbols in the instrument panel	127
Operating the power windows	107	Instrument panel licenses	130
Rearview mirror	108	Warning symbols in the instrument panel	135
Using sun curtains*	109	Compass	136
Settings view	109	Calibrating the compass	137
Categories in Settings view	110	Lighting panel and controls	138
Changing system settings in Settings view	112	Parking lights	140
Changing settings in apps	113	Daytime Running Lights (DRL)	140
Resetting the settings view	113	Low beam headlights	141
Resetting user data when the vehicle changes owners	114	High and low beam headlights	142
Ambient temperature sensor	114	Active Bending Lights*	143
Clock	115	Front fog lights*	144
Head-up display (HUD)*	116	Rear fog lights (certain models only)	145
		Brake lights	146
		Hazard warning flashers	146

Using turn signals	146
Passenger compartment lighting	147
Home safe lighting	150
Approach lighting	150
Messages in the instrument panel and center display	150
Handling messages in the instrument panel and center display	152
Handling messages stored from the instrument panel and center display	154
Instrument panel App menu	155
Using the instrument panel App menu	156
Using the windshield wipers	157
Activating/deactivating the rain sensor	157
Windshield and headlight washers	158
Tailgate window wiper and washer	159
Steering wheel	160
Adjusting the steering wheel	161
Seats	162
Manually operated front seats	162
Power front seats*	163
Adjusting power front seats*	163
Adjusting the passenger's seat from the driver's seat*	164
Using the power seat memory function*	165
Multifunctional front seats*	166

Adjusting function settings in the multifunctional front seats*	166
Rear seats	169
Adjusting the second row head restraints	170
Moving the second row seats forward/rearward	171
Adjusting the second row backrest tilt	172
Folding the second row backrests	173
Getting into and out of the third row of seats	174
Folding the third row* backrests	175
Driver profiles	175
Selecting a driver profile	176
Editing a driver profile	177
Linking a remote key to a driver profile	177
Importing/exporting a driver profile from/to a USB flash drive	178

## CLIMATE

Climate control system	182
Perceived temperature	182
Climate system sensors	183
Air quality	183
Clean Zone Interior Package (CZIP)*	184
Interior Air Quality System (IAQS)*	185
Passenger compartment air filter	185
Automatic climate control	186
Climate system controls	186
Climate system controls in the center display	187
Rear climate system controls on the tunnel console*	189
Setting the blower speed	190
Setting the temperature	191
Turning recirculation on and off	194
Defrosting windows and mirrors	194
Turning steering wheel heating* on and off	197
Air conditioning	197
Turning seat heating* on and off	198
Turning front seat ventilation* on and off	200
Air distribution	201
Opening/closing/directing air vents	202
Adjusting air distribution	202

Air distribution table

204

## LOADING AND STORAGE

Cargo space	208
Loading	208
Passenger compartment storage spaces	210
Using the glove compartment	211
Tunnel console	212
Grocery bag holder	213
Cargo net	213
Steel cargo grid*	215
Load anchoring eyelets	216
Cargo compartment cover*	217
Sun visors	219
Electrical sockets	220

## LOCKS AND ALARM

Locks and remote keys	224
Immobilizer	224
Changing the remote key's battery	225
Remote key	227
Remote key's range	229
Red Key*	230
Detachable key blade	231
Foot movement tailgate operation*	232
Locking/unlocking from outside the vehicle	233
Locking/unlocking from inside the vehicle	235
Antenna locations for the start and lock system	236
Locking and unlocking confirmation	237
Locking/unlocking the tailgate	238
Power tailgate*	240
Private (valet) locking	242
Locking/unlocking with the detachable key blade	243
Automatically arming/disarming the alarm	244
Alarm	245
Deactivating the alarm without a functioning remote key	246
Child safety locks	246

Start and lock system type designations 248

## DRIVER SUPPORT

Driver support systems	250	Switching between Cruise Control and Adaptive Cruise Control*	266
Adjustable steering force*	250	Distance Alert*	267
Electronic Stability Control (ESC)	251	Using Distance Alert*	268
Electronic Stability Control (ESC) sport mode	252	Distance Alert* limitations	269
Electronic Stability Control (ESC) symbols and messages	253	Adaptive Cruise Control (ACC)*	269
Roll stability control (RSC)	255	Starting and activating Adaptive Cruise Control (ACC)*	272
Speed limiter (SL)*	255	Deactivating/resuming Adaptive Cruise Control (ACC)	273
Starting and activating the Speed Limiter (SL)*	256	Changing Adaptive Cruise Control (ACC) speed	275
Changing a Speed Limiter (SL)* maximum speed	257	Setting an Adaptive Cruise Control time interval	276
Automatic Speed Limiter (ASL)*	257	Passing Assistance with Adaptive Cruise Control or Pilot Assist	277
Activating/deactivating the Automatic Speed Limiter (ASL)*	259	Changing target vehicles and automatic braking with Adaptive Cruise Control (ACC)	277
Changing tolerance for the Automatic Speed Limiter	259	Adaptive Cruise Control (ACC) - troubleshooting	279
Deactivating/reactivating the Speed Limiter*	260	Adaptive Cruise Control (ACC) - limitations	280
Turning the Speed Limiter* off	261	Adaptive Cruise Control (ACC) symbols and messages	281
Cruise Control (CC)	262	Pilot Assist*	283
Starting and activating Cruise Control	262	Starting and activating Pilot Assist	286
Changing Cruise Control speed	263	Changing Pilot Assist speed	288
Deactivating/resuming Cruise Control (CC)	264		
Turning Cruise Control off	265		

Setting a Pilot Assist time interval	289	Activating/deactivating Cross Traffic Alert (CTA)*	320	Starting the Park Assist Camera (PAC)*	344
Deactivating/resuming Pilot Assist	290	Cross Traffic Alert (CTA)* limitations	321	Park Assist Camera* (PAC) limitations	345
Changing target vehicles and automatic braking with Pilot Assist	292	Blind Spot Information (BLIS)* with Cross Traffic Alert (CTA)* symbols and messages	323	Park Assist Pilot (PAP)*	346
Pilot Assist limitations	293	Road Sign Information (RSI)*	324	Using Park Assist Pilot (PAP)*	347
Pilot Assist symbols and messages	295	Road Sign Information (RSI)* operation	324	Park Assist Pilot (PAP)* limitations	350
Driver support system radar sensor	296	Road Sign Information (RSI)* limitations	326	Park Assist Pilot (PAP)* symbols and messages	352
Radar sensor limitations	297	Driver Alert Control (DAC)	326		
Radar sensor - type approval	300	Using Driver Alert Control (DAC)	327		
Driver support system camera	300	Driver Alert Control limitations	328		
Camera limitations	301	Driving lane assistance	328		
City Safety™	304	Activating/deactivating Lane Keeping Aid (LKA)	330		
City Safety warning level settings	306	Driving lane assistance symbols and messages	331		
Detecting obstructions with City Safety	307	Run-off Mitigation	333		
City Safety in crossing traffic	309	Run-off Mitigation* symbols and messages	335		
City Safety when evasive action is not possible	310	Park Assist*	336		
City Safety™ troubleshooting	310	Activating/deactivating Park Assist	337		
City Safety limitations	312	Park Assist limitations	338		
City Safety symbols and messages	315	Park assist symbols and messages	339		
Rear Collision Warning (RCW)	316	Park Assist Camera (PAC)*	340		
Blind Spot Information (BLIS)*	317	Park Assist Camera (PAC)* trajectory lines and fields	342		
Blind Spot Information (BLIS)* On/Off	318				
Blind Spot Information (BLIS)* limitations	319				
Cross Traffic Alert (CTA)*	319				

## STARTING AND DRIVING

Starting and driving	354
Brakes	354
Brake functions	356
Auto-hold brake function	356
Brake assist system	357
Braking effect after a collision	357
Emergency brake lights	358
Hill Descent Control (HDC)	358
Low Speed Control (LSC)*	359
Hill Start Assist	360
Parking brake	360
Using the parking brake	361
Parking brake malfunctions	363
Before a long distance trip	363
Driving economically	364
Driving through standing water	365
Overheating the engine and transmission	366
Winter driving	367
Towing eyelet	367
Towing recommendations	369
Fuel	371
Octane rating	372
Opening/closing the fuel filler door	373
Emission controls	374

Jump starting	374
Driving with a trailer	376
Detachable trailer hitch*	378
Trailer Stability Assist (TSA)	379
Ignition modes	380
Battery drain	382
Starting the engine	382
Turning the engine off	384
Drive modes*	384
ECO drive mode	387
Start/Stop	389
Using the Start/Stop function	389
Conditions for Start/Stop	391
Automatic transmission	392
Shiftlock	393
Gear shift indicator	394
Gear selector positions	394
Steering wheel paddles*	396
All Wheel Drive (AWD)	397
Leveling control* and suspension	398

## INFOTAINMENT

The infotainment system	402
Apps (applications)	402
Sound settings	403
Radio	404
Radio settings	404
RBDS radio	405
Changing and searching for radio stations	405
HD Radio™ reception	406
Switching HD Radio on and off	408
HD Radio sub-channels	408
HD Radio limitations	409
SiriusXM® Satellite radio*	410
Using SiriusXM® Satellite radio*	411
SiriusXM® Satellite radio* settings	412
SiriusXM Travel Link*	413
SiriusXM Travel Link - Weather	415
SiriusXM Travel Link - Alerts	416
SiriusXM Travel Link - Fuel	417
SiriusXM Travel Link - Sports	418
Phone	419
Pairing a cell phone	420
Connecting/disconnecting a cell phone	421
Handling phone calls	422

Managing the phone book	423
Handling text messages	424
Phone settings	425
Text message settings	426
Connecting a Bluetooth® device	426
Connecting a device via the AUX/USB socket	426
Media player	427
Apple CarPlay	428
Apple CarPlay settings	429
Android auto*	430
Android Auto* settings	431
CD (media) player*	432
Playing media	432
Media searches	434
Playing media through the AUX/USB sockets	435
Streaming media through a Bluetooth connection	435
Media sound settings	436
Gracenote	436
Video	437
Media player technical data	437
Internet connected vehicle	439
Connecting to the Internet	439

Bluetooth settings	441
Downloading, updating and uninstalling apps	441
Internet connection troubleshooting	442
Tethering (Wi-Fi sharing)	443
Deleting Wi-Fi networks	444
Wi-Fi technology and security	444
Vehicle modem settings	444
Infotainment system license information	445
Terms, conditions and confidentiality	449

## WHEELS AND TIRES

Tires	452
Tire sidewall designations	454
Wheel (rim) designations	455
Tire terminology	456
Tire direction of rotation	457
Tread wear indicator	457
Loading specifications	458
Uniform Tire Quality Grading	459
Snow tires and chains	459
Checking tire inflation pressure	460
Changing tires	462
Tools	462
Jack	462
Spare tire	463
Wheel bolts	464
Removing a wheel	465
Installing a wheel	466
Tire Pressure Monitoring System (TPMS)	467
Checking tire inflation pressure	468
Reinflating tires equipped with the Tire Pressure Monitoring System (TPMS)	469
Calibrating the Tire Pressure Monitoring System (TPMS)	470
Tire sealing system	471
Using the tire sealing system	473

Inflating a tire with the tire sealing system compressor

477

## MAINTENANCE AND SERVICING

Volvo's service program	480	Engine compartment overview	515
System updates	482	Engine oil	516
Remote updates	483	Checking and refilling engine oil	517
Vehicle status	483	Windshield wipers in the service position	518
Booking service and repairs	484	Replacing wiper blades	519
Wi-Fi connection to a workshop	486	Refilling coolant	520
Climate system service	487	Refilling the windshield washer fluid reservoir	521
Start battery	488	Cleaning the exterior	522
Support battery	490	Cleaning the interior	525
Battery symbols	491	Cleaning the center display	527
Fuses	492	Corrosion protection	527
Replacing fuses	493	Paint damage	528
Fuses in the engine compartment	494	Touching up paint damage	529
Fuses in the passenger compartment	498	Polishing and waxing	529
Fuses in the cargo compartment	502		
Replacing bulbs	505		
Removing the rectangular headlight cover	507		
Replacing low beam headlight bulbs	508		
Replacing High Beam headlight bulbs	509		
Replacing front turn signal bulbs	509		
Replacing front parking light bulbs	510		
Bulb specifications	511		
Hoisting the vehicle	512		
Opening and closing the hood	514		



## **SPECIFICATIONS**

Label information	532
Dimensions	535
Weights	537
Air conditioning refrigerant	540
Brake fluid specification and volume	540
Coolant specifications	541
Engine specifications	542
Engine oil specifications and volume	544
Fuel tank volume	544
Tire inflation pressure table	545
Transmission fluid specification and volume	546

## **INDEX**

Index	547
-------	-----



# INTRODUCTION

## Contacting Volvo

Use the following contact information if you would like to get in touch with Volvo in the United States or Canada.

### In the USA:

Volvo Car USA, LLC  
Customer Care Center  
1 Volvo Drive,  
P.O. Box 914  
Rockleigh, New Jersey 07647  
1-800-458-1552  
www.volvocars.com/us

### In Canada:

Volvo Cars of Canada  
National Customer Service  
9130 Leslie Street, Suite 101  
Richmond Hill, Ontario L4B 0B9  
1-800-663-8255  
www.volvocars.com/ca

## Volvo On Call Roadside Assistance

Your new Volvo comes with a four year ON CALL roadside assistance.

Additional information, features, and benefits of this program are described in a separate information package in your glove compartment.

If you require assistance, dial:

**In the U.S.** 1-800-638-6586 (1-800-63-VOLVO)

**In Canada** 1-800-263-0475

### NOTE

Some vehicles may be equipped with **Volvo On Call with Sensus Connect**, which will allow access to the call center and additional features directly from the vehicle. This is in addition to the Volvo On Call Roadside Assistance program mentioned above.

**Volvo On Call with Sensus Connect** will be a customer pay subscription offer after an initial complimentary trial period.

## Additional information about your vehicle

Volvo Cars' website and support site provide additional information about your vehicle.

## Support on the Internet

Go to support.volvocars.com or use the QR code below to visit the site, which is available in most markets.



QR code to the support site

The information on the support site is searchable and is grouped into different categories. It includes support for e.g., Internet-based services and functions, Volvo On Call, the navigation system and apps. Video and step-by-step instructions explain various procedures such as how to connect the vehicle to the Internet via a cell phone.

## Downloadable information

### Maps

Sensus Navigation system maps can be downloaded from the support site.

### Mobile apps

Beginning with model year 2014, the owner's manual is available in the form of an app for certain Volvo models. The Volvo On Call app can also be found here.

### Owner's manuals for earlier model Volvos

Owner's manuals for earlier model Volvos are available in PDF format. Quick Guides and supplements can also be found on the support site. Select a model and a model year and download the desired information.

### Contact

Contact information for customer support and the nearest Volvo retailer are available on the site.

### Related information

- Using the owner's manual (p. 48)
- On-board digital owner's manual (p. 50)
- Volvo ID (p. 27)

### Volvo and the environment

Volvo is committed to the well-being of its customers. As a natural part of this commitment, we care about the environment in which we all live. Concern for the environment means an everyday involvement in reducing our environmental impact.

Volvo's environmental activities are based on a holistic view, which means we consider the overall environmental impact of a product throughout its complete life cycle. In this context, design, production, product use, and recycling are all important considerations. In production, Volvo has partly or completely phased out several chemicals including CFCs, lead chromates, asbestos, and cadmium; and reduced the number of chemicals used in our plants 50% since 1991.

Volvo was the first in the world to introduce into production a three-way catalytic converter with a Lambda sond, now called the heated oxygen sensor, in 1976. The current version of this highly efficient system reduces emissions of harmful substances (CO, HC, NO<sub>x</sub>) from the exhaust pipe by approximately 95 – 99% and the search to eliminate the remaining emissions continues. Volvo is the only automobile manufacturer to offer CFC-free retrofit kits for the air conditioning system of all models as far back as the 1975 model 240. Advanced electronic engine controls and cleaner fuels are bringing us closer to our goal. In addition to continuous environmental

refinement of conventional gasoline-powered internal combustion engines, Volvo is actively looking at advanced technology alternative-fuel vehicles.

When you drive a Volvo, you become our partner in the work to lessen the car's impact on the environment. To reduce your vehicle's environmental impact, you can:

- Maintain proper air pressure in your tires. Tests have shown decreased fuel economy with improperly inflated tires.
- Follow the recommended maintenance schedule in your Warranty and Service Records Information booklet.
- Drive at a constant speed whenever possible.
- See a trained and qualified Volvo service technician as soon as possible for inspection if the check engine (malfunction indicator) light illuminates, or stays on after the vehicle has started.
- Properly dispose of any vehicle-related waste such as used motor oil, used batteries, brake pads, etc.
- When cleaning your vehicle, please use genuine Volvo car care products. All Volvo car care products are formulated to be environmentally friendly.

### Related information

- Driving economically (p. 364)

## Owner's manual and the environment

The wood pulp in Volvo's printed owner's information comes from FSC® (Forest Stewardship Council®) certified forests and other responsible sources.

FSC®

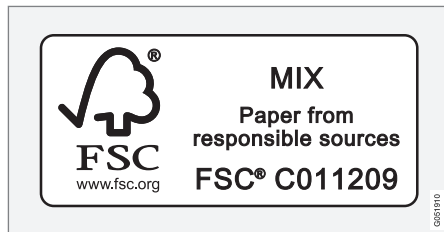

The symbol above indicates that the wood pulp is FSC® certified.

### Related information

- Volvo and the environment (p. 15)

## IntelliSafe—driver support

IntelliSafe is Volvo's philosophy regarding vehicle safety. It encompasses a number of systems, both standard and optional, that are designed to help make driving and traveling in a Volvo safer.

### Support

Systems that help make driving safer are an integral part of IntelliSafe. These include optional features such as Adaptive Cruise Control\* that helps maintain a set distance to a vehicle ahead, Park Assist Pilot\*, which assists in parking the vehicle, Cross Traffic Alert\*, Blind Spot Information\*, etc.

### Accident prevention

Systems such as City Safety are designed to automatically apply the brakes in situations in which the driver does not have time to react. Lane Keeping Aid\* alerts the driver if the vehicle inadvertently crosses a lane's/road's side marker line.

### Protection

The vehicle is equipped with e.g., seat belt pretensioners that pull the seat belts taut in critical situations when there is a collision risk and numerous airbags designed to help provide cushioning if certain types of collisions should occur.

### Related information

- Adaptive Cruise Control (ACC)\* (p. 269)
- Park Assist Pilot (PAP)\* (p. 346)

- High and low beam headlights (p. 142)
- Cross Traffic Alert (CTA)\* (p. 319)
- Blind Spot Information (BLIS)\* (p. 317)
- City Safety™ (p. 304)
- Driving lane assistance (p. 328)
- Airbag system (p. 65)
- Roll stability control (RSC) (p. 255)
- Seat belts (p. 60)
- General safety information (p. 56)

## Sensus

Sensus is the core of your personal Volvo experience and provides information, entertainment and features that make owning your vehicle easier.

### This is Sensus



Sensus provides an intelligent interface and Internet-connected service with an intuitive navigation structure that offers access to relevant information when it is needed, with minimal distractions.

Sensus also includes all of your vehicle's solutions relating to entertainment, connecting to the Internet, navigation and the user interface between the driver and the vehicle. Sensus makes communication between you, the vehicle and the digital world around you possible.

◀ Information when it's needed, where it's needed



Information is presented in different displays depending on how it should be prioritized (generic illustration)

**Head-up-display\***

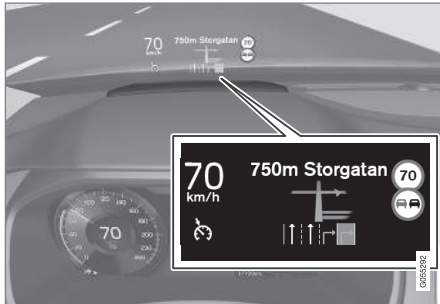

The head up-display presents types of information that the driver should be aware of immedi-

ately, such as traffic warnings, speed information and navigation. Road sign information and incoming phone calls are also displayed here. The head-up display is controlled from the right-side steering wheel keypad and the center display.

**Instrument panel**



12" instrument panel





8" instrument panel

The instrument panel displays information such as speed, an incoming phone call or the track that is currently playing. It is controlled using both steering wheel keypads.

### Center display



Many of the vehicle's main functions are controlled from the center display, a touchscreen that reacts to taps or other gestures. The number of physical buttons is thereby minimized. The screen can be operated with or without gloves.

The center display is used to control e.g., the climate and infotainment systems and to adjust the power seats\*. The information shown here can be dealt with by the driver or the front seat passenger.

### Voice control system



The voice control system enables the driver to operate certain vehicle functions without removing his/her hands from the steering wheel and it understands natural speech.

Use voice commands to e.g., play a track on the infotainment system, make a phone call, raise the passenger compartment temperature or to read a text message.

For additional information about all of the functions/system, see the respective articles in the on-board owner's manual or the printed supplement.

### Related information

- Using the center display (p. 44)
- Center display overview (p. 28)
- Navigating in the center display's views (p. 38)

- Head-up display (HUD)\* (p. 116)
- Instrument panel (p. 124)
- Voice control (p. 119)

## Owner's manual in mobile devices

Owner's information mobile app<sup>1</sup> can be downloaded from the App Store and Google Play and is adapted for both cell phones and tablets. These apps also contain videos and interior/exterior hotspot views of the vehicle that you can click on for additional information.



This QR code will take you directly to the app or you can search for "Volvo manual" in the App Store or Google Play.

The app contains videos and exterior/interior views of the vehicle with certain components/functions highlighted in hotspots, which lead directly to related information. It is easy to navigate between the various categories and articles and the contents are searchable.

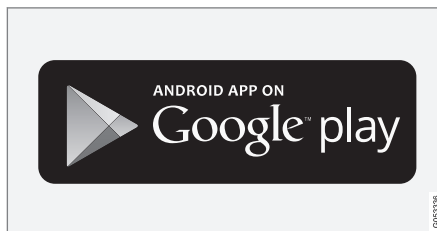
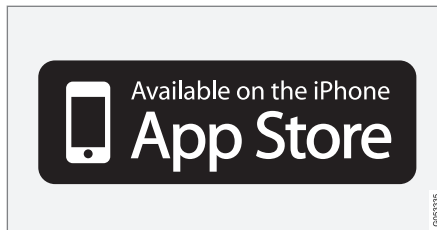

The mobile app is available at the App Store and Google Play

## Related information

- Using the owner's manual (p. 48)
- Additional information about your vehicle (p. 14)

<sup>1</sup> Certain models and mobile devices

## Options, accessories and the On-board Diagnostic (OBDII) socket

We strongly recommend that Volvo owners install only genuine, Volvo-approved accessories, and that accessory installations be performed only by a trained and qualified Volvo service technician.

Optional or accessory equipment described in this manual is indicated by an asterisk.

Optional or accessory equipment may not be available in all countries or markets. Please note that some vehicles may be equipped differently, depending on special legal requirements.

Contact your Volvo retailer for additional information.

### NOTE

- Do not export your Volvo to another country before investigating that country's applicable safety and exhaust emission requirements. In some cases it may be difficult or impossible to comply with these requirements. Modifications to the emission control system(s) may render your Volvo not certifiable for legal operation in the U.S., Canada and other countries.
- All information, illustrations and specifications contained in this manual are based on the latest product information available at the time of publication. Please note that some vehicles may be equipped differently, depending on market-specific adaptations or special legal requirements. Optional equipment described in this manual may not be available in all markets.
- Some of the illustrations shown are generic and are intended as examples only, and may not depict the exact model for which this owner's information is intended.
- Volvo reserves the right to make model and product changes at any time, or to change specifications or design without notice and without incurring obligation.

### WARNING

If your vehicle is involved in an accident, unseen damage may affect its drivability and safety.

### WARNING

#### CALIFORNIA proposition 65

Engine exhaust, some of its constituents, and certain vehicle components contain or emit chemicals known to the state of California to cause cancer, and birth defects or other reproductive harm. In addition, certain fluids contained in vehicles and certain products of component wear contain or emit chemicals known to the State of California to cause cancer, and birth defects or other reproductive harm.

### WARNING

Certain components of this vehicle such as air bag modules, seat belt pretensioners, adaptive steering columns, and button cell batteries may contain Perchlorate material. Special handling may apply for service or vehicle end of life disposal.

See [www.dtsc.ca.gov/hazardouswaste/perchlorate](http://www.dtsc.ca.gov/hazardouswaste/perchlorate).

- Genuine Volvo accessories are tested to ensure compatibility with the performance, safety, and emission systems in your vehicle.





Additionally, a trained and qualified Volvo service technician knows where accessories may and may not be safely installed in your Volvo. In all cases, please consult a trained and qualified Volvo service technician before installing any accessory in or on your vehicle.

- Accessories that have not been approved by Volvo may or may not be specifically tested for compatibility with your vehicle. Additionally, an inexperienced installer may not be familiar with some of your car's systems.
- Any of your car's performance and safety systems could be adversely affected if you install accessories that Volvo has not tested, or if you allow accessories to be installed by someone unfamiliar with your vehicle.
- Damage caused by unapproved or improperly installed accessories may not be covered by your new vehicle warranty. See your Warranty and Service Records Information booklet for more warranty information. Volvo assumes no responsibility for death, injury, or expenses that may result from the installation of non-genuine accessories.

### Connecting equipment to the On-board Diagnostic (OBDII) socket

#### **WARNING**

Volvo Cars takes no responsibility for the consequences of connecting non-authorized equipment to the On-board Diagnostic (OBDII) socket. This socket should only be used by a trained and qualified Volvo service technician.

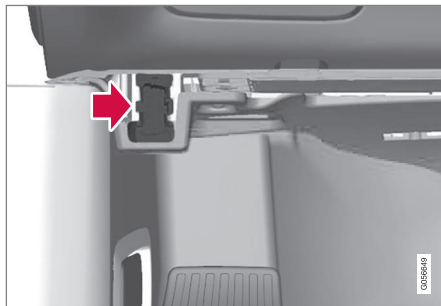

The diagnostic socket OBDII under the dashboard on the driver's side

#### **Type approval USA**

FCC ID: 2AGKKACUII-06

This device complies with Part 15 of the FCC rules. Operation is subject to the following two conditions:

(1) This device may not cause harmful interference, and

(2) this device must accept any interference received, including interference that may cause undesired operation.

#### **WARNING**

Changes or modifications not expressly approved by the party responsible for compliance could void the user's authority to operate the equipment.

#### **Canada**

IC: 20839-ACUII06

This device complies with Industry Canada licence-exempt RSS standard(s). Operation is subject to the following two conditions:

(1) this device may not cause interference, and

(2) This device must accept any interference received, including interference that may cause undesired operation.

## Finding owner's information

Owner's information is available in several different formats in both digital and printed form. The owner's manual is available on the vehicle's center display, as a mobile app and on Volvo's support website.

There is also a Quick Guide in the glove compartment as well as a printed supplement to the owner's manual containing information about e.g., fuses, specifications, etc. A complete printed owner's manual can also be ordered.

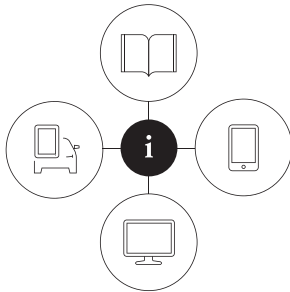

000000

## The vehicle's center display



In the center display, pull down Top view and tap **Owner's manual**. This gives you access to visual navigation with exterior and interior images of the vehicle. The information is searchable and is divided into categories.

ries.

## Mobile app

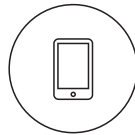

In App Store or Google Play, search for "Volvo Manual." Download the app to a smartphone or tablet and select a vehicle model. The app contains instructive videos and offers visual navigation, including

interior and exterior images of the vehicle. Navigation between the various articles in the owner's manual is designed to provide easy access to the information and the information is searchable.

## Volvo Cars' support site



Go to [support.volvocars.com](http://support.volvocars.com) and select your country. Owner's manuals are available here online and in PDF format. Volvo Car's support site also contains instructional videos and additional information

about your vehicle and owning a Volvo.

## Printed owner's information



The glove compartment contains a printed supplement to the owner's manual containing information about fuses and specifications as well as a summary of other important and practical information.

A printed Quick Guide can also be found in the glove compartment containing useful information about the most commonly used features and functions in your vehicle.

Other printed owner's information may also be found in the vehicle, depending on options and/or accessories that the vehicle is equipped with.

A complete printed version of the owner's information (or a new owner's manual supplement) can be ordered through a Volvo retailer.

### **i** NOTE

If the content of the digital information in the center display and the printed information differ, the printed information always has precedence.



## WARNING

The driver is always responsible for operating the vehicle in a safe manner and adhering to current laws and traffic regulations.

It is also important that the vehicle be operated, maintained and serviced according to Volvo's recommendations/instructions in the owner's manual.

### Changing the language used in the vehicle's center display

Changing languages in the center display could mean that some of the owner's information provided may not comply with national or local statutes and regulations. Changing to a language that you do not understand may also make it difficult to change back to the original language.

#### Related information

- Owner's manual in mobile devices (p. 20)
- Navigating in the digital owner's manual (p. 51)
- On-board digital owner's manual (p. 50)
- Navigating in the digital owner's manual (p. 51)
- Using the owner's manual (p. 48)
- Additional information about your vehicle (p. 14)

## Driver distraction

Please keep the following warnings in mind when operating/servicing your vehicle.

A driver has a responsibility to do everything possible to ensure his or her own safety and the safety of passengers in the vehicle and others sharing the roadway. Avoiding distractions is part of that responsibility.

Driver distraction results from driver activities that are not directly related to controlling the vehicle in the driving environment. Your new Volvo is, or can be, equipped with many feature-rich entertainment and communication systems. These include hands-free cellular telephones, navigation systems, and multipurpose audio systems. You may also own other portable electronic devices for your own convenience. When used properly and safely, they enrich the driving experience. Improperly used, any of these could cause a distraction.

For all of these systems, we want to provide the following warning that reflects the strong Volvo concern for your safety. Never use these devices or any feature of your vehicle in a way that distracts you from the task of driving safely. Distraction can lead to a serious accident. In addition to this general warning, we offer the following guidance regarding specific newer features that may be found in your vehicle:

## WARNING

- Never use a hand-held cellular telephone while driving. Some jurisdictions prohibit cellular telephone use by a driver while the vehicle is moving.
- If your vehicle is equipped with a navigation system, set and make changes to your travel itinerary only with the vehicle parked.
- Never program your audio system while the vehicle is moving. Program radio presets with the vehicle parked, and use your programmed presets to make radio use quicker and simpler.
- Never use portable computers or personal digital assistants while the vehicle is moving.

### Accessory installation

- We strongly recommend that Volvo owners install only genuine, Volvo-approved accessories, and that accessory installations be performed only by a trained and qualified Volvo service technician.
- Genuine Volvo accessories are tested to ensure compatibility with the performance, safety, and emission systems in your vehicle. Additionally, a trained and qualified Volvo service technician knows where accessories may and may not be safely installed in your Volvo. In all cases, please consult a trained

and qualified Volvo service technician before installing any accessory in or on your vehicle.

- Accessories that have not been approved by Volvo may or may not be specifically tested for compatibility with your vehicle. Additionally, an inexperienced installer may not be familiar with some of your car's systems.
- Any of your car's performance and safety systems could be adversely affected if you install accessories that Volvo has not tested, or if you allow accessories to be installed by someone unfamiliar with your vehicle.
- Damage caused by unapproved or improperly installed accessories may not be covered by your new vehicle warranty. See your Warranty and Service Records Information booklet for more warranty information. Volvo assumes no responsibility for death, injury, or expenses that may result from the installation of non-genuine accessories.

### **WARNING**

The driver is always responsible for operating the vehicle in a safe manner and for complying with current statutes and regulations.

It is also essential to maintain and service the vehicle according to Volvo's recommendations as stated in the owner's information and the service and warranty booklet.

If the on-board information differs from the printed owner's manual, the printed information always takes precedence.

### **Related information**

- Volvo Structural Parts Statement (p. 25)

## **Volvo Structural Parts Statement**

Volvo has always been and continues to be a leader in automotive safety.

Volvo engineers and manufactures vehicles designed to help protect vehicle occupants in the event of a collision.

Volvos are designed to absorb the impact of a collision. This energy absorption system including, but not limited to, structural components such as bumper reinforcement bars, bumper energy absorbers, frames, rails, fender aprons, A-pillars, B-pillars and body panels must work together to maintain cabin integrity and protect the vehicle occupants.

The supplemental restraint system including but not limited to air bags, side curtain air bags, and deployment sensors work together with the above components to provide proper timing for air bag deployment.

Due to the above, Volvo Car USA does not support the use of aftermarket, alternative or anything other than original Volvo parts for collision repair.

Volvo Car USA also recommends using Volvo-approved replacement glass. The use of aftermarket glass, particularly a windshield, can have an adverse effect on collision avoidance and advanced lighting systems.

In addition Volvo does not support the use or reuse of structural components from an existing



- ◀◀ vehicle that has been previously damaged. Although these parts may appear equivalent, it is difficult to tell if the parts have been previously replaced with non-OE parts or if the part has been damaged as a result of a prior collision. The quality of these used parts may also have been affected due to environmental exposure.

### Related information

- Crash event data (p. 26)
- Contacting Volvo (p. 14)

### Crash event data

This vehicle is equipped with an event data recorder (EDR). The main purpose of an EDR is to record, in certain crash or near crash-like situations, such as an air bag deployment or hitting a road obstacle, data that will assist in understanding how a vehicle's systems performed. The EDR is designed to record data related to vehicle dynamics and safety systems for a short period of time, typically 30 seconds or less. The EDR in this vehicle is designed to record such data as:

- How various systems in your vehicle were operating;
- Whether or not the driver and passenger safety belts were buckled/fastened;
- How far (if at all) the driver was depressing the accelerator and/or brake pedal; and,
- How fast the vehicle was traveling.

These data can help provide a better understanding of the circumstances in which crashes and injuries occur.

EDR data are recorded by your vehicle only if a non-trivial crash situation occurs; no data are recorded by the EDR under normal driving conditions and the EDR never registers who is driving the vehicle or the location of a crash or a near crash-like situation. However, other parties, such as law enforcement, could combine the EDR data with the type of personally identifying data rou-

tinely acquired during a crash investigation. To read data recorded by an EDR, special equipment is required, and access to the vehicle or the EDR is needed.

Furthermore, your vehicle is equipped with a number of computers whose task is to continuously control and monitor the vehicle's operation. They can also register some of this information during normal driving conditions, most importantly if they detect a fault relating to the vehicle's operation and functionality or upon activation of the vehicle's active safety systems (e.g. City Safety and the auto-brake function). Some of the registered information is required by technicians when carrying out service and maintenance to enable them to diagnose and rectify any faults that have occurred in the vehicle and to enable Volvo to fulfill legal and other regulatory requirements. Information thus registered in the vehicle is registered in the vehicle's computers until the vehicle is serviced or repaired. In addition to the above, the registered information may – on an aggregated basis – be used for research and product development purposes in order to continuously improve the safety and quality of Volvo vehicles.

For additional information, contact:

### In the United States

Volvo Car USA, LLC  
Customer Care Center  
1 Volvo Drive, P.O. box 914



Rockleigh, New Jersey 07647

1-800-458-1552

www.volvocars.com/us

### In Canada

Volvo Cars of Canada

National Customer Service

9130 Leslie Street

Richmond Hill, Ontario L4B 0B9

1-800-663-8255

www.volvocars.com/ca

## Volvo ID

A Volvo ID can be used to access a number of on-line services<sup>2</sup>

### Creating a Volvo ID

A Volvo ID can be created in two ways:

#### Using the Volvo ID app

1. If you have not already done so, download the Volvo ID app from the **Download Center**.
2. Start the app and register a personal email address.
3. Follow the instructions that will be sent automatically to this email address.
  - > A Volvo ID has now been created and has been automatically registered to the vehicle. The Volvo ID services available can now be used.

#### Using the Volvo On Call app

1. Download the latest version of the Volvo On Call app to your cell phone from e.g., the App Store, Windows Phone or Google Play.
2. Start the app and create a Volvo ID on the start page.
3. Register a personal email address and then follow the instructions that will be sent automatically to this address.

## Registering your Volvo ID to the vehicle

If your Volvo ID was created using the Volvo On Call mobile app, the ID has to be registered to the vehicle:

1. With the vehicle connected to the Internet, download the Volvo ID app from the **Download Center** in the center display's App view. See also the article "Downloading, updating and uninstalling apps."
2. Start the app and enter your Volvo ID.
3. Follow the instructions that will be sent automatically to the email address linked to your Volvo ID.
  - > Your Volvo ID is now registered to the vehicle and the Volvo ID services available can be used.

## Advantages of having a Volvo ID

- Only one user name and password are required to access online services.
- If you change a user name or password for one of the online service (e.g., Volvo On Call), it/they will also be automatically changed for the other services.

## Related information

- Downloading, updating and uninstalling apps (p. 441)
- Connecting to the Internet (p. 439)

<sup>2</sup> These services vary and may be subject to change. Consult your Volvo retailer.

## Center display overview

Many of the vehicle's functions are controlled from the center display.



Three of the center display's basic views. Swipe to the right/left to access the Function/App view (generic illustration)

- 1 Function view: vehicle functions can be activated/deactivated by tapping. Certain functions are called "trigger functions", which open settings windows, e.g., **Camera** and parking functions. Settings for the head-up display\* are also started from Function view but the actual interaction is controlled from the steering wheel keypad buttons and the instrument panel.
- 2 Home view: the initial view shown when the center display is started.
- 3 App (Application) view: shows apps that have been downloaded (third-party apps) as well as ones for integrated functions such as **FM radio**. Tap an icon to open the app.
- 4 Status bar: vehicle activities are shown at the top of the screen. Network/connection information is shown on the left side of the bar. Media-related information, the clock and information about background activities are shown to the right.
- 5 Top view: pull down the tab to open Top view. From here, you can access **Settings**, **Owner's manual** and stored messages.
- 6 Navigation: leads to map navigation. Tap the sub-view to expand it.
- 7 Media: the most recently used media-related apps. Tap the sub-view to expand it.
- 8 Phone: used to access phone-related functions. Tap the sub-view to expand it.

- 9 The extra sub-view: the most recently used apps/vehicle functions that do not belong in any of the other sub-views are listed here. Tap the sub-view to expand it.
- 10 Climate bar: information and direct access to settings such as temperature, seat heating\* and blower speed. Tap the symbol at the center of the Climate bar to open Climate view for additional settings.

### Related information

- Using the center display (p. 44)
- Function view buttons (p. 36)
- Symbols in the center display status bar (p. 43)
- Settings view (p. 109)
- Media player (p. 427)
- Phone (p. 419)
- Climate system controls in the center display (p. 187)
- Cleaning the center display (p. 527)

### Changing center display settings

The center display activates automatically when the driver's door is opened. Settings can be made for e.g., sounds, background and themes.

### Turning off or changing the volume of center display sounds

System sounds in the center display can be turned off or their volume can be changed:

1. Tap **Settings** in the center display's Top view.
2. Tap **Sound** → **System Volumes**.
3. Pull the control under **Screen Touch** to the desired level to change volume or turn off the sound for tapping the screen or **Keypad Touch**.

### Changing the screen's appearance (theme)

1. Tap **Settings** in the center display's Top view.
2. Tap **My Car** → **Displays** → **Display Themes**.
3. Select a theme, e.g., **Minimalistic** or **Chrome Rings**.

In addition, the settings: **Normal** and **Bright** can also be selected. For **Normal**, the screen's background is dark and the text is light. This is the default setting. If **Bright** is selected, the back-

ground will be light and the text will be dark, which can increase readability in strong ambient lighting.

These alternatives are always available and do not shift automatically according to changes in ambient lighting.

### Related information

- Using the center display (p. 44)
- Sensus (p. 17)
- Settings view (p. 109)
- Cleaning the center display (p. 527)

## Using the center display keyboard

A keyboard can be used on the center display to enter characters and search for e.g., destinations using the navigation system, adding contacts in phone book, etc. It is also possible to use handwriting on the screen.

## Entering text using the keyboard

The keyboard will only appear at the bottom of the center display in situations when it is possible to write on the screen.



Keyboard function buttons (the appearance may vary depending on language settings, context, etc.)

- 1 Field for possible search hits. The word changes as new letters are added. Scroll in the list using the left/right arrows. Tap a word to select it. The keyboard may not support all language selections, in which case this line on the screen will not be displayed.
- 2 The characters that can be entered are language-dependent (see point 7). Tap a character to enter it.

- 3 Several buttons (depending on the context for which the keyboard is being used) will be displayed here. In certain cases, it can be used to enter @, .com or to start a new line.
- 4 Press to hide the keyboard. In cases where this is not possible, the button will not be displayed.
- 5 Tap once to enter **one** uppercase letter. Double-tap for **Caps lock** (tap again to return to lowercase letters). Letters entered after the !, . and ? characters will automatically be uppercase. The first letter in the text field or in text fields intended for names, addresses or company names will also automatically be uppercase. The first letter in text fields intended for passwords, web addresses or email addresses will automatically be lowercase unless upper case is chosen.
- 6 Press to display the numbers that can be entered. When numbers are displayed, tap ABC to resume entering text or #\~ to enter special characters.
- 7 Tap to change the keyboard language (in this example, UK English is the selected language). The characters available will change according to the selected language (2). This button will only be displayed if several keyboard languages have been selected (see the section "Changing keyboard languages"

below). Tap to display a list of possible languages and tap a language to use it.

- 8 Tap to enter blank spaces.
- 9 Tap to erase one character at a time.
- 10 Tap to enable handwriting. See the section "Handwritten text" below.

Entering text and performing searches using the keyboard are done somewhat differently in the navigation system. See the section "Filtering destination search results" below.

Tap the button above the keyboard to confirm the text that has been entered (not shown in the illustration). This button's appearance differs depending on the context.

### Changing keyboard languages

In order to change keyboard languages, they must first be selected under **Settings**.

The keyboard language can be changed without changing the language used for the other systems/menus in the vehicle.

1. Pull down the center display's Top view and tap **Settings**.
2. Tap **System** → **Keyboard Layouts**.

3. Select and one or more of the languages in the list.
  - > This makes it possible to change the keyboard layout and characters available depending on the language(s) selected.



When more than one language has been selected, this button (7)<sup>3</sup> will appear on the keyboard.

To shift between keyboard languages:

1. Press and hold the button (7).
  - > A list will be displayed.
2. Tap the desired language. If more than four languages have been selected in **Settings**, scroll in the list.
  - > The keyboard layout and characters available will change to the selected language.

<sup>3</sup> In the example illustration, the button shows "UK".

## ◀ Special characters

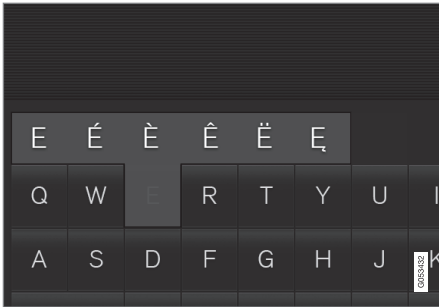

To enter language-specific characters such as **é** or **è** (if available):

1. Press and hold a character key.  
> A box with available characters will open.
2. Tap the desired character. If none of the special characters is selected, the key's initial character will be entered.

### Handwritten text

Tap button (10), see the overview illustration above, to enter the handwriting mode.

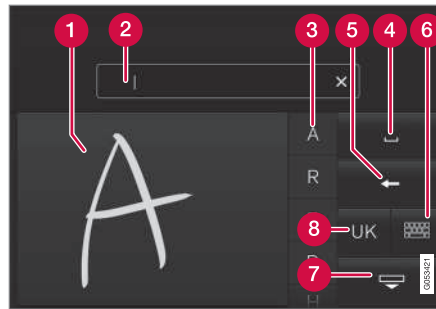

- 1 Area for entering characters.
- 2 Text box where the characters entered in area (1) appear.
- 3 Suggested characters. Scroll in the list if necessary.
- 4 Blank spaces.
- 5 Tap to erase one character at a time.
- 6 Tap to return to the standard keyboard.
- 7 Press to hide the keyboard. In cases where this is not possible, the button will not be displayed.
- 8 Tap to change the keyboard language.

### Entering characters

1. Enter a handwritten character (1) using a fingertip or by holding e.g., a pen near the screen.  
> Several character suggestions will appear (3). The most likely character will be at the top of the list.

#### **!** CAUTION

Do not touch the screen with sharp objects because this could cause scratches.

2. Continue entering characters.  
> If no other choice is made, the character at the top of the list will be used. Tap one of the other characters in the list to use it instead.



### Erasing/changing handwritten characters

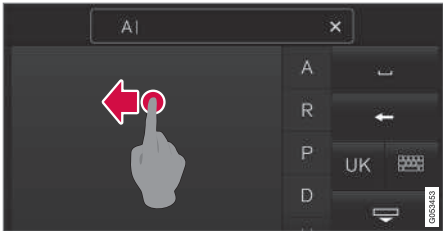

Erase a character by swiping over the handwriting area (1)

Characters can be erased/changed in several ways:

- Tap the desired character in the list (3).
- Tap button (5) to erase the character and start again.
- Sweep horizontally from right to left over the handwriting area (1). Erase several characters by swiping over the area several times.
- Tap the "x" in the text box (2) to delete all characters.

### New lines



Create a new line by drawing above the characters as shown in the illustration

### Related information

- Using the center display (p. 44)
- Center display overview (p. 28)
- Navigating in the center display's views (p. 38)

### Function view buttons

The Function view, which is one of the center display's basic views, contains all of the vehicle's

on-screen function buttons. From the Home view, swipe from left to right on the screen to come to the Function view.

### Different types of buttons

There are three different types of vehicle function buttons as listed in the following table.

Type of button	Functions	Vehicle function affected
Function buttons	Have On/Off modes. An LED indicator light to the left of the button's icon will illuminate when a function is active. Press the button to turn the function on or off.	Most of the buttons in the function view are function buttons.
Start buttons	Do not have On/Off modes. Pressing a start button opens a function's window, e.g., a window for adjusting the driver's seat.	<ul style="list-style-type: none"> <li>● <b>Camera.</b></li> <li>● <b>Headrest fold.</b></li> <li>● Functions for folding down a seat.</li> <li>● <b>Head-up display adjustments.</b></li> </ul>
Parking buttons	Have On/Off and scanning modes. Similar to function buttons but have an additional parking scanning mode.	<ul style="list-style-type: none"> <li>● <b>Park In.</b></li> <li>● <b>Park Out.</b></li> </ul>

### Button modes

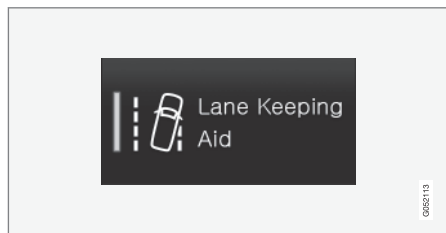

A function is activated (on) when the LED indicator is green

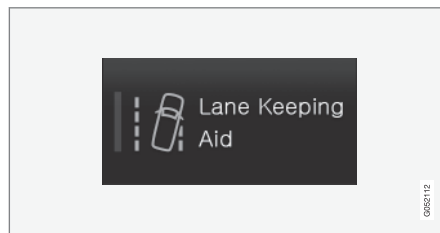

A function is deactivated (off) when the LED indicator is off

When a function or parking button's LED indicator is green, the function is activated. When a function is initially activated, an additional text will be displayed (certain functions only) in the button for approx. 5 seconds, after which the button will be displayed with the LED indicator illuminated.

Press the button briefly to deactivate the function.

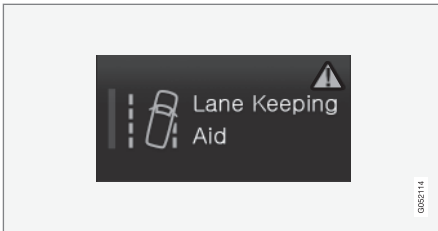

The yellow triangle indicates that the function is not working correctly

### Related information

- Center display overview (p. 28)
- Navigating in the center display's views (p. 38)
- Categories in Settings view (p. 110)

## Navigating in the center display's views

There are 5 different basic views in the center display: Home view, Top view, Climate view, App view and Function view. The display is activated automatically when the driver's door is opened.

### Home view

Home view is displayed when the screen is activated. It consists of four sub-views: **Navigation**, **Media**, **Phone** and an extra sub-view. The extra

sub-view contains the most recently used app/vehicle function that is not related to the other three sub-views. For example, if the most recently used app/vehicle function is a music app, the **Media** sub-view will be displayed.

The sub-views display brief information about the respective apps.

The first time the vehicle is started, some of the Home view's sub-views will not contain any information.

 <b>NOTE</b>
<ul style="list-style-type: none"><li>• In Home view's standard mode (reached by pressing the Home button briefly), an animation explaining how to access the different views will be shown on the screen.</li><li>• Some functions may be disabled when the vehicle is moving.</li></ul>

## Expanding/minimizing a sub-view

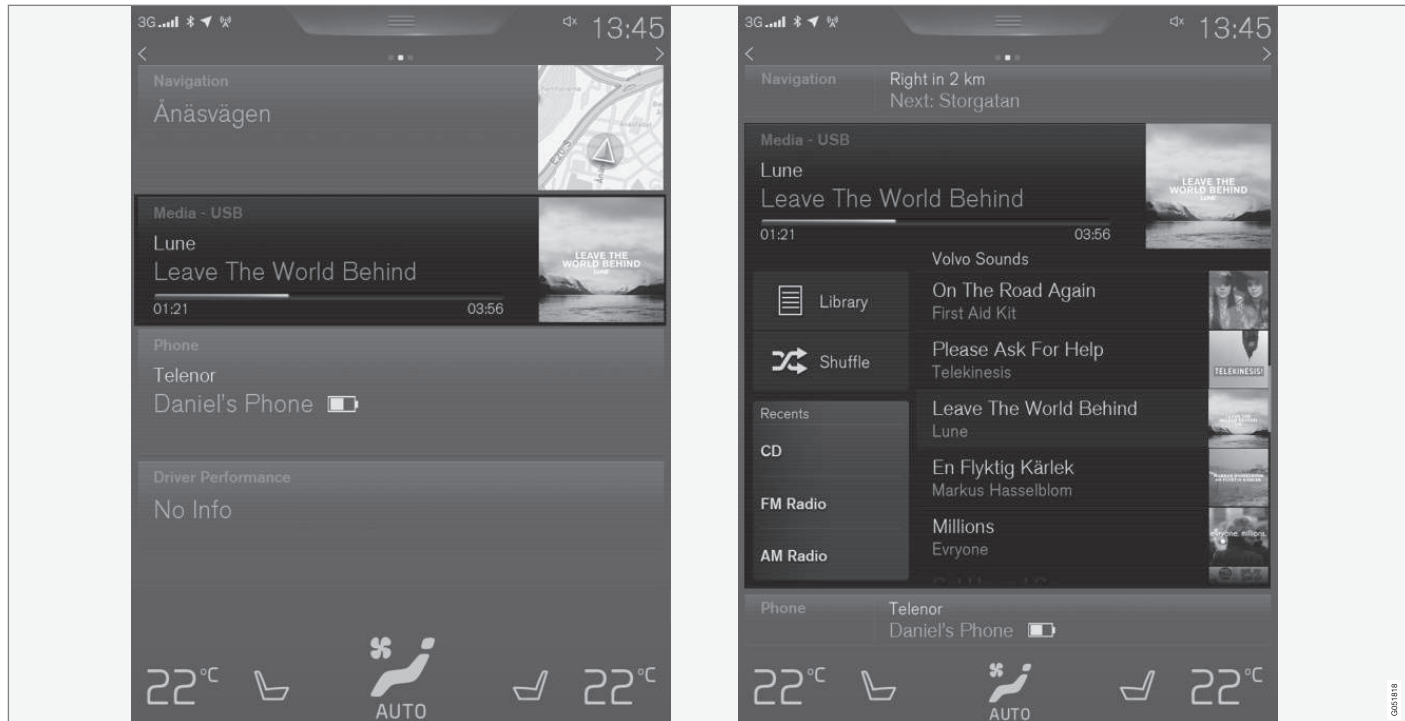

The Media sub-view shown minimized (left) and expanded (right)

- To expand a sub-view, tap the screen anywhere in the sub-view to access the respec-

◀◀ tive app's basic functions. When a sub-view is expanded, the Home view's fourth sub-view will temporarily not be displayed.

- To minimize a sub-view, tap anywhere on the screen.

### Opening/closing a sub-view in full-screen mode

The extra sub-view and the **Navigation** sub-view can be opened in full-screen mode to show additional information and possible settings.



In expanded mode, open the app in full-screen mode by tapping the symbol.



Tap on the symbol or the Home button below the screen to return to the expanded view.

It is always possible to return to Home view by pressing the Home button. Press the Home button **twice** to return to Home view's standard view from full-screen.



Home button for the center display

### Status bar

Current vehicle activities are shown in the status bar at the top of the screen. Network and connection information is shown to the left. Brief information about currently running apps and the clock are shown to the right.

### Top view

The top view has a tab at the center of the status bar. Pull down (expand) the Top view by swiping the tab downward.

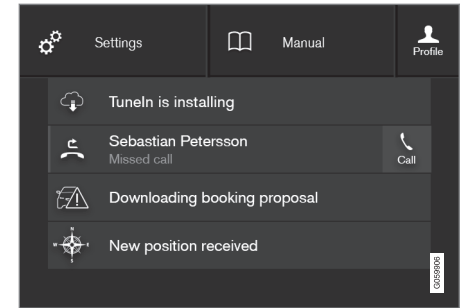

Top view when expanded

Top view provides access to:

- **Settings**
- **Owner's manual**
- **Profile**
- The vehicle's stored messages

To leave (minimize) Top view, tap the screen outside of this view or tap at the bottom of Top view and swipe upward. The views behind will become visible again. Top view is not available when the ignition is being started/switched off or when a message is displayed on the screen.

### Going to Top view from an app

To pull down Top view when an app is running (e.g., FM radio):

- Tap **FM Radio Settings** to display these settings.
- Tap **Owner's manual** to open an article related to the specific app.

**This applies only to your vehicle's factory-installed apps.** This is not possible for third-party apps that have been downloaded.

### Climate view

The climate bar, where the most common climate system settings can be made, is located at the bottom of the screen and is always visible.



Tap the symbol at the center of the climate bar to open Climate view for access to additional climate system settings.



Tap the symbol to close Climate view and return to a previous view.

### App view

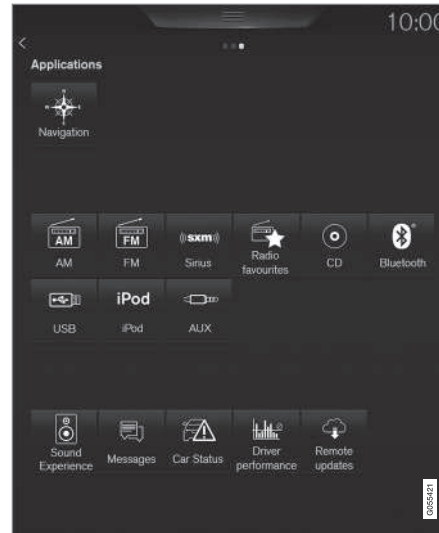

App view (generic illustration)

Swipe the screen from right to left to access App view from Home view. This displays factory-installed apps such as **FM** as well as any apps that have been downloaded. Brief information will be displayed for certain apps, for example missed phone calls, etc.

Tap an app to open it.

When applicable, swipe downward to scroll in the list of apps (depending on the number of apps currently running).

To move an app, press and hold it. It will become slightly bigger and transparent and can then be dragged to the desired position and released.

Return to Home view by swiping the screen from left to right or by pressing the Home button.

### Function view

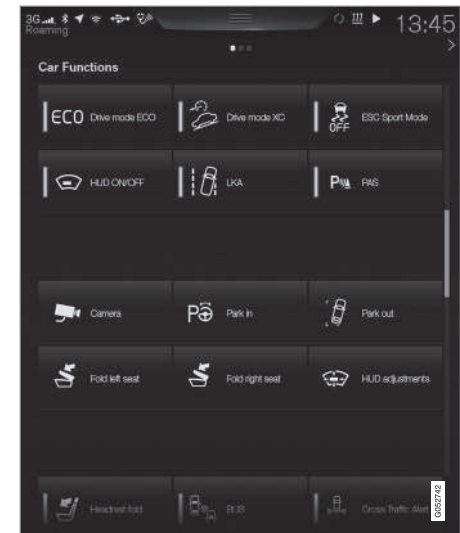

Function view (generic illustration)

## INTRODUCTION

- ◀◀ Swipe the screen from left to right to access Function view from Home view. From Function view, you can activate/deactivate various vehicle functions such as **Drive Modes**, **Speed Sign Assist** and **Park Assist**.

When applicable, swipe upward to scroll in the list of functions (depending on the number of functions).

Activate/deactivate a function by tapping its button. Certain functions will open in their own windows.

To move a function button, press and hold it. It will become slightly smaller and transparent and can then be dragged to the desired position and released.

### Related information









- Using the center display (p. 44)
- Center display overview (p. 28)
- Function view buttons (p. 36)
- Symbols in the center display status bar (p. 43)
- Changing settings in different types of apps (p. 43)
- Climate system controls (p. 186)











## Symbols in the center display status bar

The following table provides an overview of the symbols used in the center display's status bar.

The status bar shows current vehicle activities and in certain cases, also their status. Due to limited space in the status bar, not all symbols will be displayed at all times.

Symbol	Meaning
	Roaming activated.
	Cell phone network signal strength.
	Bluetooth device connected.
	Bluetooth activated but no device connected.
	Connected to a Wi-Fi network.
	Tethering activated. (Wi-Fi hotspot).
	Vehicle modem activated.
	Remote diagnostics active.
	Action in progress.

Symbol	Meaning
	Preconditioning <sup>A</sup> in progress.
	Audio source being played.
	Audio source paused.
	Phone call in progress.
	Audio source muted.
	News broadcasts from current radio station <sup>B</sup> .
	Traffic information being received <sup>B</sup> .
	Clock.

<sup>A</sup> Hybrid models only.

<sup>B</sup> Not available in all markets.

### Related information

- Navigating in the center display's views (p. 38)
- Indicator symbols in the instrument panel (p. 127)
- Warning symbols in the instrument panel (p. 135)
- Messages in the instrument panel and center display (p. 150)

## Changing settings in different types of apps

App view, which is one of the center display's basic views, contains all of the vehicle's apps (applications/programs). Access this view by swiping the screen from right to left.

### Basic apps

A number of apps are standard and are part of Volvo Sensus, such as **FM Radio**, **USB** and **CD**.

To change settings in a basic app:

1. Open the app, for example **Phone**, either on the home screen or full-screen from App view.
2. Pull down Top view.
3. Tap **Phone settings**.
4. Change the desired settings and confirm.
5. Press the Home button, tap the screen outside of Top view or pull Top view up.

### Third-party apps

Third party apps have to be selected and downloaded. In these apps, setting are made from within the app, not from Top view.

### Using the center display

Many of the vehicle's functions can be controlled and settings can be made from the screen in the center console, referred to in this owner's information as the center display, which is a touchscreen.



### Using the center display's touchscreen functionality





Two people can interact with the screen at the same time, e.g., to adjust the temperature for the driver and passenger sides.

The screen reacts differently depending on whether the user taps, drags or swipes on the screen. This makes it possible to move between views, mark objects, scroll in lists and move apps by touching the screen in various ways. The following table lists the gestures that can be used on the screen:

An infrared film on the screen enables it to react if a finger is directly in front of the screen (but not actually touching it). This makes it possible to use the screen while wearing gloves.

**!** **CAUTION**  
Do not touch the screen with sharp objects because this could cause scratches.

Procedure	Gesture	Result
	Tap once.	Marks an object, confirms a selection or activates a function.
	Double-tap.	Zooms in on an object such as a map.
	Press and hold.	"Grabs" an object so that it can be dragged. Press and hold on the screen and drag the object to the desired position.
	Tap with two fingers.	Zooms out from an object such as a map.

Procedure	Gesture	Result
	Drag	Moves between screen views, scrolls in a list, text or a view. Press and hold to drag apps or objects in a list.
	Swipe	Moves between screen views, scrolls in a list, text or a view
	Stretch	Zooms in.
	Pinch	Zooms out.

## ◀ Turning off and reactivating the center display



Home button for the center display

When the center display is turned off, the screen goes dark to avoid disturbing the driver. However, the climate bar remains visible and apps or other functions connected to the display remain active.

1. Press and hold the Home button below the screen.
  - > The screen will go dark. However, the climate bar remains visible and apps or other functions connected to the display remain active. The screen can also be cleaned while it is turned off.

2. Reactivate by pressing the Home button briefly.
  - > The view that was displayed when the screen was turned off will be displayed again.

**NOTE**

- The display cannot be turned off while a message requiring action is on the screen.
- The display turns off automatically when the ignition is switched off and the driver's door is opened.

## Returning to Home view

1. Press the Home button briefly.
  - > The most recent Home view mode will be displayed.
2. Press again briefly.
  - > All of the Home view's sub-views will return to standard mode.

**NOTE**

From Home view's standard mode, press the Home button to start animated on-screen instructions describing how to display the various views.

## Moving apps and vehicle function buttons

Apps and function buttons can be moved and organized in their respective views.

1. Press and hold an app/button.
  - > The app/button will change size and become transparent. It can then be moved.
2. Drag the app/button to an available position in the view.

A maximum of 48 lines can be utilized for placing apps/buttons. To move an app/button outside of the visible view, drag it to the bottom of the view. A new line will then be added where the app/button can be placed (this line may not be visible). Swipe the screen to scroll up or down in the view to display information that may be outside of the view.

## Scrolling in lists, articles or views

A scroll indicator on the screen shows that it is possible to scroll up or down in the view. Press the indicator and move it up or down or swipe up or down anywhere in the view.

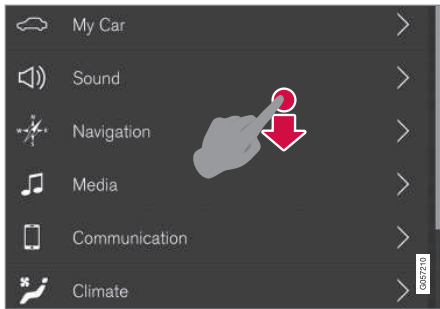

The scroll indicator on the right side of the center display

### Using center display controls



Temperature control<sup>4</sup>

Digital controls are available for many of the vehicle's functions. For example, to set the temperature:

- Drag the control to the desired temperature
- Tap +/- to raise or lower the temperature incrementally, or
- Tap the desired temperature on the control

### Related information

- Navigating in the center display's views (p. 38)
- Settings view (p. 109)
- Sensus (p. 17)
- Downloading, updating and uninstalling apps (p. 441)
- Using the center display keyboard (p. 31)

<sup>4</sup> Generic illustration. The temperature in your vehicle may be set to degrees Fahrenheit.

## Using the owner's manual

Reading your owner's manual is a good way of familiarizing yourself with the features and systems in your vehicle.

### On-board owner's manual

Reading the owner's manual is a good way to become familiar with your vehicle and to learn to utilize the features and functions that it offers. Pay particular attention to the warnings provided.

Volvo reserves the right to make model changes at any time, or to change specifications or design without notice and without incurring obligation.

© Volvo Car Corporation

### Printed owner's information

We advise keeping printed owner's information in the vehicle for quick access to necessary information and how to contact Volvo if help is required.

### Illustrations

Some of the illustrations used in your owner's information may be generic and will give a general view of a certain feature or function. For example, some illustrations describing climate system functions may display a temperature in degrees Celsius but the same information applies to Fahrenheit.

### Options and accessories

Optional or accessory equipment described in this manual is indicated by an asterisk.

Optional or accessory equipment may not be available in all countries or markets. Please note that some vehicles may be equipped differently, depending on special legal requirements.

Contact your Volvo retailer for additional information.

### Footnotes

Certain pages of this manual contain information in the form of footnotes at the bottom of the page. This information supplements the text that the footnote number refers to (a letter is used if the footnote refers to text in a table).

### Messages

There are several displays in the vehicle that show messages generated by various systems and functions in the vehicle. The appearance of these texts differs slightly from normal texts (for example: **Phone, Accept**).

### Decals

There are various types of decals in the vehicle whose purpose is to provide important information in a clear and concise way. The importance of these decals is explained as follows, in descending order of importance.

### Risk of injury

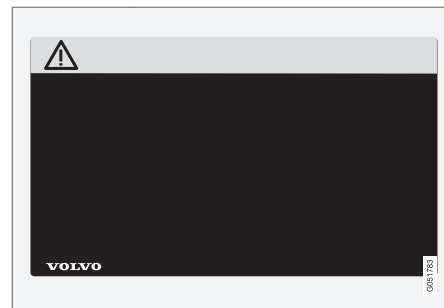

Black ISO symbols on a yellow warning background, white text/image on a black background. Decals of this type are used to indicate potential danger. Ignoring a warning of this type could result in serious injury or death.

### Risk of damage to the vehicle



White ISO symbols and white text/image on a black or blue warning background and space for a message. If the information on decals of this type is ignored, damage to the vehicle could result.

### Information

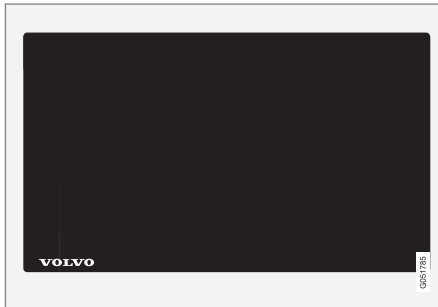

White ISO symbols and white text/image on a black background. These decals provide general information.

### **i** NOTE

The decals shown in the Owner's Manual are examples only and are not intended to be reproductions of the decals actually used in the vehicle. The purpose is to give an indication of how they look and their approximate location in the vehicle. The applicable information for your particular vehicle can be found on the respective decals in the vehicle.

### Types of lists

#### Procedures

Procedures (step-by-step instructions), or actions that must be carried out in a certain order, are arranged in numbered lists in this manual.

- 1** If there is a series of illustrations associated with step-by-step instructions, each step in the procedure is numbered in the same way as the corresponding illustration.
- A** Lists in which letters are used can be found with series of illustrations in cases where the order in which the instructions are carried out is not important.
- ▶** Arrows with or without numbers are used to indicate the direction of a movement.

- ▶** Arrows containing letters are used to indicate movement.

If there are no illustrations associated with a step-by-step list, the steps in the procedure are indicated by ordinary numbers.

#### Position lists

- 1** Red circles containing a number are used in general overview illustrations in which certain components are pointed out. The corresponding number is also used in the position list's description of the various components.

#### Bullet lists

Bullets are used to differentiate a number of components/functions/points of information that can be listed in random order.

For example:

- Coolant
- Engine oil

#### Illustrations

Some of the illustrations and images shown in the owner's manual are generic and may differ slightly from the equipment in your vehicle depending the level of instrumentation or market.

#### Related information

Related information offers references to articles containing information associated with the information that you are currently reading.

◀◀ **Continues on next page**

▶▶ This symbol can be found at the lower right corner to indicate that the current topic continues on the following page.

**Continuation from previous page**

◀◀ This symbol can be found at the upper left corner to indicate that the current topic is a continuation from the previous page.

**Related information**

- On-board digital owner's manual (p. 50)
- Owner's manual in mobile devices (p. 20)
- Additional information about your vehicle (p. 14)

**On-board digital owner's manual**

When printed owner's information refers to digital owner's information, this is the on-board information available in the vehicle's center display.

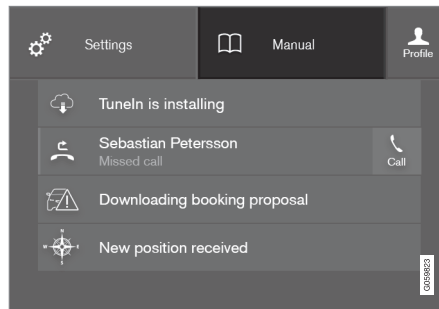



The digital on-board owner's manual is accessed from the center display's Top view

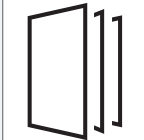

There are a number of ways to find information in the digital owner's manual, which can be accessed from the manual's top menu by tapping .

 **NOTE**

The on-board owner's information cannot be accessed while the vehicle is moving.

Symbols and their descriptions	
	Takes you to the owner's information start page.
	All articles sorted by category. An article may be listed in several categories.
	A selection of useful articles about the most commonly used functions in the vehicle.

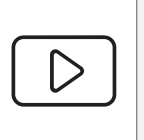
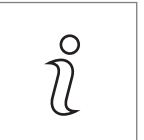

Symbols and their descriptions	
	Exterior/interior views of the vehicle in which certain areas/components are highlighted as hotspots. Tap a hotspot to come to a relevant article.
	
	This offers access to a list of articles that have been saved as favorites. Tap an article to read it in its entirety.

Symbols and their descriptions	
	Leads to short instructional videos for various vehicle functions.
	This offers information about the current version of the owner's information in your vehicle and other useful information.

### Related information

- Navigating in the digital owner's manual (p. 51)

## Navigating in the digital owner's manual

The digital on-board owner's manual is accessed from the center display. The contents are searchable and it is easy to navigate among the various sections.

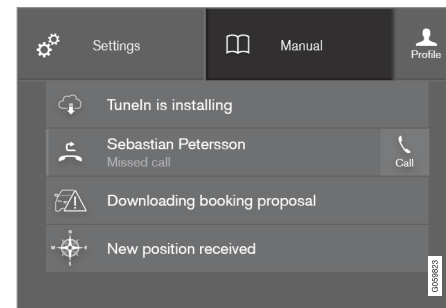

The digital on-board owner's manual is accessed from the center display's Top view

### Opening the digital owner's information

- To open the digital owner's information, pull down the center display's Top view and tap **Owner's manual**.



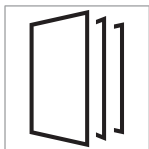

There are several ways of finding information.

To access the owner's manual's menu, tap  in the upper bar.

## ◀ Searching using categories



The articles in the owner's manual are structured in main and sub-categories. The same article may appear in several pertinent categories in order to make them easier to find.



1. Tap  followed by **Categories**.
  - > The main categories will be listed.
2. Tap a main category () .
  - > A list of sub-categories and () and articles () will be displayed.
3. Tap an article to open it. Tap the left arrow to go back or  to begin a new search.

## Interior and exterior hotspots



Exterior and interior views of the vehicle where certain components are pointed out are called hotspots.



1. Tap  followed by **Exterior/Interior**.
  - > Exterior/interior views will be displayed with hotspots, which lead to relevant articles. Swipe the screen horizontally to scroll among the views.
2. Tap a hotspot.
  - > The title of a relevant article will be displayed.
3. Tap the title to open the article. Tap the left arrow to go back or  to begin a new search.

## Quick Guide.



The heading **Quick Guide** in the owner's manual's menu leads to a selection of articles that may be helpful in familiarizing you with your vehicle's most common features and functions. These articles can also



be found through categories but have been gathered here for quick access. Tap an article to read it in its entirety.

## Favorites



This is a list of articles that have been saved as favorites. Tap an article to read it in its entirety.

## Saving/deleting favorites

Save an article as a favorite by tapping the star () at the upper right when an article is open. The star symbol will be filled in () when its article has been saved as a favorite.

To delete a favorite, tap its star again.

## Video

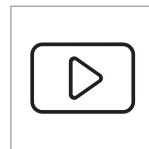

Tap for short instructional videos for various vehicle functions.

## Information

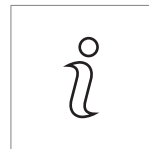

Tap the symbol for information about the current version of the owner's information in your vehicle and other useful information.

## Start page



Tap the symbol to come to the owner's information start page.

## Using the search function

1. Tap the magnifying glass icon (🔍) in the owner's manual's upper menu. A keyboard will appear at the bottom of the screen.
2. Enter a word, e.g., "seat belt."
  - > Suggested articles will be displayed as more characters are entered.
3. Confirm by tapping the article. To leave search mode tap the up-arrow next to the search box.

## Related information

- On-board digital owner's manual (p. 50)
- Using the center display keyboard (p. 31)

## Glass

### Laminated glass

The windshield and panoramic roof\* are made of laminated glass, which is reinforced to help prevent break-ins and to provide additional sound-proofing. Laminated glass is optional for the other side windows.



Laminated glass symbol<sup>5</sup>

### Related information

- Laminated panoramic roof\* (p. 103)
- Power windows (p. 107)
- Defrosting windows and mirrors (p. 194)
- Using sun curtains\* (p. 109)
- Rearview mirror (p. 108)
- Power windows (p. 107)
- Head-up display (HUD)\* (p. 116)
- Activating/deactivating the rain sensor (p. 157)
- Windshield and headlight washers (p. 158)
- Tailgate window wiper and washer (p. 159)

## Technician certification

In addition to Volvo factory training, Volvo supports certification by the National Institute for Automotive Service Excellence (A.S.E.).

Certified technicians have demonstrated a high degree of competence in specific areas. Besides passing exams, each technician must also have worked in the field for two or more years before a certificate is issued. These professional technicians are best able to analyze vehicle problems and perform the necessary maintenance procedures to keep your Volvo at peak operating condition.

<sup>5</sup> This symbol is not shown on the windshield or panoramic roof.



SAFETY

## General safety information

The vehicle is equipped with a number of safety systems for the driver and passengers.

In the event of an accident, there are a number of sensors in the vehicle that react and trigger safety systems such as Roll Stability Control, airbags, seat belt pretensioners, etc., depending on the severity of the collision. There are also mechanical systems such as the Whiplash Protection System.

### Warning symbol in the instrument panel



The warning symbol in the instrument panel illuminates when the ignition is in mode **II** or higher. It will go out after approx. 6 seconds if no faults are detected in the airbag system.

### WARNING

- If the SRS warning light stays on after the engine has started or if it illuminates while you are driving, have the vehicle inspected by a trained and qualified Volvo service technician as soon as possible.
- Never try to repair any component or part of the SRS yourself. Any interference in the system could cause malfunction and serious injury. All work on these systems should be performed by a trained and qualified Volvo service technician.



If the dedicated warning symbol is not functioning, the general warning symbol will illuminate instead and the same message will be displayed in the instrument panel.

### Related information

- Safety during pregnancy (p. 58)
- Seat belts (p. 60)
- Airbag system (p. 65)
- Safety mode (p. 74)
- Whiplash protection system (p. 59)
- Child safety (p. 75)

## Occupant safety

Safety is Volvo's cornerstone.

### Volvo's concern for safety

Our concern for safety dates back to 1927 when the first Volvo rolled off the production line. Three-point seat belts (a Volvo invention), safety cages, and energy-absorbing impact zones were designed into Volvo vehicles long before it was fashionable or required by government regulation.

We will not compromise our commitment to safety. We continue to seek out new safety features and to refine those already in our vehicles. You can help. We would appreciate hearing your suggestions about improving automobile safety. We also want to know if you ever have a safety concern with your vehicle. Call us in the U.S. at: 1-800-458-1552 or in Canada at: 1-800-663-8255.

### Occupant safety reminders

How safely you drive doesn't depend on how old you are but rather on:

- How well you see.
- Your ability to concentrate.
- How quickly you make decisions under stress to avoid an accident.

The following suggestions are intended to help you cope with the ever changing traffic environment.

- Never drink and drive.
- If you are taking any medication, consult your physician about its potential effects on your driving abilities.
- Take a driver-retraining course.
- Have your eyes checked regularly.
- Keep your windshield and headlights clean.
- Replace wiper blades when they start to leave streaks.
- Take into account the traffic, road, and weather conditions, particularly with regard to stopping distance.
- Never send text messages while driving.
- Refrain from using or minimize the use of a cell phone while driving.

### Related information

- Recall information (p. 58)
- Reporting safety defects (p. 57)

### Reporting safety defects

The following information will help you report any perceived safety-related defects in your vehicle.

#### Reporting safety defects in the U.S.

If you believe that your vehicle has a defect which could cause a crash or could cause injury or death, you should immediately inform the National Highway Traffic Safety Administration (NHTSA) in addition to notifying Volvo Car USA, LLC. If NHTSA receives similar complaints, it may open an investigation, and if it finds that a safety defect exists in a group of vehicles, it may order a recall and remedy campaign. However, NHTSA cannot become involved in individual problems between you, your retailer, or Volvo Car USA, LLC. To contact NHTSA, you may either call the Auto Safety Hotline toll-free at

1-888-327-4236

(TTY: 1-800-424-9153) or write to: NHTSA, U.S. Department of Transportation, Washington D.C. 20590.

You can also obtain other information about motor vehicle safety from <http://www.safercar.gov>, where you can also enter your vehicle's VIN (Vehicle Identification Number) to see if it has any open recalls.

Volvo strongly recommends that if your vehicle is covered under a service campaign, safety or emission recall or similar action, it should be completed as soon as possible. Please check with your local retailer or Volvo Car USA, LLC if your vehicle is covered under these conditions.

NHTSA can be reached at:

Internet:

<http://www.nhtsa.gov>

Telephone:

1-888-DASH-2-DOT  
(1-888-327-4236).

#### Reporting safety defects in Canada

If you believe your vehicle has a defect that could cause a crash or could cause injury or death, you should immediately inform Transport Canada in addition to notifying Volvo Cars of Canada Corp.



◀◀ **Transport Canada can be contacted at:**

1-800-333-0510

Teletypewriter (TTY): 613 990-4500

Fax: 1-819-994-3372

Mailing Address: Transport Canada - Road Safety, 80 rue Noël, Gatineau, (Quebec) J8Z 0A1

**Related information**

- Recall information (p. 58)
- Occupant safety (p. 56)

**Recall information**

On our website, select the "Own" tab on the upper left side of the screen and click the heading "Recall Information" on the right side of the screen. Enter your Vehicle Identification Number (VIN) for your vehicle (found at the base of the windshield). If your vehicle has any open Recalls, they will be displayed on this page.

You can also enter the Vehicle Identification Number in the search field on the National Highway Traffic Safety Administration's (NHTSA) website at: [www.nhtsa.gov](http://www.nhtsa.gov).

**Volvo customers in Canada**

For any questions regarding open recalls for your vehicle, please contact your authorized Volvo retailer. If your retailer is unable to answer your questions, please contact Volvo Customer Relations at 905 695-9626, Monday through Friday, 8:30 A.M. to 5:00 P.M. EST or by e-mail at [vclcust@volvocars.com](mailto:vclcust@volvocars.com). You may also write us at:

Volvo Cars of Canada

National Customer Service

9130 Leslie Street, Suite 101

Richmond Hill, Ontario L4B 0B9

[www.tc.gc.ca](http://www.tc.gc.ca)

**Related information**

- Occupant safety (p. 56)
- Reporting safety defects (p. 57)

**Safety during pregnancy**

The seat belt should always be worn during pregnancy. However, it is crucial that it be worn correctly.

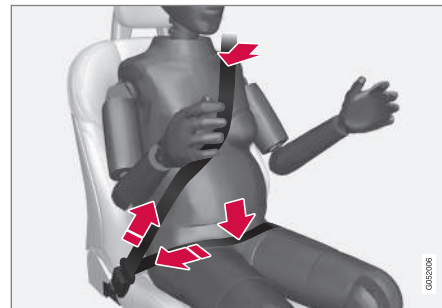

The diagonal section should wrap over the shoulder then be routed between the breasts and to the side of the belly. The lap section should lay flat over the thighs and as low as possible under the belly. It must never be allowed to ride upward. Remove all slack from the belt and ensure that it fits close to the body without any twists.

As a pregnancy progresses, pregnant drivers should adjust their seats and steering wheel such that they can easily maintain control of the vehicle as they drive (which means they must be able to easily operate the foot pedals and steering wheel). Within this context, they should strive to position the seat with as large a distance as possible between their belly and the steering wheel.



### Related information

- Buckling and unbuckling seat belts (p. 62)
- Adjusting power front seats\* (p. 163)
- Manually operated front seats (p. 162)

### Whiplash protection system

The Whiplash protection system (WHIPS) consists of specially designed hinges and brackets on the front seat backrests designed to help absorb some of the energy generated in a collision from the rear (when the vehicle is rear-ended).

#### Function

In the event of certain rear-end collisions, the hinges and brackets of the front seat backrests are designed to change position slightly to allow the backrest/head restraint to help support the occupant's head before moving slightly rearward. This movement helps absorb some of the forces that could result in whiplash.

#### WARNING

- The WHIPS system is designed to supplement the other safety systems in your vehicle. For this system to function properly, the three-point seat belt must be worn. Please be aware that no system can prevent all possible injuries that may occur in an accident.
- The WHIPS system is designed to function in certain collisions from the rear, depending on the crash severity, angle and speed.

#### WARNING

- Occupants in the front seats must never sit out of position. The occupant's back must be as upright as comfort allows and be against the seat back with the seat belt properly fastened.
- If your vehicle has been involved in a rear-end collision, the front seat backrests must be inspected by a trained and qualified Volvo service technician, even if the seats appear to be undamaged. Certain components in the WHIPS system may need to be replaced.
- Do not attempt to service any component in the WHIPS system yourself.

#### WARNING

- Boxes, suitcases, etc. wedged behind the front seats could impede the function of the Whiplash Protection System.
- If the rear seat backrests are folded down, cargo must be secured to prevent it from sliding forward against the front seat backrests in the event of a collision from the rear. This could interfere with the action of the Whiplash Protection System.



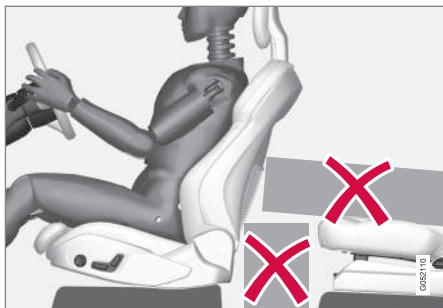

Do not place any objects behind the front seats that could impede the WHIPS function

### **WARNING**

Any contact between the front seat backrests and the folded rear seat or a rear-facing child seat could impede the function of the WHIPS system. If the rear seat is folded down, the occupied front seats must be adjusted forward so that they do not touch the folded rear seat.

### **Related information**

- General safety information (p. 56)
- Rear Collision Warning (RCW) (p. 316)
- Manually operated front seats (p. 162)
- Power front seats\* (p. 163)

## **Seat belts**

Seat belts should always be worn by all occupants of your vehicle. Children should be properly restrained, using an infant, car, or booster seat determined by age, weight and height.

Most states and provinces make it mandatory for occupants of a vehicle to use seat belts.

### **Reversible seat belt pretensioners**

Reversible seat belt pretensioners is a system in the front seats that pulls the seat belts slightly taut prior to a collision. This function helps position the front seat occupants to help improve the effects of other safety systems, e.g., the airbag system.

### **Seat belt maintenance**

Check periodically that the seat belts are in good condition. Use water and a mild detergent for cleaning. Check seat belt mechanism function as follows: attach the seat belt and pull rapidly on the strap.

### **WARNING**

- Never repair the belt yourself; have this work done by a trained and qualified Volvo service technician only.
- Any device used to induce slack into the shoulder belt portion of the three-point belt system will have a detrimental effect on the amount of protection available to you in the event of a collision.
- The seat back should not be tilted too far back. The shoulder belt must be taut in order to function properly.
- Do not use child safety seats or child booster cushions/backrests in the front passenger's seat. We also recommend that children who have outgrown these devices sit in the rear seat with the seat belt properly fastened.

### **Related information**

- Buckling and unbuckling seat belts (p. 62)
- Door and seat belt reminders (p. 64)
- Seat belt pretensioners (p. 61)

## Seat belt pretensioners

The vehicle's seat belts are equipped with standard and electric pretensioners that can help pull the seat belts taut in a critical situation or a collision. Some or all of the pretensioners will be triggered in certain types of collisions, depending on the direction and severity of the impact.

### Reversible seat belt pretensioners

Reversible seat belt pretensioners is a system in the front seats that pulls the seat belts slightly taut prior to a collision. This function helps position the front seat occupants to help improve the effects of other safety systems, e.g., the airbag system.

### Seat belt pretensioners in collisions

The seat belts are equipped with standard pretensioners that are triggered according to the severity of a collision.

### Seat belt pretensioners in critical situations

In addition to the standard pretensioners, the seat belts in the front seats are also equipped with electric pretensioners.

The pretensioners interact and can be triggered along with the City Safety and Rear Collision Warning systems. In critical situations such as sudden braking, evasive maneuvers, etc., the seat belt can be pulled taut by the pretensioner's electric motor.

The electric pretensioner positions the occupant in the seat to help reduce the risk of striking the interior of the passenger compartment and improves the effect of other safety systems such as the airbags.

### Resetting the electric pretensioners

When a critical situation has passed, the seat belt and the electric pretensioner are reset automatically.

If the seat belt should remain taut:

1. Stop the vehicle safely.
2. Unbuckle the seat belt and rebuckle it.
  - > The seat belt and the electric pretensioner will be reset.

## WARNING

- Never repair the belt yourself; have this work done by a trained and qualified Volvo service technician only.
- Any device used to induce slack into the shoulder belt portion of the three-point belt system will have a detrimental effect on the amount of protection available to you in the event of a collision.
- The seat back should not be tilted too far back. The shoulder belt must be taut in order to function properly.
- Do not use child safety seats or child booster cushions/backrests in the front passenger's seat. We also recommend that children who have outgrown these devices sit in the rear seat with the seat belt properly fastened.

### Related information

- Seat belts (p. 60)
- Door and seat belt reminders (p. 64)
- Buckling and unbuckling seat belts (p. 62)

## Buckling and unbuckling seat belts

Seat belts should be used by all occupants in the vehicle when it is in motion.

### Buckling a seat belt

1. Pull the belt out slowly. It should not be twisted or turned.

Be sure that the seat belt in the center position of the second row of seats is correctly positioned in the seat belt guide.

#### NOTE

Each seat belt is equipped with a seat belt retractor that will lock up in the following situations:

- if the belt is pulled out rapidly
- during braking and acceleration
- if the vehicle is leaning excessively
- when driving in turns
- if the Automatic Locking Retractor/Emergency Locking Retractor (ALR/ELR) is activated (each seat belt (except for the driver's belt) is equipped with the ALR/ELR function, which is designed to help keep the seat belt taut. ALR/ELR activates if the seat belt is pulled out as far as possible. If this is done, a sound from the seat belt retractor will be audible, which is normal, and the seat belt will be pulled taut and locked in place. This function is automatically disabled when the seat belt is unbuckled and fully retracted).

2. Insert the latch plate into the receptacle. The seat belt retractor is normally "unlocked" and you can move freely, provided that the shoulder belt is not pulled out too far.
  - > A distinct click will be audible.

#### WARNING

The seat belt latch plate should only be inserted into its intended receptacle. Inserting it into one of the other receptacles may prevent it from functioning properly.

3. The height of the seat belts in the front seats and outboard rear seating positions can be adjusted. The height of the shoulder section of the seat belt must be correctly adjusted.

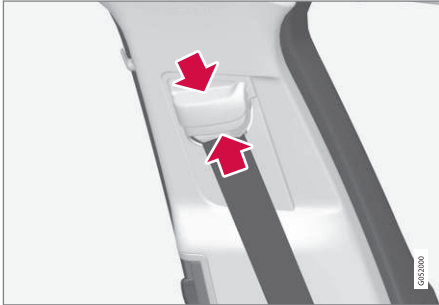

Press the button and move the upper seat belt anchor up or down.

Position it as high as possible so that the shoulder section of the belt is across the seat occupant's collarbone and not across the throat.

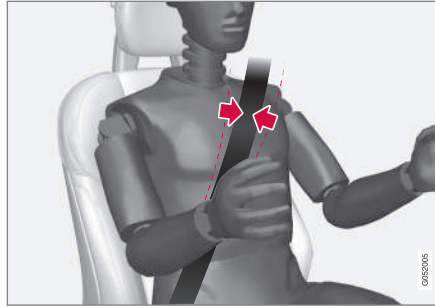

The seat belt should be positioned over the shoulder (not over the arm)

4. Tighten the lap section of the seat belt by pulling the diagonal section upward toward the shoulder.

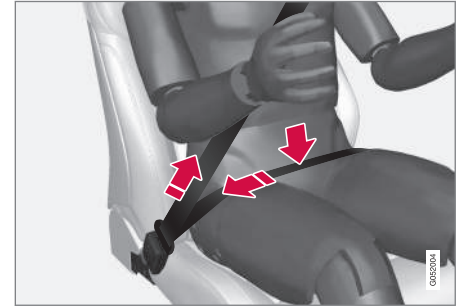

The lap section of the belt must be positioned low on the hips (not pressing against the abdomen)

Make sure that the shoulder belt is rolled up into its retractor and that the shoulder and lap belts are taut.

### **WARNING**

Never use a seat belt for more than one occupant. Never wear the shoulder portion of the belt under the arm, behind the back or otherwise out of position. Such use could cause injury in the event of an accident. As seat belts lose much of their strength when exposed to violent stretching, they should be replaced after any collision, even if they appear to be undamaged.

## ◀ Unbuckling the seat belt

To remove the seat belt, press the red section on the seat belt receptacle. Before exiting the vehicle, check that the seat belt retracts fully after being unbuckled. If necessary, guide the belt back into the retractor slot.

Be sure that the seat belt in the center position of the second row of seats is correctly positioned in the seat belt guide.

### Related information

- Door and seat belt reminders (p. 64)
- Seat belts (p. 60)

## Door and seat belt reminders

The door and seat belt reminders are intended to alert all occupants of the vehicle that their seat belts should be buckled before the vehicle begins to move or if a door, the hood, tailgate or fuel filler door have not been closed properly.

### Graphics in the instrument panel

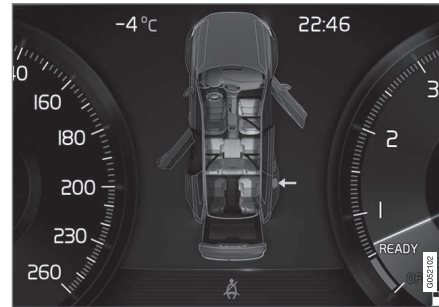

Warning colors for doors/tailgate vary depending on the vehicle's speed (generic illustration)

The instrument panel graphic shows the seats where seat belts are not buckled.

The same graphic also indicates if a door, the hood, tailgate or fuel filler door is/are open.

This graphic disappears automatically after approx. 30 seconds or if the **O** button on the steering wheel keypad is pressed.

## Seat belt reminder



Seat belt reminder light in ceiling console



The seat belt reminder consists of an audible signal, an indicator light near the rearview mirror and a symbol in the instrument panel that alert all occupants of the vehicle to buckle their seat belts.

The audible signal is speed-dependent and will sound for several seconds.

If the driver's or a passenger's seat belt is not buckled, this will be indicated in the instrument panel.

Child seats are not included in the seat belt reminder system.

### Front seats

An audible signal and an indicator light will remind the driver and front seat passenger to buckle their seat belts.

## Rear seats

The rear seat belt reminder has two functions.

- It indicates which seat belts are buckled in the rear seats. This will also be displayed in an instrument panel graphic.
- It also provides audio and visual reminders if a rear seat belt is unbuckled while the vehicle is in motion. The reminders will disappear when the seat belt has been buckled again or can be erased by pressing the **O** button on the steering wheel keypad.

## Door/hood/tailgate/fuel filler door reminder

If a door, the hood, tailgate or fuel filler door is/are not properly closed, this will be indicated in a graphic in the instrument panel. Stop the vehicle safely and close the source of the reminder.



If the vehicle is moving at a speed under approx. 6 mph (10 km/h), the information symbol will illuminate in the instrument panel.



At speeds above approx. 6 mph (10 km/h), the warning symbol will illuminate in the instrument panel.

## Related information

- Seat belts (p. 60)
- Buckling and unbuckling seat belts (p. 62)
- Seat belt pretensioners (p. 61)

## Airbag system

As an enhancement to the three-point seat belts, your vehicle is equipped with an airbag system.

### WARNING

- If the airbag warning light stays on after the engine has started or if it illuminates while you are driving, have the vehicle inspected by a trained and qualified Volvo service technician as soon as possible.
- Never try to repair any component or part of the airbag systems yourself. Any interference in the system could cause malfunction and serious injury. All work on these systems should be performed by a trained and qualified Volvo service technician.

### WARNING

If your vehicle has become flood-damaged in any way (e.g., soaked carpeting/standing water on the floor of the vehicle), do not attempt to start the vehicle. This may cause airbag deployment which could result in serious injury. Have the vehicle towed to a trained and qualified Volvo service technician for repairs.

Before attempting to tow the vehicle:

1. Switch off the ignition for at least 10 minutes and disconnect the battery.
2. Follow the instructions for manually overriding the shiftlock system.

## Deployed airbags

### WARNING

If any of the airbags have deployed:

- Do not attempt to drive the vehicle. Have it towed to a qualified repair facility.
- If necessary seek medical attention.

## Driver/passenger side airbags

The front airbags supplement the three-point seat belts. For these airbags to provide the protection intended, seat belts must be worn at all times.

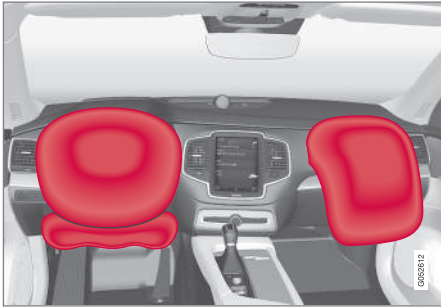

Driver and passenger side front airbags

### The front airbag system

The front airbag system includes gas generators surrounded by the airbags, and deceleration sensors that activate the gas generators, causing the airbags to be inflated with nitrogen gas.

As the movement of the seats' occupants compresses the airbags, some of the gas is expelled at a controlled rate to provide better cushioning. Both seat belt pretensioners also deploy, minimizing seat belt slack. The entire process, including inflation and deflation of the airbags, takes approximately one fifth of a second.

The location of the front airbags is indicated by **SRS AIRBAG** embossed on the steering wheel pad and above the glove compartment, and by decals on both sun visors and on the front and far right side of the dash.

The **driver's side front airbag** is folded and located in the steering wheel hub.

The **knee airbag** is folded on the underside of the dashboard on the driver's side. The text **AIRBAG** is embossed on the panel.

The **passenger's side front airbag** is folded behind a panel located above the glove compartment.

## WARNING

- The airbags in the vehicle are designed to be a **SUPPLEMENT** to—not a replacement for—the three-point seat belts. For maximum protection, wear seat belts at all times. Be aware that no system can prevent all possible injuries that may occur in an accident.
- Never drive with your hands on the steering wheel pad/airbag housing.
- The front airbags are designed to help prevent serious injury. Deployment occurs very quickly and with considerable force. During normal deployment and depending on variables such as seating position, one may experience abrasions, bruises, swellings, or other injuries as a result from deployment of one or both of the airbags.
- When installing any accessory equipment, make sure that the front airbag system is not damaged. Any interference in the system could cause malfunction.

### Front airbag deployment

- The front airbags are designed to deploy during certain frontal or front-angular collisions, impacts, or decelerations, depending on the crash severity, angle, speed and object impacted. The airbags may also deploy in



certain non-frontal collisions where rapid deceleration occurs.

- The airbag system sensors, which trigger the front airbags, are designed to react to both the impact of the collision and the inertial forces generated by it, and to determine if the intensity of the collision is sufficient for the seat belt pretensioners and/or airbags to be deployed.

However, not all frontal collisions activate the front airbags.

- If the collision involves a nonrigid object (e.g., a snow drift or bush), or a rigid, fixed object at a low speed, the front airbags will not necessarily deploy.
- Front airbags do not normally deploy in a side impact collision, in a collision from the rear or in a rollover situation.
- The amount of damage to the bodywork does not reliably indicate if the airbags should have deployed or not.

**i** **NOTE**

- Deployment of front airbags occurs only one time during an accident. In a collision where deployment occurs, the airbags and seat belt pretensioners activate. Some noise occurs and a small amount of powder is released. The release of the powder may appear as smoke-like matter. This is a normal characteristic and does not indicate fire.
- Volvo's front airbags use special sensors that are integrated with the front seat buckles. The point at which the airbag deploys is determined by whether or not the seat belt is being used, as well as the severity of the collision.
- Collisions can occur where only one of the airbags deploys. If the impact is less severe, but severe enough to present a clear injury risk, the airbags are triggered at partial capacity. If the impact is more severe, the airbags are triggered at full capacity.

**⚠** **WARNING**

- Do not use child safety seats or child booster cushions/backrests in the front passenger's seat. We also recommend that occupants under 4 feet 7 inches (140 cm) in height who have outgrown these devices sit in the rear seat with the seat belt fastened. See also the Occupant Weight Sensor information,.
- Never drive with the airbags deployed. The fact that they hang out can impair the steering of your vehicle. Other safety systems can also be damaged.
- The smoke and dust formed when the airbags are deployed can cause skin and eye irritation in the event of prolonged exposure.

Should you have questions about any component in the SRS system, please contact a trained and qualified Volvo service technician or Volvo customer support:

**In the USA**

Volvo Car USA, LLC  
 Customer Care Center  
 1 Volvo Drive  
 P.O. Box 914  
 Rockleigh, New Jersey 07647



◀◀ 1-800-458-1552

www.volvocars.com/us

**In Canada**

Volvo Cars of Canada Corp.

National Customer Service

9130 Leslie Street, Suite 101

Richmond Hill, Ontario L4B 0B9

1-800-663-8255

www.volvocars.com/ca

**Airbag decals**



Airbag decal on the outside of both sun visors

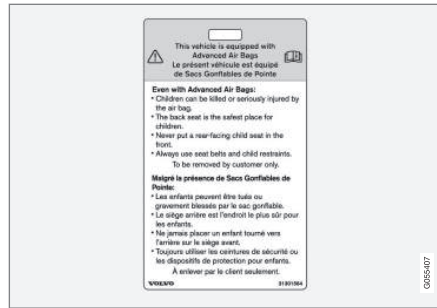

Passenger's side airbag decal

**WARNING**

- Children must never be allowed in the front passenger's seat.
- Occupants in the front passenger's seat must never sit on the edge of the seat, sit leaning toward the instrument panel or otherwise sit out of position.
- The occupant's back must be as upright as comfort allows and be against the seat back with the seat belt properly fastened.
- Feet must be on the floor, e.g., not on the dash, seat or out of the window.

**WARNING**

- No objects or accessory equipment, e.g. dashboard covers, may be placed on, attached to, or installed near the air bag hatch (the area above the glove compartment) or the area affected by airbag deployment.
- There should be no loose articles, such as coffee cups on the floor, seat, or dashboard area.
- Never try to open the airbag cover on the steering wheel or the passenger's side dashboard. This should only be done by a trained and qualified Volvo service technician.
- Failure to follow these instructions can result in injury to the vehicle occupants.

**Related information**

- Seat belts (p. 60)
- Occupant weight sensor (p. 69)

## Occupant weight sensor

The Occupant Weight Sensor (OWS) is designed to meet the regulatory requirements of Federal Motor Vehicle Safety Standard (FMVSS) 208 and is designed to disable (will not inflate) the passenger's side front airbag under certain conditions.



Occupant Weight Sensor (OWS) indicator light

### Disabling the passenger's side front airbag

Volvo recommends that ALL occupants (adults and children) shorter than 4 feet 7 inches (140 cm) be seated in the back seat of any vehicle with a front passenger side airbag and be properly restrained for their size and weight.

The OWS works with sensors that are part of the front passenger's seat and seat belt. The sensors are designed to detect the presence of a properly

seated occupant and determine if the passenger's side front airbag should be enabled (may inflate) or disabled (will not inflate).

The OWS will disable (will not inflate) the passenger's side front airbag when:

- the front passenger's seat is unoccupied, or has small/medium objects in the front seat,
- the system determines that an infant is present in a rear-facing infant seat that is installed according to the manufacturer's instructions,
- the system determines that a small child is present in a forward-facing child restraint that is installed according to the manufacturer's instructions,
- the system determines that a small child is present in a booster seat,
- a front passenger takes his/her weight off of the seat for a period of time,
- a child or a small person occupies the front passenger's seat.

The OWS uses a PASSENGER AIRBAG OFF indicator lamp which will illuminate and stay on to remind you that the passenger's side front airbag is disabled. The PASSENGER AIRBAG OFF indicator lamp is located in the overhead console, near the base of the rearview mirror.

### **i** NOTE

When the ignition is switched on, the OWS indicator light will illuminate for several seconds while the system performs a self-diagnostic test.

However, if a fault is detected in the system:

- The OWS indicator light will stay on
- The SRS warning light will come on and stay on and a text message will be displayed.

### **⚠** WARNING

If a fault in the system is detected and indicated as described, be aware that the passenger's side front airbag will not deploy in the event of a collision. In this case, the SRS system and Occupant Weight Sensor should be inspected by a trained and qualified Volvo service technician as soon as possible.



## WARNING

- Never try to open, remove, or repair any components in the OWS system. This could result in system malfunction. Maintenance or repairs should only be carried out by an trained and qualified Volvo service technician.
- The front passenger's seat should not be modified in any way. This could reduce pressure on the seat cushion, which might interfere with the OWS system's function.

Passenger's seat occupancy status	OWS indicator light status	Passenger's side front airbag status
Seat unoccupied	OWS indicator light lights up.	Passenger's side front airbag disabled
Seat occupied by low weight occupant/object <sup>A</sup>	OWS indicator light lights up	Passenger's side front airbag disabled
Seat occupied by heavy occupant/object	OWS indicator light is <b>not</b> lit	Passenger's side front airbag enabled

<sup>A</sup> Volvo recommends that children always be properly restrained in appropriate child restraints in the rear seats. Do not assume that the passenger's side front airbag is disabled unless the PASSENGER AIRBAG OFF indicator lamp is lit. Make sure the child restraint is properly installed. If there is any doubt as to the status of the passenger's side front airbag, move the child restraint to the rear seat.

The OWS is designed to enable (may inflate) the passenger's side front airbag in the event of a collision anytime the system senses that a person of adult size is sitting properly in the front passenger's seat. The PASSENGER AIRBAG OFF indicator lamp will be off and remain off.

If a person of adult size is sitting in the front passenger's seat, but the PASSENGER AIRBAG OFF indicator lamp is on, it is possible that the

person isn't sitting properly in the seat. If this happens:

- Turn the vehicle off and ask the person to place the seatback in an upright position.
- Have the person sit upright in the seat, centered on the seat cushion, with the person's legs comfortably extended.
- Restart the vehicle and have the person remain in this position for about two minutes. This will allow the system to detect that person and enable the passenger's frontal airbag.
- If the PASSENGER AIRBAG OFF indicator lamp remains on even after this, the person should be advised to ride in the rear seat.

This condition reflects limitations of the OWS classification capability. It does not indicate OWS malfunction.

### Modifications

If you are considering modifying your vehicle in any way to accommodate a disability, for example by altering or adapting the driver's or front passenger's seat(s) and/or airbag systems, please contact Volvo at:

#### In the USA

Volvo Car USA, LLC  
Customer Care Center  
1 Volvo Drive

P.O. Box 914

Rockleigh, New Jersey 07647

1-800-458-1552

### In Canada

Volvo Cars of Canada Corp.

National Customer Service

9130 Leslie Street, Suite 101

Richmond Hill, Ontario L4B 0B9

1-800-663-8255

### WARNING

- No objects that add to the total weight on the seat should be placed on the front passenger's seat. If a child is seated in the front passenger's seat with any additional weight, this extra weight could cause the OWS system to enable the airbag, which might cause it to deploy in the event of a collision, thereby injuring the child.
- The seat belt should never be wrapped around an object on the front passenger's seat. This could interfere with the OWS system's function.
- The front passenger's seat belt should never be used in a way that exerts more pressure on the passenger than normal. This could increase the pressure exerted on the weight sensor by a child, and could result in the airbag being enabled, which might cause it to deploy in the event of a collision, thereby injuring the child.

### WARNING

- Keep the following points in mind with respect to the OWS system. Failure to follow these instructions could adversely affect the system's function and result in serious injury to the occupant of the front passenger's seat:
- The full weight of the front seat passenger should always be on the seat cushion. The passenger should never lift him/herself off the seat cushion using the armrest in the door or the center console, by pressing the feet on the floor, by sitting on the edge of the seat cushion, or by pressing against the backrest in a way that reduces pressure on the seat cushion. This could cause OWS to disable the front, passenger's side airbag.



### **WARNING**

- Do not place any type of object on the front passenger's seat in such a way that jamming, pressing, or squeezing occurs between the object and the front seat, other than as a direct result of the correct use of the Automatic Locking Retractor/Emergency Locking Retractor (ALR/ELR) seat belt.
- No objects should be placed under the front passenger's seat. This could interfere with the OWS system's function.

### **Related information**

- Airbag system (p. 65)

### **Side impact airbags**

As an enhancement to the structural side impact protection built into your vehicle, it is also equipped with Side Impact Protection System (SIPS) airbags.



The SIPS airbag system is designed to help increase occupant protection in the event of certain side impact collisions. The SIPS airbags are designed to deploy only during certain side-impact collisions, depending on the crash severity, angle, speed and point of impact.

### **NOTE**

SIPS airbag deployment (one airbag) occurs only on the side of the vehicle affected by the impact. The airbags are not designed to deploy in all side impact situations.

### **Components in the SIPS airbag system**

This SIPS airbag system consists of a gas generator, the side airbag modules built into the out-board sides of both front seat backrests, and electronic sensors/wiring.

**⚠ WARNING**

- The SIPS airbag system is a supplement to the structural Side Impact Protection System and the three-point seat belt system. It is not designed to deploy during collisions from the front or rear of the vehicle or in rollover situations.
- The use of seat covers on the front seats may impede SIPS airbag deployment.
- No objects, accessory equipment or stickers may be placed on, attached to or installed near the SIPS airbag system or in the area affected by SIPS airbag deployment.
- Never try to open or repair any components of the SIPS airbag system. This should be done only by a trained and qualified Volvo service technician.
- In order for the SIPS airbag to provide its best protection, both front seat occupants should sit in an upright position with the seat belt properly fastened.
- Failure to follow these instructions can result in injury to the occupants of the vehicle in the event of an accident.

**Related information**

- Airbag system (p. 65)
- Seat belts (p. 60)

**Inflatable curtains**

The inflatable curtain is designed to help protect the heads of the occupants of the front seats and the occupant of the outboard rear seating positions in certain side impact collisions.

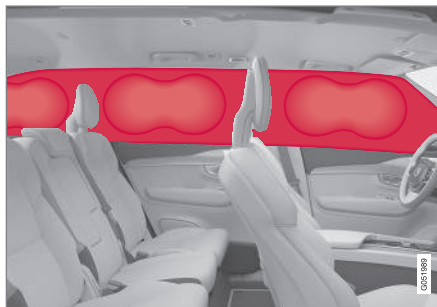

This system consists of inflatable curtains located along the sides of the roof liners, stretching from the center of both front side windows to the rear edge of the rear side door windows.

In certain side impacts, **both** the Inflatable Curtain (IC) and the side Impact Airbag System (SIPS airbag) will deploy. The IC and the SIPS airbag deploy simultaneously.

**⚠ WARNING**

- Never try to open or repair any components of the IC system. This should be done only by a trained and qualified Volvo service technician.
- Never hang heavy items from the ceiling handles. This could impede deployment of the Inflatable Curtain.
- The cargo area and rear seat should not be loaded to a level higher than 4 in. (10 cm) below the upper edge of the rear side windows. Objects placed higher than this level could impede the function of the Inflatable Curtain.
- In order for the IC to provide its best protection, both front seat occupants and both outboard rear seat occupants should sit in an upright position with the seat belt properly fastened; adults using the seat belt and children using the proper child restraint system.

**Related information**

- Airbag system (p. 65)
- Side impact airbags (p. 72)
- Child safety (p. 75)
- Seat belts (p. 60)

## Safety mode

As a safety precaution after a collision, the functionality of some of the vehicle's systems may be reduced.

If the vehicle has been involved in a collision, the text **Safety mode** may appear in the information display.

### NOTE

This text can only be shown if the display is undamaged and the vehicle's electrical system is intact.

Safety mode is a feature that is triggered if one or more of the safety systems such as the front/side airbags inflatable curtain, etc., or one or more of the seat belt pretensioners has deployed. The collision may have damaged an important function in the vehicle, such as the fuel lines, sensors for one of the safety systems, the brake system, etc.

### WARNING

- Never attempt to repair the vehicle yourself or to reset the electrical system after the vehicle has displayed **Safety mode**. This could result in injury or improper system function.
- Restoring the vehicle to normal operating status should only be done by a trained and qualified Volvo service technician.
- After **Safety mode** has been displayed, if you detect the odor of fuel vapor, or see any signs of fuel leakage, do not attempt to start the vehicle. Leave the vehicle immediately.

### Related information

- Starting or moving a vehicle in safety mode (p. 74)
- General safety information (p. 56)

## Starting or moving a vehicle in safety mode

If **Safety mode** has been set, it may be possible to start and move the vehicle, for example, if it is blocking traffic.

### Starting the vehicle in safety mode

1. Check the vehicle for damage, particularly for fuel leakage or the smell of gasoline fumes.

If the damage to the vehicle is minor and there is no fuel leakage/fumes, you may attempt to start the engine and move the vehicle.

### WARNING

If you smell gasoline fumes or detect fuel leakage while **Safety mode** See **Owner's manual** is displayed in the instrument panel, **do not attempt to start the vehicle**. Leave the vehicle immediately.

2. Turn the start knob to **STOP** and release it.
3. Try to start the vehicle.
  - > **Vehicle start System check, wait** will be displayed in the instrument panel while the vehicle's electrical system attempts to reset to normal mode.



**⚠ WARNING**

If the message **Safety mode See Owner's manual** is still displayed, the vehicle should not be driven and must be towed. Concealed faults may make the vehicle difficult to control.

**Moving the vehicle after safety mode has been set**

If the message **Normal mode The vehicle is now in normal mode** is displayed, the vehicle may be moved carefully from its present position if, for example, it is blocking traffic.

**It should, however, not be moved farther than is absolutely necessary.**

**⚠ WARNING**

After **Safety mode** has been set, the vehicle should not be driven or towed (pulled on the ground by another vehicle). It must be transported on a flatbed tow truck to a trained and qualified Volvo service technician for inspection/repairs.

**Related information**

- Safety mode (p. 74)
- Towing recommendations (p. 369)

**Child safety**

Children should always be seated safely when traveling in the vehicle.

**General information**

Volvo recommends the proper use of restraint systems for all occupants including children. Remember that, regardless of age and size, a child should always be properly restrained in a vehicle.

Your vehicle is also equipped with ISOFIX/LATCH attachments, which make it more convenient to install child seats.

Some restraint systems for children are designed to be secured in the vehicle by lap belts or the lap portion of a lap-shoulder belt. Such child restraint systems can help protect children in vehicles in the event of an accident only if they are used properly. However, children could be endangered in a crash if the child restraints are not properly secured in the vehicle. Failure to follow the installation instructions for your child restraint can result in your child striking the vehicle's interior in a sudden stop.

Holding a child in your arms is NOT a suitable substitute for a child restraint system. In an accident, a child held in a person's arms can be crushed between the vehicle's interior and an unrestrained person. The child could also be injured by striking the interior, or by being ejected from the vehicle during a sudden maneuver or

impact. The same can also happen if the infant or child rides unrestrained on the seat. Other occupants should also be properly restrained to help reduce the chance of injuring or increasing the injury of a child.

All states and provinces have legislation governing how and where children should be carried in a vehicle. Find out the regulations existing in your state or province. Recent accident statistics have shown that children are safer in rear seating positions than front seating positions when properly restrained. A child restraint system can help protect a child in a vehicle. Here's what to look for when selecting a child restraint system:

It should have a label certifying that it meets applicable Federal Motor Vehicle Safety Standards (FMVSS 213) – or in Canada, CMVSS 213.

Make sure the child restraint system is approved for the child's height, weight and development – the label required by the standard or regulation, or instructions for infant restraints, typically provide this information.

In using any child restraint system, we urge you to carefully look over the instructions that are provided with the restraint. Be sure you understand them and can use the device properly and safely in this vehicle. A misused child restraint system can result in increased injuries for both the infant or child and other occupants in the vehicle.



- ◀◀ When a child has outgrown the child safety seat, you should use the rear seat with the standard seat belt fastened. The best way to help protect the child here is to place the child on a cushion so that the seat belt is properly located on the hips. Legislation in your state or province may mandate the use of a child seat or cushion in combination with the seat belt, depending on the child's age and/or size. Please check local regulations.

A specially designed and tested booster cushion and backrest can be obtained from your Volvo retailer. See also the article "Integrated booster cushion."



### **WARNING**

- Do not use child safety seats or child booster cushions/backrests in the front passenger's seat. We also recommend that children under 4 feet 7 inches (140 cm) in height who have outgrown these devices sit in the rear seat with the seat belt fastened.
- On hot days, the temperature in the vehicle interior can rise very quickly. Exposure to these high temperatures for even a short period of time can cause heat-related injury or death. Small children are particularly at risk. Never leave children unattended in a vehicle.

Child seats should always be registered.

### **Volvo's recommendations**

Why does Volvo believe that no child should sit in the front seat of a car? It's quite simple really. A front airbag is a very powerful device designed, by law, to help protect an adult.

Because of the size of the airbag and its speed of inflation, a child should never be placed in the front seat, even if he or she is properly belted or strapped into a child safety seat. Volvo has been an innovator in safety for over seventy-five years, and we'll continue to do our part. But we need your help. Please remember to put your children in the back seat, and buckle them up.

### **WARNING**

A child restraint should never be reused if:

- The vehicle has been involved in a collision, no matter how minor
- Its history is unknown
- It is older than the manufacturer's expiration date

### **Volvo has some very specific recommendations**

- Always wear your seat belt.
- Airbags are a SUPPLEMENTAL safety device which, when used with a three-point seat belt can help reduce serious injuries during certain types of accidents. Volvo recommends that you do not disconnect the air-bag system in your vehicle.
- Volvo strongly recommends that everyone in the vehicle be properly restrained.
- Volvo recommends that ALL occupants (adults and children) shorter than 4 feet 7 inches (140 cm) be seated in the back seat of any vehicle with a front passenger side airbag.
- Drive safely!

### **Related information**

- Integrated booster cushion\* (p. 87)
- Booster cushions (p. 83)

- Convertible seats (p. 81)
- Infant seats (p. 79)
- ISOFIX/LATCH lower anchors (p. 84)
- Top tether anchors (p. 86)

## Child restraints

Suitable child restraints should always be used when children travel in the vehicle.

### Child restraint systems



Infant seat

There are three main types of child restraint systems: infant seats, convertible seats and booster cushions. They are classified according to the child's age and size.

The child restraint should be secured using a three-point seat belt, ISOFIX/LATCH anchors or top tether anchors.

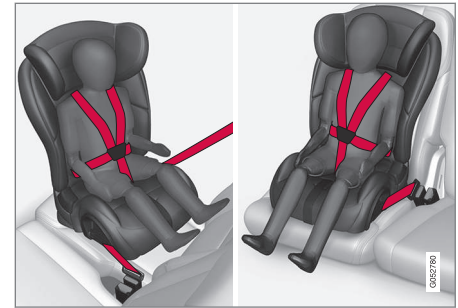

Convertible seat

### **⚠ WARNING**

A child seat should never be used in the front passenger seat of any vehicle with a front passenger airbag – not even if the "Passenger airbag off" symbol near the rear-view mirror is illuminated (on vehicles equipped with Occupant Weight Sensor). If the severity of an accident were to cause the airbag to inflate, this could lead to serious injury or death to a child seated in this position.



Booster cushion

### WARNING

Always refer to the child restraint manufacturer's instructions for detailed information on securing the restraint.

### WARNING

- When not in use, keep the child restraint system secured or remove it from the passenger compartment to help prevent it from injuring passengers in the event of a sudden stop or collision.
- A small child's head represents a considerable part of its total weight and its neck is still very weak. Volvo recommends that children up to age 4 travel, properly restrained, facing rearward. In addition, Volvo recommends that children should ride rearward facing, properly restrained, as long as possible.

### Automatic Locking Retractor/ Emergency Locking Retractor (ALR/ ELR)

To make child seat installation easier, each seat belt (except for the driver's belt) is equipped with a locking mechanism to help keep the seat belt taut.

#### When attaching the seat belt to a child seat:

1. Attach the seat belt to the child seat according to the child seat manufacturer's instructions.
2. Pull the seat belt out as far as possible.
3. Insert the seat belt latch plate into the buckle (lock) in the usual way.

4. Release the seat belt and pull it taut around the child seat.

A sound from the seat belt retractor will be audible at this time and is normal. The belt will now be locked in place. This function is automatically disabled when the seat belt is unlocked and the belt is fully retracted.

### WARNING

Do not use child safety seats or child booster cushions/backrests in the front passenger's seat. We also recommend that children who have outgrown these devices sit in the rear seat with the seat belt properly fastened.

### Child restraint registration and recalls

Child restraints could be recalled for safety reasons. You must register your child restraint to be reached in a recall. To stay informed about child safety seat recalls, be sure to fill out and return the registration card that comes with new child restraints.

Child restraint recall information is readily available in both the U.S. and Canada. For recall information in the U.S., call the U.S. Government's Auto Safety Hotline at 1-800-424-9393 or go to <http://www-odi.nhtsa.dot.gov/cars/problems/recalls/register/childseat/index.cfm>. In Canada, visit Transport Canada's Child Safety website at <http://www.tc.gc.ca/roadsafety/childsafety/menu.htm>.

## Infant seats

Suitable child restraints should always be used when children (depending on their age/size) are seated in the vehicle.

### Securing an infant seat with a seat belt



Do not place the infant seat in the front passenger's seat

1. Place the infant seat in the rear seat of the vehicle.
2. Attach the seat belt to the infant seat according to the manufacturer's instructions.



Positioning the seat belt through the infant seat

### **WARNING**

- An infant seat must be in the rear-facing position only.
- The infant seat should not be positioned behind the driver's seat unless there is adequate space for safe installation.

### **WARNING**

A child seat should never be used in the front passenger seat of any vehicle with a front passenger airbag – not even if the "Passenger airbag off" symbol near the rear-view mirror is illuminated (on vehicles equipped with Occupant Weight Sensor). If the severity of an accident were to cause the airbag to inflate, this could lead to serious injury or death to a child seated in this position.

3.



Fasten the seat belt

Fasten the seat belt by inserting the latch plate into the buckle (lock) until a distinct click is audible.



Pull out the shoulder section of the seat belt

4. Pull the shoulder section of the seat belt out as far as possible to activate the belt's automatic locking function.

**i NOTE**

The locking retractor will automatically release when the seat belt is unbuckled and allowed to retract fully.

5. Press the infant seat firmly in place, let the seat belt retract and pull it taut. A sound from the seat belt retractor's automatic locking function will be audible at this time and is normal. The seat belt should now be locked in place.



Ensure that the seat is securely in place

6. Push and pull the infant seat along the seat belt path to ensure that it is held securely in place by the seat belt.

**⚠ WARNING**

It should not be possible to move the child restraint (child seat) more than 1 in. (2.5 cm) in any direction along the seat belt path.

The infant seat can be removed by unbuckling the seat belt and letting it retract completely.

**Related information**

- ISOFIX/LATCH lower anchors (p. 84)
- Top tether anchors (p. 86)
- Convertible seats (p. 81)
- Buckling and unbuckling seat belts (p. 62)
- Child safety (p. 75)

## Convertible seats

Suitable child restraints should always be used when children (depending on their age/size) are seated in the vehicle.

### Securing a convertible seat with a seat belt



Do not place the convertible seat in the front passenger's seat

Convertible seats can be used in either a forward or rearward-facing position, depending on the age and size of the child.

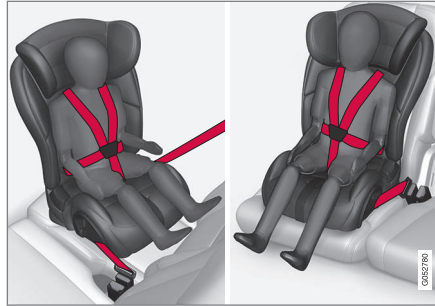

Route the seat belt through the convertible seat

### WARNING

Always use a convertible seat that is suitable for the child's age and size. See the convertible seat manufacturer's recommendations.

1. Place the convertible seat in the rear seat of the vehicle.

### WARNING

- A small child's head represents a considerable part of its total weight and its neck is still very weak. Volvo recommends that children up to age 4 travel, properly restrained, facing rearward. In addition, Volvo recommends that children should ride rearward facing, properly restrained, as long as possible.
  - Convertible child seats should be installed in the rear seat only.
  - A rear-facing convertible seat should not be positioned behind the driver's seat unless there is adequate space for safe installation.
2. Attach the seat belt to the convertible seat according to the manufacturer's instructions.



Fasten the seat belt

3. Fasten the seat belt by inserting the latch plate into the buckle (lock) until a distinct click is audible.
4. Pull the shoulder section of the seat belt out as far as possible to activate the belt's automatic locking function.

**NOTE**

The locking retractor will automatically release when the seat belt is unbuckled and allowed to retract fully.

5. Press the convertible seat firmly in place, let the seat belt retract and pull it taut. A sound from the seat belt retractor's automatic locking function will be audible at this time and is normal. The seat belt should now be locked in place.



Pull out the shoulder section of the seat belt

6. Push and pull the convertible seat along the seat belt path to ensure that it is held securely in place by the seat belt.

**WARNING**

It should not be possible to move the child restraint (child seat) more than 1 in. (2.5 cm) in any direction along the seat belt path.

The convertible seat can be removed by unbuckling the seat belt and letting it retract completely.



Ensure that the seat is securely in place

**WARNING**

A child seat should never be used in the front passenger seat of any vehicle with a front passenger airbag – not even if the "Passenger airbag off" symbol near the rear-view mirror is illuminated. If the severity of an accident were to cause the airbag to inflate, this could lead to serious injury or death to a child seated in this position.



### Related information

- ISOFIX/LATCH lower anchors (p. 84)
- Top tether anchors (p. 86)
- Booster cushions (p. 83)
- Buckling and unbuckling seat belts (p. 62)
- Child safety (p. 75)

## Booster cushions

### Securing a booster cushion



Position the child correctly on the booster cushion

Booster cushions are recommended for children who have outgrown convertible seats.

1. Place the booster cushion in the rear seat of the vehicle.
2. With the child properly seated on the booster cushion, attach the seat belt to or around the cushion according to the manufacturer's instructions.

3. Fasten the seat belt by inserting the latch plate into the buckle (lock) until a distinct click is audible.

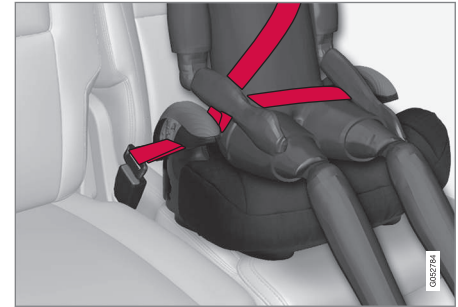

Positioning the seat belt

4. Ensure that the seat belt is pulled taut and fits snugly around the child.

### **WARNING**

- The hip section of the three-point seat belt must fit snugly across the child's hips, not across the stomach.
- The shoulder section of the three-point seat belt should be positioned across the chest and shoulder.
- The shoulder belt must never be placed behind the child's back or under the arm.

#### ◀ Related information

- ISOFIX/LATCH lower anchors (p. 84)
- Top tether anchors (p. 86)
- Child safety (p. 75)
- Buckling and unbuckling seat belts (p. 62)
- Integrated booster cushion\* (p. 87)

### ISOFIX/LATCH lower anchors

Lower anchors for ISOFIX/LATCH-equipped child seats are located in the second row, out-board seats, hidden below the backrest cushions.

#### Using the ISOFIX/LATCH lower child seat anchors



Location of the ISOFIX/LATCH anchors

Symbols on the seat back upholstery mark the ISOFIX/LATCH anchor positions as shown. To access the anchors, kneel on the seat cushion and locate the anchors by feel. Always follow your child seat manufacturer's installation instructions, and use both ISOFIX/LATCH lower anchors and top tethers whenever possible.

#### To access the anchors

1. Put the child restraint in position.

2. Kneel on the child restraint to press down the seat cushion and locate the anchors by feel.
3. Fasten the attachment on the child restraint's lower straps to the ISOFIX/LATCH/LATCH lower anchors.
4. Firmly tension the lower child seat straps according to the manufacturer's instructions.

#### **⚠ WARNING**

Volvo's ISOFIX/LATCH anchors conform to FMVSS/CMVSS standards. Always refer to the child restraint system's manual for weight and size ratings.

#### **i NOTE**

- The rear seat's center position is not equipped with ISOFIX/LATCH lower anchors. When installing a child restraint in this position, attach the restraint's top tether strap (if it is so equipped) to the top tether anchorage point and secure the restraint with the vehicle's center seat belt.
- Always follow your child seat manufacturer's installation instructions, and use both ISOFIX/LATCH lower anchors and top tethers whenever possible.

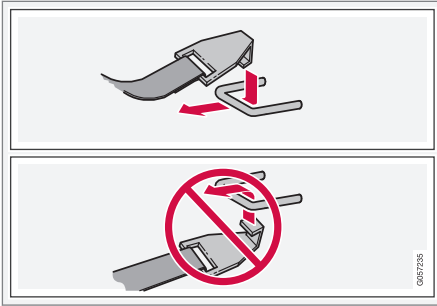

Fasten the attachment correctly to the ISOFIX/LATCH lower anchors

### **⚠ WARNING**

- Be sure to fasten the attachment correctly to the anchor (see the illustration). If the attachment is not correctly fastened, the child restraint may not be properly secured in the event of a collision.
- The ISOFIX/LATCH lower child restraint anchors are only intended for use with child seats positioned in the outboard seating positions. These anchors are not certified for use with any child restraint that is positioned in the center seating position. When securing a child restraint in the center seating position, use only the vehicle's center seat belt.

### Related information

- Top tether anchors (p. 86)

### Lower child seat attachment points<sup>1</sup>

The vehicle is equipped with lower attachment points for child seats in the second row of seats.

The lower attachment points are intended for use with rear-facing child restraints.

Always follow the child restraint manufacturer's installation instructions when attaching a child restraint to these attachment points.

### Location



Attachment points in the front seat

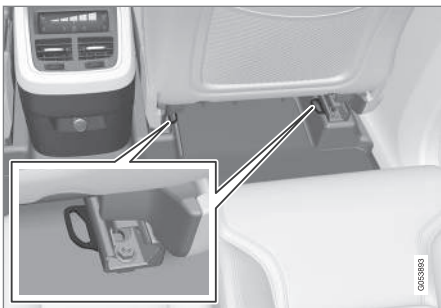

Attachment points in the second row of seats

The attachment points in the second row of seats are in the rear section of the front seat's floor rails.

### **WARNING**

A child seat should never be used in the front passenger seat of any vehicle with a front passenger airbag – not even if the "Passenger airbag off" symbol near the rear-view mirror is illuminated (on vehicles equipped with Occupant Weight Sensor). If the severity of an accident were to cause the airbag to inflate, this could lead to serious injury or death to a child seated in this position.

### Related information

- Child restraints (p. 77)
- ISOFIX/LATCH lower anchors (p. 84)
- Occupant weight sensor (p. 69)

### Top tether anchors

Your Volvo is equipped with child restraint top tether anchorages for all three seating positions in the rear seat. They are located on the rear side of the backrests.

### Child restraint anchorages



Top tether anchors and symbols on the rear side of the second row backrests. There is no symbol for the center anchor position.

<sup>1</sup> Not available in all markets

### Securing a child seat

1. Place the child restraint on the rear seat.
  2. Route the top tether strap under the head restraint and attach it to the anchor.
  3. Attach lower tether straps to the lower ISO-FIX/LATCH anchors. If the child restraint is not equipped with lower tether straps, or the restraint is used in the center seating position, follow instructions for securing a child restraint using the Automatic Locking Retractor seat belt.
- Firmly tension all straps.

Refer also to the child seat manufacturer's instructions for information on securing the child seat.

#### **i** NOTE

On models equipped with the optional cargo area cover, this cover should be removed before a child seat is attached to the child restraint anchors.

#### **⚠** WARNING

- Always refer to the recommendations made by the child restraint manufacturer.
- Volvo recommends that the top tether anchors be used when installing a forward-facing child restraint.
- Never route a top tether strap over the top of the head restraint. The strap should be routed beneath the head restraint.
- Child restraint anchorages are designed to withstand only those loads imposed by correctly fitted child restraints. Under no circumstances are they to be used for adult seat belts or harnesses. The anchorages are not able to withstand excessive forces on them in the event of collision if full harness seat belts or adult seat belts are installed to them. An adult who uses a belt anchored in a child restraint anchorage runs a great risk of suffering severe injuries should a collision occur.
- Do not install rear speakers that require the removal of the top tether anchors or interfere with the proper use of the top tether strap.

#### Related information

- Child safety (p. 75)
- Child restraints (p. 77)

### Integrated booster cushion\*

Volvo's optional integrated booster cushion is located in the rear seat's center position and is designed to raise the child higher so that the shoulder strap crosses over the child's collarbone, not over the neck.



## « Integrated booster cushion<sup>2</sup>

This booster cushion has been specially designed to help safeguard children in the rear seat. It should be stowed (folded down into the seat cushion) when not in use. When using an integrated booster cushion, the child must be secured with the vehicle's three-point seat belt.

If using a booster cushion does not result in proper positioning of the shoulder strap, then the child should be placed in a properly secured child restraint. The shoulder belt must never be placed behind the child's back or under the arm.

Use only with children who weigh between 33 and 80 pounds (15 – 36 kg) and whose height is between 38 and 54 inch (97 – 137 cm).

**In Canada:** 18 kg (40 lbs) is the minimum weight requirement for a child using booster seats according to the Canadian regulation CMVSS 213.4

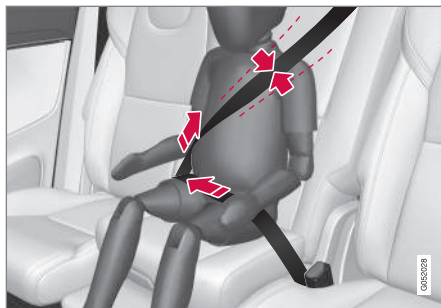

Correct seating position: the shoulder belt is across the collarbone

## **⚠ WARNING**

DEATH or SERIOUS INJURY can occur

- Follow all instructions on this child restraint and in the vehicle's owner's manual.
- Make sure the booster cushion is securely locked before the child is seated.
- Use only with children who weigh between 33 and 80 pounds (15 – 36 kg) and whose height is between 38 and 54 inch (97 – 137 cm). In Canada: 18 kg (40 lbs) is the minimum weight requirement for a child using booster seats according to the Canadian regulation CMVSS 213.4
- Use only the vehicle's lap and shoulder belt system when restraining the child in this booster seat.
- In the event of a collision while the integrated booster cushion was occupied, the entire booster cushion and seat belt must be replaced. The booster cushion should also be replaced if it is badly worn or damaged in any way. This work should be

<sup>2</sup> Canada only: This cushion may be referred to as a built-in booster cushion.

performed by a trained and qualified Volvo service technician only.

Before driving, check that:

- The integrated booster cushion has been correctly raised and locked in position.
- That the seat belt is properly positioned and is taut.
- The shoulder section of the seat belt is across the child's collarbone, not over the neck.
- The lap section of the seat belt is across the child's hips and not the abdomen.
- The head restraint is set to same height as the child's head so that, if possible, the entire back of the child's head is covered.

### Related information

- Seat belts (p. 60)
- Child safety (p. 75)
- Raising the integrated booster cushion\* (p. 89)
- Stowing the integrated booster cushion\* (p. 90)

## Raising the integrated booster cushion\*

The integrated booster cushion in the second row of seat's center position must be correctly raised before use.

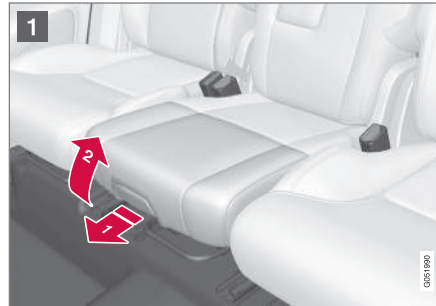

- 1** Pull the handle forward and upward to release the booster cushion.

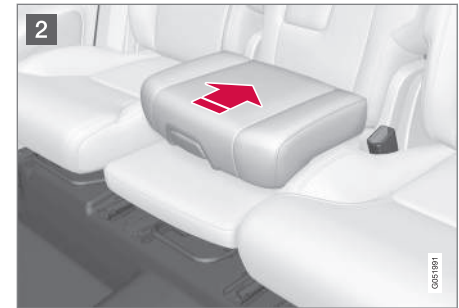

- 2** Press the booster cushion rearward to lock it in position.



## **⚠️ WARNING**

DEATH or SERIOUS INJURY can occur

- Follow all instructions on this child restraint and in the vehicle's owner's manual.
- Make sure the booster cushion is securely locked before the child is seated.
- Use only with children who weigh between 33 and 80 pounds (15 – 36 kg) and whose height is between 38 and 54 inch (97 – 137 cm). In Canada: 18 kg (40 lbs) is the minimum weight requirement for a child using booster seats according to the Canadian regulation CMVSS 213.4
- Use only the vehicle's lap and shoulder belt system when restraining the child in this booster seat.
- In the event of a collision while the integrated booster cushion was occupied, the entire booster cushion and seat belt must be replaced. The booster cushion should also be replaced if it is badly worn or damaged in any way. This work should be performed by a trained and qualified Volvo service technician only.

## Related information

- Integrated booster cushion\* (p. 87)
- Stowing the integrated booster cushion\* (p. 90)

## Stowing the integrated booster cushion\*

The integrated booster cushion in the second row of seat's center position should be stowed (folded down) when not in use.



- 1 Pull the handle forward to release the booster cushion.



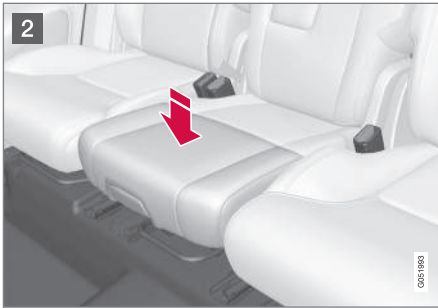

- 2** Press down on the center of the booster cushion to return it to the stowed position.

**i NOTE**

The booster cushion must be in the stowed position before the rear seat backrests are folded down.

**! CAUTION**

Be sure there are no loose objects under the booster cushion before it is stowed.

**! WARNING**

DEATH or SERIOUS INJURY can occur

- Follow all instructions on this child restraint and in the vehicle's owner's manual.
- Make sure the booster cushion is securely locked before the child is seated.
- Use only with children who weigh between 33 and 80 pounds (15 – 36 kg) and whose height is between 38 and 54 inch (97 – 137 cm). In Canada: 18 kg (40 lbs) is the minimum weight requirement for a child using booster seats according to the Canadian regulation CMVSS 213.4
- Use only the vehicle's lap and shoulder belt system when restraining the child in this booster seat.
- In the event of a collision while the integrated booster cushion was occupied, the entire booster cushion and seat belt must be replaced. The booster cushion should also be replaced if it is badly worn or damaged in any way. This work should be performed by a trained and qualified Volvo service technician only.

**Related information**

- Integrated booster cushion\* (p. 87)
- Raising the integrated booster cushion\* (p. 89)



# INSTRUMENTS AND CONTROLS

### Instruments and controls

This overview shows the location of the primary displays, and controls/buttons/switches.

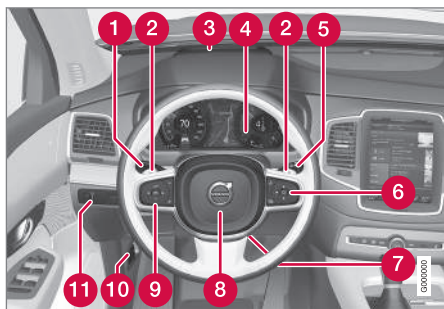

	Display/function/control
1	Parking lights, daytime running lights, low beams, high beams, turn signals, front fog lights/corner illumination*, rear fog lights, trip computer reset
2	Transmission manual shifting paddle*
3	Head-up-display*
4	Instrument panel
5	Wipers/washers, rain sensor*
6	Right-side steering wheel keypad

	Display/function/control
7	Steering wheel adjustment
8	Horn
9	Left-side steering wheel keypad
10	Hood open
11	Display lighting, tailgate unlock, tailgate open/close*



	Display/function/control
1	Front reading lights and courtesy lighting
2	Laminated panoramic roof*

	Display/function/control
3	Ceiling console display
4	Manual rearview mirror auto-dim (certain markets only)

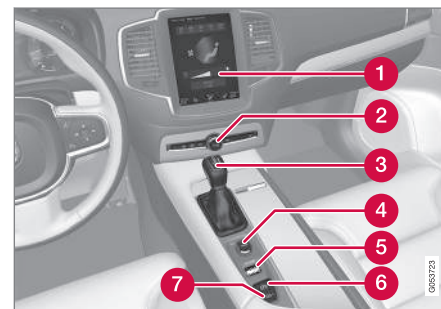

	Display/function/control
1	Center display
2	Hazard warning flashers, max. defroster/heated windshield*, media player, glove compartment open
3	Gear selector
4	Start knob
5	Drive modes*

	Display/function/control
6	Parking brake
7	Auto-hold brakes

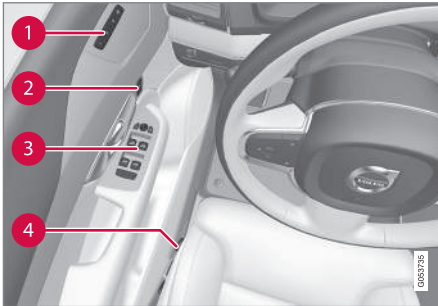

	Display/function/control
1	Memory control for: <ul style="list-style-type: none"> <li>power seats*</li> <li>door mirrors</li> <li>head-up display*</li> </ul>
2	Door open, door/tailgate lock/unlock
3	Power windows, power door mirrors
4	Controls for power front seat*

## Trip computer

The trip computer registers and calculates information such as distance driven, fuel consumption and average speed. This information is displayed in the instrument panel.

To help promote fuel efficient driving, the trip computer provides readings for current and average fuel consumption.

### The trip computer includes the following gauges:

- Trip odometers
- Odometer
- Current fuel consumption
- Distance to empty
- Tourist (alternative speedometer)

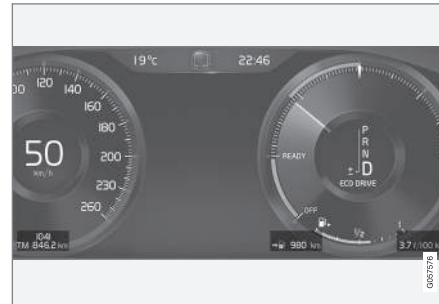

12" instrument panel

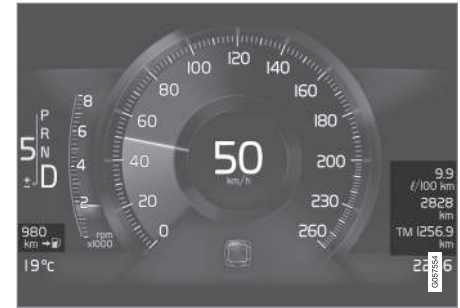

8" instrument panel

### Trip odometer

There are two trip odometers: TM and TA. During a drive, the trip odometer registers:

- Mileage
- Driving time
- Average speed
- Average fuel consumption

The values displayed are those since the last time the trip odometer was reset.

### Odometer

The odometer registers the vehicle's total mileage and cannot be reset.

### Current fuel consumption

This gauge shows the current fuel consumption. This reading is updated once a second.

### Distance to empty

This function shows the approximate distance that can be driven on the fuel remaining in the tank.

The calculation is based on average fuel consumption during the last 20 miles (30 km) of driving and the amount of fuel remaining in the tank.

When the gauge displays "----", there is very little useable fuel remaining in the tank; refuel as soon as possible.

The accuracy of this figure may vary if your driving style changes. An economical driving style will generally increase this distance.

### Tourist (alternative speedometer)

This is an alternative digital speedometer can be used when driving in areas in which the speed limit is listed in a different unit of measure. If the speedometer is in **mph**, this gauge will show the vehicle's speed in **km/h** and vice versa.

### Related information

- Displaying trip computer information (p. 96)
- Displaying trip statistics (p. 97)

### Displaying trip computer information

The trip computer registers and calculates information such as distance driven, fuel consumption and average speed. This information is displayed in the instrument panel.

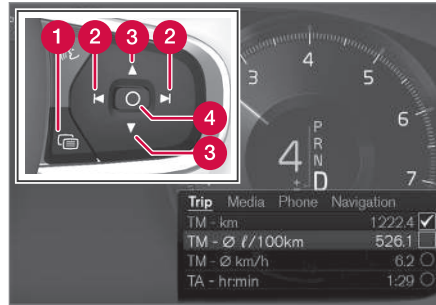

Use the right-side steering wheel keypad to navigate in the trip computer (generic illustration)

- 1 Open/close the app menu
- 2 Left/right arrow keys
- 3 Up/down arrow keys
- 4 Confirm

1. Press (1) to open the app menu in the instrument panel.

The app menu cannot be opened if there is an a message in the instrument panel that has not been confirmed. Press (4) to confirm.

2. The top four lines show readings from trip odometer TM. The following four lines show readings from trip odometer TA. Scroll up/down in the list using (3).
3. Scroll to the selection buttons in the lines below TA and select the trip odometer to be displayed.

- Current fuel consumption
- Distance to empty
- Odometer
- Trip odometers TM, TA or none
- Tourist (alternative speedometer).

Select or deselect an alternative using the center button (4). The change will be made immediately.

## Resetting a trip odometer



Reset trip odometer TM by pressing and holding the **RESET** button the left-side steering wheel lever. Trip odometer TA resets automatically if the ignition is switched off for more than 4 hours.

## Changing the unit of measure

Change the units of measure for driven distance and fuel consumption in the center display's Top view by selecting **Settings** → **System** → **Units of Measurement** and marking the desired unit.

### **i** NOTE

Changing these units of measure will also change the ones used in the Volvo navigation system\*.

## Related information

- Displaying trip statistics (p. 97)
- Trip computer (p. 95)

## Displaying trip statistics

Trip computer statistics can be displayed graphically in the center display.



Open the **Driver performance** app in the app menu to display trip statistics.

Each bar in the graph represents a driving distance of 1 mile, 10 miles or 100 miles<sup>1</sup>

depending on the current scale; bars are added from the right and the bar at the far right shows the value for the current trip.

Average fuel consumption is calculated from the most recent time at which the current trip odometer was reset.

### Trip statistic settings

Select **Preferences** to:

- change the graph's scale
- Reset data after each trip (this occurs if the vehicle remains parked for more than 4 hours)
- Reset data for the current trip

<sup>1</sup> This can also be displayed in kilometers.

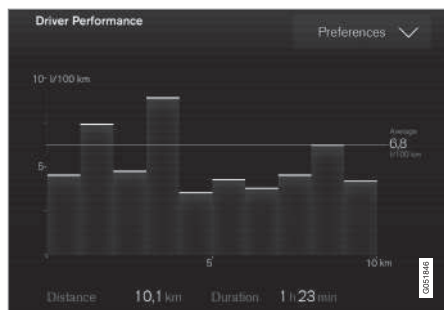

The illustration is generic; the layout may vary depending on the model or due to software updates

### Changing the unit of measure

Change the units of measure for driven distance and fuel consumption in the center display's Top view.

1. Tap **Settings** in Top view.
2. Tap **System** → **Units**.
3. Under **Units of Measurement**, select: **Metric**, **Imperial** or **US**.

### Related information

- Trip computer (p. 95)
- Displaying trip computer information (p. 96)

## HomeLink® Wireless Control System\*

HomeLink® can be used to open garage doors, gates, etc.

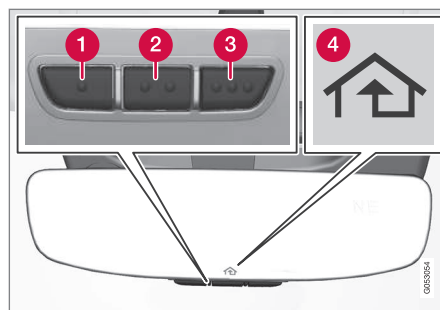

- 1 Button 1
- 2 Button 2
- 3 Button 3
- 4 Indicator light

The HomeLink®<sup>2</sup> Wireless Control System provides a convenient way to replace up to three hand-held radio-frequency (RF) transmitters used to activate devices such as gate operators, garage door openers, entry door locks, security systems, even home lighting. Additional informa-

tion can be found on the Internet at, [www.homelink.com/](http://www.homelink.com/) [www.youtube.com/HomelinkGentex/](http://www.youtube.com/HomelinkGentex/) or by phoning the hotline at 1-800-355-3515.

### **WARNING**

- If you use HomeLink® to open a garage door or gate, be sure no one is near the gate or door while it is in motion.
- When programming a garage door opener, it is advised to park outside of the garage.
- Do not use HomeLink® with any garage door opener that lacks safety stop and reverse features as required by U.S. federal safety standards (this includes any garage door opener model manufactured before April 1, 1982). A garage door that cannot detect an object - signaling the door to stop and reverse - does not meet current U.S. federal safety standards. For more information, contact HomeLink at: [www.homelink.com](http://www.homelink.com).

Retain the original transmitter of the RF device you are programming for use in other vehicles as well as for future HomeLink programming. It is also suggested that upon the sale of the vehicle, the programmed HomeLink buttons be erased

<sup>2</sup> HomeLink and the HomeLink house are registered trademarks of Gentex Corporation.



for security purposes. See the article "Programming HomeLink."

### Related information

- Programming the HomeLink® Wireless Control System\* (p. 99)

## Programming the HomeLink® Wireless Control System\*

### NOTE

Some vehicles may require the ignition to be switched on or be in the "accessories" position for programming and/or operation of HomeLink. It is also recommended that a new battery be placed in the hand-held transmitter of the device being programmed to HomeLink for quicker training and accurate transmission of the radio-frequency signal. The HomeLink buttons must be reset first. When this has been completed, Homelink is in learning mode so that you can perform programming.

To program HomeLink®

1. Press the HomeLink® button to be programmed. The HomeLink® indicator will begin flashing yellow once a second. You do not need to continue holding the button.
2. Point the hand-held transmitter toward the HomeLink® button to be programmed and hold it approx. 6–12 inches (15–30 cm) away from the HomeLink® button. Do not obstruct the HomeLink® indicator light.

3. Press and hold the button on the original remote control that is to be programmed on HomeLink® and observe the HomeLink® indicator light. Hold the button until the indicator light has changed from flashing yellow once a second to either flashing green 10 times a second or by glowing steadily green. When the HomeLink® indicator light flashes or glows steadily green, the button on the original remote control can be released.
 

**Note:** for certain remote controls, the instructions listed under "Gate operators/Canadian programming" at the end of this article should be used instead of step 3.



4. Press the programmed HomeLink<sup>®</sup> button and check the indicator light.

**Indicator light glows steadily green:** programming has been completed. The garage door, gate, etc., should now be activated when the programmed button is pressed.

**Indicator light flashes 10 times a second:** press the HomeLink<sup>®</sup> button that is being programmed. Hold it for 2 seconds and release it. Repeat the "press/hold/release" sequence a second time, and, depending on the brand of the garage door opener, repeat this sequence a third time to complete the programming process. Programming should now be completed and the garage door, gate, etc., should now be activated when the programmed button is pressed.

**If the garage door, etc. still does not react:** continue with steps 6-8 to complete programming.

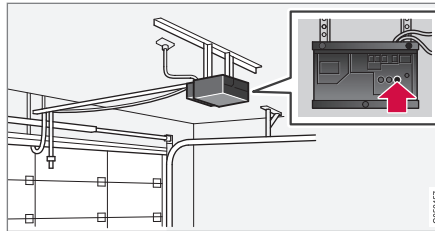

5. Locate the "training" button on the garage door opener, etc. The designation and color of the button may vary, depending on the manufacturer. It is usually located near the antenna attachment on the device.
6. Press the device's "training" button. When this has been done, step 8 must be completed within 30 seconds.
7. Press and hold the HomeLink<sup>®</sup> button being programmed for 2 seconds and release it. Repeat the "press/hold/release" sequence a second time, and, depending on the brand of the garage door opener, repeat this sequence a third time to complete the programming process. Programming should now be completed and the garage door, gate, etc., should now be activated when the programmed button is pressed.

### Gate Operator/Canadian Programming

Canadian radio-frequency laws require transmitter signals to "time-out" (or quit) after several seconds of transmission – which may not be long enough for HomeLink to pick up the signal during programming. Similar to this Canadian law, some U.S. gate operators are designed to "time-out" in the same manner.

If you live in Canada or you are having difficulties programming a gate operator or garage door opener by using the "Programming" procedures, **replace "Programming HomeLink" step 3 with the following:**

- Continue to press and hold the HomeLink button while you **press and release - every two seconds** ("cycle") your hand-held transmitter until the HomeLink indicator light changes from a slow to a rapidly blinking light. Now you may release both the HomeLink and hand-held transmitter buttons.

Proceed with "Programming" step 4 to complete.

### Using HomeLink<sup>®</sup>

When programming has been completed, HomeLink<sup>®</sup> can be used instead of the original remote controls.

To operate, press and hold the programmed HomeLink<sup>®</sup> button until the trained device begins to operate<sup>3</sup> (this may take several seconds). The

<sup>3</sup> Do not hold the button for more than 20 seconds as this will clear the programming of the button.

indicator light will glow steadily or flash when the button has been pressed. Activation will now occur for the trained device (i.e., garage door opener, gate operator, security system, entry door lock, home/office lighting, etc.).

### **i NOTE**

If the ignition is switched off, HomeLink will function for 30 minutes after the driver's door has been opened.

For convenience, the hand-held transmitter of the device may also be used at any time.

In the event that there are still programming difficulties or questions, contact HomeLink at: [www.HomeLink.com](http://www.HomeLink.com), [www.youtube.com/HomeLinkGentex](http://www.youtube.com/HomeLinkGentex) or by phoning the hotline at 1-800-355-3515.

### **Resetting HomeLink® buttons**

Use the following procedure to reset (erase programming) from the three HomeLink® buttons (individual buttons cannot be reset but can be "reprogrammed" as outlined in the following section):

1. Press and hold HomeLink® buttons 1 and 3 for approx. 10 seconds until the indicator light begins to flash green.

2. Release both buttons.
  - > HomeLink® is now in the training (or learning) mode and can be programmed at any time beginning with "To program HomeLink®" above.

### **Reprogramming a single HomeLink® button**

To reprogram an individual HomeLink® button:

1. Press and hold the desired HomeLink® button. **DO NOT** release the button.
2. The yellow indicator light will begin to flash after 20 seconds. Without releasing the HomeLink button, proceed with "To program HomeLink®" step 1 above.

For questions or comments, contact HomeLink at: [www.HomeLink.com](http://www.HomeLink.com), [www.youtube.com/HomeLinkGentex](http://www.youtube.com/HomeLinkGentex) or by phoning the hotline at 1-800-355-3515.

### **FCC (USA) and IC (Canada)**

This device complies with FCC rules part 15 and Industry Canada RSS-210. Operation is subject to the following two conditions: (1) This device may not cause harmful interference, and (2) This device must accept any interference that may be received including interference that may cause undesired operation. **WARNING:** The transmitter has been tested and complies with FCC and IC

rules. Changes or modifications not expressly approved by the party are prohibited.

### **i NOTE**

The transmitter has been tested and complies with FCC and IC rules. Changes or modifications not expressly approved by the party responsible for compliance could void the user's authority to operate the device.<sup>4</sup>

### **Related information**

- HomeLink® Wireless Control System\* (p. 98)

<sup>4</sup> The term "IC:" before the certification/registration number only signifies that Industry Canada technical specifications were met.

## Adjusting the power door mirrors

The control on the driver's door is used to adjust the position of the door mirrors.



Door mirror controls

### Adjusting

1. Press the **L** button for the left door mirror or the **R** button for the right door mirror. The light in the button comes on.
2. Adjust the position with the joystick in the center.
3. Press the **L** or **R** button again. The light should no longer be on.

### WARNING

Objects seen in the mirrors may appear further away than they actually are.

<sup>5</sup> Only on models equipped with a power driver's seat.

### Storing the position\*

The mirror positions are stored in the key memory\* when the vehicle has been locked with the remote key. When the vehicle is unlocked with the same remote key, the mirrors and the driver's seat adopt the stored positions when the driver's door is opened. The mirrors' position can also be stored in the power seat's\* memory.

### Tilting the door mirrors when parking<sup>5</sup>

The door mirrors can be tilted down to help give the driver a better view along the sides of the vehicle, for example when parallel parking.

- To activate this function, select reverse gear and press the **L** or **R** mirror control button to tilt the mirror down.
- The door mirror will reset to its normal position:
- after 10 seconds when reverse is disengaged
  - immediately if you press the corresponding **L** or **R** button again.

### NOTE

Only one mirror can be tilted down at a time.

### Automatically tilting the door mirrors when parking<sup>5</sup>

This function can be activated/deactivated in the center display.

1. Tap **Settings** in Top view.
2. Tap **My Car** → **Mirrors and Easy Entry**.
3. Under **Exterior Mirror Tilt at Reverse**, select **Off**, **Driver**, **Passenger** or **Both** to activate/deactivate and select which mirror to tilt.

### Folding mirrors\*

When parking in a limited space, the mirrors can be folded in:

1. Press the **L** and **R** buttons at the same time (the ignition must be in at least mode **I**).
2. Release the buttons after approx. 1 second. The mirrors will stop automatically when they are completely folded in.

Fold out the mirrors by pressing the **L** and **R** at the same time. The mirrors will stop automatically when they return to their original positions.

### Automatic folding when the vehicle is locked<sup>5</sup>

The mirrors can be folded in/out automatically when the vehicle is locked/unlocked.

This function can be activated/deactivated in the center display.

1. Tap **Settings** in Top view.
2. Tap **My Car → Mirrors and Easy Entry**.
3. Select **Fold Mirror When Locked** to activate/deactivate.

### Resetting the mirrors' position

A mirror that has been moved manually (e.g., bumped into in a parking lot, etc.) has to be returned to its normal position electrically before automatic folding will function correctly.

1. Fold in the mirrors with the **L** and **R** buttons.
2. Fold out the mirrors with the **L** and **R** buttons.

The mirrors have now been reset to their original positions.

### Auto-dim\*

Settings can be made for the auto-dim function in the rearview and door mirrors.

The auto-dim function is always active while the vehicle is being driven except when the reverse gear has been selected. The level of sensitivity for this function can be set to three levels, which affect the rearview mirror and door mirrors.

### NOTE

When the level of sensitivity is changed, this change will not be noticeable immediately but will take effect after a short period of time.

The level of sensitivity is set from the center display:

1. Tap **Settings** in Top view.
2. Tap **My Car → Mirrors and Easy Entry**.
3. Under **Rearview Mirror Auto Dimming**, select **Normal**, **Dark** or **Light**.

### Related information

- Using the power seat memory function\* (p. 165)
- Rearview mirror (p. 108)

### Laminated panoramic roof\*

The laminated panoramic roof is divided into two sections and only the front section can be opened; it can be slid horizontally to the open or closed positions or its rear edge can be raised and lowered to allow ventilation.

The laminated panoramic roof also has a sun shade made of perforated fabric that is located below the sections of glass. This shade can be opened or closed, for example when driving in bright sunlight.

The laminated panoramic roof also has a wind blocker that folds up when the roof is open.

### CAUTION

The optional panoramic roof should not be opened while load carriers are installed on the vehicle.





The laminated panoramic roof and the sun shade are operated using the controls in the ceiling console, near the rear-view mirror. The controls are activated when the vehicle's ignition is in mode **I** or **II**.

### CAUTION

- Remove ice and snow before opening the laminated panoramic roof.
- Do not operate the laminated panoramic roof if it is frozen closed.
- Never place heavy objects on the laminated panoramic roof.

### Wind blocker

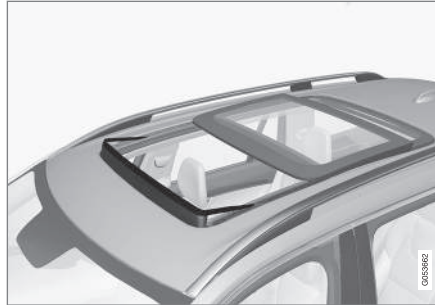

The laminated panoramic roof is equipped with a wind blocker that folds up when the roof is open.

### Related information

- Operating the laminated panoramic roof\* (p. 104)

### Operating the laminated panoramic roof\*

When opened automatically, the sun shade and roof open first to the "comfort" position that helps reduce wind noise and then open completely.

In the tilt (ventilation) position, the rear edge of the front section of the roof is raised.

### Operation

#### WARNING

- During manual closing, if the laminated panoramic roof is obstructed, immediately open it again.
- Never open or close the laminated panoramic roof if it is obstructed in any way.
- Never allow a child to operate the laminated panoramic roof.
- Never leave a child alone in a vehicle.
- When leaving the vehicle, ensure that the ignition is in mode **O**. Never leave a remote key in the vehicle.
- Never extend any object or body part through the open laminated panoramic roof, even if the vehicle's ignition is completely switched off.

**CAUTION**

The optional panoramic roof should not be opened while load carriers are installed on the vehicle.



- 1 Manual open (arrow points toward the rear of the vehicle)
- 2 Auto open
- 3 Manual close
- 4 Auto close

The laminated panoramic roof and sun shade can be operated when the ignition is in at least mode I.

**Manual operation**

- Opening the sun shade:** Pull the control back to the first stop (the manual open position) and hold it until the sun shade has opened to the position of your choice.
- Opening the laminated panoramic roof:** Pulling the control back to the first stop (the manual open position) and holding it a **second** time will open the laminated panoramic roof to the "comfort" position that helps reduce wind noise while driving. Pull the control a **third** time to open the roof completely.

Perform this procedure in reverse order to close the laminated panoramic roof and/or sun shade.

Movement of the laminated panoramic roof will stop if the control is released while it is in the manual open position.

**NOTE**

For manual opening, the sun shade must first be fully open before it will be possible to open the laminated panoramic roof. When closing, the laminated panoramic roof must be fully closed before the sun shade can be closed.

**Automatic operation**

- Opening the sun shade:** Pull the control as far back as possible (to the auto open position) and release it.

- Opening the laminated panoramic roof:** Pull the control as far back as possible a **second** time (to the auto open position) and release it to open the laminated panoramic roof to the "comfort" position that helps reduce wind noise while driving. Pull the control a **third** time (to the auto open position) and release it to open the roof completely.

Perform this procedure in reverse order to close the laminated panoramic roof/sun shade. The roof will not stop at the "comfort" position if it is closed from the fully open position.

The laminated panoramic roof will stop when it reaches the "comfort" position, the fully open position or the closed position. Movement will also stop if the control is moved in the opposite direction to the movement of the roof.

The roof will not stop at the "comfort" position if it is closed from the fully open position.

◀◀ **Quick open/close**

The laminated panoramic roof and the sun shade can be opened/closed at the same time:

- **Open:** pull the control back (to the auto open position) twice in quick succession and release it.
- **Close:** push the control forward (to the auto close position) twice in quick succession and release it.

The laminated panoramic roof will stop when it reaches the "comfort" position or the closed position. Movement will also stop if the control is moved in the opposite direction to the movement of the roof.

The roof will not stop at the "comfort" position if it is closed from the fully open position. The sun shade never stops when the roof reaches the "comfort" position.

**Tilt (ventilation) position**



Tilt position, raised at the rear edge

- ➔ **1** Open (raise the rear edge of the front glass section) by pressing the rear edge of the control upward.
- ➔ **2** Close by pulling the rear edge of the control downward/forward and holding it until the laminated panoramic roof has closed completely.

If the sun shade is completely closed, it will open approximately 2 inches (5 cm) when the laminated panoramic roof is opened to the tilt position.

**Automatically closing the sun shade<sup>6</sup>**

When the vehicle is parked in sunny/warm weather, the sun shade can be closed automatically 15 minutes after the vehicle has been

locked to help keep the temperature in the passenger compartment down and to protect the upholstery from the sun.

This function is deactivated by default and can be activated/deactivated:

1. Tap **Settings** in the center display's Top view.
2. Tap **My Car** → **Locking**.  
Select **Auto Close Sunroof Curtain** to activate/deactivate.

**Closing using an outside door handle<sup>7</sup>**

To close the panoramic roof when locking the vehicle, hold the pressure sensitive surface on the outside of a door handle until the panoramic roof has closed completely. The panoramic roof will stop if the button is released before it is fully closed. (This also applies to the windows).

**Pinch protection (auto-stop)**

The laminated panoramic roof has a pinch protection feature that is triggered if the glass section of the roof and/or the sun shade is blocked in any way when being closed. In this case, the laminated panoramic roof and/or sun shade will stop and reverse automatically approximately 2 in. (5 cm) from the point at which it was blocked (or will open fully to the tilt position).

<sup>6</sup> Not available in all markets

<sup>7</sup> Vehicles with the optional keyless Passive Entry system only.



The pinch protection feature also functions when the laminated panoramic roof and/or sun shade is being opened.

### WARNING

If the pinch protection (auto-stop) feature has been triggered, the laminated panoramic roof and/or sun shade can still be operated once more within 10 seconds **without pinch protection**. Pinch protection can be overridden if the closing procedure has been interrupted (e.g., due to ice around the laminated panoramic roof) by pressing and holding the control forward/downward until the laminated panoramic roof and/or sun shade is closed.

## Power windows

All power windows can be operated using the control panel in the driver's door. The control panels in the other doors only operate the window in the respective doors.

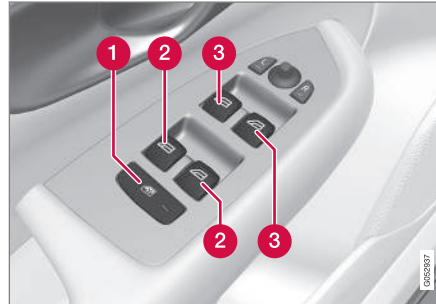

Driver's door control panel

- 1** Switch for power child safety locks\* and disengaging rear power window buttons
- 2** Rear window controls
- 3** Front window controls

### Related information

- Operating the power windows (p. 107)
- Child safety locks (p. 246)

## Operating the power windows

### WARNING

- Always put the ignition in mode **0** and remove the ignition key from the vehicle when the vehicle is unattended
- Never leave children unattended in the vehicle.
- Make sure that the windows are completely unobstructed before they are operated.

### Operating



Operating the power windows

- 1** Manual up/down
- 2** Auto up/down.

- ◀◀ For the power windows to function, the ignition must be in at least mode I. When the vehicle has been running, the power windows can be operated for several minutes after the ignition has been switched off, or until a door has been opened.

### **i** NOTE

- Movement of the windows will stop if they are obstructed in any way. If this happens twice in succession, the automatic function will not work for several minutes and the window can be closed by holding the button up.
- To reduce buffeting wind noise if the rear windows are opened, also open the front windows slightly.

### **Manual up/down**

- Move one of the controls up/down slightly.
  - > The power windows move up/down as long as the control is held in position.

### **Auto up/down**

- Move one of the controls up/down as far as possible and release it.
  - > The window will open or close completely.

### **Resetting**

If the battery has been disconnected, the auto open function must be reset so that it will work properly

1. Gently raise the front section of the button to close the window and hold it for one second.
2. Release the button briefly.
3. Raise the front section of the button again for one second.

### **Related information**

- Child safety locks (p. 246)

### **Rearview mirror**

The interior rearview mirror has an auto-dim function that helps reduce glare from following vehicle's headlights.

### **Auto-dim function**

The auto-dim function is controlled by two sensors: one pointing forward (located on the forward-facing side of the mirror, which monitors the amount of ambient light) and one pointing rearward (located on the side of the mirror facing the driver at the upper edge, which senses the strength of following vehicles' headlights), and work together to help eliminate glare.

### **i** NOTE

Obstructing the forward sensor with e.g., parking stickers, transponders, etc., or the rear sensor by loading the cargo area or the rear seat in such a way that light is prevented from reaching the sensor will reduce the auto-dim function in the interior rearview mirror and optional auto-dim function in the door mirrors.

The auto-dim function is always active while the vehicle is being driven except when the reverse gear has been selected. The level of sensitivity for this function can be set to three levels, which affect the rearview mirror and door mirrors.

**i NOTE**

When the level of sensitivity is changed, this change will not be noticeable immediately but will take effect after a short period of time.

The level of sensitivity is set from the center display:

1. Tap **Settings** in Top view.
2. Tap **My Car** → **Mirrors and Easy Entry**.
3. Under **Rearview Mirror Auto Dimming**, select **Normal**, **Dark** or **Light**.

**Related information**

- Adjusting the power door mirrors (p. 102)

**Using sun curtains\***

Both rear doors have integrated sun curtains.

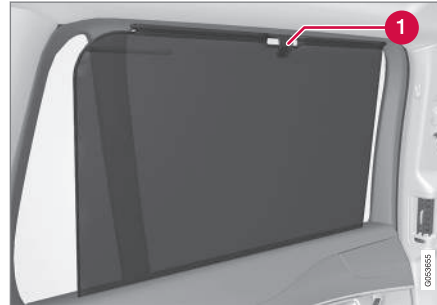
**Rear doors****1** Hook and locking mechanism

- Pull up the sun curtain and hook it to the upper section of the door frame.

The window can be opened/closed when the sun curtain is being used.

**Related information**

- Power windows (p. 107)
- Ignition modes (p. 380)

**Settings view**

The center display's Settings view is used to make many of the vehicle's function settings and to display vehicle-related information.

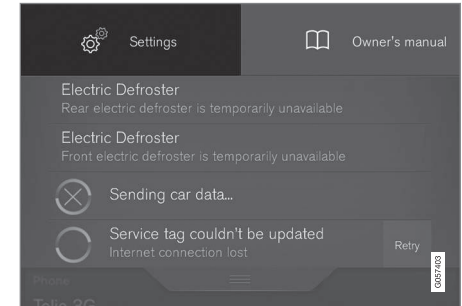
**Opening Settings view**

Top view with the **Settings** button

1. Pull down the tab on the upper edge of the center display to open Top view.
2. Tap **Settings**.
3. Tap one of the categories displayed and navigate to sub-categories and settings by tapping again.
4. Tap **Back** to go back in Settings view.  
Tap **Close** to close Settings view.



## ◀ Changing a setting

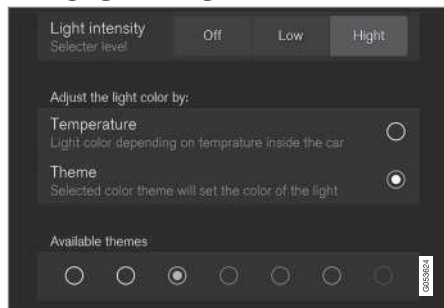

A sub-category in Settings view with various possible settings

1. Tap the category/sub-category to navigate to the desired setting.
2. Change the setting(s).
  - > The changes are saved immediately.

### Types of settings

Type of setting	Description
Trigger function	Starts an app or a separate view for more advanced settings. Tap the text to e.g., connect a Bluetooth device.
Radio button	Select one of the possible settings by tapping the desired radio button to e.g., change the system language.

Type of setting	Description
Multi-selection button	Select a level for a particular setting by pressing the desired part of the button e.g., to set the desired level for City Safety.
Check box	Tap to activate/deactivate a function e.g., to select automatic start for steering wheel heating.
Slider	Select a level for a function by pressing and dragging the slider control e.g., to set a volume level.
Information display	This is not an actual setting but displays information such as the vehicle's VIN number.

### Related information

- Center display overview (p. 28)
- Navigating in the center display's views (p. 38)
- Using the center display (p. 44)
- Changing system settings in Settings view (p. 112)
- Categories in Settings view (p. 110)

## Categories in Settings view

Settings view consists of a number of main categories and sub-categories that contain settings and information for many of the vehicle's features and functions.

The main categories in Settings view are: **My Car, Sound, Navigation, Media, Communication, Climate and System.**

Each main category, in turn, contains several sub-categories with possible settings. The table shows the first level of sub-categories. The possible settings for a function or area are described in greater detail in their respective articles in the owner's manual. For system settings not described in the respective articles, see "Changing system settings in Settings view."

### My Car

Sub-categories	Type of setting
Displays	Personal
IntelliSafe	Combination
Park Assist	Global
Drive Mode/Individual Drive Mode*	Combination
Lights and Lighting	Combination
Mirrors and Easy Entry	Personal
Locking	Combination

Sub-categories	Type of setting
Parking Brake and Suspension	Combination
Seats	Combination
Wipers	Combination
Suspension	Global

### Sound

Sub-categories	Type of setting
Sound Experience*	Personal
Tone	Personal
Balance	Personal
System Volumes	Combination

### Navigation

Sub-categories	Type of setting
Map	Personal
Route and Guidance	Personal
Traffic	Personal
Guidance	Personal
System	Personal

### Media

Sub-categories	Type of setting
AM/FM Radio <sup>A</sup>	Personal
SiriusXM	Personal
Gracenote <sup>®</sup>	Personal
Video	Personal

<sup>A</sup> AM radio is not available in hybrid models.

### Communication

Sub-categories	Type of setting
Phone	-
Text Messages	-
Bluetooth Devices	-
Wi-Fi	Global
Vehicle Wi-Fi Hotspot	Global
Vehicle Modem Internet	Global
Volvo On Call	-
Volvo Service Networks	Global

### Climate

The main category **Climate** has no sub-categories.

### System

Sub-categories	Type of setting
Driver Profile	Personal
Date and Time	-
System Language	Personal
Keyboard Layouts	Global
Voice Control	Personal
Units	Personal
Storage	-
Software Updates	-
Factory Reset	-
Services	-

### Related information

- Settings view (p. 109)
- Changing system settings in Settings view (p. 112)

## Changing system settings in Settings view

Settings view's main category **System** contains general settings and information, such as language, units of measure, etc.

The system settings under **Driver Profile, Date and Time, Keyboard Layouts, Voice Control, Software Updates, Factory reset** and **Services** are described in their respective articles in the owner's manual.

### Changing system languages

1. Pull down the center display's Top view and tap **Settings**.
2. Tap **System → System Language**.
3. Select a new system language. Languages that can be used for voice commands are indicated by a voice control symbol.
  - > This change affects the language used in the instrument panel, center display and the head-up display\*.

### Changing units of measure

#### Changing length and volume units

1. Pull down the center display's Top view and tap **Settings**.
2. Tap **System → Units → Units of Measurement**.

3. Select one of the following measurement standards:
  - **Metric:** kilometers, liters and degrees Celsius.
  - **Imperial:** miles, gallons and degrees Celsius.
  - **US:** miles, gallons and degrees Fahrenheit.
  - > This change affects the units of measure used in the instrument panel, center display and the head-up display\*

#### Changing tire inflation pressure units

1. Pull down the center display's Top view and tap **Settings**.
2. Tap **System → Units → Tire Pressure Units**.
3. Select a unit of measure for tire pressure.
  - > This changes the tire inflation pressure units used in the **Car status** app in the center display.

#### Viewing storage information

1. Pull down the center display's Top view and tap **Settings**.

2. Tap **System → Storage**.
  - > Storage information for the vehicle's hard drive will be displayed, including total capacity, available capacity and the amount of storage space used by the apps that have been installed.

#### Viewing the VIN (Vehicle Identification Number)

1. Pull down the center display's Top view and tap **Settings**.
2. Tap **System → Vehicle Identification Number**.
  - > The vehicle's VIN will be displayed.

## Changing settings in apps

App view, which is one of the center display's basic views, contains all of the apps installed in the vehicle. From Home view, navigate to App view by swiping the screen from right to left.

### Apps for integrated (basic) functions

Certain apps in your vehicle are factory-installed, such as **FM**, **USB** and **CD** and are part of Sensus. Settings in these apps can be changed in the center display's Top view.

### Changing settings for a basic app

1. Tap one of the basic apps, for example **FM radio**.
2. Pull down Top view.
3. Tap **FM Radio Settings**.
4. Change the desired settings and confirm.
5. Press the Home button below the center display or tap the screen outside of Top view or pull up Top view to return to your original view. See also the article "Categories in Settings view."

### Third party apps

Third party apps have to be downloaded e.g., **Volvo ID**. Settings for these apps are made in the apps themselves, not in Top view.

### Related information

- Settings view (p. 109)
- Navigating in the center display's views (p. 38)
- Categories in Settings view (p. 110)

## Resetting the settings view

All of the changes made under Settings view can be reset to their default values at the same time.

### Types of reset

There are three ways to reset the settings in Settings view under **Factory Reset**:

- **Factory Reset:** erases all data and media and resets to the settings used when the vehicle left the factory.
- **Reset Vehicle Settings:** resets all global settings to standard ones.
- **Reset Personal Settings:** erases all personal data and resets to standard settings.

### Resetting

#### **i** NOTE

**Factory Reset** is only possible when the vehicle is stationary.

1. Tap **Settings** in the center display's Top view.
2. Tap **System** → **Factory Reset**.  
> A pop-up menu will appear.



- 3. Tap **OK** to confirm your choice.

For **Reset Personal Settings**, tap **Reset for the active profile** or **Reset for all profiles** for confirmation.

> The selected settings will be reset.

### Related information

- Settings view (p. 109)
- Resetting user data when the vehicle changes owners (p. 114)
- Changing system settings in Settings view (p. 112)

### Resetting user data when the vehicle changes owners

When the vehicle changes owners, all user settings should be reset to the factory defaults.

When the vehicle changes owners, it is essential to reset all user data and system settings to their factory defaults, including Volvo On Call.

### Related information

- Resetting the settings view (p. 113)
- Volvo ID (p. 27)

### Ambient temperature sensor

The ambient temperature sensor displays the temperature outside the vehicle in the instrument panel.

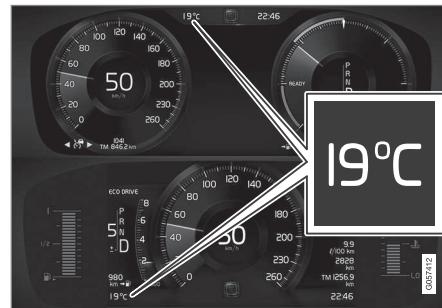

Location of the ambient temperature sensor in 12" (upper) and 8" (lower) instrument panels (temperature shown here in degrees Celsius)

### **i** NOTE

When the ambient temperature is between 23° and 36 °F (−5° and +2 °C), a snowflake symbol will be displayed next to the temperature. This symbol serves as a warning for possible slippery road surfaces. Please note that this symbol does **not** indicate a fault with your vehicle.

At low speeds or when the vehicle is not moving, the temperature readings may be slightly higher than the actual ambient temperature.



## Settings

Changing measurement standard in the center display:

1. Pull down the center display's Top view and tap **Settings**.
2. Tap **System** → **Units of Measurement**.
3. Select measurement standard, **Metric**, **Imperial** or **US**.

## Related information

- Instrument panel (p. 124)
- Climate system sensors (p. 183)

## Clock

The clock is displayed in the instrument panel and in the center display.



Location of the clock in the instrument panel in 12" (upper) and 8" (lower) instrument panels

Certain messages and other information in the instrument panel may temporarily obscure the clock.

In the center display, the clock is located at the upper right of the status bar.

## Settings for date and time

Select **Settings** → **System** → **Date and Time** in the center display's Top view to change the format for displaying date or time.

Set the date and time by tapping the up or down arrows on the center display.

## Automatic time

The function **Auto Time** is also available, which adjusts the time zone automatically, depending on the vehicle's location. If **Auto Time** has not been selected, set the date and time manually by tapping the up or down arrows on the center display.

## Daylight savings time

In certain countries, an automatic change to daylight savings time can be selected by activating **Auto**. If the automatic change is not available, change to daylight savings time by selecting **On** or **Off**.

## Related information

- Instrument panel (p. 124)
- Center display overview (p. 28)
- Using the center display (p. 44)

### Head-up display (HUD)\*

The head-up display provides information such as speed, cruise control functions, navigation, traffic sign information, incoming phone calls, etc. at the base of the windshield in the driver's field of vision.

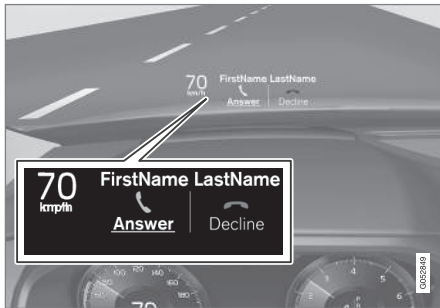

Incoming phone call

The HUD supplements the instrument panel and projects information on the lower section of the windshield. The projected information can only be seen from the driver's seat.

**CAUTION**

The HUD's projection unit is located in the dashboard. Avoid scratching or placing objects on the unit's glass surface.

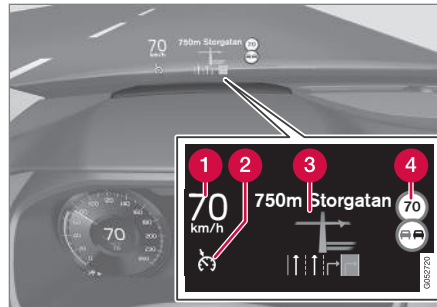

Example of information in the head-up display. The information shown is generic and may vary slightly from market to market or in terms of units of measure

- 1 Speed
- 2 Cruise control
- 3 Navigation
- 4 Road signs

Symbols such as the following ones may appear temporarily in the HUD.



If the warning symbol appears, read the warning text in the instrument panel.



If the information symbol appears, read the warning text in the instrument panel.

**NOTE**

If the City Safety is activated, the information in the HUD will be replaced by a City Safety-related graphic. This graphic will illuminate even if the HUD is turned off.

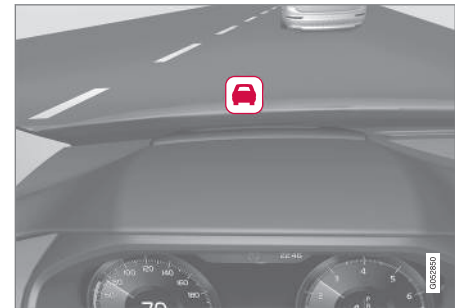

A graphic for the City Safety flashes to attract the driver's attention

**i NOTE**

The driver's ability to see information in the HUD may be impeded by:

- the use of polarizing sunglasses
- the use of an aftermarket or non-Volvo replacement windshield
- not sitting in the center of the driver's seat
- objects on the HUD projector glass on the dashboard
- certain ambient lighting conditions
- certain types of vision problems, which may also result in headaches or eye strain.
- Activating/deactivating and settings for HUD are only possible when an image is projected on the windshield. The engine must be running.

**Activating/deactivating HUD**

HUD can be activated in two ways in the center display:

**Via Function view**

Tap the **Head-up display** button.

**Via settings**

1. Tap **Settings** in Top view.
2. Tap **My Car** → **Displays**.
3. Select/deselect **Head-Up Display**.

This selection can be stored as a personal setting in a driver profile.

**Selecting display alternatives**

1. Tap **Settings** in Top view.
2. Tap **My Car** → **Displays** → **Head-Up Display Options**.

Tap Go to the center display's Settings view and select **Driver Display & Head-up Display**.

3. Select : **Show Navigation, Show Road Sign Information, Show Driver Support** or **Show Phone**.

This selection can be stored as a personal setting in a driver profile.

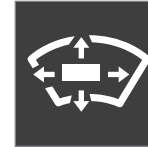
**Adjusting HUD brightness and height position**

1. Tap **Head-up display adjustments** in the center display's Function view.
2. Use the right-side steering wheel keypad to adjust the HUD's brightness and height position on the windshield in the driver's field of vision.

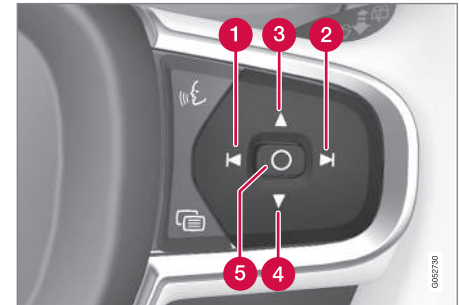

- 1 Reduce brightness
- 2 Increase brightness
- 3 Higher position
- 4 Lower position
- 5 Brightness and height position

- ◀◀ **4** Lower position
- 5** Confirm

### Adapting brightness

The brightness of the graphics displayed in the HUD are also automatically adjusted according to ambient lighting conditions. HUD brightness is also affected by adjustments to the brightness of the other displays in the vehicle.

### Power front seat\* memory function

The position of the HUD can be stored in the power seat's memory function.

### Replacing the windshield

Vehicles with a head-up display have a special type of windshield meeting the requirements for displaying projected information.

If the windshield has to be replaced, contact a trained and qualified Volvo service technician or authorized workshop. The correct type of replacement windshield must be used for a head-up display.

### Calibrating the horizontal position

If the windshield has been replaced, it may be necessary to calibrate the HUD's horizontal position. This means that the projected image will have to be rotated clockwise or counterclockwise. To do so:

1. Pull down the center display's Top view and tap **Settings**.

2. Select **My Car** → **Displays** → **Head-Up Display Calibration**.
3. Use the buttons on the right-side steering wheel keypad to calibrate the horizontal position.

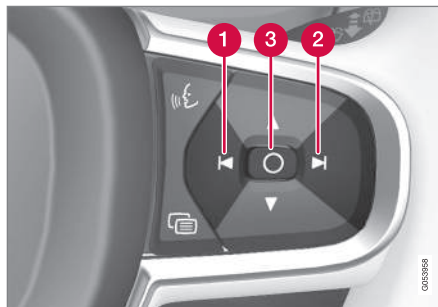

- 1** Rotate counterclockwise
- 2** Rotate clockwise
- 3** Confirm

### Cleaning

Wipe the glass covering the HUD projection unit carefully with a clean and dry (or very slightly damp if necessary) microfiber cloth.

Never use strong stain removers. For difficult cleaning conditions, a special cleaning agent can be purchased at a Volvo retailer.

### Related information

- Center display overview (p. 28)
- Navigating in the center display's views (p. 38)

## Voice control

Voice commands make it possible for the driver to voice-control certain functions in the media player, a Bluetooth-connected cell phone, climate system and the Volvo navigation system\*.

Voice control offers convenience and enables the driver to keep his/her hands on the steering wheel and concentrate on driving and the traffic situation around the vehicle.

### WARNING

As the driver, you have full responsibility for operating the vehicle safely and adhering to all applicable traffic regulations.

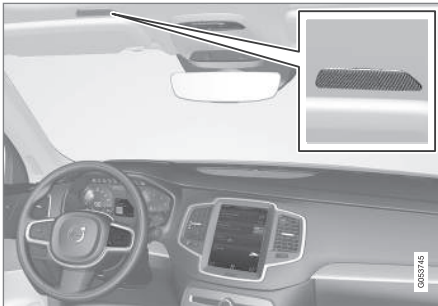

Input to the system is in dialog form and comprises commands from the driver and a verbal response from the system.

The voice control system uses the same microphone as the Bluetooth hands-free system and system responses come via the infotainment system's speakers.

In certain cases, text messages are also provided in the instrument panel.

The functions are controlled using the right-side steering wheel keypad and settings are made from the center console.

### System updates

The voice control system is being constantly improved and updates should be downloaded for optimal functionality. See the support site [support.volvocars.com](http://support.volvocars.com).

### Related information

- Using voice commands (p. 119)
- Voice control settings (p. 124)
- Voice control for radio and media (p. 121)
- Voice control for cell phones (p. 120)
- System updates (p. 482)
- Navigation system voice commands (p. 123)
- Climate system voice commands (p. 122)

## Using voice commands

The following is an introduction for using voice commands.





Press the button on the right-side steering wheel keypad to activate the system and initiate a voice command dialog.

Keep the following points in mind when using voice commands:

- When giving a command, speak at your usual speed and in a normal tone of voice **after the tone**.
- Avoid speaking while the system is responding. Commands cannot be processed during a response.
- Avoid background noises in the cabin when using the system by closing the vehicle's doors, windows and panoramic roof\* when giving voice commands.

Voice command dialogs can be cancelled by:

- Saying "**Cancel**".
- By pressing and holding the  button on the right-side steering wheel keypad.

To speed up a command dialog or to skip system responses, press the  button on the right-side steering wheel keypad when the system is responding and give your next command.



### ◀ Voice command examples

Press , say "**Call**"-"[First-name]"-"[Last-name]"-"[Number category]" to call a contact in your phonebook if the person has more than one phone number listed (i.e., home, mobile, work, etc.).

For example, press  and say "**Call**"-"Robin"-"Smith"-"mobile".

### Commands/phrases

The following commands can always be used:

- **Repeat:** the system will repeat the most recent voice instruction.
- **Cancel:** cancel the dialog.
- **Help:** Initiates a help dialog. The system will provide several alternative commands that can be used in a given situation.

The commands for specific situations are described in the respective articles such as "Cell phone commands", etc.

### Numbers

Numbers can be spoken in different ways depending on the context and function being used:

- **Phone numbers and zip codes** should be spoken individually, number by number, e.g., five five five one two three four (5551234).
- **Addresses (house numbers)** can be spoken individually or as a group, e.g., two two or twenty-two (22). It is also possible to say a

sequence of numbers, e.g., twenty-two twenty-two (22 22) and "double" or "triple" can also be used, e.g., double zero (00) or triple zero (000). Numbers in the range 0-2300 can be used.

- **Frequencies** can be spoken ninety-eight point eight (98.8), one hundred four point two (104.2) or hundred four point two (104.2).

### Related information

- Voice control (p. 119)

### Voice control for cell phones

Voice commands can be used to control many of the most common functions in a Bluetooth®-connected cell phone.

To specify a phone book contact, the voice command has to include the contact's information that is in the phone book. For example, if a contact such as **John Smith** has several phone numbers, a number category such as **home** or **mobile** can be specified. To call, say: "**Call John Smith mobile**".

To use the voice control system, press the  on the right-side steering wheel keypad and say one of the following commands after the tone:

- "**Call [contact]**": call a contact from your phone book.
- "**Call [phone number]**": call a phone number.
- "**Recent calls**": displays the list of recent calls.
- "**Read message**": reads a message aloud. If there are several messages, select the one to be read.
- "**Message to [contact]**": an empty message to the selected contact will open and is ready for dictation to begin.

### Related information

- Voice control (p. 119)
- Using voice commands (p. 119)
- Voice control settings (p. 124)

### Voice control for radio and media

The following voice commands can be used for the radio or an external media player.

To use the voice control system, press the  on the right-side steering wheel keypad and say one of the following commands after the tone:

- **"Media"**: initiates a dialog and displays possible commands.
- **"Play [artist]"**: plays music by the selected artist.
- **"Play [song title]"**: plays the selected song.
- **"Play [song title] from [album]"**: plays the selected song from the selected album.
- **"Play [radio station]"**: starts the selected radio station.
- **"Tune to [frequency]"**: tunes to the selected frequency on the current waveband. If no waveband has been selected, FM is the default.
- **"Tune to [frequency] [waveband]"**: tunes to the selected station on the selected waveband.
- **"Radio"**: starts FM radio.
- **"Radio FM"**: starts FM radio.
- **"Radio AM"**: starts AM radio.
- **"SiriusXM"**: starts SiriusXM radio\*
- **"CD"**: starts playback from a CD.

- **"USB"**: starts playback from a USB flash drive.
- **"iPod"**: starts playback from an iPod.
- **"Bluetooth"**: starts playback from a Bluetooth-connected device.
- **"Similar music"**: starts playback from a USB flash drive with music similar to the type currently playing.

### Related information

- Voice control (p. 119)
- Using voice commands (p. 119)
- Voice control settings (p. 124)

## Climate system voice commands

Voice commands can be used to control the climate system to e.g., change the temperature, activate seat heating\* or change blower (fan) speed.

To use the voice control system, press the  on the right-side steering wheel keypad and say one of the following commands after the tone:

- **"Climate"**: starts a command dialog and provides examples of commands that can be used.
- **"Set temperature to X degrees"**: sets the desired temperature.
- **"Raise temperature"/"Lower temperature"**: raises/lowers the temperature.
- **"Sync temperature"**: synchronizes the temperature in all of the vehicle's climate zones with the one set for the driver's side.
- **"Air on feet"/"Air on body"**: opens the desired air vent.
- **"Air on feet off"/"Air on body off"**: closes the desired air vent.
- **"Set fan to max"/"Turn off fan"**: changes the blower speed to **Max/Off**.
- **"Raise fan speed"/"Lower fan speed"**: raises/lowers the blower speed.
- **"Turn on auto"**: activates automatic climate control.
- **"Air condition on"/"Air condition off"**: activates/deactivates the air conditioning.
- **"Recirculation on"/"Recirculation off"**: activates/deactivates recirculation.
- **"Turn on defroster"/"Turn off defroster"**: activates/deactivates window and door mirror defrosting.
- **"Turn on max defroster"/"Turn off max defroster"**: activates/deactivates max defroster.
- **"Turn on electric defroster"/"Turn off electric defroster"**: activates/deactivates the electrically heated windshield\*.
- **"Turn on rear defroster"/"Turn off rear defroster"**: activates/deactivates the electrically heated rear window and door mirrors.
- **"Turn steering wheel heat on"/"Turn steering wheel heat off"**: activates/deactivates the electrically heated steering wheel\*.
- **"Raise steering wheel heat"/"Lower steering wheel heat"**: raises/lowers the heating level for the electrically heated steering wheel\*.
- **"Turn on seat heat"/"Turn off seat heat"**: activates/deactivates the electrically heated seats\*.
- **"Raise seat heat"/"Lower seat heat"**: raises/lowers the heating level for the electrically heated seats\*.
- **"Turn on seat ventilation"/"Turn off seat ventilation"**: activates/deactivates seat ventilation\*.
- **"Raise seat ventilation"/"Lower seat ventilation"**: raises/lowers the level for seat ventilation\*.

## Related information

- Climate system controls (p. 186)
- Voice control (p. 119)
- Using voice commands (p. 119)



## Navigation system voice commands

Many of the navigation system's functions can be activated using voice commands.

The procedure for using voice control is described in greater detail in the articles "Voice control," "Using voice control" and "Voice control settings."

### Voice commands

The following list contains examples of commands that are unique to navigation system.

To use the voice control system, press the  on the right-side steering wheel keypad and say one of the following commands after the tone:

- **"Navigation"**: Starts a navigation voice command dialog and displays available commands.
- **"Take me home"**: Guidance will be given to the location set as **Home**.
- **"Go to [City]"**: Enter a city as a destination, e.g., "Go to New York."
- **"Go to [Address]"**: Enter an address as a destination, e.g., "Go to 125 43 St., New York."
- **"Go to Intersection"**: Starts a dialog where two street names are entered. The destination will then be the intersection of the two streets.
- **"Go to [Zip code]"**: Enter a zip code as a destination, e.g., "Go to 07405."
- **"Go to [Name]"**: Enter a name from a list of contacts e.g., "Go to John Smith."
- **"Search [POI category] in [City]"**: The list of results will be sorted around the center of the selected city/town, e.g., Search restaurants in Butler.
- **Search [POI category]"**: For example, Search Yankee Stadium.
- **"Change country/Change state"**: Changes the country/state in which a search is conducted.
- **"Show favorites"**: Shows a list of **Favorites** in the center display's Top view.
- **"Clear itinerary"**: Deletes all intermediate destinations in an itinerary.
- **"Repeat voice guidance"**: Repeats the most recent guidance instruction.
- **"Pause guidance"**: Pauses guidance on the map.
- **"Resume guidance"**: Resumes guidance on the map.
- **"Turn off voice guidance"**: Turns voice navigation guidance off.
- **"Turn on voice guidance"**: Turns voice navigation guidance on.

### Related information

- Voice control (p. 119)
- Using voice commands (p. 119)
- Voice control settings (p. 124)

## Voice control settings

There are a number of settings that can be made for the voice control system.

Open the center display's Top view and tap **Settings → System → Voice Control** and select settings.

- Repeat Voice Command
- Gender
- Speech Rate

## Sound settings

Open Top view and tap **Settings → Sound → System Volumes → Voice Control**.

## Changing languages

The voice control system only understands the languages marked by the  symbol in the list of possible system languages.

Changing the language for this system also affects menus, messages and help texts.

Open Top view and tap **Settings → System → System Language**.

## Related information

- Voice control (p. 119)
- Using voice commands (p. 119)
- Navigation system voice commands (p. 123)

## Instrument panel

The instrument panel displays vehicle- and driving-related information.

The gauges, indicators, symbols and functions displayed in the instrument panel depend on the equipment/systems installed in the vehicle and which functions are currently activated.

The instrument panel is available in two versions: 12" and 8".

Some of the functions listed below are optional.

### WARNING

- If the instrument panel is not functioning properly, information about e.g., brakes, airbags or other safety-related messages cannot be displayed and the driver cannot be alerted to possible problems.
- If the instrument panel turns off, does not activate when the ignition is switched on or is completely/partially not possible to read, do not drive the vehicle. Contact a trained and qualified Volvo service technician.

## 12" Instrument panel



### Left side

- Speedometer
- Trip odometer
- Odometer
- Cruise control/speed limiter information
- Road sign information\*

**Center**

- Indicator and warning symbols
- Ambient temperature sensor
- Clock
- Messages (and in certain cases also graphics)
- Door and seat belt status
- Media player
- Navigation system map
- Cell phone
- Voice control
- Compass

**Right side**

- Tachometer (depending on current driving mode)
- ECO gauge (depending on current driving mode)
- Gear indicator
- Current driving mode (Comfort, Off Road, Eco, Dynamic and Individual)
- Fuel gauge
- Start/Stop function's status
- Driving distance to empty tank
- Current fuel consumption
- App menu (activated using the right-side steering wheel keypad)

**8" instrument panel****Left side**

- Fuel gauge
- Current driving mode (Comfort, Off Road, Eco, Dynamic and Individual)
- Gear indicator
- Tachometer (depending on current driving mode)
- ECO gauge (depending on current driving mode)
- Distance to empty tank
- Ambient temperature sensor
- Indicator and warning symbols

**Center**

- Speedometer
- Road sign information\*
- Cruise control/speed limiter information

- Door and seat belt status
- Start/Stop function's status

**Right side**

- Media player
- Cell phone
- Navigation system map
- Clock
- App menu (activated using the right-side steering wheel keypad)
- Current fuel consumption
- Odometer
- Trip odometer
- Indicator and warning symbols
- Voice control
- Coolant temperature gauge
- Compass



## ◀ Position for variable symbols



Sample indicator symbol in the 12" instrument panel

Different symbols for various types of messages will be displayed in the center of the instrument panel. This may consist of an indicator or warning symbol or may be a series of graphics in this position which then convert to a larger graphic.

### Activating the instrument panel

The instrument panel is activated as soon as a door is opened (i.e., ignition mode **O**). After a short period, the panel will go out if it is not used.

To reactivate it, do **one** of the following:

- Press the brake pedal
- Turn the start knob to **START** and release it (without pressing the brake pedal). This activates ignition mode **I**
- Open one of the doors

### Related information

- Instrument panel App menu (p. 155)
- Warning symbols in the instrument panel (p. 135)
- Indicator symbols in the instrument panel (p. 127)
- Instrument panel licenses (p. 130)

### Instrument panel settings

Instrument panel settings can be made from its **app menu** and under **Settings** in the center display.

#### App menu settings

Settings can be made in the instrument panel's app menu to determine the information to be displayed from:

- the trip computer
- the media player
- a cell phone
- the navigation system.

The instrument panel's app menu is opened and settings are made using the right-side keypad on the steering wheel.

## Making settings from the center display

### Selecting types of information

1. Tap **Settings** in the center display's Top view.
2. Tap **My Car** → **Displays** → **Driver Display Information**.
3. Select the information to be displayed in the background:
  - **Show no information in the background**
  - **Show information for current playing media**
  - **Show navigation even if no route is set**<sup>8</sup>.

Information is displayed at the center of the 12" instrument panel and in a field at the upper right of the 8" version.

### Selecting themes

1. Tap **Settings** in the center display's Top view.
2. Tap **My Car** → **Displays** → **Display Themes**

3. Select a theme (appearance) for the instrument panel:
  - **Glass**
  - **Minimalistic**
  - **Performance**
  - **Chrome Rings**.

### Selecting a language



1. Tap **Settings** in the center display's Top view.
2. To select a language, tap **System** → **Choose system language**.
  - > Changing languages affects all of the vehicle's displays. Changing to a language that you do not understand may make it difficult to change back to the original language.

### Related information

- Instrument panel App menu (p. 155)
- Instrument panel (p. 124)
- Settings view (p. 109)







## Indicator symbols in the instrument panel







The indicator symbols alert the driver when certain functions are activated, that a system is actively working or that a fault may have occurred in a system or function.

Symbol	Explanation
	<p><b>Information, see the text message in the instrument panel</b></p> <p>The information symbol illuminates in combination with a text message if one of the vehicle's systems requires the driver's attention. The information symbol can also illuminate in combination with other symbols.</p>
	<p><b>Brake system</b></p>



<sup>8</sup> The 8" instrument panel only shows guidance instructions. The map is only shown on the 12" instrument panel. See the navigation manual for additional information.





Symbol	Explanation
	<b>ABS brake system</b> This symbol indicates a possible fault in the ABS braking function. The vehicle's normal brakes will still function but without ABS brake modulation.
	
	<b>Parking brake/Auto-brake</b> This function keeps the vehicle at a standstill after it has stopped. The symbol is on when the function is activated and the brakes or parking brake are being used.
	
	<b>Tire pressure system</b> The symbol illuminates to indicate low tire pressure or a fault in the tire pressure system.
	<b>Malfunction indicator light (check engine light)</b> This symbol will illuminate if there is a fault in the emissions control system. If this happens, please have your vehicle checked by a trained and qualified Volvo service technician as soon as possible.

Symbol	Explanation
	<b>Left/right turn signals</b> Both turn signal indicators will flash when the hazard warning flashers are being used.
	
	<b>Forward lights</b>
	<b>Active Bending Lights (ABL)</b> This symbol will illuminate if there is a fault in the ABL system or if any other fault is detected in the headlight system.
	<b>Automatic/active high beams on</b> The symbol will be blue when the automatic high beams are on.
	<b>Automatic/active high beams off</b> The symbol will be white when the automatic high beams are off.
	<b>High beam indicator</b> The symbol will illuminate when the high beams are on or when high beam flash is being used.

Symbol	Explanation
	<b>Automatic/active high beams on</b> The symbol will be blue when the automatic high beams are on. The parking lights will also be on.
	<b>Automatic/active high beams off</b> The symbol will be white when the automatic high beams are off. The parking lights will be on.
	<b>High beams on</b> The high beams and parking lights will be on.
	<b>Front fog lights</b> The symbol illuminates when the front fog lights are on.
	<b>Rear fog lights</b> The symbol illuminates when the rear fog lights are on.
	<b>Rain sensor</b> The symbol illuminates when the rain sensor is on.

Symbol	Explanation
	Not in use
	<b>Stability system</b> This symbol flashes when the stability system is actively working to stabilize the vehicle. If the symbol glows steadily, there is a fault in the system.
	<b>Stability system, sport mode</b> This symbol illuminates when Sport mode is activated. Sport mode offers more active driving characteristics by monitoring movement of the accelerator pedal, steering wheel and cornering by allowing more lateral movement of the rear wheels before the stability system is activated.

Symbol	Explanation
	<b>Lane keeping aid</b> White symbol: lane keeping aid on and marker lines detected. Gray symbol: lane keeping aid on and no marker lines detected. Yellow symbol: lane keeping aid active
	<b>Lane keeping aid and rain sensor</b> White symbol: lane keeping aid on and marker lines detected. Rain sensor on. Gray symbol: lane keeping aid on and no marker lines detected. Rain sensor on.

<sup>A</sup> US models

<sup>B</sup> Canadian models

### Door/hood/tailgate/fuel filler door reminder

If a door or the hood/tailgate/fuel filler door are not closed properly, the information or warning symbol will illuminate and a graphic will be displayed in instrument panel. Stop the vehicle in a safe place as soon as possible and close the door, etc.

### Related information

- Instrument panel (p. 124)
- Warning symbols in the instrument panel (p. 135)
- Door and seat belt reminders (p. 64)

## Instrument panel licenses

### BSD 4-clause "Original" or "Old" License

Copyright ©) 1982, 1986, 1990, 1991, 1993  
The Regents of the University of California. All rights reserved.

Redistribution and use in source and binary forms, with or without modification, are permitted provided that the following conditions are met:

1. Redistributions of source code must retain the above copyright notice, this list of conditions and the following disclaimer.
2. Redistributions in binary form must reproduce the above copyright notice, this list of conditions and the following disclaimer in the documentation and/or other materials provided with the distribution.
3. All advertising materials mentioning features or use of this software must display the following acknowledgment: This product includes software developed by the University of California, Berkeley and its contributors.
4. Neither the name of the University nor the names of its contributors may be used to endorse or promote products derived from this software without specific prior written permission.

THIS SOFTWARE IS PROVIDED BY THE REGENTS AND CONTRIBUTORS "AS IS" AND

ANY EXPRESS OR IMPLIED WARRANTIES, INCLUDING, BUT NOT LIMITED TO, THE IMPLIED WARRANTIES OF MERCHANTABILITY AND FITNESS FOR A PARTICULAR PURPOSE ARE DISCLAIMED. IN NO EVENT SHALL THE REGENTS OR CONTRIBUTORS BE LIABLE FOR ANY DIRECT, INDIRECT, INCIDENTAL, SPECIAL, EXEMPLARY, OR CONSEQUENTIAL DAMAGES (INCLUDING, BUT NOT LIMITED TO, PROCUREMENT OF SUBSTITUTE GOODS OR SERVICES; LOSS OF USE, DATA, OR PROFITS; OR BUSINESS INTERRUPTION) HOWEVER CAUSED AND ON ANY THEORY OF LIABILITY, WHETHER IN CONTRACT, STRICT LIABILITY, OR TORT (INCLUDING NEGLIGENCE OR OTHERWISE) ARISING IN ANY WAY OUT OF THE USE OF THIS SOFTWARE, EVEN IF ADVISED OF THE POSSIBILITY OF SUCH DAMAGE.

### BSD 3-clause "New" or "Revised" License

Copyright (c) 2011-2014, Yann Collet.

Redistribution and use in source and binary forms, with or without modification, are permitted provided that the following conditions are met:

1. Redistributions of source code must retain the above copyright notice, this list of conditions and the following disclaimer.
2. Redistributions in binary form must reproduce the above copyright notice, this list of conditions and the following disclaimer in

the documentation and/or other materials provided with the distribution.

3. Neither the name of the organisation nor the names of its contributors may be used to endorse or promote products derived from this software without specific prior written permission.

THIS SOFTWARE IS PROVIDED BY THE COPYRIGHT HOLDERS AND CONTRIBUTORS "AS IS" AND ANY EXPRESS OR IMPLIED WARRANTIES, INCLUDING, BUT NOT LIMITED TO, THE IMPLIED WARRANTIES OF MERCHANTABILITY AND FITNESS FOR A PARTICULAR PURPOSE ARE DISCLAIMED. IN NO EVENT SHALL THE COPYRIGHT HOLDER OR CONTRIBUTORS BE LIABLE FOR ANY DIRECT, INDIRECT, INCIDENTAL, SPECIAL, EXEMPLARY, OR CONSEQUENTIAL DAMAGES (INCLUDING, BUT NOT LIMITED TO, PROCUREMENT OF SUBSTITUTE GOODS OR SERVICES; LOSS OF USE, DATA, OR PROFITS; OR BUSINESS INTERRUPTION) HOWEVER CAUSED AND ON ANY THEORY OF LIABILITY, WHETHER IN CONTRACT, STRICT LIABILITY, OR TORT (INCLUDING NEGLIGENCE OR OTHERWISE) ARISING IN ANY WAY OUT OF THE USE OF THIS SOFTWARE, EVEN IF ADVISED OF THE POSSIBILITY OF SUCH DAMAGE.



**BSD 2-clause "Simplified" license**

Copyright ©) <YEAR>, <OWNER> All rights reserved.

Redistribution and use in source and binary forms, with or without modification, are permitted provided that the following conditions are met:

1. Redistributions of source code must retain the above copyright notice, this list of conditions and the following disclaimer.
2. Redistributions in binary form must reproduce the above copyright notice, this list of conditions and the following disclaimer in the documentation and/or other materials provided with the distribution.

THIS SOFTWARE IS PROVIDED BY THE COPYRIGHT HOLDERS AND CONTRIBUTORS "AS IS" AND ANY EXPRESS OR IMPLIED WARRANTIES, INCLUDING, BUT NOT LIMITED TO, THE IMPLIED WARRANTIES OF MERCHANTABILITY AND FITNESS FOR A PARTICULAR PURPOSE ARE DISCLAIMED. IN NO EVENT SHALL THE COPYRIGHT OWNER OR CONTRIBUTORS BE LIABLE FOR ANY DIRECT, INDIRECT, INCIDENTAL, SPECIAL, EXEMPLARY, OR CONSEQUENTIAL DAMAGES (INCLUDING, BUT NOT LIMITED TO, PROCUREMENT OF SUBSTITUTE GOODS OR SERVICES; LOSS OF USE, DATA, OR PROFITS; OR BUSINESS INTERRUPTION) HOWEVER CAUSED AND ON ANY THEORY OF LIABILITY, WHETHER IN CONTRACT, STRICT LIABILITY,

OR TORT (INCLUDING NEGLIGENCE OR OTHERWISE) ARISING IN ANY WAY OUT OF THE USE OF THIS SOFTWARE, EVEN IF ADVISED OF THE POSSIBILITY OF SUCH DAMAGE.

The views and conclusions contained in the software and documentation are those of the authors and should not be interpreted as representing official policies, either expressed or implied, of the FreeBSD Project.

**FreeType Project License**

1. 1 Copyright 1996-1999 by David Turner, Robert Wilhelm, and Werner Lemberg  
Introduction The FreeType Project is distributed in several archive packages; some of them may contain, in addition to the FreeType font engine, various tools and contributions which rely on, or relate to, the FreeType Project. This license applies to all files found in such packages, and which do not fall under their own explicit license. The license affects thus the FreeType font engine, the test programs, documentation and makefiles, at the very least. This license was inspired by the BSD, Artistic, and IJG (Independent JPEG Group) licenses, which all encourage inclusion and use of free software in commercial and freeware products alike. As a consequence, its main points are that:
  - o We don't promise that this software works. However, we are interested in any kind of bug reports. ('as is'

distribution) o You can use this software for whatever you want, in parts or full form, without having to pay us. ('royalty-free' usage) o You may not pretend that you wrote this software. If you use it, or only parts of it, in a program, you must acknowledge somewhere in your documentation that you've used the FreeType code. ('credits') We specifically permit and encourage the inclusion of this software, with or without modifications, in commercial products, provided that all warranty or liability claims are assumed by the product vendor. Legal Terms 0. Definitions Throughout this license, the terms 'package', 'FreeType Project', and 'FreeType archive' refer to the set of files originally distributed by the authors (David Turner, Robert Wilhelm, and Werner Lemberg) as the 'FreeType project', be they named as alpha, beta or final release. 'You' refers to the licensee, or person using the project, where 'using' is a generic term including compiling the project's source code as well as linking it to form a 'program' or 'executable'. This program is referred to as 'a program using the FreeType engine'. This license applies to all files distributed in the original FreeType archive, including all source code, binaries and documentation, unless otherwise stated in the file in its original, unmodified form as distributed in the original archive. If you are unsure whether or not a particular file is covered by this license, you





must contact us to verify this. The FreeType project is copyright (C) 1996-1999 by David Turner, Robert Wilhelm, and Werner Lemberg. All rights reserved except as specified below.

1. No Warranty THE FREETYPE ARCHIVE IS PROVIDED 'AS IS' WITHOUT WARRANTY OF ANY KIND, EITHER EXPRESSED OR IMPLIED, INCLUDING, BUT NOT LIMITED TO, WARRANTIES OF MERCHANTABILITY AND FITNESS FOR A PARTICULAR PURPOSE. IN NO EVENT WILL ANY OF THE AUTHORS OR COPYRIGHT HOLDERS BE LIABLE FOR ANY DAMAGES CAUSED BY THE USE OR THE INABILITY TO USE, OF THE FREETYPE PROJECT. As you have not signed this license, you are not required to accept it. However, as the FreeType project is copyrighted material, only this license, or another one contracted with the authors, grants you the right to use, distribute, and modify it. Therefore, by using, distributing, or modifying the FreeType project, you indicate that you understand and accept all the terms of this license.

2. Redistribution Redistribution and use in source and binary forms, with or without modification, are permitted provided that the following conditions are met:
  - o Redistribution of source code must retain this license file ('licence.txt') unaltered; any additions, deletions or changes to the original files must be clearly indicated in accompanying

documentation. The copyright notices of the unaltered, original files must be preserved in all copies of source files.

- o Redistribution in binary form must provide a disclaimer that states that the software is based in part of the work of the FreeType Team, in the distribution documentation. We also encourage you to put an URL to the FreeType web page in your documentation, though this isn't mandatory. These conditions apply to any software derived from or based on the FreeType code, not just the unmodified files. If you use our work, you must acknowledge us. However, no fee need be paid to us.

3. Advertising The names of FreeType's authors and contributors may not be used to endorse or promote products derived from this software without specific prior written permission. We suggest, but do not require, that you use one or more of the following phrases to refer to this software in your documentation or advertising materials:
  - 'FreeType Project', 'FreeType Engine', 'FreeType library', or 'FreeType Distribution'.
4. Contacts There are two mailing lists related to FreeType:
  - o [freetype@freetype.org](mailto:freetype@freetype.org) Discusses general use and applications of FreeType, as well as future and wanted additions to the library and distribution. If you are looking for support, start in this list if you haven't found anything to help you in the documentation.
  - o [devel@freetype.org](mailto:devel@freetype.org)

Discusses bugs, as well as engine internals, design issues, specific licenses, porting, etc.

- o <http://www.freetype.org> Holds the current FreeType web page, which will allow you to download our latest development version and read online documentation. You can also contact us individually at: David Turner <[david.turner@freetype.org](mailto:david.turner@freetype.org)> Robert Wilhelm <[robert.wilhelm@freetype.org](mailto:robert.wilhelm@freetype.org)> Werner Lemberg <[werner.lemberg@freetype.org](mailto:werner.lemberg@freetype.org)>

### Libpng License

This copy of the libpng notices is provided for your convenience. In case of any discrepancy between this copy and the notices in the file png.h that is included in the libpng distribution, the latter shall prevail.

**COPYRIGHT NOTICE, DISCLAIMER, and LICENSE:**

If you modify libpng you may insert additional notices immediately following this sentence.

libpng versions 1.0.7, July 1, 2000, through 1.0.13, April 15, 2002, are Copyright (c) 2000-2002 Glenn Randers-Pehrson and are distributed according to the same disclaimer and license as libpng-1.0.6 with the following individuals added to the list of Contributing Authors

Simon-Pierre Cadieux

Eric S. Raymond

Gilles Vollant

and with the following additions to the disclaimer:

There is no warranty against interference with your enjoyment of the library or against infringement. There is no warranty that our efforts or the library will fulfill any of your particular purposes or needs. This library is provided with all faults, and the entire risk of satisfactory quality, performance, accuracy, and effort is with the user.

libpng versions 0.97, January 1998, through 1.0.6, March 20, 2000, are Copyright (c) 1998, 1999 Glenn Randers-Pehrson, and are distributed according to the same disclaimer and license as libpng-0.96, with the following individuals added to the list of Contributing Authors:

Tom Lane

Glenn Randers-Pehrson

Willem van Schaik

libpng versions 0.89, June 1996, through 0.96, May 1997, are Copyright (c) 1996, 1997 Andreas Dilger Distributed according to the same disclaimer and license as libpng-0.88, with the following individuals added to the list of Contributing Authors:

John Bowler

Kevin Bracey

Sam Bushell

Magnus Holmgren

Greg Roelofs

Tom Tanner

libpng versions 0.5, May 1995, through 0.88, January 1996, are Copyright (c) 1995, 1996 Guy Eric Schalnat, Group 42, Inc.

For the purposes of this copyright and license, "Contributing Authors" is defined as the following set of individuals:

Andreas Dilger

Dave Martindale

Guy Eric Schalnat

Paul Schmidt

Tim Wegner

The PNG Reference Library is supplied "AS IS". The Contributing Authors and Group 42, Inc. disclaim all warranties, expressed or implied, including, without limitation, the warranties of merchantability and of fitness for any purpose. The Contributing Authors and Group 42, Inc. assume no liability for direct, indirect, incidental, special, exemplary, or consequential damages, which may result from the use of the PNG Reference Library, even if advised of the possibility of such damage.

Permission is hereby granted to use, copy, modify, and distribute this source code, or portions hereof, for any purpose, without fee, subject to the following restrictions:

1. The origin of this source code must not be misrepresented.
2. Altered versions must be plainly marked as such and must not be misrepresented as being the original source.
3. This Copyright notice may not be removed or altered from any source or altered source distribution.

The Contributing Authors and Group 42, Inc. specifically permit, without fee, and encourage the use of this source code as a component to supporting the PNG file format in commercial products. If you use this source code in a product, acknowledgment is not required but would be appreciated.

- ◄◄ A "png\_get\_copyright" function is available, for convenient use in "about" boxes and the like:

```
printf("%s",png_get_copyright(NULL));
```

Also, the PNG logo (in PNG format, of course) is supplied in the files "pngbar.png" and "pngbar.jpg (88x31) and "pngnow.png" (98x31).

Libpng is OSI Certified Open Source Software. OSI Certified Open Source is a certification mark of the Open Source Initiative.

Glenn Randers-Pehrson randeg@alum.rpi.edu  
April 15, 2002

### MIT License

Copyright (c) <year> <copyright holders>

Permission is hereby granted, free of charge, to any person obtaining a copy of this software and associated documentation files (the "Software"), to deal in the Software without restriction, including without limitation the rights to use, copy, modify, merge, publish, distribute, sublicense, and/or sell copies of the Software, and to permit persons to whom the Software is furnished to do so, subject to the following conditions:

The above copyright notice and this permission notice shall be included in all copies or substantial portions of the Software.

THE SOFTWARE IS PROVIDED "AS IS", WITHOUT WARRANTY OF ANY KIND, EXPRESS OR IMPLIED, INCLUDING BUT NOT

LIMITED TO THE WARRANTIES OF MERCHANTABILITY, FITNESS FOR A PARTICULAR PURPOSE AND NONINFRINGEMENT. IN NO EVENT SHALL THE AUTHORS OR COPYRIGHT HOLDERS BE LIABLE FOR ANY CLAIM, DAMAGES OR OTHER LIABILITY, WHETHER IN AN ACTION OF CONTRACT, TORT OR OTHERWISE, ARISING FROM, OUT OF OR IN CONNECTION WITH THE SOFTWARE OR THE USE OR OTHER DEALINGS IN THE SOFTWARE.

### zlib License

The zlib/libpng License Copyright (c) <year>  
<copyright holders>

This software is provided 'as-is', without any express or implied warranty. In no event will the authors be held liable for any damages arising from the use of this software.

Permission is granted to anyone to use this software for any purpose, including commercial applications, and to alter it and redistribute it freely, subject to the following restrictions:

1. The origin of this software must not be misrepresented; you must not claim that you wrote the original software. If you use this software in a product, an acknowledgment in the product documentation would be appreciated but is not required.
2. Altered source versions must be plainly marked as such, and must not be

misrepresented as being the original software.

3. This notice may not be removed or altered from any source distribution.

### SGI Free Software B License Version 2.0.

SGI FREE SOFTWARE LICENSE B (Version 2.0, Sept. 18, 2008)

Copyright (C) [dates of first publication] Silicon Graphics, Inc. All Rights Reserved. Permission is hereby granted, free of charge, to any person obtaining a copy of this software and associated documentation files (the "Software"), to deal in the Software without restriction, including without limitation the rights to use, copy, modify, merge, publish, distribute, sublicense, and/or sell copies of the Software, and to permit persons to whom the Software is furnished to do so, subject to the following conditions: The above copyright notice including the dates of first publication and either this permission notice or a reference to <http://oss.sgi.com/projects/FreeB/> shall be included in all copies or substantial portions of the Software.

THE SOFTWARE IS PROVIDED "AS IS", WITHOUT WARRANTY OF ANY KIND, EXPRESS OR IMPLIED, INCLUDING BUT NOT LIMITED TO THE WARRANTIES OF MERCHANTABILITY, FITNESS FOR A PARTICULAR PURPOSE AND NONINFRINGEMENT. IN NO EVENT SHALL SILICON GRAPHICS, INC. BE LIABLE FOR ANY

CLAIM, DAMAGES OR OTHER LIABILITY, WHETHER IN AN ACTION OF CONTRACT, TORT OR OTHERWISE, ARISING FROM, OUT OF OR IN CONNECTION WITH THE SOFTWARE OR THE USE OR OTHER DEALINGS IN THE SOFTWARE.



Except as contained in this notice, the name of Silicon Graphics, Inc. shall not be used in advertising or otherwise to promote the sale, use or other dealings in this Software without prior written authorization from Silicon Graphics, Inc.





### Related information

- Instrument panel (p. 124)



## Warning symbols in the instrument panel

The warning symbols alert the driver that an important function is activated or that a serious fault has occurred.

Symbol	Meaning
	<p><b>Warning</b></p> <p>The red warning symbol alerts the driver that an important function is activated or that a serious fault has occurred that may affect the vehicle's drivability. The warning symbol can also illuminate in combination with other symbols.</p>
	<p><b>Seat belt reminder</b></p> <p>This symbol will flash for approximately 6 seconds if the driver or front seat passenger has not fastened his or her seat belt or if anyone in the rear seat has unbuckled a seat belt.</p>

Symbol	Meaning
	<p><b>Airbags</b></p> <p>If this light remains on after the vehicle has been started or comes on while the vehicle is being driven, a fault has been detected in one of the vehicle's safety systems. See the message in the instrument panel. Have the system(s) inspected by a trained and qualified Volvo service technician as soon as possible.</p>
 A	<p><b>Brake system</b></p> <p>If this symbol illuminates, the brake fluid level may be too low. Stop the vehicle in a safe place and check the level in the brake fluid reservoir. See also the warning following this table.</p>
 B	
 A	<p><b>Parking brake</b></p> <p>This symbol flashes while the parking brake is being applied and then glows steadily when the parking brake has been set.</p> <p>If the symbol flashes in any other situation, this indicates a fault. See the text message in the instrument panel.</p>
 B	



Symbol	Meaning
	<p><b>Oil pressure</b></p> <p>If the symbol illuminates during driving, stop the vehicle, the engine oil level is too low. Stop the engine immediately and check the engine oil level. Add oil if necessary. If the oil level is normal and the symbol remains illuminated, have the vehicle towed to the nearest authorized Volvo workshop or trained and qualified Volvo service technician.</p>
	<p><b>Generator not charging</b></p> <p>This symbol illuminates during driving if a fault has occurred in the electrical system. Contact an authorized Volvo workshop or trained and qualified Volvo service technician.</p>

A US models

B Canadian models

**⚠ WARNING**

- If the fluid level is below the **MIN** mark in the brake fluid reservoir or if a warning message is displayed in the text window: **DO NOT DRIVE**. Have the vehicle towed to a trained and qualified Volvo service technician and have the brake system inspected.
- If the **BRAKE** and **ABS** symbols illuminate at the same time, there is a risk of reduced vehicle stability.

### Door/hood/tailgate/fuel filler door reminder

If a door, tailgate, the hood or the fuel filler door are not closed properly, the information or warning symbol will illuminate and a graphic will be displayed in the instrument panel.

### Related information

- Instrument panel (p. 124)
- Indicator symbols in the instrument panel (p. 127)

## Compass

The rear-view mirror has an integrated compass that shows the direction in which the vehicle is traveling.

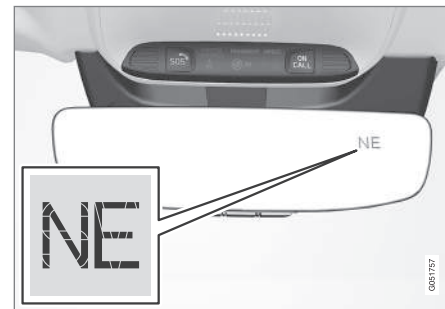

Rearview mirror with compass

Eight different directions are shown with the abbreviations: **N** (north) **NE** (northeast) **E** (east), **SE** (southeast) **S** (south), **SW** (southwest) **W** (west) **NW** (northwest)

### Switching the compass on/off

The compass is displayed automatically when the vehicle is started.

To switch the compass on/off:

- Use a pen, paperclip or similar object and press in the button on the underside of the mirror.

## Related information

- Calibrating the compass (p. 137)
- Ignition modes (p. 380)

## Calibrating the compass

North America is divided into 15 magnetic zones and the compass will need to be calibrated if the vehicle is driven from one zone to another.

To calibrate the compass:

1. Stop the vehicle in a large open area, safely out of traffic and away from steel structures and high-tension electrical wires.
2. Start the vehicle.

### **i** NOTE

- For best calibration results, switch off all electrical equipment in the vehicle (climate system, windshield wipers, audio system, etc.) and make sure that all doors are closed.
- Calibration may not succeed or be incorrect if the vehicle's electrical equipment is not switched off.

3. Using a pen, paperclip or similar object, press and hold the button on the underside of mirror for approx. 3 seconds until the number of the current magnetic zone is displayed.

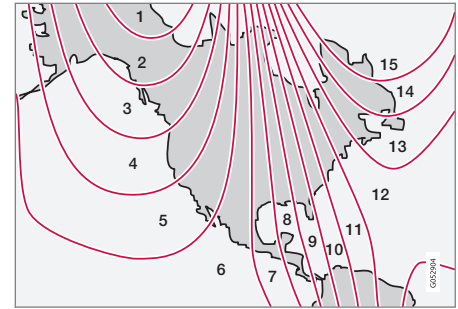

Magnetic zones

4. Press the button on the underside of mirror repeatedly until the desired magnetic zone (1-15) is displayed (see the map of magnetic zones).
5. Wait until **C** is again displayed in the mirror or hold the button on the underside of mirror for approx. 6 seconds until **C** is displayed in the mirror.
6. Drive slowly in a circle at a speed of no more than 6 mph (10 km/h) until a direction is displayed. This indicates that calibration is complete. Drive around in a circle an additional two times to fine-tune the calibration.
7. **Vehicles with an electrically heated windshield:**\* if **C** is displayed when the heating function is activated, perform step 6 with the heating function on.



- ◀ 8. Repeat the calibration procedure if necessary.

**Related information**

- Defrosting windows and mirrors (p. 194)
- Compass (p. 136)



**Lighting panel and controls**

The lighting ring on the left-side steering wheel lever can be used to activate the vehicle's exterior lighting.

Instrument lighting brightness can be adjusted using the thumb wheel on the lighting panel.

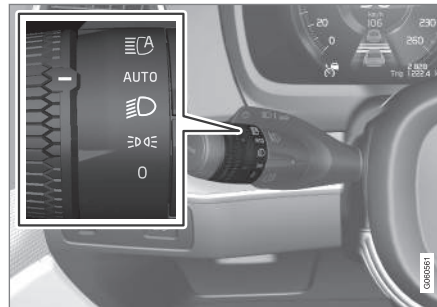
**Lighting ring on the left-side steering wheel lever**



Lighting ring position	Result
0	<p><b>With the ignition in mode II or if the engine is running:</b></p> <ul style="list-style-type: none"> <li>• In the <b>US</b>: the Daytime Running Lights (DRL) will be <b>off</b></li> <li>• In <b>Canada</b>: the Daytime Running Lights will be <b>on</b></li> <li>• High beam flash can be used</li> </ul>
	<p><b>With the ignition in mode II or if the engine is running:<sup>A</sup></b></p> <ul style="list-style-type: none"> <li>• Parking lights will be <b>on</b></li> <li>• In the <b>US</b>: the Daytime Running Lights will be <b>off</b></li> <li>• In <b>Canada</b>: the Daytime Running Lights will be <b>on</b></li> <li>• High beam flash can be used</li> </ul>
	<p><b>With the ignition in mode II or if the engine is running:</b></p> <ul style="list-style-type: none"> <li>• The Daytime Running Lights will be <b>off</b></li> <li>• The low beam headlights will be <b>on</b></li> <li>• High Beams/High Beam flash can be used</li> </ul>



Lighting ring position	Result
<b>AUTO</b>	<p><b>With the ignition in mode II or if the engine is running:</b></p> <ul style="list-style-type: none"> <li>• The Daytime Running Lights will be <b>on</b> in daylight conditions<sup>B</sup></li> <li>• The low beam headlights will automatically switch on in dark conditions</li> <li>• Tunnel detection will be activated</li> <li>• Active High Beams (AHB) can be activated</li> <li>• High beam flash can be used</li> <li>• Continuous high beams can be used in dark conditions</li> </ul>
	Active High Beams On/Off

<sup>A</sup> The parking lights will be on in this position, even if the ignition is switched off. In dark conditions, the rear parking lights illuminate automatically when the tailgate is open, regardless of the ring's position or ignition mode.

<sup>B</sup> US models only: The use of Daytime Running Lights can be activated/deactivated in the center display's Settings menu.

 <b>NOTE</b>
Volvo recommends the use of Daytime Running Lights in the United States. The use of these lights is <b>mandatory in Canada</b> .

**Volvo recommends using the AUTO position whenever possible.**

 <b>WARNING</b>
<ul style="list-style-type: none"> <li>• Daytime Running Lights are a driving aid designed to help make the vehicle visible to other roads users.</li> <li>• The driver is always responsible for adapting the use of Daytime Running Lights/headlights according to ambient lighting and weather conditions.</li> </ul>

## Lighting panel

### Instrument lighting



Thumb wheel (to the left) for adjusting display brightness

Illumination of the display and instrument lights will vary, depending on ignition mode.

The display lighting is automatically subdued in darkness and the sensitivity is set with the thumb wheel.

### Related information

- Daytime Running Lights (DRL) (p. 140)
- High and low beam headlights (p. 142)
- Ignition modes (p. 380)

## Parking lights

Turn the parking lights on by turning the lighting ring on the left-side steering wheel lever.

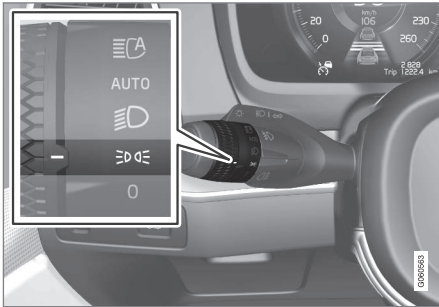

Lighting ring in the parking light position

Turn the lighting ring to the  position (the license plate lighting comes on at the same time).

**Canadian models:** If the ignition is in position II or the engine is running, the daytime running lights will illuminate instead of the front parking lights.

With the lighting ring in this position, the parking lights will remain on even when the ignition is switched off.

In dark conditions, the rear parking lights also illuminate when the tailgate is opened to alert anyone traveling behind your vehicle. This hap-

pens regardless of the position that the lighting ring is in or which mode the ignition is in.

## Related information

- Lighting panel and controls (p. 138)

## Daytime Running Lights (DRL)

The car monitors ambient lighting conditions.

With the ring on the left-side steering wheel lever in the **AUTO** position and the ignition in mode **II** (or the engine running), the lights toggle automatically between DRL and low beam headlights.

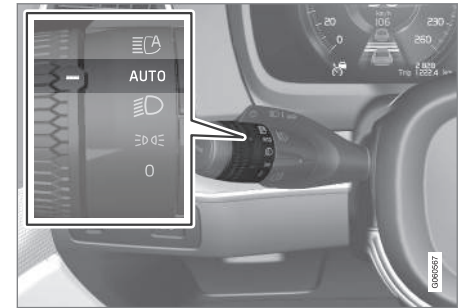

Ring in the **AUTO** position.

### **NOTE**

Volvo recommends the use of Daytime Running Lights in the United States. The use of these lights is **mandatory in Canada**.

### With the lighting ring in the **0** position:

- In the **US**: DRL will be **off**
- In **Canada**: DRL will be **on**

With the lighting ring in the  $\text{DRL}^9$  position and the ignition in mode II or if the engine is running:

- In the **US**: DRL will be **off**
- In **Canada**: DRL will be **on**

With the lighting ring in the **AUTO** position:

- DRL will be **on** (the low beam headlights will automatically switch on in dark conditions)

**US models only:** DRL can be deactivated in the center display's Settings view.

With **AUTO** selected, a tunnel detection function activates the low beams when the vehicle enters a tunnel.

With the lighting ring in the  $\text{D}$  position:

- DRL will be **off** and the low beam headlights will be **on**

## Low beam headlights

The low beam headlights can be activated in several ways.

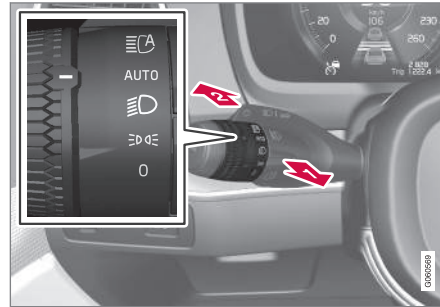

Lighting ring

**In dark conditions**, the low beams will be activated automatically when the engine is started or the ignition is in mode II and the lighting ring is turned to the **AUTO** position.

With the lighting ring in the **AUTO** position, the low beams will also be activated if:

- the front fog lights are activated
- the rear fog lights are activated
- both the front and rear fog lights are activated

If the lighting ring is turned to  $\text{D}$ , the low beams will be activated automatically when the

engine is started or the ignition is in mode II, regardless of the ambient lighting conditions.

### Related information

- Daytime Running Lights (DRL) (p. 140)
- Ignition modes (p. 380)



<sup>9</sup> The parking lights will be on in this position, even if the ignition is switched off.

## High and low beam headlights

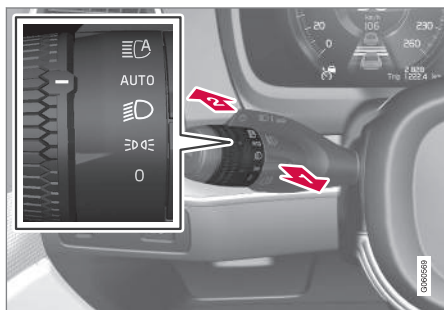
If the ignition is in mode II or when the engine is started, the low beams are activated automatically if the lighting ring is in position . In dark conditions, the low beams will also be on if the lighting ring is in the **AUTO** position.



Lighting ring

-  High beam flash
-  Continuous high beams

## High beam flash

Pull the lever slightly toward the steering wheel. The high beams illuminate until the lever is released.

## Continuous high beams

Continuous high beams are available if the lighting ring is turned to **AUTO**<sup>10</sup> or . Toggle to high beams by moving the lever forward. Return to low beams by moving the lever toward the steering wheel.

The  symbol will illuminate in the instrument panel when the high beams are on.

## Active high beams

The active high beam system uses a camera at the upper edge of the windshield to detect the headlights of oncoming vehicles or the taillights of a vehicle directly ahead. When this happens, the headlights will automatically switch from high beams to low beams.

When the camera no longer detects an approaching vehicle or one that is ahead, your headlights will switch back to high beams.

## Vehicles with halogen headlights<sup>11</sup>

When the camera no longer detects the headlights of an approaching vehicle or the taillights of a vehicle ahead, your headlights will switch back to high beams after several seconds.

## Operation

Activate/deactivate this function by turning the lighting ring past the **AUTO** position to .

When released, the ring will automatically return to the **AUTO** position.

If the active high beam function has not been activated, switching between high and low beams must be done manually.

A **white** symbol () in the instrument panel indicates that the function has been activated.

When the high beams are on, the symbol will change to **blue**.

### NOTE

- Keep the windshield in front of the camera free of ice, snow, dirt, etc.
- Do not mount or in any way attach anything on the windshield that could obstruct the camera.



If a message is displayed in the instrument panel saying that active high beams are temporarily unavailable, switching between high and low beams will have to be done manually. However, the light switch can remain in the **AUTO** position. The same applies if a message saying that the windshield sensors are blocked and the symbol above are displayed. The  symbol will go out if this happens.

<sup>10</sup> When the low beams are on.

<sup>11</sup> Halogen headlights are not available on all models.

Active high beams may be temporarily unavailable (e.g., in heavy fog or rain). When the system becomes active again or if the sensors in the windshield are no longer obscured, the messages will disappear and the  symbol will illuminate.

### WARNING

- Automatic high beams are a driving aid designed to help provide the best possible headlight illumination in good driving conditions.
- The use of aftermarket or non-Volvo glass can have an adverse effect on the automatic high beam function.
- The driver is always responsible for manually toggling between high and low beams when this is required by traffic or weather conditions.

### CAUTION

In the following situations, it may be necessary to switch between high and low beams manually:

- In heavy fog or rain
- In blowing snow or slush
- In bright moonlight
- In freezing rain
- In areas with dim street lighting
- When oncoming vehicles have dim front lighting
- If there are pedestrians on or near the road
- If there are reflective objects, such as signs, near the road
- When oncoming vehicles' lights are obscured by e.g., fences, bushes, etc.
- When there are vehicles on connecting roads
- At the top of hills or in dips in the road
- In sharp curves

### Related information

- City Safety™ troubleshooting (p. 310)
- Lighting panel and controls (p. 138)

## Active Bending Lights\*

Active Bending Lights (ABL) are designed to help light up a curve according to movements of the steering wheel.

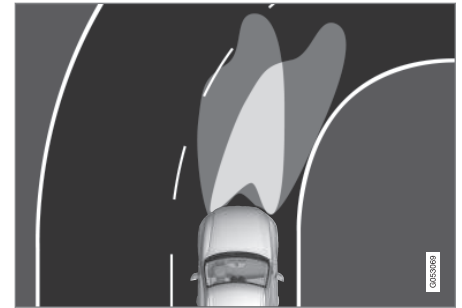

Headlight pattern with the Active Bending Light function deactivated (left) and activated (right)

ABL is activated automatically<sup>12</sup> when the engine is started and the low beam headlights are on. ABL can be deactivated in the center display.

If a fault is detected in the system, the  symbol in the instrument panel will illuminate. A text message will be displayed and an additional symbol will also illuminate.

<sup>12</sup> The factory default setting is on.



### **i** NOTE

This function is only active in twilight or dark conditions, and only when the vehicle is in motion.

### Deactivating/activating the function

ABL can be deactivated/activated in two ways in the center display:

#### Via Function view



Tap the **Active Bending Lights** button.

#### Via settings

1. Tap **Settings** in Top view.
2. Tap **My Car** → **Lights and Lighting** → **Exterior Lights**.
3. Deselect/select **Active Bending Lights**.

#### Related information

- Settings view (p. 109)

### Front fog lights\*



Front fog light button

The front fog lights can be used in combination with the low beam headlights.

All fog lights also illuminate when the vehicle is backing up.

Press the button to turn the fog lights on/off. The indicator symbol  in the instrument panel illuminates when the front fog lights are on.

### **i** NOTE

The front fog lights cannot be used if the continuous high beam headlights are on. If the front fog lights are already on when the continuous high beams are switched on, the front fog lights will switch off.

However, using the high beam flash function will not affect the front fog lights.

### Corner illumination

The front fog lights include corner illumination, which temporarily provides extra light to the front left or right of the vehicle (depending on which way the vehicle is turned) when making a sharp turn at low speeds (for example, when turning into a parking space) or when the turn signals are used.

This function is activated in darkness or in poor daylight conditions when the lighting ring on the left-side steering wheel lever is in the **AUTO** or  positions when the vehicle's speed is under approx. 20 mph (30 km/h).

When the vehicle is backing up, corner illumination also switches on to supplement the backup light.

Corner illumination is activated by default and can be deactivated/reactivated in the center display.

**Related information**

- Low beam headlights (p. 141)
- Lighting panel and controls (p. 138)

**Rear fog lights (certain models only)<sup>13</sup>**

The rear fog light(s) are considerably brighter than the normal taillight and should be used only when conditions such as fog, rain, snow, smoke or dust reduce visibility for other vehicles to less than approx. 500 ft. (150 meters).





Rear fog light button

**i NOTE**

Rear fog lights are not available on all models or in all markets.

The rear fog lights can only be used when:

- the ignition is in mode **II** or if the engine is running and the lighting ring is in the **AUTO** or  position
- the lighting ring is in the  position and the front fog lights are on

Press the button to turn the rear fog lights on/off. The rear fog light indicator symbol  in the instrument panel illuminates when the rear fog lights are switched on.

The rear fog lights turn off automatically when:

- the start knob is turned to **STOP** or when the lighting ring is turned to the **0** position
- the lighting ring is in the  position and the front fog lights are turned off

**Related information**

- Lighting panel and controls (p. 138)

<sup>13</sup> Some models are equipped with one rear fog light only, on the driver's side of the vehicle.

## Brake lights

The brake lights illuminate automatically when the brakes are applied.

In addition to illuminating when the brake pedal is depressed, the brake lights also illuminate when one of the driver support systems (e.g., adaptive cruise control, City Safety or collision warning) slow the vehicle.

### Related information

- Adaptive Cruise Control (ACC)\* (p. 269)
- City Safety™ (p. 304)
- Emergency brake lights (p. 358)

## Hazard warning flashers

The hazard warning flashers should be used to indicate that the vehicle has become a traffic hazard.

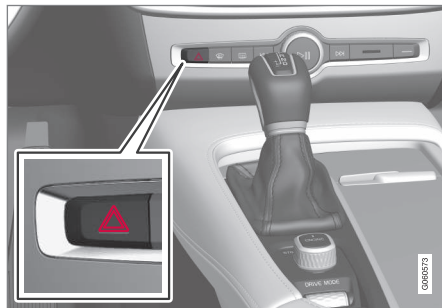

Hazard warning flasher button

Press the button to activate the flashers. Press the button again to turn off the flashers.

Regulations regarding the use of the hazard warning flashers may vary, depending on where you live.

### Related information

- Using turn signals (p. 146)

## Using turn signals

The turn signals are controlled using the left steering wheel lever. The turn signals flash three times or continuously, depending on how far up or down the lever is moved.

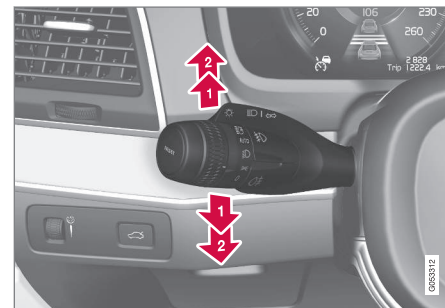

Turn signals

### Short flashing sequence

- ➔ The driver can automatically flash the turn signals 3 times by moving the left steering wheel lever up or down to the first position and releasing it. This function can be activated/deactivated in the center display.



**i NOTE**

- This automatic flashing sequence can be interrupted by immediately moving the lever in the opposite direction.
- If the turn signal indicator flashes faster than normal, see the message in the instrument panel.

**Continuous flashing sequence**

- ➔ Move the lever as far up or down as possible to start the turn signals.

The turn signals will be cancelled automatically by the movement of the steering wheel, or the lever can be returned to its initial position by hand.

**Related information**

- Lighting panel and controls (p. 138)
- Hazard warning flashers (p. 146)
- Settings view (p. 109)

**Passenger compartment lighting**

The passenger compartment lighting is controlled using the buttons in the ceiling above the front and rear seats.

All passenger compartment lighting can be turned on and off manually within 30 minutes after:

- the vehicle is unlocked but the engine has not been started
- the engine is switched off and the ignition is in mode **0**.

**Front interior lighting**

Controls in the ceiling console for front reading lights and courtesy lighting

- ➊ Driver's side reading light
- ➋ Courtesy lighting

- ➌ Courtesy lighting (**AUTO**) switch
- ➍ Passenger's side reading light

**Front reading lights**

Turn the reading lights on or off by pressing the respective buttons briefly. Adjust the brightness by pressing and holding the button.

**Courtesy lighting**

Turn the footwell and overhead courtesy lighting on or off by pressing the button briefly.

**Courtesy lighting switch**

Activate the automatic function by briefly pressing the **AUTO** button in the ceiling console. The indicator light in the button will illuminate. With **AUTO** activated, the courtesy lighting will switch on and off as follows:

The courtesy lighting:

- comes on when the vehicle is unlocked and when the ignition is switched off
- goes off when the engine is started and when the vehicle is locked
- comes on or goes off when one of the side doors is opened or closed
- remains on for 2 minutes if a side door is left open

The courtesy lighting switches off when:

## ◀ Rear interior lighting

### Rear reading lights

The rear interior lighting/reading lights are located in the ceiling.



Rear reading lights: second<sup>14</sup> and third row\* of seats



Rear reading light: second row of seats in models with a laminated panoramic roof\*

The rear reading lights are turned on or off by briefly pressing the button in the ceiling console. Adjust the brightness by pressing and holding the button.

### Glove compartment lighting

The glove compartment lighting comes on or goes off when the glove compartment is opened or closed.

### Vanity mirror lighting

The vanity mirror lighting comes on or goes off when the cover over the mirror is opened or closed.

### Ground lighting

The ground lighting comes on or goes off when a door is opened or closed.

### Doorsill lighting

The doorsill lighting comes on or goes off when a door is opened or closed.

### Cargo area lighting

The cargo area lighting comes on or goes off when the tailgate is opened or closed.

### Ambience lighting

1. In the center display's Top view, select **Settings → My Car → Lights and Lighting → Ambient Lighting**
2. Choose among the following settings:
  - Under **Ambient Light Intensity**, choose: **Off**, **Low** or **High**.
  - **Ambient Light Level: Reduced** or **Full**.

<sup>14</sup> In models with a laminated panoramic roof\* there are lights on each side of the roof



The ambience lighting can also be fine-tuned using the thumb wheel (on the dashboard to the left of the steering wheel)

### Mood lighting\*

When the overhead courtesy lighting has gone out and the engine is running, several LEDs located near the roof console illuminate to provide faint lighting to help e.g., see objects in storage compartments. This lighting goes out just after the overhead courtesy lighting when the vehicle is locked.

The following settings can be made for the mood lighting in the center display:

#### Brightness

1. In the center display's Top view, select **Settings → My Car → Lights and Lighting → Interior Mood Lighting**.
2. Press **Interior Mood Light Intensity** and choose **Off**, **Low** or **High**.

### Change the color of the light

1. In the center display's Top view, select **Settings → My Car → Lights and Lighting → Interior Mood Lighting**.
2. Choose **By Temperature**, **By Color** or **Theme Colors**.



The intensity of the mood lighting can also be fine-tuned using the thumb wheel (on the dashboard to the left of the steering wheel)

### Lighting in the door storage compartments

This lighting is illuminated when the engine is running. Adjust brightness with the thumb wheel on the lighting panel.

### Lighting in the front tunnel console cup holders

This lighting is switched on or off when the vehicle is unlocked or locked. Adjust brightness with the thumb wheel on the lighting panel.

#### Related information

- Lighting panel and controls (p. 138)
- Ignition modes (p. 380)
- Settings view (p. 109)

## Home safe lighting

The home safe lighting function illuminates the area in front of the vehicle in dark conditions.

This function turns on the headlights, parking lights, outer door handle lights\* and license plate lights for a set amount of time.

The length of time that these lights remain illuminated can be set in the center display. The default setting is 30 seconds.

To activate home safe lighting:

1. Switch off the ignition (mode **0**).
2. Push the turn signal lever as far as possible towards the dashboard and release it.
3. Exit the vehicle and lock the doors.

## Related information

- Using the center display (p. 44)
- Settings view (p. 109)
- Ignition modes (p. 380)

## Approach lighting

Approach lighting (the parking lights, outer door handle lights\*, license plate lighting, courtesy lighting and footwell lighting) can be activated to provide light as you walk toward the vehicle.

To use this feature, deselect/select **Welcome Light** in the center display's menu system.

If this function has been selected in the menu, **it is activated by pressing the unlock button on the remote key as you approach the vehicle.**

If a door is opened while the function is activated, the lighting in the outer door handle\* and courtesy lighting will remain illuminated for a somewhat longer period of time.

## Related information

- Settings view (p. 109)
- Home safe lighting (p. 150)
- Remote key (p. 227)

## Messages in the instrument panel and center display

Information and warning messages are displayed in the instrument panel and center display.

### Instrument panel



Message in the instrument panel (12" version)

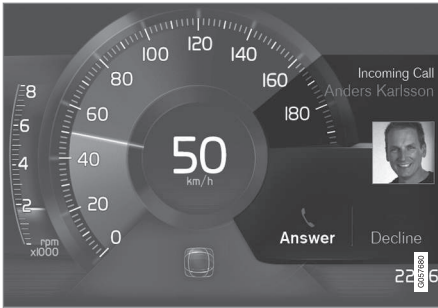

Message in the instrument panel (8" version)

High-priority messages are displayed in the instrument panel.

Messages may appear in different parts of the instrument panel depending on their context. The message will time out after a short period of time or disappear when it has been confirmed or if action has been taken. Messages that need to be stored will be saved under **My car messages** in the center display's Top view.

The message may be displayed along with graphics, symbols or buttons for e.g., confirming the message or accepting a request.

### Service messages

The following table lists a selection of important service messages and the action that should be taken.

Message	Action
<b>Stop safely<sup>A</sup></b>	Stop and switch off the engine. There is a risk of serious damage to the vehicle <sup>B</sup> .
<b>Turn off engine<sup>A</sup></b>	Stop and switch off the engine. There is a risk of serious damage to the vehicle <sup>B</sup> .
<b>Service urgent Drive to workshop<sup>A</sup></b>	Contact a workshop <sup>B</sup> to have the vehicle inspected immediately.
<b>Service required<sup>A</sup></b>	Contact a workshop <sup>B</sup> to have the vehicle inspected as soon as possible.
<b>Book time for maintenance</b> <b>Time for maintenance</b>	Time for the next scheduled service. Contact a workshop <sup>B</sup> .

Message	Action
<b>Maintenance overdue</b>	Time for the next scheduled service. Contact a workshop <sup>B</sup> . If the service schedule is not followed, this may void all or part of the vehicle's warranty and result in damage to vehicle components.
<b>Temporarily off<sup>A</sup></b>	A function has been temporarily deactivated and will be reactivated automatically while driving or after the engine is restarted.

<sup>A</sup> Part of the message is context-dependent.

<sup>B</sup> Contact a Volvo retailer or a trained and qualified Volvo service technician.

## ◀ Center display



Message in the center display's status bar

Messages with lower priority for the driver are shown in the center display.

Most of the messages are shown in the center display's status bar. The message times out after a short period of time or disappears if it has been confirmed or if action has been taken. Messages that need to be stored are saved under **My car messages** in Top view.

Some messages in the center display contain one or more buttons for e.g., confirming the message or accepting a request.

Messages' form can vary and they may be displayed with graphics, symbols or buttons for e.g., confirming a message or accepting a request.

### Pop-up messages

Messages are sometimes displayed in pop-up windows. Messages of this type have higher pri-

ority than ones in the status bar and must be confirmed or action must be taken before they disappear. Messages that need to be stored are saved under **My car messages** in Top view.

### Related information

- Instrument panel (p. 124)
- Center display overview (p. 28)

## Handling messages in the instrument panel and center display

Messages in the instrument panel and center display are handled using the controls on the right-side steering wheel keypad and in the center display's various views.

### Instrument panel

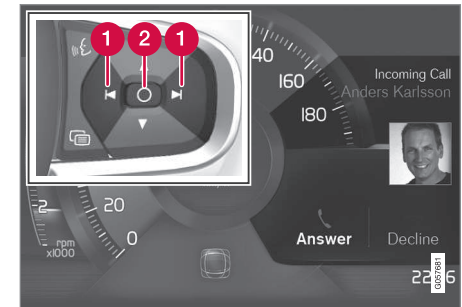

Message in the instrument panel (8" version) and the right-side steering wheel keypad



Message in the instrument panel (12" version) and the right-side steering wheel keypad

- 1 Left/right arrow keys
- 2 Confirm

Some messages in the instrument panel contain one or more buttons for e.g., confirming a message or accepting a proposal.

### Handling new messages

For messages with buttons:

1. Navigate among the buttons available by pressing the left/right arrow keys (1).
2. Confirm a choice by pressing (2).
  - > The message will disappear from the instrument panel.

For messages without buttons:

- Close the message by pressing (2) or let the message time-out after a short period.
  - > The message will disappear from the instrument panel.

If a message needs to be saved, it will be stored in the **Car status** app, which can be opened in the center display's App view. **Car message stored in Car Status application** will be displayed at this time in the center display.

### Center display

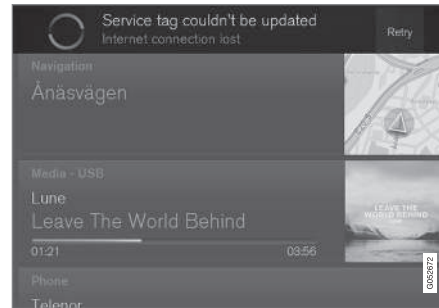

Message in the center display

Some buttons in the center display have a button (or several buttons in a pop-up) to make it possible to e.g., activate/deactivate a function related to the message.

### Handling new messages

For messages with buttons:

- Tap the button to carry out the action or let the message time-out after a short period.
  - > The message will disappear from the center display's status bar.

For messages without buttons:

- Close the message by tapping it or let the message time-out after a short period.
  - > The message will disappear from the center display's status bar.

If a message needs to be saved, it will be stored in the center display's Top view.

### Related information

- Messages in the instrument panel and center display (p. 150)
- Using the instrument panel App menu (p. 156)

## Handling messages stored from the instrument panel and center display

### Messages saved from the instrument panel

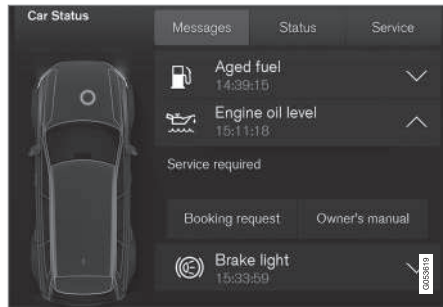

Saved messages and possible selections in the **Car status** app



Messages that have been displayed in the instrument panel and need to be saved are stored in the **Car status** app, which can be opened in the center display's App view. **Car message stored in Car**

**Status application** will be displayed at this time in the center display.

### Reading saved messages

Reading a saved message immediately:

- Tap the button to the right of the message **Car message stored in Car Status application** in the center display.
  - > The saved message will be displayed in the **Car status** app.

Reading a saved message at a later time:

1. Open the **Car status** app in the center display's App view.
  - > The app will open in Home view's lowest sub-view.
2. Select the **Messages** tab in the app.
  - > A list of saved messages will be displayed.
3. Tap the arrow to the right to expand/minimize the message.
  - > More information about the message will appear in the list and the image to the left in the app will show information about the message in graphic form.

### Handling a saved message

In expanded form, some messages have two buttons for booking service or reading the owner's manual.

Booking service:

- With the message in expanded form, tap **Request appoint./Call to make Appointment**<sup>15</sup> to book a service/repair appointment.
  - > **Request appoint.:** the **Appointments** tab will open in the app and create a request for a service/repair appointment.
  - > **Call to make Appointment:** the phone app will start and initiate a call to your preferred retailer to make a service/repair appointment.

Reading the owner's manual:

- With the message in expanded form, tap **Owner's manual** to read the section of the owner's manual related to the message.
  - > The owner's manual will open in the center display and provide information related to the message.

Messages stored in the app will be erased automatically each time the engine is started.

<sup>15</sup> Certain markets only.



## Messages saved from the center display

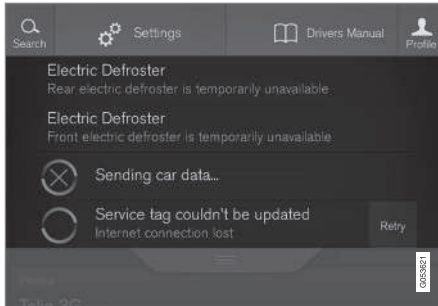

Saved messages and possible selections in Top view

Messages that have been shown in the center display and need to be saved are stored in the center display's Top view.

### Reading a saved message

1. Open the center display's Top view.
  - > A list of saved messages will be displayed. The ones with an arrow to the right can be expanded.
2. Tap the arrow to the right to expand/minimize the message.

### Handling a saved message

Some messages have a button to e.g., activate/deactivate a function related to the message.

- Tap the button to carry out the action.

Messages saved in Top view are erased automatically when the engine is switched off.

### Related information

- Handling messages in the instrument panel and center display (p. 152)

## Instrument panel App menu

The App (application) menu in the instrument panel provides quick access to commonly used functions in certain apps.



In some cases, the App menu can be used instead of the center display

The App menu is displayed in the instrument panel and is controlled using the right-side steering wheel keypad. This menu makes it possible to toggle between apps or functions in apps without removing your hands from the steering wheel.

### App menu functions

The following apps and their functions can be controlled from the App menu:



App	Functions
Trip computer	Select a trip odometer, make instrument panel display settings, etc.
Media player	Select the active source for the media player.
Phone	Call a contact from the call list.
Navigation	Pause guidance, start guidance to a recently set destination, etc.

### Related information

- Instrument panel (p. 124)
- Center display overview (p. 28)
- Using the instrument panel App menu (p. 156)

## Using the instrument panel App menu

The App (application) menu in the instrument panel is controlled using the right-side steering wheel keypad.

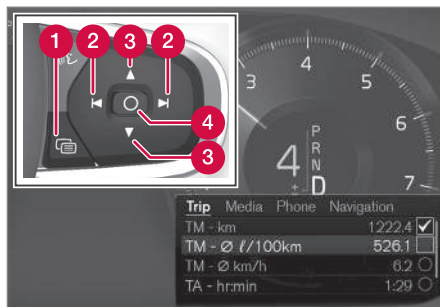

App menu and right-side steering wheel keypad

- 1 App menu
- 2 Left/right
- 3 Up/down
- 4 Confirm

## Opening/closing the App menu

- Press the App menu (1).

The App menu cannot be opened if there are unread/unconfirmed messages in the instrument panel. The message must be confirmed before the App menu can be opened.

> The App menu opens/closes.

The App menu closes automatically after a period of inactivity or after certain selections are made.

## Navigating and making selections in the App menu

1. Navigate between the various apps by pressing left or right (3).
  - > Functions for the preceding/next app will be displayed in the App menu.
2. Scroll through the current app's selections using up or down (4).
3. Confirm or select a function by pressing (2).
  - > The function will be activated and in certain cases, the App menu will close.

## Related information

- Instrument panel App menu (p. 155)

## Using the windshield wipers

Before using the wipers, ice and snow should be removed from the windshield. Be sure the wiper blades are not frozen in place.

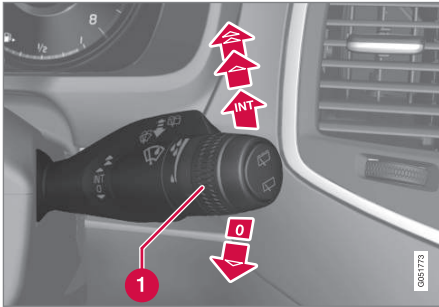

Right-side steering wheel lever

- 1 Thumb wheel to set rain sensor\* sensitivity/interval wiper speed

### Single sweep

 Move the lever down and release it for a single sweep.

### Wipers off

**0** Move the lever to position **0** to turn off the windshield wipers.

### Interval wipers

**INT** Set the wiper interval speed by moving the thumb wheel upward or downward.

## Continuous wipers

 Move the lever upward for the wipers to operate at normal speed.

### **i** NOTE

Before using the wipers, be sure that the wiper blades are not frozen onto the windshield and that any ice or snow on the windshield has been removed.

 Move the lever upward to the next position for maximum wiper speed.

### Related information

- Tailgate window wiper and washer (p. 159)
- Activating/deactivating the rain sensor (p. 157)
- Windshield and headlight washers (p. 158)

## Activating/deactivating the rain sensor

The rain sensor monitors the amount of water on the windshield and automatically regulates wiper speed.

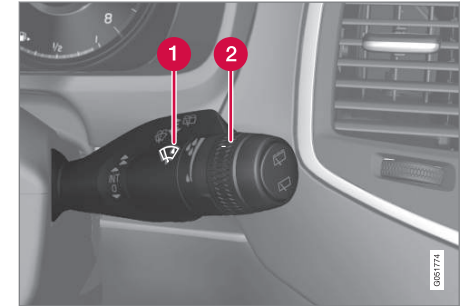

Right-side steering wheel lever

- 1 Rain sensor button
- 2 Thumb wheel for adjusting sensitivity/interval wiper speed

When the rain sensor is activated, the  symbol will illuminate in the instrument panel.

### Activating the rain sensor

When activating the rain sensor, the engine must be running or the ignition must be in mode **I** or **II**.

The windshield wiper lever must also be in position **0** or in the single sweep position.



- ◀ Activate the rain sensor by pressing the  button. The wipers will make one sweep.

If the lever is pressed down, the wipers will make additional sweeps across the windshield.

Move the thumb wheel upward for increased sensitivity or downward for decreased sensitivity. The wipers will make one extra sweep if the thumb wheel is moved upward.

### Deactivating the rain sensor

Deactivate the rain sensor by pressing the  button or by moving the lever upward to another wiper position.

The rain sensor is automatically deactivated in ignition mode **O**.

The rain sensor is also automatically deactivated when the wipers blades are put in the service position and will reactivate when the wipers have been returned to the normal operating position.

### CAUTION

Deactivate the rain sensor when washing the vehicle in an automatic car wash if the engine is running or if the ignition is left in mode **I** or **II**. The symbol in the instrument panel will go out. If the rain sensor is not deactivated, the wipers may start inadvertently in the car wash and could be damaged.

### Activating/deactivating the memory function

The rain sensor's memory function can be set to activate the rain sensor each time the engine is started:

1. In the center display, select **Settings** → **My Car** → **Wipers**
2. Activate by selecting the **Rain Sensor Memory** box.

Deactivate by deselecting the **Rain Sensor Memory** box.

### Related information

- Using the windshield wipers (p. 157)
- Windshield wipers in the service position (p. 518)
- Tailgate window wiper and washer (p. 159)

### Windshield and headlight washers

Use the windshield/headlight washers to help improve visibility.

### Starting the windshield and headlight washers



Washing function

- Move the right-side steering wheel lever toward the wheel to start the windshield and headlight washers.
  - > After the lever is released the wipers make several extra sweeps.

**CAUTION**

- Use ample washer fluid when washing the windshield. The windshield should be thoroughly wet when the wipers are in operation.
- Avoid using the washers if the fluid reservoir is frozen or empty to help avoid damage to the pump.

When the washing system is used, the length of time that the windshield washers operate depends on the ambient temperature. In cold weather, the amount of washer fluid used will also be increased automatically to help improve cleaning.

**Heated washer nozzles\***

The washer nozzles are heated automatically in cold weather to help prevent the washer fluid from freezing.

**High-pressure headlight washing\***

High-pressure headlight washing consumes a large quantity of washer fluid. To save fluid, the headlights are washed once for every five times the windshield is washed.

**Reduced washing**

When approx. 1 US quart (1 liter) of washer fluid remains in the reservoir, the headlights will no longer be washed to conserve fluid.

A text message and the  symbol will be displayed in the instrument panel to remind the driver to fill the washer fluid reservoir.

**Related information**

- Refilling the windshield washer fluid reservoir (p. 521)
- Using the windshield wipers (p. 157)
- Tailgate window wiper and washer (p. 159)



**Tailgate window wiper and washer**

Start the tailgate window wiper/washer with controls on the right-side steering wheel lever.

**NOTE**

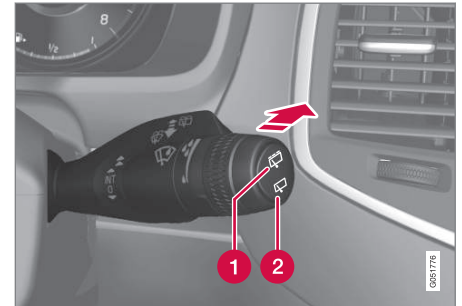
The rear wiper is equipped with a cut-off function, which means that it will not operate if its electric motor overheats. The wiper will function again after a cool-down period (30 seconds or longer, depending on the heat of the motor and ambient temperature conditions).

**Using the tailgate wiper/washer**

- 1 Press  for tailgate interval wiper
  - 2 Press  for tailgate continuous wiper
- Move the lever forward to wash/wipe the tailgate window.



## ◀ Tailgate wiper and reverse gear

1. In the center display, select **Settings** → **My Car** → **Wipers**.
2. Activate/deactivate by selecting/deselecting the **Auto Rear Wiper** box.

If the windshield wipers are on and the transmission is put into reverse gear, the tailgate wiper will start. This function is deactivated when a different gear is selected.

### Related information

- Using the windshield wipers (p. 157)
- Windshield and headlight washers (p. 158)
- Refilling the windshield washer fluid reservoir (p. 521)
- Activating/deactivating the rain sensor (p. 157)

## Steering wheel

The steering wheel has controls for the horn, certain optional driver support systems, menus/messages and paddles for manually shifting gears\*.



Steering wheel keypads and paddles\*

- 1 Driver support system controls<sup>16</sup>
- 2 Paddles for manually shifting gears\*
- 3 Keypad for voice controls, adjusting the head-up display\*accessing menus and messages, and handling phone calls

## Horn



The horn is located in the steering wheel hub.

### Related information

- Adjusting the steering wheel (p. 161)
- Turning steering wheel heating\* on and off (p. 197)
- Cruise Control (CC) (p. 262)
- Speed limiter (SL)\* (p. 255)
- Adaptive Cruise Control (ACC)\* (p. 269)
- Distance Alert\* (p. 267)
- Pilot Assist\* (p. 283)
- Steering wheel paddles\* (p. 396)
- Voice control (p. 119)
- Head-up display (HUD)\* (p. 116)

<sup>16</sup> Cruise control\*, Speed limiter \*, Adaptive cruise control\*, Distance alert\* and Pilot Assist\*.

- Using the instrument panel App menu (p. 156)
- Phone (p. 419)

## Adjusting the steering wheel

The steering wheel can be adjusted to various positions.

### **WARNING**

Never adjust the steering wheel while driving.

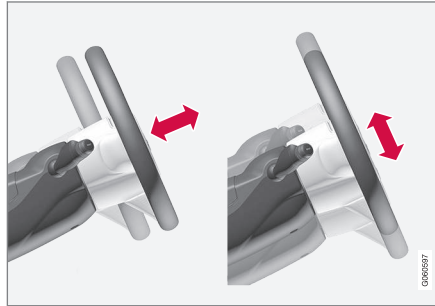

The steering wheel's height and reach can be adjusted

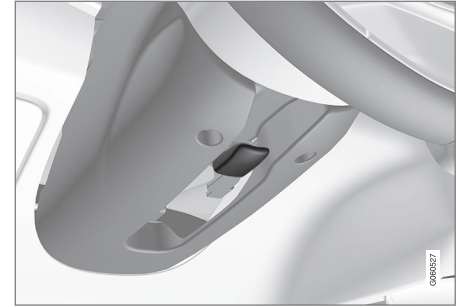

Adjusting the steering wheel

To adjust the steering wheel:

1. Push the lever downward/forward to release the steering wheel.
2. Adjust the steering wheel to a suitable position.
3. Pull back the lever to lock the steering wheel in place. If the lever is difficult to pull into place, press the steering wheel lightly at the same time as you pull the lever.

### Related information

- Steering wheel (p. 160)
- Adjustable steering force\* (p. 250)

## Seats

The vehicle can be equipped with 5 or 7 seats\*. The front seats can be adjusted electronically\* or manually. The second and third row\* seats are adjusted primarily manually.

The adjustment settings for the power front seats\*, door mirrors and the head-up display can be stored in memory buttons.

Using the multi-function control\*, comfort in the front seats can be further enhanced by e.g., adjusting the lumbar support or extending the length of the front seat cushion.

The rear seats can be folded down and their head restraints can be adjusted. The second row seats can be moved forward/rearward and their backrest tilt can also be changed.

### Related information

- Adjusting power front seats\* (p. 163)
- Adjusting function settings in the multifunctional front seats\* (p. 166)
- Manually operated front seats (p. 162)
- Using the power seat memory function\* (p. 165)
- Folding the second row backrests (p. 173)
- Getting into and out of the third row of seats (p. 174)
- Moving the second row seats forward/rearward (p. 171)

- Adjusting the second row backrest tilt (p. 172)

## Manually operated front seats

The front seats can be adjusted in a number of ways to help provide the most comfortable seating position.



- 1 Raise/lower the front edge of seat cushion by pumping up/down
- 2 Change the length of the seat cushion by pulling up the lever and moving the cushion forward/rearward with your hand
- 3 Move the seat forward/rearward by pulling the bar upward and moving the seat.
- 4 Change lumbar support by pressing the button\*
- 5 Raise/lower the seat by moving the control up/down
- 6 Change backrest tilt by turning the wheel



**⚠ WARNING**

- Do not adjust the seat while driving. The seat should be adjusted so that the brake pedal can be depressed fully. In addition, position the seat as far rearward as comfort and control allow.
- Check that the seat is securely locked into position after adjusting.

**Related information**

- Turning seat heating\* on and off (p. 198)
- Power front seats\* (p. 163)
- Multifunctional front seats\* (p. 166)
- Seat belts (p. 60)

**Power front seats\***

The power front seats offer a number of adjustment possibilities to help maximize comfort and ergonomics.

The power seats have an overload protector that activates if a seat is blocked by any object. If this occurs, put the ignition in mode **I** or **0** and wait for a short period before operating the seat again.

The power seat(s) can be adjusted for a short period after unlocking the door with the remote key without switching the ignition on. Seat adjustment can always be made when the engine is running.

**Related information**

- Multifunctional front seats\* (p. 166)
- Adjusting power front seats\* (p. 163)
- Using the power seat memory function\* (p. 165)
- Manually operated front seats (p. 162)
- Turning seat heating\* on and off (p. 198)
- Turning front seat ventilation\* on and off (p. 200)

**Adjusting power front seats\***

The power front seat(s) can be adjusted to many positions to help improve comfort and ergonomics.

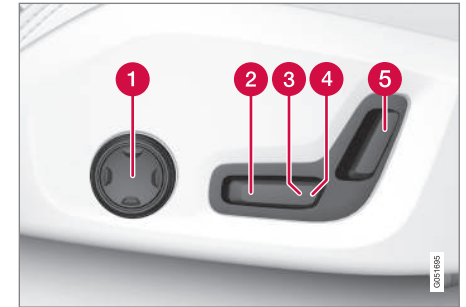

- 1 Adjust lumbar support by pressing the control up/down/forward/rearward
- 2 Raise/lower the front edge of the seat cushion by moving the control up/down
- 3 Raise/lower the seat by moving the control up/down
- 4 Move the seat forward/rearward by moving the control forward/rearward
- 5 Change backrest tilt by moving the control forward/rearward

Only one of the power seat's controls can be used at the same time.

The front seat backrests can be folded down completely.



#### ◀ Related information

- Power front seats\* (p. 163)
- Using the power seat memory function\* (p. 165)
- Multifunctional front seats\* (p. 166)
- Seat belts (p. 60)

### Adjusting the passenger's seat from the driver's seat\*

Using the controls on the side of the driver's seat, the driver can adjust the position of the front passenger's seat.

#### Activating the function in the center display

From the center display, the function can be activated in two ways.

After activating the function, adjust the passenger's seat **within 10 seconds**. If no adjustments are made in that time span, the function deactivates automatically.

#### Activating from Function view



1. Go to the center display's Function view.
2. Activate the function by tapping **Adjust passenger seat**.

#### Activating from Settings

- In the center display, select **Settings → My Car → Seats → Adjust Passenger Seat From Driver Position**.



Power seat controls

- 1 Move the passenger's seat forward/rearward by moving the control forward/rearward.
- 2 Change the passenger seat's backrest tilt by moving the control forward/rearward.

#### Related information

- Power front seats\* (p. 163)
- Adjusting power front seats\* (p. 163)
- Seat belts (p. 60)

## Using the power seat memory function\*

The memory function can be used to store the settings (positions) of the power front seats\*, door mirrors and the head-up display\*.

Three different settings can be stored using this function. Memory controls are found on one or both of the front doors\*.

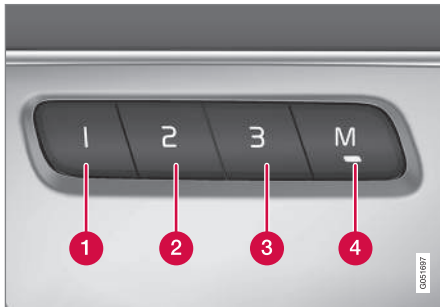

- ❶ Button for storing a position
- ❷ Button for storing a position
- ❸ Button for storing a position
- ❹ **M** (memory) button

### Storing a position

1. Adjust the seat, door mirrors and head-up display to the desired positions.

2. Press and release the **M** button. The indicator light in the button will illuminate.
3. Press button **1, 2 or 3 within 3 seconds** to store the current position of the seat/ mirrors/head-up display in the selected button.
  - > When the position has been stored in the selected button, an audible signal will sound and the indicator light in the **M** button will go out.

If none of the buttons (1, 2 or 3) are pressed within 3 seconds, the indicator light in the **M** button will go out and the position will **not** be stored.

The seat/mirrors/head-up display must be moved before new settings can be stored.

### Using a stored position

A stored position can be used when one of the front doors is opened or closed:

#### Front door open

- Press one of the buttons (**1–3**) briefly. The seat, door mirrors and head-up display will move to the positions stored in that button.

#### Front door closed

- Press and hold one of the buttons (**1–3**) until the seat, door mirrors and head-up display have moved to the positions stored in that button.

The seat, door mirrors and head-up display will stop automatically if the button is released before they have reached the stored positions.

### **WARNING**

- Because the driver's seat can be adjusted with the ignition off, children should never be left unattended in the vehicle.
- Movement of the seat can be STOPPED at any time by pressing any button on the power seat control panel.
- Do not adjust the seat while driving. The seat should be adjusted so that the brake pedal can be depressed fully. In addition, position the seat as far rearward as comfort and control allow.
- The seat rails on the floor must not be obstructed in any way when the seat is in motion.

### Related information

- Adjusting power front seats\* (p. 163)
- Power front seats\* (p. 163)

## Multifunction front seats\*

In addition to the adjustment settings offered by the power seat controls, the multifunction control provides additional possibilities for convenience and comfort.



Multifunction control on the side of the seat

The multifunction control can be used to adjust lumbar support\*, the backrest's side bolsters\*, the length of the seat cushion and the massage function\*. The adjustment settings made with the control are shown in the center display\* and certain settings can be made directly from the center display.

### Center display

The adjustment settings for the driver and passenger seats made using the multifunction control are shown in the center display. If only one seat is adjusted, the settings are shown in the

center of the display. If both seats are adjusted, the settings for the driver seat are shown on the upper half of the screen and the ones made for the passenger seat are on the lower half.

Press the Home button on the center console to exit the seat adjustment setting view.

### Related information

- Power front seats\* (p. 163)
- Adjusting function settings in the multifunctional front seats\* (p. 166)
- Turning seat heating\* on and off (p. 198)

## Adjusting function settings in the multifunction front seats\*

The multifunction controls on the side of the seat as well as the center display can be used to make seat adjustments. The adjustment settings are shown in the center display\*.



Multifunction control on the side of the seat

Turn the control up or down to activate.

### Front seat massage settings\*

The front seat backrests have a massage function. Air-filled cushions provide the massaging action and a number of settings are available.

The massage function can only be used when the engine is running.

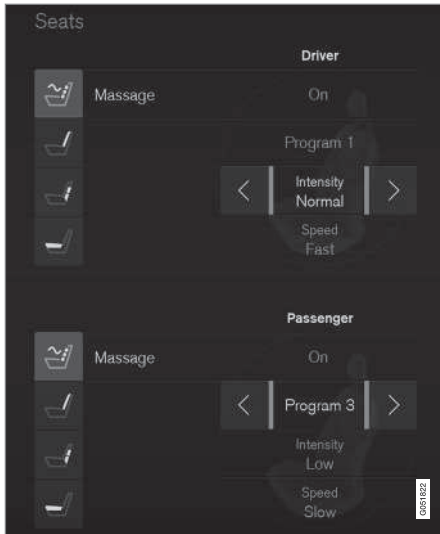

Message view in the center display

1. Activate the multifunction control by turning it up or down. Seat settings will be displayed in the center display.
2. Tap **Message** in the seat settings view.

3. Select message settings by tapping the center display or by moving the cursor up/down using the multifunction control's upper/lower buttons. Change a setting in the selected function by tapping the arrows on the center display or by using the multifunction control's front/rear buttons.

### Message settings

The following message settings are available:

- **On/Off.**
- **Program 1-5:** There are 5 preset message programs. Select **Swell**, **Tread**, **Advanced**, **Lumbar** or **Shoulder**.
- **Intensity:** Select **Low**, **Normal** or **High**.
- **Speed:** Select **Slow**, **Normal** or **Fast**.

### Restarting the message function

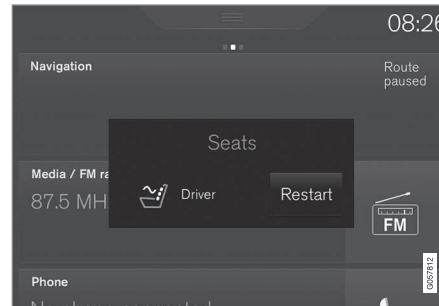

Message restart button in the center display

The message function switches off automatically after 20 minutes and must be restarted manually for continued use.

Tap **Restart** in the center display to restart the selected message program.

### Adjusting the side bolsters in the front seats\*

The side bolsters in the front seat backrests can be inflated/deflated to adjust the amount of support provided.





Side bolster view in the center display

1. Activate the multifunction control on the side of the seat by moving it up/down. The seat settings view will appear in the center display.
2. Select **Side bolsters** in the seat settings view.
  - Tap the front button to increase bolster support.
  - Tap the rear button to decrease bolster support.

### Adjusting front seat lumbar support\*

Lumbar support can be adjusted up/down/front/rear.

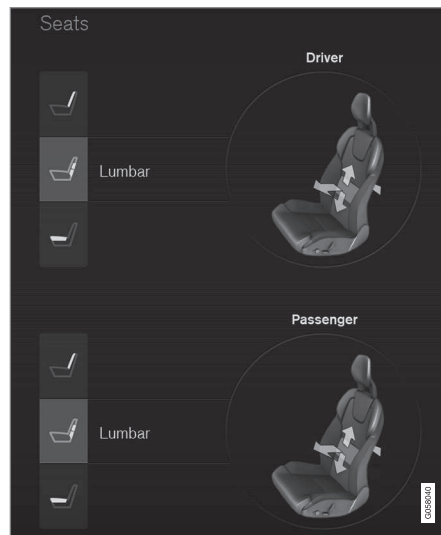

Lumbar support view in the center display

1. Activate the multifunction control on the side of the seat by moving it up/down. The seat settings view will appear in the center display.

2. Select **Lumbar** in the seat settings view.

- Tap the button up/down to move lumbar support up/down.
- Tap the front button to make lumbar support firmer.
- Tap the rear button to make lumbar support softer.

### Extending the seat cushion

The seat cushion can be extended/retracted using the multifunction control.

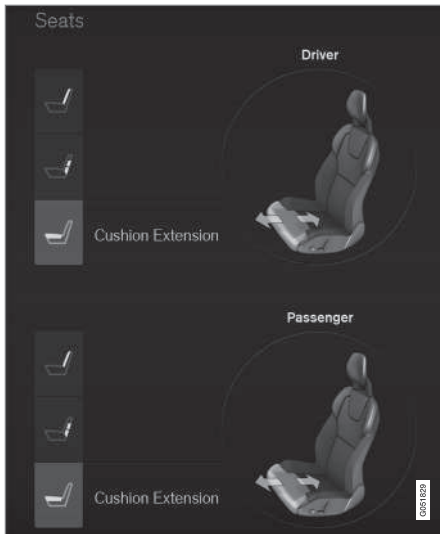

Seat cushion extension view in the center display

### Related information

- Multifunctional front seats\* (p. 166)

### Rear seats

Your vehicle has two or three\* rows of seats. The second row of seats has three individual seating positions and the optional third row of seats has two individual seating positions.

### Related information

- Adjusting the second row backrest tilt (p. 172)
- Adjusting the second row head restraints (p. 170)
- Folding the second row backrests (p. 173)
- Folding the third row\* backrests (p. 175)
- Getting into and out of the third row of seats (p. 174)
- Moving the second row seats forward/rearward (p. 171)
- Turning seat heating\* on and off (p. 198)

1. Activate the multifunction control on the side of the seat by moving it up/down. The seat settings view will appear in the center display.
2. Select **Cushion extension** in the seat settings view.
  - Tap the front button to extend the cushion.
  - Tap the rear button to retract the cushion.

## Adjusting the second row head restraints

The center head restraint in the second row of seats can be adjusted to suit the height of the seat's occupant. The outboard head restraints can be folded down\* for a better rear view.

### Adjusting the center head restraint

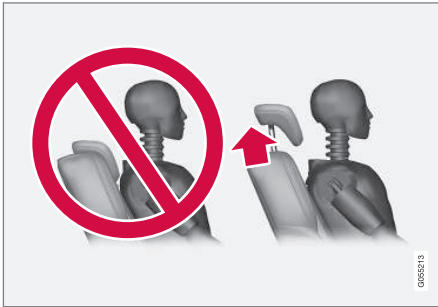

The center head restraint should be adjusted up or down according to the passenger's height. The restraint should be carefully adjusted to support the occupant's head.

The center rear seat head restraint should only be in its lowest position when this seat is NOT occupied. When the center seat is occupied, the head restraint must be correctly adjusted to the passenger's height so that, if possible, the whole of the back of the head is covered.

**⚠ WARNING**

The center rear seat head restraint should only be in its lowest position when this seat is NOT occupied. When the center seat is occupied, the head restraint must be correctly adjusted to the passenger's height so that, if possible, the entire back of the head is covered.

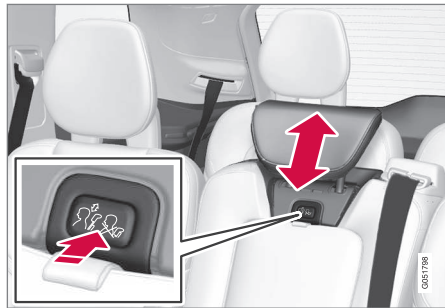

Center head restraint button

To lower the head restraint, press and hold the button (see the illustration) and push the head restraint down carefully.

## Electrically folding down the rear seat's outboard head restraints\*



The outboard head restraints can be folded down in two ways from the center display.

### From Function view



1. Go to the center display's Function view.
2. Tap the **Headrest fold** button.



**Via settings**

The ignition has to be in at least mode II.

1. In the center display's Top view, tap **Settings**.
2. Tap **My Car** → **Seats**
3. Select **Fold Headrest On Second Row Seats** to fold down the outboard head restraints.

The head restraints must be returned to the upright position manually until they click into position.

**⚠ WARNING**

For safety reasons, the outboard head restraints in the rear seats must be in the upright (fixed) position if these seating positions are occupied or if the third row seats\* are occupied.

The head restraint must be locked in the upright position after it has been folded up.

**Related information**

- Folding the second row backrests (p. 173)
- Center display overview (p. 28)

**Moving the second row seats forward/rearward**

In 7-seat models\*, the second row seats can be moved forward/rearward individually to help optimize legroom for the passengers.

The second row seats cannot be moved in 5-seat models.



1. Lift the handle located under the seat.
2. Move the seat forward/rearward to the desired position.
3. Release the handle and move the seat so that it locks in the new position.

**⚠ WARNING**

Be careful when moving the seat to avoid injuries to your hands/fingers.

Check that the seat is securely locked in position after being moved.

**Related information**

- Rear seats (p. 169)
- Getting into and out of the third row of seats (p. 174)

## Adjusting the second row backrest tilt

Backrest tilt can be adjusted separately for each of the second row seats.

### Center seat



1. Pull the strap on the center seat's right side.
2. Adjust backrest tilt forward/rearward by decreasing/increasing pressure on it.
3. Release the strap to lock the backrest in the new position and press the backrest until its lock engages.

### Outboard seats



1. Pull the handle on the side of the seat upward.
2. Adjust backrest tilt forward/rearward by decreasing/increasing pressure on it.
3. Release the handle to lock the backrest in the new position and press the backrest until its lock engages.

### **WARNING**

Check that all backrests are securely locked in place after changing the tilt angle.

### Related information

- Rear seats (p. 169)
- Moving the second row seats forward/rearward (p. 171)
- Folding the second row backrests (p. 173)

- Seat belts (p. 60)

## Folding the second row backrests

The second row of seats has three individual seating positions whose backrests can be folded down separately.

### CAUTION

- To help avoid damage to the seat upholstery, before a rear seat backrest is folded down, remove any objects from the seat and ensure that the seat belts are not buckled.
- The integrated booster cushion\* in the center position must be stowed (folded down) before the backrest is folded down.
- The center seating position armrest must be folded up before the backrest is folded down.

### NOTE

- It may be necessary to adjust the front seat backrests and/or move these seats forward in order to fold down the rear seat backrests completely.
- It may also be necessary to move the second row of seats rearward.

### WARNING

Adjust the seat and be sure it is locked in the new position before driving.

#### Center seat



To fold down the backrest:

1. Fold down the head restraint manually.
2. Pull the strap on the center seat's right side.
3. Fold the backrest down until it locks in position. The seat cushion will move downward/forward as the backrest is folded down to create a flat surface.

To return the backrest to the upright position:

1. Pull the strap.
2. Fold the backrest and release the strap. Push it into position until its lock engages.

3. Adjust the head restraint if necessary.

#### Outboard seats



To fold down the backrest:

1. Pull up and hold the handle on the side of the seat while the backrest is being folded down.
2. Be sure that the backrest and head restraint do not come in contact with the front seats while they are being folded down. Fold down until the backrest locks in place.
  - > The seat cushion will move downward/forward as the backrest is folded down to create a flat surface. The head restraint folds down automatically when the backrest is folded down.





### **⚠ WARNING**

After being folded down, be sure the backrests are securely locked in place.

To return the backrest to the upright position:

1. Pull up and hold the handle on the side of the seat while the backrest is being folded up.
2. Be sure that the backrest and head restraint do not come in contact with the front seats while they are being folded up. Fold up the backrest and release the handle.
3. Press the backrest until its lock engages.
4. Fold up the head restraint manually.

### **⚠ WARNING**

Be sure the backrest and head restraint are securely locked in position after they have been folded up.

#### **Related information**

- Rear seats (p. 169)
- Adjusting the second row backrest tilt (p. 172)
- Folding the third row\* backrests (p. 175)
- Adjusting the second row head restraints (p. 170)

### **Getting into and out of the third row of seats**

The second row seats can be moved for easier access to the third row of seats\*.

#### **Getting into and out of a third row seat**



To fold down the backrest:

1. Pull the handle on the upper side of one of the outboard second row seats upward/forward.
2. Fold the backrest forward and move the entire seat forward.

To return the backrest to the upright position:

- Move the seat back and fold up the backrest until it locks in position.

### **⚠ WARNING**

Be sure the backrest and head restraint are securely locked in position after they have been folded up.

#### **Related information**

- Moving the second row seats forward/rearward (p. 171)
- Adjusting the second row backrest tilt (p. 172)
- Folding the second row backrests (p. 173)

## Folding the third row\* backrests

The third row of seats has two individual seating positions that can be folded down manually or electrically\*.

### **i** NOTE

Before folding down the third row seats, it may be necessary to change the position/tilt of the seats in the second row.



1. Pull the handle on the upper side of the backrest upward/forward.

2. Be sure that the backrest and head restraint do not come in contact with the seat ahead while they are being folded down. Fold the backrest down.
  - > The seat cushion will move downward/forward as the backrest is folded down to create a flat surface. The head restraint folds down automatically when the backrest is folded down.

To return the backrest to the upright position, fold the backrest up until it locks in position. The head restraint has to be folded up manually.

### **⚠** WARNING

Be sure the backrest and head restraint are securely locked in position after they have been folded up.

### Related information

- Rear seats (p. 169)
- Adjusting the second row head restraints (p. 170)
- Adjusting the second row backrest tilt (p. 172)
- Moving the second row seats forward/rearward (p. 171)

## Driver profiles

Many of the vehicle's settings can be adapted to the driver's personal preferences and saved in one or more driver profiles.

The personal settings made are automatically saved in the active driver profile. Each remote key is linked to a driver profile and when this key is used, the vehicle's settings are adapted according to the specific ones saved in that profile.

### Which settings are saved in driver profiles?

The settings that can be changed in the vehicle are either **personal** or **global**.

Changes made to personal settings are saved automatically in the active (current) driver profile, assuming that this profile is not locked. See the article "Editing a driver profile" for additional information.

Changes to global settings are not saved in a specific driver profile but instead affect all driver profiles.



### ◀ **Global settings**

Global settings and parameters remain the same regardless of which driver profile is currently active.

Keyboard layout is an example of a global setting. If driver profile X is used to add additional keyboard languages, these languages will also be available even if driver profile Y is used. This type of global change is not specific to a single driver profile.

### **Personal settings**

If driver profile X has been used to e.g., set the brightness for the center display, driver profile Y will not be affected by this setting since it is specific (personal) to driver profile X.

See also the article "Categories in Settings view" for an overview of global and personal settings.

### **Related information**

- Editing a driver profile (p. 177)
- Categories in Settings view (p. 110)

### **Selecting a driver profile**

The most recently selected driver profile will be used automatically the next time the vehicle is started. However, a different driver profile can be selected after the vehicle has started.

When the vehicle is started, the most recently selected driver profile will be shown at the top of the center display. There are two alternatives for changing to another driver profile.

Alternative 1:

1. Tap the name of the drive profile shown at the top of the center display when the vehicle has been started.
  - > A list of driver profiles that can be selected will be displayed.
2. Select the desired profile.
3. Tap **Confirm**.
  - > The new driver profile has now been selected and the system will load the settings stored in that profile.

Alternative 2:

1. Pull down the center display's Top view.
2. Tap **Profile**.
  - > A list of driver profiles that can be selected will be displayed.
3. Select the desired profile.

4. Tap **Confirm**.

- > The new driver profile has now been selected and the system will load the settings stored in that profile.

### **Related information**

- Driver profiles (p. 175)
- Editing a driver profile (p. 177)
- Linking a remote key to a driver profile (p. 177)

## Editing a driver profile

The names of the driver profiles created for the vehicle can be changed.

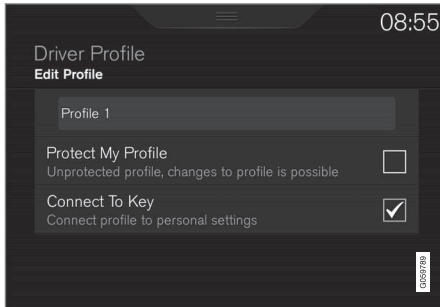

All types of changes in driver profiles are made from the center display's Top view: **Settings → System → Driver Profiles**.

## Changing a profile's name

Changing a driver profile's name is done from the **Driver Profile** window:

1. Tap **Edit Profile**.
  - > A menu will open in which the profile can be edited.
2. Tap the **Profile Name** box.
  - > A keyboard will be displayed and can be used to change the name. Tap  to close the keyboard.

3. Save the changes by tapping **Back/Close**.
  - > The name has now been changed.

## Resetting driver profile changes

Settings that have been changed and saved in one or more driver profiles can be reset.

 <b>NOTE</b>
<b>Factory Reset</b> is only possible when the vehicle is stationary.

1. Tap **Settings** in the center display's Top view.
2. Select **System → Factory Reset → Reset Personal Settings**.
3. Select one of the following: **Reset for the active profile**, **Reset for all profiles** or **Cancel**.

## Related information

- Driver profiles (p. 175)
- Resetting the settings view (p. 113)
- Using the center display keyboard (p. 31)
- Using the center display (p. 44)
- Selecting a driver profile (p. 176)

## Linking a remote key to a driver profile

A remote key can be linked to a driver profile, which means that all of the settings stored in the driver profile will apply each time that particular remote key is used with the vehicle.

A remote key is not initially linked to a specific driver profile. When the key is used to unlock the vehicle/start the engine for the first time, the **Guest** profile will be used.

A driver profile can be selected manually each time the vehicle is unlocked/started without a remote key being linked to that profile. When the vehicle is started, the most recently selected driver profile will be activated. If the key has previously been linked to a driver profile, it is not necessary to manually select a profile when that particular key is used.

## Linking a remote key to a driver profile for the first time

Select a profile to link to the remote key (if that profile is not already active).

1. Pull down the center display's Top view and tap **Settings**.
2. Tap **System → Driver Profiles**.
3. Tap the profile to be linked to the remote key. The **Guest** profile cannot be linked to a remote key.



4. Open Top view in the center display and tap **Settings** → **System** → **Driver Profiles** → **Edit Profile**.
5. Select **Connect key** to link the selected profile to the remote key currently being used. A profile can only be linked to the remote key that is currently being used. If there are several keys in the vehicle at the same time, **More than one key is found, put the key you want to connect on backup reader** will be displayed.



Location of the backup reader in the tunnel console

- > When **Profile connected to key** is displayed, the remote key and the selected driver profile have been linked.
6. Tap **OK** to confirm.
    - > The key currently in use will remain linked to the selected driver profile as long as the **Connect key** box is not deselected.

### Related information

- Driver profiles (p. 175)
- Editing a driver profile (p. 177)
- Remote key (p. 227)

### Importing/exporting a driver profile from/to a USB flash drive

The personal settings stored in a driver profile can be imported or exported to another vehicle using a USB flash drive.

The following steps describe the procedure for importing or exporting personal settings saved in a driver profile to a USB flash drive:

1. Tap **Settings** in the center display's Top view.
2. Tap **System** → **Driver Profiles**.
3. Insert a flash drive in the USB socket in the tunnel console.



USB socket in the tunnel console



4. Select **Import profile from USB/Export profile to USB**.

**i NOTE**

- The **Guest** profile cannot be imported or exported
- Several profiles can be exported to USB but only **one** profile can be imported. When a profile is imported, it overwrites the one currently being used in the vehicle.

5. Select the profile(s) to be imported/exported.
6. Select **OK**.

If an export does not succeed, this may be due to:

- USB flash drive is full.
- USB flash drive was not inserted correctly or was removed before the export was completed.

If an import does not succeed, this may be due to:

- USB flash drive was not inserted correctly or was removed before the import was completed.
- No driver profile had been stored on the USB flash drive.
- The driver profile file on the USB flash drive is damaged.

**Related information**

- Driver profiles (p. 175)



CLIMATE

## Climate control system

The vehicle is equipped with Electronic Climate Control (ECC) that cools, heats, dehumidifies and filters the air in the passenger compartment.

### 2-zone climate system

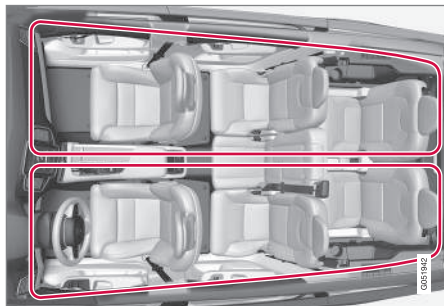

2-zone system climate zones

The 2-zone climate system makes it possible to set the left- and right-side temperatures separately.

All climate system settings are made from the center display and the buttons in the center console.

### 4-zone climate system\*

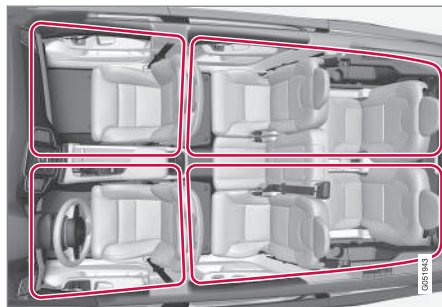

4-zone system climate zones

The 4-zone climate system makes it possible to set the left- and right-side temperatures separately for the front and rear seats.

All climate system settings are made from the center display and the buttons in the center console. Settings for the rear seats can also be made from the climate system panel on the rear side of the tunnel console.

### Related information

- Climate system sensors (p. 183)
- Perceived temperature (p. 182)
- Climate system controls (p. 186)
- Air quality (p. 183)
- Air distribution (p. 201)
- Air conditioning refrigerant (p. 540)

## Perceived temperature

The climate system regulates passenger compartment temperature based on the perceived temperature, not on the actual one.

The selected passenger compartment temperature is based on a physical perception relating to the current ambient temperature, air flow, humidity, sunlight in the passenger compartment, etc.

The system's sunlight sensor monitors the side of the car where sunlight is entering the passenger compartment. This means that the actual temperature may differ between the right and left sides of the compartment, even if the temperature setting is the same for both sides.

### Related information

- Climate system sensors (p. 183)
- Climate control system (p. 182)

## Climate system sensors

The climate system's sensors help regulate the passenger compartment temperature, humidity level, etc.

### Location of the sensors

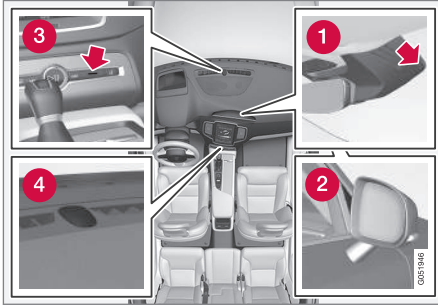

- 1 Humidity sensor: in the rearview mirror console.
- 2 Ambient temperature sensor: in the passenger's side door mirror.
- 3 Passenger compartment temperature sensor: near the center console buttons.
- 4 Sunlight sensor: on the upper side of the dashboard.

#### **i** NOTE

Do not cover or block the sensors with clothing or other objects.

On models equipped with the optional Interior Air Quality System, there is also an air quality sensor located at the climate system's air intake.

### Related information

- Climate control system (p. 182)
- Perceived temperature (p. 182)
- Interior Air Quality System (IAQS)\* (p. 185)

## Air quality

The materials used in the passenger compartment have been selected and designed to be pleasant and comfortable, even for people with asthma or other types of allergies.

### Materials in the passenger compartment

The materials used have been developed to help minimize the amount of dust and make the cabin easier to keep clean.

All floor mats (including the cargo compartment) can be easily removed for cleaning.

Only use cleaning agents and car care products recommended by Volvo. Clean regularly and follow the instructions included with the product.

### Air filtering systems

In addition to the passenger compartment filter, the Clean Zone Interior Package\* and the Interior Air Quality System\* contribute to a cleaner passenger compartment environment.

### Clean Zone\*

The Clean Zone function monitors the conditions that affect good passenger compartment air quality.



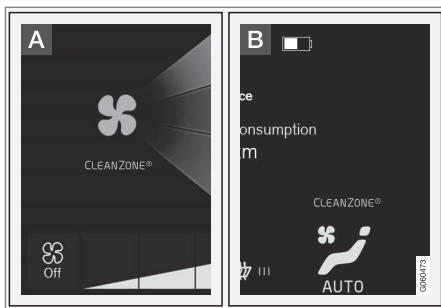

**A** The indicator is shown in center display's Climate view.

**B** The indicator is shown in the climate bar when the Climate view is not open.

If the air quality conditions are **not** met, the text **Clean Zone** will be white. When the conditions **are** met, the text will change to blue.

The conditions monitored are:

- All side windows, doors, tailgate and panoramic roof\* are closed
- The Interior Air Quality System\* is activated
- The air conditioning is activated
- Recirculation is deactivated

**i NOTE**

Please be aware that the Clean Zone function does not indicate that the air quality in the passenger is good, only that the conditions for good air quality have been met.

### Related information

- Passenger compartment air filter (p. 185)
- Interior Air Quality System (IAQS)\* (p. 185)
- Clean Zone Interior Package (CZIP)\* (p. 184)
- Cleaning the interior (p. 525)
- Climate system controls in the center display (p. 187)

## Clean Zone Interior Package (CZIP)\*

The Clean Zone Interior Package includes a number of features that help further reduce allergenic substances in the passenger compartment.

CZIP includes the following:

- An enhanced blower function that starts the blower when the vehicle is unlocked with the remote key to fill the passenger compartment with fresh air. This function starts automatically when required and shuts off automatically after a short period or if one the doors is opened. The time for which the blower operates decreases gradually due to reduced need until the vehicle is four years old.
- The Interior Air Quality System (IAQS).

### Related information

- Air quality (p. 183)
- Interior Air Quality System (IAQS)\* (p. 185)

### Interior Air Quality System (IAQS)\*

The Interior Air Quality System uses a multifilter and an air quality sensor to remove gases, particles and other contaminants from the air entering the passenger compartment.

The IAQS air quality sensor monitors increased levels of contaminants in the outside air and if contaminants are detected, the air intake closes and the air inside the passenger compartment is recirculated, i.e., no outside air enters the vehicle. The filter also cleans recirculated passenger compartment air.

**i NOTE**

- The air quality sensor should always be engaged in order to obtain the best air in the passenger compartment.
- Recirculation is limited in cold weather to avoid fogging.
- If the insides of the windows start fogging, disengage the air quality sensor. Use the defroster function to increase airflow to the front, side, and rear windows.

### Activating/deactivating IAQS

To change the setting for IAQS activation/deactivation:

1. In the center display's Settings view, go to **Climate**.

2. Activate/deactivate IAQS by selecting/deselecting the **Air Quality Sensor** box.

### Related information

- Air quality (p. 183)
- Passenger compartment air filter (p. 185)
- Clean Zone Interior Package (CZIP)\* (p. 184)
- Turning recirculation on and off (p. 194)

### Passenger compartment air filter

All air entering the passenger compartment through the climate system air intake is filtered.

### Filter replacement

The filter must be replaced according to the service schedule for your vehicle. When driving in e.g., dusty or industrial areas, the filter may need to be replaced more often. Consult your Volvo retailer.

### Related information

- Air quality (p. 183)
- Clean Zone Interior Package (CZIP)\* (p. 184)
- Interior Air Quality System (IAQS)\* (p. 185)
- Volvo's service program (p. 480)

## Automatic climate control

The Auto feature automatically controls a number of climate system functions.

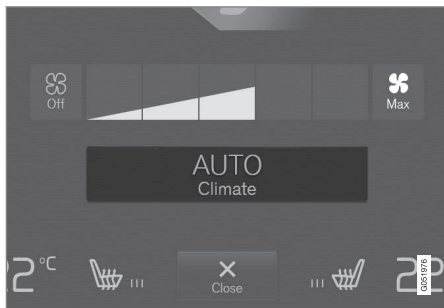

The Auto climate button in Climate view

1. Go to the center display's Climate view.

2. Tap or press and hold **AUTO**.
  - > Auto mode is activated (button lights up)/deactivated (button is off). Auto mode automatically controls air recirculation, air conditioning, and air distribution.

Blower speed and temperature change depending on how long the button is pressed.

- Tap: return to previous settings.
- Press and hold: change to default settings (level **3** and 72 °F (22 °C)/(level **2** in the rear seats<sup>1</sup>).

### Related information

- Climate system controls in the center display (p. 187)

## Climate system controls

Climate system functions are controlled using buttons on the center console, the center display and the climate system panel on the rear side of the tunnel console\*.

### Overview of climate system controls

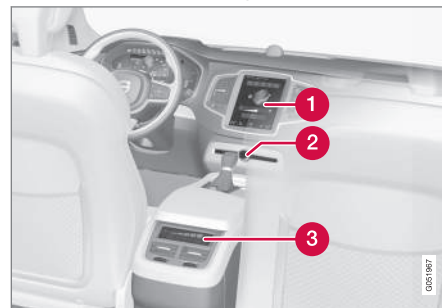

- 1 Climate system controls in the center display
- 2 Defroster buttons on the center console
- 3 Climate system panel on the rear side of the tunnel console\*

### Related information

- Climate system controls in the center display (p. 187)
- Climate control system (p. 182)

<sup>1</sup> Models with the 4-zone climate system\*



- Rear climate system controls on the tunnel console\* (p. 189)
- Defrosting windows and mirrors (p. 194)
- Climate system voice commands (p. 122)
- Air quality (p. 183)

## Climate system controls in the center display

All climate system functions can be controlled from the center display's climate bar and Climate view.

### Climate bar

The most common climate system functions can be controlled from the climate bar.



- 1 Temperature control for the driver and passenger sides.
- 2 Control for heated\* and ventilated\* driver/passenger seats and heated steering wheel\*.
- 3 Button for opening Climate view. The graphic in the button shows the activated climate system settings.

### Climate view

Tap the center button on the climate bar to access Climate view, which is divided into the following tabs: **Main climate**, **Rear climate\*** and **Parking climate\***. Toggle between the tabs by swiping the screen to the left/right or by tapping the respective headings.



### ◀ Main climate settings

In addition to the climate bar's functions, other primary climate system functions can also be controlled from the **Main climate** tab.

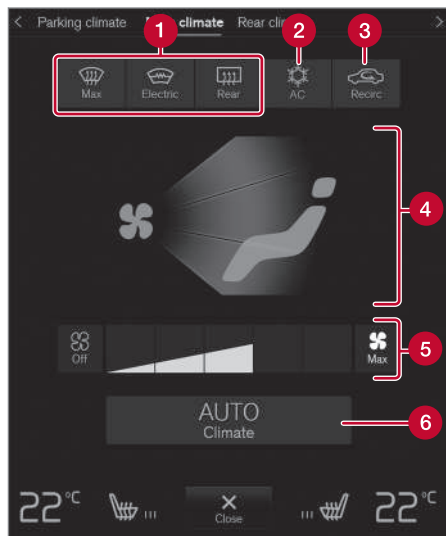

- 1 **Max, Electric, Rear:** controls for defrosting windows and door mirrors.
- 2 **AC:** air conditioning controls.
- 3 **Recirc:** recirculation controls.

- 4 Air distribution controls.
- 5 Blower control for the front seats (also for the rear seat on models with a 2-zone climate system).
- 6 **AUTO:** climate system Auto mode.

### Rear climate\*

All of the climate system functions for the rear seat can be controlled from the **Rear climate** tab.

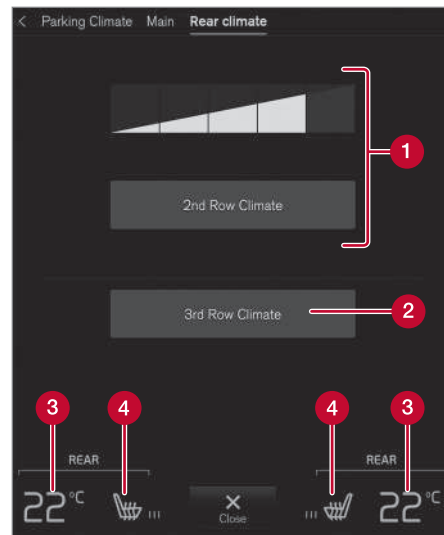

- 1 **2nd row climate:** Blower control and climate system functions for the second row of seats.
- 2 **3rd row climate:** Blower control and climate system functions for the third row of seats\*.
- 3 Rear seat temperature control.
- 4 Rear seat heating control\*.

## Parking climate<sup>2</sup>

All of the parking climate functions can be controlled from the **Parking climate** tab.

### Related information

- Climate system controls (p. 186)
- Defrosting windows and mirrors (p. 194)
- Air conditioning (p. 197)
- Adjusting air distribution (p. 202)
- Setting the temperature (p. 191)
- Setting the blower speed (p. 190)
- Automatic climate control (p. 186)
- Turning steering wheel heating\* on and off (p. 197)
- Turning seat heating\* on and off (p. 198)

## Rear climate system controls on the tunnel console\*

The rear seat climate system functions are controlled from the rear side of the tunnel console.

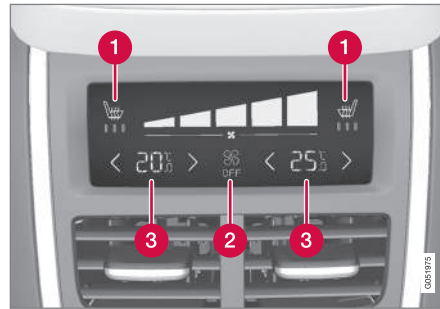

- 1 Rear seat heating\*
- 2 Rear seat blower speed
- 3 Rear seat temperature control

If the vehicle is not equipped with a climate panel on the rear side of the tunnel console but also has heated rear seats\*, there will be buttons on the panel for this function.

### Related information

- Climate system controls (p. 186)
- Turning seat heating\* on and off (p. 198)

<sup>2</sup> Plug-in hybrid models only.

- Setting the blower speed (p. 190)
- Setting the temperature (p. 191)

## Setting the blower speed

The blower can be set to five different automatic speeds plus **Off** and **Max**. In models with the 4-zone climate system\*, blower speed can be set separately for the front and rear seats.

### Setting blower speed for the front seats<sup>3</sup>

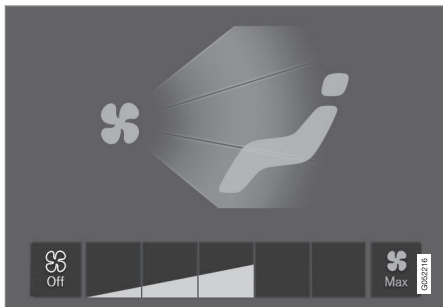

Blower control buttons in Climate view

1. Go to the center display's Climate view.
2. Tap the desired blower speed: **Off**, **1-5** or **Max**.
  - > The blower speed will change and the button for the selected speed will light up.

### **i** NOTE

If the blower is turned off completely, the air conditioning is disengaged, which may result in fogging on the windows.

## Setting the rear seat blower speed\*

### From the front seat

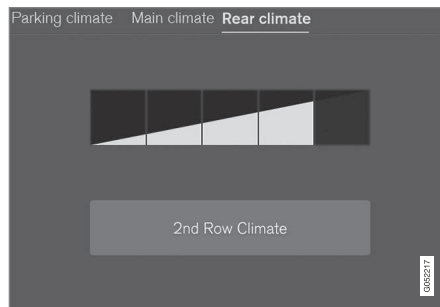

Blower control buttons in the **Rear climate** tab in Climate view

1. Open the center display's Climate view.
2. Select the **Rear climate** tab.

3. Tap the desired blower speed: **1-5**.

The blower can be turned off for the second and third row of seats\* by tapping **2nd row climate**.

The blower speed for the third row of seats\* will be the same as for the second row seats but can be turned off separately by tapping **3rd row climate**.

- > The blower speed will change and the button for the selected speed will light up.

<sup>3</sup> The same setting applies to the rear seats in models with the 2-zone climate system.

**From the rear seat**

Blower controls on the climate panel on the rear side of the tunnel console

- Tap the desired blower level: **Off** or **1-5** on the tunnel console climate panel.
  - > The blower speed will change and the button for the selected speed will light up.

**i NOTE**

- Blower speed for the rear seat cannot be set if the front seat blower setting is **Off**.
- The climate system will adapt air flow within each set blower speed, which means that the blower speed may vary slightly.

**Related information**

- Climate system controls in the center display (p. 187)
- Rear climate system controls on the tunnel console\* (p. 189)

**Setting the temperature<sup>4</sup>**

The temperature can be set separately for the left and right sides of the passenger compartment. In models with the 4-zone climate system\*, it can also be set for the front and rear seats separately.

**Setting the temperature for the front seats<sup>5</sup>**

Temperature buttons in the climate bar

1. Tap the right or left side temperature button in the center display's climate bar to open the control.

<sup>4</sup> Shown here in Celsius but also applies to Fahrenheit

<sup>5</sup> The same setting applies to the rear seats in models with the 2-zone climate system.





Temperature control

## 2. Set a temperature by:

- dragging the control to the desired temperature or
  - tapping +/- to raise/lower the temperature.
- > The temperature will change and the new temperature will be shown in the button.

## Synchronizing the temperature

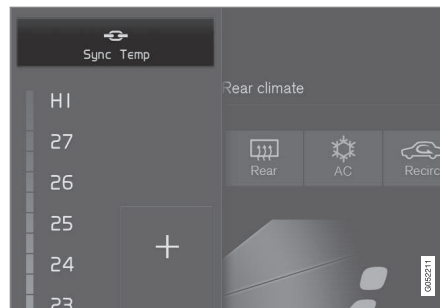

Synchronization button on the driver's side temperature control

1. Tap the driver's side temperature button to open the control.
2. Tap **Synchronize temperature** .
  - > The temperature for all of the vehicle's climate zones will be synchronized with the one set for the driver's side and the synchronization symbol will be displayed in the temperature button.

Synchronization can be stopped by tapping **Synchronize temperature** again or by changing the temperature for the passenger's side or the rear seat\*.

## Setting the rear seat temperature\*

### From the front seat

Temperature buttons in the **Rear climate** group in Climate view

1. Open the center display's Climate view.
2. Select the **Rear climate** tab.
3. Tap the left or right side temperature buttons to open the control.

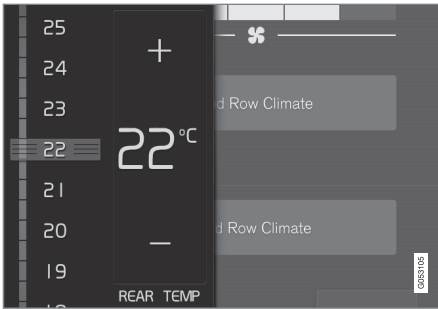

Temperature control

#### 4. Set the temperature by:

- dragging the control to the desired temperature or
  - tapping +/- to raise/lower the temperature.
- > The temperature will change and the new temperature will be shown in the button.

#### From the rear seat



Temperature controls on the climate panel on the rear side of the tunnel console

- Tap the left or right side's </> buttons on climate panel to lower/raise the temperature.
  - > The temperature will change and the climate panel screen will show the new temperature.

#### **i** NOTE

Heating or cooling cannot be speeded up by selecting a higher/lower temperature than the actual temperature required.

#### Related information

- Climate system controls (p. 186)
- Climate system controls in the center display (p. 187)

- Rear climate system controls on the tunnel console\* (p. 189)
- Perceived temperature (p. 182)

## Turning recirculation on and off

Recirculation can be used to shut out exhaust fumes, smoke, etc., from the passenger compartment.



Recirculation button in Climate view

1. Open Climate view in the center display.
2. Press **Recirc**.
  - > Recirculation is activated (button lights up)/deactivated (button is off)

### **i** NOTE

- If recirculation is on for too long, there is a risk of condensation forming on the insides of the windows, especially in winter.
- Recirculation cannot be deactivated if max. defroster is being used.

## Activating/deactivating the recirculation timer

With the timer activated, recirculation will switch off automatically after 20 minutes.

1. Tap **Settings** in the center display's Top view.
2. Tap **Climate**.
3. Activate/deactivate the timer by selecting/deselecting the box for **Recirculation Timer**.

## Related information

- Climate system controls in the center display (p. 187)

## Defrosting windows and mirrors

The max. defroster, heated windshield\* and heated rear window/door mirror functions are used to remove ice or condensation.

### Using the buttons in the center console

The buttons in the center console offer quick access to the defroster functions.

On models with the optional heated windshield, the max. defroster function can only be activated separately from the Climate view in the center display.

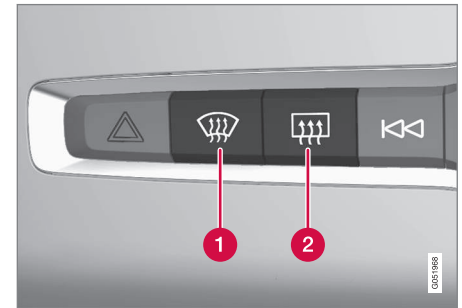

Center console buttons

- 1 Button for the heated windshield\* and max. defroster.
- 2 Button for the heated rear window and door mirrors.



Models **without** a heated windshield.

- Press button (1).
  - > Max. defroster is activated (button indicator light on)/deactivated (button indicator light off).

Models **with** a heated windshield\*.

- Press button (1) repeatedly to access the function's three levels:
  - Activate windshield heating
  - Activate windshield heating and max. defroster
  - Deactivated
- > The windshield heating is activated (button indicator light on)/deactivated (button indicator light off).

### **i** NOTE

Max. defroster starts after a slight delay to avoid a brief increase in blower speed if the heated windshield function has been deactivated by pressing the button twice in quick succession.

Heated rear window and door mirrors

- Press button (2).
  - > Heating for the rear window/door mirrors is activated (button indicator light on)/deactivated (button indicator light off).

## From the center display's Climate view

### Activate/deactivate max. defroster

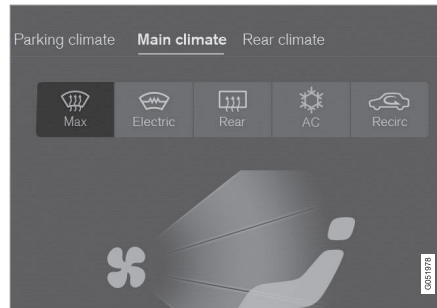

Max. defroster button in Climate view

1. Open Climate view in the center display.

2. Tap **Max**.

- > Max. defroster is activated (button lights up)/deactivated (button is off).

Max. defroster overrides automatic climate control and recirculation, and activates the air conditioning, changes blower speed to 5<sup>6</sup> and the temperature to HI<sup>6</sup>.

When max. defroster is deactivated, the climate system returns to the previous settings.

<sup>6</sup> In models with the 4-zone climate system\*, front seats only.

## ◀◀ Activating/deactivating windshield heating\*

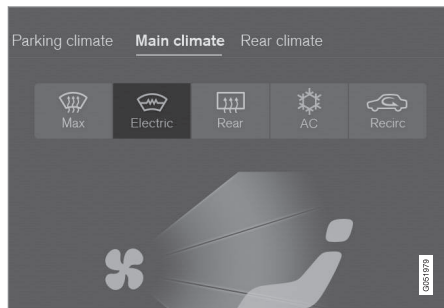

Windshield heating button in Climate view

1. Open Climate view in the center display.
2. Tap **Electric**.
  - > Windshield heating is activated (button lights up)/deactivated (button is off).

If windshield heating is activated while the Start/Stop function has turned off the engine, the engine will restart.

### **i** NOTE

- Triangular areas at the far sides of the windshield are not heated electrically and will take slightly longer to defrost/de-ice.
- The heated windshield may affect the performance/range of e.g., transponders used to automatically pay highway tolls or other communication equipment.

## Activating/deactivating rear window and door mirror heating

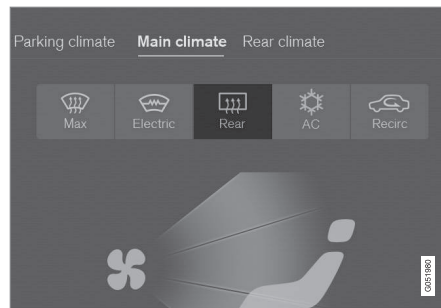

Rear window/door mirror heating button in Climate view

1. Open Climate view in the center display.
2. Tap **Rear**.
  - > Rear window/door mirror heating is activated (button lights up)/deactivated (button is off).

### Automatically activating/deactivating the window heating function when the engine is started

The rear window/door mirror/windshield heating\* can be set to start automatically when the engine is started. The heating function switches off automatically when the glass surfaces are sufficiently warm and the condensation/ice has disappeared.

1. Tap **Settings** in the center display's Top view and select **Climate**.
2. Activate/deactivate the respective defroster functions when the engine is started by selecting/deselecting the boxes for **Auto Front Defroster** and **Auto Rear Defroster**.

The heating function will switch off automatically when the window/mirror is sufficiently warm and the ice/condensation has disappeared.

### Related information

- Climate system controls (p. 186)
- Climate system controls in the center display (p. 187)
- Defrosting windows and mirrors (p. 194)
- Air conditioning (p. 197)
- Turning recirculation on and off (p. 194)
- Adjusting air distribution (p. 202)
- Setting the blower speed (p. 190)
- Automatic climate control (p. 186)
- Turning front seat ventilation\* on and off (p. 200)
- Turning steering wheel heating\* on and off (p. 197)

## Turning steering wheel heating\* on and off

The steering wheel can be heated electrically for added comfort in cold weather.

## Activating/deactivating steering wheel heating



Buttons for heated steering wheel and seats in the climate bar

1. Tap the driver side steering wheel and seat button in the center display's climate bar to open the steering wheel and seat heating controls.

If the vehicle is not equipped with the optional heated or ventilated seats, the button for steering wheel heating will be directly accessible in the climate bar.

2. Tap the steering wheel heating button repeatedly to select one of four levels: **Off**, **High**, **Medium** or **Low**.
  - > The level changes and is displayed in the button.

## Automatic steering wheel heating

The automatic function starts heating the steering wheel automatically when the engine is started if the temperature is sufficiently cold. This feature can be activated/deactivated.

1. Tap **Settings** in the center display's Top view.
2. Tap **Climate**.
3. Under **Auto Steering Wheel Heating Level**, select **Off**, **Low**, **Medium** or **High** to activate/deactivate the automatic function.

## Related information

- Climate system controls (p. 186)
- Climate system controls in the center display (p. 187)
- Steering wheel (p. 160)

## Air conditioning

The air conditioning cools and dehumidifies the air in the passenger compartment.

## Activating/deactivating the main air conditioning unit

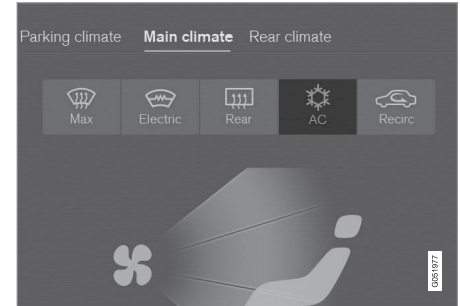

Air conditioning button in Climate view

1. Open Climate view in the center display.
2. Tap **AC**.
  - > The air conditioning is activated (button lights up)/deactivated (button is off).

When the air conditioning is activated, it will be switched on and off automatically by the climate system as necessary.





### NOTE

- For the air conditioning to function optimally, close the side windows and laminated panoramic roof\*
- The air conditioning cannot be activated if the blower is set to **Off**

### Activating/deactivating the air conditioning unit for the third row seats\*

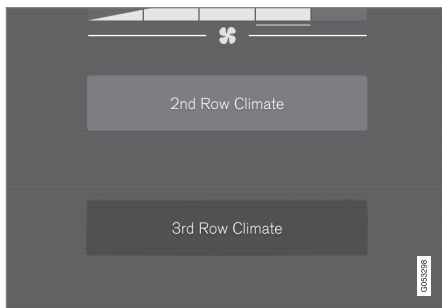

Air conditioning button in the **Rear climate** tab in Climate view

1. Go to Climate view in the center display.
2. Go to **Rear climate**.

3. Tap **3rd row climate**.
  - > The air conditioning is activated (button lights up)/deactivated (button is off).

### NOTE

Air conditioning for the third row of seats\* cannot be activated if the main air conditioning unit or the air conditioning for the second row of seats\* is/are deactivated.

### Activating/deactivating the third row air conditioning when the engine is started

The air conditioning for the optional third row of seats<sup>7</sup> can be set to start automatically when the engine is started.

1. Tap **Settings** in the center display's Top view.
2. Tap **Climate**.
3. Select **Auto Third Row Climate** to activate/deactivate the air conditioning for the third row of seats when the engine is started.

### Related information

- Climate system controls in the center display (p. 187)

### Turning seat heating\* on and off

The seats can be heated for added comfort in cold weather.

### Activating/deactivating front seat heating



Steering wheel and seat buttons in the climate bar

1. Tap the left or right side steering wheel and seat button in the center display's climate bar to open the steering wheel and seat heating controls.

If the vehicle is not equipped with the optional heated steering wheel or ventilated seats, the button for seat heating will be directly accessible in the climate bar.

<sup>7</sup> Models with the optional 4-zone climate system only.

- Tap the seat heating button repeatedly to select one of four levels: **Off**, **High**, **Medium** or **Low**.
  - > The level changes and is displayed in the button.

## Activating/deactivating rear seat heating

### From the front seat\*

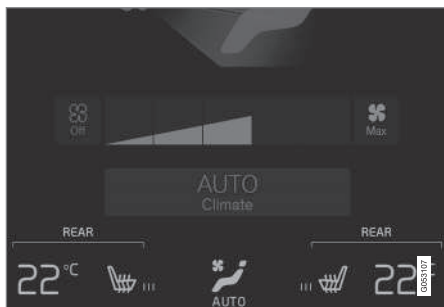

Temperature buttons for **Rear climate** in Climate view

- Open Climate view in the center display and tap **Rear climate**.
- Tap the button repeatedly to select one of the following seat heating levels: **Off**, **Low**, **Medium** or **High**.
  - > The level will change and will be displayed in the button.

### From the rear seat

With the 2-zone climate system

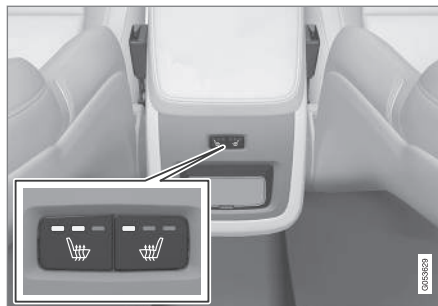

Seat heating buttons on the climate panel on the rear side of the tunnel console

- Press repeatedly on the left or right side buttons on the climate panel on the rear side of the tunnel console to select one of four levels: **Off**, **High**, **Medium** or **Low**.
  - > The level changes and the indicator lights in the button display the level.

With the 4-zone climate system\*



Seat heating indicator and control on the climate panel on the rear side of the tunnel console

- Tap repeatedly on the left or right side seat heating buttons on the climate panel on the rear side of the tunnel console to select one of four levels: **Off**, **High**, **Medium** or **Low**.
  - > The level changes and is displayed on the screen in the climate panel.

## Automatically activating/deactivating the seat heating function when the engine is started

The seat heating\* can be set to start automatically when the engine is started.

The automatic function starts heating the seats when the ambient temperature is sufficiently cold.

- Tap **Settings** in the center display's Top view.



2. Tap **Climate**.
3. Under **Auto Driver Seat Heating Level** and **Auto Passenger Seat Heating Level**, select **Off**, **Low**, **Medium** or **High** to activate/deactivate the automatic function and select a level for the driver's and passenger's seats.

### Related information

- Climate system controls (p. 186)
- Climate system controls in the center display (p. 187)
- Rear climate system controls on the tunnel console\* (p. 189)

### Turning front seat ventilation\* on and off

Seat ventilation can be used e.g., to help remove dampness from the seat occupant's clothing.

The ventilation system consists of fans in the seats and backrests that draw air through the seat upholstery. The cooling effect increases as the air in the passenger compartment becomes cooler. This feature can be activated when the engine is running and it monitors the seat's temperature, sunlight in the passenger compartment and the ambient temperature.

### Activating/deactivating front seat ventilation

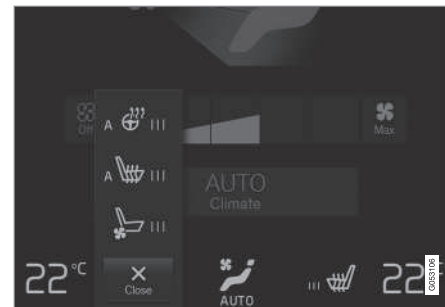

Steering wheel and seat buttons in the climate bar

1. Tap the left or right side steering wheel and seat button in the center display's climate bar to open the steering wheel and seat controls.
 

If the vehicle is not equipped with the optional heated steering wheel/seats, the button for seat ventilation will be directly accessible in the climate bar.
2. Tap the seat ventilation button repeatedly to select one of four levels: **Off**, **High**, **Medium** or **Low**.
  - > The level changes and is displayed in the button.

**i NOTE**

Seat ventilation cannot be started if the temperature in the passenger compartment is too low.

For use over extended periods, the setting **Low** is recommended.

**Related information**

- Climate system controls (p. 186)
- Climate system controls in the center display (p. 187)

**Air distribution**

The incoming air is distributed through a number of different vents in the passenger compartment.

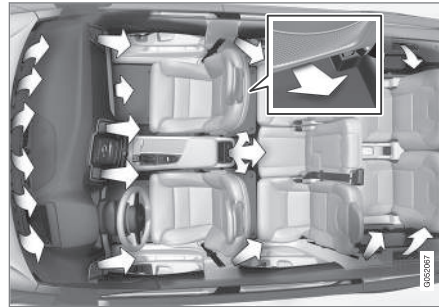
**Air distribution overview**

Air distribution with a 4-zone climate system

**Automatic and manual air distribution**

When the auto-climate feature is being used, air distribution is regulated automatically. However, air distribution can also be adjusted manually.

**Adjustable air vents**

There are 6, 8\* or 10\* adjustable air vents in the passenger compartment.

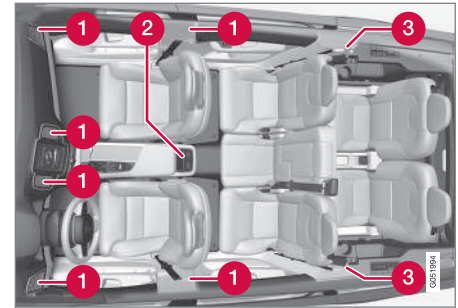

Location of the air vents

- 1 2-zone system: four vents on the dashboard and one on each of the pillars between the front and rear doors.
- 2 4-zone system\*: two additional vents on the rear side of the tunnel console.
- 3 4-zone system\*: one additional vent on each of the pillars behind the rear seats.

**Related information**

- Climate control system (p. 182)
- Adjusting air distribution (p. 202)
- Opening/closing/directing air vents (p. 202)
- Air distribution table (p. 204)
- Automatic climate control (p. 186)

## Opening/closing/directing air vents

Some of the passenger compartment air vents can be open/closed/directed individually.

Direct the dashboard and door pillar outer air vents toward the side windows to demist/defrost.

Direct the vents into the passenger compartment to help maintain a comfortable temperature in warm weather.

### Opening/closing air vents

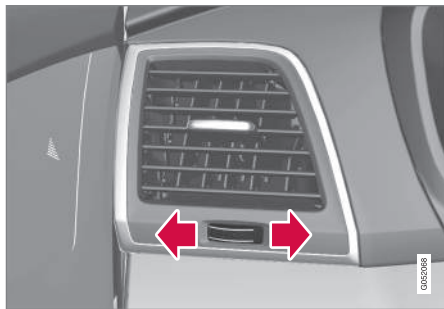

Air vent thumb wheel <sup>8</sup>

- Turn the thumb wheel to open/close the air flow from the vent.

The more of the white lines on the thumb wheel that are visible, the greater the air flow.

### Directing air flow

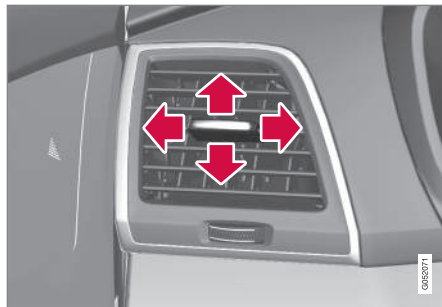

Air flow control <sup>8</sup>

- Move the control from side to side or up/down to direct the flow of air from the vent.

### Related information

- Air distribution (p. 201)
- Adjusting air distribution (p. 202)
- Air distribution table (p. 204)

## Adjusting air distribution

Air distribution can be adjusted manually.

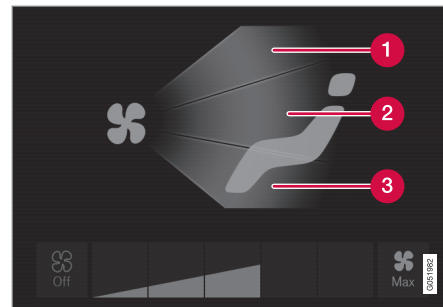

Air distribution buttons in Climate view

- 1** Defrost the windshield
- 2** Air vents in the dashboard and center console
- 3** Floor air vents
  1. Go to Climate view in the center display.
  2. Tap one or more of the air distribution buttons to open/close the corresponding air flow.
    - > Air distribution changes and the buttons light up or go out.

<sup>8</sup> The illustration is generic; the air vent's design varies, depending on its location.











**Related information**

- Air distribution (p. 201)
- Opening/closing/directing air vents (p. 202)
- Air distribution table (p. 204)
- Climate system controls in the center display (p. 187)

## Air distribution table

Air distribution can be adjusted manually.

	Air distribution	Use
	<p>If all air distribution buttons are deselected in manual mode, the climate system will revert to automatic mode.</p>	
	<p>Main air flow from the defroster vents, some flow from the other vents.</p>	<p>To remove ice and condensation (with moderate blower speed).</p>
	<p>Main air flow from the dashboard vents, some flow from the other vents.</p>	<p>For best comfort in hot weather.</p>
	<p>Main air flow from the floor vents, some flow from the other vents.</p>	<p>For heating/cooling near the floor.</p>

	Air distribution	Use
	Main air flow from the defroster and dashboard vents, some flow from the other vents.	For best comfort in hot and dry weather.
	Main air flow from the defroster and floor vents, some flow from the other vents.	For best comfort and defrosting in cold or humid conditions.
	Main air flow from the dashboard and floor vents, some flow from the other vents.	For good comfort in sunny, cool weather. For cooling or heat to the floor.
	Main air flow from the defroster, dashboard and floor vents.	For cooler air toward the floor in warm weather or warmer air upward in cold weather.

### Related information

- Air distribution (p. 201)
- Opening/closing/directing air vents (p. 202)
- Climate system controls in the center display (p. 187)
- Adjusting air distribution (p. 202)



LOADING AND STORAGE

### Cargo space

The vehicle has flexible cargo capacity that makes it possible to load and secure large objects.

By folding down the backrests in the second and third rows\* of seats, the cargo capacity of the vehicle increases considerably. To make loading easier, the rear section of the vehicle can be raised and lowered using the pneumatic suspension\*. Use the load anchoring eyelets or the grocery bag holder to secure objects and the cargo compartment cover to help conceal the load.

The spare tire, jack and tools can be found under the cargo compartment's floor.

### Related information

- Loading (p. 208)
- Cargo compartment cover\* (p. 217)
- Cargo net (p. 213)
- Grocery bag holder (p. 213)
- Load anchoring eyelets (p. 216)
- Steel cargo grid\* (p. 215)
- Folding the second row backrests (p. 173)
- Folding the third row\* backrests (p. 175)
- Leveling control\* and suspension (p. 398)

### Loading

The load carrying capacity of your vehicle is determined by factors such as the number of passengers, the amount of cargo, the weight of any accessories that may be installed, etc.

### Loading recommendations

- Load objects in the cargo compartment against the backrest whenever possible.
- If the backrests of the second row seats are folded down, they should not be in contact with the front seat backrests. This could impede the function of the Whiplash Protection System (WHIPS).
- Unstable loads can be secured to the load anchoring eyelets with straps or web lashings to help keep them from shifting.
- Stop the engine and apply the parking brake when loading or unloading long objects. The gear selector can be knocked out of position by long loads, which could set the vehicle in motion.

### WARNING

- Stop the engine, put the gear selector in **P**, and apply the parking brake when loading or unloading long objects.
- The vehicle's driving characteristics may change depending on the weight and distribution of the load.
- A 44-pound (20 kg) object produces a force of 2,200 pounds (1,000 kg) in a head-on collision at 30 mph (50 km/h).
- The cargo area and rear seat should not be loaded to a level higher than 2 in. (5 cm) below the upper edge of the rear side windows. Objects placed higher than this level could impede the function of the Inflatable Curtain.

### WARNING

- Cover sharp edges on long loads to help prevent injury to occupants. Secure the load to help prevent shifting during sudden stops.
- Always secure large and heavy objects with a seat belt or cargo retaining straps.
- Always secure the load to help prevent it from moving in the event of sudden stops.
- Switch off the engine, apply the parking brake and put the gear selector in **P** when loading and unloading the vehicle.

## Raising/lowering the rear-end of the vehicle\*

Using the buttons on the rear edge of the cargo compartment, the rear-end of the vehicle (the level of the cargo compartment floor) can be raised or lowered for easier loading or to make attaching a trailer<sup>1</sup> simpler.

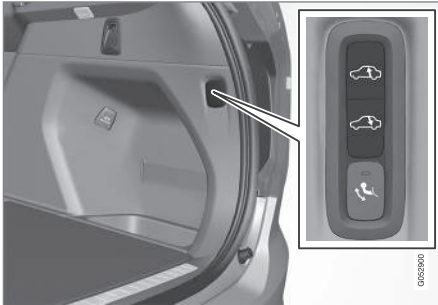

Level control buttons on the rear edge of the cargo compartment

The level control consists of two buttons: one to raise and one to lower the rear-end of the vehicle.

Press and hold the respective buttons until the desired level has been reached.

### **i** NOTE

The level cannot be adjusted if a door or the hood are open (this does not apply to the tail-gate).

### **⚠** WARNING

Be sure that the entire area under the vehicle is completely unobstructed before lowering the level.

### Extra loading space

The rear seat backrests can be folded down to added cargo space or for transporting long objects.

### **⚠** WARNING

- Boxes, suitcases, etc. wedged behind the front seats could impede the function of the Whiplash Protection System.
- If the rear seat backrests are folded down, cargo must be secured to prevent it from sliding forward against the front seat backrests in the event of a collision from the rear. This could interfere with the action of the Whiplash Protection System.

### **⚠** WARNING

- Cover sharp edges on long loads to help prevent injury to occupants. Secure the load to help prevent shifting during sudden stops.
- Always secure large and heavy objects with a seat belt or cargo retaining straps.
- Always secure the load to help prevent it from moving in the event of sudden stops.
- Switch off the engine, apply the parking brake and put the gear selector in **P** when loading and unloading the vehicle.

### Roof loads

Load carriers are available as Volvo accessories. Observe the following points when in use:

- To avoid damaging your vehicle and to achieve maximum safety when driving, we recommend using the load carriers that Volvo has developed especially for your vehicle.
- Volvo-approved removable roof racks are designed to carry the maximum allowable roof load for this vehicle (see the article "Weights" for specific information).
- Never exceed the rack manufacturer's weight limits.
- Avoid single-point loads. Distribute loads evenly.

<sup>1</sup> An accessory trailer hitch can be purchased from a Volvo retailer.

## LOADING AND STORAGE

- ◀ • Place heavier cargo at the bottom of the load.
  - Secure the cargo correctly with appropriate tie-down equipment.
  - Check periodically that the load carriers and load are properly secured.
  - Remember that the vehicle's center of gravity and handling change when you carry a load on the roof.
  - The vehicle's wind resistance and fuel consumption will increase with the size of the load.
  - Drive smoothly. Avoid rapid starts, fast cornering and hard braking.
- Cargo compartment cover\* (p. 217)
  - Steel cargo grid\* (p. 215)
  - Load anchoring eyelets (p. 216)
  - Whiplash protection system (p. 59)
  - Locking/unlocking the tailgate (p. 238)

### **!** CAUTION

The optional panoramic roof should not be opened while load carriers are installed on the vehicle.

See the article "Weights" for information about the maximum permissible load that can be transported on the roof.

### Related information

- Folding the second row backrests (p. 173)
- Folding the third row\* backrests (p. 175)
- Weights (p. 537)
- Cargo net (p. 213)

## Passenger compartment storage spaces

The following is an overview of the passenger compartment and its storage spaces.

### Front seats

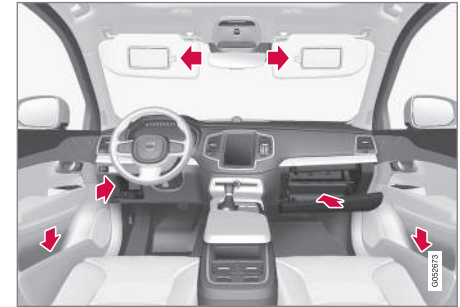

Storage spaces in the door panel, near the steering wheel, the glove compartment and the sun visors



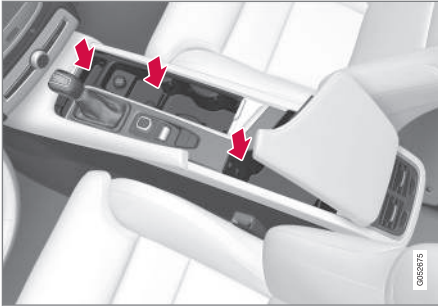

Storage spaces, cup holders and 12-volt socket/AUX/USB sockets in the tunnel console in the center console

### Second row of seats

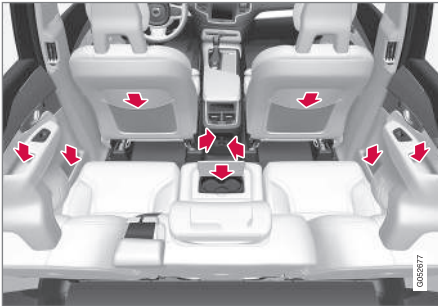

Storage compartments in the door panels, cup holders in the center seat's backrest, storage pockets on the rear side of the front seat backrest, and 12-volt socket on the rear side of the tunnel console

### Third row of seats\*



Storage space and cup holder in the side panel and the storage space between the seats

### WARNING

Always stow loose items such as cell phones, cameras, remote controls, etc. in the glove compartment or other storage spaces to help keep them from becoming projectiles in the event of sudden braking, etc.

### Related information

- Tunnel console (p. 212)
- Using the glove compartment (p. 211)
- Electrical sockets (p. 220)
- Sun visors (p. 219)

### Using the glove compartment

The glove compartment provides storage space for small items.

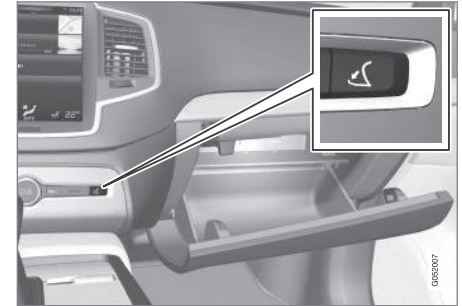

The glove compartment and opening button on the center console

The owner's manual and maps can be kept here. There are also holders for pens and the inside of the glove compartment door.

### Opening the glove compartment

- Press the glove compartment button on the center console.
  - > The glove compartment door will open.

### Locking/unlocking the glove compartment

The glove compartment and tailgate can be locked when e.g., the vehicle is in a workshop for service, etc. See also the article "Private locking" for additional information.



## ◀ Using the glove compartment as a cooler\*

The glove compartment can be used to cool drinks or food and the cooling feature functions when the climate system is active (i.e., when the ignition is in mode **II** or when the engine is running).

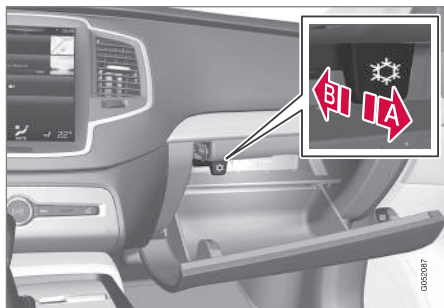

**A** Cooling activated

**B** Cooling deactivated

- Activate/deactivate cooling by moving the control as far as possible toward the passenger compartment/glove compartment.

### Related information

- Passenger compartment storage spaces (p. 210)
- Private (valet) locking (p. 242)

## Tunnel console

The tunnel console, located between the front seats, contains a 12-volt electrical socket, cup holders and storage spaces, etc.

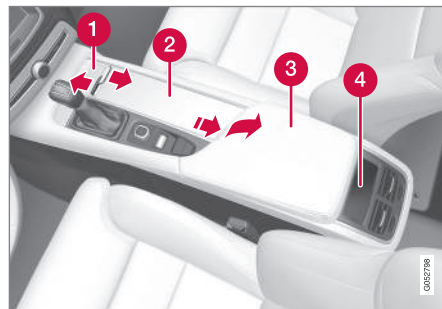

- 1** Storage space\*. Press the handle to open the cover.
- 2** Storage space with cup holders for the driver and passenger and a 12-volt socket
- 3** Storage space and USB/AUX sockets under the armrest
- 4** Climate control panel for the rear seats\* or storage space

### **i** NOTE

One of the alarm sensors, which is sensitive to metallic objects, is located under the tunnel console cup holders. Avoid leaving coins, keys, etc., in the cup holders because they may inadvertently trigger the alarm.

### Related information

- Passenger compartment storage spaces (p. 210)
- Electrical sockets (p. 220)
- Alarm (p. 245)
- Rear climate system controls on the tunnel console\* (p. 189)

## Grocery bag holder

The grocery bag holders (hooks) and elastic strap help keep shopping bags in place.

### Under the cargo compartment floor<sup>2</sup>

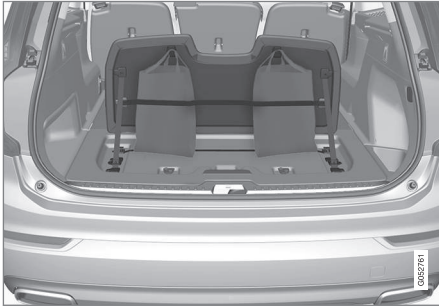

There are two grocery bag holders and an elastic strap<sup>3</sup> in the hatch that is part of the cargo area floor. The strap can be attached in four positions.

Open the hatch to access the grocery bag holders and attach the elastic strap. Grocery bags with handles can also be hung on the hooks.

### On the sides of the cargo compartment

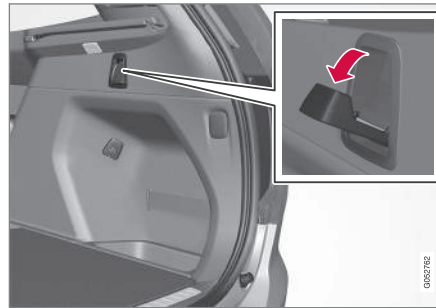

There are also two fold-out holders in the side panels, one on each side.

### **!** CAUTION

The grocery bag holders (hooks) are only intended to hold weights less than approx. 11 lbs (5 kg).

### Related information

- Cargo net (p. 213)
- Steel cargo grid\* (p. 215)
- Cargo compartment cover\* (p. 217)

## Cargo net

The cargo net helps protect passengers from objects in the cargo compartment in the event of a sudden stop or hard braking.

The cargo net is attached at four points.

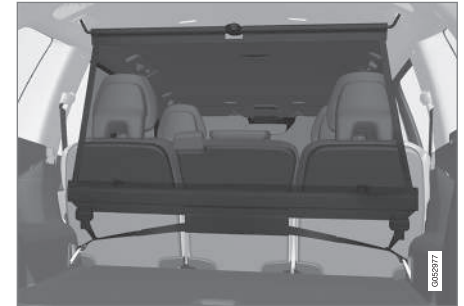

Cargo net

The cargo net can be mounted in two positions:

- Rear mounting: behind the second row seats' backrests.
- Front mounting: behind the front seats' backrests.

<sup>2</sup> 5-seat models only.

<sup>3</sup> Can be replaced by ordering a new one from a Volvo retailer.



**⚠ WARNING**

- Objects in the cargo compartment should always be securely anchored.
- All of the net's attachment points must be securely in place when the net is used.
- A damaged net must never be used.

**Attaching**

1. Fold out the cargo net and fold out the upper rod. Be sure it locks in position.
2. Insert one of the net's upper hooks into the front or rear ceiling mounting point with the net's lower straps' locks facing you.

3. Insert the other upper hook into the ceiling mounting point on the opposite side. It is spring-loaded to make mounting easier. Press each of the hooks as far forward into the respective mounting points as possible.

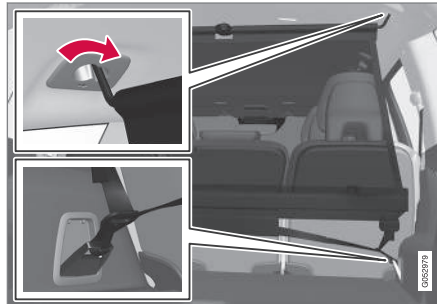

Rear mounting

4. **Rear mounting:** with the upper hooks inserted into the rear ceiling mounting points, hook the lower straps through the load anchoring eyelets on the floor of the cargo compartment as shown in the illustration.

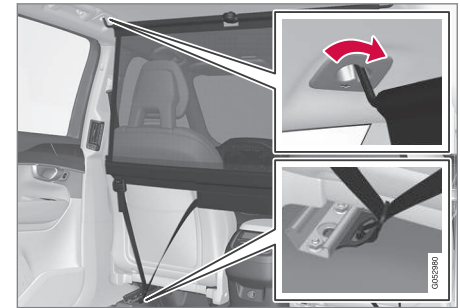

Front mounting

**Front mounting:** with the upper hooks inserted into the front ceiling mounting points, hook the lower straps through the eyelets on the front seat rails as shown in the illustration. Attaching the net is easier if the front seat backrests are upright and the seats are moved slightly forward.

Adjust the front seats so that they only touch the net but do not apply pressure to it.

**CAUTION**

Pressure from the front seats against the cargo net could damage the net and/or its brackets.

5. Pull the lower straps taut.

**Removing and storing**

1. Reduce tension on the net by pressing the button on the lower straps' respective locks and allow some slack on both sides.
2. Press in the catches and release both of the straps' hooks.
3. Remove the upper hooks from the ceiling mounting points.
4. Press the red button on the upper rod to allow it to fold.
5. Fold and roll up the net.

Store the net under the cargo compartment floor.

**Related information**

- Cargo compartment cover\* (p. 217)
- Load anchoring eyelets (p. 216)
- Steel cargo grid\* (p. 215)
- Loading (p. 208)

**Steel cargo grid\***

Your vehicle can be equipped with a steel grid that helps prevent objects in the cargo compartment from moving forward into the passenger area.

The steel grid is made up of the grid itself and two separate mounting brackets.

Each of the brackets has a screw cover and there are two plastic sleeves for the grid.

**WARNING**

- No one should ever be allowed to remain in the cargo compartment when the vehicle is moving.
- The steel grid may only be used in the rear position described in this article. The ceiling attachment points above the front seats are **not** intended to anchor the steel grid.
- The third row of seats (7-seat models\* only): these seats must be folded down when the steel grid is mounted in the vehicle.
- After being mounted, be sure that the steel grid is securely anchored in place.

**Mounting**

1. Fold down the rear seats (second row of seats in 7-seat models) and lift in the steel grid through one of the rear doors or the tailgate. The curved (convex) side of the grid should face toward the cargo compartment and the hooks on each side of the grid should face upward. The mounting brackets and plastic sleeves are not needed in this step.

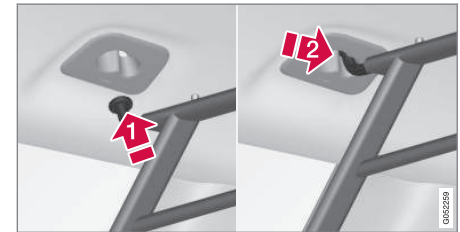

2. Press one of the grid's hooks into the larger part of the opening in the ceiling attachment point (1) as shown in the illustration.
3. Grasp the grid near the hook and move it toward the smaller opening (2).
  - > This secures the hook in the attachment point.
4. Repeat steps 2 and 3 for the hook on the opposite side of the grid.



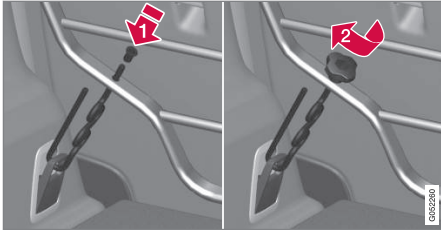

5. Attach the mounting bracket's hook through the cargo anchoring eyelet near the floor of the cargo compartment and insert the threaded section of the bracket through the grid's lower attachment hole (1).
6. Slide the plastic sleeve onto the threaded section of the of the mounting bracket with the sleeve's flange turned upward and press it down through the hole. Screw the screw cover into place until its underside is approx. 0.2 in. (5 mm) from the grid (2).
7. Repeat steps 5 and 6 for the opposite side.
8. Center the grid and tighten both mounting brackets alternately until the grid is held securely in place.

### Removing

Perform the steps above in reverse order.

The hooks can be removed before the plastic sleeves are removed from the holes in the grid.

### Related information

- Cargo net (p. 213)
- Cargo compartment cover\* (p. 217)
- Load anchoring eyelets (p. 216)
- Loading (p. 208)

### Load anchoring eyelets

The eyelets in the cargo compartment can be folded out to secure objects with straps, a net, etc.

### Load anchoring eyelets

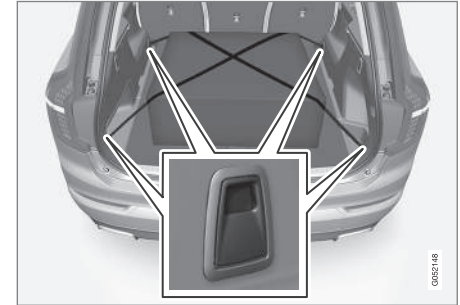

### **WARNING**

- Cover sharp edges on long loads to help prevent injury to occupants. Secure the load to help prevent shifting during sudden stops.
- Always secure large and heavy objects with a seat belt or cargo retaining straps.
- Always secure the load to help prevent it from moving in the event of sudden stops.
- Switch off the engine, apply the parking brake and put the gear selector in **P** when loading and unloading the vehicle.

**Related information**

- Loading (p. 208)
- Grocery bag holder (p. 213)
- Cargo net (p. 213)
- Steel cargo grid\* (p. 215)
- Cargo compartment cover\* (p. 217)

**Cargo compartment cover\***

The cover can be used to conceal objects in the cargo compartment.

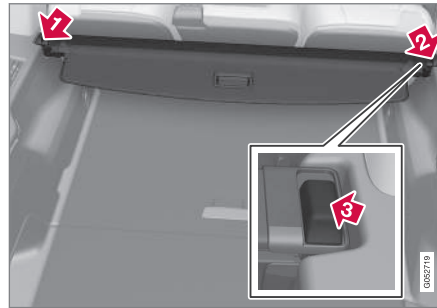
**Installing the cover**

- ➔ With the cover retracted, press the end piece on one side of the cargo area cover into the retaining bracket in the side panel of the cargo area.
- ➔ Do the same on the opposite side.
- ➔ Press both sides of the cover, one at a time, until they click into place.
  - > The red mark will no longer be visible. Check that both ends of the cover are securely locked in place.

**Using the cover**

The cover can be used in two positions: fully open to completely cover the cargo compartment

or partially retracted to make it easier to reach farther into the cargo compartment.



◀ **Fully open**  
**7-seat models**

1.

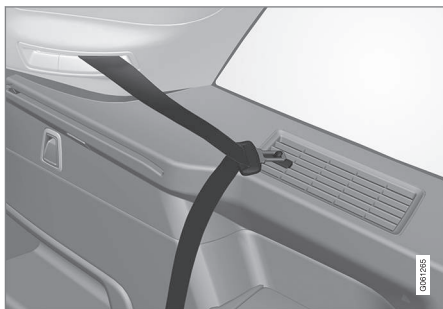

Third row seats: hang the seat belt latches in the hooks provided in the side panels.

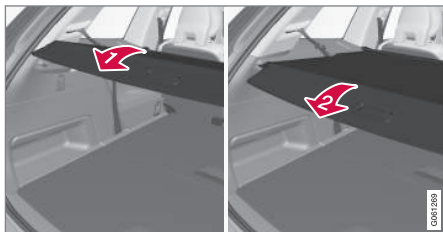

- 1) Grasp the handle and pull out the cover above the side panels in the cargo compartment as far as possible.

- 2) With the cover completely open, press the attaching pins on the rear corners of the cover into the grooves in the side panels and release the cover slightly while pressing the handle lightly downward.
  - > The cover is now fixed in the fully open position.

**5-seat models**

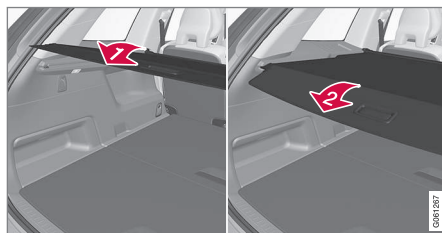

- 1) Grasp the handle and pull out the cover above the side panels in the cargo compartment as far as possible.
- 2) With the cover completely open, press the attaching pins on the rear corners of the cover into the grooves in the side panels and release the cover slightly while pressing the handle lightly downward.
  - > The cover will remain in the fully open position.

**Partially retracted**



- 1) With the cover retracted, grasp its handle and pull it so that it is above the cargo compartment's side panels until it is fully open. Press the attaching pins on the rear corners of the cover into the grooves in the side panels. If the cover is already fully open see the next step.
- 2) With the cover completely pulled out, press it upward lightly and allow it to retract slowly.
  - > Allow the cover to retract until it stops in the partially retracted position.

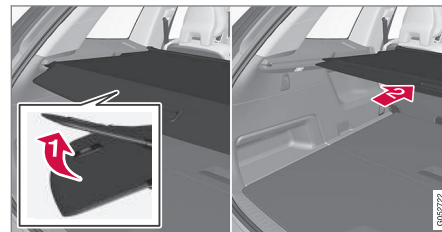



If you are holding something in one of your hands:

- 1 From the fully open position, push the cover's handle slightly upward with e.g., your elbow.
  - > 2 The cover will close until it reaches the partially retracted position.

To fully open the cover from the partially open position:

1. Grasp the handle and pull out the cover to the fully open position.
2. Let the cover retract slightly and press the handle slightly downward.
  - > The cover will be secured in the fully open position.

Avoid placing any objects on the cover when it is open.

### WARNING

7-seat models: remove the cargo compartment cover completely from the vehicle if one or both of the third row seats will be occupied.

### Retracting the cover

From the fully open position:

- Lift the cover's handle and pull it rearward slightly to release the attaching pins from their grooves. Allow the cover to retract.

From the partially retracted position:

- Grasp the handle and lift it slightly to release the attaching pins from their grooves. Pull the cover to the fully open position.
  - > Allow the cover to retract completely.

### Removing the cover

1. With the cover retracted, press the button on one of the cover's ends and lift out that end.
 

For 7-seat models: Release the seat belt latches from the hooks in the side panels. For 5-seat models, see the following step.
2. Carefully lift the cover up/out.
  - > The other end will release automatically. Lift the cover out of the cargo compartment.

### Related information

- Cargo net (p. 213)
- Steel cargo grid\* (p. 215)
- Loading (p. 208)
- Load anchoring eyelets (p. 216)

### Sun visors

There are vanity mirrors with card holders on the upper sides of the sun visors.

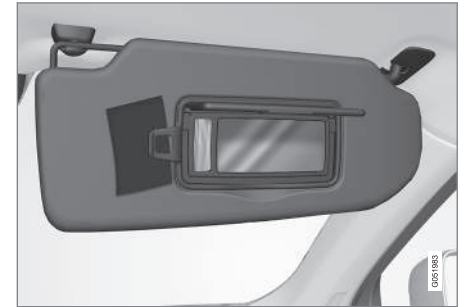

Lighted vanity mirror and card holder

The vanity mirror lighting comes on when the mirror is opened.

The vanity mirror's frame has a holder for e.g., a card or ticket.

### Related information

- Passenger compartment storage spaces (p. 210)

## Electrical sockets

There are two 12-volt sockets in the tunnel console, a 120-volt socket on the rear side of the tunnel console, and one 12-volt socket in the cargo area\*.

### 120-volt socket in the tunnel console<sup>4</sup>



120-volt socket in the tunnel console for the second row of seats

This socket is intended for 120-volt devices such as laptops, chargers, etc.

The max. current provided is 150W.

### Using the sockets

1. Slide down the cover over the socket and plug in the device.
  - > The socket's indicator light will indicate its status. The socket can only provide electrical current when the light is green.
2. Disconnect the device by pulling its plug, not its cord.

Pull up the cover over the socket when it is not in use.

### CAUTION

- Do not connect devices with large or heavy plugs that could come loose while driving.
- Do not use devices that can cause interference with the vehicle's radio receiver or electrical system.

### WARNING

- Be sure to place any devices connected to the socket safely so that they do not become projectiles in the event of a sudden stop and injure the occupants of the vehicle.
- Be aware that connected devices may generate heat and become very hot.
- Only connect devices that function correctly and are free from defects. These devices should be intended for use in a 120-volt, 60Hz socket with a plug intended for the socket in the vehicle and be UL-approved (or the equivalent thereof).
- Never let the device, its plug or the socket itself come in contact with fluids of any kind. Never touch or use the socket if it appears to be damaged or wet.
- Never connect multiple plugs, adapters or extension cords to the socket. This could override the socket's safety functions.
- Never let children play or tamper with the socket, or attempt to insert any objects into it. Never leave children unattended in the vehicle when the socket is active.
- Never try to modify or repair the 120-volt socket. This should only be done by a

<sup>4</sup> Certain models only.

trained and qualified Volvo service technician.

Failure to follow the points above could result in electrical shock and/or serious injury.

### Status indication

An LED (Light Emitting Diode) on the socket indicates its status:

Status indicator light	Socket status	Action
Steady green light	The socket is providing current to a connected device.	None.
Flashing orange light	The socket's voltage converter is too hot (the connected device draws too much current, etc. or the temperature in the passenger compartment is very high).	Unplug the device, let the converter cool down and plug in the device again.
	The connected device draws too much current (constantly or currently) or is not functioning properly.	None. The device should not be plugged into the socket.
Indicator light off	The socket has not detected a plugged in device.	Be sure the device is correctly plugged into the socket.
	The socket is not active.	Put the vehicle's ignition in at least mode I.
	The socket has been active but has been deactivated.	Start the engine and/or charge the start battery.

If a problem persists, have the socket checked by a trained and qualified Volvo service technician.

◀◀ **12-volt socket in the tunnel console**



12-volt socket in the tunnel console for the front seats



12-volt socket in the tunnel console for the second row of seats

The electrical sockets can be used for 12-volt devices such as monitors, MP3 players and cell

phones. For the sockets to provide electrical current, the ignition must be in at least mode I.

**WARNING**

Always keep the sockets covered when not in use.

**CAUTION**

Max. current provided is 10 A (120 W) if one socket is used at a time. If both of the sockets in the tunnel console are used at the same time, the max. current provided per socket is 7.5 A (90 W)

If a tire sealing system's compressor is being used, no other device should be connected to any of the other sockets while the compressor is operating.

**12-volt socket in the cargo area**

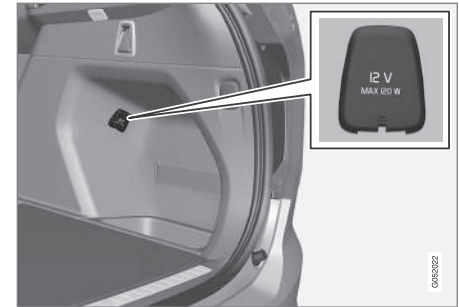

12-volt socket in the cargo area

Fold down the cover to access the socket. Max. current provided is 10 A (120 W).

**NOTE**

The 12-volt socket in the cargo area provides electrical current even when the ignition is switched off. Using the socket while the engine is not running will drain the battery.

**Related information**

- Passenger compartment storage spaces (p. 210)
- Ignition modes (p. 380)

LOCKS AND ALARM

## Locks and remote keys

The vehicle can be locked and unlocked in various ways and there are several types of remote keys that can be used.

### Locking/unlocking/opening/closing

The vehicle can be locked/unlocked from the passenger compartment, using the buttons on the remote key or by using the optional Passive Entry system where it is only necessary to have a key in your possession to lock or unlock the doors.

On models equipped with a power tailgate\*, it can also be opened/closed by moving your foot under a sensor\* beneath the rear bumper.

If for any reason a remote key does not function properly, it may be necessary to replace its batteries but the vehicle can always be locked or unlocked manually using the remote key's detachable key blade.

### Remote key

The remote key does not have to be physically handled in order to start the engine because the vehicle is equipped with the standard Passive Start system (the key only needs to be in the front part of the passenger compartment). If the vehicle is equipped with the optional Passive Entry system that enables keyless entry and start, the key can be anywhere in the vehicle when the engine is started.

Models with Passive Entry\* also have an extra, smaller key without buttons called a Key Tag.

Additional keys can be ordered from a Volvo retailer.

### Related information

- Immobilizer (p. 224)
- Alarm (p. 245)
- Child safety locks (p. 246)
- Remote key (p. 227)
- Foot movement tailgate operation\* (p. 232)
- Locking/unlocking from inside the vehicle (p. 235)
- Locking/unlocking from outside the vehicle (p. 233)
- Locking/unlocking the tailgate (p. 238)
- Starting the engine (p. 382)

## Immobilizer

The immobilizer is a start inhibitor that helps prevent unauthorized persons from starting the engine.

Each of the keys supplied with your vehicle contains a unique coded transponder. The vehicle code in the key is transmitted to the vehicle's ignition system where it is compared to the code stored in the start inhibitor module.

The following message (which may appear in the instrument panel) is related to the immobilizer:

Symbol	Message	Explanation
	<b>Vehicle key not found</b> See <b>Owner's manual</b>	Remote key not recognized during start. Place the remote key on the key symbol in the tunnel console cup holder and try to start the vehicle again.

### Related information

- Remote key's range (p. 229)
- Remote key (p. 227)

## Changing the remote key's battery

The remote key can be opened if the battery needs to be replaced.

The battery should be replaced if:



The information symbol illuminates and **Vehicle key bat. low** See **Owner's manual** is displayed in the instrument panel.

and/or

if the locks do not react after several attempts to unlock or lock the vehicle with the remote key within approx. 65 feet (20 meters) of the vehicle.

### **i** NOTE

If the locks do not react, move closer to the vehicle and try to unlock it again.

The battery in the smaller extra key without buttons (Key Tag) provided with models with the optional Passive Entry system cannot be replaced. A new Key Tag can be ordered from a Volvo retailer.

### **i** NOTE

A Key Tag with a depleted battery should be returned to an authorized Volvo retailer. The key should also be erased from the vehicle's electrical system because it could still be used to start the vehicle from the back-up start system.

## Replacing the battery



**1** Hold the remote key with the front side (with the Volvo symbol) facing up and move the button on the key ring section of the key to the right. Slide the front cover slightly upward.

**2** The cover will loosen and can be removed from the key.

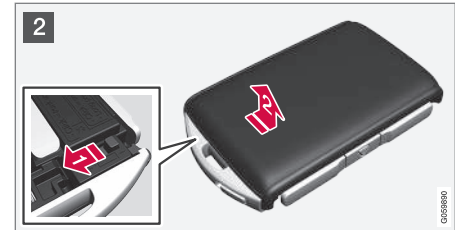

**2** **1** Move the button to the side and slide rear cover slightly upward.

**2** The cover will loosen and can be removed from the key.

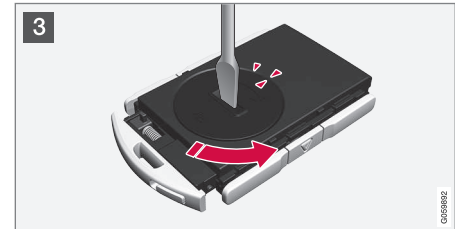

**3** Use e.g., a screwdriver to turn the battery cover counterclockwise so that the markers align toward **OPEN**.

**1** Remove the cover carefully by pressing e.g., a finger nail into the indentation.

**2** Pry the cover up.



4 The battery's positive (+) side is up. Pry out the battery as shown in the illustration.

**!** **CAUTION**  
When handling batteries, avoid touching their contact surfaces as this could result in poor battery function in the remote key.

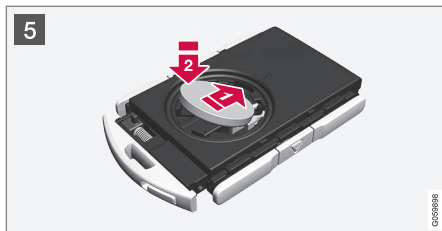

5 Insert a new battery<sup>1</sup> with the positive (+) side up. Put the battery cover back in place by:

- Placing the battery's edge downward in the holder. Slide the battery forward so that it is held in place by the two plastic catches.
- Pressing the battery downward so that it is also held in place by the two upper catches under the upper black holder.

**i** **NOTE**  
Volvo recommends that the batteries used in the remote control meet the UN Manual of Test and Criteria, Part III, sub-section 38.3.  
Batteries installed in the key from the factory and batteries exchanged by an authorized Volvo workshop fulfill the above criteria.  
Old batteries should be disposed of properly at a recycling center or at your Volvo retailer.

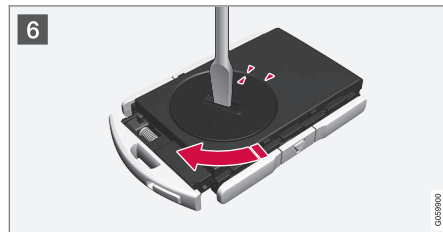

6 Put the battery cover in place and turn it clockwise until the marker points to **CLOSE**.

<sup>1</sup> Use a CR2032, 3 V battery.





7 **1** Put the rear cover in position and press down until it clicks into place.

**2** Slide the cover into place as indicated by arrow 2 in the illustration.

> Another click indicates that it is correctly in position and closed.



8 **1** Press the front cover (with the Volvo logo) until it clicks into place.

**2** Slide the cover into position as indicated by arrow 2 in the illustration.

> Another click indicates that it is correctly in position and closed.

### Related information

- Remote key (p. 227)

## Remote key

The remote key is used to lock/unlock the vehicle and must be in the passenger compartment in order to start the engine.



The standard remote key (left) and the Key Tag (right)

In models with the standard Passive Start system, the remote key only needs to be in the front section of the passenger compartment or in the tunnel console cup holders in order to start the engine.

The keyless Passive Entry system for locking/unlocking the vehicle is available as an option. This system has a range of approximately 5 feet (1.5 meters) from the sides of the vehicle or approximately 3 feet (1 meter) from the tailgate. With this system, a remote key can be anywhere in the vehicle.

- ◀ Each of the remote keys provided with the vehicle can be linked to a driver profile containing unique personal settings that will be applied when that particular key is used. See also the article "Driver profile" for additional information.

### **i** NOTE

Avoid placing the remote key closer than approx. (4-6 in.) (10-15 cm) to any metallic objects or electronic devices such as cell phones, tablets, laptops or chargers.

If interference persists, unlock the vehicle with the detachable key blade and place the remote key in the backup key reader in the tunnel console cup holder to disarm the alarm.

### **⚠** WARNING

Always remove the remote key from the passenger compartment when leaving the vehicle and ensure that the ignition is in mode **O**, especially if there are children in the vehicle.

## Key Tag

In addition to the two remote keys provided, a smaller third key, called a Key Tag, is also provided for vehicles equipped with the optional Passive Entry system.

This key functions in the same way as a standard remote key but does not have a detachable key blade and its battery cannot be replaced; a new Key Tag has to be ordered.

## Ordering new keys

Two remote keys are provided with the vehicle (a Key Tag<sup>2</sup> is also included for vehicles equipped with the optional Passive Entry system). Additional keys (a total of 12) can be ordered and used with the vehicle.

## The remote key's buttons



The remote key has four buttons: one on the left side and three on the right side

- 🔒 Lock:** Press to lock the doors/tailgate and arm the alarm.
- 🔓 Unlock:** Press to unlock the doors/tailgate and disarm the alarm. This setting can be

changed in the center display's Settings menu.

- 🔓 Tailgate:** Press to unlock the tailgate only (and disarm the alarm for the tailgate). On vehicles equipped with the power tailgate\*, press and hold to open the tailgate. Press and hold to close an open tailgate (an audible warning signal will sound).
- ⚠ Panic alarm:** Press to attract attention during emergency situations. **To activate**, press and hold this button for at least 3 seconds or press it twice within 3 seconds to activate the turn signals and horn. **To deactivate**, wait approximately 5 seconds and press the button again (the panic alarm will also deactivate automatically after several minutes).

## Interference

Metallic objects or electromagnetic fields may interfere with the remote key's function. Avoid placing the remote key within 4-6 in. (10-15 cm) of a cell phone or a metallic object.

If interference persists, use the remote key's detachable key blade to unlock the vehicle and place the remote key in the backup key reader in the tunnel console cup holder.

## Loss of a remote key

If a remote key is lost, the others should be taken with the vehicle to a Volvo retailer. As an anti-

<sup>2</sup> The Key Tag is also referred to as a Sport key. This key is designed to be waterproof to a depth of approximately 30 ft (10 meters) for up to 60 minutes, making it suitable for use in activities in and around water.

theft measure, the code of the lost remote key must be erased from the system. The number of registered keys for the vehicle can be found in the center display's Top view.

### **i** NOTE

Additional or duplicate remote control keys can be obtained from any authorized Volvo retailer.

You can also obtain additional or duplicate remote control keys from certain independent repair facilities and locksmiths that are qualified to make remote control keys. Each key must be programmed to work with your vehicle.

A list of independent repair facilities and/or locksmiths known to Volvo that can cut and code replacement keys can be found:

- on the Volvo website, [www.volvocars.com/us](http://www.volvocars.com/us)
- by calling Volvo Customer Care at 1-800-458-1552.



### Related information

- Remote key's range (p. 229)
- Detachable key blade (p. 231)
- Changing the remote key's battery (p. 225)
- Driver profiles (p. 175)

## Remote key's range

In order to function correctly, the remote key must be within a certain distance of the vehicle.

### Manual use

The remote key's functions, such as locking and unlocking the vehicle, which are activated by pressing the  or  buttons, have a range of approx. 65 feet (20 meters) from the vehicle.

Buildings or other obstacles may interfere with the function of the remote key. The vehicle can also be locked or unlocked with the key blade.

If the vehicle's locks do not react, move closer and try again.

### Keyless use<sup>3</sup>

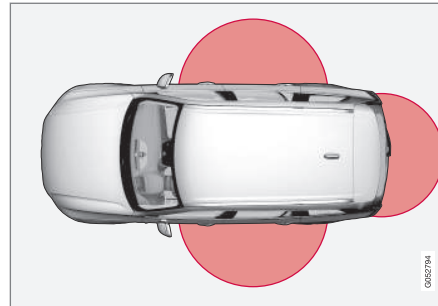

The shaded areas illustrate the range of the Passive Entry system's antennas

For keyless entry into the vehicle, the remote key must be within approximately 5 feet (1.5 meters) of the sides of the vehicle or approximately 3 feet (1 meter) of the tailgate as shown in the illustration.

The remote key may not function properly due to ambient radio waves, buildings or topographical obstructions, etc. The vehicle can always be locked/unlocked with the detachable key blade.

### If the remote key is removed from the vehicle

If all of the remote keys are removed from the vehicle while the engine is running, **Vehicle key not found** Removed from vehicle will be displayed in the instrument panel and an audible signal will sound when all of the doors have been closed. The message will be erased when a remote key has been returned to the vehicle and the **O** button on the right-side steering wheel keypad has been pressed or when all of the doors have been closed again.

### Related information

- Remote key (p. 227)
- Antenna locations for the start and lock system (p. 236)

<sup>3</sup> Models equipped with the optional Passive Entry only.

## Red Key\*

The Red Key (also referred to as a restricted key) makes it possible to limit several of the vehicle's functions to help ensure that it is operated safely, for instance if the vehicle is used by a young driver.



A Red Key makes it possible to limit the vehicle's maximum speed, add speed reminders and limit the audio system's volume. Several of the vehicle's safety systems will also always be active. Otherwise, this key functions in the same way as a standard remote key.

One or more Red Keys can be ordered from a Volvo retailer after the vehicle has been purchased. A total of 11 keys can be programmed and used for the same vehicle, one of which has to be a standard remote key.

Settings for the Red Key can be made by a standard remote key user from the center display's Top view under: **Settings** → **System** → **Driver Profiles** → **Red key**.

Several of the vehicle's safety function cannot be turned off by a Red Key user.

The restrictions are designed to help reduce the risk of an accident and they cannot be changed by a Red Key user. These settings cannot be changed by the Red Key's user.

### Possible settings

The following settings can be made for a Red Key:

#### Speed Limiter\* (On/Off)

- Setting interval: 30-160 mph (50-250 km/h)
- Default setting: 75 mph (120 km/h)
- Increments: 1 mph (1 km/h)



This symbol will appear in the instrument panel and the message **Red keySpeed limitation cannot be exceeded** will be displayed.

See the article "Speed limiter" for additional information.

#### Speed reminder (On/Off):

- Setting interval: 0-155 mph (0-250 km/h)
- Default settings: 30, 45 and 55 mph (50, 70 and 90 km/h.)
- Increments: 1 mph (1 km/h)

- Max. number of reminders: 6

#### Reduced max. volume (on/off)

- Default setting: On

#### Adaptive cruise control \* (On/Off)

- Initial setting: On at the longest interval
- See the article "Adaptive cruise control" for additional information

### Safety functions

The following safety functions will always be active for a Red Key user:

- Blind Spot Information (BLIS)\*
- Lane Keeping Aid (LKA)\*
- Distance Alert\*
- City Safety\*
- Driver Alert Control (DAC)\*
- Road Sign Information (RSI)\*

### Related information

- Remote key (p. 227)
- Adaptive Cruise Control (ACC)\* (p. 269)
- Speed limiter (SL)\* (p. 255)
- Blind Spot Information (BLIS)\* (p. 317)
- Driving lane assistance (p. 328)
- Distance Alert\* (p. 267)
- City Safety™ (p. 304)
- Driver Alert Control (DAC) (p. 326)
- Road Sign Information (RSI)\* (p. 324)

## Detachable key blade

Your vehicle's remote key contains a detachable key blade that can be used to unlock the driver's door, etc.

A Volvo retailer can provide you with the key blade's unique code.

## Using the detachable key blade

The remote key's detachable key blade can be used to:

- Unlock the driver's door if the central locking system cannot be activated using the remote key
- Lock all doors
- Activate/deactivate the mechanical child safety locks in the rear doors

The Key Tag<sup>4</sup> does not have a detachable key blade.

## Detaching the key blade



- 1** Hold the remote key with the front side (with the Volvo symbol) facing up and move the button on the key ring system of the key to the right. Slide the front cover slightly upward.

**2** The cover will loosen and can be removed from the key.



- 2** Remove the key blade by pulling it up.



- 3** After use, press the key blade back into its position in the key.

**1** Press the front cover (with the Volvo logo) until it clicks into place.

**2** Slide the cover into position as indicated by arrow 2 in the illustration.

> An additional click indicates that the cover is correctly in place.

## Related information

- Locking/unlocking with the detachable key blade (p. 243)
- Child safety locks (p. 246)

<sup>4</sup> Models with the optional Passive Entry system only.

### Foot movement tailgate operation\*

The foot movement sensor\* simplifies opening or closing the tailgate if your hands are full.<sup>5</sup>

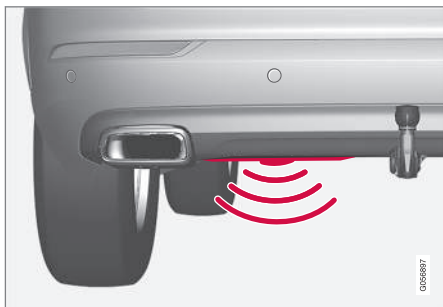

The foot movement sensor is located to the left of center under the rear bumper<sup>6</sup>

**i NOTE**

One of the remote keys must be in your possession or within range when you are behind the vehicle in order to activate the foot movement sensor, even if the tailgate is already unlocked. This is done to help prevent the sensor from inadvertently opening the tailgate, for example, in a car wash.

Be sure that the key is not within range when the vehicle is in an automatic carwash.

### Operation



Kicking motion under the sensor's activation area

### Opening/closing

- With the remote key within range, move your foot slowly forward in a kicking motion below the left section of the rear bumper without touching the bumper and take a step back.
  - > A brief audible signal will sound when the tailgate begins to open/close.

The tailgate can be closed (or closed and locked) by pressing the or buttons on the lower edge of the tailgate<sup>7</sup>.

It can also be operated manually or by pressing the button on the lighting panel in the passenger compartment or on the remote key.

If several attempts have been made to open/close the tailgate using the foot sensor without a remote key within range, the function will time out and will not be available for a short period.

**i NOTE**

Foot operation may not be possible or function normally if the sensor is obstructed by snow, ice, dirt, etc.

<sup>5</sup> Models equipped with the optional power tailgate only.

<sup>6</sup> If the vehicle is equipped with a skid plate/diffuser\*, the sensor is located under the left corner of the bumper.

<sup>7</sup> Vehicles equipped with the optional Passive Entry system only.

### Interrupting opening/closing

- Move your foot slowly forward in a kicking motion while the tailgate is opening/closing to stop its movement.

No remote keys need to be within range in order to interrupt movement of the tailgate.

### Vehicles equipped with a skid plate/diffuser\*

If the vehicle is equipped with a skid plate/diffuser\*, the sensor is located under the left corner of the rear bumper.



Sensor location on vehicles equipped with a skid plate/diffuser\*

To open/close the tailgate, make the kicking motion from the side of the rear bumper.

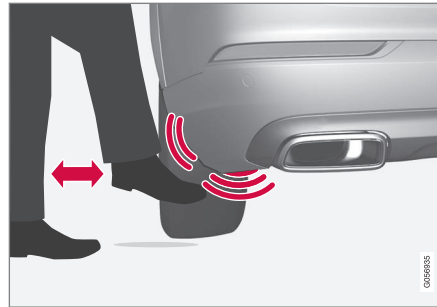

Kicking motion under the sensor's activation area

### Related information

- Power tailgate\* (p. 240)
- Locking/unlocking the tailgate (p. 238)
- Remote key's range (p. 229)

### Locking/unlocking from outside the vehicle

The buttons on the remote key can be used to lock or unlock all doors and the tailgate at the same time. This can also be done without pressing the remote key buttons on models equipped with the optional keyless Passive Entry system. The power tailgate\* can also be opened/closed by moving your foot under a sensor beneath the rear bumper.

### Locking and unlocking

The lock/unlock settings can be changed in the center display's Top view.

Go to: **Settings** → **My Car** → **Remote and Interior Unlock** and select **Unlock All Doors or Single Door**.

In order to lock the vehicle, the driver's door must be closed. If the tailgate or any of the other doors are open, they will be locked and the alarm will be armed when they are closed.

### **i** NOTE

Be sure the remote key is outside of the vehicle before the other doors/tailgate are closed to help avoid locking the remote inside the vehicle.

The settings made for the **Remote and Interior Unlock** function also affect the central locking



◀ system when a door is opened from inside the vehicle using a door handle. See also the article "Locking/unlocking from inside the vehicle" for additional information.

If the locks repeatedly do not react when the unlock button is pressed, begin by moving closer to the vehicle. However, it may be necessary to replace the battery in the remote. In this case, the driver's door can be unlocked with the detachable key blade. See also the article "Detachable key blade" for additional information.

### Keyless Passive Entry\*

If the vehicle is equipped with this system, it is only necessary to have a remote key in your possession to operate the central locking system.

Models with Passive Entry have an indentation on the outside of the handle for locking the vehicle and a pressure sensitive surface on the inside of the handle for unlocking.

The tailgate has a rubberized button used only for unlocking.

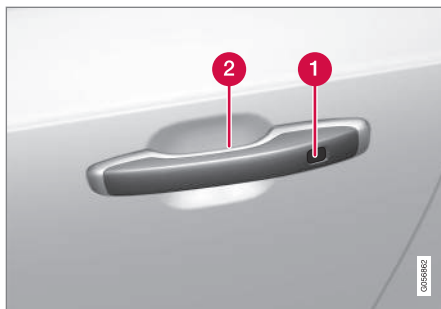

Outer indentation for locking, the pressure sensitive surface on the inside of the handle is for unlocking

- 1 Pressure sensitive indentation for locking
- 2 Pressure sensitive surface for unlocking



Rubberized button on the tailgate used only for unlocking

### Locking

All of the doors have to be closed before the vehicle can be locked but the tailgate can be open.

Lock the doors and tailgate by pressing the pressure sensitive indentation on the outside of any of the door handles. The lock indicator light on the dashboard will begin to flash to show that the vehicle is locked and the alarm has been armed.

#### **i** NOTE

Only one of a door handle's lock/unlock surfaces should be pressed at a time. If both areas are pressed simultaneously, the desired locking/unlocking action may not occur or may be delayed.

To close windows or the panoramic roof\* when locking the vehicle, hold the pressure sensitive surface on the outside of a door handle until the window(s)/panoramic roof have closed completely. The windows/panoramic roof will stop if the button is released before they are fully closed.



## Unlocking

Pull a door handle to unlock and open the door or press the rubberized button under the tailgate opening control. The lock indicator light on the dashboard will go out to show that the vehicle is unlocked and the alarm has been disarmed.

The lock/unlock settings can be changed in the center display's Top view:

Go to: **Settings** → **My Car** → **Keyless Unlock** and select **All Doors** or **Single Door**.

## Automatic relocking

If no door or the tailgate is opened within two minutes after being unlocked, the vehicle will automatically relock.

## Remote door unlock

The vehicle can be unlocked using the Volvo On Call app.

## Related information

- Remote key (p. 227)
- Remote key's range (p. 229)
- Detachable key blade (p. 231)
- Alarm (p. 245)
- Locking/unlocking from inside the vehicle (p. 235)
- Foot movement tailgate operation\* (p. 232)
- Locking/unlocking the tailgate (p. 238)



## Locking/unlocking from inside the vehicle

The lock buttons on either of the front doors can be used to lock or unlock all doors and the tailgate at the same time. The rear doors can be locked using their respective lock buttons\*.

### The central locking system



Central locking/unlocking buttons and indicator lights on the front doors

- Press the  button to lock the vehicle. Press  to unlock.

## Unlocking

- Press the  button to unlock all doors and the tailgate.
- Pull the door opening handle on either of the front doors. This will unlock the vehicle completely<sup>8</sup> and the door will open.

## Locking

- Press the  button on either of the front doors to lock the vehicle (both front doors must be closed).

### Lock buttons on the rear doors\*



Lock button and indicator light in a rear door

The lock buttons in the rear doors lock/unlock each door respectively.

<sup>8</sup> The unlock setting "All Doors" must be selected. If the setting "Driver door, then all" has been selected, only that door will unlock and open.



- ◀◀ To unlock a rear door:
- To open one of the rear doors individually, pull its handle to unlock and open the door<sup>9</sup>.

### Automatic locking

All of the doors/tailgate will lock automatically when the vehicle begins to move.

### Related information

- Locking/unlocking from outside the vehicle (p. 233)
- Locking and unlocking confirmation (p. 237)
- Child safety locks (p. 246)

## Antenna locations for the start and lock system

The vehicle is equipped with a keyless<sup>10</sup> start and lock system that requires a number of antennas located at various points in the vehicle.

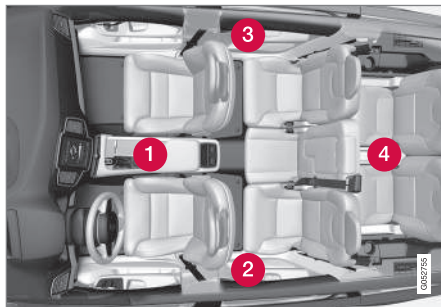

Location of the antennas

- 1 Under the cup holders in the front section of the tunnel console
- 2 In the upper front section of the driver side rear door<sup>10</sup>
- 3 In the upper front section of the passenger side rear door<sup>10</sup>
- 4 In the center of the rear seat backrest<sup>10,11</sup>

## WARNING

People with implanted pacemakers should not allow the pacemaker to come closer than 9 inches (22 cm) to any of the Passive Entry system's antennas. This is to help prevent interference between the pacemaker and the Passive Entry system.

### Related information

- Remote key (p. 227)
- Remote key's range (p. 229)

<sup>9</sup> Assuming that the child safety locks are not activated.

<sup>10</sup> Vehicles with the optional Passive Entry system only.

<sup>11</sup> In a seven-seat model, the antenna is located between the seats where the backrest and seat cushion meet.

## Locking and unlocking confirmation

The turn signals can be used to indicate that the vehicle has been locked/unlocked with the remote key. These settings can also be changed in the center display's Top view by going to:

**Settings → My Car → Locking → Visible Locking Feedback.**

## Exterior confirmation

- Locking: the turn signals flash once and the door mirrors will fold in (retract)<sup>12</sup>
- Unlocking: the turn signals flash twice and the door mirrors will fold out<sup>12</sup>

When the vehicle is locked, confirmation will only be given if all doors/tailgate and the hood are closed.

If the vehicle is locked while only the driver's door is closed<sup>13</sup>, all doors/tailgate will lock but confirmation will only be given when all doors/tailgate/hood are closed.

## Interior confirmation

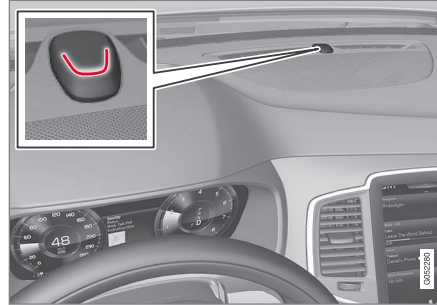

Lock and alarm indicator light on the dashboard

A long flash indicates the vehicle is locked. While the vehicle is locked, the indicator will flash briefly.

LEDs in the lock buttons on the doors illuminate when the doors are locked.

## Indicators in the interior lock buttons

### Lock buttons in the front doors



Front door lock button and indicator light

Indicator lights on: all doors are locked.

If a door is opened, the lights in both doors will go out.

<sup>12</sup> Models with electrically retractable door mirrors only.

<sup>13</sup> This does not apply to vehicles equipped with the optional keyless Passive Entry system.

◀◀ **In all doors**



Rear door lock button and indicator light

Indicator light in the respective door on: that door is locked. If a door is opened, the light in that door will turn off but the other indicator lights will remain on.

**Confirmation alternatives**

Various alternatives for locking/unlocking confirmation can be selected in the center display.

1. Tap **Settings** in the center display's Top view.
2. Tap **My Car** → **Locking**.
3. Change the settings under **Visible Locking Feedback**.

**Related information**

- Locking/unlocking from outside the vehicle (p. 233)
- Home safe lighting (p. 150)
- Adjusting the power door mirrors (p. 102)

**Locking/unlocking the tailgate**

The tailgate can be locked/unlocked in different ways, depending on whether the vehicle is equipped with the optional keyless Passive Entry system.

**Unlocking with the remote key**



Remote key tailgate button

1. Press the  button on the remote key.
  - > The tailgate will be unlocked but remain closed. The alarm indicator on the dashboard will go out to indicate that the tailgate alarm is no longer armed. The other doors will remain locked and the alarm will remain armed for them.
2. Open the tailgate.
  - > If the tailgate is not opened within two minutes, it will relock and the alarm will rearm.

## Keyless unlocking\*

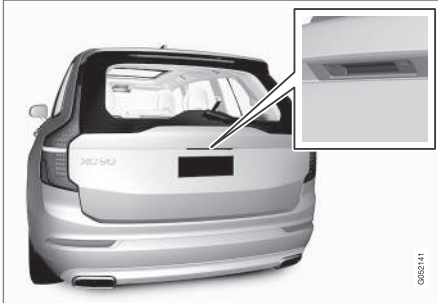

Rubberized pressure plate

### Opening the tailgate:

1. With the remote key in your possession, unlock the tailgate by pressing lightly on the rubberized pressure plate under the outer tailgate handle. If the remote key is not detected, the tailgate cannot be unlocked/opened. Three audible signals will sound.
2. Lift the handle to open the tailgate fully.

### **!** CAUTION

- When pressing the rubberized pressure plate, only light pressure is necessary to release the tailgate's electronic locking mechanism.
- When opening the tailgate, pull it up using the handle. Too much pressure on the rubberized pressure plate can damage its electrical connections.

### **!** WARNING

Avoid driving with the tailgate open if at all possible. Doing so could allow exhaust gases to enter the passenger compartment.

### Unlocking the tailgate from inside the vehicle



Tailgate unlock button

To unlock the tailgate:

- Press the  button on the lighting panel.
  - > The tailgate will unlock and can be opened within two minutes (if the vehicle has been locked from the inside).

### Locking with the remote key



- Press the  button on the remote key.
  - > The alarm indicator on the dashboard will begin to flash to show that the alarm has been armed.

### Related information

- Remote key (p. 227)
- Power tailgate\* (p. 240)
- Foot movement tailgate operation\* (p. 232)
- Remote key's range (p. 229)

## Power tailgate\*

The optional power tailgate can be opened/closed in several ways.

The power tailgate can be opened/closed using the  button on the lighting panel in the passenger compartment, the  on the remote key, by moving your foot under a sensor under the rear bumper\* or manually.

### WARNING

When operating the tailgate manually, do not use force to open or close it. This could result in injury.



Buttons in the lower edge of the tailgate



Button on the lighting panel in the passenger compartment

## Opening the tailgate



The power tailgate can be opened electrically by:

- Pressing and holding the  button on the lighting panel until the tailgate begins to open.
- Pressing and holding the  button on the remote key until the tailgate begins to open.
- Pressing lightly on the rubber-covered button under the tailgate's outside handle.
- Moving your foot under a sensor under the rear bumper\*.

## Closing the tailgate

The tailgate can be closed by moving your foot under a sensor beneath the rear bumper\*, by pressing the button on the lighting panel, with the remote key or by pressing the button on the lower edge of the tailgate\*<sup>14</sup>

To close the tailgate<sup>15</sup>:



- Press the  button on the lighting panel or on the  button on the remote key.
- > The tailgate will close automatically and audible signal will sound. **This will not lock the tailgate.**



Buttons on the lower edge of the tailgate

<sup>14</sup> Models equipped with the optional Passive Entry system have a button to close the tailgate and a button to close and lock the tailgate.

<sup>15</sup> See also the article "Foot movement tailgate opening/closing."

- Press the  button<sup>14</sup> on the lower edge of the tailgate.
  - > The tailgate will close automatically but will **not be locked**.
- Press the  button<sup>14</sup> on the lower edge of the tailgate.
  - > The tailgate will close automatically. The tailgate and doors will also be **locked** and the alarm will be armed.

If the remote key is not close enough to the tailgate, automatic locking/unlocking/opening/closing will not be possible. Three short audible signals will sound.

### Interrupting opening/closing

- This can be done in five ways:
  - Press the button on the lighting panel
  - Press the button on the remote key
  - Press either of the buttons on the lower edge of the tailgate
  - Press lightly on the rubber-covered button under the tailgate's outside handle
  - Move your foot under a sensor beneath the rear bumper\*
- > The tailgate will stop moving

### Programming the tailgate's maximum opening angle

The tailgate's maximum opening angle can be programmed, for example, if the tailgate has to be opened in a garage with a low ceiling.

Programming the opening angle:

- Open the tailgate manually to the desired angle and press and hold the closing button on the tailgate's lower edge for at least 3 seconds. Release the tailgate.
  - > Two audible signals will sound to indicate that the selected opening angle has been stored.

Erasing tailgate programming

- Open the tailgate manually to its highest position and press and hold the closing button on the tailgate's lower edge for at least 3 seconds. Release the tailgate.
  - > Two audible signals will sound to indicate that the programmed opening angle has been erased.

### NOTE

If the tailgate has been opened and closed continuously too long, the automatic function will be deactivated to avoid overloading the electrical system. The automatic function can be used again after approximately 2 minutes.

If the vehicle's battery has been discharged or disconnected, or if the tailgate has been open for more than 24 hours, the tailgate must be opened and closed once manually to reset the system.

### Pinch protection

If the tailgate is obstructed when being opened/closed, a pinch protection mechanism is activated.

- While opening: the tailgate will stop moving and an audible signal will sound.
- While closing: the tailgate will stop and return to the currently programmed maximum opening position. An audible signal will sound.

### WARNING

Pay attention to the risk of injury when opening/ closing the tailgate. Before opening/ closing: Make sure that no one is in the path of the tailgate as an injury could occur.

<sup>14</sup> Models equipped with the optional Passive Entry system have a button to close the tailgate and a button to close and lock the tailgate.

## ◀ Preloaded springs

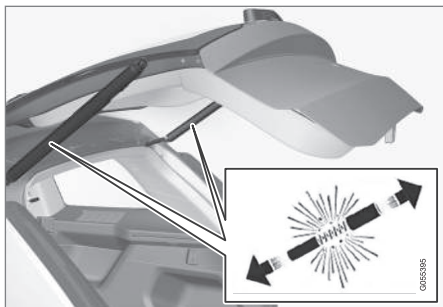

Preloaded springs for the power tailgate

### **⚠ WARNING**

Never touch or attempt to access the preloaded springs for the power tailgate. Doing so could result in serious injury.

### Related information

- Remote key's range (p. 229)
- Locking/unlocking from outside the vehicle (p. 233)
- Foot movement tailgate operation\* (p. 232)

## Private (valet) locking

The glove compartment and the tailgate can be locked when e.g., the vehicle is in a workshop for service, etc.

### Activating private locking/setting a security code

The ignition has to be in at least mode I in order to activate private locking.

1. Private locking can be activated from the center display's Function view or under Settings in Top view:
    - In Function view, tap **Private Locking**.
    - In Top view, tap **Settings** and then tap **My Car → Locking**. Tap the **Private Locking** box.
- > A pop-up window will appear.

### **i NOTE**

- A security code has to be selected the first time this function is used. This code is used to deactivate any previously used PIN codes. Keep this code in a safe place.
- If private locking is activated and the vehicle is unlocked using Volvo On Call or the Volvo On Call mobile app, it will be automatically deactivated.

2. Enter the code to be used to unlock the glove compartment and tailgate and tap **Confirm**.
  - > The glove compartment and tailgate will lock. Confirmation is provided by a green indicator light in the button in Function view and an X in the private locking box under Top view's Settings.

### Deactivating private locking

1. This function can be deactivated from the center display's Function view or under Settings in Top view:
  - In Function view, tap **Private Locking**.
  - In Top view, tap **Settings** and then tap **My Car → Locking**. Tap (deselect) the **Private Locking** box.

> A pop-up window will appear.
2. Enter the code used for locking and tap **Confirm**.
  - > The glove compartment and tailgate will unlock. Confirmation is provided when the green indicator light in the button in Function view goes out and the X in the private locking box under Top view's Settings disappears.



### Related information

- Locking/unlocking the tailgate (p. 238)
- Using the glove compartment (p. 211)
- Navigating in the center display's views (p. 38)

### Locking/unlocking with the detachable key blade

The detachable key blade can be used to e.g., unlock the driver's door from the outside if, for example, the remote key's battery is weak.

#### Unlocking

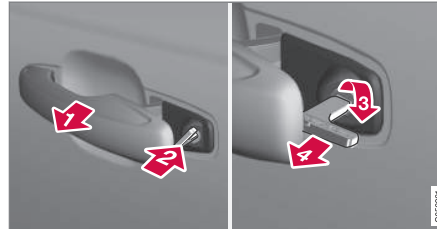

- 1 Pull out the driver's door handle as far as possible to access the lock cylinder.
- 2 Remove the key blade from the remote key and insert it into the lock cylinder.
- 3 Turn it clockwise 45 degrees so that the key blade points straight rearward.
- 4 Turn the key blade back 45 degrees to its original position. Remove the key blade from the lock cylinder and release the door handle.
5. Pull the door handle again to open the door.
  - > This will trigger the alarm.

Lock the door in the same way, but turn the key in step 3 counterclockwise.

#### Turning off the alarm



Backup key reader under the tunnel console cup holders

To turn off the alarm:

1. Place the remote key in the cup holder (on the key symbol) in the tunnel console (see the illustration).
2. Turn the start knob to **START** and release it.
  - > The start knob will return to its original position and the alarm will be turned off.

#### Locking

If necessary, the vehicle can be locked by inserting the detachable key blade into the lock cylinder in the driver's door.

Each of the other doors has a lock mechanism that must be pressed in using the key blade so that the door cannot be opened from the outside. The doors can still be opened from the inside.



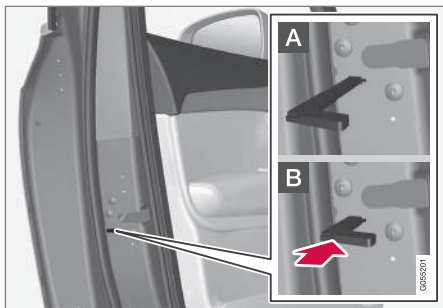

Manually locking a door (this is not the child safety lock)

- Remove the detachable key blade from the remote key. Insert it into the opening for the lock mechanism and press it in as far as possible.

- A** The door can be opened from inside and the outside.
- B** The door cannot be opened from the outside. To override the locking function, open the door from the inside.

The doors can also be unlocked by pressing the unlock button on the remote key or by pressing the unlock button on the driver's door panel.

**i NOTE**

If the child safety locks are activated for the rear doors and the mechanical locking mechanism has also been activated with the key blade, it will not be possible to open these doors from the inside or the outside.

To unlock, use the central unlocking button on either of the front doors or the unlock button on the remote key.

**Related information**

- Detachable key blade (p. 231)

**Automatically arming/disarming the alarm**

Automatically arming the alarm helps prevent inadvertently leaving the vehicle without alarm protection.

If the vehicle has been unlocked with the remote key (and the alarm has been disarmed) but no door or the tailgate has been opened within 2 minutes, the vehicle will automatically relock and the alarm will re-arm.

In certain markets, the alarm will be re-armed automatically after a slight delay after the driver's door has been opened and closed without being locked.

**Related information**

- Alarm (p. 245)
- Deactivating the alarm without a functioning remote key (p. 246)

## Alarm

The alarm system provides a warning if an attempt is made to break into the vehicle.

The following conditions will trigger the alarm:

- a door/hood/tailgate are opened
- the battery is disconnected
- the alarm siren is disconnected



If a problem is detected in the alarm system, this symbol and **Alarm system failure Service required** will be displayed in the instrument panel.

Do not attempt to repair any of the components in the alarm system yourself; this could affect the insurance policy on the vehicle. Contact a trained and qualified Volvo service technician.

### **i** NOTE

One of the alarm sensors, which is sensitive to metallic objects, is located under the tunnel console cup holders. Avoid leaving coins, keys, etc., in the cup holders because they may inadvertently trigger the alarm.

## Arming the alarm

- Lock the vehicle by pressing the remote key's lock button. On models with the optional Passive Entry system, the vehicle can also be locked by pressing the outer indentation for locking on one of the door handles or by pressing the tailgate's rubberized pressure plate.

If the vehicle is equipped with a power tailgate\*, the button on the lower edge of the tailgate can also be used to lock the vehicle and arm the alarm.

## Disarming the alarm

The alarm can be disarmed by:

- Unlock the vehicle by pressing the remote key's unlock button
- Pressing the pressure-sensitive area on the inside of one of the door handles on models with the optional Passive Entry system.
- Pressing the tailgate's rubberized pressure plate on models with the optional Passive Entry system.

## Turning off a triggered (sounding) alarm

- Press the remote key's unlock button or put the ignition in mode **I** by turning the start knob to **START** and releasing it.

## Alarm signals

The following occurs if the alarm has been triggered:

- A siren will sound for 30 seconds or until the alarm is turned off
- All turn signals flash for 5 minutes or until the alarm is turned off

If the door that triggered the alarm is left open, the alarm cycle will be repeated 10 times.

## Alarm indicator

A red indicator light on the upper side of the dashboard shows the alarm's status:

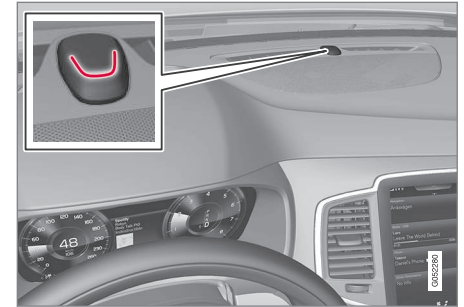

- Indicator off: the alarm is disarmed
- Indicator flashes once every two seconds: the alarm is armed
- Indicator flashes quickly after the alarm has been disarmed (max. 30 seconds) or until



- ◀◀ the ignition has been put in mode **I** (turn the start knob to **START** and release it): the alarm has been triggered

**Related information**

- Automatically arming/disarming the alarm (p. 244)
- Deactivating the alarm without a functioning remote key (p. 246)

**Deactivating the alarm without a functioning remote key**

If the remote key is not functioning properly, the alarm can be turned off and the vehicle can be started as follows:

1. Unlock and open the driver's door with the detachable key blade.  
> This will trigger the alarm.



Location of the back-up key reader in the cup holder

2. Place the remote key on the back-up key reader in the tunnel console's cup holder.
3. Turn the start knob to **START** and release it.  
> The alarm will turn off.

**Related information**

- Alarm (p. 245)
- Detachable key blade (p. 231)
- Starting the engine (p. 382)
- Automatically arming/disarming the alarm (p. 244)

**Child safety locks**

Child safety locks help prevent children from inadvertently opening one of the rear doors from inside the vehicle.

**Electronic\* activation/deactivation**

The electronic child safety locks can be activated/deactivated as long as the ignition is not completely switched off and this can be done for up to two minutes after the engine has been switched off if no door has been opened.

To activate:



Child safety lock button on the driver door control panel

1. Switch on the ignition or start the engine.

2. Press the button on the driver's door control panel.

- > **Rear child lock Activated** will be displayed in the instrument panel and the indicator light in the button will illuminate to show that the child safety locking function is activated.



While the child safety locks are activated:

- the rear door windows can only be opened from the driver door control panel
- the rear doors cannot be opened from the inside

To deactivate:

- Press the button in the driver door control panel.
  - > **Rear child lock Deactivated** will be displayed in the instrument panel and the indicator light in the button will go out to show that the child safety locking function is deactivated.

When the ignition is switched off, the current setting for the child safety locks will be stored. If the locks were activated at that time, they will continue to be activated when the ignition is switched on again.

Symbol	Message	Explanation
	<b>Rear child lockActivated</b>	The rear-door child safety locks are activated.
	<b>Rear child lockDeactivated</b>	The rear-door child safety locks are deactivated.

### Manual activation/deactivation

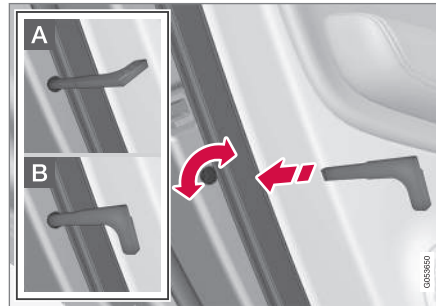

Manual child safety locks in the rear doors

- Use the detachable key blade in the remote key to adjust these controls.

- A** The rear doors can only be opened from the outside.
- B** The rear doors can be opened from the inside or the outside.

### **i** NOTE

- Each control on the respective doors control that door only, not both doors.
- There are no manual child safety locks on models equipped with the electronic option.

### Related information

- Detachable key blade (p. 231)
- Ignition modes (p. 380)

## Start and lock system type designations

The following information contains type designations for the start and lock system.

### Alarm system

USA FCC ID: MAYDA 5823(3)

This device complies with part 15 of the FCC rules. Operation is subject to the following conditions: (1) This device may not cause harmful interference, and (2) this device must accept any interference received, including interference that may cause undesired operation.

Canada IC: 4405A-DA 5823(3)

This device is subject to the following conditions: (1) this device may not cause interference, and (2) this device must accept any interference, including interference that may cause undesired operation of the device.

### Remote keys (Passive entry/Passive start\*) USA

Volvo Standard Key FCC ID: YGOHUF8423

Volvo Tag ID FCC ID: YGOHUF8432

This device complies with Part 15 of the FCC Rules. Operation is subject to the following two conditions:

(1) This device may not cause harmful interference, and

(2) this device must accept any interference received, including interference that may cause undesired operation.

Any changes or modification not expressly approved by the party responsible for compliance could void the user's authority to operate this equipment.

### Canada

Volvo Standard Key IC: 4008C-HUF8423

Volvo Tag ID IC: 4008C-HUF8432

This device complies with Industry Canada licence-exempt RSS standard(s). Operation is subject to the following two conditions:

(1) This device may not cause harmful interference, and (2) this device must accept any interference received, including interference that may cause undesired operation.

### Immobilizer and Passive entry/Passive start\* systems

USA-FCC ID: LTQV03134

This device complies with Part 15 of the FCC Rules. Operation is subject to the following two conditions:

(1) This device may not cause harmful interference, and

(2) this device must accept any interference received, including interference that may cause undesired operation.

Any changes or modification not expressly approved by the party responsible for compliance could void the user's authority to operate this equipment.

Canada-IC:3659A-VO3134

This device complies with Industry Canada licence-exempt RSS standard(s). Operation is subject to the following two conditions:

(1) This device may not cause harmful interference, and (2) this device must accept any interference received, including interference that may cause undesired operation.

### Related information

- Alarm (p. 245)
- Remote key (p. 227)

DRIVER SUPPORT

## Driver support systems

The vehicle is equipped with a number of driver support systems that help provide the driver with active/passive support.

Some of these systems are standard while others are optional and they are designed to e.g., help the driver maintain a set speed or a set distance to a vehicle ahead, or warn the driver of a potential collision situation and in certain cases apply the brakes if necessary. Certain optional systems can also assist in various parking situations.

### Related information

- Adjustable steering force\* (p. 250)
- Electronic Stability Control (ESC) (p. 251)
- Roll stability control (RSC) (p. 255)
- Speed limiter (SL)\* (p. 255)
- Distance Alert\* (p. 267)
- Cruise Control (CC) (p. 262)
- Adaptive Cruise Control (ACC)\* (p. 269)
- Pilot Assist\* (p. 283)
- Driver support system radar sensor (p. 296)
- Driver support system camera (p. 300)
- City Safety™ (p. 304)
- Blind Spot Information (BLIS)\* (p. 317)
- Cross Traffic Alert (CTA)\* (p. 319)
- Road Sign Information (RSI)\* (p. 324)

- Driver Alert Control (DAC) (p. 326)
- Driving lane assistance (p. 328)
- Run-off Mitigation (p. 333)
- Park Assist\* (p. 336)
- Park Assist Camera (PAC)\* (p. 340)
- Park Assist Pilot (PAP)\* (p. 346)

## Adjustable steering force\*

Steering force increases with the speed of the vehicle to give the driver an enhanced sense of control and stability. At low speed the vehicle is easier to steer in order to facilitate parking, etc.

### Changing the steering force level

To change the level of steering force, see the information under the heading "individual" in article "Drive modes" for additional information.

On models not equipped with the drive mode control in the center console, the selection is made in the center display's Top view under:

**Settings → My Car → Drive Modes → Steering force**

<b>i NOTE</b>
<ul style="list-style-type: none"><li>• This steering force level menu function cannot be accessed when the vehicle is in motion.</li><li>• In certain situations, the power steering function may become too hot and must be temporarily cooled. During cooling, power steering effect will be reduced and more force may be necessary to turn the steering wheel and a message will be displayed in the instrument panel.</li></ul>



## Related information

- Driver support systems (p. 250)
- Drive modes\* (p. 384)

## Electronic Stability Control (ESC)

Electronic Stability Control (ESC) helps reduce wheel spin, counteract skidding and to generally help improve directional stability.



A pulsating sound will be audible when the system is actively operating and is normal. Acceleration may also be slightly slower than normal.

### **WARNING**

ESC is a supplementary aid and cannot deal with all situations or road conditions.

The driver is always responsible for operating the vehicle in a safe manner in accordance with current traffic regulations.

ESC consists of the following functions:

- Traction control
- Spin control
- Active Yaw Control
- Engine Drag Control
- Trailer Stability Assist

### Traction control

This function is designed to help reduce wheel spin by transferring power from a drive wheel that

begins to lose traction to the wheel on the opposite side of the vehicle (on the same axle).

### Spin control

This function is designed to help prevent the drive wheels from spinning while the vehicle is accelerating.

### Active Yaw Control

At low speeds, this function helps maintain directional stability by braking one or more of the wheels if the vehicle shows a tendency to skid or slide laterally.

### Engine Drag Control EDC

EDC helps keep the engine running if the wheels show a tendency to lock, e.g., when shifting down in the manual shifting mode or while using the engine's braking function on a slippery surface. If the wheels were to lock, the vehicle would become more difficult to steer.

### Trailer Stability Assist\*<sup>1</sup>

TSA helps stabilize a vehicle that is towing a trailer when the vehicle and trailer have begun to sway.

This system is automatically deactivated if the driver selects **Sport** mode.

<sup>1</sup> This function is included if the vehicle is equipped with a Volvo original trailer hitch.



◀◀ **Related information**

- Detachable trailer hitch\* (p. 378)
- Driving with a trailer (p. 376)
- Trailer Stability Assist (TSA) (p. 379)
- Electronic Stability Control (ESC) sport mode (p. 252)
- Electronic Stability Control (ESC) symbols and messages (p. 253)

### **Electronic Stability Control (ESC) sport mode**

ESC is always activated and cannot be switched off.

However, the driver can select **Sport** mode, which offers more active driving characteristics.

In **Sport** mode, the engine management system monitors movement of the accelerator pedal and steering wheel for sportier driving and allows more lateral movement of the rear wheels before ESC is triggered.

Under certain circumstances, such as when driving with snow chains, or driving in deep snow or loose sand, it may be advisable to temporarily use **Sport** mode for maximum tractive force.

If the driver releases pressure on the accelerator pedal, ETC will also activate to help stabilize the vehicle.

### **Activating/deactivating Sport mode**



In the center display's Function view, tap **ESC Sport Mode**. The green indicator light in the button will illuminate to show that the function has been activated or gray when the function is deactivated.







When **Sport** mode is activated, this symbol will illuminate in the instrument panel. It will remain on until the driver deactivates the function. ETC will also return to normal mode when the engine is restarted.

### **Related information**

- Electronic Stability Control (ESC) (p. 251)

## Electronic Stability Control (ESC) symbols and messages

Symbol	Message	Description
	Steady glow for 2 seconds when the engine is started.	The system is performing a self-diagnostic test.
	Flashing symbol.	ESC is actively functioning to help counteract wheel spin and/or a skid.
	Steady glow.	<b>Sport</b> mode has been activated. Please note that ESC is not deactivated at this time but its functionality is reduced.
	<b>ESC</b> Temporarily off	See the message in the instrument panel.



Symbol	Message	Description
	<b>ESC Temporarily off</b>	The ESC system function has been temporarily reduced due to high brake disc temperature. The function reactivates automatically when the brakes have cooled.
	<b>ESC Service required</b>	<p>The ESC system is not functioning properly.</p> <ul style="list-style-type: none"> <li>• Stop the vehicle in a safe place, turn off the engine and restart it.</li> <li>• If the message is still displayed when the engine has restarted, drive to an authorized Volvo workshop to have the system inspected.</li> </ul>

### **WARNING**

The stability system is intended to help improve driving safety. It supplements, but can never replace, the driver's judgment and responsibility when operating the vehicle. Speed and driving style should always be adapted to traffic and road conditions.

### **Related information**

- Electronic Stability Control (ESC) (p. 251)

## Roll stability control (RSC)

Volvo's Roll Stability Control (RSC) is a stability system designed to help minimize the risk of a rollover in emergency maneuvers or if a skid should occur.

RSC registers the amount of change in the lateral angle at which the vehicle is leaning. Using this information, RSC calculates the likelihood of a rollover. If there is an imminent risk of a rollover, the stability system is activated, power to the engine is cut and the brakes are applied to one or more of the wheels until the vehicle regains stability.

### WARNING

The vehicle's stability systems, including RSC, do not replace the driver's responsibility for operating the vehicle in a safe manner. Speed and driving style should always be adapted to the current road, traffic and weather conditions. Posted speed limits should always be respected.

### Related information

- Electronic Stability Control (ESC) (p. 251)
- General safety information (p. 56)



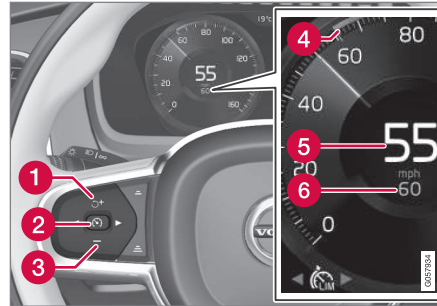

## Speed limiter (SL)\*

The Speed Limiter (SL) is a feature that helps prevent the driver from exceeding a preset maximum speed.

### Overview



Function buttons and symbols (generic illustration)

- 1  SL switches from standby mode to active mode and the set maximum speed will be used
- 1  Increases the set maximum speed
- 2  **From standby mode**, press to put SL in active mode and set the current speed as the maximum or **from active mode**, press to put SL in standby mode (the set maximum speed can be exceeded)
- 3  — Decreases the set maximum speed

- 4 Set maximum speed indicator
- 5 The vehicle's current speed
- 6 The set maximum speed

### WARNING

- The Speed Limiter cannot cover all driving situations and traffic, weather and road conditions.
- The vehicle must always be driven according to current traffic/road conditions.
- The driver must take action if SL does not maintain the set maximum speed.
- The driver is always responsible for operating the vehicle in a safe manner and observing posted speed limits.

### Limitations

On steep downslopes, the Speed limiter's braking capacity may not be sufficient and the set maximum speed may be exceeded. If this happens, **Speed limit exceeded** will be displayed in the instrument panel to alert the driver.

This message will appear if the set maximum speed is exceeded by more than approx. 2 mph (3 km/h).



#### ◀◀ Related information

- Starting and activating the Speed Limiter (SL)\* (p. 256)
- Deactivating/reactivating the Speed Limiter\* (p. 260)
- Changing a Speed Limiter (SL)\* maximum speed (p. 257)
- Automatic Speed Limiter (ASL)\* (p. 257)
- Activating/deactivating the Automatic Speed Limiter (ASL)\* (p. 259)
- Changing tolerance for the Automatic Speed Limiter (p. 259)
- Turning the Speed Limiter\* off (p. 261)

### Starting and activating the Speed Limiter (SL)\*

The Speed Limiter (SL) is a feature that has to be selected and activated in order to set a maximum speed.

#### Selecting SL (putting it in standby mode)

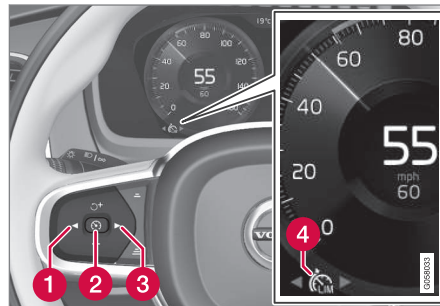



Function buttons and symbols

- Press ◀ (1) or ▶ (3) to scroll to the Speed Limiter (  ) function.
  - > The symbol (4) will be displayed in the instrument panel. This indicates that SL has been selected **and is in standby mode** (no maximum speed has been set).

### Activating SL (putting it in active mode and setting a maximum speed)

The engine must be running before SL can be put in active mode. The lowest maximum speed that can be set is 20 mph (30 km/h).

- With SL in standby mode (the  will be displayed), press the  button (2).
  - > This puts SL in active mode and sets the vehicle's current speed as the maximum speed.

#### Related information

- Speed limiter (SL)\* (p. 255)
- Deactivating/reactivating the Speed Limiter\* (p. 260)
- Changing a Speed Limiter (SL)\* maximum speed (p. 257)
- Automatic Speed Limiter (ASL)\* (p. 257)
- Activating/deactivating the Automatic Speed Limiter (ASL)\* (p. 259)
- Changing tolerance for the Automatic Speed Limiter (p. 259)
- Turning the Speed Limiter\* off (p. 261)

## Changing a Speed Limiter (SL)\* maximum speed

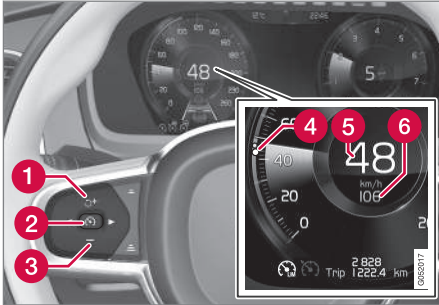

Function buttons and symbols

- Change a set maximum speed by pressing the **+** (1) or **-** (3) buttons briefly or by pressing and holding them:
  - **Press briefly:** changes the maximum speed in +/- 5 mph (+/- 5 km/h) increments. Each press changes the maximum speed by +/- 5 mph (+/- 5 km/h).
  - **Press and hold:** changes the maximum speed +/- 1 mph (+/- 1 km/h) at a time. Release the button when the indicator (4) has moved to the desired maximum speed.

## Limitations

When driving down steep hills, the Speed Limiter's braking effect may not be adequate and the set maximum speed may be exceeded. The message **Speed limit exceeded** will appear in the instrument panel to alert the driver.

### **i** NOTE

This message will appear if the maximum speed is exceeded by more than approx. 2 mph (3 km/h).

## Related information

- Speed limiter (SL)\* (p. 255)

## Automatic Speed Limiter (ASL)\*

Automatic Speed Limiter (ASL) helps the driver adapt the vehicle's maximum speed to the posted speed limits.

The Speed Limiter (SL) function can be switched to Automatic Speed Limiter.

Where applicable, ASL uses speed information from the Road Sign Information\* system to automatically adapt the vehicle's maximum speed.



### **⚠** WARNING

- ASL is a supplemental aid to the driver and does not function in all driving situations or in all traffic, weather or road conditions. It can never replace the driver's attention to traffic conditions or his/her responsibility for operating the vehicle in a safe manner.
- Even if the driver clearly sees a speed limit sign, the speed information from Road Sign Information to ASL may not be correct. The driver must adapt the vehicle's speed accordingly.

See also the article "Road Sign Information limitations".

### ◀◀ Is SL or ASL active?

Symbols in the instrument panel indicate which function is active:

Symbol	SL	ASL
 A	✓	✓
 Sign symbol <sup>B</sup> next to "70": ASL is activated.		✓

A WHITE symbol: the function is active, GRAY symbol: the function is in standby mode.  
 B See the section "ASL symbol" below for an explanation of the symbol's different colors.

#### The ASL symbol

 A road sign symbol (next to the stored speed in the center of the speedometer) can be displayed in three different colors as explained in the following table:

Road sign symbol's color	Explanation
Green/yellow	ASL is active
Gray	ASL is in standby mode
Amber/orange	ASL is temporarily in standby mode (e.g., because a speed limit sign could not be read)

#### ASL limitations

- ASL utilizes the speed limit information provided by the Road Sign Information\* system (RSI), **not** from the speed limit signs that the vehicle passes.
- If RSI cannot provide ASL with speed-related information, ASL will go into standby mode and switch to SL. The driver will have to react and adapt the vehicle's speed.
- ASL will reactivate when RSI is once again able to read a speed limit sign.

See also the article "Road Sign Information limitations".

#### Related information

- Speed limiter (SL)\* (p. 255)
- Activating/deactivating the Automatic Speed Limiter (ASL)\* (p. 259)
- Changing tolerance for the Automatic Speed Limiter (p. 259)

- Starting and activating the Speed Limiter (SL)\* (p. 256)
- Deactivating/reactivating the Speed Limiter\* (p. 260)
- Road Sign Information (RSI)\* (p. 324)
- Road Sign Information (RSI)\* limitations (p. 326)



## Activating/deactivating the Automatic Speed Limiter (ASL)\*

The function Automatic Speed Limiter (ASL) is a supplement to the Speed Limiter (SL) and can be activated/deactivated.



ASL is activated/deactivated in the center display's Function view.

### Activating ASL

With SL activated:

1. Tap the **Speed Sign Assist** button in the center display's Function view.
  - > ASL will go into standby mode and a green indicator light in the button will illuminate. A road sign symbol will be displayed in center of the speedometer.
2. Press the  button on the left-side steering wheel keypad.
  - > ASL will be activated with the vehicle's current speed.

### Deactivating ASL

- Tap the **Speed Sign Assist** button in the center display's Function view.
  - > ASL will be deactivated, the indicator will be GRAY and the Speed limiter (SL) will be activated.

### WARNING

After switching from ASL to SL, the vehicle will no longer adapt speed to posted speed limits. It will only limit the vehicle's maximum speed.

### Related information

- Speed limiter (SL)\* (p. 255)
- Automatic Speed Limiter (ASL)\* (p. 257)

## Changing tolerance for the Automatic Speed Limiter

Automatic Speed Limiter can be set to different tolerance levels.

### Posted speed limit tolerance

ASL can be set to allow the vehicle to drive above or below the posted speed limit. For example, if the current posted speed limit is 43 mph (70 km/h), the driver can opt to allow the vehicle to drive at a speed of 47 mph (75 km/h).

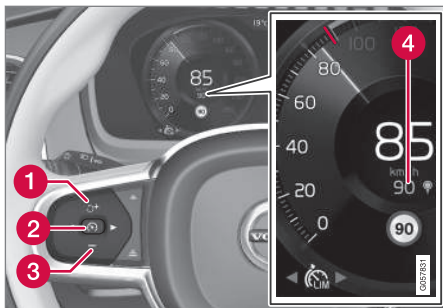

Function buttons and symbols (generic illustration)

- Press the **+** button (1) until 43 mph (70 km/h) has changed to 47 mph

(75 km/h) in the center of the speedometer (4).

- > The vehicle will then use the selected tolerance +4 mph (+5 km/h) until the vehicle passes a sign with a lower or higher speed limit. The vehicle will then adjust to the new maximum speed and the set tolerance will be deleted from the system's memory.

If the Road Sign Information\* system is activated, the posted speed limit will be indicated by a RED marker on the speedometer's speed scale.

The set tolerance can be adjusted in the same way as the Speed Limiter's set maximum speed.

**NOTE**

The greatest tolerance that can be set is +/- 5 mph (10 km/h).

**Related information**

- Automatic Speed Limiter (ASL)\* (p. 257)
- Activating/deactivating the Automatic Speed Limiter (ASL)\* (p. 259)
- Road Sign Information (RSI)\* (p. 324)
- Changing a Speed Limiter (SL)\* maximum speed (p. 257)

**Deactivating/reactivating the Speed Limiter\***

The Speed Limiter (SL) can be temporarily deactivated and put in standby mode.

**Deactivating and putting SL in standby mode**

To temporarily put the Speed Limiter in standby mode:

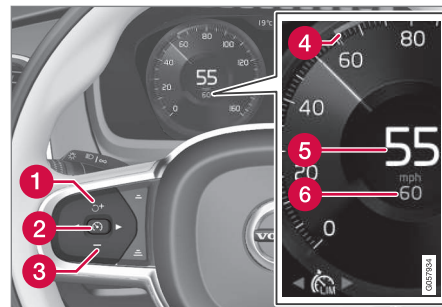

Function buttons and symbols

- Press the **SL** button (2).
- > The symbols in the instrument panel will change colors from WHITE to GRAY. This indicates that SL is temporarily in standby mode and will not limit the vehicle's maximum speed.

### Reactivating SL from standby mode

To reactivate SL after it has temporarily been put in standby mode:

- Press the  button (1).
  - > The maximum speed marker (4) and symbols will change colors to WHITE and the vehicle's maximum speed will be limited to the previously set maximum speed.

or

- Press the  button (2).
  - > The symbols will change colors from GRAY to WHITE and the vehicle's current speed will be set as the maximum speed.

### Increasing the speed with the accelerator pedal

The set maximum speed can be temporarily exceeded using the accelerator pedal without putting SL in standby mode, for instance when quick acceleration is required.

1. Press the accelerator pedal as far down as possible and release it when the vehicle has reached the desired speed.
  - > SL remains activated (the symbols in the instrument panel will remain WHITE).
2. Release the accelerator pedal when the temporary acceleration is completed.
  - > The vehicle will slow down and its speed will remain under the set maximum speed.

### Related information



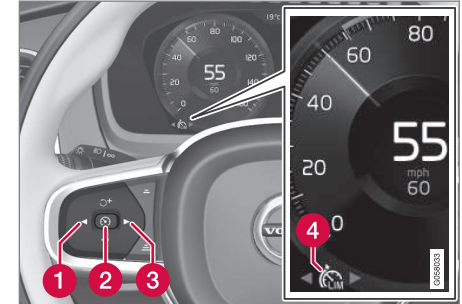

- Speed limiter (SL)\* (p. 255)
- Starting and activating the Speed Limiter (SL)\* (p. 256)

### Turning the Speed Limiter\* off

The Speed Limiter (SL) can be turned off.



Function buttons and symbols

1. Press the  button (2).
  - > SL will go into standby mode.
2. Press the  (1) or  (3) buttons to select another function.
  - > The SL symbol (4) in the instrument panel will go out and the set maximum speed will be erased from the system's memory.
3. Press the  button (2) again.
  - > The newly selected function will be activated.

### Related information

- Speed limiter (SL)\* (p. 255)
- Starting and activating the Speed Limiter (SL)\* (p. 256)

## Cruise Control (CC)

Cruise Control (CC) is designed to assist the driver by maintaining a set speed. It is primarily intended for use on long straight roads in steady traffic, such as on highways and other main roads in smoothly flowing traffic.

### Overview

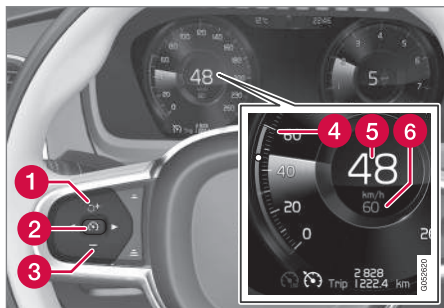

Function buttons and symbols (generic illustration)

- 1 Increases the set speed or CC switches from standby mode to active mode
- 1 The set speed will be resumed
- 2 Press to put CC in active mode and set the current speed or from active mode, press to put CC in standby mode
- 3 Decreases the set speed
- 4 Set speed indicator

- 5 The vehicle's current speed
- 6 The set speed

In models equipped with the optional Adaptive Cruise Control (ACC), the driver can toggle between CC and ACC – see the article "Switching between Cruise Control and Adaptive Cruise Control".

### WARNING

- The vehicle must always be driven according to current traffic/road conditions. The driver must take action if CC does not maintain a suitable speed and/or distance to other vehicles.
- The driver is always responsible for operating the vehicle in a safe manner.

### Related information

- Starting and activating Cruise Control (p. 262)
- Changing Cruise Control speed (p. 263)
- Deactivating/resuming Cruise Control (CC) (p. 264)
- Turning Cruise Control off (p. 265)
- Adaptive Cruise Control (ACC)\* (p. 269)
- Switching between Cruise Control and Adaptive Cruise Control\* (p. 266)

## Starting and activating Cruise Control

Cruise Control (CC) must be selected and activated before it can regulate the vehicle's speed.

### Selecting CC (putting it in standby mode)

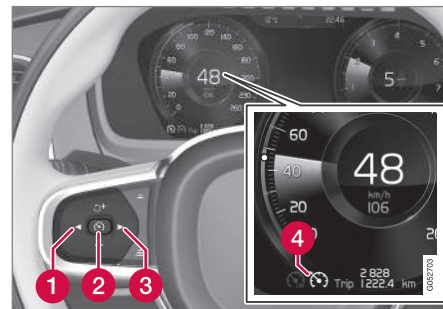



Function buttons and symbols

- Press (1) or (3) to scroll to the CC function.
- > The symbol (4) will be displayed in the instrument panel. This indicates that CC has been selected and can then be activated to maintain a set speed.

**NOTE**

Before CC can be activated, the vehicle's speed must be at least 20 mph (30 km/h). This is also the lowest speed that can be set.

**Activating CC (putting it in active mode and setting a speed)**

- With the  symbol displayed (CC is in standby mode), press the  button (2) on the left-side steering wheel keypad.
  - > This puts CC in active mode and will maintain the vehicle's current speed.

**Related information**

- Cruise Control (CC) (p. 262)
- Switching between Cruise Control and Adaptive Cruise Control\* (p. 266)
- Deactivating/resuming Cruise Control (CC) (p. 264)
- Turning Cruise Control off (p. 265)

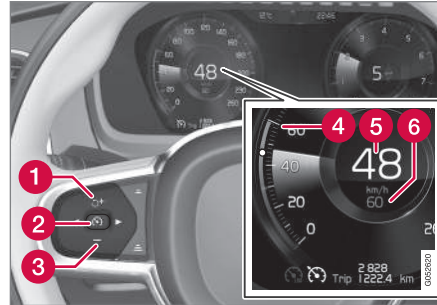
**Changing Cruise Control speed****Changing a set speed**

Function buttons and symbols (generic illustration)

- Change a set speed by pressing the **+** (1) or **-** (3) buttons briefly or by pressing and holding them:
  - **Press briefly:** changes speed in  $\pm 5$  mph ( $\pm 5$  km/h) increments. Each press changes the vehicle's speed by  $\pm 5$  mph ( $\pm 5$  km/h).
  - **Press and hold:** changes the speed  $\pm 1$  mph ( $\pm 1$  km/h) at a time. Release the button when the set speed indicator (4)/(6) has moved to the desired speed.

If speed is increased by pressing the accelerator pedal before the **+** button is pressed, the vehicle's speed when the button is pressed will

become the set speed assuming that the accelerator pedal is still depressed when the button is pressed.

A temporary increase in speed, such as when passing another vehicle, does not affect the CC set speed. The vehicle will return to the set speed when the accelerator pedal is released. Always observe posted speed limits.

**Engine braking instead of applying the brakes**

CC regulates speed by applying the brakes lightly. To avoid a loss of speed when driving down hills, use the engine braking function instead of letting the CC apply the brakes. In this situation, the driver can temporarily deactivate the CC braking function.

To do so:

- Press the accelerator pedal approx. halfway down and release it.
  - > CC will automatically deactivate the automatic brake function and will then only use the engine braking function.

**Related information**

- Cruise Control (CC) (p. 262)

## Deactivating/resuming Cruise Control (CC)

Cruise Control (CC) can be temporarily deactivated and put in standby mode.

### Deactivating and putting CC in standby mode

To temporarily deactivate and put Cruise Control in standby mode:

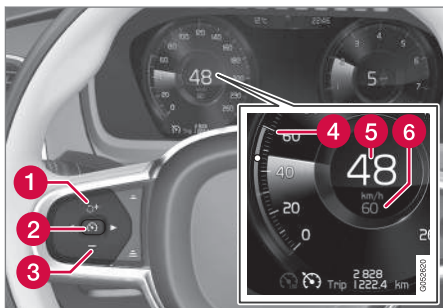

Function buttons and symbols (generic illustration)

- Press the  button (2).
  - > The set speed marker (4) and symbols will change colors from WHITE to GRAY.

This indicates that CC is temporarily in standby mode and will not maintain a set speed.

### Standby mode due to action by the driver

CC is temporarily deactivated and put in standby mode if:

- the brakes are applied
- The gear selector is moved to **N**
- the vehicle is driven faster than the set speed for more than 1 minute.

In these cases, the driver will have to regulate the vehicle's speed.

A temporary increase in speed, such as when passing another vehicle, does not affect the CC set speed. The vehicle will return to the set speed when the accelerator pedal is released.

### Automatic standby mode

CC switches automatically to standby mode if:

- the wheels lose traction
- engine speed (rpm) is too high/low
- brake temperature is too high
- the vehicle's speed goes below approx. 20 mph (30 km/h)

In these cases, the driver will have to regulate the vehicle's speed.

### Reactivating CC from standby mode

To reactivate CC after it has temporarily been put in standby mode:

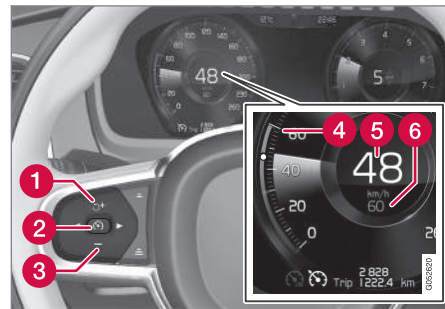

- Press the  button (1).
  - > The set speed marker (4) will change color from GRAY to WHITE. The vehicle will then return to the **most recently set speed**.

### **WARNING**

There may be a significant increase in speed after the  button has been pressed.

or

- Press the  button (2).
- > The set speed marker (4) and symbols will change colors from GRAY to WHITE. CC will then set and maintain the vehicle's **current** speed.

### Related information



- Cruise Control (CC) (p. 262)
- Starting and activating Cruise Control (p. 262)

## Turning Cruise Control off

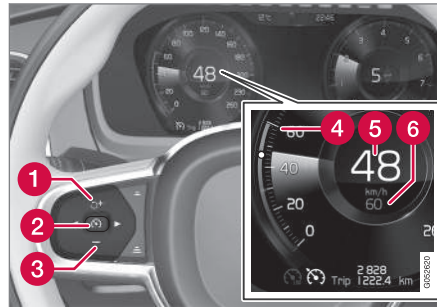
Cruise Control (CC) can be deactivated (turned off).



Function buttons and symbols

1. Press the  button (2) on the left-side steering wheel keypad.
  - > This puts CC in standby mode.
2. Press the ◀ or ▶ button to switch to another function.
  - > The Cruise Control symbol in the instrument panel  will go out.
3. Press the  button (2) again.
  - > Another function will be activated and the set speed in the CC system's memory will be erased.

In models equipped with the optional Adaptive Cruise Control (ACC), the driver can toggle

between CC and ACC – see the article "Switching between Cruise Control and Adaptive Cruise Control".



### Related information

- Cruise Control (CC) (p. 262)
- Starting and activating Cruise Control (p. 262)
- Switching between Cruise Control and Adaptive Cruise Control\* (p. 266)

## Switching between Cruise Control and Adaptive Cruise Control\*

In models equipped with the optional ACC, the driver can toggle between CC and ACC.



A symbol in the instrument panel will indicate which system is currently being used:

CC Cruise Control	ACC Adaptive Cruise Control
	

<sup>A</sup> If the symbol is WHITE, the function is active. If the symbol is GRAY, the function is in standby mode.

### Switching from ACC to CC

To switch from ACC to CC:

- Put ACC in standby mode with the  button on the left-side steering wheel keypad.
- From the center display's Function view, tap the **Cruise control** button. The button's indicator will change from GRAY to GREEN.
  - The symbol in the instrument panel will change from  (ACC) to  (CC) and CC is in standby mode (ready for use but not currently maintaining a set speed).

- Press the  button on the left-side steering wheel keypad.
  - CC goes into active mode and sets the vehicle's current speed.

### WARNING

Switching from ACC to CC means that:



- Your vehicle will **no longer** automatically maintain a set distance to a vehicle ahead.
- Only the set speed will be maintained and the driver will have to apply the brakes when needed.

If CC was activated when the engine was turned off, ACC will be selected and go into standby mode when the engine is restarted.

### Switching from CC to ACC

To switch from CC to ACC:

- Put CC in standby mode with the  button on the left-side steering wheel keypad.

- In the center display's Function view, tap the **Adaptive Cruise Control** button. The button's indicator will change from GREEN to GRAY.
  - The symbol in the instrument panel will change from  (CC) to  (ACC) and ACC is in standby mode (ready for use but not currently maintaining a set speed/time interval).
- Press the  button on the left-side steering wheel keypad.
  - ACC goes into active mode and sets the vehicle's current speed and the selected time interval to the vehicle ahead.

### Related information

- Cruise Control (CC) (p. 262)
- Adaptive Cruise Control (ACC)\* (p. 269)
- Center display overview (p. 28)



## Distance Alert\*

Distance Alert is a function that alerts the driver if the time interval to the vehicle ahead is too short.

Distance Alert is active at speeds above approximately 20 mph (30 km/h) and only reacts to a vehicle ahead that is driving in the same direction. No information is provided for vehicles driving toward you, moving very slowly, or at a standstill.

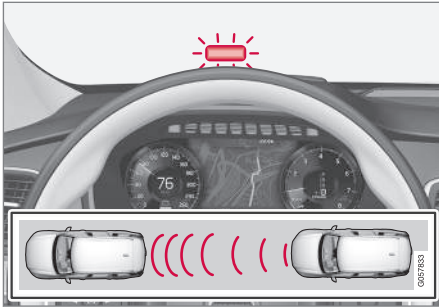

Warning light (generic illustration)

A warning light in the windshield glows steadily if your vehicle is closer to the one ahead than the set time interval.

### **i** NOTE

Strong sunlight, reflections, extreme light contrasts, the use of sunglasses, or if the driver is not looking straight ahead may make the visual warning signal in the windshield difficult to see.

### **i** NOTE

Distance Alert only monitors distance to the vehicle ahead while Adaptive Cruise Control is in standby mode or off.

### **⚠** WARNING

Distance Alert only indicates the distance to the vehicle ahead. It does not affect the speed of your vehicle.

## Head-up-display\*

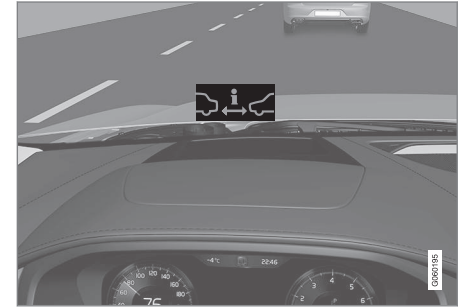

Distance Alert symbol in the windshield (generic illustration)

In vehicle is equipped with the head-up display\*, the symbol in the windshield will only appear if the distance to the vehicle ahead is shorter than the preset value. However, the **Show Driver Support** function has to be activated in the Settings menu. See the article "Head-up display" for additional information.

### **i** NOTE

Strong sunlight, reflections, extreme light contrasts, the use of sunglasses, or if the driver is not looking straight ahead may make the visual warning signal in the windshield difficult to see.



◀◀ **Related information**

- Distance Alert\* limitations (p. 269)
- Using Distance Alert\* (p. 268)
- Head-up display (HUD)\* (p. 116)
- Adaptive Cruise Control (ACC)\* (p. 269)

**Using Distance Alert\***

Distance Alert is used as follows:

**Operation**



Pull down the center display's Top view and select **Settings** followed by **Distance alert**. Tap to turn the function On or Off.

**Setting a time interval**

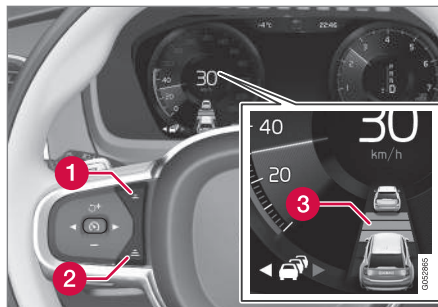

Controls for setting a time interval

- 1 Reduce the time interval
- 2 Increase the time interval
- 3 Distance/time indicator

- Press button (1) or (2) on the left-side steering wheel keypad to reduce or increase the time interval to the vehicle ahead.
- > The indicator (3) shows the current time interval.

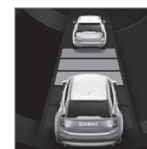

Different time intervals to the vehicle ahead can be selected and are shown in the instrument panel as 1–5 horizontal bars. The greater the number of bars, the longer the time interval.

One bar between the vehicles represents a time interval of approximately 1 second; 5 bars is approximately 3 seconds.

The same symbol appears if Adaptive Cruise Control is activated.

**i NOTE**

- The greater the vehicles' speed, the greater the **distance** between them for a set time interval.
- The set time interval is also used by Adaptive Cruise Control\*.
- Only use time intervals permitted by local traffic regulations.

**Related information**

- Distance Alert\* (p. 267)

## Distance Alert\* limitations

Distance Alert uses the same radar sensor as Adaptive Cruise Control\* and has several limitations.

### **⚠ WARNING**

- The radar sensor has a limited field of vision. In some situations it may detect a vehicle later than expected or not detect other vehicles at all.
- The radar sensor cannot cover all driving situations and traffic, weather and road conditions.
- The driver is responsible for maintaining a safe distance and speed and must intervene if the various driver support systems do not maintain a suitable speed or suitable distance to the vehicle ahead.
- Maintenance of radar sensor components may only be performed by a trained and qualified Volvo technician.
- Strong sunlight, reflections from the road surface, strong lighting contrasts or using sunglasses may make the warning light in the windshield difficult to see.

### **⚠ WARNING**

- Poor weather or winding roads can affect the radar sensor's capacity to detect vehicles ahead.
- A vehicle's size (e.g., a motorcycle) can also affect the radar sensor's capacity to detect another vehicle. This may result in the warning light illuminating at a shorter distance than the one that has been set or not illuminating at all.
- High speeds may also result in the warning light illuminating at a shorter distance than the one that has been set due to limitations in the radar sensor's range.

For additional information, see also the article "Radar sensor limitations."

### Related information

- Radar sensor limitations (p. 297)
- Distance Alert\* (p. 267)

## Adaptive Cruise Control (ACC)\*

ACC is an optional system designed to assist the driver by maintaining a set speed or a set time interval to the vehicle ahead.

ACC helps provide more relaxed driving on long trips on highways or other major roads in a relatively even flow of traffic.

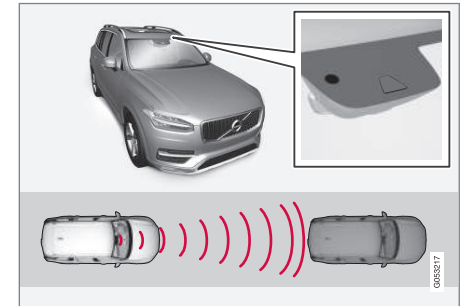

The camera and radar sensor monitor the distance to the vehicle ahead (generic illustration - certain details may vary from model to model)

The driver sets that desired speed and time interval to the vehicle ahead. When the camera and radar sensor detects a slower moving vehicle ahead, your vehicle's speed is automatically adapted. When there are no longer slower moving vehicles ahead, your vehicle will accelerate to resume the set speed.

ACC is designed to follow a vehicle ahead in the same lane and maintain a time interval to that



- ◀◀ vehicle set by the driver. If the radar sensor does not detect a vehicle ahead, ACC will instead maintain the speed set by the driver.

ACC is designed to smoothly regulate speed. However, the driver must apply the brakes in situations that require immediate braking such as when there are great differences in speed between vehicles, or if the vehicle ahead brakes suddenly. Due to limitations in the radar sensor, braking may occur unexpectedly or not at all.

Adaptive Cruise Control can follow another vehicle from a standstill up to 125 mph (200 km/h). Always observe posted speed limits.

The driver can also toggle between ACC and Cruise Control (CC) – see the article "Switching between Cruise Control and Adaptive Cruise Control".

### **WARNING**

- It is advisable to read through all of the related articles pertaining to ACC (see the list at the end of this article).
- Adaptive Cruise Control cannot cover all driving situations and traffic, weather and road conditions.
- This system is designed to be a supplementary driving aid. It is not, however, intended to replace the driver's attention and judgement. The driver is responsible for maintaining a safe distance and speed and must intervene if Adaptive Cruise Control does not maintain a suitable speed or suitable distance to the vehicle ahead.
- Maintenance of ACC components may only be performed by a trained and qualified Volvo technician.

### **Overview**

The distance to the vehicle ahead (in the same lane) is monitored by a radar sensor. Your vehicle's speed is regulated by accelerating and braking. The brakes may emit a sound when they are being modulated by the adaptive cruise control system. This is normal.

### **WARNING**

- Adaptive Cruise Control is not a collision avoidance system. The driver is always responsible for applying the brakes if the system does not detect another vehicle.
- Adaptive Cruise Control does not react to people or animals, or small vehicles such as bicycles and motorcycles. It also does not react to slow moving, parked or approaching vehicles, or stationary objects.
- Do not use Adaptive Cruise Control in demanding driving conditions such as city driving or other heavy traffic situations, in slippery conditions, when there is a great deal of water or slush on the road, during heavy rain or snow, in poor visibility, on winding roads or on highway on- or off-ramps.

## Controls

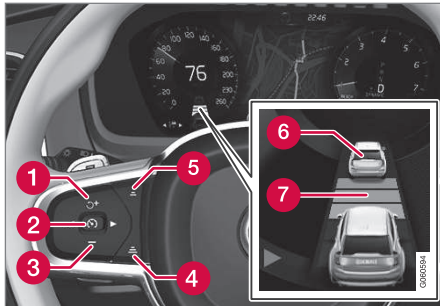

Function buttons and symbols (generic illustration)

- 1 Increases the set speed or puts ACC back into active mode (previous settings will be resumed)
- 2 Puts ACC in active mode and stores the current speed or puts ACC in standby mode
- 3 Reduces the set speed
- 4 Increases the time interval/distance to the vehicle ahead
- 5 Reduces the time interval/distance to the vehicle ahead
- 6 Target vehicle indicator: ACC has detected and is following a target vehicle using the set time interval
- 7 Distance/time indicator

## Instrument panel

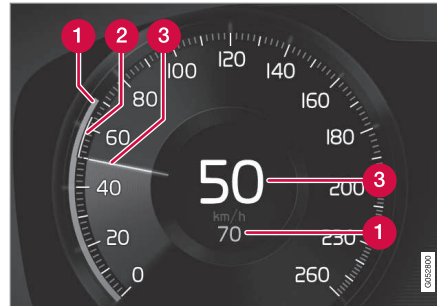

Speed indicators

- 1 Set speed
- 2 Speed of the vehicle ahead
- 3 The current speed of your vehicle

See the article "Adaptive cruise control symbols and messages" for examples of different combinations of symbols, depending on the traffic situation.

## Collision warning

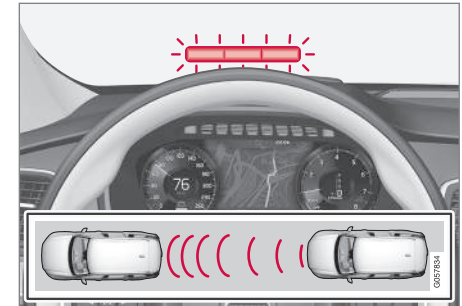

Warning light in the windshield

Adaptive Cruise Control can exert brake force that is equivalent to approximately 40% of the vehicle's total braking capacity.

In situations requiring more brake force than ACC can provide and if the driver does not apply the brakes, an audible signal from the City Safety system will sound and warning light will illuminate in the windshield to alert the driver to react.

### **i** NOTE

Strong sunlight, reflections, extreme light contrasts, the use of sunglasses, or if the driver is not looking straight ahead may make the visual warning signal in the windshield difficult to see.



**⚠ WARNING**

Adaptive Cruise Control only warns of vehicles detected by the radar sensor. In some cases there may be no warning or the warning may be delayed. The driver should always apply the brakes when necessary.

**Head-up-display\***

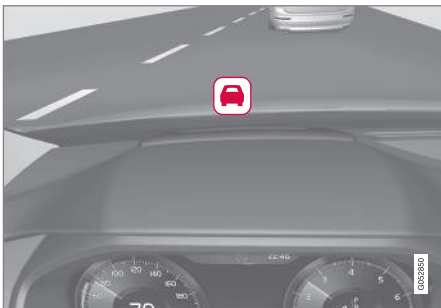

A flashing light alerts the driver

A flashing icon will appear in the head-up display to alert the driver of a collision risk.

**i NOTE**

Strong sunlight, reflections, extreme light contrasts, the use of sunglasses, or if the driver is not looking straight ahead may make the visual warning signal in the windshield difficult to see.

**Related information**

- Starting and activating Adaptive Cruise Control (ACC)\* (p. 272)
- Changing Adaptive Cruise Control (ACC) speed (p. 275)
- Setting an Adaptive Cruise Control time interval (p. 276)
- Changing target vehicles and automatic braking with Adaptive Cruise Control (ACC) (p. 277)
- Switching between Cruise Control and Adaptive Cruise Control\* (p. 266)
- Passing Assistance with Adaptive Cruise Control or Pilot Assist (p. 277)
- Deactivating/resuming Adaptive Cruise Control (ACC) (p. 273)
- Adaptive Cruise Control (ACC) - trouble-shooting (p. 279)
- Adaptive Cruise Control (ACC) symbols and messages (p. 281)
- Pilot Assist\* (p. 283)
- Distance Alert\* (p. 267)
- Head-up display (HUD)\* (p. 116)
- Radar sensor limitations (p. 297)

**Starting and activating Adaptive Cruise Control (ACC)\***

ACC must first be put in active mode before it can be started in order to regulate speed or a set time interval to the vehicle ahead.

**Starting ACC (putting it in standby mode)**

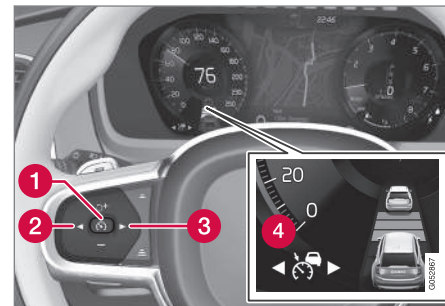

Function buttons and symbols



- Press ◀ (2) or ▶ (3) to scroll to the ACC (ACC) function. The symbol (4) will be displayed in the instrument panel.
  - > The symbol indicates that ACC has been started **and is in standby mode**. In standby mode, the vehicle will **not** maintain a set speed or a time interval to the vehicle ahead.

## Activating ACC (putting it in active mode and setting a speed)

Before ACC can be put in active mode:

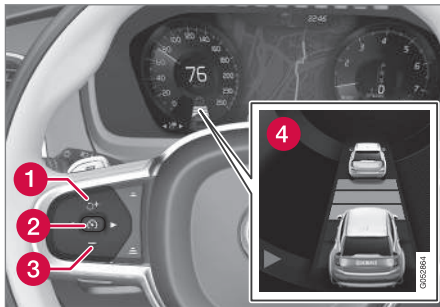
- The driver's seat belt must be buckled and the driver's door must be closed.
- There must be a vehicle ahead (a target vehicle) within a reasonable distance or your vehicle's current speed must be at least 9 mph (15 km/h).



- With the  symbol displayed (ACC is in standby mode), press the  button (1) on the left-side steering wheel keypad.
  - > This puts ACC in active mode and sets the vehicle's current speed, which is indicated by digits in the center of the speedometer.

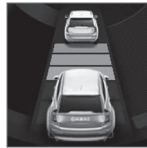

The **time interval** to the vehicle ahead will only be shown when two vehicles are displayed.



A speed interval will also be indicated:

- The higher speed is the one set in ACC
- The lower one is the speed of the vehicle ahead (the target vehicle).

## Related information

- Adaptive Cruise Control (ACC)\* (p. 269)
- Setting an Adaptive Cruise Control time interval (p. 276)
- Deactivating/resuming Adaptive Cruise Control (ACC) (p. 273)

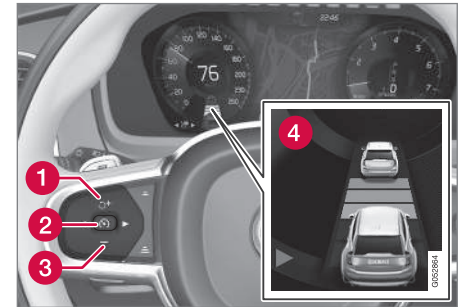

## Deactivating/resuming Adaptive Cruise Control (ACC)

ACC can be put temporarily in standby mode and then reactivated.



Function buttons and symbols

To temporarily deactivate and put Adaptive Cruise Control in standby mode:

- Press the  button (2).
  - > The  symbol in the instrument panel will change colors from WHITE to GRAY and the set speed in the center of the speedometer will change from BEIGE to GRAY.



### **⚠ WARNING**

When ACC is in standby mode, the driver has to control the vehicle's speed and distance to a vehicle ahead.

When ACC is in standby mode, the driver will be alerted if the distance to the vehicle ahead is too short by the Distance Alert function. See the article "Distance Alert" for additional information.

#### **Standby mode due to action by the driver**

ACC is temporarily deactivated and put in standby mode if:

- the brakes are applied
- The gear selector is moved to **N**
- the vehicle is driven faster than the set speed for more than 1 minute.

In these cases, the driver will have to regulate the vehicle's speed.

A temporary increase in speed, such as when passing another vehicle, does not affect the ACC set speed. The vehicle will return to the set speed when the accelerator pedal is released.

#### **Automatic standby mode**

ACC interacts with other systems, such as Electronic Stability Control. If any of these other systems are not functioning properly, ACC will turn off automatically.

### **⚠ WARNING**

If this happens, the driver will be alerted by an audible signal and a message in the instrument panel. The driver will have to adapt the vehicle's speed, apply the brakes when necessary and keep a safe distance to the vehicle ahead.

ACC switches automatically to standby mode if:

- the vehicle's speed goes below approx. 3 mph (5 km/h) and ACC cannot determine if the vehicle ahead is stationary or is an object such as a speed bump, etc
- the vehicle's speed goes below approx. 3 mph (5 km/h) and the vehicle ahead changes lanes or turns so that ACC no longer has a target vehicle to follow
- the driver opens the door
- the driver unbuckles the seat belt
- the engine speed (rpm) is too high/low
- the wheels lose traction
- the brake temperature is too high
- the parking brake is applied
- the stability system's **ESC Sport Mode** is activated
- the **Off Road** drive mode is selected
- The radar sensor is covered by e.g, wet snow or if heavy rain interferes with radar waves

#### **Reactivating ACC from standby mode**

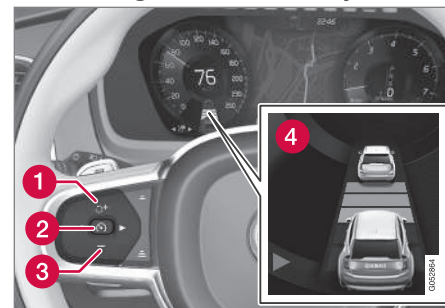

Generic illustration

To reactivate ACC after it has temporarily been put in standby mode:

- Press the button (1).
  - > The vehicle will then return to the **most recently set speed**.

### **⚠ WARNING**

There may be a significant increase in speed after the button has been pressed.

#### **Related information**

- Adaptive Cruise Control (ACC)\* (p. 269)
- Starting and activating Adaptive Cruise Control (ACC)\* (p. 272)
- Setting an Adaptive Cruise Control time interval (p. 276)



- Passing Assistance with Adaptive Cruise Control or Pilot Assist (p. 277)
- Adaptive Cruise Control (ACC) symbols and messages (p. 281)
- Distance Alert\* (p. 267)

## Changing Adaptive Cruise Control (ACC) speed

ACC makes it possible to set various speeds.

### Changing a set speed

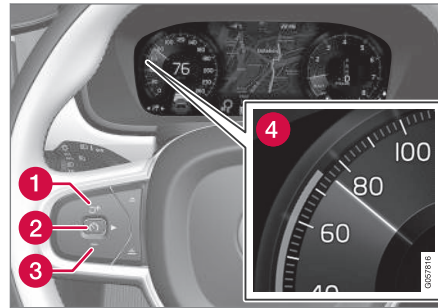

Function buttons and symbols

- Change a set speed by pressing the **+** (1) or **-** (3) buttons briefly or by pressing and holding them:
  - **Press briefly:** changes speed in +/- 5 mph (+/- 5 km/h) increments. Each press changes the vehicle's speed by +/- 5 mph (+/- 5 km/h).
  - **Press and hold:** changes the speed +/- 1 mph (+/- 1 km/h) at a time. Release the button when the set speed indicator (4) has moved to the desired speed.

If speed is increased by pressing the accelerator pedal before the **+** button is pressed, the vehicle's speed when the button is pressed will become the set speed assuming that the accelerator pedal is still depressed when the button is pressed.

A temporary increase in speed, such as when passing another vehicle, does not affect the ACC set speed. The vehicle will return to the set speed when the accelerator pedal is released.

The Adaptive Cruise Control can follow another vehicle from a standstill up to 125 mph (200 km/h). Always observe posted speed limits.

The lowest speed that can be **set** for ACC is 20 mph (30 km/h). However, ACC can monitor and react to the speed of the vehicle ahead down to a standstill.

The highest speed that can be set/stored is approx. 125 mph (200 km/h). Always observe posted speed limits.

### Related information

- Adaptive Cruise Control (ACC)\* (p. 269)

## Setting an Adaptive Cruise Control time interval

ACC makes it possible to set various time intervals to the vehicle ahead.



Different time intervals to the vehicle ahead can be selected and are shown in the instrument panel as 1–5 horizontal bars. The greater the number of bars, the longer the time interval. One bar between the vehicles represents a time interval of approximately 1 second; 5 bars is approximately 3 seconds.

The same symbol appears if Distance Alert is activated.

- If the symbol shows two vehicle's, ACC is actively following the vehicle ahead (a target vehicle).
- If only one vehicle is displayed, ACC is **not** actively following another vehicle.

## Changing a time interval

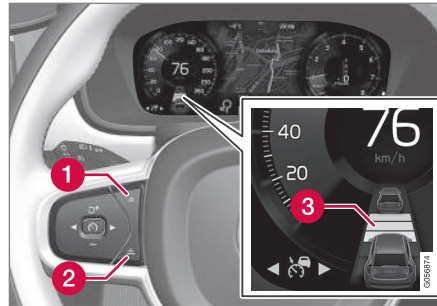

Controls for setting a time interval

- 1 Reduce the time interval
- 2 Increase the time interval
- 3 Distance/time indicator
  - Press buttons (1) or (2) to reduce or increase the time interval.
  - > The distance/time indicator (3) shows the current time interval.

In order to follow the vehicle ahead as smoothly as possible, ACC allows the time interval to vary considerably in certain situations. At low speeds, when the distance to the vehicle ahead is short, ACC increases the time interval slightly.

- If ACC does not seem to react when it is put in active mode, this may be because the set

time interval to the vehicle ahead does not allow an increase in speed.

- The higher the speed, the greater the distance to the vehicle ahead for a given time interval.
- Only use time intervals permitted by local traffic regulations.

### WARNING

- Only use a time interval that is suitable in current traffic conditions.
- A short time interval gives the driver limited reaction time if an unexpected situation occurs in traffic.

### Related information

- Adaptive Cruise Control (ACC)\* (p. 269)
- Starting and activating Adaptive Cruise Control (ACC)\* (p. 272)
- Deactivating/resuming Adaptive Cruise Control (ACC) (p. 273)
- Passing Assistance with Adaptive Cruise Control or Pilot Assist (p. 277)
- Adaptive Cruise Control (ACC) symbols and messages (p. 281)
- Distance Alert\* (p. 267)

## Passing Assistance with Adaptive Cruise Control or Pilot Assist

ACC or Pilot Assist can assist the driver when passing other vehicles.

### How passing assistance works

When ACC or Pilot Assist is following another vehicle and the driver indicates that he/she is about to pass that vehicle by using the left turn signal, ACC or Pilot Assist will begin accelerating toward the vehicle ahead before your vehicle has moved into the passing lane.

The function will then delay a speed reduction to avoid early braking as your vehicle approaches the slower-moving vehicle.

The function is active until your vehicle has passed the other vehicle.

### **⚠️ WARNING**

Be aware that this function may be activated in situations other than when passing a vehicle, such as if the turn signal is used to indicate a lane change or to indicate a turn. The vehicle will accelerate briefly.

### Using passing assistance

To activate passing assistance:

- Your vehicle (ACC or Pilot Assist) must be following another vehicle (the target vehicle).
- Current speed must be at least approx. 45 mph (70 km/h).

- The speed set for ACC or Pilot Assist must be high enough to safely pass the vehicle ahead.

### Starting passing assistance

To start a passing assistance sequence:

- Activate the left turn signal.

### Passing assistance limitations

#### **⚠️ WARNING**

The driver should be prepared for sudden changes when passing assistance is used. In certain cases, there may be undesired acceleration.

Certain situations should be avoided, such as:

- If the vehicle is approaching an exit to the left or a left turn.
- If the vehicle ahead slows down before your vehicle has moved into the passing lane.
- Traffic in the passing lane slows down.

Passing assistance in these situations can be deactivated by putting ACC or Pilot Assist in standby mode.

### Related information

- Pilot Assist\* (p. 283)
- Adaptive Cruise Control (ACC)\* (p. 269)

## Changing target vehicles and automatic braking with Adaptive Cruise Control (ACC)

At certain speeds, Adaptive Cruise Control can change target vehicles and automatically apply the brakes.

### Changing target vehicles

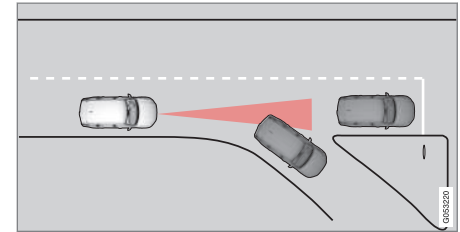

If the target vehicle turns suddenly, there may be a stationary vehicle ahead

When ACC is actively following another vehicle at speeds **under 20 mph (30 km/h)** and changes targets from a moving vehicle to a stationary one, the system will brake for the stationary vehicle.





## **⚠ WARNING**

At speeds **above** 20 mph (30 km/h), if ACC changes targets from a moving vehicle to a stationary one, the system will **not** react to the stationary vehicle and will accelerate to the previously set speed.

The driver must actively apply the brakes to slow/stop the vehicle.

### **Automatic standby mode when changing targets**

ACC disengages and goes into standby mode if:

- your vehicle's speed goes below approx. 3 mph (5 km/h) and ACC cannot determine if the target object is a stationary vehicle or some other type of object such as a speed bump, etc
- the vehicle's speed goes below approx. 3 mph (5 km/h) and the vehicle ahead changes lanes or turns so that ACC no longer has a target vehicle to follow.

### **Auto-hold brake function**

In slow-moving, stop-and-go traffic or when stopped at a traffic light, driving will resume automatically if the vehicle is not stopped for more than approx. 3 seconds. If it takes more than 3 seconds for the vehicle ahead to begin moving again, ACC will go into standby mode and the auto-hold brake function will activate.

- The driver will then have to reactivate ACC in one of the following ways:
  - Press the  button on the left-side steering wheel keypad.
  - Press the accelerator pedal.
- > ACC will resume following the vehicle ahead (target vehicle) if it begins to move within approx. 6 seconds.

### **ⓘ NOTE**

ACC can keep the vehicle at a standstill for up to 5 minutes, after which the parking brake will be set and ACC will go into standby mode.

The parking brake has to be released before ACC can be reactivated.

### **Deactivation of the auto-hold brake function**

In certain situations, auto-hold will be deactivated when the vehicle is at a standstill and ACC will go into standby mode.

This means that the brakes will be released and the vehicle can begin to roll.

The driver must actively apply the brakes to keep the vehicle at a standstill.

This can occur in the following situations:

- the driver presses the brake pedal
- the parking brake is set

- the gear selector is moved to the **P, N** or **R** positions
- the driver puts ACC in standby mode.

### **Automatically setting the parking brake**

In certain situations, the parking brake is set automatically to help keep the vehicle at a standstill.

This occurs if ACC keeps the vehicle at a standstill with the brakes and:

- the driver unbuckles the seat belt or opens the door
- ACC has kept the vehicle at a standstill for more than approx. 5 minutes
- the brakes overheat
- the engine is turned off.

### **Related information**

- Adaptive Cruise Control (ACC)\* (p. 269)
- Auto-hold brake function (p. 356)
- Parking brake (p. 360)

## Adaptive Cruise Control (ACC) - troubleshooting



If this symbol is displayed in the instrument panel and the message **Windscreen sensor blocked, see Owner's manual**

appears, the ACC radar sensor is blocked and cannot detect vehicles ahead.

This message also indicates that the following systems may have reduced functionality:

- Distance Alert
  - City Safety
  - Driver Alert Control
  - Pilot Assist
  - Lane Keeping Aid (LKA)
- Road Sign Information (RSI)

The following table lists possible causes for this message being displayed and suitable actions:

Cause	Action
The windshield in front of the radar is dirty or covered with snow/ice.	Clean/clear the windshield in front of the radar.
Heavy rain or snow is interfering with the radar signals.	No action possible. Heavy precipitation may affect the function of the radar.
Swirling water or snow from the surface of the road may interfere with the radar signals.	No action possible. A very wet or snow-covered road surface may affect the function of the radar.
The windshield in front of the radar is clean but the message remains in the display.	Wait a short time. It may take several minutes for the radar to detect that it is no longer obstructed.

A text message can be erased by briefly pressing the **O** button on the right-side steering wheel keypad. If the message recurs, contact a trained and authorized Volvo service technician or retailer.

### Related information

- Adaptive Cruise Control (ACC)\* (p. 269)

## **Adaptive Cruise Control (ACC) - limitations**

Adaptive Cruise Control (ACC) functionality may be limited in certain situations.

### **Steep roads and/or heavy loads**

Adaptive Cruise Control is primarily intended for use on relatively level roads. The function may not be able to maintain the correct time interval to the vehicle ahead when driving down steep hills. The driver should be attentive and prepared to apply the brakes in these situations.

Do not use Adaptive Cruise Control when the vehicle is transporting a heavy load or if it is towing a trailer.

### **Additional information**

- The **Off Road** drive mode cannot be selected if Adaptive Cruise Control is activated.
- Adaptive Cruise Control uses the vehicle's camera and radar sensor, which have certain general limitations. See the articles "Camera limitations" and "Radar sensor limitations" for additional information.

### **Related information**

- Adaptive Cruise Control (ACC)\* (p. 269)
- Radar sensor limitations (p. 297)
- Camera limitations (p. 301)

## Adaptive Cruise Control (ACC) symbols and messages

A number of ACC symbols and/or messages may appear in the instrument panel or the head-up display\*.

Several examples<sup>2</sup> are provided here.

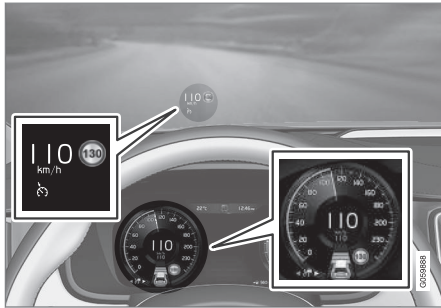

This illustration<sup>3</sup> shows that ACC is set at a speed of 68 mph (110/km/h) and that there is no vehicle ahead to follow.

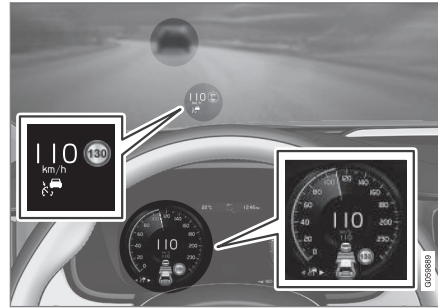

This illustration<sup>3</sup> shows that ACC is set at a speed of 68 mph (110/km/h) and is following another vehicle traveling at the same speed.

The following table lists several ACC-related symbols and messages.



Symbol	Message	Explanation
	WHITE symbol	ACC is in active mode and maintaining the set speed.
	GRAY symbol and <b>Unavailable</b>	ACC is in standby mode.

<sup>2</sup> In the following illustrations, the optional RSI (Road Sign Information) function is indicating that the posted speed limit is 80 mph (130 km/h).

<sup>3</sup> The illustration is generic. 110 km/h is approx. 68 mph.





Symbol	Message	Explanation
	<b>Adaptive cruise Service required</b>	The system is not functioning properly. Contact a trained and qualified Volvo Service technician.
	<b>Windscreen sensor Sensor blocked, see Owner's manual</b>	Clean the windshield in front of the camera/radar sensor.

A text message can be erased by briefly pressing the **O** button on the right-side steering wheel keypad. If the message recurs, contact a trained and authorized Volvo service technician or retailer.

#### Related information

- Adaptive Cruise Control (ACC)\* (p. 269)
- Road Sign Information (RSI)\* (p. 324)



## Pilot Assist\*

The Pilot Assist feature helps keep the vehicle in its current traffic lane by providing steering assistance and maintaining an even speed and a set time interval to the vehicle ahead.

### Function

Pilot Assist helps provide more relaxed driving on long trips on highways or other major roads in an even flow of traffic.

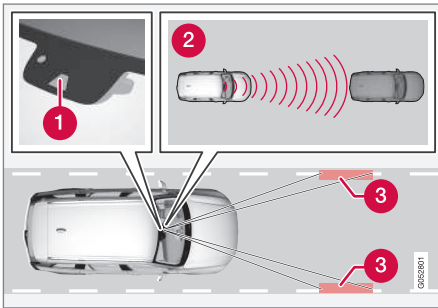

Function overview (generic illustration)

- 1 Windshield module containing the camera/radar sensor
- 2 Monitoring distance
- 3 Monitoring side marker lines

The driver sets the desired time interval to the vehicle ahead. Pilot Assist monitors that vehicle and the traffic lane's side market lines using the

camera and radar sensor mounted in the upper, center section of the windshield. It helps maintain the set time interval by automatically adjusting speed and by providing steering assistance to help keep your vehicle in the lane.

Pilot Assist's steering assistance is based on monitoring the direction of the vehicle ahead and the traffic lane's side marker lines. The driver can always override Pilot Assist and steer the vehicle to e.g., change lanes, etc.

If the camera and radar sensor cannot detect the lane's side marker lines, Pilot Assist will temporarily switch off the steering assistance until the lane's side marker lines become visible again and can be detected. However, the function's speed and distance monitoring will continue to be activated.

### WARNING

Pilot Assist's steering assistance may switch on or off without warning.

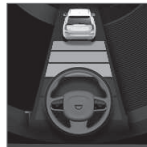

The color of the steering wheel symbol indicates the current status of the steering assistance function:

GREEN: steering assistance is active

GRAY (as in the illustration): steering assistance is deactivated

### WARNING

- Pilot Assist is designed to be a supplementary driving aid and cannot cover all driving situations, traffic, weather and/or road conditions.
- The driver should be familiar with all of the information in this article regarding Pilot Assist, including its limitations.
- Pilot Assist is not intended to replace the driver's attention and judgement.
- Pilot Assist must only be used where there are clearly visible traffic lane side marker lines on both sides of the current traffic lane. In other circumstances there is an increased risk of collision with surrounding obstacles that are not detected by the system.
- The driver is always responsible for steering the vehicle and maintaining a suitable speed and distance to the vehicle ahead and must intervene if necessary, even if Pilot Assist is being used.

Pilot Assist attempts to regulate speed smoothly but in situations calling for fast braking, the driver must apply the brakes. This applies to situations where there are considerable differences in speed or if the vehicle ahead brakes suddenly. Due to the limitations of the camera and radar



- ◀ sensor, the system may apply the brakes in your vehicle suddenly or not at all.

Pilot Assist is designed to follow a vehicle ahead in the same traffic lane at a preset time interval set by the driver. If the radar sensor does not detect a vehicle ahead, the vehicle will instead maintain the speed set by the driver. This will also be the case if a vehicle ahead accelerates and exceeds the set speed.

- Pilot Assist can follow another vehicle from a standstill up to a speed of approx. 125 mph (200 km/h)
- Pilot Assist can provide steering assistance from very low speeds up to approx. 87 mph (140 km/h).

Never exceed posted speed limits.

### WARNING

- Pilot Assist is not a collision avoidance system. The driver must react if the system does not detect another vehicle.
- Pilot Assist does not react to people, animals, stationary objects, small vehicles (such as bicycles and motorcycles), low trailers and slow moving, parked or approaching vehicles.
- Do not use Pilot Assist in demanding driving conditions such as city driving or other heavy traffic situations, in areas with intersections, in slippery conditions, when there is a great deal of water or slush on the road, during heavy rain or snow, in poor visibility, on winding roads, on highway on- or off-ramps or if the vehicle is towing a trailer, boat, etc.

### NOTE

- Pilot Assist maintenance should only be carried out by a trained and qualified Volvo service technician.
- Pilot Assist regulates your vehicle's speed using the accelerator pedal and the brakes. Please be aware that there may be a faint sound from the brakes when the system is using them.

## Pilot Assist overview

### Controls

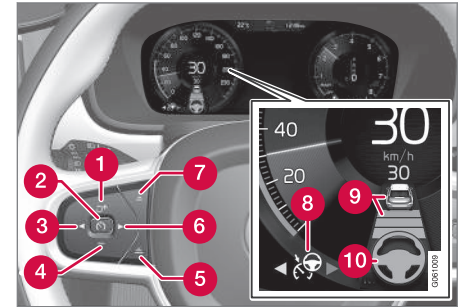

Function buttons and symbols (generic illustration)

- 1 Increase set speed or resume Pilot Assist set speed and distance (time interval) to the vehicle ahead
- 2 Press to activate Pilot Assist or put it in standby mode
- 3 Change from Pilot Assist to Adaptive Cruise Control
- 4 Reduce set speed
- 5 Increase the distance (time interval) to the vehicle ahead
- 6 Change from Adaptive Cruise Control to Pilot Assist
- 7 Reduce the distance (time interval) to the vehicle ahead

- 8 Function symbol
- 9 Distance and target vehicle symbol
- 10 Steering assistance symbol

### Instrument panel

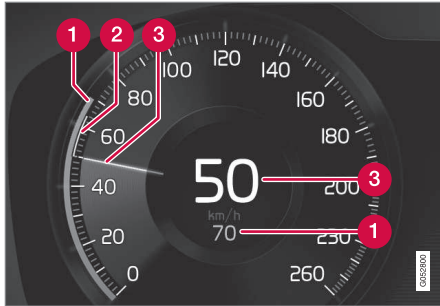

Speed indication (generic illustration)

- 1 Set speed
- 2 Speed of the vehicle ahead
- 3 Your vehicle's current speed.

See also the article "Pilot assist symbols and messages" for additional information.

### Collision warning

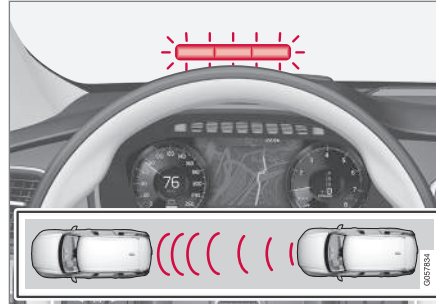

Warning light in the windshield

Pilot Assist can exert brake force that is equivalent to approximately 40% of the vehicle's total braking capacity.

In situations requiring more brake force than Pilot Assist can provide and if the driver does not apply the brakes, an audible signal and warning light will illuminate in the windshield to alert the driver to react.

### **i** NOTE

Strong sunlight, reflections, extreme light contrasts, the use of sunglasses, or if the driver is not looking straight ahead may make the visual warning signal in the windshield difficult to see.

### **⚠** WARNING

Pilot Assist only provides warnings for vehicles that its radar sensor and camera have detected. For this reason, a warning may be given later than expected or not at all. The driver should never wait for a warning before applying the brakes.

◀ **Head-up-display\***



A flashing symbol alerts the driver

If the vehicle is equipped with a head-up display, a flashing symbol in the windshield will alert the driver.

**i NOTE**

Strong sunlight, reflections, extreme light contrasts, the use of sunglasses, or if the driver is not looking straight ahead may make the visual warning signal in the windshield difficult to see.

**Related information**

- Starting and activating Pilot Assist (p. 286)
- Changing Pilot Assist speed (p. 288)
- Setting a Pilot Assist time interval (p. 289)

- Changing target vehicles and automatic braking with Pilot Assist (p. 292)
- Deactivating/resuming Pilot Assist (p. 290)
- Passing Assistance with Adaptive Cruise Control or Pilot Assist (p. 277)
- Pilot Assist limitations (p. 293)
- Pilot Assist symbols and messages (p. 295)
- Adaptive Cruise Control (ACC)\* (p. 269)
- Distance Alert\* (p. 267)
- Head-up display (HUD)\* (p. 116)
- Radar sensor limitations (p. 297)
- Camera limitations (p. 301)

**Starting and activating Pilot Assist**

Pilot Assist has to be started and then activated before it can provide steering assistance and regulate speed and the distance to the vehicle ahead.

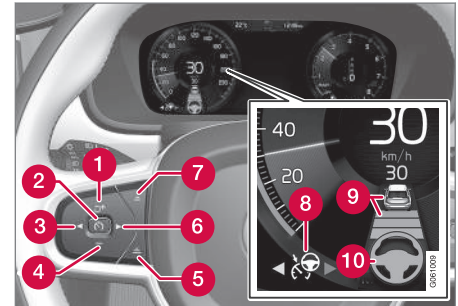



Function buttons and symbols

## Prerequisites

The prerequisites for activating Pilot Assist are:

- The driver's seat belt must be buckled and the driver's door must be closed.
- There must be a vehicle ahead (a target vehicle) within a reasonable distance or your vehicle's current speed must be at least 9 mph (15 km/h).

With ACC in standby mode:

1. Tap ► (6).
    - > The symbol  will change to Pilot Assist in standby mode (8).
  2. Press the  button (2) on the left-side steering wheel keypad.
    - > Pilot Assist will go into active mode and the current speed will be stored and displayed in the center of the speedometer.
- or

If Adaptive Cruise Control has been started:

- Tap ► (6).
  - > Pilot Assist will start.



Pilot Assist's steering assistance is only active when the steering wheel symbol (2) changes from GRAY to GREEN.

And Pilot Assist will only regulate the time interval to the vehicle ahead when a vehicle symbol (1) is displayed above the steering wheel.



At the same time, a speed interval will be marked.

The higher speed is the one stored by the driver and the lower one is the speed of the vehicle ahead (target vehicle).

## WARNING

Pilot Assist is not a collision avoidance system. The driver is always responsible for steering or applying the brakes if the system does not detect another vehicle.

Do not use Pilot Assist in demanding driving conditions such as city driving or other heavy traffic situations, in slippery conditions, when there is a great deal of water or slush on the road, during heavy rain or snow, in poor visibility, on winding roads or on highway on- or off-ramps.

In certain situations, it may be difficult for Pilot Assist to assist the driver correctly or to deactivate automatically. In such cases, it is advisable not to use Pilot Assist. Examples of such situations may be:

- the lane's side market lines are missing, badly faded or cross each other.
- the division of lanes is not clear, e.g., when a line divides or merges with another, at exits or if there are many road signs/markers.
- there are edges or other lines on or near the lane, e.g., curbs, cracks, repaired areas, sharp shadows, etc.
- the lane is narrow or winding.



- the lane is at the top of a hill, on an uneven road surface or over a bump.
- bad weather conditions (rain, snow, fog, slush, poor visibility, backlighting, etc).

The driver should also be aware that Pilot Assist has the following limitations:

- High curbs, barriers and temporary obstacles (cones, barriers etc) may not be detected or could be detected incorrectly as side marker lines, which may create a risk of collision. The driver must ensure a safe distance to these obstacles.
- The camera or radar sensor may not be able to detect objects if there are pot-holes or if there are stationary objects partially or completely blocking the road.
- Pilot Assist does not "see" pedestrians, animals, etc.
- Pilot Assist's steering capacity is limited and may not always be able to help the driver keep the vehicle in the lane.

### Hands on the steering wheel

**Pilot Assist only functions when the driver's hands are on the steering wheel**, which is continuously monitored by the system. If this is not the case, the driver will be alerted by a text message in the instrument panel. If the driver's hands are not returned to the steering wheel, an audible signal will sound.

If the driver does not return his/her hands to the steering wheel after the audible signal, Pilot Assist will go into standby mode and must be reactivated by pressing .

### Related information

- Pilot Assist\* (p. 283)
- Changing Pilot Assist speed (p. 288)
- Setting a Pilot Assist time interval (p. 289)
- Changing target vehicles and automatic braking with Pilot Assist (p. 292)
- Deactivating/resuming Pilot Assist (p. 290)
- Passing Assistance with Adaptive Cruise Control or Pilot Assist (p. 277)
- Pilot Assist limitations (p. 293)
- Pilot Assist symbols and messages (p. 295)

## Changing Pilot Assist speed

Different speeds can be set for Pilot Assist.

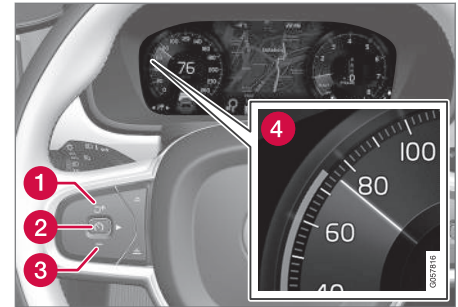

Function buttons and symbols

- Change a set speed by pressing the **+** (1) or **-** (3) buttons briefly or by pressing and holding them:
  - **Press briefly:** changes speed in +/- 5 mph (+/- 5 km/h) increments. Each press changes the vehicle's speed by +/- 5 mph (+/- 5 km/h).
  - **Press and hold:** changes the speed +/- 1 mph (+/- 1 km/h) at a time. Release the button when the set speed indicator (4) has moved to the desired speed.

If speed is increased by pressing the accelerator pedal before the **+** button is pressed, the vehicle's speed when the button is pressed will

become the set speed assuming that the accelerator pedal is still depressed when the button is pressed.

A temporary increase in speed, such as when passing another vehicle, does not affect the speed set for Pilot Assist. The vehicle will return to the set speed when the accelerator pedal is released.

Pilot Assist can follow another vehicle from a standstill up to a speed of approx. 125 mph (200 km/h). Always observe posted speed limits.

The lowest speed that can be set/stored for Pilot Assist is 20 mph (30 km/h). However, Pilot Assist can monitor and react to the speed of the vehicle ahead down to a standstill.

The highest speed that can be set/stored is approx. 125 mph (200 km/h). Always observe posted speed limits.

### Related information

- Pilot Assist\* (p. 283)
- Starting and activating Pilot Assist (p. 286)
- Setting a Pilot Assist time interval (p. 289)
- Changing target vehicles and automatic braking with Pilot Assist (p. 292)
- Deactivating/resuming Pilot Assist (p. 290)
- Passing Assistance with Adaptive Cruise Control or Pilot Assist (p. 277)
- Pilot Assist limitations (p. 293)

- Pilot Assist symbols and messages (p. 295)

## Setting a Pilot Assist time interval

Different time intervals to the vehicle ahead can be selected and are shown in the instrument panel as 1–5 horizontal bars.

### Changing the time interval

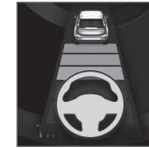

The greater the number of bars, the longer the time interval. One bar between the vehicles represents a time interval of approximately 1 second; 5 bars is approximately 3 seconds.

### **i** NOTE

When the graphic in the instrument panel shows a vehicle and a steering wheel, Pilot Assist is following a vehicle ahead using the set time interval.

If only a steering wheel is displayed, there is no vehicle ahead within a reasonable distance.



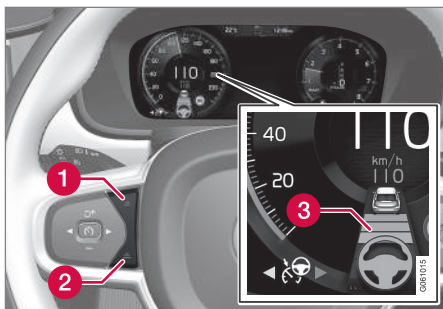

Time interval controls

- 1** Press to reduce the time interval to the vehicle ahead
- 2** Press to increase the time interval to the vehicle ahead
- 3** Distance indicator

In order to follow the vehicle ahead as smoothly as possible, Pilot Assist allows the time interval to vary considerably in certain situations. At low speeds, when the distance to the vehicle ahead is short, Pilot Assist increases the time interval slightly.

- If Pilot Assist does not seem to react when it is put in active mode, this may be because the set time interval to the vehicle ahead does not allow an increase in speed.
- The higher the speed, the greater the distance to the vehicle ahead for a given time interval.

**⚠ WARNING**

- Only use a time interval that is suitable in current traffic conditions.
- A short time interval gives the driver limited reaction time if an unexpected situation occurs in traffic.

**Related information**

- Pilot Assist\* (p. 283)
- Starting and activating Pilot Assist (p. 286)
- Changing Pilot Assist speed (p. 288)
- Changing target vehicles and automatic braking with Pilot Assist (p. 292)
- Deactivating/resuming Pilot Assist (p. 290)
- Passing Assistance with Adaptive Cruise Control or Pilot Assist (p. 277)
- Pilot Assist limitations (p. 293)
- Pilot Assist symbols and messages (p. 295)

**Deactivating/resuming Pilot Assist**

Pilot Assist can be temporarily deactivated, put in standby mode and then reactivated.

**Deactivating and putting Pilot Assist in standby mode**

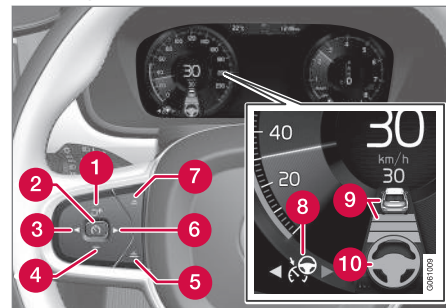

Function buttons and symbols (generic illustration)

- Press the button (2).
  - > Pilot Assist will go into standby mode (8). The symbol in the instrument panel will change colors from WHITE to GRAY and the set speed in the center of the speedometer will change from BEIGE to GRAY.
- or
- Press the button (3).
  - > Pilot Assist will be turned off and shift to Adaptive Cruise Control in active mode.



In standby mode, the driver will have to regulate the vehicle's speed and the distance to the vehicle ahead.

When Pilot Assist is in standby mode and your vehicle comes too close to another vehicle, the driver will be alerted by the Distance Alert function.

### Standby mode due to action by the driver

Pilot Assist is temporarily deactivated and put in standby mode if:

- the brakes are applied
- The gear selector is moved to **N**
- the turn signals are used for more than 1 minute
- the vehicle is driven faster than the set speed for more than 1 minute.

A temporary increase in speed, such as when passing another vehicle, does not affect the Pilot Assist set speed. The vehicle will return to the set speed when the accelerator pedal is released.

When the turn signals are used, Pilot Assist's steering function will be temporarily deactivated. When this is no longer the case, the steering function will reactivate if the traffic lane's side marker lines can still be detected.

### Automatic standby mode

Pilot Assist interacts with other systems, such as Electronic Stability Control. If any of these other

systems are not functioning properly, Pilot Assist will automatically be deactivated.

### WARNING

If this happens, the driver will be alerted by an audible signal and a message in the instrument panel. The driver will have to adapt the vehicle's speed, apply the brakes when necessary and keep a safe distance to the vehicle ahead.

Pilot Assist switches automatically to standby mode if:

- the vehicle's speed is below approx. 3 mph (5 km/h) and Pilot Assist cannot determine if a vehicle ahead is a stationary vehicle or an object.
- the vehicle's speed is below approx. 3 mph (5 km/h) and the vehicle ahead turns so that Pilot Assist no longer has a vehicle to follow (target vehicle).
- the driver's hands are not on the steering wheel
- the driver's door is opened
- the driver unbuckles the seat belt
- engine speed (rpm) is too high/low
- the wheels lose traction
- brake temperature is too high
- the parking brake is set

- The camera lens/radar sensor is covered by e.g., snow or if heavy rain interferes with radar waves

### Reactivating Pilot Assist from standby mode

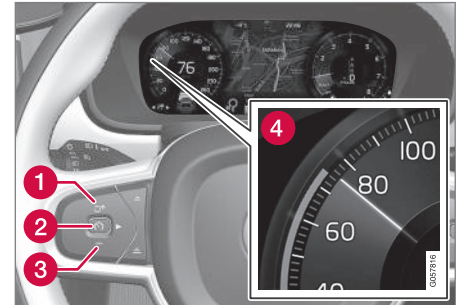

Generic illustration

- Press the  button (1).
  - > The most recently set speed will be used.

### WARNING

There may be a significant increase in speed after the  button has been pressed.

### Related information

- Pilot Assist\* (p. 283)
- Starting and activating Pilot Assist (p. 286)
- Changing Pilot Assist speed (p. 288)



- Setting a Pilot Assist time interval (p. 289)
- Changing target vehicles and automatic braking with Pilot Assist (p. 292)
- Passing Assistance with Adaptive Cruise Control or Pilot Assist (p. 277)
- Pilot Assist limitations (p. 293)
- Pilot Assist symbols and messages (p. 295)
- Distance Alert\* (p. 267)

## Changing target vehicles and automatic braking with Pilot Assist

At certain speeds, Pilot Assist can change target vehicles and automatically apply the brakes.

### Changing target vehicles

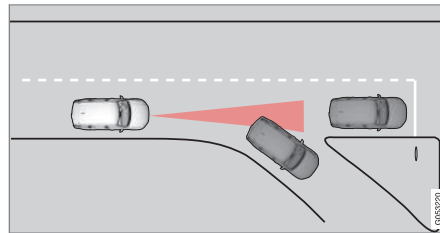

If the target vehicle turns suddenly, there may be a stationary vehicle ahead

When Pilot Assist is actively following another vehicle at speeds **under** 20 mph (30 km/h) and changes targets from a moving vehicle to a stationary one, the system will brake for the stationary vehicle.

### **WARNING**

If Pilot Assist changes targets from a moving vehicle to a stationary one at speeds **above** 20 mph (30 km/h), the system will **not** react to the stationary vehicle and will accelerate to the previously set speed.

The driver must actively apply the brakes to slow/stop the vehicle.

### Automatic standby mode when changing targets

Pilot Assist disengages and goes into standby mode if:

- your vehicle's speed goes below approx. 3 mph (5 km/h) and Pilot Assist cannot determine if the target object is a stationary vehicle or some other type of object such as a speed bump, etc
- the vehicle's speed goes below approx. 3 mph (5 km/h) and the vehicle ahead changes lanes or turns so that Pilot Assist no longer has a target vehicle to follow

### Auto-hold brake function

In slow-moving, stop-and-go traffic or when stopped at a traffic light, driving will resume automatically if the vehicle is not stopped for more than approx. 3 seconds. If it takes more than 3 seconds for the vehicle ahead to begin moving again, Pilot Assist will go into standby mode and the auto-hold brake function will activate.

- The driver will then have to reactivate Pilot Assist in one of the following ways:
  - Press the  button on the left-side steering wheel keypad
  - Press the accelerator pedal
- > Pilot Assist will resume following the vehicle ahead (target vehicle) if it begins to move within approx. 6 seconds.

### **i** NOTE

Pilot Assist can keep the vehicle at a standstill for up to 5 minutes, after which the parking brake will be set and Pilot Assist will go into standby mode.

The parking brake has to be released before Pilot Assist can be reactivated.

### **Deactivation of the auto-hold brake function**

In certain situations, auto-hold will be deactivated when the vehicle is at a standstill and Pilot Assist will go into standby mode.

This means that the brakes will be released and the vehicle can begin to roll.

The driver must actively apply the brakes to keep the vehicle at a standstill.

This can occur in the following situations:

- the driver presses the brake pedal
- the parking brake is set

- the gear selector is moved to the **P, N** or **R** positions
- the driver puts Pilot Assist in standby mode

### **Automatically setting the parking brake**

In certain situations, the parking brake is set automatically to help keep the vehicle at a standstill.

This occurs if Pilot Assist keeps the vehicle at a standstill with the brakes and:

- the driver unbuckles the seat belt or opens the door
- Pilot Assist has kept the vehicle at a standstill for more than approx. 5 minutes
- the engine is turned off
- the brakes overheat

### **Related information**

- Pilot Assist\* (p. 283)
- Starting and activating Pilot Assist (p. 286)
- Changing Pilot Assist speed (p. 288)
- Setting a Pilot Assist time interval (p. 289)
- Deactivating/resuming Pilot Assist (p. 290)
- Passing Assistance with Adaptive Cruise Control or Pilot Assist (p. 277)
- Pilot Assist limitations (p. 293)
- Pilot Assist symbols and messages (p. 295)

### **Pilot Assist limitations**

Pilot Assist functionality may be limited in certain situations.

Pilot Assist is designed to help the driver in a number of situations. However, the driver always has the primary responsibility for maintaining a safe distance to other vehicles and for keeping the vehicle in its proper traffic lane.





## WARNING

Pilot Assist is not a collision avoidance system. The driver is always responsible for steering or applying the brakes if the system does not detect another vehicle.

Do not use Pilot Assist in demanding driving conditions such as city driving or other heavy traffic situations, in slippery conditions, when there is a great deal of water or slush on the road, during heavy rain or snow, in poor visibility, on winding roads or on highway on- or off-ramps.

In certain situations, it may be difficult for Pilot Assist to assist the driver correctly or to deactivate automatically. In such cases, it is advisable not to use Pilot Assist. Examples of such situations may be:

- the lane's side marker lines are missing, badly faded or cross each other.
- the division of lanes is not clear, e.g., when a line divides or merges with another, at exits or if there are many road signs/markers.
- there are edges or other lines on or near the lane, e.g., curbs, cracks, repaired areas, sharp shadows, etc.
- the lane is narrow or winding.
- the lane is at the top of a hill, on an uneven road surface or over a bump.

- bad weather conditions (rain, snow, fog, slush, poor visibility, backlighting, etc).

The driver should also be aware that Pilot Assist has the following limitations:

- High curbs, barriers and temporary obstacles (cones, barriers etc) may not be detected or could be detected incorrectly as side marker lines, which may create a risk of collision. The driver must ensure a safe distance to these obstacles.
- The camera or radar sensor may not be able to detect objects if there are potholes or if there are stationary objects partially or completely blocking the road.
- Pilot Assist does not "see" pedestrians, animals, etc.
- Pilot Assist's steering capacity is limited and may not always be able to help the driver keep the vehicle in the lane.

The driver can always take action to override Pilot Assist.

### Steep roads and/or heavy loads

Pilot Assist is primarily intended for use on relatively level roads. The function may not be able to maintain the correct time interval to the vehicle ahead on when driving down steep hills. The driver should be attentive and prepared to apply the brakes in these situations.

Do not use Pilot Assist when the vehicle is transporting a heavy load or if it is towing a trailer.

### Additional information

- The **Off Road** drive mode cannot be selected if Pilot Assist is activated.
- Pilot Assist uses the vehicle's camera and radar sensor, which have certain general limitations. See the articles "Camera limitations" and "Radar sensor limitations" for additional information.

### Related information

- Pilot Assist\* (p. 283)
- Starting and activating Pilot Assist (p. 286)
- Changing Pilot Assist speed (p. 288)
- Setting a Pilot Assist time interval (p. 289)
- Changing target vehicles and automatic braking with Pilot Assist (p. 292)
- Deactivating/resuming Pilot Assist (p. 290)
- Passing Assistance with Adaptive Cruise Control or Pilot Assist (p. 277)
- Pilot Assist symbols and messages (p. 295)
- Radar sensor limitations (p. 297)
- Camera limitations (p. 301)

## Pilot Assist symbols and messages

A number of Pilot Assist symbols and/or messages may appear in the instrument panel or the head-up display\*.

Several examples<sup>4</sup> are provided here.

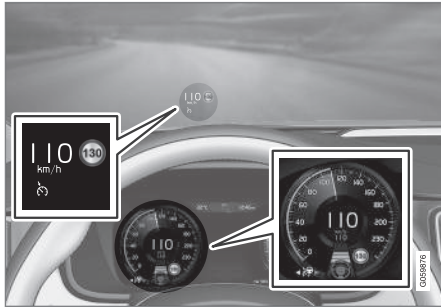

In this illustration, Pilot Assist is set at 65 mph (110 km/h) and there is no target vehicle ahead.

In this example, Pilot Assist will not provide steering assistance because it cannot detect the traffic lane's side marker lines.

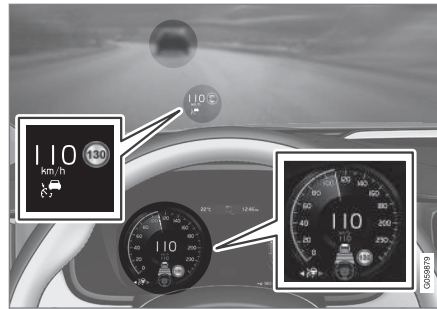

In this illustration, Pilot Assist is set at 65 mph (110 km/h) and there is a target vehicle ahead that is traveling at the same speed.

In this example, Pilot Assist will not provide steering assistance because it cannot detect the traffic lane's side marker lines.

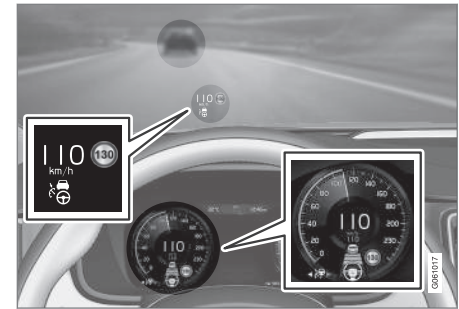

In this illustration, Pilot Assist is set at 65 mph (110 km/h) and there is a target vehicle ahead that is traveling at the same speed.

In this example, Pilot Assist also provides steering assistance because it is able to detect the traffic lane's side marker lines.

<sup>4</sup> In the following illustrations, the optional RSI (Road Sign Information) function is indicating that the posted speed limit is 80 mph (130 km/h).

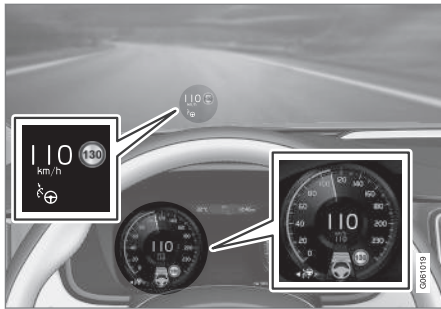

In this illustration, Pilot Assist is set at 65 mph (110 km/h) and there is no target vehicle ahead.

In this example, Pilot Assist also provides steering assistance because it is able to detect the traffic lane's side marker lines.

### Related information

- Pilot Assist\* (p. 283)
- Starting and activating Pilot Assist (p. 286)
- Changing Pilot Assist speed (p. 288)
- Setting a Pilot Assist time interval (p. 289)
- Changing target vehicles and automatic braking with Pilot Assist (p. 292)
- Deactivating/resuming Pilot Assist (p. 290)
- Passing Assistance with Adaptive Cruise Control or Pilot Assist (p. 277)
- Pilot Assist limitations (p. 293)

### Driver support system radar sensor

The radar sensor is used by a number of driver support systems to e.g., help detect other vehicles.



Radar sensor location

The radar sensor is used by the following functions:

- Distance Alert\*
- Adaptive Cruise Control\*
- Pilot Assist\*
- City Safety

Any modifications to the radar sensor may make its use illegal.

### Related information

- Radar sensor limitations (p. 297)
- Radar sensor - type approval (p. 300)

- Distance Alert\* (p. 267)
- Adaptive Cruise Control (ACC)\* (p. 269)
- City Safety™ (p. 304)
- Pilot Assist\* (p. 283)

## Radar sensor limitations

The radar sensor used by several of the driver support systems has certain limitations, which also affect the systems using it.

## Obstructions



The marked area must not be obstructed in any way.  
This area of the windshield should always be kept clean

The radar sensor is located at the upper, center section of the windshield along with the camera.

### **WARNING**

Never place any objects, decals, electronic toll devices, window tinting films etc., on the windshield in front of or around the camera/radar sensor. This could reduce or block these components' functions, and could cause one or more of the systems that utilize them to stop functioning.

This can also result in certain functions being reduced or disabled, or they may respond incorrectly.



If this symbol and the message **Windscreen Sensors blocked** appear in the instrument panel, this indicates that the camera and/or radar sensor cannot detect other vehicles ahead.

The following table shows some of the situations that can cause the message to be displayed and suggested actions.

Cause	Action
The area of the windshield in front of the camera/radar sensor is dirty or covered by ice or snow.	Clean the windshield or remove the ice/ snow.
Thick fog or heavy rain/snow reduces the camera/radar sensor's range of visibility.	No action. The driver should be extra alert in conditions of this type.
Water or snow on the surface of the road swirl up and block radar signals or the camera's view.	No action. The driver should be extra alert in conditions of this type.
There is dirt between the inside of the windshield and the camera/radar sensor.	Have the area of the windshield cleaned by a trained and qualified Volvo service technician.





### Vehicle's speed

The radar sensor's capacity to detect vehicles ahead is impeded:

- if the speed of the vehicle ahead differs greatly from your vehicle's speed.

### Limited field of vision

The radar sensor has a limited field of vision. In some situations it may detect a vehicle later than expected or not detect other vehicles at all.

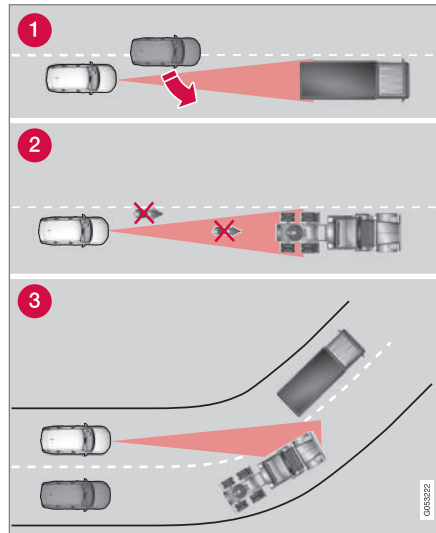

Radar sensor's field of vision

- 1 In certain situations, the radar sensor cannot detect vehicles at close quarters, for example a vehicle that suddenly enters the lane between your vehicle and the target vehicle.
- 2 Small vehicles, such as motorcycles, or vehicles not driving in the center of the lane may remain undetected.
- 3 In curves, the radar sensor may detect the wrong vehicle or lose sight of the target vehicle.

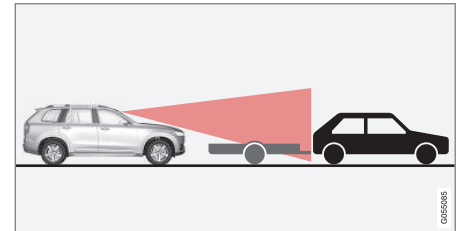

Low trailer in the radar shadow (generic illustration)

Low trailers may also be difficult to detect or may not be detected at all. The driver should be extra alert in situations of this type.

### High temperatures

If the temperature in the passenger compartment is very high, the camera and radar sensor may be temporarily turned off for approx. 15 minutes after the engine has been started to protect their electronic components. When the temperature has cooled sufficiently, the camera and radar sensor will restart automatically.

### Damaged windshield



**CAUTION**

- Service and maintenance on City Safety may only be carried out by a trained and qualified Volvo service technician.
- If a crack, scratch or stone chip should occur in the section of the windshield in front the camera/radar sensor, contact a trained and qualified Volvo service technician to repair or replace the windshield. Failing to do so may result in reduced City Safety functionality.
- This can also result in certain functions being reduced or disabled, or they may respond incorrectly.

To help avoid the risk of incorrect, reduced or disabled functionality for driver support systems using the camera or radar sensors:

- Volvo recommends that cracks, scratches or stone chips on the windshield in front of the camera/radar sensor should **not** be repaired; in such cases, the entire windshield should be replaced.
- Before the windshield is replaced, contact a Volvo retailer to ensure that the correct windshield is ordered and installed. If the wrong type of windshield is used, this may cause City Safety to function improperly or not at all.
- Volvo recommends the use of only Genuine Volvo Replacement Windshields.

- When replacing windshield wipers, use the same type or ones approved by Volvo.

After the windshield has been replaced, the camera/radar sensor will have to be recalibrated by a trained and qualified Volvo service technician to help ensure proper function of all of the vehicle's camera-/radar-based systems.

**Maintenance**

In order for camera and radar sensor to function properly, the area of the windshield must be kept free of dirt, ice, snow, etc. and should be washed regularly with a suitable car washing detergent.

**NOTE**

Dirt, ice and/or snow covering the camera and radar sensors reduce functionality and may disable the vehicle's camera-/radar-based systems.

This can also result in certain functions being reduced or disabled, or they may respond incorrectly.

**Related information**

- Driver support system radar sensor (p. 296)
- Camera limitations (p. 301)
- Pilot Assist limitations (p. 293)
- City Safety limitations (p. 312)

- City Safety limitations (p. 312)
- Road Sign Information (RSI)\* limitations (p. 326)
- Park Assist Pilot (PAP)\* limitations (p. 350)

## Radar sensor - type approval

### USA & Canada:

FCC ID: L2C0054TR IC: 3432A-0054TR FCC  
ID: L2C0055TR IC: 3432A-0055TR

This device complies with Part 15 of the FCC Rules and with Industry Canada license-exempt RSS standard(s). Operation is subject to the following two conditions:

- (1) This device may not cause harmful interference, and
- (2) This device must accept any interference received, including interference that may cause undesired operation.

### WARNING

Changes or modifications not expressly approved by the party responsible for compliance could void the user's authority to operate the equipment.

The term "IC:" before the radio certification number only signifies that Industry Canada technical specifications were met.

### Related information

- Driver support system radar sensor (p. 296)

## Driver support system camera

The camera is used by a number of driver support systems to e.g., detect a driving lane's side marker lines or traffic signs.



Camera location

The camera is used by the following driver support systems:

- Adaptive Cruise Control (ACC)\*
- Driving lane assistance\*
- Driver Alert Control\*
- Pilot Assist\*
- City Safety
- Run-off Mitigation
- Road sign information\*
- Active high beams\*

### Related information

- Camera limitations (p. 301)
- Adaptive Cruise Control (ACC)\* (p. 269)
- Driving lane assistance (p. 328)
- Driver Alert Control (DAC) (p. 326)
- Pilot Assist\* (p. 283)
- City Safety™ (p. 304)
- Run-off Mitigation (p. 333)
- Road Sign Information (RSI)\* (p. 324)
- High and low beam headlights (p. 142)

## Camera limitations

The camera used by several of the driver support systems has certain limitations, which also affect the systems using it.

### Reduced visibility

#### WARNING

- The camera has the same limitations as the human eye. In other words, its “vision is impaired” by adverse weather conditions such as heavy snowfall, dense fog, etc. These conditions may reduce the function of systems that depend on the camera or cause these systems to temporarily stop functioning.
- Strong sunlight, reflections from the road surface, ice or snow covering the road, a dirty road surface, or unclear lane marker lines may drastically reduce the camera’s capacity to detect the side of a lane, a pedestrian, a cyclist, a large animal or another vehicle.

### Obstructions



The marked area must not be obstructed in any way. This area of the windshield should always be kept clean.

The camera is located at the upper, center section of the windshield along with the radar sensor.

#### WARNING

Never place any objects, decals, electronic toll devices, window tinting films etc., on the windshield in front of or around the camera/radar sensor. This could reduce or block these components' functions, and could cause one or more of the systems that utilize them to stop functioning.

This can also result in certain functions being reduced or disabled, or they may respond incorrectly.



If this symbol and the message **Windscreen Sensors blocked** appear in the instrument panel, this indicates that the camera and/or radar sensor cannot detect other vehicles ahead.

The following table shows some of the situations that can cause the message to be displayed and suggested actions.

Cause	Action
The area of the windshield in front of the camera/radar sensor is dirty or covered by ice or snow.	Clean the windshield or remove the ice/ snow.
Thick fog or heavy rain/snow reduces the camera/radar sensor's range of visibility.	No action. The driver should be extra alert in conditions of this type.





Cause	Action
Water or snow on the surface of the road swirl up and block radar signals or the camera's view.	No action. The driver should be extra alert in conditions of this type.
There is dirt between the inside of the windshield and the camera/radar sensor.	Have the area of the windshield cleaned by a trained and qualified Volvo service technician.
Strong backlighting	No action required. The came will reset automatically when lighting conditions improve.

### High temperatures

If the temperature in the passenger compartment is very high, the camera and radar sensor may be temporarily turned off for approx. 15 minutes after the engine has been started to protect their electronic components. When the temperature has cooled sufficiently, the camera and radar sensor will restart automatically.

### Damaged windshield

**! CAUTION**

- Service and maintenance on City Safety may only be carried out by a trained and qualified Volvo service technician.
- If a crack, scratch or stone chip should occur in the section of the windshield in front the camera/radar sensor, contact a trained and qualified Volvo service technician to repair or replace the windshield. Failing to do so may result in reduced City Safety functionality.
- This can also result in certain functions being reduced or disabled, or they may respond incorrectly.

To help avoid the risk of incorrect, reduced or disabled functionality for driver support systems using the camera or radar sensors:

- Volvo recommends that cracks, scratches or stone chips on the windshield in front of the camera/radar sensor should **not**

be repaired; in such cases, the entire windshield should be replaced.

- Before the windshield is replaced, contact a Volvo retailer to ensure that the correct windshield is ordered and installed. If the wrong type of windshield is used, this may cause City Safety to function improperly or not at all.
- Volvo recommends the use of only Genuine Volvo Replacement Windshields.
- When replacing windshield wipers, use the same type or ones approved by Volvo.

After the windshield has been replaced, the camera/radar sensor will have to be recalibrated by a trained and qualified Volvo service technician to help ensure proper function of all of the vehicle's camera-/radar-based systems.

## Maintenance

In order for camera and radar sensor to function properly, the area of the windshield must be kept free of dirt, ice, snow, etc. and should be washed regularly with a suitable car washing detergent.

### **i** NOTE

Dirt, ice and/or snow covering the camera and radar sensors reduce functionality and may disable the vehicle's camera-/radar-based systems.

This can also result in certain functions being reduced or disabled, or they may respond incorrectly.

## Related information

- Driver support system camera (p. 300)
- Radar sensor limitations (p. 297)
- Driving lane assistance (p. 328)
- Driver Alert Control limitations (p. 328)
- Pilot Assist limitations (p. 293)
- City Safety limitations (p. 312)
- Road Sign Information (RSI)\* limitations (p. 326)
- Park Assist Pilot (PAP)\* limitations (p. 350)

## City Safety™

City Safety™ is a support system designed to help alert the driver to pedestrians, cyclists, large animals and vehicles that may appear suddenly in front of your vehicle by providing visual, audible and haptic alerts. The vehicle will brake automatically if the driver is unable to react quickly enough.

### City Safety introduction

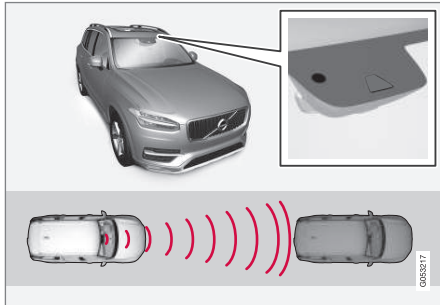

Location of the camera and radar sensor (generic illustration)

City Safety can help prevent a collision or lower the vehicle's speed at the point of impact.

### WARNING

- City Safety™ is a supplemental aid to the driver. It can never replace the driver's attention to traffic conditions or his/her responsibility for operating the vehicle in a safe manner.
- City Safety™ does not function in all driving situations or in all traffic, weather or road conditions.

The City Safety function can help the driver avoid a collision when e.g., there is a sudden change in the traffic ahead if the driver's does not take action.

The function assists the driver by applying the brakes automatically if there is an imminent risk of a collision and the driver does not react in time.

City Safety triggers brief, forceful braking in an attempt to stop your vehicle immediately behind the vehicle or object ahead. This braking may be perceived as being very sudden.

City Safety activates in situations where the driver has not applied the brakes in time, which means that the system cannot help the driver in all situations.

City Safety is designed to intervene as late as possible to help avoid unnecessary activation.

Normally, the occupants of the vehicle will not be aware of City Safety except when the system intervenes when a collision is imminent.

### City Safety parameters

City Safety can help avoid a collision with a **vehicle or cyclist ahead** by reducing your vehicle's speed by up to 30 mph (50 km/h).

In the case of **pedestrians**, City Safety can reduce speed by up to 28 mph (45 km/h).

If the **difference in speed** is greater than 30 mph (50 km/h) or 28 mph (45 km/h) respectively, City Safety's auto-brake function cannot prevent a collision but it can help mitigate the effects of the collision.

If there is a risk of colliding with a **large animal**, City Safety can reduce the vehicle's speed by up to 9 mph (15 km/h). The braking function for large animals is primarily intended to mitigate the force of a collision at higher speeds. Braking is most effective at speeds above 43 mph (70 km/h) and less effective at lower speeds.

**⚠ WARNING**

Warnings will only be provided if there is an imminent risk of a collision taking place. The driver should be aware of the system's limitations before operating the vehicle.

Warnings and automatic braking for pedestrians and cyclists are deactivated at speeds above approx. 43 mph (70 km/h).

City Safety's auto-brake function can help prevent a collision or reduce the speed at which a collision occurs. However, the driver should always apply the brakes, even if auto-brake is operating.

The driver is always responsible for maintaining the correct speed and distance in relation to the vehicle ahead. Never wait for a collision warning or for City Safety to intervene.

City Safety does not activate the auto-brake function during fast acceleration.

City Safety maintenance may only be carried out by a trained and qualified Volvo service technician.

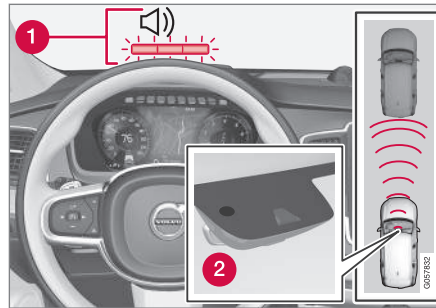

Function overview

- 1** Audio-visual collision warning
- 2** Distance monitoring by a camera and radar sensor

When triggered, City Safety carries out three steps in the following order:

1. **Collision warning**
2. **Brake assistance**
3. **Auto-brake**

**1: Collision warning**

The driver is first alerted to the risk of an imminent collision.

City Safety can detect pedestrians, cyclists or vehicles that are stationary, are moving in the same direction as your vehicle or are in your vehicle's path.

City Safety can also detect pedestrians, large animals or cyclists that are crossing in front of your vehicle.

If there is a risk of a collision with a pedestrian, cyclist, large animal or a vehicle, as well as vehicles described in the article "City Safety in crossing traffic," the driver will be alerted by a flashing red warning signal, an audible signal and a haptic warning in the form of pulsations in the brake pedal. At lower speeds, during hard braking or if the accelerator pedal is pressed, the haptic warning will not be given.

**2: Brake assistance**

If the risk of a collision increases, brake support will be activated.

This function increases pressure on the brake pedal if the driver does not apply enough pressure to the pedal.

**3: Auto-brake**

The brakes will be applied automatically.

If the driver has not taken action at this stage and a collision is imminent, auto-braking will be triggered. Full braking effect will be used to avoid the collision if possible or to make the speed at the point of impact as low as possible.

In certain situations, auto-braking may begin with limited effect before full braking is used.

If City Safety has prevented a collision, the vehicle will be kept at a standstill until the driver



◀◀ takes action. If the vehicle has slowed to avoid colliding with the vehicle ahead, your speed will be reduced to that vehicle's speed.

When auto-brake is triggered, the seat belt pretensioners may also be activated, see the article "Seat belts" for additional information.

Auto-braking can be cancelled if the driver presses hard on the accelerator pedal.

When City Safety applies the brakes, the brake lights will illuminate.

When City Safety is triggered and applies the brakes, a text message will be displayed in the instrument panel.

### Related information

- City Safety™ troubleshooting (p. 310)
- City Safety in crossing traffic (p. 309)
- City Safety limitations (p. 312)
- City Safety symbols and messages (p. 315)
- Detecting obstructions with City Safety (p. 307)
- Rear Collision Warning (RCW) (p. 316)
- City Safety warning level settings (p. 306)
- City Safety in crossing traffic (p. 309)
- Seat belts (p. 60)
- City Safety when evasive action is not possible (p. 310)

## City Safety warning level settings

City Safety is always activated but the function's warning distance can be adjusted.

### NOTE

City Safety cannot be turned off and activates automatically each time the engine is started.

### Setting a warning level (distance)

The distance set for warnings determines the system's responsiveness and sets the distance at which visual, audible and tangible (haptic) warnings will be triggered.

To do so:

1. Tap **Settings** in the center display's Top view.
2. Tap **My Car** → **IntelliSafe** → **City Safety Warning**.
3. Choose among **Earlier**, **Normal** or **Later**.

Begin by choosing **Earlier**. If too many warnings are given, change to **Normal**.

If the driver feels that warnings are given too often, the warning level can be lowered. This means that warnings will be provided later, resulting in fewer warnings being given.

The setting **Later** should only be used in exceptional circumstances, e.g., for a more dynamic driving style.

### WARNING

- No automatic system can be guaranteed to function 100% correctly in all situations. For that reason, never test City Safety by driving toward a person or object. This could result in serious injury or death.
- Even if the setting **Earlier** has been selected, warnings may be perceived as being given late, e.g., if the difference in speed is great or if the vehicle ahead brakes suddenly.
- City Safety can provide a warning for a potential collision but it can never shorten the driver's reaction time.
- To help make City Safety as effective as possible, always use the setting **Earlier** if recommended.

### NOTE

- Due to local traffic regulations in certain markets, Rear Collision Warning (RCW) will **not** activate the rear turn signals. That part of the function will be deactivated.
- The use of the rear turn signals will also be deactivated if the City Safety warning level is set at **Later**. See also the section



"Setting a warning level (distance)" in the article "City Safety settings."

- If RCW detects a vehicle approaching from behind, the seat belt pretensioners and Whiplash Protection System will be activated.

### Related information

- City Safety limitations (p. 312)
- City Safety™ (p. 304)
- Rear Collision Warning (RCW) (p. 316)

## Detecting obstructions with City Safety

City Safety can detect vehicles, cyclists, large animals and pedestrians.

### Vehicles

City Safety detects most types of vehicles that are either stationary, moving in the same direction as your vehicle or those described in the article "City Safety in crossing traffic."

In order for City Safety to detect a vehicle in darkness, its headlights and taillights must be on and clearly visible.

### Cyclists

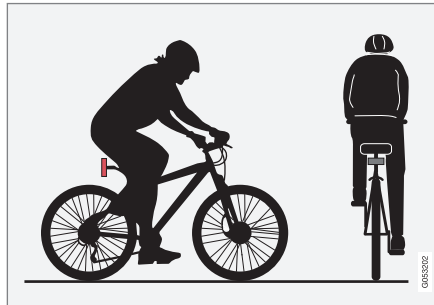

Optimal example of what the system considers to be a cyclist: clear body/bike contours

To help function optimally, City Safety's function for cyclist detection needs clear information about the bike itself and the rider's head, arms,

shoulders, legs, the upper and lower parts of the body and a cyclist's normal pattern of movement.

- If major parts of the cyclist's body are not visible to the camera, the system cannot detect the cyclist.
- The cyclist must be an adult riding a bike intended for an adult.

### **WARNING**

City Safety is designed to be a supplementary driving aid and cannot detect all cyclists in all situations, such as:

- a partially obscured cyclist.
- a cyclist whose clothing prevents a clear view of the person's body contours.
- a cyclist transporting a large object.

The driver is always responsible for operating the vehicle in a safe manner.

## ◀ Pedestrians

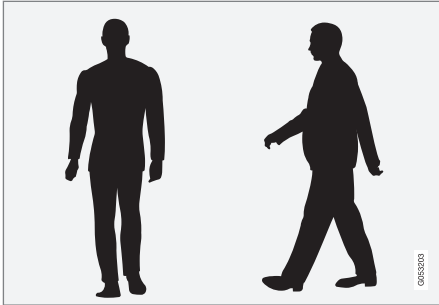

Optimal example of what the system considers to be a pedestrian: clear body contours

To help function optimally, City Safety's function for pedestrian detection needs clear information about the person's head, arms, shoulders, legs, the upper and lower parts of the body and a person's normal pattern of movement.

In order to detect a pedestrian, there must be a contrast to the background. If there is little contrast, the person may be detected late or not at all, which may result in a late or no reaction from the system.

- If major parts of the pedestrian's body are not visible to the camera, he/she may not be detected.
- In order to detect a pedestrian, the system must have a full view of the person's entire

body and the person must be at least 32 in. (80 cm) tall.

- City Safety can also help detect pedestrians in dark conditions if they are in the path of the vehicle's headlights.

### **⚠ WARNING**

City Safety is designed to be a supplementary driving aid.

It cannot detect pedestrians:

- who are partially obscured, wearing clothing that prevents a clear view of the person's body contours or who are not at least 32 in. (80 cm) tall.
- who have limited contrast to their immediate background. A warning or braking may be delayed or not come at all.
- carrying a large object.

The driver is always responsible for operating the vehicle in a safe manner.

## Large animals

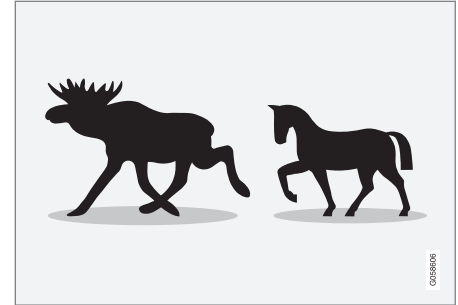

Examples of what City Safety considers to be large animals: stationary or moving slowly with clear body contours

To function optimally, the system feature for detecting large animals (moose, horses, etc.) must receive as clear information about body contours as possible. This entails being able to detect the animal straight from the side and assumes that the animal has a normal pattern of movement.

If parts of the animal's body are hidden from the camera, the system cannot detect this animal.

City Safety can also help detect large animals in dark conditions if they are in the path of the vehicle's headlights.

**⚠ WARNING**

City Safety is designed to be a supplementary driving aid.

It cannot detect large animals in all situations such as:

- large animals that are partially obscured
- large animals straight from the front or rear
- large animals that are running or moving quickly
- large animals that have limited contrast to their immediate background. A warning or braking may be delayed or not come at all.
- smaller animals such as dogs or cats

The driver is always responsible for operating the vehicle in a safe manner.

**Related information**

- City Safety™ (p. 304)
- City Safety limitations (p. 312)
- City Safety in crossing traffic (p. 309)

**City Safety in crossing traffic**

City Safety can help the driver when turning in the path of an oncoming vehicle in an intersection.

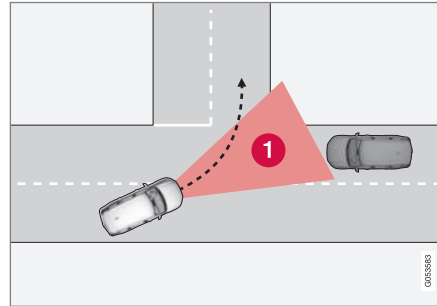
**Turning at an intersection**

1. The area in which City Safety can detect an oncoming vehicle

In order for City Safety to detect an approaching vehicle in situations where there is a risk of a collision, that vehicle must be within City Safety's range (the red area in the illustration).

The following criteria must also be met:

- your vehicle's speed must be at least 3 mph (4 km/h)
- the approaching vehicle's headlights must be on
- your vehicle must be making a left turn

**⚠ WARNING**

- City Safety is a supplementary driving aid and does not function in all driving situations or in all traffic, weather or road conditions.
- Warnings and braking for an approaching vehicle will usually come at a very late stage.
- The driver is responsible for maintaining a safe distance and speed. Never wait for a warning or for City Safety to take action.

**Limitations in crossing traffic**

In certain situations, it may be very difficult for City Safety to help the driver avoid a collision with an approaching vehicle in crossing traffic, for example:

- on slippery roads when Electronic Stability Control is active
- if the approaching vehicle is detected at a late stage
- If the approaching vehicle is partially obscured by another vehicle
- if the approaching vehicle moves erratically (e.g., sudden lane changes at a late stage)

**Related information**

- City Safety™ (p. 304)
- City Safety limitations (p. 312)

## City Safety when evasive action is not possible

City Safety can help the driver by automatically braking the vehicle sooner if it is not possible to steer out of a potential collision situation.

City Safety assists the driver by continuously trying to determine possible "escape routes" to the sides if a slow-moving or stationary vehicle ahead is detected at a late stage.

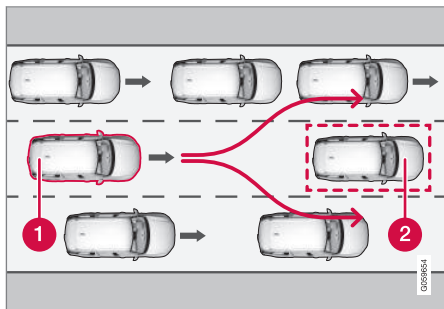

Your vehicle (1) cannot "see" any way of veering to avoid the vehicle ahead (2) and will attempt to auto-brake sooner

- 1 Your vehicle
- 2 Slow moving/stationary vehicle

City Safety will not trigger the auto-brake function as long as the driver has a chance to avoid a collision by steering the vehicle.

However, if City Safety determines that an evasive steering maneuver is not possible due to a lack of space in the adjacent traffic lanes, the function will attempt to assist the driver by automatically applying the brakes considerably sooner.

### **WARNING**

City Safety's capacity to assess certain traffic situations is a supplemental aid to the driver and does not function in all driving/traffic situations or weather/road conditions. It can never replace the driver's attention to traffic conditions or his/her responsibility for operating the vehicle in a safe manner.

### Related information

- City Safety limitations (p. 312)
- City Safety™ (p. 304)

## City Safety™ troubleshooting

Messages pertaining to any possible problems with City Safety will be displayed in the instrument panel.

### Troubleshooting and remedial action

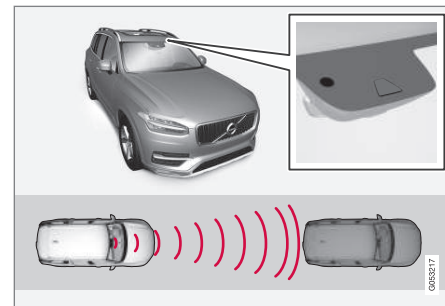

Location of the camera and the radar sensor

If a message is displayed in the instrument panel saying that the camera/radar sensor is blocked, City Safety cannot detect vehicles, cyclists or pedestrians ahead of you, which means that the system is not functioning properly.

However, this message will not be displayed in all situations in which the camera/radar sensor is obstructed. For this reason, the driver must ensure that the area of the windshield in front of the camera/radar sensor is always kept clean.

The following table shows some of the situations that can cause the message to be displayed and suggested actions.

Cause	Action
The area of the windshield in front of the camera/radar sensor is dirty or covered by ice or snow.	Clean the windshield or remove the ice/ snow.
Thick fog or heavy rain/snow blocks reduces the camera/radar sensor's range of visibility.	No action. The driver should be extra alert in conditions of this type.
There is dirt between the inside of the windshield and the camera/radar sensor.	Have the area of the windshield cleaned by a trained and qualified Volvo service technician.

### CAUTION

- Service and maintenance on City Safety may only be carried out by a trained and qualified Volvo service technician.
- If a crack, scratch or stone chip should occur in the section of the windshield in front the camera/radar sensor, contact a trained and qualified Volvo service technician to repair or replace the windshield. Failing to do so may result in reduced City Safety functionality.
- This can also result in certain functions being reduced or disabled, or they may respond incorrectly.

To help avoid the risk of incorrect, reduced or disabled functionality for driver support systems using the camera or radar sensors:

- Volvo recommends that cracks, scratches or stone chips on the windshield in front of the camera/radar sensor should **not** be repaired; in such cases, the entire windshield should be replaced.
- Before the windshield is replaced, contact a Volvo retailer to ensure that the correct windshield is ordered and installed. If the wrong type of windshield is used, this may cause City Safety to function improperly or not at all.
- Volvo recommends the use of only Genuine Volvo Replacement Windshields.

- When replacing windshield wipers, use the same type or ones approved by Volvo.

After the windshield has been replaced, the camera/radar sensor will have to be recalibrated by a trained and qualified Volvo service technician to help ensure proper function of all of the vehicle's camera-/radar-based systems.

### Maintenance

In order for City Safety to function properly, the area of the windshield must be kept free of dirt, ice, snow, etc.

### Other vehicle functions

If a message is displayed in the instrument panel, this means that the other systems using the camera/radar sensor (see the list below) will not have full functionality or may not function at all.

The camera and radar sensor is used by the following functions:

- Distance Alert\*
- Driver Alert Control\*
- Adaptive Cruise Control\*
- Pilot Assist\*
- Run-off Mitigation
- Road Sign Information\*
- Active High Beams\*
- Lane Keeping Aid\*



- ◀◀ Do not mount or in any way attach anything on the windshield that could obstruct the camera/radar sensor.

### **WARNING**

- The camera has the same type of limitations as the human eye, i.e., it cannot see as well in heavy snowfall or rain, thick fog or in heavy blowing dust or snow. In such conditions, systems depending on the camera may experience greatly reduced functionality or may be temporarily deactivated.
- Never place any objects, decals, etc., on the windshield in front of the camera. This could reduce or block the camera's function, and could cause one or more of the systems that utilize the camera to stop functioning.
- Strong sunlight, reflections from the road surface, ice or snow covering the road, a dirty road surface, or unclear lane marker lines may drastically reduce the camera's capacity to detect the side of a lane, a pedestrian, a cyclist or another vehicle.

### **Radar sensor for other functions**

City Safety uses the same radar sensor as Adaptive Cruise Control. See the article "Radar sensor limitations" for detailed information.

### **Related information**

- Radar sensor limitations (p. 297)
- Camera limitations (p. 301)
- City Safety limitations (p. 312)

### **City Safety limitations**

City Safety™ may have limited or reduced functionality in certain situations.

The function has several limitations that the driver should be familiar with:

#### **Low objects**

Hanging objects, such as flags for overhanging loads or accessories such as auxiliary lights or front protective grids that extend beyond the height of the hood may limit City Safety's function.

#### **Slippery driving conditions**

The extended braking distance on slippery roads may reduce City Safety's capacity to help avoid a collision. In situations of this type, the ABS brakes and Electronic Stability Control will help provide braking power and stability.

#### **Backlighting**

Strong sunlight, reflections, extreme light contrasts, the use of sunglasses, or if the driver is not looking straight ahead may make the visual warning signal in the windshield difficult to see.

#### **Heat**

If the temperature in the passenger compartment is very high due to e.g., strong sunlight, the visual warning signal may be temporarily disabled.

### Camera and radar sensor's field of vision

The camera and radar sensor have limited fields of vision. In some situations they may detect a vehicle, large animal, pedestrian or cyclist later than expected or not detect them at all.

Other vehicles that are dirty may be detected later than others and in dark conditions, motorcycles may be detected late or not at all.

If a text message is displayed in the instrument panel indicates that the camera or radar sensor are blocked, it may be difficult for City Safety to detect a vehicle, pedestrian or cyclist and the system's functionality may be reduced.

#### WARNING

Text messages may not be displayed in all situations in which the camera and/or radar sensor are blocked. It is therefore essential to keep the windshield in front the camera/radar sensor clean and free from snow, ice, etc.

Camera and radar sensor components should only be serviced or replaced by a trained and qualified Volvo service technician.

### Action by the driver

#### Backing up

City Safety is temporarily deactivated while the vehicle is backing up.

#### Low speed

City Safety is not activated at very low speeds (under approx. 3 mph (4 km/h)). This means that

the system will not be triggered if your vehicle approaches a vehicle ahead at very low speed, such as when parking.

#### Active driver

Action by the driver always has priority. For this reason, City Safety may not react or react later than expected in situations in which the driver is actively operating the vehicle, even if a collision is imminent. This is also done to help eliminate excessive warnings.

#### Other limitations

City Safety uses the vehicle's camera and radar sensor, which have certain general limitations. See the articles "Camera limitations" and "Radar sensor limitations" for additional information.

#### WARNING

- Warnings and braking may be delayed or not occur at all if traffic, weather or other conditions prevent the camera and/or radar sensor from detecting pedestrians, cyclists, large animals or other vehicles correctly.
- Other vehicles can only be detected in darkness if their headlights and taillights are clearly visible.
- The sensors have a limited range for pedestrians and cyclists. The system functions best at relative speeds up to 30 mph (50 km/h). For stationary or slow-moving vehicles, the system functions best at speeds up to approx. 43 mph (70 km/h).
- If there is a risk of colliding with a large animal, City Safety can reduce the vehicle's speed by up to 9 mph (15 km/h). Warnings and braking are most effective at speeds above 43 mph (70 km/h) and less effective at lower speeds.





## WARNING

- Warnings for stationary or slow-moving vehicles and large animals may be impeded by darkness or poor visibility.
- Warnings and braking for pedestrians and cyclists will not be provided at speeds above approx. 43 mph (70 km/h).
- Do not place, attach or mount any objects on the inside or outside of the windshield near or over the sensor. This could affect the camera-based functions.
- Objects, snow, ice or dirt in the camera's field of vision may result in certain functions being reduced or disabled, or they may respond incorrectly.

### Related information

- City Safety™ (p. 304)
- Adaptive Cruise Control (ACC) - troubleshooting (p. 279)
- City Safety™ troubleshooting (p. 310)
- Camera limitations (p. 301)
- Radar sensor limitations (p. 297)



## City Safety symbols and messages

A number of City Safety-related messages may be displayed in the instrument panel.

Several examples are provided in the following table:

Message	Explanation
Automatic intervention City Safety	When City Safety is braking or has applied the brakes, one of more symbols may illuminate in the instrument panel and a text message will be displayed.
City Safety Reduced functionality Service required	The system is not functioning properly. Contact a trained and authorized Volvo service technician.

A text message can be erased by briefly pressing the **O** button on the right-side steering wheel keypad. If the message recurs, contact a trained and authorized Volvo service technician or retailer.

### Related information

- City Safety™ (p. 304)

## Rear Collision Warning (RCW)

The **Rear Collision Warning (RCW)** function can help the driver avoid rear-end collisions.

RCW is activated automatically each time the engine is started.

RCW can warn the driver of a vehicle approaching yours from behind by rapidly flashing your turn signals.

RCW is only activated when a vehicle is rapidly approaching your vehicle from behind.

At speeds below 20 mph (30 km/h), if RCW determines that your vehicle is at risk of a rear-end collision, the front seat belt pretensioners and the Whiplash Protection System are activated.

Just prior to the collision, the brakes are also applied to help reduce your vehicle's forward movement if and when the collision occurs. However, this can only happen if your vehicle is stationary.

The brakes will be released immediately if the accelerator pedal is pressed.

 <b>NOTE</b>
<ul style="list-style-type: none"><li>• Due to local traffic regulations in certain markets, Rear Collision Warning (RCW) will <b>not</b> activate the rear turn signals. That part of the function will be deactivated.</li><li>• The use of the rear turn signals will also be deactivated if the City Safety warning level is set at <b>Later</b>. See also the section "Setting a warning level (distance)" in the article "City Safety settings."</li><li>• If RCW detects a vehicle approaching from behind, the seat belt pretensioners and Whiplash Protection System will be activated.</li></ul>

### Limitations

In some circumstances, it may be difficult for RCW to help the driver if there is a risk of a collision, such as:

- If the vehicle approaching from the rear is detected at a late stage
- If the vehicle approaching from the rear changes lanes at a late stage
- If the vehicle approaching from the rear is moving at a speed above approx. 50 mph (80 km/h)

### Related information

- City Safety™ (p. 304)
- Whiplash protection system (p. 59)
- Seat belts (p. 60)
- City Safety warning level settings (p. 306)

## Blind Spot Information (BLIS)\*

Blind Spot Information is a system designed to alert the driver to the presence of other vehicles moving in the same direction as your vehicle on roads with several lanes.

Blind Spot Information is a driving aid intended to:

- detect other vehicles in your door mirrors' "blind area"
- detect vehicles that are about to pass your vehicle or are approaching your vehicle quickly from behind in the left and/or right lanes

### WARNING

- Blind Spot Information is an information system, NOT a warning or safety system and does not function in all situations.
- Blind Spot Information does not eliminate the need for you to visually confirm the conditions around you, and the need for you to turn your head and shoulders to make sure that you can safely change lanes or back up.
- As the driver, you have full responsibility for changing lanes/backing up in a safe manner.

## Overview

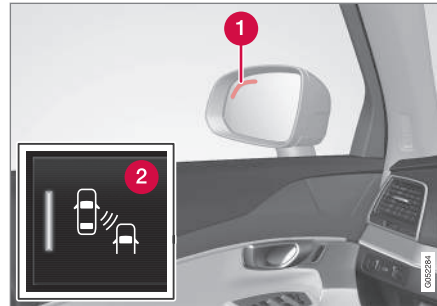

Blind Spot Information indicators

- 1** Indicator light
- 2** BLIS button in the center display's Function view to activate/deactivate the function

The indicator light illuminates on the side of the vehicle where the system has detected another vehicle. If your vehicle is passed on both sides at the same time, both lights will illuminate.

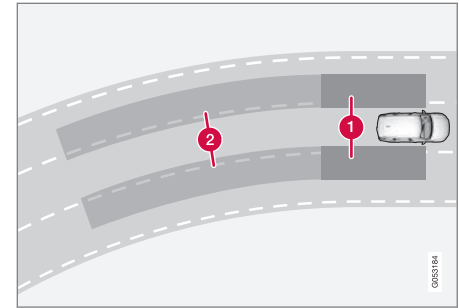

Principle for Blind Spot Information: Zone 1. Blind area, Zone 2. Area for approaching/passing vehicles

Blind Spot Information functions when your vehicle is moving at speeds above approx. 6 mph (10 km/h).

Blind Spot Information is designed to react to:

- vehicles that are passing your vehicle
- other vehicles that are rapidly approaching your vehicle

When Blind Spot Information detects a vehicle in zone 1 or a fast-approaching vehicle in zone 2, the indicator light in the respective door mirror will glow steadily.

If the driver then uses the turn signal on the side on which the warning is given, the indicator light will begin flashing and become brighter.





### **⚠ WARNING**

- Blind Spot Information does not function in sharp curves.
- Blind Spot Information does not function when your vehicle is backing up.

### **Related information**

- Blind Spot Information (BLIS)\* On/Off (p. 318)
- Blind Spot Information (BLIS)\* limitations (p. 319)
- Cross Traffic Alert (CTA)\* (p. 319)

## **Blind Spot Information (BLIS)\* On/Off**

The Blind Spot Information function can be activated/deactivated.

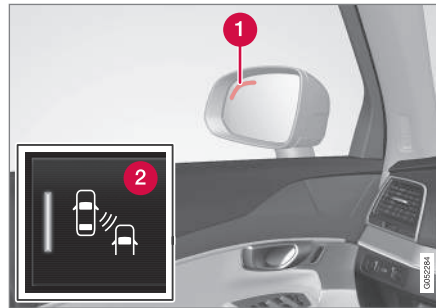

Blind Spot Information indicators

- 1** Indicator light
- 2** Blind Spot Information symbol

Blind Spot Information can be activated/deactivated in the center display's Function view.

- In Function view, tap **BLIS**.
  - > When Blind Spot Information is activated/deactivated, the indicator light in the button will be green/gray.

If BLIS is activated when the engine is started, the indicator lights in the door mirrors will flash once.

If BLIS is deactivated when the engine is switched off, it will remain off the next time the engine is started and the indicator lights in the door mirrors will not illuminate.

### **Related information**

- Blind Spot Information (BLIS)\* (p. 317)

## Blind Spot Information (BLIS)\* limitations

Blind Spot Information functionality may be reduced in certain situations.

- Dirt, ice and snow on the sensors may reduce functionality and prevent the system from providing warnings.
- Do not attach any objects, tape, decals, etc., on the surface of the sensors.
- BLIS is deactivated if a trailer is attached to the vehicle's electrical system.

## Maintenance

The BLIS/CTA<sup>5</sup> sensors are located on the inside of the rear fenders/bumper.

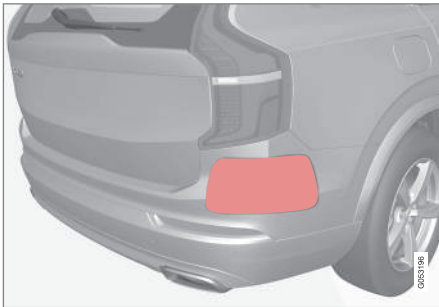

Keep the highlighted area clean (on both sides of the vehicle)

For the system to function optimally, the area over and around the sensors must be kept clean.

### ! CAUTION

Repairs to the BLIS/CTA systems and/or repainting the rear bumper should only be done by a trained and qualified Volvo service technician.

## Related information

- Blind Spot Information (BLIS)\* On/Off (p. 318)
- Blind Spot Information (BLIS)\* (p. 317)
- Cross Traffic Alert (CTA)\* (p. 319)

## Cross Traffic Alert (CTA)\*

Cross Traffic Alert (CTA) is a supplementary part of Blind Spot Information and is intended to detect vehicles crossing behind your vehicle while you are backing up.

### When does Cross Traffic Alert function

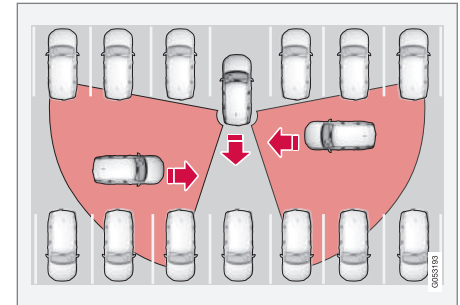

Principle for CTA

CTA supplements BLIS by warning the driver of crossing traffic behind your vehicle, for example, when backing out of a parking space.

It is primarily designed to detect another vehicle but in certain cases may also detect pedestrians or smaller objects such as bicycles.

CTA is only activated when the vehicle is rolling rearward or when the gear selector is put in reverse.

<sup>5</sup> Cross Traffic Alert\*

- ◀◀ If CTA detects that something is approaching your vehicle from the side:
  - An audible signal indicates will sound from either the left or right infotainment system speakers, depending on which the side of your vehicle the approaching vehicle/ object has been detected.
  - An icon illuminates in the Park Assist\* system's graphic in the instrument panel.
  - An icon is also shown in the Park Assist Camera's\* Top view.



Illuminated CTA icon in the Park Assist system's graphic

### Related information

- Activating/deactivating Cross Traffic Alert (CTA)\* (p. 320)
- Blind Spot Information (BLIS)\* with Cross Traffic Alert (CTA)\* symbols and messages (p. 323)

- Cross Traffic Alert (CTA)\* Limitations (p. 321)

### Activating/deactivating Cross Traffic Alert (CTA)\*

Cross Traffic Alert (CTA) can be activated/deactivated separately from Blind Spot Information (BLIS).



CTA is activated/deactivated in the center display's Function view.

- Tap **Cross Traffic Alert** in Function view.
    - > CTA activates/deactivates.
  - Green indicator light: CTA is activated
  - Grey indicator light: CTA is deactivated
- CTA is activated when the engine is started.

**⚠ WARNING**

- BLIS and CTA are information systems, NOT warning or safety systems and do not function in all situations.
- BLIS and CTA do not eliminate the need for you to visually confirm the conditions around you, and the need for you to turn your head and shoulders to make sure that you can safely change lanes or back up.
- As the driver, you have full responsibility for changing lanes/backing up in a safe manner.

**Related information**

- Cross Traffic Alert (CTA)\* (p. 319)
- Blind Spot Information (BLIS)\* On/Off (p. 318)

**Cross Traffic Alert (CTA)\* limitations**

CTA functionality may be reduced in certain situations.

**Limitations**

CTA has limitations in certain situations, for example, the CTA sensors cannot "see" through other parked vehicles or obstructions.

The following are several examples where CTA's "field of vision" may initially be limited and approaching vehicles cannot be detected until they are too close:

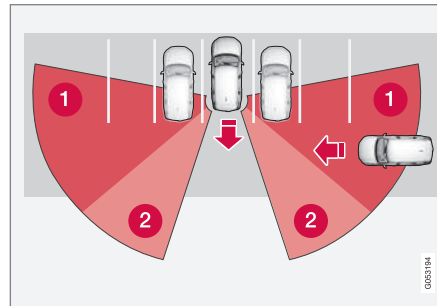

The vehicle is pulled far into a parking space

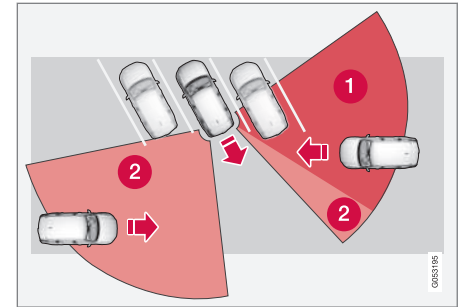

In angled parking spaces, CTA may be "blind" on one side

- ① CTA's blind area
- ② CTA's "field of vision"

However, as you back your vehicle out of a parking space, CTA's "field of vision" expands.

Examples of other limitations include:

- Dirt, ice or snow obstructing the sensors may reduce the system's function or make it impossible to detect other vehicles or objects.
- CTA is deactivated if a trailer's wiring is connected to the vehicle's electrical system.

**Maintenance**

The CTA sensors are located on the inside of the rear fenders/bumper.



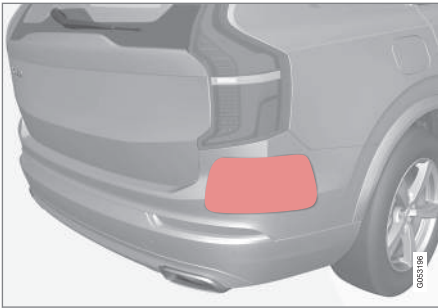

Keep the highlighted area clean (on both sides of the vehicle)

For the system to function optimally, the area over and around the sensors must be kept clean.

Do not attach any objects, tape, decals, etc., on the surface of the sensors.

### **CAUTION**

Repairs to the BLIS/CTA systems and/or repainting the rear bumper should only be done by a trained and qualified Volvo service technician.

### **Related information**

- Cross Traffic Alert (CTA)\* (p. 319)
- Activating/deactivating Cross Traffic Alert (CTA)\* (p. 320)

- Blind Spot Information (BLIS)\* with Cross Traffic Alert (CTA)\* symbols and messages (p. 323)
- Blind Spot Information (BLIS)\* limitations (p. 319)



## Blind Spot Information (BLIS)\* with Cross Traffic Alert (CTA)\* symbols and messages

In situations where Blind Spot Information and/or Cross Traffic Alert are not functioning

properly or if the function is interrupted, a symbol and a text message may be displayed in the instrument panel. Follow the instructions provided.

The following table lists several symbols and messages:

Message	Explanation
Blind spot sensor Service required	The system is not functioning properly. Contact a trained and qualified Volvo service technician
Blind spot system off Trailer attached	BLIS and CTA have been deactivated because a trailer has been connected to the vehicle's electrical system.

A text message can be erased by briefly pressing the **O** button on the right-side steering wheel keypad. If the message recurs, contact a trained and authorized Volvo service technician or retailer.

### Related information

- Cross Traffic Alert (CTA)\* (p. 319)
- Blind Spot Information (BLIS)\* (p. 317)

## Road Sign Information (RSI)\*

RSI is a feature that helps the driver see road signs showing the posted speed limit.

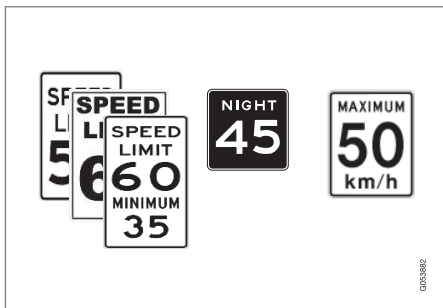

Examples of readable road signs

If the vehicle passes a sign showing the speed limit, this will be displayed in the instrument panel and the head-up display\*.

**i NOTE**

If the vehicle is equipped with the Sensus Navigation system, speed-related information is provided by this system in the following instances:

- In cases where the speed limit is given indirectly (e.g., when driving on highways or other major roads).
- If a previously read speed limit sign is no longer considered valid and no new sign has been passed.

If a third-party navigation system is being used, RSI has no support for speed-related information.

**⚠ WARNING**

RSI does not function in all situations and is only intended to provide supplementary information.

The driver is always responsible for operating the vehicle safely.

### Related information

- Road Sign Information (RSI)\* operation (p. 324)
- Road Sign Information (RSI)\* limitations (p. 326)
- Speed limiter (SL)\* (p. 255)
- Head-up display (HUD)\* (p. 116)

## Road Sign Information (RSI)\* operation

### Speed limit information

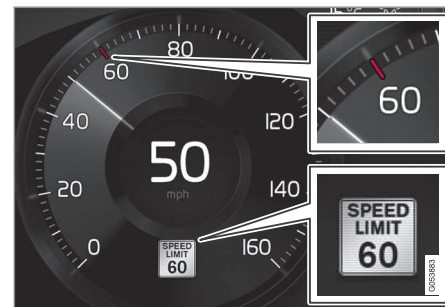

Speed limit information

When RSI registers a road sign showing the speed limit, this sign is displayed as a symbol on the instrument panel.

### Settings

RSI settings can be made in the center display's Top view.

Go to: **Settings** → **My Car** → **IntelliSafe** → **Road Sign Information**.

### Activating/deactivating RSI



RSI can be activated/deactivated in the center display's function view.

- Tap the **Road Sign Information** button in Function view.
  - > When RSI is activated, the indicator light in the button will be green. The indicator light will be gray when the function is deactivated.

### Activating/deactivating the speed warning function

The driver can be alerted if the current speed limit is being exceeded (the symbol for the current speed limit will begin to flash). This function can be activated or deactivated and the limit for a warning can be set.

1. Tap **Settings** in the center display's Top view.
2. Tap **My Car → IntelliSafe → Road Sign Information**.
3. Tap **Speed Limit Warning** to activate/deactivate this function.
  - > If the function is activated, a speed selector will be displayed.

4. Select the limit at which the speed warning is to be given by pressing the up/down arrows.

Please be aware that the set warning limit will not be used when a speed camera symbol is displayed in the instrument panel.

### Activating/deactivating the audible alert

The audible alert can be activated/deactivated and the limit for a warning can be set.

1. Tap **Settings** in the center display's Top view.
2. Tap **My Car → IntelliSafe → Road Sign Information**.
3. Tap **Audio Warning** to activate/deactivate this function.

### Speed camera alert



Speed camera warning in the instrument panel (generic illustration)



If the Sensus navigation system in your vehicle is being used, the driver can be alerted if the vehicle is exceeding a detected speed limit and is approaching a speed camera.

### Related information

- Road Sign Information (RSI)\* (p. 324)
- Road Sign Information (RSI)\* limitations (p. 326)

## Road Sign Information (RSI)\* limitations

The RSI function may be limited in certain situations.

RSI may have difficulty reading signs that are:

- Faded
- Located in a curve
- Twisted or damaged
- Positioned high above the road
- Obstructed (by bushes, etc.)
- Partially covered by snow, ice, etc.
- If the digital maps used by the Sensus Navigation system\* are not up-to-date or do not contain speed information<sup>6</sup>.

The camera used by RSI has certain limitations. See the article "Camera limitations" for additional information.

### **i** NOTE

RSI may perceive certain types of bicycle holders (with wiring attached to the trailer electrical socket) as a trailer, which may result in faulty speed limit information to the driver.

## Related information

- Road Sign Information (RSI)\* (p. 324)
- Road Sign Information (RSI)\* operation (p. 324)
- Camera limitations (p. 301)

## Driver Alert Control (DAC)

DAC is intended to alert the driver if his/her driving becomes erratic due to e.g., distraction or fatigue.

DAC is designed to help detect a slowly changing driving pattern. It is primarily intended to be used on main roads and is not meant for use in city traffic.

The function activates initially when the vehicle's speed first exceeds 40 mph (65 km/h) and remains active as long the speed remains above approx. 37 mph (60 km/h)

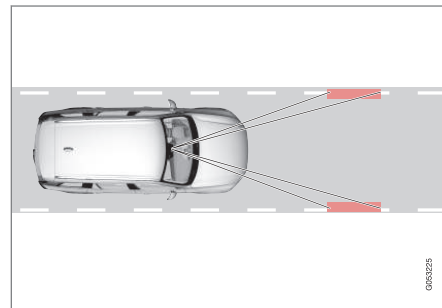

A camera monitors the traffic lane's side marker lines and compares the direction of the road with the driver's movements of the steering wheel.

<sup>6</sup> Speed information is not available in all markets.

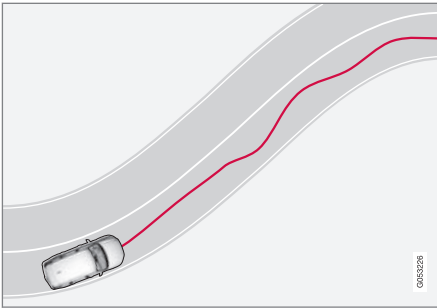

If the driving pattern becomes noticeably erratic, the driver will be alerted by an audible signal and **Driver Alert Time for a break** will appear in the instrument panel along with a symbol.

The warning will be repeated if the driving pattern does not change.

### **WARNING**

- DAC is not intended to extend the duration of driving. Always plan breaks at regular intervals to help remain alert.
- A warning from DAC should not be ignored. A driver may not be aware of how fatigued he/she has become.
- In certain cases, fatigue may not affect the driver's behavior. In situations of this type, no warning will be provided. Therefore, it is important to take breaks at regular intervals, regardless of whether or not DAC has given a warning.

#### **Related information**

- Using Driver Alert Control (DAC) (p. 327)
- Driver Alert Control limitations (p. 328)

### **Using Driver Alert Control (DAC)**

DAC settings are made in the center display's menu system.

#### **Activating/deactivating Driver Alert Control**

1. Tap **Settings** in the center display's Top view.
2. Tap **My Car** → **IntelliSafe** → **Driver Alert Control**.
3. Select **Alertness Warning** to activate/deactivate DAC.

#### **Activating/deactivating guidance to a rest area**

With this feature activated, DAC will propose a nearby rest area if a warning has been given.

1. Tap **Settings** in the center display's Top view.
2. Tap **My Car** → **IntelliSafe** → **Driver Alert Control**.
3. Select **Rest Stop Guidance** to activate/deactivate guidance to a rest area.

#### **Related information**

- Driver Alert Control (DAC) (p. 326)

## Driver Alert Control limitations

Driver Alert Control (DAC) may have limited or reduced functionality in certain situations.

### WARNING

A driving pattern may not change despite driver fatigue, e.g., if a function such as Pilot Assist is being used, which means that DAC will not provide a warning. It is always very important to stop and take a break at the first sign of driver fatigue, even if the system has not provided a warning.

In certain situations, DAC may provide warnings even if the driver's driving pattern has not become erratic:

- in strong crosswinds
- on grooved road surfaces.

### NOTE

DAC uses the vehicle's camera, which has certain general limitations. See the article "Camera limitations" for additional information.

## Related information

- Driver Alert Control (DAC) (p. 326)
- Using Driver Alert Control (DAC) (p. 327)
- Camera limitations (p. 301)
- Pilot Assist\* (p. 283)

## Driving lane assistance

The Lane Assistance functions are designed to help reduce the risk of accidents in situations where the vehicle unintentionally leaves its lane on highways or other major roads.

### Driving lane assistance system

Lane Keeping Aid (LKA) actively steers the vehicle to help keep it in its traffic lane and/or alerts the driver using an audible signal or through vibrations in the steering wheel.

The driving lane assistance system is active at speeds between approx. 40-125 mph (65-200 km/h) on roads with clearly visible traffic lane marker lines. Always observe posted speed limits.

On narrow roads, the system may not function and will go into standby mode. It will return to active mode if the road becomes sufficiently wide.

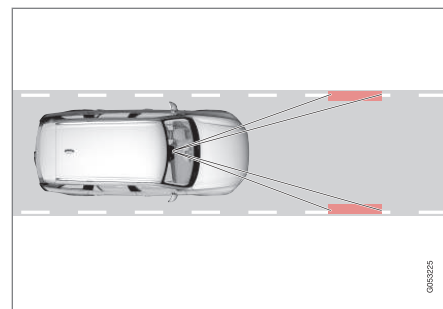

A camera monitors the road/traffic lane's marker lines.

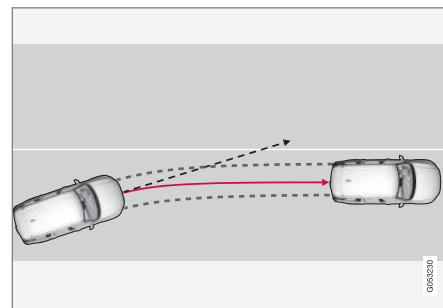

Driving lane assistance attempts to steer the vehicle back into its lane.

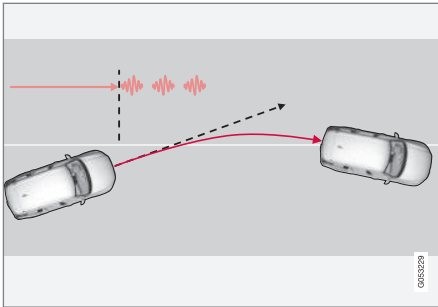

Driving lane assistance provides vibrations in the steering wheel<sup>7</sup>.

Depending on the settings used, Lane Keeping Aid functions in different ways:

- Assistance type **Assist**<sup>8</sup> is activated: when the vehicle approaches a traffic lane marker line, LKA will provide active steering assistance to help steer it back into the lane.
- Assistance type **Warning**<sup>8</sup> is activated: if the vehicle is moving out of its traffic lane, an audible signal and/or vibrations in the steering wheel will be provided.

### **i** NOTE

If the turn signal is used, Lane Keeping Aid will **not** provide an alert or steering assistance.

### **⚠** WARNING

Lane Keeping Aid is only intended to assist the driver and does not function in all driving, weather, traffic or road conditions.

As the driver, you have full responsibility for operating the vehicle in a safe manner.

### Steering assistance

In order for LKA's steering assistance to function, the driver's hands must be on the steering wheel, which the system monitors continuously.

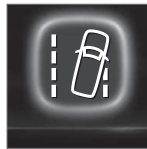

If the driver's hands are not on the steering wheel, this symbol will illuminate in the instrument panel and the following message will be displayed:

### • Lane Keeping Aid – Apply steering

If the driver does not begin to steer the vehicle, the symbol will illuminate again, an audible signal

will sound and the following message will be displayed:

### • Lane Keeping Aid – Standby until steering applied

If the driver still does not begin to steer the vehicle, LKA will go into standby mode. The function will not become available again until the driver actively steers the vehicle

### Traffic lane assistance does not react

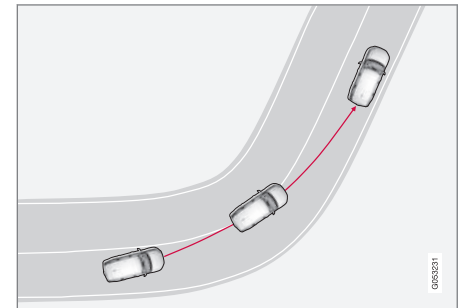

The traffic lane assistance system does not intervene in sharp curves

In certain cases, such as during active driving or if the turn signal is used, the traffic lane system will **not** react if the vehicle crosses a lane marker line.

<sup>7</sup> The level of vibrations varies; the farther the vehicle is over a lane marker line, the greater the number of vibrations:

<sup>8</sup> See "Type of assistance" in the article "Activating/deactivating Lane Keeping Aid".

## ◀ Limitations

In certain demanding driving situations, the driving lane assistance functions may not be able to assist the driver. In these situations, it may be advisable to turn the function off.

Examples of such situations:

- road construction
- winter driving conditions
- poor road surfaces
- a very active driving style
- bad weather with reduced visibility
- edges or lines other than the lane's marker lines
- roads with indistinct or no lane marker lines

The driving lane assistance function use the vehicle's camera, which has general limitations. See the article "Camera limitations."

## Related information

- Activating/deactivating Lane Keeping Aid (LKA) (p. 330)
- Camera limitations (p. 301)
- Run-off Mitigation (p. 333)

## Activating/deactivating Lane Keeping Aid (LKA)

LKA can be activated/deactivated.

### Activating/deactivating



The function can be activated/deactivated in the center display's Function view.

- Tap **Lane Keeping Aid**.
  - > LKA is activated (GREEN indicator light in the button), or is deactivated (GRAY indicator light in the button).

### Type of warning

Choose the type of warning that the driver will receive if the vehicle starts to leave its driving lane.

1. Tap **Settings** in the center display's Top view.
2. Tap **My Car → IntelliSafe → Lane Assistance**.

3. Under **Lane Keeping Aid Warning Feedback**, select:

- **Sound:** an audible warning signal will be provided
- **Vibrations:** the driver will be warned by vibrations in the steering wheel

### Type of assistance

Select the type of assistance LKA should provide:

1. Tap **Settings** in the center display's Top view.
2. Tap **My Car → IntelliSafe → Lane Assistance**.
3. Under **Lane Keeping Aid Mode**, select:
  - **Assist:** the system will provide steering assistance but no warning.
  - **Both:** the system will provide steering assistance and warning
  - **Warning:** the system will provide warning but no steering assistance

### Related information

- Driving lane assistance (p. 328)
- Driving lane assistance symbols and messages (p. 331)



## Driving lane assistance symbols and messages

A number of symbols and messages relating to Lane Keeping Aid (LKA) may appear in the instrument panel.

### Symbols in the instrument panel



The driving lane assistance systems use a symbol in the instrument panel in different situations.

Several examples of the symbol's appearance will be given here:

#### Available



When the driving lane assistance systems are **available**, the marker lines in the symbol will be **white**.

LKA are monitoring the driving lane's marker line(s).

#### Not available

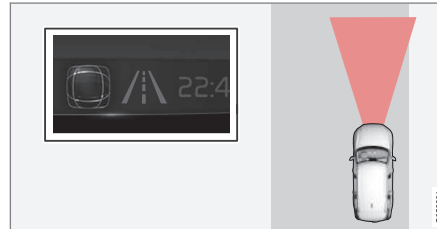

When the driving lane assistance systems are **not** available, the marker lines in the symbol will be **gray**

This is because LKA cannot monitor (detect) the driving lane's marker line(s) or the vehicle's speed is too low or the road is too narrow.

### Steering/warning indicator







Steering/warning: the side marker lines in the symbol will be colored

LKA indicates that the system is warning and/or attempting to steer the vehicle back into its lane.

## ◀ Symbols and messages

The following table lists several LKA-related symbols and messages.

Symbol	Message	Explanation
	<b>Driver support system</b> <b>Reduced functionality Service required</b>	The system is not functioning properly. Contact a trained and qualified Volvo service technician.
	<b>Windscreen sensor</b> <b>Sensor blocked, see Owner's manual</b>	The camera's functionality is limited.
	<b>Lane Keeping Aid</b> <b>Apply steering</b>	LKA's steering assistance does not function if the driver's hands are not on the steering wheel. Steer the vehicle actively.
	<b>Lane Keeping Aid</b> <b>Standby until steering applied</b>	LKA's steering assistance is in standby mode until the driver actively steers the vehicle.

A text message can be erased by briefly pressing the **O** button on the right-side steering wheel keypad. If the message recurs, contact a trained and authorized Volvo service technician or retailer.

### Related information

- Driving lane assistance (p. 328)
- Activating/deactivating Lane Keeping Aid (LKA) (p. 330)

## Run-off Mitigation

Run-off Mitigation is designed to assist the driver by helping return the vehicle to its traffic lane if it is about to go off the road.

Run-off Mitigation is active at speeds between 40–87 mph (65–140 km/h)<sup>9</sup> **on roads with clearly marked edges or side marker lines.**

Run-off Mitigation uses a camera to monitor the edges of a road and its side marker lines. If the vehicle is about to cross the edge of the road or side marker line, Run-off Mitigation will attempt to actively steer the vehicle back onto the road. If the attempt to steer the vehicle is not sufficient, the brakes will also be applied.

Run-off Mitigation does not provide steering or braking assistance if a turn signal is being used. If the function detects that the vehicle is being driven actively, Run-off Mitigation activation may be delayed for a short time.

The function has two activation levels:

- Steering assistance only
- Steering assistance and braking

### Run-off Mitigation with steering assistance only

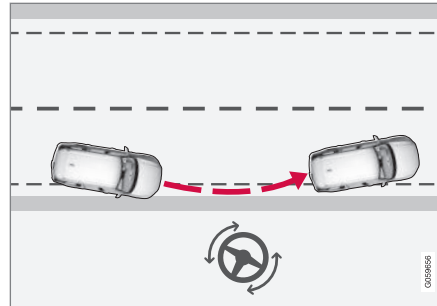

Run-off Mitigation provides steering assistance

### Run-off Mitigation with steering assistance and braking

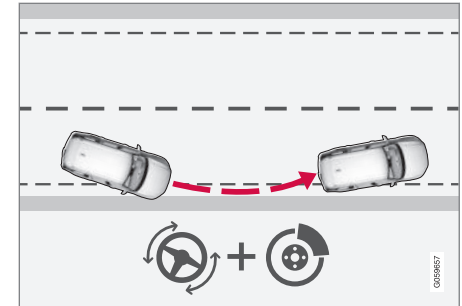

Run-off Mitigation provides steering assistance and braking

Braking is triggered in situations where steering assistance may not be sufficient. Braking effect is modulated automatically depending on the situation when the vehicle begins to run off the road.

### Settings

Run-off Mitigation can be activated/deactivated by pulling down the center display's Top view and navigating to:

**Settings** → **My Car** → **IntelliSafe** → **Lane Assistance**

<sup>9</sup> Always observe posted speed limits.

◀◀ To activate Run-off Mitigation:

- Select (tap) the box for **Collision Avoidance Assistance, Steering aid during increased collision risk.**

The setting selected when the engine was switched off will be used the next time the engine is started.

### Limitations

In certain situations, it may be difficult for Run-off Mitigation to assist the driver. In such cases, it is advisable to deactivate the function.

Examples of these situations include:

- road construction
- winter driving conditions
- poor road surfaces
- narrow roads
- a very active driving style
- bad weather with reduced visibility
- edges or lines other than the lane's marker lines
- roads with indistinct or no lane marker lines

The Run-off Mitigation function use the vehicle's camera, which has general limitations. See the article "Camera limitations".

### WARNING

- Run-off Mitigation is only intended to assist the driver and does not function in all driving, weather, traffic or road conditions.
- This function cannot detect barriers, rails or similar obstructions at the side of a road or traffic lane.
- As the driver, you have full responsibility for operating the vehicle in a safe manner.



### Related information

- Run-off Mitigation\* symbols and messages (p. 335)
- Driving lane assistance (p. 328)
- Camera limitations (p. 301)

## Run-off Mitigation\* symbols and messages

A number of symbols and messages relating to Run-off Mitigation may appear in the instrument panel.

The following table provides several examples:

Symbol	Message	Explanation
	<b>Automatic intervention</b> <b>City Safety</b>	This message indicates that Run-off Mitigation has been activated.
	<b>Driver support system</b> <b>Reduced functionality Service required</b>	The system is not functioning properly. Contact a trained and qualified Volvo service technician.
	<b>Windscreen sensor</b> <b>Sensor blocked, see Owner's manual</b>	The camera's functionality is limited.

### Related information

- Run-off Mitigation (p. 333)

## Park Assist\*

The Park Assist system is designed to assist you when driving into parking spaces, garages, etc. An audible signal and symbols in the instrument panel and center display indicate the distance to the object.



Display view showing object zones and sensor sectors

The center display shows an overview of the vehicle in relation to objects that have been detected.

The highlighted sector shows which of the sensors has detected the object. The closer the highlighted sector is to the vehicle symbol, the closer the actual object is to your vehicle.

The Park Assist system uses an intermittent tone that pulses faster as you come closer to an object. Sound from the infotainment system will be temporarily turned down.

The audible signals for objects in front of and to the sides are active while the vehicle is moving and will stop after the vehicle has been stopped for approx. 2 seconds. The audible signals for objects behind the vehicle are active even when the vehicle has stopped moving.

The audible signal becomes constant when you are within approximately 1 ft (30 cm) of an object and the highlighted sensor field is filled in.

While an audible signal is being given, its volume level can be raised/lowered using the >|| control in the center console or can be adjusted in the center displays Top view under **Settings**.

### NOTE

Audible alerts will only be provided for objects that are directly in the vehicle's path.

### WARNING

Park Assist is an information system, NOT a safety system. This system is designed to be a supplementary aid when parking the vehicle. It is not, however, intended to replace the driver's attention and judgement.

## Rear park assist

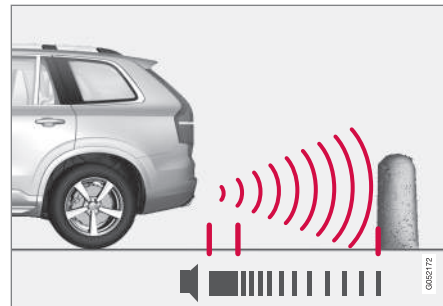

The system's rear sensors are activated automatically when the engine is started and are active if the vehicle rolls rearward with the gear selector in **N** or if **R** has been selected.

The distance monitored behind the vehicle is approximately 5 ft (1.5 m). The audible signal comes from the rear speakers.

The rear sensors will be deactivated automatically when towing a trailer if Volvo genuine trailer wiring is used. If a non-Volvo trailer hitch is being used, it may be necessary to switch off the system manually.

## Side park assist

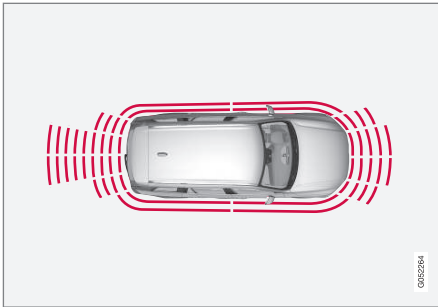

The system's side sensors are activated automatically when the engine is started and are active at speeds below approximately 6 mph (10 km/h).

The distance monitored along the sides of the vehicle is approximately 1 ft (30 cm). The audible signal comes from the side speakers.

## Front park assist

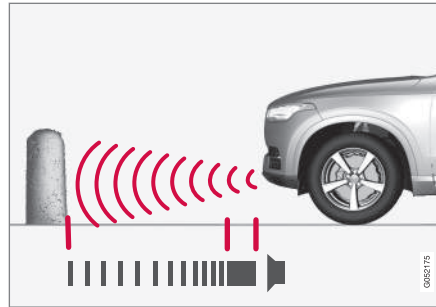

The system's front sensors are activated automatically when the engine is started and are active at speeds below approximately 6 mph (10 km/h).

The distance monitored in front of the vehicle is approximately 2.5 ft (80 cm). The audible signal comes from the front speakers.

Front Park Assist is deactivated if the parking brake is applied or if the gear selector is put in **P**.

When installing auxiliary headlights, be sure that they do not obstruct the front sensors. Otherwise, these lights could trigger a Park Assist warning.

### Related information

- Activating/deactivating Park Assist (p. 337)
- Park Assist limitations (p. 338)
- Park assist symbols and messages (p. 339)

## Activating/deactivating Park Assist

The Park Assist system can be turned on or off.

### On/Off

Park Assist's front and side sensors are activated automatically when the engine is started. The rear sensors activate if the vehicle rolls rearward in **N** or if **R** is selected.



This function can be activated/deactivated in the center display's Function view.

- Tap the **Park Assist** button.
  - > Green indicator: the function is active.
  - Gray indicator: the function is deactivated.

### Related information

- Park Assist\* (p. 336)
- Park Assist limitations (p. 338)
- Park assist symbols and messages (p. 339)

## Park Assist limitations

The Park Assist system has certain limitations.

### **i** NOTE

A trailer hitch whose wiring is integrated with the vehicle's electrical system will be taken into account when measuring the available space behind the vehicle.

### **i** NOTE

- The system will not detect high objects, such as a loading dock, etc.
- Certain materials or fabrics may not be detected by the sensors. Objects made of these materials or people wearing clothing made of these fabrics may not be detected.
- Children or animals near the vehicle may not always be detected.
- Objects such as chains, thin shiny poles or low objects may temporarily not be detected by the system. This may result in the pulsing tone unexpectedly stopping instead of changing to a constant tone as the vehicle approaches the object. In such cases, use caution when backing up or stop the vehicle to help avoid damage.
- In certain circumstances, the park assist system may give unexpected warning signals that can be caused by external sound sources that use the same ultrasound frequencies as the system. This may include such things as the horns of other vehicles, wet tires on asphalt, pneumatic brakes, motorcycle exhaust pipes, other vehicles with similar ultrasound systems, etc. This does not indicate a fault in the system.

## Cleaning the sensors

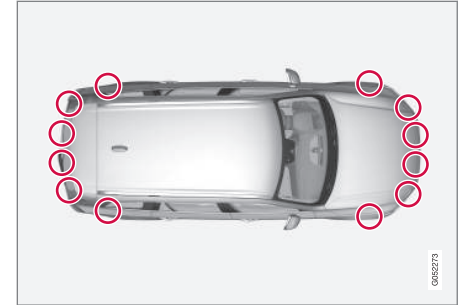

Location of the Park Assist sensors

The sensors must be cleaned regularly to ensure that they work properly. Clean them with water and a suitable car washing detergent.

### **i** NOTE

If the sensors are obstructed by e.g., dirt, snow, or ice, this could result in false warning signals from the park assist system or the system may not function at all.

## Related information

- Park Assist\* (p. 336)
- Activating/deactivating Park Assist (p. 337)
- Park assist symbols and messages (p. 339)



## Park assist symbols and messages

A number of messages relating to Park Assist will appear in the instrument panel.

The following table provides some examples.

Message	Explanation
<b>Park Assist System Unavailable Service required</b>	The system is not functioning properly. Contact a trained and qualified Volvo service technician.
<b>Park Assist System Sensors blocked, cleaning needed</b>	One or more of the system's sensors are blocked. Check and clean the sensors as soon as possible.

A text message can be erased by briefly pressing the **O** button on the right-side steering wheel keypad. If the message recurs, contact a trained and authorized Volvo service technician or retailer.

### Related information

- Park Assist limitations (p. 338)
- Park Assist\* (p. 336)
- Activating/deactivating Park Assist (p. 337)

## Park Assist Camera (PAC)\*

The Park Assist Camera system is designed to provide the driver with a view of the area around the vehicle in the form of a camera image and graphics in the center display.

PAC is a supplementary parking aid that can be activated automatically when the gear selector is in **R** or by tapping a button in the center display, depending on the selected settings. See also the article "Starting the Park Assist Camera."

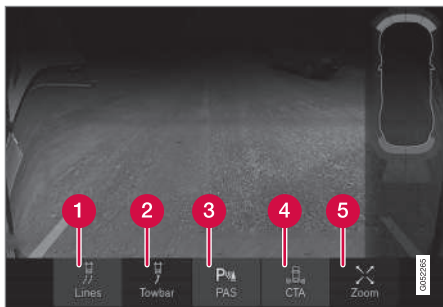

- 1 Lines:** Guiding lines On/Off
- 2 Towbar:** Guiding lines for a trailer hitch\*<sup>10</sup> On/Off
- 3 PAS:** Park Assist On/Off

- 4 CTA:** Cross Traffic Alert\* On/Off
- 5 Zoom:** Zoom in/out<sup>11</sup>

### **i** NOTE

A trailer hitch whose wiring is integrated with the vehicle's electrical system will be taken into account when measuring the available space behind the vehicle.

### **⚠** WARNING

- PAC is designed to be a supplementary aid when parking the vehicle. It is not, however, intended to replace the driver's attention and judgment.
- The camera has blind spots where it cannot detect objects or people around or near the vehicle.
- Pay particular attention to people or animals that are close to the vehicle.
- Objects seen on the screen may be closer than they appear to be.

### Camera views

This function can show a 360° panoramic view as well as separate views for the four respective cameras: front, rear, left, right. The currently

selected camera will be displayed at the top of the view.

### Panorama (360°) view

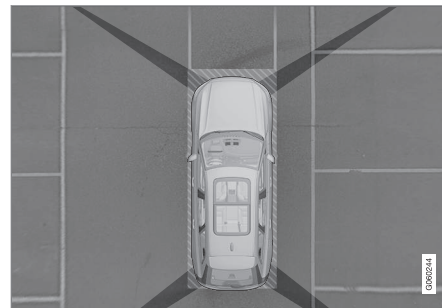

Location of the cameras and their fields of vision

All four sides of the vehicle are shown in the center display to help the driver monitor objects close-by when maneuvering at low speeds.

Each camera view can be displayed separately:

- Tap the center display in the desired "field of vision," e.g., behind the rear camera, etc.

The camera view selected (front/left/right/rear) will be indicated at the top of the graphic.

The cameras can be activated automatically or manually, see the article "Park Assist Camera settings."

<sup>10</sup> Not available in all markets.

<sup>11</sup> Guiding lines will not be displayed while zooming in.

## Backing up



Location of the rear Park Assist Camera (generic illustration)

The rear camera shows a wide area behind the vehicle and on certain models, part of the bumper and the trailer hitch (if installed) will be visible.

Some objects on the screen may appear to “lean” slightly, which is normal.

### **⚠ WARNING**

People/objects/obstructions displayed on the center console screen may be closer to the vehicle than they appear.

## Front camera



Location of the front Park Assist Camera (generic illustration)

The front camera is located behind the grill and can be useful when driving off in areas with limited visibility (hedges, bushes, etc). It is active at speeds up to approx. 16 mph (25 km/h) and is automatically turned off when the vehicle exceeds this speed.

However, if the vehicle's speed does not exceed 30 mph (50 km/h) and its speed goes under 14 mph (22 km/h) within 60 seconds after the camera has been switched off, the front camera will reactivate.

### **i NOTE**

The front camera will only reactivate automatically if **Auto Camera Reverse Activation** has been selected in **Settings → My Car → Park Assist**.

## Side camera



The side cameras are located in the respective door mirrors and show views along the sides of the vehicle.

### **Related information**

- Park Assist Camera (PAC)\* trajectory lines and fields (p. 342)
- Park Assist Camera\* (PAC) limitations (p. 345)
- Starting the Park Assist Camera (PAC)\* (p. 344)



- Park Assist\* (p. 336)
- Cross Traffic Alert (CTA)\* (p. 319)
- Park Assist Pilot (PAP)\* (p. 346)

### Park Assist Camera (PAC)\* trajectory lines and fields

The Park Assist Camera system uses trajectory lines and fields to indicate the vehicle's position in relation to its immediate surroundings.

#### Trajectory lines

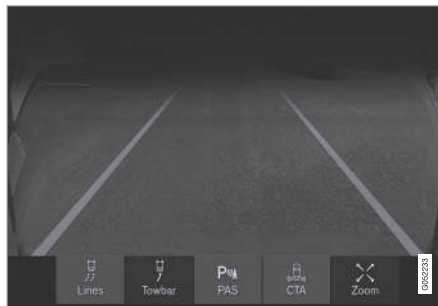

Sample guidelines

The trajectory lines are intended to show the position of the vehicle's outermost dimensions based on the current position of the steering wheel to help simplify parallel parking, backing into tight spaces or when attaching a trailer.

The lines on the screen are projected as if they were a path on the ground around the vehicle and are directly affected by the way in which the steering wheel is turned. This enables the driver to see path the vehicle will take, even if he/she turns the steering wheel.

These lines also indicate the outermost limits that any object (door mirrors, corners of the body, a trailer hitch, etc.) extends out from the vehicle, even when it turns.

#### **i** NOTE

When backing up with a trailer, the trajectory lines show the path that the **vehicle** will take, not the trailer.

Trajectory lines will not be displayed while zooming in.

#### **⚠** WARNING

Keep in mind that when the rear camera has been selected, the image on the screen only shows the area behind the vehicle. The driver must always watch for people, animals, other vehicles, etc., near the sides or the front of the vehicle when turning while backing up.

The opposite is true when the front camera is selected.

Please note that the trajectory lines show the shortest path. Be sure that the vehicle's sides do not come into contact with or scrape against any obstacle/obstruction when the steering wheel is turned while driving forward or that the front of the vehicle does not come into contact with or scrape against any obstacle/obstruction when backing up.

### Models with the 360° panorama camera system and Park Assist sensors\*

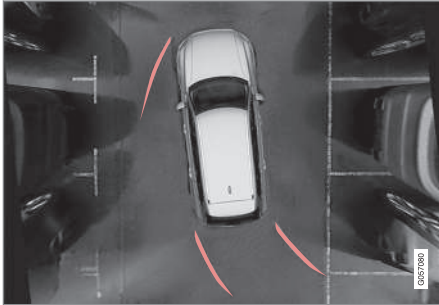

Location of the cameras and their fields of vision (generic illustration)

On models with the 360° panorama camera system, trajectory lines will be shown behind, in front of or to the sides of the vehicle, depending on its direction.

- When driving forward: front lines
- When backing up: side/rear lines

When the front or rear camera is selected, trajectory lines will be shown regardless of the vehicle's direction.

If a side camera is selected, trajectory lines will only be shown if the vehicle is backing up.

### Trajectory lines for a trailer hitch (towbar)

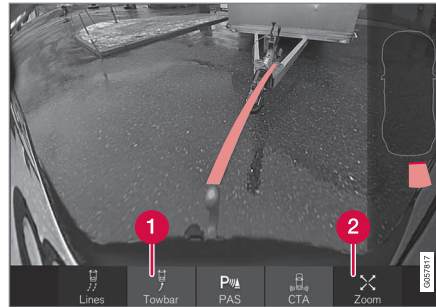

- 1 **Towbar:** activate trajectory lines for a trailer hitch
- 2 **Zoom:** zoom in/out

The camera can help make hitching a trailer easier by showing the "line" that the trailer hitch will take toward the trailer.

1. Tap **Towbar** (1).
  - > The trajectory lines will be displayed and the trajectory lines for the vehicle will disappear.
2. Tap **Zoom** (2) for a close-up view.
  - > The camera will zoom in.

Trajectory lines for the trailer hitch and the vehicle cannot be shown at the same time.

### Front and rear sensor fields

If the vehicle is also equipped with the optional Park Assist system, this information will be displayed on the screen as colored field showing the distance to obstacles that have been detected.

### Front and rear sensors



The screen can display colored sensor fields on the car symbol at the right

The front and rear fields change colors (yellow-orange-red) as the vehicle moves closer to an object.

Front/rear field colors	Distance to the object
Yellow	2.0–4.9 ft (0.6–1.5 m)
Orange	1.3–2.0 ft (0.4–0.6 m)
Red	0–1.3 ft (0–0.4 m)

## ◀ Side sensors

The side fields will only be shown in orange.

Side field color	Distance to the object
Orange	0–1.0 ft (0–0.3 m)

## Related information

- Park Assist Camera (PAC)\* (p. 340)
- Starting the Park Assist Camera (PAC)\* (p. 344)

## Starting the Park Assist Camera (PAC)\*

PAC starts automatically when the gear selector is moved to **R** or can be started manually from the center display.

### Starting the camera

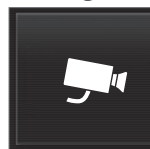

PAC can be started manually in the center display's Function view if it is turned off.

- Tap the **Camera** button.
  - > The camera will start.

### Starting the camera in different situations

When the button is tapped, the vehicle's speed and direction determine if the camera starts in top view or front view:

- Top view: if the vehicle is stationary or is moving forward at speeds up to 9 mph (15 km/h)
- Top view: if the vehicle is stationary or is reversing, regardless of speed
- Front view: if the vehicle is moving forward at speeds between 9–14 mph (15–22 km/h)

## Activating/deactivating automatic start of PAC

PAC can be started automatically when reverse gear is selected.

1. Tap **Settings** in the center display's Top view.
2. Tap **My Car** → **Park Assist**.
3. Select **Auto Camera Reverse Activation** to activate/deactivate automatic start.

### Automatically deactivating the camera

Front view switches off at a speed of approx. 16 mph (25 km/h) to help avoid distracting the driver. If the setting **Auto Camera Reverse Activation** has been selected, the camera's front view will reactivate if the vehicle's speed drops below 14 mph (22 km/h) within 60 seconds. If the vehicle's speed has exceeded 31 mph (50 km/h), front view will not automatically reactivate.

Other camera views switch off at 9 mph (15 km/h) and will not reactivate automatically.

### Selecting the camera's basic view when reversing

With **Auto Camera Reverse Activation** selected, the driver can also choose the camera view to be used when reversing: the rear view or 360° view\*.

1. Tap **Settings** in the center display's Top view.

2. Tap **My Car** → **Park Assist**.
3. Select **Rear View Instead of 360°** to set the rear view as default.

### Related information

- Park Assist Camera (PAC)\* trajectory lines and fields (p. 342)
- Park Assist Camera\* (PAC) limitations (p. 345)
- Ignition modes (p. 380)

## Park Assist Camera\* (PAC) limitations

The Park Assist Camera system has certain limitations that the driver should be aware of.

### NOTE

Bicycle carriers or other accessories mounted on the tailgate may obstruct the camera's field of vision.

### Blind sectors

Even if a fairly small section of the screen image appears to be obstructed, this may mean that a relatively large area is hidden and objects there may not be detected until they are very near the vehicle.

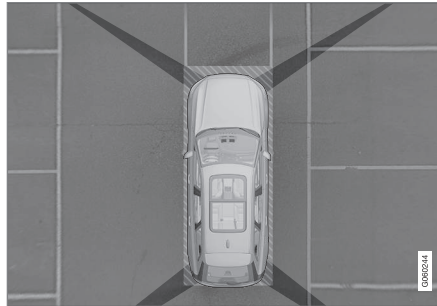

The "blind" sectors between the cameras' fields of vision

With **360° view** selected, objects/obstacles may not be detected at the edges of the individual cameras' fields of vision.

### Defective camera

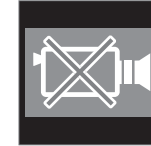

If a camera sector is dark and contains this symbol, this indicates that the camera is not functioning properly (see the following illustration).

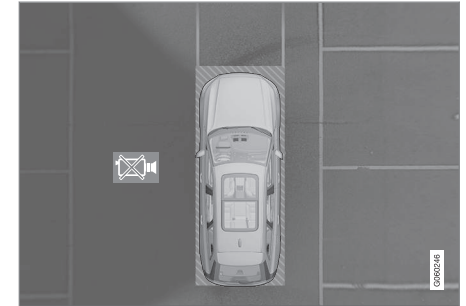

In this example, the driver's side camera is not functioning



### ◀ Dark camera sectors

A dark camera sector may also be displayed in the following situations but **without** the defective camera symbol. A sector may be dark because:

- the door mirror is folded in
- the door is open
- the tailgate is open

### Ambient lighting

The camera images are adjusted automatically to the ambient light, which means the image may vary slightly in terms of light and quality. Poor ambient lighting may reduce the quality of the image.

### Maintenance

- Keep the camera's lens free of dirt, ice and snow. This is particularly important in poor ambient lighting conditions.
- Remove dirt, ice and snow carefully to avoid scratching the lenses.
- Clean the lens regularly with warm water and a suitable car washing detergent.

### Related information

- Park Assist Camera (PAC)\* (p. 340)

### Park Assist Pilot (PAP)\*

Park Assist Pilot (PAP) helps the driver drive into parallel or perpendicular parking spaces and leave parallel parking spaces.

Park Assist Pilot provides assistance when parking by measuring the parking space and turning the steering wheel to guide the vehicle into the space.

Information about the actions required by the driver is provided in the center display in the form of symbols, images and text.

#### **i** NOTE

While PAP is active, the driver's task is to:

- carefully monitor the area around the vehicle
- follow the instructions provided in the center display
- select a gear (**D** or **R**) when prompted
- regulate the vehicle's speed
- apply the brakes when necessary and stop the vehicle

### Types of parking

#### Parallel parking

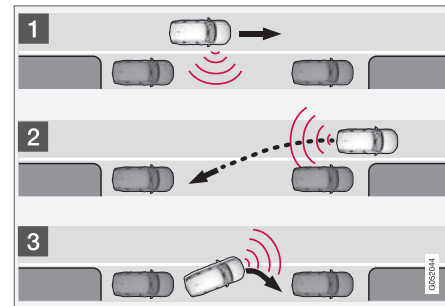

Procedure for parallel parking

PAP helps park the vehicle as follows:

1. The system searches for and measures a possible parking space. While this is being done, the vehicle's speed may not exceed approx. 20 mph ( 30 km/h). When backing into a space, the speed may not exceed approx. 4 mph ( 7 km/h).
2. The vehicle is steered while it is backing into the parking space. The driver controls the vehicle's speed.
3. The vehicle's position in the parking space is adjusted by prompting the driver to move forward and rearward while the system steers.



## Perpendicular parking

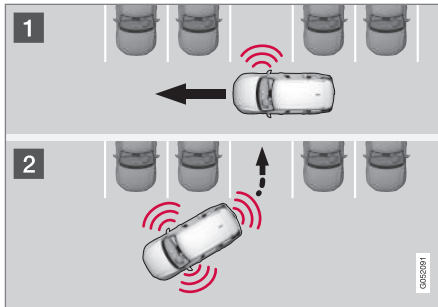

Procedure for perpendicular parking

PAP helps park the vehicle as follows:

1. The system searches for and measures a possible parking space. While this is being done, the vehicle's speed may not exceed approx. 4 mph ( 7 km/h).
2. The vehicle is steered while it is backing into the parking space and its position in the space is adjusted by prompting the driver to select **D** or **R** while the system steers. The driver has to control the vehicle's speed.

### **i** NOTE

PAP's **Park out** function cannot be used to help a vehicle leave a parking space if the **Perpendicular parking** function was used to park the vehicle.

### **!** WARNING

- PAP does not function in all situations and is only intended to assist the driver during parallel or perpendicular parking.
- As the driver, you have full responsibility for parking the vehicle in a safe manner.

### Related information

- Using Park Assist Pilot (PAP)\* (p. 347)
- Park Assist Pilot (PAP)\* limitations (p. 350)
- Park Assist Pilot (PAP)\* symbols and messages (p. 352)

## Using Park Assist Pilot (PAP)\*

Park Assist Pilot (PAP) gives the driver instructions during the parking procedure. The function can also assist when leaving a parking space.

### **i** NOTE

While PAP is active, the driver's task is to:

- carefully monitor the area around the vehicle
- follow the instructions provided in the center display
- select a gear (**D** or **R**) when prompted
- regulate the vehicle's speed
- apply the brakes when necessary and stop the vehicle

Symbols, images and text in the center display indicate when the various steps in the parking procedure will be carried out.

PAP can be activated if the following conditions are met after the engine has started:

- The vehicle may not be towing a trailer.
- The vehicle's speed must be below approx. 20 mph (30 km/h).
- The distance between the vehicle and a parking space must be between 1.6-5.0 ft (0.5-1.5 m)





**i NOTE**  
 If a trailer hitch is configured in the vehicle's electrical system, PAP will take the trailer hitch into consideration when determining the necessary size of a parking space.

**Parking**

Procedure for parking:

1. The system searches for and measures a possible parking space.
2. The vehicle is steered while it is backing into the parking space.
3. The vehicle's position is adjusted in the parking space by moving forward and rearward.

**1: Searching and measuring**

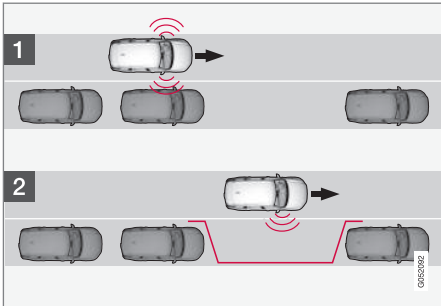

Parallel parking

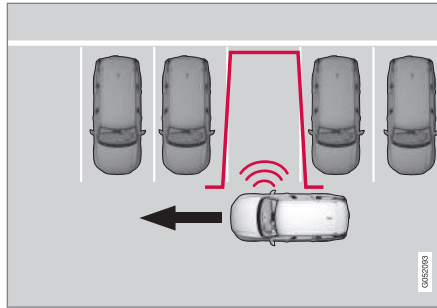

Perpendicular parking

PAP searches for a potential parking space and measures it to see if there is sufficient space for your vehicle. To start this procedure:



1. Tap the **Park In** button in the center display's Function view.

If necessary, slow down to:

- a speed below 20 mph (30 km/h) for parallel parking
- approx. 12 mph ( 20 km/h) for perpendicular parking.

2. Keep an eye on the display and be prepared to stop the vehicle when you are instructed by PAP to do so.
3. Select **Parallel parking** or **Perpendicular parking** and put the transmission in reverse.
4. Keep an eye on the display and be prepared to stop the vehicle when you are instructed by PAP to do so.
5. Stop the vehicle when instructed to do so.

**i NOTE**  
 PAP normally searches for available parking spaces along the curb on the right (passenger's) side of the vehicle. However, it can also assist in finding and parking in spaces on the driver's side. To do so:

- Activate the left turn signal. PAP will then search for a parking space on the left side of the vehicle.

## 2: Backing into the parking space

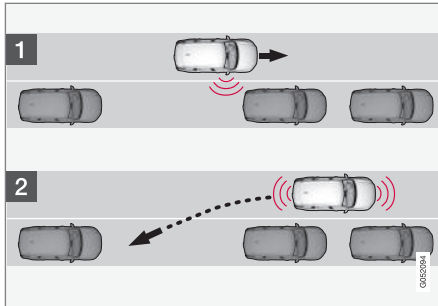

Parallel parking

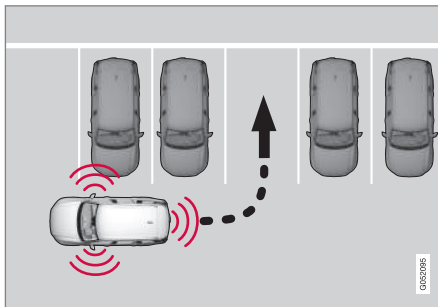

Perpendicular parking

When the vehicle is backing up, PAP will steer it into the parking space. Do as follows:

1. Check that the area behind the vehicle is clear and put the gear selector in **R**.
2. Back up slowly without moving the steering wheel. The vehicle's speed must be below approximately 4 mph (7 km/h).
3. Keep an eye on the instrument panel and be prepared to stop the vehicle when you are instructed by PAP to do so.

### **i** NOTE

- Release the wheel while PAP is steering the vehicle.
- The steering wheel must be able to turn freely.
- For PAP to function optimally, wait until the steering wheel is no longer turning before beginning the next phase of the parking procedure.

## 3: Adjusting the vehicle's position

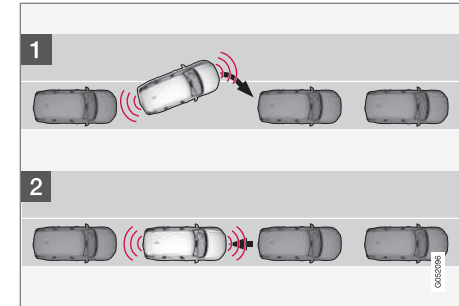

Parallel

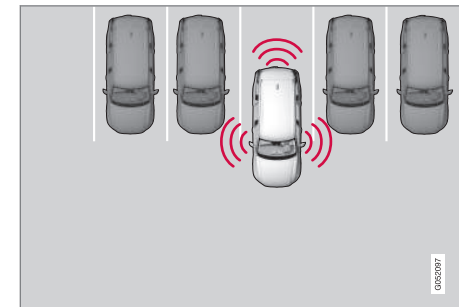

Perpendicular

After the vehicle has backed into the parking space, its position in the space has to be

- ◀ adjusted by driving slightly forward and backing up.
  1. Put the gear selector in **D**, wait until the steering wheel has turned and drive forward slowly.
  2. Stop the vehicle when you are instructed by PAP to do so.
  3. Put the gear selector in **R**, back up slowly and stop when you are instructed by PAP to do so.

When the parking procedure is finished (this will be indicated by a text message and a graphic image), PAP switches off automatically. If necessary, the driver may need to make minor adjustments to ensure that the vehicle is parked correctly.

**! CAUTION**

The warning distance is shorter when PAP is using the sensors than when Park Assist is using them.

### Leaving a parking space

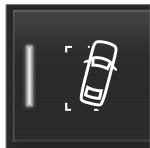

This function can only be used for a vehicle that has been **parallel parked** and is activated in the center display's Function view.

1. Tap the **Park out** button in the center display's Function view.
2. Use the turn signal to indicate the direction in which the vehicle should leave the parking space.
3. Follow the instructions provided in the center display. The procedure is the same as when parking the vehicle.

The steering wheel may turn back slightly when the function is completed and the driver may have to turn the back before leaving the parking space.

If PAP determines that the driver can leave the parking space without assistance, the function will deactivate before the vehicle is completely out of the space.

### Related information

- Park Assist Pilot (PAP)\* (p. 346)
- Park Assist Pilot (PAP)\* limitations (p. 350)
- Park Assist Pilot (PAP)\* symbols and messages (p. 352)

### Park Assist Pilot (PAP)\* limitations

The PAP function may be limited in certain situations.

### The PAP parking sequence is cancelled

A parking sequence will be cancelled:

- if the vehicle is driven too fast: above approx. 4 mph (7 km/h)
- if the driver taps **Cancel** in the center display
- if the driver moves the steering wheel with sufficient force.
- if the anti-lock brakes or Electronic Stability Control are activated (e.g., if a wheel begins to spin or lose traction)

In such cases, a text message will explain why the parking sequence was cancelled.

**i NOTE**

- PAP will not function correctly if its sensors are obstructed by dirt, snow, etc.
- In certain situations, PAP may not be able to measure a parking space. This could be due to external sources of sound (e.g., a vehicle's horn, tires on wet asphalt, pneumatic brakes, noise from a motorcycle's exhaust, etc.) emitting ultrasound using approximately the same frequencies as PAP.

## Points to keep in mind

PAP is a parking aid only and the driver should always be prepared to take control and cancel a parking sequence. This can be due to one or more of the following factors:

- PAP's function is based on the way that the vehicles are parked behind and in front of your parking space. If they are, for example, parked too close to the curb, there is a risk that your vehicle's tires or wheel rims could be damaged by the curb during the parking procedure.
- PAP is intended to provide parking assistance on straight streets, not sections of street with curved or irregular curbs. Be sure that your vehicle is parallel to the curb when PAP measures the parking space.
- PAP may not be able to provide parking assistance on narrow streets due to lack of space to maneuver the vehicle. In situations like this, it may help to drive between 1.5-5.0 ft (0.5-1.5 m) from the side of the road where the parking space is located.
- Use only approved tires with the correct inflation pressure because this affects PAP's capacity to provide parking assistance. Changing to a different approved tire size may affect PAP's parameters. Consult a trained and qualified Volvo service technician.

- Heavy rain or snow may inhibit PAP's capacity to correctly measure a parking space.
- Do not use PAP when using snow chains and/or a temporary spare tire.
- Do not use PAP if there are any objects protruding from the vehicle.

### WARNING

- The front end of your vehicle may turn out toward oncoming traffic during the parking procedure.
- Objects located above the parking sensors' field of vision are not included when PAP measures a parking space. For this reason, PAP may turn into the parking space too soon. Avoid parking spaces of this type.
- The driver is always responsible for determining if PAP has selected a suitable parking space.

## Maintenance

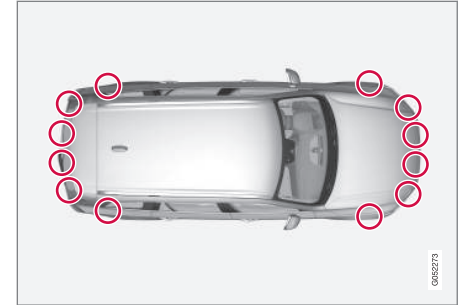

Location of the PAP sensors

In order for PAP to function correctly, these sensors must be cleaned regularly with water and a suitable car washing detergent.

## Related information

- Park Assist Pilot (PAP)\* (p. 346)
- Park Assist Pilot (PAP)\* limitations (p. 350)
- Park Assist Pilot (PAP)\* symbols and messages (p. 352)

## Park Assist Pilot (PAP)\* symbols and messages

Park Assist Pilot uses graphics and text messages to indicate if there is a problem with the system.

Various PAP-related combinations of graphics and text messages are displayed in the instrument panel and sometimes also include suitable actions.

The following table provides some examples.

Message	Explanation
<b>Park Assist System Unavailable Service required</b>	The system is not functioning properly. Contact a trained and qualified Volvo service technician.
<b>Park Assist System Sensors blocked, cleaning needed</b>	One or more of the system's sensors are blocked. Check and clean the sensors as soon as possible.

A text message can be erased by briefly pressing the **O** button in the center of the right-side steering wheel keypad.

Contact a Volvo retailer or a trained and qualified Volvo service technician If a message indicating that PAP is not functioning properly remains displayed or recurs.

### Related information

- Park Assist Pilot (PAP)\* (p. 346)
- Using Park Assist Pilot (PAP)\* (p. 347)
- Park Assist Pilot (PAP)\* limitations (p. 350)

STARTING AND DRIVING

### Starting and driving

The vehicle is equipped with features that supplement its basic functions, such as shifting gears with steering wheel paddles\* and the fuel-conserving start/stop function.

The vehicle is equipped with an automatic transmission that also makes it possible to shift gears manually.

Certain functions can also be used when the engine is not running, depending on the ignition mode being used.

### Related information

- Starting the engine (p. 382)
- Ignition modes (p. 380)
- Automatic transmission (p. 392)
- Opening/closing the fuel filler door (p. 373)
- Start/Stop (p. 389)
- Parking brake (p. 360)

### Brakes

The brake system is a hydraulic system consisting of two separate brake circuits. If a problem should occur in one of these circuits, it is still possible to stop the vehicle with the other brake circuit.

### Brake system

If one of the brake circuits is not functioning, more pressure will be needed on the brake pedal (and the pedal will go down farther) for normal braking effect.

If the brake pedal must be depressed farther than normal and requires greater foot pressure, the stopping distance will be longer.

Pressure on the brake pedal is enhanced by the power braking function.

The power brakes only function when the engine is running.

If the power brakes are not working, considerably higher pressure will be required on the brake pedal to compensate for the lack of power assistance. This can happen for example when towing your vehicle or if the engine is switched off when the vehicle is rolling. The brake pedal feels stiffer than usual.

When the Hill Start Assist function is being used, it will take slightly longer for the brake pedal to return to its normal position if the vehicle is parked on an incline or uneven surface.

When driving in very hilly areas or if the vehicle is carrying a heavy load, manual gear shifting can be used for engine braking to augment the brakes. Use the **Off Road\*** drive mode on steep downgrades to increase the engine braking effect at low speeds.

### Anti-lock Braking System ABS

The ABS system helps to improve vehicle control (stopping and steering) during severe braking conditions by limiting brake lockup.

When ABS is operating, there may be some vibration in the brake pedal, which is normal.

The system performs a brief self-diagnostic test when the engine has been started and driver releases the brake pedal. Another automatic test may be performed when the vehicle first reaches a speed of approximately 6 mph (10 km/h). The brake pedal will pulsate several times and a sound may be audible from the ABS control module, which is normal.

### Cleaning the brake discs

Coatings of dirt and water on the brake discs may result in delayed brake function. This delay is minimized by cleaning the brake linings.

Cleaning the brake pads is advisable in wet weather, prior to long-term parking, and after the vehicle has been washed. Do this by braking gently for a short period while the vehicle is moving.



### Driving on wet or salted roads

Prolonged driving on wet or salted roads can affect brake function and increase stopping distance. Be sure to keep a safe distance to the vehicle ahead when driving under these conditions.

### Brake pad inspection

On vehicles equipped with a jack\*, the condition of the brake pads can be checked by raising the vehicle and performing a visual inspection of the brake pads.





#### WARNING

- If the vehicle has been driven immediately prior to a brake pad inspection, the wheel hub, brake components, etc., will be very hot. Allow time for these components to cool before carrying out the inspection.
- Apply the parking brake and put the gear selector in the Park (P) position.
- Block the wheels standing on the ground, use rigid wooden blocks or large stones.

#### WARNING

- Use the jack intended for the vehicle when changing a tire. For any other job, use stands to support the vehicle.
- The jack should be kept well-greased and clean, and should not be damaged.
- Be sure the jack is on a firm, level, non-slippery surface.
- No objects should be placed between the base of jack and the ground, or between the jack and the attachment bar on the vehicle.
- The jack must correctly engage the jack attachment.
- Never allow any part of your body to be extended under a vehicle supported by a jack.

### Instrument panel symbols

Symbol	Explanation
 A	Check the brake fluid level. If the level is low, top up and have the system inspected to determine the cause of the loss of fluid.
 B	
 A	Steady glow for 2 seconds when the engine is started: automatic function control.  Steady glow for more than 2 seconds: there is a fault in the ABS system. The normal brake system will still function but without ABS brake modulation.
 B	

A US models

B Canadian models



## ⚠ WARNING

If both symbols illuminate at the same time and the brake level is **below** the **MIN** mark in the reservoir or if a brake system-related message is shown in the instrument panel: **DO NOT DRIVE**. Have the vehicle towed to a trained and qualified Volvo service technician and have the brake system inspected.

If both symbols illuminate at the same time and the brake level is **normal** (not below the **MIN** mark in the reservoir) or if a brake system-related message is shown in the instrument panel: drive the vehicle carefully to an authorized Volvo workshop and have the brake system inspected by a trained and qualified Volvo service technician.

### Related information

- Brake functions (p. 356)
- Brake assist system (p. 357)
- Emergency brake lights (p. 358)

## Brake functions

The vehicle's standard braking features are augmented by a number of auxiliary help functions.

In addition to the wheel brakes and the parking brake, the vehicle is equipped with several automatic brake assist functions. These systems help the driver by e.g., keeping the vehicle stationary when the brake pedal is not depressed (at a traffic light or intersection), when starting up a hill or when driving down a hill.

These systems include:

- Auto-hold brakes
- Hill Start Assist
- Braking assist after a collision
- Hill Descent Control\*

### Related information

- Brakes (p. 354)
- Parking brake (p. 360)
- Hill Descent Control (HDC) (p. 358)
- Auto-hold brake function (p. 356)

## Auto-hold brake function

With the Auto-hold brake function, the driver can release the brake pedal and the brakes will remain applied, for example, when the vehicle has stopped at a traffic light or intersection.

When the vehicle is no longer moving forward, Auto-hold applies the brakes automatically, either using the normal brakes or the parking brake. The brakes will be released when the accelerator pedal is depressed.

If the driver's door is opened or the engine is turned off, the parking brake will be applied automatically.

Auto-hold is deactivated when the transmission is in neutral or if the driver's door is open and the seat belt is unbuckled.

### Auto-hold control





Auto-hold control and indicator light

Turn Auto-hold on or off by pressing the control in the tunnel console. The indicator light illuminates when the function is on.

When Auto-hold is off, Hill Start Assist (HSA) will be activated to help prevent the vehicle from rolling backwards when starting up a hill.

### Instrument panel symbol

Symbol	Explanation
	The symbol in the instrument panel illuminates when this function is using the normal brakes to keep the vehicle stationary.
	This symbol in the instrument panel illuminates when Auto-hold is using the parking brake to keep the vehicle stationary.

A US models

B Canadian models

### Related information

- Hill Start Assist (p. 360)
- Brake functions (p. 356)

### Brake assist system

The Brake Assist System (BAS) increases braking force, thereby helping reduce braking distance.

The system monitors the driver's braking habits and increases braking force when necessary. Brake force can be increased up to the point at which the ABS system is activated. The function is deactivated when pressure on the brake pedal decreases.

### Related information

- Brakes (p. 354)

### Braking effect after a collision

In certain types of collisions, the vehicle's brakes are applied to help prevent or mitigate a secondary collision.

Maintaining control of the vehicle after a collision may be difficult. To help avoid or mitigate the effect of a secondary collision, the brakes are applied automatically to help bring the vehicle to a stop.

The brake lights and hazard warning flashers will be activated and the flashers will remain on after the vehicle has come to a standstill. The parking brake will then be applied automatically.

In a situation where stopping the vehicle may not be desirable, the driver can override this system by pressing the accelerator pedal.

This feature can only function if the brake system is intact after the collision.

### Related information

- Brake functions (p. 356)
- Airbag system (p. 65)
- Rear Collision Warning (RCW) (p. 316)

## Emergency brake lights

The emergency brake lights activate in the event of hard braking/rapid deceleration at most normal driving speeds or if the ABS system is activated. This function causes an additional taillight on each side of the vehicle to illuminate to help alert vehicles traveling behind.

Once the emergency brake lights have been activated, if the driver releases the brake pedal, the brake lights will return to their normal function.

### Related information

- Brakes (p. 354)
- Hazard warning flashers (p. 146)
- Brake lights (p. 146)

## Hill Descent Control (HDC)

HDC is a type of low-speed automatic engine brake and makes it possible to increase or decrease the vehicle's speed on steep downhill gradients using only the accelerator pedal, without applying the brakes.

HDC is particularly useful when driving down steep hills with rough surfaces, and where the road may have slippery patches.

### WARNING

HDC does not function in all situations, and is a supplementary braking aid. The driver has full responsibility for driving in a safe manner.

### Function

HDC allows the vehicle to roll forward or in reverse at very low speed with enhanced engine braking. However, speed can be adjusted to a higher level with the accelerator pedal. When the accelerator pedal is released, the vehicle will return to very low speed regardless of the steepness of the hill and without applying the brakes. The brake lights illuminate when HDC is functioning.

The driver can use the brakes to slow or stop the vehicle at any time.

HDC is activated along with Low Speed Control (LSC), which together make driving on slippery surfaces at low speeds easier.

When HDC and LSC are activated, this changes the response from the accelerator pedal and engine.

### Activating HDC

This function can be activated in different ways, depending on how the vehicle is equipped.

### Using the drive mode control\*



Select the **Off Road** drive mode to activate the function.

Select a different drive mode to turn HDC off. If this is done while the vehicle is on a steep downgrade, engine braking will decrease gradually.

**From the center display's Function view**

Models without the drive mode control have a button for **Hill Descent Control** in the center display's Function view.

- Tap the button to activate. A light in the button illuminates when the function is activated.

**i NOTE**

HDC can be used:

- **Automatic gear shifting:** in Drive or Reverse.
- **Manual gear shifting:** in gears 1 or 2. It is not possible to manually shift to a higher gear when HDC is active.

**i NOTE**

The function is deactivated when driving at higher speeds and must be reactivated at lower speeds if so desired.

**Related information**

- Brake functions (p. 356)
- Low Speed Control (LSC)\* (p. 359)
- Drive modes\* (p. 384)

**Low Speed Control (LSC)\***

Low Speed Control (LSC) helps make off-road driving easier on slippery surfaces when towing a trailer on grass, etc. This feature is part of the **Off Road** drive mode.

When driving at low speeds, LSC prioritizes low gears and all wheel drive to help avoid wheel spin and to improve traction on slippery surfaces. The accelerator pedal and engine react differently to make low-speed driving easier.

In models equipped with the drive mode control\*, LSC is part of the **Off Road** drive mode.

It is activated along with Hill Descent Control (HDC), which increases engine braking to help keep vehicle speed low and smooth, even driving down steep hills.

**Activating LSC**

This function can be activated in different ways, depending on how the vehicle is equipped.

**Using the drive mode control\***

Select the **Off Road** drive mode to activate the function.

Select any other drive mode to turn it off.



◀◀ **From the center display's Function view**



Models without the drive mode control have a button for **Hill Descent Control** in the center display's Function view.

- Tap the button to activate.
  - > A light in the button illuminates when the function is activated.

**i NOTE**

The function is deactivated when driving at higher speeds and must be reactivated at lower speeds if so desired.

**Related information**

- Brake functions (p. 356)
- Hill Descent Control (HDC) (p. 358)
- Drive modes\* (p. 384)

**Hill Start Assist**

Hill Start Assist (HSA) helps prevent the vehicle from rolling backwards when starting up a hill. If you are backing up a hill, HSA helps prevent the vehicle from rolling forward.

HSA makes it easier to start or back up on a hill by retaining pressure on the brake pedal for several seconds after the pedal has been released in order to keep the vehicle at a standstill.

The brakes will be released after several seconds or when the driver presses the accelerator pedal.

HSA is available even if the Auto-hold braking function is turned off.

**Related information**

- Brake functions (p. 356)
- Auto-hold brake function (p. 356)

**Parking brake**

The electric parking brake helps to keep the vehicle stationary when it is parked.



Parking brake control in the tunnel console between the front seats

**i NOTE**

- A faint sound from the parking brake's electric motor can be heard when the parking brake is being applied. This sound can also be heard during the automatic function check of the parking brake.
- The brake pedal will move slightly when the electric parking brake is applied or released.

If the vehicle is not moving when the parking brake is applied, only the rear wheels are affected.

ted. If it is applied while the vehicle is moving, the normal brakes are used on all four wheels. The brakes will only be applied on the rear wheels once the vehicle has stopped.

### Related information

- Brake functions (p. 356)
- Using the parking brake (p. 361)
- Parking brake malfunctions (p. 363)

## Using the parking brake



The electric parking brake helps to keep the vehicle stationary when it is parked.

### Applying the parking brake



1. Put the gear selector in **P**.
2. Press firmly on the brake pedal.
3. Pull up the control.
  - > The symbol in the instrument panel will illuminate when the parking brake has been fully applied.
4. Release the brake pedal and ensure that the vehicle is stationary.

### Symbol in the instrument panel

Symbol	Explanation
	The symbol flashes while the parking brake is being applied.
	If the symbol flashes at any other time, this indicates a fault. See the message in the instrument panel.

A US models

B Canadian models

### Automatic function

The parking brake is applied automatically:

- If the Auto Hold function is activated and the vehicle has been stationary for approx. 5 minutes.
- If the gear selector is moved to **P** on a steep hill.
- When the engine is turned off (this function can be selected, see "Parking brake settings" below).

### Emergency braking

In an emergency, the parking brake can be applied when the vehicle is moving by pressing and holding up the control. Braking will be interrupted when the control is released.

An audible signal will sound during this procedure if the vehicle is moving at higher speeds.

## ◀◀ Releasing the parking brake



### Releasing manually

1. Press firmly on the brake pedal.
2. Press the control.
  - > This releases the parking brake and the symbol in the instrument panel will go out.

### Releasing automatically

1. The driver must fasten his/her seat belt.
2. Start the engine.
3. Press firmly on the brake pedal.
4. Move the gear selector to **D** or **R** and press the accelerator pedal.
  - > This releases the parking brake and the symbol in the instrument panel will go out.

**i NOTE**

- For safety reasons, the parking brake is only released automatically if the engine is running and the driver is wearing a seat belt.
- The electric parking brake will be released immediately when the accelerator pedal is pressed and the gear selector is in position **D** or **R**.

### Parking on a hill

Put the gear selector in **P**.

- If the vehicle is pointing **uphill**, turn the front wheels so that they point away from the curb.
- If the vehicle is pointing **downhill**, turn the front wheels so that they point toward the curb.

The parking brake should also be applied.

**⚠ WARNING**

Always apply the parking brake when parking on hills or uneven surfaces.

### Heavy load uphill

A heavy load, such as a trailer, can cause the vehicle to roll backward when the parking brake is released automatically on a steep incline. To help avoid this:

1. Keep the electric parking brake control pushed in.
2. While pressing the accelerator pedal to pull away, release the parking brake control only after the vehicle begins to move.

### Parking brake settings

Automatically setting the parking brake can be turned on or off in the center display's Top view.

1. Tap **Settings** in Top view.
2. Tap **My Car** → **Parking Brake and Suspension** and deselect **Auto Activate Parking Brake**.

### Related information

- Parking brake (p. 360)
- Parking brake malfunctions (p. 363)
- Auto-hold brake function (p. 356)



## Parking brake malfunctions

If it has not been possible to apply or release the parking brake after several attempts, consult a trained and authorized Volvo service technician or retailer.

An audible signal will sound if the parking brake is applied when the vehicle is being driven. If the vehicle must be parked while the parking brake is not functioning properly:

- Put the gear selector in **P**.
- If the vehicle is pointing **uphill**, turn the front wheels so that they point away from the curb.
- If the vehicle is pointing **downhill**, turn the front wheels so that they point toward the curb.
- Put the gear selector in **P**.





## Low battery charge level

If the battery is discharged, the parking brake cannot be operated. Connect an auxiliary battery to the vehicle.

## Replacing brake pads

The rear brake pads have to be replaced by a trained and authorized Volvo service technician due to the design of the electric parking brake.

## Symbols in the instrument panel

Symbol	Explanation
 A	If the symbol flashes, a parking brake fault has been detected. See the message in the instrument panel.
 B	
 A	Fault in the brake system.
 B	

A US models

B Canadian models

## Related information

- Using the parking brake (p. 361)
- Using the parking brake (p. 361)
- Brake functions (p. 356)
- Jump starting (p. 374)

## Before a long distance trip

It is always worthwhile to have your vehicle checked by a trained and qualified Volvo service technician before driving long distances. Your retailer will also be able to supply you with bulbs, fuses, spark plugs and wiper blades for your use in the event that problems occur.

As a minimum, the following items should be checked before any long trip:

- Check that engine runs smoothly and that fuel consumption and the oil level are normal.
- Check for fuel, oil, and fluid leakage.
- Check condition of drive belts.
- Check state of the battery's charge.
- Examine tires carefully (including the spare tire where applicable), and replace those that are worn. Also, check tire inflation pressure.
- The brakes, front wheel alignment, and steering gear should be checked by a trained and qualified Volvo service technician only.
- Check all lights, including high beams.
- Reflective warning triangles are legally required in some states/provinces.
- Have a word with a trained and qualified Volvo service technician if you intend to drive

in countries where it may be difficult to obtain the correct fuel.

- Consider your destination. If you will be driving through an area where snow or ice are likely to occur, consider using snow tires.

### **Driving economically**

Better driving economy can be obtained by **thinking ahead, avoiding rapid starts and stops and adjusting the speed of your vehicle to immediate traffic conditions.**

#### **Economical driving conserves natural resources**

**Observe the following rules:**

- Bring the engine to normal operating temperature as soon as possible by driving with a light foot on the accelerator pedal for the first few minutes of operation. A cold engine uses more fuel and is subject to increased wear.
- Whenever possible, avoid using the vehicle for driving short distances. This does not allow the engine to reach normal operating temperature.
- Drive carefully and avoid rapid acceleration and hard braking.
- Use the transmission's Drive (**D**) position as often as possible and avoid using kick-down.
- Using the engine's Eco function can help improve fuel economy.
- Do not exceed posted speed limits.
- Avoid carrying unnecessary items (extra load) in the vehicle.
- Maintain correct tire pressure. Check tire pressure regularly (when the tires are cold).

- Use tires recommended by Volvo for your vehicle.
- Remove snow tires when threat of snow or ice has ended.
- Note that roof racks, ski racks, etc, increase air resistance and also fuel consumption.
- At highway driving speeds, fuel consumption will be lower with the air conditioning on and the windows closed than with the air conditioning off and the windows open.
- Using the onboard trip computer's fuel consumption modes can help you learn how to drive more economically.

**Other factors that decrease gas mileage are:**

- Dirty air cleaner
- Dirty engine oil and clogged oil filter
- Dragging brakes
- Incorrect front end alignment

Some of the above mentioned items and others are checked at the standard maintenance intervals.

#### **Handling and roadholding**

- Vehicle load, tire design and inflation pressure all affect vehicle handling. Therefore, check that the tires are inflated to the recommended pressure according to the vehicle load. Loads should be distributed so that

capacity weight or maximum permissible axle loads are not exceeded.

- At the specified curb weight your vehicle has a tendency to understeer, which means that the steering wheel has to be turned more than might seem appropriate for the curvature of a bend. This ensures good stability and reduces the risk of rear wheel skid. Remember that these properties can alter with the vehicle load. The heavier the load in the cargo compartment, the less the tendency to understeer.

#### Related information

- ECO drive mode (p. 387)
- Tire inflation pressure table (p. 545)
- Volvo and the environment (p. 15)

### Driving through standing water

The vehicle should be driven with extreme caution if it is necessary to drive through standing water.

The vehicle can be driven through water up to a depth of approximately 17.7 in. (45 cm) at walking speed. Be particularly careful when driving through flowing water.

- Take particular care when driving through flowing water.
- After driving through water, apply the brakes and check that they are functioning correctly.
- Clean the electrical connections for trailer wiring after driving in mud or water.
- When driving through water, maintain low speed and do not stop in the water.
- Avoid driving through salt water if at all possible to help avoid the risk of corrosion.

#### CAUTION

- Engine damage will occur if water is drawn into the air cleaner.
- Damage to any components, the engine, transmission, turbo-charger, differential or its internal components caused by flooding, vapor lock or insufficient oil is not covered under warranty.
- Do not allow the vehicle to stand in water up to the door sills longer than absolutely necessary. This could result in electrical malfunctions.
- If the engine has been stopped while the vehicle is in water, do not attempt to restart it. Have the vehicle towed out of the water.

#### WARNING

- Avoid driving through standing or rushing water. Doing so can be dangerous and it may also be difficult to determine the actual depth of the water.
- If water cannot be avoided, after driving through the water, press lightly on the brake pedal to ensure that the brakes are functioning normally. Water or mud can make the brake linings slippery, resulting in delayed braking effect.

## ◀◀ Related information

- Towing recommendations (p. 369)

## Overheating the engine and transmission

In demanding driving conditions, such as when transporting heavy loads, driving in mountainous areas or in very hot weather there is a risk of overheating the engine or transmission.

- The engine's output may be slightly limited if there is a risk of overheating.
- Remove e.g., auxiliary lights mounted in front of the grille in hot weather.
- If the temperature of the engine coolant becomes too high, the warning symbol will illuminate and the message **Engine temperature/Stop safely** will be displayed. Stop the vehicle as soon as possible in a safe place and let the engine idle for several minutes.
- If the message **Engine temperature/High temperature Turn off engine** or **Engine coolant/Stop safely** is displayed, stop safely and turn off the engine.
- If the transmission begins to overheat, an alternative gear shifting program will be selected. An integrated protective function will also be activated, the warning symbol will illuminate and the message **Transmission warm/High temperature Reduce speed** or **Transmission warm/Stop safely, wait for cooling** will be displayed in the instrument panel.

- The air conditioning may be switched off temporarily.
- After a prolonged period of driving, do not turn off the engine immediately after stopping.
- The engine cooling fan commonly continues to run for several minutes after the engine has been turned off.

### **WARNING**

The cooling fan (located at the front of the engine compartment, behind the radiator) may start or continue to operate (for up to 6 minutes) after the engine has been switched off.

## Related information

- Driving with a trailer (p. 376)
- Before a long distance trip (p. 363)

## Winter driving

Check your vehicle before the approach of cold weather.

The following advice is worth noting:

- Make sure that the engine coolant contains 50 percent antifreeze. Any other mixture will reduce freeze protection. This gives protection against freezing down to  $-31\text{ }^{\circ}\text{F}$  ( $-35\text{ }^{\circ}\text{C}$ ). The use of "recycled" antifreeze is not approved by Volvo. Different types of antifreeze must not be mixed.
- Volvo recommends using only genuine Volvo antifreeze in your vehicle's radiator.
- Try to keep the fuel tank well filled – this helps prevent the formation of condensation in the tank. In addition, in extremely cold weather conditions it is worthwhile to add fuel line de-icer before refueling.
- The viscosity of the engine oil is important. Oil with low viscosity (thinner oil) improves cold-weather starting as well as decreasing fuel consumption while the engine is warming up. Full synthetic OW-30 oil is recommended for driving in areas with sustained low temperatures.
- The load placed on the battery is greater during the winter since the windshield wipers, lighting, etc., are used more often. Moreover, the capacity of the battery decreases as the temperature drops. In very cold weather, a poorly charged battery can freeze and be

damaged. It is therefore advisable to check the state of charge more frequently and spray an anti-rust oil on the battery posts.

- Volvo recommends the use of snow tires on all four wheels for winter driving.
- To prevent the washer fluid reservoir from freezing, add washer solvents containing antifreeze. This is important since dirt is often splashed on the windshield during winter driving, requiring the frequent use of the washers and wipers. Volvo Washer Solvent should be diluted as follows: Down to  $14\text{ }^{\circ}\text{F}$  ( $-10\text{ }^{\circ}\text{C}$ ): 1 part washer solvent and 4 parts water Down to  $5\text{ }^{\circ}\text{F}$  ( $-15\text{ }^{\circ}\text{C}$ ): 1 part washer solvent and 3 parts water Down to  $0\text{ }^{\circ}\text{F}$  ( $-18\text{ }^{\circ}\text{C}$ ): 1 part washer solvent and 2 parts water Down to  $-18\text{ }^{\circ}\text{F}$  ( $-28\text{ }^{\circ}\text{C}$ ): 1 part washer solvent and 1 part water.
- Use Volvo Teflon Lock Spray in the locks.
- Avoid using de-icing sprays as they can cause damage to the locks.

### Related information

- Snow tires and chains (p. 459)

## Towing eyelet

When used, the towing eyelet should always be securely attached in the openings on the right side of the front and rear bumpers. There are covers over these attachment points.

### Using the towing eyelet

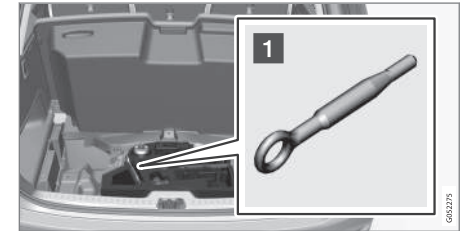

- 1 Take out the towing eyelet, which is stored under the floor in the cargo compartment.

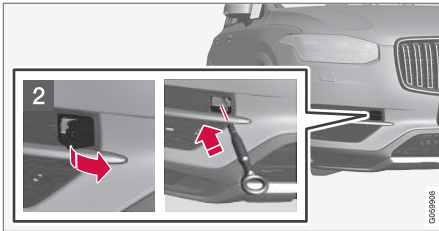

- 2** Front bumper: Carefully pry open the cover by inserting a small screwdriver or the remote key's removable key blade into the groove on its left side.
- > The cover turns along its center line and then be removed.

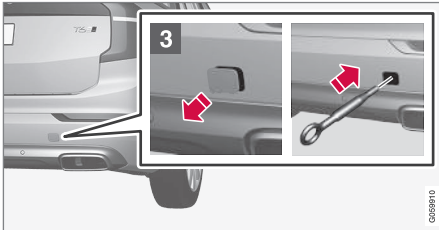

- 3** Rear bumper: Remove the cover by pressing the mark with a finger and folding out the upper right corner with a coin, etc.
- > The cover turns along its center line and then be removed.

4. Screw the towing eyelet into place, first by hand and then using the tire iron, etc. until it has been screwed into place **as far as possible**.

After use, the eyelet should be removed and returned to its storage location.

Reinsert the cover into the bumper.

**! CAUTION**

**In certain conditions, the towing eyelet may be used to pull the vehicle onto a flatbed tow truck.**

- The vehicle's position and ground clearance determine if it can be pulled up onto a flatbed tow truck using the towing eyelet.
- If the angle of the tow truck's ramp is too steep or the ground clearance under the vehicle is insufficient, damage could occur by attempting to pull the vehicle using the towing eyelet.
- If necessary, lift the vehicle using the tow truck's lifting device.

**! WARNING**

No person or object should be behind the tow truck while the vehicle is being pulled up onto the flatbed.

**Related information**

- Towing recommendations (p. 369)

## Towing recommendations

Always check with state and local authorities before attempting to tow another vehicle because this type of towing is subject to regulations regarding maximum towing speed, length and type of towing device, lighting, etc.

### Towing your vehicle behind another vehicle

1. After securely attaching the towing line to both vehicles, put the gear selector in position **N** and release the parking brake.
2. Put the ignition in mode **II** by turning the start knob to **START (without depressing the brake pedal)** and hold it in this position for approx. 4 seconds. Release the knob.
3. Put the gear selector in position **N** and release the parking brake.
4. The towing vehicle can now begin driving.
5. Keep the tow rope taut when the towing vehicle slows down by applying light pressure on the brake pedal. This will help prevent jarring movements of the vehicle being towed.
6. Be prepared to apply the brakes to stop the vehicle being towed.

### CAUTION

General towing precautions:

- If the vehicle's battery is dead, an auxiliary battery will be necessary to provide current for releasing the electric parking brake and to move the gear selector from the **P** position to **N**. If this is not possible, use the shiftlock override procedure to manually release the gear selector from **P** and move it to **N**.
- Maximum speed: 50 mph (80 km/h). Do not exceed the maximum allowable towing speed.
- Maximum distance with front wheels on ground: 50 miles (80 km).
- The vehicle should only be towed in the forward direction.

### WARNING

- When the vehicle is being towed, the ignition should be in mode **II** (in mode **I**, all of the vehicle's airbags are deactivated).
- The remote key must remain inside the vehicle.
- The power brakes and power steering will not function when the engine is not running. Approximately 5 times more pressure will be required on the brake pedal and the steering wheel will be considerably harder to turn.
- The towing eyelets must not be used for pulling the vehicle out of a ditch or for any similar purpose involving severe strain.

◀ **Tow trucks**

**! CAUTION**

**In certain conditions, the towing eyelet may be used to pull the vehicle onto a flatbed tow truck.**

- The vehicle's position and ground clearance determine if it can be pulled up onto a flatbed tow truck using the towing eyelet.
- If the angle of the tow truck's ramp is too steep or the ground clearance under the vehicle is insufficient, damage could occur by attempting to pull the vehicle using the towing eyelet.
- If necessary, lift the vehicle using the tow truck's lifting device.

**⚠ WARNING**

No person or object should be behind the tow truck while the vehicle is being pulled up onto the flatbed.

**Vehicle with pneumatic suspension\***

If the vehicle is equipped with the optional pneumatic suspension, this feature must be deactivated before the vehicle is lifted onto a tow truck.

To do so:

1. Tap **Settings** in the center display's Top view.
2. Tap **My Car** → **Suspension** .
3. Select **Disable Leveling Control**.

**! CAUTION**

The towing eyelet is only intended for use if the vehicle is on a road, **not** if it is off the road surface or stuck in mud, snow, etc. In these cases, contact professional towing help.

**Jump starting**

Do not attempt to start the engine by towing the vehicle. This could result in damage to the three-way catalytic converter. Use a 12-volt auxiliary battery or one in another vehicle.

**⚠ WARNING**

**PROPOSITION 65 WARNING!**

Battery posts, terminals, and related accessories contain lead and lead compounds, chemicals known to the state of California to cause cancer and reproductive harm. Wash hands after handling.

**! CAUTION**

Connect the jumper cables carefully to avoid short circuits with other components in the engine compartment.

**⚠ WARNING**

- Do not connect the jumper cable to any part of the fuel system or to any moving parts. Avoid touching hot manifolds.
- Batteries generate hydrogen gas, which is flammable and explosive.
- Battery fluid contains sulfuric acid. Do not allow battery fluid to contact eyes, skin, fabrics or painted surfaces. If contact occurs, flush the affected area immediately with water. Obtain medical help immediately if eyes are affected.
- Never expose the battery to open flame or electric spark.
- Do not smoke near the battery.
- Failure to follow the instructions for jump starting can lead to injury.

**Related information**

- Towing eyelet (p. 367)
- Jump starting (p. 374)
- Parking brake (p. 360)
- Ignition modes (p. 380)



## Fuel

Volvo recommends the use of detergent gasoline to control engine deposits.

### Deposit control gasoline (detergent additives)

Detergent gasoline is effective in keeping injectors and intake valves clean. Consistent use of deposit control gasolines will help ensure good drivability and fuel economy. If you are not sure whether the gasoline contains deposit control additives, check with the service station operator.

#### NOTE

Volvo does not recommend the use of external fuel injector cleaning systems.

### Unleaded fuel

Each Volvo has a three-way catalytic converter and must use only unleaded gasoline. U.S. and Canadian regulations require that pumps delivering unleaded gasoline be labeled "UNLEADED". Only these pumps have nozzles which fit your vehicle's filler inlet. It is unlawful to dispense leaded fuel into a vehicle labeled "unleaded gasoline only". Leaded gasoline damages the three-way catalytic converter and the heated oxygen sensor system. Repeated use of leaded gasoline will lessen the effectiveness of the emission control system and could result in loss of emission warranty coverage. State and local vehicle

inspection programs will make detection of mis-fueling easier, possibly resulting in emission test failure for misfueled vehicles.

#### NOTE

Some U.S. and Canadian gasolines contain an octane enhancing additive called methylcyclopentadienyl manganese tricarbonyl (MMT). If such fuels are used, your Emission Control System performance may be affected, and the Check Engine Light (malfunction indicator light) located on your instrument panel may light. If this occurs, please return your vehicle to a trained and qualified Volvo service technician for service.

### Gasoline containing alcohol and ethers, "Oxygenated fuels"

Some fuel suppliers sell gasoline containing "oxygenates" which are usually alcohols or ethers. In some areas, state or local laws require that the service pump be marked indicating use of alcohols or ethers. However, there are areas in which the pumps are unmarked. If you are not sure whether there is alcohol or ethers in the gasoline you buy, check with the service station operator. To meet seasonal air quality standards, some areas require the use of "oxygenated" fuel.

Volvo allows the use of the following "oxygenated" fuels; however, the octane ratings listed must still be met.

### Alcohol – Ethanol

Fuels containing up to 10% ethanol by volume may be used. Ethanol may also be referred to as Ethyl alcohol, or "Gasohol".

Ethers – MTBE: Fuels containing up to 15% MTBE may be used.

### Methanol

Do not use gasolines containing methanol (methyl alcohol, wood alcohol). This practice can result in vehicle performance deterioration and can damage critical parts in the fuel system. Such damage may not be covered under the New Vehicle Limited Warranty.

### Related information

- Octane rating (p. 372)
- Opening/closing the fuel filler door (p. 373)

## Octane rating

Volvo requires premium fuel (91 octane or above) for best performance.

## Minimum octane



Sample fuel pump octane label

## TOP TIER Detergent Gasoline

Volvo endorses the use of "TOP TIER Detergent Gasoline" where available to help maintain engine performance and reliability. TOP TIER Detergent Gasoline meets a new standard jointly established by leading automotive manufacturers to meet the needs of today's advanced engines. Qualifying gasoline retailers (stations) will, in most cases, identify their gasoline as having met the "TOP TIER Detergent Gasoline" standards.

**NOTE**

Information about TOP TIER Detergent Gasoline is available at [www.toptiergas.com](http://www.toptiergas.com).

**NOTE**

When switching to higher octane fuel or changing gasoline brands, it may be necessary to fill the tank more than once before a difference in engine operation is noticeable.

## Fuel Formulations

Do not use gasoline that contains lead as a knock inhibitor, and do not use lead additives. Besides damaging the exhaust emission control systems on your vehicle, lead has been strongly linked to certain forms of cancer.

Many fuels contain benzene as a solvent. Unburned benzene has been strongly linked to certain forms of cancer. If you live in an area where you must fill your own gas tank, take precautions. These may include:

- standing upwind away from the filler nozzle while refueling
- refueling only at gas stations with vapor recovery systems that fully seal the mouth of the filler neck during refueling
- wearing neoprene gloves while handling a fuel filler nozzle.

## Use of Additives

With the exception of gas line antifreeze during winter months, do not add solvents, thickeners, or other store-bought additives to your vehicle's fuel, cooling, or lubricating systems. Overuse may damage your engine, and some of these additives contain organically volatile chemicals. Do not needlessly expose yourself to these chemicals.

**WARNING**

Never carry a cell phone that is **switched on** while refueling your vehicle. If the phone rings, this may cause a spark that could ignite gasoline fumes, resulting in fire and injury.

**WARNING**

Carbon monoxide is a poisonous, colorless, and odorless gas. It is present in all exhaust gases. If you ever smell exhaust fumes inside the vehicle, make sure the passenger compartment is ventilated, and immediately return the vehicle to a trained and qualified Volvo service technician for correction.

## Related information

- Fuel (p. 371)

## Opening/closing the fuel filler door

The fuel tank has a filling system that does not have a cover.

## Opening/closing the fuel filler door

The vehicle must be unlocked before the fuel filler door can be opened.



An arrow next to the fuel pump symbol in the instrument panel indicates the side of the vehicle where the fuel filler door is located.

1. Open the fuel filler door by pressing lightly on its rear edge.
2. After refueling, close the fuel filler door by pressing lightly.

## Refueling from a service station pump

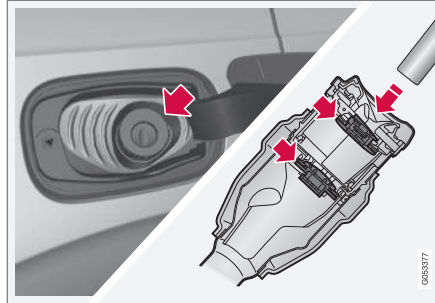

To refuel:

1. Open the fuel filler door. Do not refuel with the engine running<sup>1</sup>
2. Insert the pump's nozzle into the fuel filler pipe's opening **as far as possible** (see the illustration).
3. Avoid overfilling the fuel tank. Do not press the handle on the filler nozzle after it has stopped pumping. Too much fuel in the tank in hot weather conditions can cause the fuel to overflow. Overfilling could also cause damage to the emission control systems.

## CAUTION

Avoid spilling gasoline during refueling. In addition to causing damage to the environment, gasolines containing alcohol can cause damage to painted surfaces, which may not be covered under the New Vehicle Limited Warranty.

## Related information

- Fuel (p. 371)
- Octane rating (p. 372)

<sup>1</sup> If the engine is running when the vehicle is refueled, the Check Engine Light (malfunction indicator lamp) may indicate a fault. However, your vehicle's performance will not be affected.

## Emission controls

### Three-way catalytic converter

- Keep your engine properly tuned. Certain engine malfunctions, particularly involving the electrical, fuel or distributor ignition systems, may cause unusually high three-way catalytic converter temperatures. Do not continue to operate your vehicle if you detect engine misfire, noticeable loss of power or other unusual operating conditions, such as engine overheating or backfiring. A properly tuned engine will help avoid malfunctions that could damage the three-way catalytic converter.
- Do not park your vehicle over combustible materials, such as grass or leaves, which can come into contact with the hot exhaust system and cause such materials to ignite under certain wind and weather conditions.
- Excessive starter cranking (in excess of one minute), or an intermittently firing or flooded engine can cause three-way catalytic converter or exhaust system overheating.
- Remember that tampering or unauthorized modifications to the engine, the Engine Control Module, or the vehicle may be illegal and can cause three-way catalytic converter or exhaust system overheating. This includes: altering fuel injection settings or components, altering emission system components

or location or removing components, and/or repeated use of leaded fuel.

#### **i** NOTE

Unleaded fuel is required for vehicles with three-way catalytic converters.

### Heated oxygen sensors

The heated oxygen sensors monitor the oxygen content of the exhaust gases. Readings are fed into a control module that continuously monitors engine functions and controls fuel injection. The ratio of fuel to air into the engine is continuously adjusted for efficient combustion to help reduce harmful emissions.

### Related information

- Octane rating (p. 372)

## Jump starting

Follow the instructions provided here to jump start your vehicle or to jump start another vehicle.

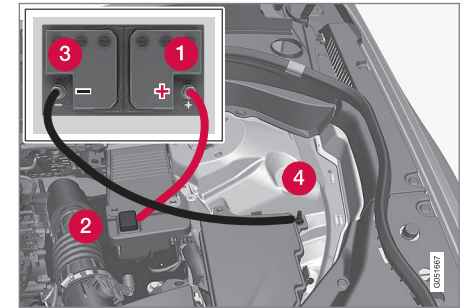

Jumper cable connecting points

If the **12-volt auxiliary battery** to be used is in another vehicle, check that the vehicles are not touching to prevent premature completion of a circuit. Be sure to follow jump starting instructions provided for the other vehicle.

1. Switch off the ignition in your vehicle (set the ignition to mode **0**).

- If the **12-volt auxiliary battery** to be used is in another vehicle, switch off that vehicle's ignition while the jumper cables are being attached. Be sure to follow jump starting instructions provided for the other vehicle.

### CAUTION

Connect the jumper cables carefully to avoid short circuits with other components in the engine compartment.

- Connect one of the red jumper cable's clamps to the auxiliary battery's positive (+) terminal (1).
- Fold back the cover over the positive (+) jump start terminal on your vehicle's battery (2).
- Connect the red jumper cable's other clamp to your vehicle's positive (+) jump start terminal (2).
- Connect one of the black jumper cable's clamps to the auxiliary battery's negative (-) terminal (3).
- Connect the black jumper cable's other clamp to your vehicle's negative ground point (4).
- Check that the jumper cables are securely attached.

- Start the engine in the assisting vehicle and run it at approx. 1,500 rpm.
- Start the engine in the vehicle with dead battery.
- After the engine has started, carefully remove the negative (-) terminal jumper cable (black). Then remove the positive (+) terminal jumper cable (red).

### WARNING

#### PROPOSITION 65 WARNING!

Battery posts, terminals, and related accessories contain lead and lead compounds, chemicals known to the state of California to cause cancer and reproductive harm. Wash hands after handling.

### WARNING

- Do not connect the jumper cable to any part of the fuel system or to any moving parts. Avoid touching hot manifolds.
- Batteries generate hydrogen gas, which is flammable and explosive.
- Battery fluid contains sulfuric acid. Do not allow battery fluid to contact eyes, skin, fabrics or painted surfaces. If contact occurs, flush the affected area immediately with water. Obtain medical help immediately if eyes are affected.
- Never expose the battery to open flame or electric spark.
- Do not smoke near the battery.
- Failure to follow the instructions for jump starting can lead to injury.

#### Related information

- Ignition modes (p. 380)
- Starting the engine (p. 382)
- Turning the engine off (p. 384)
- Start battery (p. 488)
- Opening and closing the hood (p. 514)

## Driving with a trailer

When towing a trailer, always observe the legal requirements of the state/province.

- All Volvo models are equipped with energy-absorbing shock-mounted bumpers. Trailer hitch installation should not interfere with the proper operation of this bumper system.

Trailer towing does not normally present any particular problems, but take into consideration:

- Increase tire pressure to recommended full pressure.
- When your vehicle is new, avoid towing heavy trailers during the first 620 miles (1,000 km).
- Maximum speed when towing a trailer: 50 mph (80 km/h).
- Engine and transmission are subject to increased loads. Therefore, engine coolant temperature should be closely watched when driving in hot climates or hilly terrain. Use a lower gear and turn off the air conditioner if the temperature gauge needle enters the red range.
- If the automatic transmission begins to overheat, a message will be displayed in the text window.
- Avoid overload and other abusive operation.
- Hauling a trailer affects handling, durability, and economy.

- It is necessary to balance trailer brakes with the towing vehicle brakes to provide a safe stop (check and observe state/local regulations).
- Do not connect the trailer's brake system directly to the vehicle's brake system.
- More frequent vehicle maintenance is required.
- Remove the ball holder when the hitch is not being used.

 <b>NOTE</b>
<ul style="list-style-type: none"><li>• When parking the vehicle with a trailer on a hill, apply the parking brake before putting the gear selector in <b>P</b>. Always follow the trailer manufacturer's recommendations for wheel chocking.</li><li>• When starting on a hill, put the gear selector in <b>D</b> before releasing the parking brake.</li><li>• If you use the manual (Geartronic) shift positions while towing a trailer, make sure the gear you select does not put too much strain on the engine (using too high a gear).</li><li>• The drawbar assembly/trailer hitch may be rated for trailers heavier than the vehicle is designed to tow. Please adhere to Volvo's recommended trailer weights.</li><li>• Avoid driving with a trailer on inclines of more than 15%.</li></ul>

**! CAUTION**

The maximum trailer weights listed are only applicable for altitudes up to 3,280 ft (1000 m) above sea level. With increasing altitude the engine power and therefore the car's climbing ability are impaired because of the reduced air density, so the maximum trailer weight has to be reduced accordingly. The weight of the vehicle and trailer must be reduced by 10% for every further 3,280 ft (1,000 m) (or part thereof). When towing 5,000 lbs (2,250 kg) hill inclination is restricted to 14%.



**⚠ WARNING**

- Bumper-attached trailer hitches must not be used on Volvos, nor should safety chains be attached to the bumper.
- Trailer hitches attaching to the vehicle rear axle must not be used.
- Never connect a trailer's hydraulic brake system directly to the vehicle brake system, nor a trailer's lighting system directly to the vehicle lighting system. Consult your nearest authorized Volvo retailer for correct installation.
- When towing a trailer, the trailer's safety chains or wire must be correctly fastened to the attachment points provided in the trailer hitch on the vehicle. The safety chain or wire must never be fastened to or wound around the towing ball.

**Trailer turn signals and brake lights**

If one (or more) of the bulbs on a trailer is defective, a symbol and a message will be displayed in the instrument panel.

The other lights on the trailer must be checked manually by the driver before the vehicle is driven. See the subsection "Manual check" in the following section "Trailer lamp check".

Symbol	Message
	<ul style="list-style-type: none"> <li>• Trailer turn indicator Right turn indicator malfunction</li> <li>• Trailer turn indicator Left turn indicator malfunction</li> </ul>
	<ul style="list-style-type: none"> <li>• Trailer brake light Malfunction</li> </ul>

If one of the trailer's turn signal bulbs is defective, the turn signal symbol in the instrument panel for the respective sides of the vehicle will also flash faster than normal.

## ◀ Trailer lamp check\*

### Automatic check

When the trailer has been connected to the vehicle's electrical system, its lamps can be checked by automatically activating them. This helps the driver to ensure that the trailer's lamps are functioning correctly before starting to drive.

In order to perform this check, the engine must not be running.

1. When a trailer is connected to a trailer hitch or towbar, **Automatic Trailer Lamp Check** will appear in the instrument panel.
2. Confirm this message by pressing the **O** button on the right-side steering wheel keypad.
  - > The lamp check will begin.
3. Leave the vehicle to perform the trailer lamp check.
  - > All of the trailer's lamps will begin to flash and then each lamp will illuminate one at a time.
4. Visually check that all of the trailer's lamps are functioning correctly.
5. After a short time, all of the trailer's lamps will begin to flash again.
  - > The lamp check is completed.

### Disabling the automatic check

The automatic lamp check function can be disabled in the center display.

1. Tap **Settings** in Top view.
2. Tap **My Car** → **Lights and Lighting**.
3. Deselect **Automatic Trailer Lamp Check**.

### Manual check

If the automatic lamp check has been disabled, the function can be started manually.

1. Tap **Settings** in Top view.
2. Tap **My Car** → **Lights and Lighting**.
3. Select **Manual Trailer Lamp Check**.
  - > The lamp check will begin. Leave the vehicle to perform the trailer lamp check as described in the section "Automatic check" above.

### Self-leveling suspension\*

The self-leveling system attempts to keep the vehicle at a constant level, regardless of the load (up to the max. permissible load). When the engine is not running, the rear of the vehicle sinks down slightly, which is normal.

### Related information

- Detachable trailer hitch\* (p. 378)
- Trailer Stability Assist (TSA) (p. 379)
- Weights (p. 537)

## Detachable trailer hitch\*

Volvo recommends the use of Volvo trailer hitches that are specially designed for the vehicle.

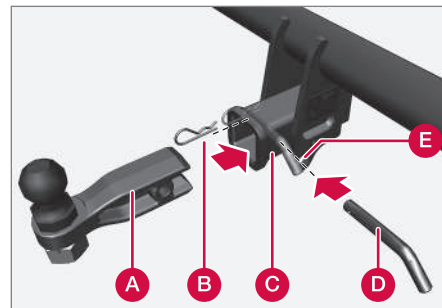

- A** Ball holder
- B** Cotter pin
- C** Hitch assembly
- D** Locking bolt
- E** Safety wire attachment bracket

### Installing the ball holder

1. If necessary, remove the cotter pin from the locking bolt and slide the locking bolt out of the hitch assembly.
2. Slide the ball holder into the hitch assembly.



3. Align the hole in the ball holder with the one in the hitch assembly.
4. Slide the locking bolt through the hitch assembly/ball holder.
5. Insert the cotter pin in the hole at the end of the locking bolt.

### **WARNING**

- Be sure the towbar is securely locked in position before attaching anything to it.
- Always attach the trailer's safety wire securely to the towbar's safety wire attachment bracket.

### Removing the ball holder

1. Remove the cotter pin from the locking bolt and slide the locking bolt out of the ball holder/hitch assembly.
2. Pull the ball holder out of the hitch assembly.

### **NOTE**

A cover for the hitch assembly is also included in the kit.

### Stowing the ball holder

#### **WARNING**

When not in use, the detachable trailer hitch should always be properly stowed under the cargo compartment floor.

### Related information

- Driving with a trailer (p. 376)
- Trailer Stability Assist (TSA) (p. 379)

### Trailer Stability Assist (TSA)

Trailer Stability Assist is a system designed to help stabilize a vehicle that is towing a trailer when the vehicle and trailer have begun to sway and is part of the Electronic Stability Control system.

### Function

A vehicle towing a trailer may begin to sway for various reasons. Normally this only occurs at high speeds but, for example, if the trailer is overloaded or if the load is unevenly distributed in the trailer, there is risk of swaying.

Swaying may be caused by factors such as:

- The vehicle and trailer are hit by a sudden, strong crosswind
- The vehicle and trailer are traveling on an uneven road surface or drive over a bump
- Sudden movements of the steering wheel

### Facts about TSA

- The stability system symbol in the instrument panel will flash when TSA is working
- If the driver switches off the stability system's Spin Control function, TSA will also be switched off (but will be on again the next time the engine is started)
- TSA may not intervene when the vehicle and trailer begin to sway if the driver tries to compensate for the swaying motion by moving the steering wheel rapidly



### ◀ How TSA works

Once swaying has begun, it can be very difficult to stop, which makes it difficult to control the vehicle and trailer.

The TSA system continuously monitors the vehicle's movements, particularly lateral movement. If the system detects a tendency to sway, the brakes are applied individually on the front wheels, which has a stabilizing effect on the vehicle and trailer. This is often enough to enable the driver to regain control of the vehicle.

If this is not adequate to stop the swaying motion, the brakes are applied to all of the wheels on the vehicle and on the trailer if it is equipped with brakes, and engine power is temporarily reduced. As the swaying motion begins to decrease and the vehicle-trailer have once again become stable, TSA will now stop regulating the brakes/engine power and the driver regains control of the vehicle.

TSA is deactivated if the driver deactivates **ESC** in the center display's menu system.



When the **ESC** symbol in the instrument panel flashes, TSA is active.

### Related information

- Detachable trailer hitch\* (p. 378)
- Driving with a trailer (p. 376)
- Electronic Stability Control (ESC) (p. 251)

### Ignition modes

The vehicle's ignition can be put in various modes (levels) to make different functions available.

The vehicle's ignition has 3 modes: **0**, **I**, and **II** that can be used to operate various functions without starting the engine. The following table shows examples of which functions are available in the respective modes.

Mode	Functions available
0	<ul style="list-style-type: none"> <li>The odometer, clock and temperature gauge are illuminated</li> <li>Power seats* can be adjusted</li> <li>The power windows can be operated</li> <li>The 12-volt socket in the cargo compartment can be used</li> <li>The center display is activated and can be used</li> <li>The infotainment system can be used for a limited time</li> </ul> <p>In this mode, certain functions can only be used for a limited time to help minimize battery drain</p>
I	<ul style="list-style-type: none"> <li>The laminated panoramic roof*, power seats*/windows, 12-volt sockets in the passenger compartment, Bluetooth, navigation system*, climate system blower, windshield wipers can be operated</li> <li>The infotainment system will start (if it was started when the ignition was switched off)</li> </ul>

Mode	Functions available
II	<ul style="list-style-type: none"> <li>The headlights illuminate</li> <li>Warning/indicator lights illuminate for 5 seconds</li> <li>A number of other functions will also be activated. However, the heated seats* and heated rear window functions can only be activated when the engine is running.</li> </ul> <p><b>This mode should only be used for very short periods to help avoid draining the battery.</b></p>

### Selecting an ignition mode



Start knob in the tunnel console (generic illustration)

- Ignition mode 0:** unlock the vehicle and keep the remote key in the passenger's compartment.

### **i** NOTE

To access ignition modes **I** or **II** without starting the engine, the brake pedal must **not** be depressed when these modes are selected.

- Ignition mode I:** Turn the start knob to **START** and release it. The knob will return automatically to its original position.
- Ignition mode II:** Turn the start knob to **START** and hold it there for approx. 4 seconds. Release the knob.
- Returning to ignition mode 0:** To return to mode **0** from mode **II** or **I**, turn the start knob to **STOP** and release it.

### Related information

- Starting the engine (p. 382)
- Turning the engine off (p. 384)

## Battery drain

Your vehicle's electrical functions drain the battery to varying extents.

Avoid using ignition mode **II** as much as possible, or electrical functions that require a great deal of electrical current when the engine is not running.

Using ignition mode **I** whenever possible consumes less electrical current.

Functions that require a great deal of electrical current include:

- the climate system blower
- headlights
- wipers
- infotainment system (especially at high volume).

If the battery's charge level is low, a text message will appear in the instrument panel. The vehicle's energy-saving function will then turn off or reduce certain functions that are currently consuming electrical current.

If the battery needs to be recharged, start the engine and let it idle for at least 15 minutes or drive the vehicle (driving charges the battery faster than letting the engine idle).

## Related information

- Ignition modes (p. 380)

## Starting the engine

The engine can be started using the start knob on the tunnel console if there is a remote key in the passenger compartment.



Start knob in the tunnel console between the front seats (generic illustration)

## WARNING

Before starting the engine:

- Fasten the seat belt.
- Check that the seat, steering wheel and mirrors are adjusted properly.
- Make sure the brake pedal can be depressed completely. Adjust the seat if necessary.

To start the engine.

1. A remote key must be in the passenger compartment. On models with the standard Passive Start, the key has to be in the front section of the passenger compartment. If the vehicle is equipped the optional Passive Entry system (keyless locking/unlocking) the key can be anywhere in the vehicle.
2. Press firmly on the brake pedal<sup>2</sup>.
3. Turn the start knob toward **START** and release it to start the engine.
  - > The starter motor will crank until the engine starts or its overheating protection is triggered.

<sup>2</sup> If the vehicle is moving, it is only necessary to turn the start knob toward **START** to start the engine.

**⚠ WARNING**

- Never use more than one floor mat at a time on the driver's floor. Before driving, remove the original mat from the driver's seat floor before using any other type of floor mat. Any mat used in this position should be securely and properly anchored in the attaching pins. An extra mat on the driver's floor can cause the accelerator and/or brake pedal to catch. Check that the movement of these pedals is not impeded.
- Volvo's floor mats are specially manufactured for your car. They must be firmly secured in the clips on the floor so that they cannot slide and become trapped under the pedals on the driver's side.



Back-up reader in the tunnel console

If **Vehicle key not found** is displayed in the instrument panel, place the remote key in the

back-up reader in the tunnel console (see the illustration) and try again to start the engine.

**i NOTE**

When the remote key is in the back-up reader, be sure there are no other metallic objects (e.g., other keys, coins, cell phones) in the cup holder. This could affect the back-up reader's function.

**⚠ CAUTION**

If the engine does not start after the third try, wait for approximately 3 minutes before trying to start it again to give the battery time to recover its starting capacity.

**⚠ WARNING**

- Always remove the remote key from the passenger compartment when leaving the vehicle and ensure that the ignition is in mode **0**.
- On vehicles with the optional Passive Entry, never remove the remote key from the vehicle while it is being driven or towed.
- Always place the gear selector in Park and apply the parking brake before leaving the vehicle. Never leave the vehicle unattended with the engine running.
- Always open garage doors fully before starting the engine inside a garage to ensure adequate ventilation. The exhaust gases contain carbon monoxide, which is invisible and odorless but very poisonous.

**i NOTE**

After a cold start, idle speed may be noticeably higher than normal for a short period. This is done to help bring components in the emission control system to their normal operating temperature as quickly as possible, which enables them to control emissions and help reduce the vehicle's impact on the environment.



**CAUTION**

- When starting in cold weather, the automatic transmission may shift up at slightly higher engine speeds than normal until the automatic transmission fluid reaches normal operating temperature.
- Do not race a cold engine immediately after starting. Oil flow may not reach some lubrication points fast enough to prevent engine damage.
- The engine should be idling when you move the gear selector. Never accelerate until after you feel the transmission engage. Accelerating immediately after selecting a gear will cause harsh engagement and premature transmission wear.
- Selecting **P** or **N** when idling at a standstill for prolonged periods of time will help prevent overheating of the automatic transmission fluid.

**Related information**

- Ignition modes (p. 380)
- Turning the engine off (p. 384)
- Changing the remote key's battery (p. 225)
- Jump starting (p. 374)

**Turning the engine off**

The engine can be turned off using the start knob on the tunnel console.



Start knob in the tunnel console between the front seats

To turn off the engine:

- Turn the start knob toward **STOP** and release it to switch the engine off.

If the gear selector is in **P** or if the vehicle is moving:

- Hold the knob in the **STOP** position until the engine stops.

**Related information**

- Starting the engine (p. 382)
- Ignition modes (p. 380)

**Drive modes\***

Selecting a drive mode affects the vehicle's driving characteristics to help make driving more enjoyable or easier in certain types of situations.

The following systems are adapted to help provide the best vehicle performance in the respective drive modes:

- Steering
- Engine/transmission/All Wheel Drive\*
- Brakes
- Pneumatic suspension\* Suspension control
- Instrument panel
- Start/Stop
- Climate system settings

Select the drive mode best suited to the current driving conditions.

Please be aware that not all modes can be selected in all driving situations. The selected mode will be displayed in the instrument panel.

## Selecting a drive mode



1. Press the **DRIVE MODE** control in the tunnel console.
  - > A pop-up menu will open in the center display.
2. Roll the control upward or downward to scroll to the desired drive mode.
3. Press the control again to select it. A drive mode can also be selected by tapping its button on the center display.
  - > The selected drive mode will be displayed in the instrument panel.

When a drive mode cannot be selected, one of the following messages may be displayed:

- **Not possible to select due to gear in manual**
- **Not possible to select due to low battery**

- **Not possible to select due to low temperature**
- **Not possible to select due to limitations**
- **Not possible to select due to high speed.**

### Available drive modes

#### COMFORT

This is the default mode.

When the engine is started, COMFORT drive mode will be selected and the Start/Stop function will be activated. This setting offers driving comfort, light steering and relatively soft suspension.

#### ECO

ECO drive mode is designed to help promote fuel-efficient driving.

In this mode, Start/Stop is activated, ground clearance is lowered to help reduce wind resistance and certain climate system functions will be reduced.

There is an ECO gauge in the instrument panel to indicate the current level of fuel-efficiency. See also the article "ECO drive mode."

#### OFF ROAD

This mode helps maximize the vehicle's capacity to traverse difficult terrain or poor roads.

In OFF ROAD, ground clearance is maximized, the steering is light, and All Wheel Drive and Hill

Descent Control are activated. **Start/Stop** is deactivated.

This drive mode can only be activated at low speeds (the permissible speed range will be shown on the speedometer). At higher speeds, OFF ROAD mode will be cancelled and another drive mode will be activated.

In OFF ROAD mode, a compass will be displayed in the instrument panel.

This drive mode is not intended for normal street driving.

#### **!** CAUTION

OFF ROAD drive mode may not be used if the vehicle is towing a trailer without an electrical connection. This could result in damage to the pneumatic suspension system's bellows.

Due to the increased ground clearance, if the OFF ROAD mode was selected when the engine was switched off, the suspension will lower when the engine is restarted.

## ◀ DYNAMIC

**Dynamic** drive mode is designed to provide sportier driving characteristics. Gear shifting will be faster and more distinct and will occur at higher rpm.

Steering response will be more immediate, the suspension will be stiffer and low ground clearance will help reduce body roll when cornering. **Start/Stop** will be deactivated.

## INDIVIDUAL

This setting allows you to adapt a drive mode to your personal preferences.

Select one of the other drive modes as a basis and change the settings to provide the driving characteristics that you prefer. These settings will be stored in a driver profile.

INDIVIDUAL is only available if it has been activated in the center display.

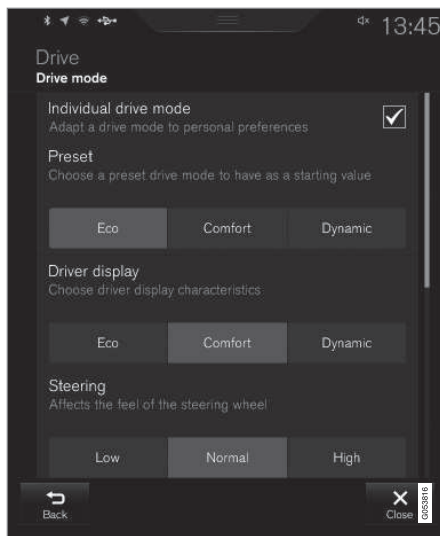

Settings view<sup>3</sup> for INDIVIDUAL drive mode

1. Tap **Settings** in the center display's Top view.
2. Tap **My Car** → **Individual Drive Mode** and tap **Individual Drive Mode**.

3. Under **Presets**, select: **Eco**, **Comfort** or **Dynamic**.

The following settings can be modified:

- **Driver Display**
- **Steering force**
- **Powertrain Characteristics**
- **Brake Characteristics**
- **Suspension Control**
- **ECO Climate**
- **Start/Stop**.

## Related information

- Adjustable steering force\* (p. 250)
- Loading (p. 208)
- Driver profiles (p. 175)
- Start/Stop (p. 389)
- ECO drive mode (p. 387)
- All Wheel Drive (AWD) (p. 397)
- Hill Descent Control (HDC) (p. 358)

<sup>3</sup> Generic illustration.



## ECO drive mode

The Eco drive mode is a function designed to give the driver the opportunity to drive more economically and to help reduce fuel consumption.

When this mode is activated, the following characteristics are modified:

- The automatic transmission's shifting points
- The engine management system and accelerator pedal response
- Eco Coast functionality is activated: engine braking is disabled at speeds between approx. 40 and 87 mph(65 and 140 km/h)
- Climate system settings: certain functions will be temporarily reduced or deactivated
- The suspension's self-leveling function\* lowers ground clearance to help reduce wind resistance
- Information is shown in an ECO gauge in the instrument panel to help promote more economical driving

### **i** NOTE

When Eco is activated, several climate system parameters are changed and the function of certain current-consuming systems will be reduced.

Some of these functions can be restarted manually but full functionality will not be restored until Eco is deactivated.

## Selecting ECO mode

When the engine is switched off, ECO mode is deactivated and must be reactivated each time the engine is started. **ECO** will appear in the instrument panel when the function is activated.

### Via Function view



Tap the button in the center display's Function view. An indicator light in the button shows that the function is activated.

### With the drive mode control\*



1. Press the **DRIVE MODE** control.  
> A pop-up menu will open in the center display.
2. Roll the control upward or downward to scroll to the desired drive mode and

3. Press the control again to select it. A drive mode can also be selected by tapping its button on the center display.

## Eco Coast

Eco Coast essentially deactivates engine braking, allowing the vehicle to roll freely.

When the driver releases the accelerator pedal, the transmission is automatically disengaged from the engine to allow the vehicle to roll as far as possible, which helps reduce fuel consumption.

This feature is primarily intended to be used in driving situations where the vehicle can roll freely, such as down gentle hills or when a decrease in speed is expected, such as when approaching an intersection or a traffic light.

Eco Coast enables proactive driving with as little braking as possible.

Depending on the driving situation, Eco and Eco Coast can be used in different ways to help reduce fuel consumption:

- **With Eco activated:** this enables Eco Coast, which allows the vehicle **to roll freely for as far as possible** when the driver releases the accelerator pedal (e.g., when approaching a traffic light or intersection).
- or
- **With Eco deactivated:** engine braking can be used **when the vehicle will only roll for**



- ◀◀ **a short distance** (in heavy traffic, etc.) or **when driving down hills.**

To help keep fuel consumption as low as possible, Eco Coast should not be used in traffic situations where the brakes have to be used frequently.

**Activating Eco Coast**

Eco Coast is activated when the accelerator pedal is released completely if:

- Eco is activated
- The gear selector is in **D**
- The vehicle's speed is between approximately 40 and 87 mph(65 and 140 km/h)  
Always observe posted speed limits
- The gradient of a down-slope is less than approximately 6%

**COASTING** will appear in the instrument panel when Eco Coast is being used.

**Limitations**

Eco Coast is **not** available if:

- The engine and/or transmission have not reached their normal operating temperature
- Cruise control is activated
- The gear selector is moved from **D** to "+/-" for manual shifting
- The vehicle's speed is not within the 40 and 87 mph(65 and 140 km/h) range

- The gradient of a down-slope is more than approximately 6%
- The steering wheel paddles\* are used for manual shifting

**Deactivating and turning off Eco Coast**

In certain situations, it may be advisable to switch off the Eco Coast function, such as:

- When driving down steep hills, in order to utilize engine braking
- Prior to passing another vehicle, in order to do so as safely as possible

Deactivating Eco Coast (and reactivating engine braking) can be done in the following ways:

- Move the gear selector to the manual "+/-" position
- Change gears using the steering wheel paddles\*
- Press the brake or accelerator pedal

Turn the function off by changing drive modes\* or by turning ECO off in the center display's Function view.

The vehicle will roll for short distances even if Eco Coast is turned off to help conserve fuel. However, for the best fuel economy, the function should be used as much as possible.

**ECO gauge in the instrument panel**



Eco gauge 12" instrument panel



Eco gauge 8" instrument panel

The ECO gauge in the instrument panel helps improve driving economy.

- A low reading in the green area indicates economical driving.
- A higher reading indicates higher fuel consumption.

The ECO gauge also has an indicator showing how a "reference" driver would drive in the same situation. This is indicated by a diamond in the gauge.

### Eco climate

In the **Eco** drive mode, eco climate is automatically activated in the passenger compartment to help minimize energy consumption.

To restart the climate system functions that may have been reduced, press the **AUTO** or defroster buttons.

In order to return to full functionality for all of the systems that may have been reduced to help improve economical driving, select another drive mode or adapt the climate system functions using the **Individual** mode to full functionality.

### Related information

- Driving economically (p. 364)
- Drive modes\* (p. 384)
- Start/Stop (p. 389)

### Start/Stop

Start/Stop is a function that temporarily switches off the engine when the vehicle is not moving, for instance in heavy traffic or at a traffic light, to help reduce fuel consumption. The engine starts again automatically when the brake pedal is released.

Start/Stop is one of several fuel-conserving features that also help reduce emissions.

This feature helps make it possible to drive more economically by allowing the engine to auto-stop in certain situations.

### Related information

- Conditions for Start/Stop (p. 391)
- Using the Start/Stop function (p. 389)
- ECO drive mode (p. 387)

### Using the Start/Stop function

Start/Stop is a function that temporarily switches off the engine when the vehicle is not moving, for instance in heavy traffic or at a traffic light, to help reduce fuel consumption. The engine starts again automatically when the brake pedal is released.

Start/Stop is available when the engine has been started. The instrument panel will indicate if the function is available/unavailable/active.

All of the vehicle's normal systems such as lighting, infotainment, etc., function normally when the engine has auto-stopped. However, certain functions, such as climate system blower speed or very high infotainment system volume, will be temporarily reduced.

### Auto-stop

The following conditions must be met for the engine to auto-stop:

- Stop the vehicle by applying the brakes and keep the brake pedal depressed. The engine will auto-stop. If the COMFORT<sup>4</sup> or ECO driving modes are activated, the engine can auto-stop before the vehicle has come to a standstill.

If the **Adaptive cruise** or **Pilot Assist** functions are activated, the engine will auto-stop after

<sup>4</sup> The default driving mode.



◀ approx. 3 seconds. See also the article "Conditions for Start/Stop."

### Auto-start

The following conditions must be met for the engine to auto-start:

- Release the brake pedal; the engine will automatically restart. When starting on an uphill incline, the Hill Start Assist (HSA) function will be activated to help prevent the vehicle from rolling backward.
- When the brake system's Auto Hold function is activated, the engine will not auto-start until the accelerator pedal is pressed.
- When **Adaptive cruise** or **Pilot Assist** are activated, the engine will auto-start when the accelerator pedal is pressed or if the  button is pressed on the left-side steering wheel keypad.
- Keep the brake pedal depressed but press the accelerator pedal. The engine will auto-start.
- On a downhill incline, release the brake pedal so that the vehicle begins to roll. The engine will auto-start after a slight increase in speed.

### Symbols in the instrument panel

#### 12" Instrument panel



- **READY** will be displayed in the tachometer when Start/Stop is available.
- An indicator in the tachometer will point toward **READY** when Start/Stop is active and the engine has auto-stopped.
- **READY** will be grayed-out when Start/Stop is not available.
- No text will be displayed when Start/Stop is turned off.



Instrument panel when Start/Stop is active and the engine has auto-stopped

#### 8" instrument panel

The symbol is displayed at the bottom of the speedometer.

Symbol	Explanation
	White symbol: the function is available.
	Beige symbol: the function is active and the engine has auto-stopped.
	The function is not available because the conditions have not been met.
-	No symbol displayed - the function is turned off.

### Turning Start/Stop off

In certain situations (e.g., heavy stop-and-go traffic), it may be advisable to temporarily turn this function off. To do so:



Tap the **Start/Stop** button in the center display's Function view. The green indicator light in the button will go out. Start/Stop will remain off until the button is tapped again, the driving mode is changed

COMFORT or ECO, or until the engine is restarted.

### Related information

- Conditions for Start/Stop (p. 391)
- Start/Stop (p. 389)

### Conditions for Start/Stop

Certain conditions must be met for the **Start/Stop** feature to function. If a condition is not met, this will be indicated in the instrument panel.

#### The engine does not auto-stop

In certain situations or conditions, the engine **may not auto-stop** when the vehicle comes to a standstill, such as when:

- the vehicle has not reached a speed of approx. 8 mph (12 km/h) after starting.
- after several auto-stops, the speed must again exceed approx. 8 mph (12 km/h) before the next auto-stop.
- the driver's seat belt is unbuckled.
- the main battery's charge is below the minimum level.
- the engine has not reached its normal operating temperature.
- the ambient temperature is below approx. 23°F (-5°C) or above approx. 85°F (30°C).
- the windshield's heating function\* is activated.
- the climate system cannot keep the desired settings in the passenger compartment.
- the vehicle is backing up.
- the main battery's temperature is above or below the permitted limits.
- the driver is turning the steering wheel hard.

- the road's incline is very steep.
- the hood is opened.
- the transmission has not reached its normal operating temperature.
- driving at high altitude and the engine has not reached its normal operating temperature.
- the gear selector is in the manual shifting position.
- the ABS brakes have activated.
- hard braking (even if the ABS brakes have not activated).
- many starts during a short time period have triggered the starter motor's overheating protection.
- a trailer's electrical system is connected to the vehicle's electrical system.

#### The engine does not auto-start

In certain situations or conditions, the engine **may not auto-start** after an auto-stop, such as:

- if the driver is not wearing a seat belt
- the gear selector is in the **P** position and the driver's door is open. The engine must be started normally.

#### The engine auto-starts while the brake pedal is depressed

In the following situations, the engine **will auto-start** even though the brake pedal is depressed:



- ◀ ● condensation forms on the inside of the windows.
- the climate system cannot keep the desired settings in the passenger compartment.
- electrical current consumption is temporarily high or the main battery's charge is below the minimum level.
- the brake pedal is pumped repeatedly.
- the hood is opened.
- the vehicle begins to move or increases speed slightly (if the engine auto-stopped before the vehicle was at a standstill).
- the driver's seat belt is unbuckled while the gear selector is in the **D** or **N** positions.
- the gear selector is moved from **D** to **R** or **±**.
- the driver's door is opened with the gear selector in **D**: an audible signal and a text message will inform the driver that the ignition is on.

**⚠ WARNING**

Do not open the hood if the engine has auto-stopped. The engine could suddenly auto-start.

Before opening the hood:

- Switch off the ignition by turning the start knob in the tunnel console toward **STOP**.
- Be aware that if the engine has been running, components in the engine compartment will be very hot.

**Related information**

- Using the Start/Stop function (p. 389)

**Automatic transmission**



The automatic transmission has 8 forward gears and shifts up or down based on the level of acceleration, speed and engine speed (measured in revolutions per minute - rpm). Manual shifting is also possible. The gear indicator in the instrument panel shows the gear currently being used or gear shift mode.

**⚠ CAUTION**

The transmission's temperature is monitored to help prevent damage to the transmission or other drivetrain components. If there is a risk of overheating, the warning symbol on the instrument panel will illuminate and a text message will be displayed. Follow the instructions provided there.

**Symbols in the instrument panel**

If a problem should occur with the transmission, a symbol and a message will be displayed in the instrument panel.

Symbol	Explanation
	Transmission-related information. Follow the instructions provided.
	Hot or overheated transmission. Follow the instructions provided.

## Related information

- Gear selector positions (p. 394)
- Gear shift indicator (p. 394)
- Shiftlock (p. 393)
- Steering wheel paddles\* (p. 396)
- All Wheel Drive (AWD) (p. 397)

## Shiftlock

The automatic transmission's shiftlock feature helps prevent inadvertently moving the gear selector between different positions.

There are two different types of shiftlock: mechanical and automatic.

### Mechanical shiftlock

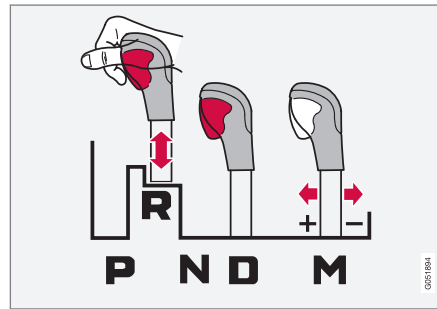

The gear selector can be moved back and forth freely between **N** and **D**. There is a mechanical shiftlock for the other positions.

To move the gear selector to between **P**, **R**, **N** and **D**, press the button on the front of the gear selector (see the illustration).

## Automatic shiftlock

### From Park – P

In order to move the gear selector from the **P** position, the brake pedal must be depressed and the ignition must be in mode **II**.

### From neutral – N

If the gear selector is in **N** and the vehicle has been stationary for more than 3 seconds (regardless of whether or not the engine is running), the shiftlock feature will lock the gear selector in this position.

In order to move the gear selector from the **N** position, the brake pedal must be depressed and the ignition must be in mode **II**.

### Shiftlock override

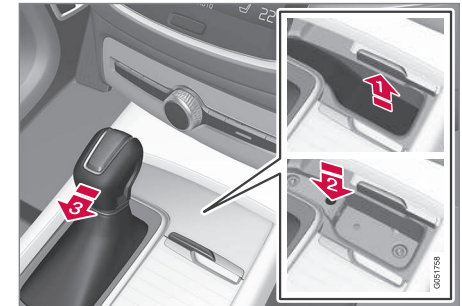

If the vehicle cannot be driven (e.g., due to a discharged battery), the shiftlock feature has to be overridden in order to move the gear selector



◀ from the **P** or **D** positions into **N** so that the vehicle can be moved. To do so:

- 1 Lift away the rubber mat on the bottom of the storage compartment in front of the gear selector to expose the small hole for overriding the shiftlock feature.
  - 2 Press a small screwdriver or similar item into the hole and hold it down.
  - 3 Press the button on the front side of the gear selector and move the selector to the **N** position. Release the button and remove the screwdriver from the hole.
4. Put the rubber mat back into place.

### Related information

- Gear selector positions (p. 394)
- Automatic transmission (p. 392)

### Gear shift indicator

The gear shift indicator in the instrument panel shows the current gear (in manual shifting mode) and will prompt the driver to shift up or down to help get the best possible fuel economy.

The gear shift indicator shows the current gear in the instrument panel and uses an upward arrow to recommend shifting to a higher gear.



Gear shift indicator (generic illustration)

### Related information

- Gear selector positions (p. 394)
- Steering wheel paddles\* (p. 396)

### Gear selector positions

The automatic transmission has 8 forward gears and also offers manual shifting.

### Gear selector positions



The following gear selector positions are shown in the instrument panel:

**P, R, N, D** or **M**.

For manual shifting, the gear indicator in the instrument panel shows the gear currently being used.



**Park – P**

Select **P** when the vehicle is parked or when the starting the engine. The vehicle must be stationary when **P** is selected.

The ignition must be in mode **II** and the brake pedal must be depressed before the gear selector can be moved from **P**.

In position **P**, the transmission is mechanically locked. Always apply the parking brake when the vehicle is parked.

**i NOTE**

The gear selector must be in the **P** position before the vehicle can be locked and the alarm set.

**⚠ WARNING**

Always apply the parking brake when the vehicle is parked, particularly when parking on a hill. The transmission's **P** mode may not be able to keep the vehicle stationary if it is parked on an incline.

**Reverse – R**

The vehicle must be stationary before **R** can be selected.

**Neutral – N**

No gear is selected and the engine can be started. Always apply the parking brake if the vehicle is not moving and the gear selector is in the **N** position.

The ignition must be in mode **II** and the brake pedal must be depressed before the gear selector can be moved from **N**.

**Drive – D**

**D** is the normal driving position and gear shifting is fully automatic. The vehicle must be stationary when the gear selector is moved from **R** to **D**.

**Manual shifting – M (shown on the instrument panel)**

Manual shifting can be selected at any time and engine braking will occur when the accelerator pedal is released.

To select, move the gear selector from **D** to the side toward **"±"**. The current gear (1 - 8) will be shown in the instrument panel.

- Press the gear selector forward toward **"+"** (plus) and release it to shift up one gear.
- Pull the gear selector rearward toward **"-"** (minus) and release it to shift down one gear.



Manual shift indicator in the instrument panel<sup>5</sup>.

For smooth shifting and engine performance, the transmission will shift down automatically if the vehicle's speed becomes too low for the selected gear.

Move the gear selector to the side toward **D** at any time to resume automatic gear shifting.

**Safety function**

To help avoid excessive rpm that might cause engine damage, the transmission control module has a down-shift protection feature that in some situations may prevent a down-shift or kickdown.

During kickdown, the transmission may shift down one or more gears, depending on the engine's rpm and will shift up again when max. rpm is reached for a specific gear.

<sup>5</sup> Generic illustration.

◀◀ **Related information**

- Steering wheel paddles\* (p. 396)
- Shiftlock (p. 393)
- Gear shift indicator (p. 394)

**Steering wheel paddles\***

In addition to the manual gearshift function using the gear selector, the paddles make it possible to manually shift gears from the steering wheel.

**Activating the paddles**

In order to shift gears with the paddles, they have to first be activated. To do so:

- Pull either paddle toward the steering wheel and release it.
  - > A number in the instrument panel will indicate the current gear being used.

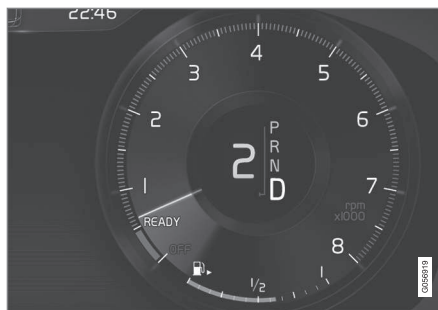

Instrument panel when the paddles are activated

**Manually shifting gears**

In shift mode **M**, the paddles are automatically activated.



Instrument panel when using the paddles in manual mode

**Shifting**

To shift one gear:

- Pull either paddle toward the steering wheel and release it.



1 "-": Shift down one gear.

2 "+": Shift up one gear.

A gear shift will take place each time a paddle is pulled if the engine speed (rpm) is within the permissible range for the selected gear.

The gear number shown in the instrument panel will change after each gear shift.

## Deactivating the paddles

### Manual deactivation in modes D and M

- Pull the right (+) paddle toward the steering wheel and hold it until the number of the current gear is no longer displayed in the instrument panel.
  - > The transmission will revert to automatic gear shifting in the **D** mode.

### Automatic deactivation

In shift mode **D**, if the paddles are not used for a period of time, they will deactivate automatically. The number of the current gear will no longer be displayed.

The paddles will remain active if engine braking is currently being used.

### Related information

- Gear selector positions (p. 394)
- Gear shift indicator (p. 394)

## All Wheel Drive (AWD)<sup>6</sup>

Your Volvo can be equipped with All Wheel Drive, which means that power is distributed automatically between the front and rear wheels.

Under normal driving conditions, most of the engine's power is directed to the front wheels. However, if there is any tendency for the front wheels to spin, an electronically controlled coupling distributes power to the wheels that have the best traction.

AWD reacts differently, depending on the drive mode\* selected.

### Related information

- Drive modes\* (p. 384)
- Low Speed Control (LSC)\* (p. 359)

<sup>6</sup> Standard equipment on certain models.

## Leveling control\* and suspension

The leveling control system adjusts the suspension and shock absorbers automatically to help provide good comfort and control while driving. Leveling can also be controlled manually to make loading or getting in and out of the vehicle easier.

## Pneumatic suspension and shock absorbers

This system is linked to the selected drive mode and is adapted to the vehicle's speed. The pneumatic suspension reduces the vehicle's ground clearance at higher speeds to reduce wind resistance and increase stability. The shock absorbers are normally set to provide the best possible comfort and are adjusted continuously according to the road surface, acceleration, braking and cornering.



The instrument panel will indicate when the suspension level is being adjusted.

The level cannot be adjusted if one of the side doors or the hood is open.

<sup>7</sup> Depending on the equipment installed in the vehicle'

## Suspension settings

### Easy entry

The vehicle can be lowered to entering and exiting easier.

In the center display's Top view:

1. Tap **Settings**.
2. Tap **My Car → Suspension**.
3. Select **Easy Entry and Exit Suspension Control**.
  - > When the vehicle is parked and the engine is turned off, the level is lowered. Level adjustment will stop if a side door is opened and will resume after a slight delay when the door has been closed. When the engine is started and the vehicle begins to move, the level will be raised to the height set by the selected drive mode.

If a door has been opened and closed, there may be a slight delay before the leveling function will resume.

### Deactivating suspension and leveling control

In certain situations, this function has to be turned off, for example when lifting the vehicle on a jack to help avoid problems created by the difference in levels in the pneumatic suspension when the vehicle is raised.

1. Tap **Settings** in the center display's Top view.
2. Tap **My Car → Suspension**.
3. Select **Disable Leveling Control**.

### Changing the suspension control level<sup>7</sup>

Models equipped with the Four-C active chassis system but without the drive mode control\*, suspension control is adjusted from the center display.

1. Tap **Settings** in Top view.
2. Tap **My Car → Drive Mode → Suspension Control** and select the desired level.

### Loading mode



Use the buttons in the cargo compartment to raise or lower the vehicle to make loading or unloading easier or when attaching a trailer.

**Parking the vehicle**

When parking, be sure that there is adequate space above and below the vehicle since its ground clearance may vary, e.g., depending on the ambient temperature, how the vehicle is loaded, if loading mode is being used or the drive mode selected after the engine is started.

The level may also be adjusted for a certain time after the vehicle has been parked to compensate for possible height adjustments due to temperature changes in the pneumatic suspension when the vehicle has cooled.

**Transport**

When transporting the vehicle on a ferry, train or a tow truck, it may only be secured (lashed) around the tires, not using any other chassis components. Changes in the pneumatic suspension may occur during transport that could negatively affect the lashing and result in damage.

**Related information**

- Drive modes\* (p. 384)
- Driving with a trailer (p. 376)
- Loading (p. 208)



INFOTAINMENT

## The infotainment system

The infotainment system consists of a radio, media player and has the capacity to communicate with a Bluetooth-connected cell phone. It is also possible to connect to the Internet to e.g., stream audio content via apps.

The system's functions can be controlled from the right-side steering wheel keypad, the center display or by using voice commands.

## Infotainment overview

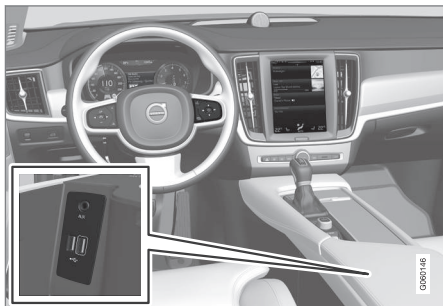

Infotainment system overview

## System updates

The infotainment system is constantly being developed and improved. For optimal functionality, updates can be downloaded when the vehicle is connected to the Internet. See the article "System updates" and the support site [support.volvocars.com](http://support.volvocars.com).

## Related information

- Media player (p. 427)
- Radio (p. 404)
- Phone (p. 419)
- Internet connected vehicle (p. 439)
- Apps (applications) (p. 402)
- Ignition modes (p. 380)
- Symbols in the center display status bar (p. 43)
- Voice control (p. 119)
- Infotainment system license information (p. 445)
- System updates (p. 482)

## Apps (applications)

Apps (applications) are programs used to control some of the vehicle's features and functions.



The center display's App view (generic illustration)

Several basic apps are always available and others can be downloaded. Downloadable apps include navigation services, web radio, streaming music services, retailer contact and software downloads.



Some apps are only available if the vehicle is connected to the Internet.

- In the center display's App view, tap an app to start it.

### Related information

- Internet connected vehicle (p. 439)
- Downloading, updating and uninstalling apps (p. 441)
- Changing settings in different types of apps (p. 43)

## Sound settings

The infotainment system is precalibrated for optimal sound reproduction but these settings can be changed to suit your personal preferences.

The system's volume is normally adjusted using the right-side steering wheel keypad or the volume control below the center display.

### Optimal sound reproduction settings

The audio system is precalibrated for optimal sound reproduction using digital signal processing. This calibration takes into account the speakers, amplifier, cabin acoustics, listener position, etc., for each combination of vehicle and infotainment system.

Dynamic calibration is also available, which monitors the setting of the volume control, radio reception and the vehicle's speed.

Specific sound settings are described in the respective articles/sections of this owner's information.

To change a setting, pull down the center display's Top view and tap **Settings** → **Sound**.

### Active noise suppression<sup>1</sup>

The vehicle can be equipped with an active noise suppression function that reduces engine noise in the passenger compartment by utilizing the infotainment system. The microphone(s) in the

ceiling liner react to engine noise and the infotainment system produces signals (white noise) to counteract this.

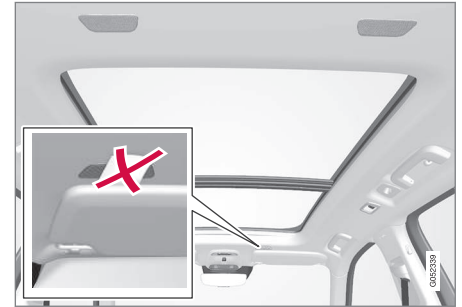

Microphone in the ceiling liner. The number and position vary, depending on the vehicle

### **i** NOTE

Avoid covering or obstructing the noise suppression speakers because doing so could result in a rumbling noise.

### Related information

- Media sound settings (p. 436)
- Voice control settings (p. 124)
- Phone settings (p. 425)

<sup>1</sup> Certain models only.

## Radio

Your vehicle's radio offers AM and FM with HD Radio™ Technology and SiriusXM® Satellite radio\*.



The radio can be controlled using the right-side steering wheel keypad, the center display or by using voice commands.

### Related information

- Changing and searching for radio stations (p. 405)
- Radio settings (p. 404)
- SiriusXM® Satellite radio\* (p. 410)
- HD Radio™ reception (p. 406)
- Changing and searching for radio stations (p. 405)

## Radio settings

The following information lists the settings that can be made for the various wavebands.

Pull down the center display's Top view and select **Settings** → **Media** for the desired waveband. Tap to activate/deactivate.

### AM/FM

- **Show Broadcast Information:** displays information about program content, artists, etc.
- **Freeze Program Name:** select to stop excessive scrolling to freeze after 20 seconds.
- **AM HD Radio:** Enables HD Radio™ Technology for AM audio quality comparable to analogue FM.
- **FM HD Radio:** - Enables HD Radio™ Technology for audio comparable to CD quality. See the article "HD Radio" for detailed information.

### SiriusXM® Satellite radio

With SiriusXM® Satellite radio activated, pull down the center display's Top view and tap **SiriusXM Settings** to display a list of available alternatives. See the article "SiriusXM Satellite radio settings" for detailed information.

### Related information

- SiriusXM® Satellite radio\* settings (p. 412)
- SiriusXM® Satellite radio\* (p. 410)
- Radio (p. 404)
- HD Radio™ reception (p. 406)

## RBDS radio

### RBDS radio

RBDS (Radio Data Broadcast System) enables certain functionality<sup>2</sup>, such as:

- Searches for program types or new broadcasts
- Text information about currently broadcast programs

For example, if news is broadcast, the currently playing sound source will be interrupted so that the news can be heard. The infotainment system will return to the previous sound source when the news broadcast has been completed.

To cancel the announcement, press the  button on the right-side steering wheel keypad or tap **Cancel** on the center display. This function can be activated/deactivated in the center display's **Settings** menu.

### Related information

- Radio (p. 404)
- Radio settings (p. 404)

## Changing and searching for radio stations

The radio automatically compiles a list of the strongest stations that it is currently receiving.

### Turning the radio on

1. Open an app (e.g., FM) from the center display's App view.
2. Select a station.

### Changing a list in a waveband

1. Tap **Library**.
2. Select from **Stations**, **Favorites** or **Genres**.
3. Tap the desired station in the list.

**Favorites:** only plays stations from the list of favorites (see "Favorites" below).

**Genres:** only plays stations broadcasting the selected genre or program type, e.g., pop, classical, etc.

### Changing stations in a selected list

- Tap **<>** under the center display or on the right-side steering wheel keypad.
  - > Move step-by-step through the selected list.

The center display can also be used to change stations.

## Favorites

If a favorite station from a list is currently available, the radio will automatically tune to that station.

See "Changing a list in a waveband" above for information about selecting favorites on a waveband. See "Radio favorites" below for information about selecting a station among all of your favorites.

- Tap  to add or remove a station for the waveband's list of favorites or Radio favorites.

### Radio favorites



Radio favorites shows all of the favorite stations that have been saved for e.g., AM, FM.

1. Open the **Radio favorites** app in App view.
2. Tap the desired station to listen.

When a station is removed, it will also be removed from the respective waveband's list of favorites.

<sup>2</sup> Certain stations only.

◀◀ **Changing wavebands<sup>3</sup>**



- Tap an app, e.g., **FM** in App view or open the app menu from the right-side steering wheel keypad to select.

**Searching for a radio station**

Searching is done differently, depending on the waveband selected.

- AM: stations and frequencies.
- FM: stations, genres and frequencies.
- SiriusXM®: program types, genres, stations.

<sup>3</sup> The AM waveband is not available in hybrid models.

<sup>4</sup> HD Radio (TM) technology is manufactured under license from iBiquity Digital Corp. U.S. and Foreign Patents. HD Radio(TM) and the HD and HD Radio logos are proprietary trademarks of iBiquity Digital Corp.

1. Tap **Library**.
2. Tap .
  - > The search view with a keyboard will open.
3. Enter a search word(s).
  - > The search will start and change as characters are entered and the search results will be categorized.

**Searching for a station manually**

Searching manually makes it possible to find and tune to stations that are not on the automatically compiled list of the strongest stations in the area.

- Tap **Manual tuning**, drag the control or tap <> to go to the desired frequency.

**Related information**

- SiriusXM® Satellite radio\* (p. 410)
- HD Radio™reception (p. 406)

**HD Radio™reception**

HD Radio is a brand name registered by the iBiquity digital corporation<sup>4</sup>. They are the developer of a broadcasting technology called IBOC or In Band On Channel, which refers to the method of transmitting a digital radio broadcast signal centered on the same frequency as the AM or FM station's present frequency.

**Introduction**

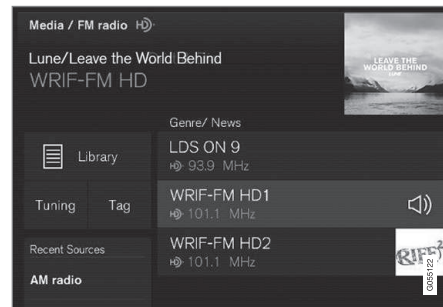

Display when the radio is receiving an HD Radio broadcast (generic illustration)

**i NOTE**

HD Radio volume may fade in and out at times due to coverage limitations.

The IBOC system is referred to as a "hybrid" since it is both analogue and digital. During hybrid operation, receivers still continue to receive the analogue (non-digital) signal. HD Radio receivers incorporate both modes of reception, where the receiver will automatically switch to the analogue signal if the digital signal cannot be decoded or is lost by the receiver.

When you have tuned to an HD Radio station, the  symbol will appear in the infotainment system display. The symbol will be displayed in different colors:

- **Grayed-out symbol:** NoHD Radio broadcast reception
- **White symbol:** the radio is actively receiving an HD broadcast
- **Orange symbol:** the radio is receiving an HD broadcast with digital sound

More information about HD Radio and IBOC can be found on Ibiqity's website, [www.hdradio.com](http://www.hdradio.com) and [www.ibiqity.com](http://www.ibiqity.com).

### Artist Experience™

A radio station's logo and album art can be displayed. If a station opts to provide this information, it is broadcast once every 12 minutes, which means that there may be a delay before the logo/album art appear on the screen. The radio can store 100 station logos so the next time the radio is tuned to the same station, the logo will

be displayed immediately. Album art is synched with the artist that you are currently listening to.

### iTunes tagging

This feature is common to both HD Radio and SiriusXM® Satellite radio\*. See the section "iTunes tagging" in the article "SiriusXM satellite radio settings" for more detailed information.

### Ball game mode

This feature means that a main FM station (HD1) will broadcast live events, where the content of the programming is more important than sound quality, in analog mode only to help prevent the delay between analog and digital broadcasting. The HD Radio symbol will be white during live broadcasts and "Live" will be displayed next to the symbol.

### Benefits of digital broadcasting

- Better sound (FM sounds near CD quality and AM as analogue FM).
- Some FM frequencies offer a greater number of listening choices through "multicasting" (consisting of a frequency's main channel and any sub-channels that may also be available on that particular frequency.)
- When receiving a digital signal there is no multipath disturbance or hisses/pops/crackling due to outside influences.

### How HD Radio™ Technology broadcasting works

HD Radio works similarly to conventional radio and broadcasts of this type are available in many areas of the United States. However, there are a few key differences:

- Instead of transmitting one analogue signal, stations send out a bundled signal – both analogue and digital.
- An HD Radio receiver can receive both digital and analogue broadcasts. Depending on the terrain and location of the vehicle (which will influence the signal strength), the receiver will determine which signal to receive.

### Related information

- Switching HD Radio on and off (p. 408)
- HD Radio sub-channels (p. 408)
- HD Radio limitations (p. 409)
- Radio (p. 404)
- Changing and searching for radio stations (p. 405)

## Switching HD Radio on and off

The factory setting for HD Radio is **off**.

### Switching HD on or off

When listening to an HD Radio station and driving through areas with weak HD signals (fringe areas), you may experience that the radio repeatedly switches between analogue/digital and digital/analogue reception. If this happens, it may be desirable to switch HD off.

To do so:

1. Be sure the infotainment system is switched on and in AM or FM mode.
2. To access the settings menu from the center display's Home view, pull down Top view and tap **AM/FM Radio**.

Go to **Adjust settings for media**.

3. Tap the **AM HD Radio** or **FM HD Radio** box to select/deselect this function.

This will disable the radio's capability to receive digital broadcasts but it will continue to function as a conventional (analogue) AM/FM receiver. Please note that when HD is switched off, it will not be possible to tune to sub-channels (see the article "HD Radio subchannels" for a more detailed explanation of sub-channels).

Please note that this will only switch HD Radio on or off (selecting or deselecting the function) only affects the selected waveband.

## Related information

- HD Radio™ reception (p. 406)
- HD Radio sub-channels (p. 408)
- SiriusXM® Satellite radio\* settings (p. 412)

## HD Radio sub-channels

In many cases, a main HD Radio station (FM wavebands only) will also have sub-channels offering additional types of programming or music.

### Sub-channels

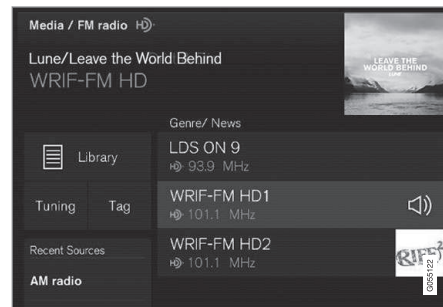

Example of an HD Radio station with sub-channels

If any sub-channels are available, they will listed below the main channel on the screen. In this example, "WRIF-FM HD2" is a sub-channel.

### Selecting sub-channels

To listen to a station's sub-channel(s), tap the station on the screen or press the forward/back arrow keys on the right-side steering wheel keypad or below the screen.

Sub-channels can also be stored as favorites, see the article "Changing and searching for radio stations".

If you tap a sub-channel favorite, it may take up to **6 seconds** before the channel becomes audible. If you tap a station while you are out of digital range of the transmitter, **No reception** will be displayed.

### Related information

- HD Radio™ reception (p. 406)
- Switching HD Radio on and off (p. 408)
- Changing and searching for radio stations (p. 405)

## HD Radio limitations

### Limitations

- **Main channel vs. sub-channels (FM only):**  
The main channel is the only channel that can receive in hybrid mode (both digital and analogue). If a frequency has sub-channels, they are broadcast in digital mode only. The main FM channel will be displayed as, for example, "WRIF-FM HD1". The sub-FM channels will be displayed as "WRIF-FM HD2", "WRIF-FM HD3", etc.
- **Reception coverage area:** Due to current IBOC transmitter power limitations, the reception coverage area in digital mode is somewhat more limited than the station's analogue coverage area. Please be aware that as with any radio broadcast technology, terrain, time of day, foliage level and building location can have positive or negative effects on radio reception.
- **Analogue to digital/digital to analogue blending:** Analogue to digital blending will occur as the signal strength reaches a preset threshold in the receiver. This will be noticeable in fringe areas (areas with weak reception) and is normal.

### NOTE

There may be a noticeable difference in sound quality when a change from analogue to digital or digital to analogue occurs, such as:

- Volume increase or decrease
- Equalizer settings, i.e., Bass/ Midrange/ Treble cut or boost
- Time alignment (Digital program material in extreme cases can be as much as 8 seconds behind the analogue). This will be noticeable as a "stuttering" effect.

**The above items are dependant on the broadcaster's equipment settings and do not indicate a fault in the vehicle's radio receiver or antenna systems.**

### Related information

- HD Radio sub-channels (p. 408)
- HD Radio™ reception (p. 406)

## SiriusXM® Satellite radio\*

The SiriusXM® Satellite system broadcasts from a number of high elevation satellites in geosynchronous orbit.

### Listening to satellite radio

The digital signals from the satellites are line-of-sight, which means that physical obstructions such as bridges, tunnels, etc, may temporarily interfere with signal reception.

Avoid any obstructions, such as metallic objects transported on roof racks or in a ski box, or other antennas that may impede signals from the SiriusXM® satellites.

### Selecting SiriusXM® Satellite radio mode

1. From the center display's Home view, swipe from right to left to come to App view.



2. Tap the SiriusXM® Satellite radio icon.

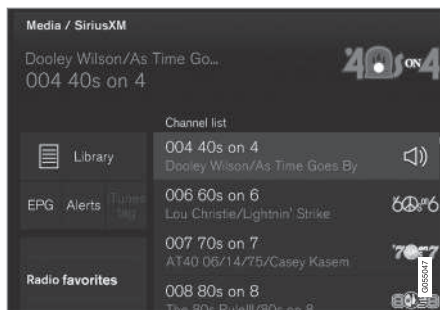

Home view with SiriusXM® Satellite radio activated

If there is no subscription activated, tap channel 1, where you will be prompted on the screen to phone SiriusXM®.

If a cell phone is paired and connected to the vehicle, you can also subscribe by:

1. From Home view, pull down the Settings menu.
2. Open the settings menu for SiriusXM® Satellite radio.
3. Tap **Unsubscribed Services**
4. Tap the phone number to call SiriusXM®, who will activate the subscription of your choice. This may take several minutes.

When the subscription has been activated, tap the SiriusXM® Satellite radio icon to start the

function and display the channel list included in your subscription.

### Related information

- Using SiriusXM® Satellite radio\* (p. 411)
- SiriusXM Travel Link\* (p. 413)



## Using SiriusXM® Satellite radio\*

SiriusXM® Satellite radio offers several features for finding and listening to music, news, sporting events, etc. being broadcast on satellite radio stations.

### SiriusXM® Satellite radio functions

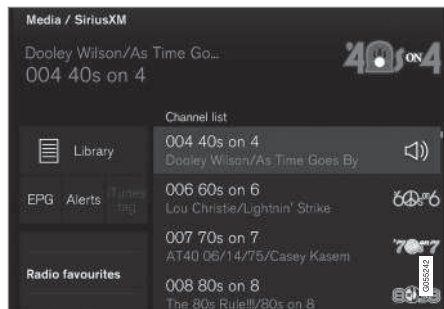

With SiriusXM® Satellite radio activated, tap **Library** to display a screen offering the following functions:

- **Search** (the magnifying glass icon)
- **Channels**
- **Favorites**
- **Categories**

If you have used this view previously, you will be returned to the most recently used one.

### Search

Tap the magnifying glass to display a screen where you can enter text using the center display's keyboard or by writing in the free-text field to search for e.g., a station number, an artist, song title, etc.

### Channels

Tap to display a complete list of the channels included in your subscription. Tap a channel name to listen. If a subscription to a channel has expired, its name will be grayed-out on the screen.

For quick access to a channel that you often listen to, tap the star to the right of the channel's name to add it to the list of favorites.

### Favorites

Tap to display the channels that you have added to this list. Tap a channel name to listen.

### Categories/Genres

Tap to display the categories available. Tap a category or genre name to display the channels that it contains and then tap a channel to listen.

If an alert has been set (see the section "Alerts" below) and an alert is active for an artist, song or team, virtual categories will also be temporary created and displayed. The channels currently broadcasting the song, artist or broadcasting a program with the selected team will be listed in a virtual category.

## EPG (Electronic Program Guide)

On the center display's Home screen, tap **EPG** for information about e.g., when a program is being broadcast and its name, description, artist, etc. If no information is currently available, **No information** will be displayed.

### Alerts

If this feature has been selected under **SiriusXM Settings**, the **Alerts** button will be displayed on the Home screen.

To add e.g., an artist's name, song title or a sports team to the list of alerts:

1. Tune to any channel that is broadcasting a song, game, etc., of your choice.
2. Press the **Alerts** button.
3. A pop-up window will be displayed showing a list of alerts (nothing will be displayed if the selected channel does not support the alert function).
4. Select one of the alternatives in list (only one can be selected at a time).
5. The song/artist/team will now be added to the list of alerts. Favorite sports teams can also be added to the list using the "Game Alert" setting as described in the article "SiriusXM satellite radio settings."
  - > When your choice is being broadcast on a channel, you will be informed by a pop-up.



◀ **iTunes tagging**

From the center display's Top view, tap **SiriusXM Settings**. Tap the **iTunes Tagging** menu. Tap the **iTunes Tagging** box to activate/deactivate this function and tap **Close** to return to Home view. Tap **Tags List** to display a list of all tagged songs.

If the function is activated, the **iTunes tag** button will be displayed in Home view. If a song is played that you would like to buy in the iTunes store, tap this button while the song is playing to tag it. If a song with **iTunes Tagging** information is available, the button will be selectable. Tap the button to tag the song. If you would like to buy a tagged song via iTunes, Tap the iTunes tag button.

To buy a song in iTunes, begin by connecting an iPhone/iPod/iPad to the USB socket in the tunnel console. The iTunes tagging list will automatically be transferred to the device and removed from the list in the vehicle. If the device is connected when a song is tagged, the data will automatically be saved in the device. To purchase the song, consult the iTunes support page.

**Related information**

- SiriusXM® Satellite radio\* (p. 410)
- Using the center display keyboard (p. 31)
- SiriusXM® Satellite radio\* settings (p. 412)
- Connecting a device via the AUX/USB socket (p. 426)

**SiriusXM® Satellite radio\* settings**

There are numerous settings that can be made to enhance your SiriusXM® Satellite radio listening experience.

**Settings**

To access the settings menu from the center display's Home view, pull down Top view and tap **SiriusXM Settings**. The following alternatives will be displayed:

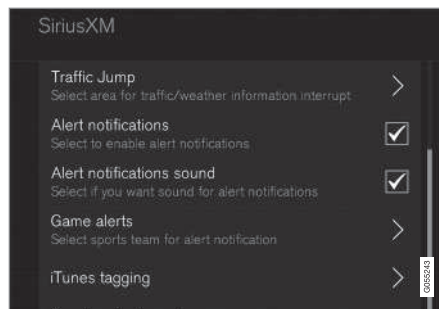

**Traffic Jump**

Tap to display a list of cities from which you can choose to get traffic/weather information (or **Traffic jump off** to deactivate the feature). Tap to select a city (**JUMP** will be displayed on the Home screen next to **Library**). Tap **Back** to return to the list of settings or **Close** to return to the Home screen.

From the Home screen, tap **JUMP** to activate the function. When traffic/weather information is available from the selected city, the radio will automatically tune to the channel providing the information. When the information/announcement is finished, the radio will automatically return to the channel that you were previously listening to.

During an announcement, tap **JUMP** to interrupt the message and return to the station that you were currently listening to.

**Alert notifications**

Tap the box to activate/deactivate. When activated, you will be notified if a song, artist, etc. that you have selected is playing. You will be asked if you want to listen.

**Alert notifications sound**

Opt to receive an audible alert when one of your selected choices is being played.

**iTunes tagging**

Tap to display a menu with the options: **iTunes Tagging** and **Tags List**. With this feature activated, songs can be tagged for later purchase from the iTunes store.

### Game Alerts

Tap to display a list of sports.

Tap a sport to display a list of teams and tap a box on the right side of the screen to select a team as a favorite. An alert will then be provided when information about the team is being broadcast.

Tap **Confirm** below the list to return to the list of sports.

Tap **Back** to return to the list of settings or **Close** to return to the main screen.

### Unsubscribed services

If you have a SiriusXM® Satellite radio subscription, any channels not included in the subscription will be listed here. Call SiriusXM™ to subscribe. The phone number will be shown on the screen. If a cell phone is paired and connected to the vehicle, tap the phone number to make the call.

### Skipped stations

Tap to display a list of channels that you would like to skip (hide). Hide channels from the channel list by tapping the boxes to the right of the screen. Skipped (hidden) channels will not be shown in the channel list. However, a channel previously selected as a favorite will still be displayed in the list of favorites, even it has been added to the skip list.

### Skipped categories

Tap to display a list of categories. Tap a category to skip (hide) it. It will not be displayed in the list of categories.

### Related information

- Using SiriusXM® Satellite radio\* (p. 411)
- SiriusXM® Satellite radio\* (p. 410)

### SiriusXM Travel Link\*

SiriusXM Travel Link is a feature offered by SiriusXM® Satellite radio\* that can provide information about e.g., weather forecasts, weather alerts, service stations, sports, etc. in the vicinity of the vehicle.

### Starting SiriusXM Travel Link

#### NOTE

SiriusXM Travel Link services are only available in vehicles equipped with the Sensus Navigation system.

From the center display's App view, tap **SiriusXM Travel Link** to activate the feature. A disclaimer text will be displayed. Tap **OK** to display a list of SiriusXM Travel Link services:

- Alerts
- Fuel
- Sports
- Weather
- Favorites

In order to use one or more of these services, the user has to subscribe to the ones desired.

To subscribe to a SiriusXM Travel Link service:

1. Open the center display's Top view.
2. Tap **SiriusXM Travel Link** .



◀◀ 3. Tap **Subscription Status**.

- > To subscribe, call the phone number listed on the screen.

Any services not subscribed will be grayed out and contain the text **Service not subscribed**.

When the services have been activated (subscribed), tap the one of your choice to start it.

**The following applies for all of the SiriusXM Travel Link services:**

- Pressing the **Back** button will take you back to the previous screen
- Pressing the **Close** button will take you to the SiriusXM Travel Link home screen.

**i NOTE**

If the **Close** button is used to return to SiriusXM Travel Link home screen, the following applies (the **Weather** service is used here as an example):

- If you have already used the **Weather** function, tapping **Weather** again in the SiriusXM Travel Link home screen **before using any other SiriusXM Travel Link service** will return you to the point where you left the **Weather** service
- If another SiriusXM Travel Link service is used (e.g., Fuel, Sports, etc.) before you return to the **Weather** service, you will be returned to the default **Weather** view (in this case, **Local**)

The same principle applies to all of the SiriusXM Travel Link services.

- Navigating in the center display's views (p. 38)
- SiriusXM Travel Link - Weather (p. 415)
- SiriusXM Travel Link - Sports (p. 418)
- SiriusXM Travel Link - Alerts (p. 416)
- SiriusXM Travel Link - Fuel (p. 417)

**Favorites**

Many SiriusXM Travel Link selections can be saved for easy access as favorites by tapping the "star" icon next to the selection where applicable.

To display a list of your favorites, tap the **Favorite** application in the SiriusXM Travel Link home screen.

**Related information**

- SiriusXM® Satellite radio\* (p. 410)
- Center display overview (p. 28)

## SiriusXM Travel Link - Weather

This SiriusXM Travel Link service provides weather-related information near the vehicle, at a local ski resort, etc.

From the SiriusXM Travel Link home screen, to display weather-related information:

- Tap the **Weather** button to display this screen.

At the top of the screen, the following categories will be displayed:

- Search (the magnifying glass icon)
- **Local**
- **Ski condition**
- **Areas**
- **Favorites**

Tap the category of your choice.

### Search

Tap the magnifying glass icon. If the function is supported in the current context, a keyboard will appear on the screen. Enter the text of your choice and tap **Search** for detailed information from the SiriusXM Travel Link database.

### Local<sup>5</sup>

Information from the closest weather station will be displayed and the following alternatives are available:

- Map view
- Today
- 5 days

#### Map view

Tap the map to display it full-screen. Tap **Back** to return to the original map view.

Tap **Map options** to display the following alternatives.

- **Weather radar**
- **Storm attributes**
- **Surface features**
- **Tropical storm tracks**
- **Winds**

Tap the respective boxes to the right of the alternatives to select/deselect. Tap **Done** to confirm and return to the previous screen or **Cancel**.

#### Today

Tap to see the current temperature, or the temperature in 3/6 hours.

Tap **Back** to return to the **Local** screen or **Close** to return to the SiriusXM Travel Link home screen.

### 5 days

Tap to see weather information for the coming 5 days.

Tap **Back** to return to the **Local** screen or **Close** to return to the SiriusXM Travel Link home screen.

### Ski location

Tap to display a list of ski areas in the vicinity of the vehicle. Tap a name in the list for information such as if the ski area is open/closed, temperature, wind conditions, snow conditions, the number of lifts that are in operation, etc.

- Weather locations
- Ski locations

Tap Map view to display a map and a weather legend.

Tap **Map options** to display the following alternatives.

- **Weather radar**
- **Storm attributes**
- **Surface features**
- **Tropical storm tracks**
- **Winds**

Tap the respective boxes to the right of the alternatives to select/deselect. Tap **Done** to confirm and return to the previous screen or **Cancel**.

<sup>5</sup> This is the weather default unless another alternative has been selected.

◀ **Areas**

Tap **Areas** to display a list of areas/locations in states from the SiriusXM Travel Link database.

Scroll to a state and tap to display:

- **Weather locations:** tap arrow to the right to display a list of towns. Scroll to desired town and tap for detailed weather information. You can choose Map view, today, 5 days or Favorites (star)
- **Ski locations:** tap arrow at right to display local ski areas. Tap an area for detailed info. See also "Ski locations" above.

For information about storing a location, state, town, etc. as a favorite, see the heading "Favorites" in the article "SiriusXM Travel Link."

**Related information**

- SiriusXM Travel Link\* (p. 413)
- SiriusXM Travel Link - Alerts (p. 416)

**SiriusXM Travel Link - Alerts**

This SiriusXM Travel Link service provides alerts for potential weather problems or other emergency situations in the vicinity of the vehicle.

From the SiriusXM Travel Link home screen, to display alerts:

- Tap the **Alerts** button to display the this screen.
- If any alerts are currently available, a notification will appear at the top of the screen. They can also be listed from the **Settings** menu in the center display's Top view.
- If no alerts are available, **No active alerts** will be displayed.

**Types of alerts**

To select the types of alerts to be displayed:

1. From the **Alerts** screen, tap the **Select alerts** button at the bottom of the screen.
2. This displays the types of alerts that can be displayed. Tap the box to the right of each type of alert to select/deselect it.
3. Tap **Done** when you have made your selections to return to the **Alerts** screen.

**Information about an alert**

If any alerts have been displayed on the screen, tap one for more detailed information (i.e., the location of the weather problem on a map and a description of the situation).

If a phone number is available in an alert, a **Call** button will be displayed. Tap this button for additional information.

**Related information**

- SiriusXM Travel Link\* (p. 413)
- SiriusXM Travel Link - Weather (p. 415)

## SiriusXM Travel Link - Fuel

This SiriusXM Travel Link service provides information and guidance to service stations near the vehicle providing the type of fuel that you prefer/require for your vehicle.

From the SiriusXM Travel Link home screen, to display fuel information:

- Tap the **Fuel** button to display main fuel screen.

The following **Fuel** categories will be listed:

- Search (the magnifying glass icon)
- **Nearby**
- **Recommended**
- **Favorites**
- **Brands**

Tap one of the alternatives to display its screen.

### NOTE

In each of the **Fuel** categories listed, tapping the **Select fuel type** button near the bottom of the screen opens a sub-view where you can specify the type of fuel preferred/required (regular, premium, diesel, 120V, etc.). Tap **Done** to return to the previous screen.

## Search

Tap the magnifying glass icon. If the function is supported in the current context, a keyboard will

appear on the screen. Enter the text of your choice and tap **Search** for detailed information if available.

## Nearby

Tap for a list of service stations in the vicinity of the vehicle, with the nearest station at the top of the list.

The following information will be provided where available:

- For vehicles using gasoline, the price information for regular gasoline (unless another grade/type of fuel has been selected in **Select fuel type**)
- For electric vehicles/hybrids, information about charging stations, showing the total number of charging ports and the number of ports currently not in use
- the distance to the station
- a star icon to set the service station as a favorite

Tap the name of a service station to display more detailed information.

For guidance to the service station, tap the **Start navigation** or **Add as waypoint** buttons. See the Sensus Navigation supplement for additional information about using the navigation system.

## Recommended

Tap for a list of service stations near the vehicle, displayed according to the price of regular gaso-

line (unless another grade/type of fuel has been selected in **Select fuel type**) or of stations offering the greatest number of available charging ports for electric vehicles/hybrids. The station offering the lowest price/most available charging ports will be displayed at the top of the list. Tap the name of a service station to display more detailed information.

## Favorites

Tap for a list of service stations that have been stored as favorites. See also the heading **Favorites** in the article "SiriusXM Travel Link" for information explaining how to create favorites. Tap the name of a service station to display more detailed information.

In addition to the **Select fuel type** button at the bottom of the screen, tap the **Edit** button to delete individual stations from the list or tap **Delete all** to clear the list. Tap **Done** to return to the previous screen.

## Brands

1. Tap **Brands** to display a list of service station brands in the area.
2. Tap a brand to display a list of service stations affiliated with that brand (e.g., BP, Exxon, etc.).
3. Tap the name of a service station to display detailed information.

In addition to the **Select fuel type** button at the bottom of the screen, tap the **Sort** button to



- ◀ arrange the list according to **Nearest** or **Recommended**. Tap **Done** to return to the previous screen.

**Related information**

- SiriusXM Travel Link\* (p. 413)
- Octane rating (p. 372)
- Opening/closing the fuel filler door (p. 373)
- Fuel (p. 371)

**SiriusXM Travel Link - Sports**

This SiriusXM Travel Link service provides information sporting events, tournaments, teams, leagues, etc.

From the SiriusXM Travel Link home screen, to display sports information:

- Tap the **Sports** button to display the main sports screen.

A number of **Sports** categories will be listed (Football, Baseball, Basketball, etc.)

Tap a sport to select a league in that sport (NFL, MLB, etc.) or a sport organization (PGA, LPGA, etc.).

**The following is an example of the result of tapping Baseball:**

1. MLB (Major League Baseball) will be displayed.
2. Tap MLB to display the two leagues in Major League Baseball (American League or National League).
3. Tap one of the league names to display the divisions in the league.

4. Tap one of the divisions to display:

- **In progress:** play-by-play information about a match/game/tournament currently in progress. Continue tapping to display. In the detailed view, you can also select a radio station that is currently broadcasting an ongoing sporting event
- **Headlines for MLB:** Tap to display brief headline information
- **Scheduled:** schedules for coming matches, games, etc.
- **Scores:** match/game results

The same principle applies to all sports.

**Related information**

- Using SiriusXM® Satellite radio\* (p. 411)



## Phone

A Bluetooth-enabled cell phone can be paired and connected to the vehicle's integrated hands-free system.

The infotainment system offers hands-free functionality for remote-controlling a number of a cell phone's features. The phone's integrated controls can also be used, even when it is connected to the vehicle.

When the phone has been paired and connected to the infotainment system, it can be used to make or receive calls, send or receive text messages, to stream music, etc., or as an Internet connection.



The phone is controlled from the center display but the App menu (accessed using the right-side steering wheel keypad) and voice commands can also be used to control certain functions.

## Overview

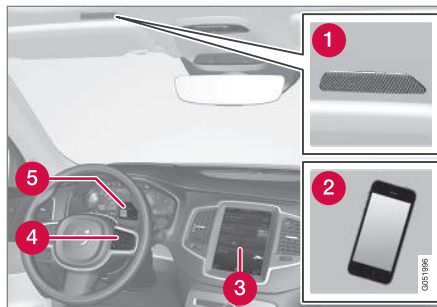

- 1 Microphone
- 2 Cell phone
- 3 Center display
- 4 Keypad for controlling phone functions shown in the center display and voice commands
- 5 Instrument panel

## Related information

- Connecting/disconnecting a cell phone (p. 421)
- Handling phone calls (p. 422)
- Handling text messages (p. 424)
- Pairing a cell phone (p. 420)
- Phone settings (p. 425)

- Text message settings (p. 426)

## Pairing a cell phone

A Bluetooth®-enabled cell phone or other device can be paired and wirelessly connected to the infotainment system.

When a cell phone or other device is connected, audio can be streamed to the infotainment system. Toggle between the devices by pressing the **TEL** and **MEDIA** buttons to access the respective sources' functions.

**Before a Bluetooth device can be used with the infotainment system, it has to be paired ("registered").**

This procedure only needs to be done once for each device (a maximum of 20 Bluetooth devices can be paired to the system). Once a device has been paired and its Bluetooth function is activated, it can then be selected for use (wirelessly connected) to the vehicle's infotainment system.

Two Bluetooth devices can be connected at the same time. However, if two cell phones are connected, only the most recently connected one can be used as a phone. The other one can be used to e.g., to stream audio or video. To change what the phone will be used for, see the article "Bluetooth settings."

A paired and connected cell phone can also be used to connect the vehicle to the Internet. To do so, its tethering/personal hotspot function must be activated.

There are two ways of pairing a Bluetooth device to the infotainment system:

- Searching for the phone (or other device) from the vehicle
- Searching for the vehicle from the phone (or other device)

The following instructions assume that a cell phone is to be paired to the infotainment system but the procedure is the same for any Bluetooth device.

### Alternative 1: searching for the phone from the vehicle

1. Make the phone discoverable/visible using its Bluetooth function. Refer to the phone's user guide if necessary.
2. Open the Phone view on the center display.
  - > • If no phones have been paired to the vehicle, tap **Add phone**.
  - If a list of phones is displayed, tap **Change**  and tap **Add phone** in the pop-up window.
3. Tap the name of the phone to be connected.
4. Check that the code displayed in the vehicle is the same as the one in the phone. Confirm in both places.

5. For the phone selected, accept or cancel the alternatives for the phone book (list of contacts), text messages, etc. Full functionality may not be available in all cell phones.
6. To connect the vehicle to the Internet via the phone's Bluetooth function, activate the phone's function for tethering/personal hotspot, etc.

### Alternative 2: searching for the vehicle from the phone

1. Open the center display's Phone view.
  - If no phones have been paired to the vehicle, tap **Add phone** → **Make vehicle discoverable**.
  - If a phone has previously been paired to the vehicle, tap **Change**  and tap **Add phone** → **Make vehicle discoverable** in the pop-up window.
2. Activate the phone's Bluetooth function.
3. Search in the phone for Bluetooth devices.
  - > A list of Bluetooth devices will be displayed.
4. Select the vehicle's name in the list.
5. Check that the code displayed in the phone is the same as the one in the vehicle. Confirm in both places.

6. For the phone selected, accept or cancel the alternatives for the phone book (list of contacts), text messages, etc. Full functionality may not be available in all cell phones.
7. To connect the vehicle to the Internet via the phone's Bluetooth function, activate the phone's function for tethering/personal hotspot, etc.

### NOTE

If your cell phone's operating system is updated, this may break the connection between the phone and the vehicle. If this happens, delete the phone from the list of paired phones and repeat the pairing procedure described in this article.

### Compatible cell phones

Many of the cell phones available today have Bluetooth functionality but not all of them are fully compatible with the vehicle. Go to [www.volvocars.com](http://www.volvocars.com) for a list of compatible phones or contact your Volvo retailer.

### Related information

- Connecting/disconnecting a cell phone (p. 421)
- Handling phone calls (p. 422)
- Handling text messages (p. 424)
- Phone settings (p. 425)
- Bluetooth settings (p. 441)

## Connecting/disconnecting a cell phone

Once a cell phone or other Bluetooth device has been paired to the infotainment system, it can be connected, disconnected or removed from the list of available devices.

### Connecting automatically

Only the 2 most recently connected cell phones can be connected automatically.

1. Before switching on the vehicle's ignition, be sure that the phone's Bluetooth function is activated.

To connect to the Internet, the phone's personal hotspot (tethering) function must also be activated.

2. Switch on the ignition.
  - > The phone will be connected to the system and can be used wirelessly.

### Connecting manually

1. Be sure that the phone's Bluetooth and personal hotspot (tethering) functions are activated.
2. In the center display, open Phone view and tap **Change phone**.
  - > A list of available Bluetooth devices (ones that have already been paired to the infotainment system) will be displayed.

3. Tap the name of the phone or other device to be connected.
  - > The phone (or other device) will be connected.

### Disconnecting a phone

- Deactivate the phone's Bluetooth function.

If a phone is carried out of range of the vehicle, it will automatically be disconnected.

If a call in progress when this is done, the call will be transferred from the vehicle's speakers/microphone to the cell phone.

### Changing phones

1. In the center display, open Phone view.
2. Tap **Change**  .
  - > A list of available Bluetooth devices (ones that have already been paired to the infotainment system) will be displayed.
3. Tap the name of the phone (or other device) to be connected.

### Removing a phone (or other device) from the list

1. In the center display, open Phone view.
2. Tap **Settings** → **Communication** → **Bluetooth Devices**.
  - > A list of available Bluetooth devices (ones that have already been paired to the infotainment system) will be displayed.



- 3. Tap the name of the phone to be deleted from the list.
- 4. Tap **Remove device** and confirm.
  - > The phone or other device is no longer paired to the vehicle. Before this device can be used again, the pairing procedure will have to be repeated.

**Related information**

- Pairing a cell phone (p. 420)

**Handling phone calls**

Calls can be made to one or more parties.

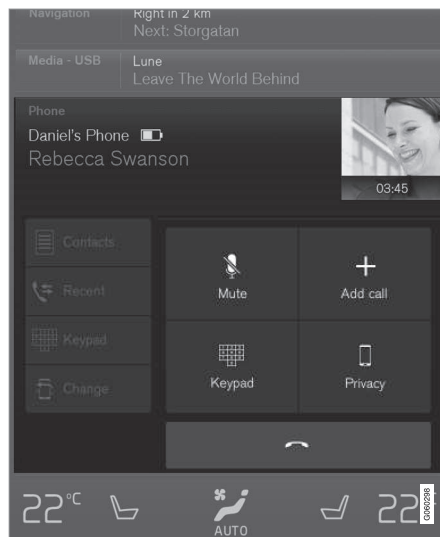

Generic illustration

**Making calls**

- 1. In the center display, open Phone sub-view.

- 2. Initiate a call from: recently made calls, the phone book (list of contacts) or enter a number. Search for or scroll to a contact in the phone book. Tap ☆ in the phone book to add a contact to your list of **Favorites**.

- 3. Tap **Call** or ☎.

- 4. Tap **End call** to end a phone call.

Calls can also be made from the list of recent calls using the App menu, which can be opened using the right-side steering wheel keypad's ☰ symbol.

**Making multiple calls**

While a call is in progress:

- 1. Tap **Add call**.
- 2. Select from the list of recent calls or from the phone book.
- 3. Tap a line in the list of recent calls or ☎ to call a contact in the phone book.
- 4. Tap **Swap call** to toggle between calls.
- 5. Tap **End call** to end a phone call.

**Group (conference) calls**

While multiple calls are in progress:

- 1. Tap **Join calls** to merge ongoing calls.
- 2. Tap **End call** to end a phone call.

## Incoming calls

Information about incoming calls is displayed in the instrument panel and the center display. Handle the calls using the right-side steering wheel keypad or the center display.

1. Tap **Answer/Reject**.
2. Tap **End call** to end a phone call.

## Incoming calls while another call is in progress

1. Tap **Answer/Reject**.
2. Tap **End call** to end a phone call.

## Privacy

While a call is in progress:

- Tap **Privacy**.
  - > The vehicle's integrated microphone will be turned off.
- **Switch to mobile phone:** the hands-free function will be disconnected and the call will continue in the cell phone.
- **Driver focused:** the microphone in the ceiling liner on the passenger's side will be muted and the call will continue using vehicle's the hands-free function on the driver's side.

## Related information

- Phone (p. 419)
- Voice control for cell phones (p. 120)

- Using the center display (p. 44)
- Using the center display keyboard (p. 31)
- Phone settings (p. 425)

## Managing the phone book

The following is information about keeping track of contacts in your Bluetooth-connected cell phone's phone book.

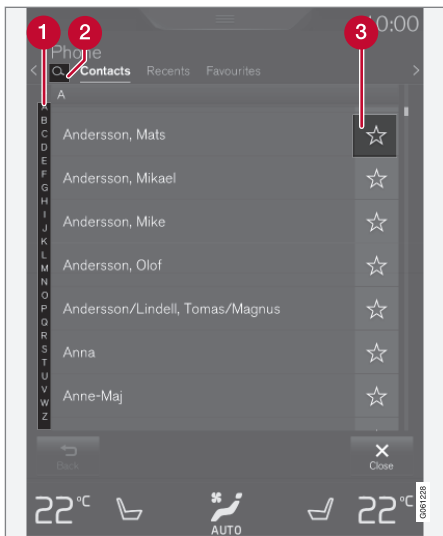

- 1 **Favorites:** tap ☆ to add or remove a contact from the list of favorites.
- 2 **Search contacts:** tap Q to search for a phone number or a name in the phone book (list of contacts).
- 3 To make navigating in the list easier, a quick-select function provides names that match the letters as they entered.

The vehicle can store up to 3,000 contacts from a Bluetooth-connected cell phone. Only contacts

from the currently connected phone are accessible.

### Sorting

The phone book is sorted in alphabetical order and you can choose to sort by first or last names (see the article "Phone settings" for additional information). Any special characters in the list of contacts in the phone book will be listed under "#".

### Related information

- Phone (p. 419)
- Voice control for cell phones (p. 120)
- Phone settings (p. 425)
- Changing settings in apps (p. 113)
- Using the center display keyboard (p. 31)

## Handling text messages

Text messages can be received and sent from a connected cell phone.

Text message functionality has to be activated in certain cell phones and not all phones offer full compatibility/functionality. Go to [support.volvocars.com](http://support.volvocars.com) for additional information.

### Reading text messages in the center display

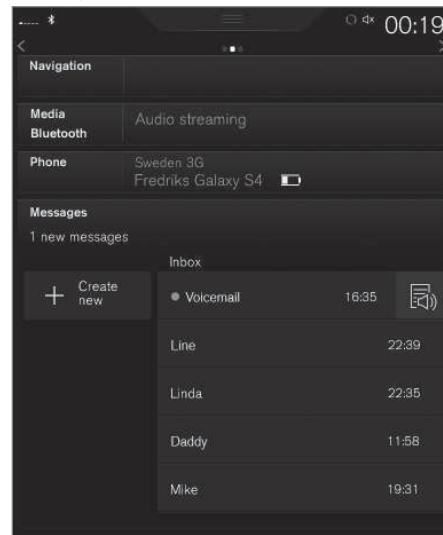

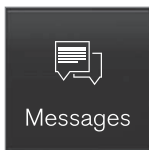

1. From App view, tap **Messages** to open.
2. Tap the name of the contact who sent the message.
3. Tap **Read out** to have the message read aloud or tap the message to be displayed.

### Reading new text messages in the instrument panel

Text messages are only displayed in the instrument panel if this has been selected. See the article "Text message settings" for more information.

- To have the message read aloud, select **Read out** using the keypad in the steering wheel.

### Sending text messages

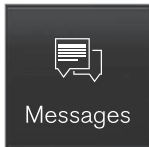

1. From App view, tap **Messages** to open.

2.
  - To reply to a message: tap the name of the contact who sent the message and then tap **Answer**.
  - To create a new message: tap **Create new** → +. Select the contact who will receive the message or enter a phone number.
3. Write or dictate (🗨️) the message.
4. Tap **Send**.

### Message notification

See the article "Text message settings" for a list of possible settings.

### Related information

- Text message settings (p. 426)

## Phone settings

The following settings can be made for a paired and connected cell phone.

### Cell phones

- Pull down the center display's Top view and tap **Settings** → **Communication** → **Phone** and choose among the following settings:
    - **Ringtones:** select a ring tone (tones from the cell phone or the vehicle can be used). Not all cell phones are fully compatible and it may not be possible to use their ring tones in the vehicle. Go to [www.volvocars.com](http://www.volvocars.com) for additional information.
    - **Sort order for contacts:** select sort criteria for the phone book (list of contacts).
- To show call notifications in the head-up display\*, see the article "Head-up display."

### Related information

- Text message settings (p. 426)
- Bluetooth settings (p. 441)
- Phone (p. 419)
- Handling phone calls (p. 422)
- Head-up display (HUD)\* (p. 116)

## Text message settings

The following settings can be made for text messages received through a paired and connected cell phone.

### Text message settings

- Pull down the center display's Top view and tap **Settings** → **Communication** → **Text Messages** and choose among the following settings:
  - **Notification in center display:** shows text messages in the center display's status bar.
  - **Notification in driver display:** shows text messages in the instrument panel. With this alternative active, incoming messages can be handled from the right-side steering wheel keypad.
  - **Text message tone:** select an audible signal for incoming text messages.

### Related information

- Connecting/disconnecting a cell phone (p. 421)
- Pairing a cell phone (p. 420)
- Handling text messages (p. 424)

## Connecting a Bluetooth® device

Bluetooth®-enabled devices can be paired and connected to the infotainment system to stream media and in some cases connect to the Internet.

Many cell phones and other devices currently on the market offer wireless Bluetooth® technology. Consult your Volvo retailer or go to [support.volvocars.com](http://support.volvocars.com) for any questions regarding a device's compatibility with the vehicle's infotainment system.

The procedure for pairing and connecting a Bluetooth®-enabled device is the same as for a cell phone. See the articles "Pairing a cell phone" and "Connecting/disconnecting a cell phone" for details.

### Related information

- Pairing a cell phone (p. 420)
- Connecting/disconnecting a cell phone (p. 421)

## Connecting a device via the AUX/USB socket

External audio sources such as an iPod® or mp3 player can be connected to the infotainment system via the AUX and USB sockets in the tunnel console.

Route the cable out under the front edge to help avoid pinching it when the cover is closed.

If there are two USB sockets, the one with a white frame should be used to connect an iPhone to Apple CarPlay.



AUX/USB sockets in the tunnel console

### Related information

- Apple CarPlay (p. 428)
- Playing media (p. 432)
- Media player technical data (p. 437)
- Media player (p. 427)



## Media player

The media player can play audio from a CD\*, from external media devices connected to the USB/AUX sockets or it can stream audio from an external device connected to the infotainment system through a Bluetooth connection.

Video can also be viewed from devices connected to the USB socket.

If the vehicle is connected to the Internet, it may also be possible to listen to web radio, audio books and to use various music services through apps.

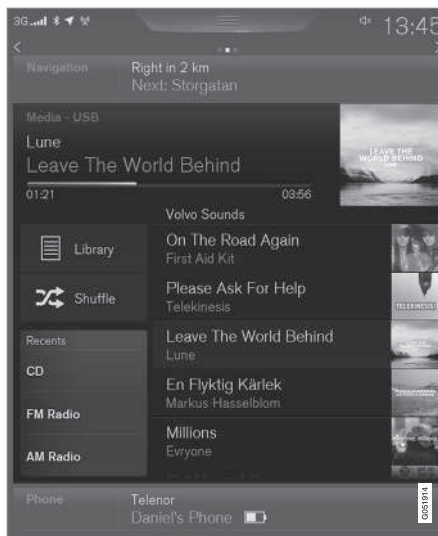

The media player is controlled from the center display but certain functions can also be controlled from the right-side steering wheel keypad or by using voice commands.

### Related information

- Playing media (p. 432)
- Voice control for radio and media (p. 121)
- Radio (p. 404)

- Apps (applications) (p. 402)
- CD (media) player\* (p. 432)
- Playing media through the AUX/USB sockets (p. 435)

## Apple CarPlay

Apple CarPlay helps make it possible to listen to music, make phone calls, get directions to a destination, send/receive text messages and use Siri while focusing on driving. Apple CarPlay functions with certain Apple devices.

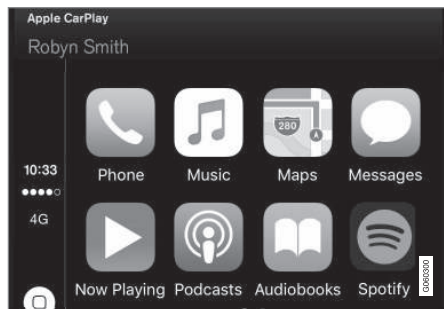



If the vehicle is not already equipped with Apple CarPlay, it can be retro-fitted. Contact a Volvo retailer.

Information about the apps supported and compatible cell phones is available from Apple at: [www.apple.com/ios/carplay/](http://www.apple.com/ios/carplay/).

**i NOTE**

- Using apps that are not compatible with Apple CarPlay may sometimes result in a broken connection between an iPhone and the vehicle.
- Please be aware that Volvo has no control over the content of the Apple CarPlay app.
- Apple CarPlay can only be used if Bluetooth is disabled. Therefore, a cell phone or a media player connected via Bluetooth will not be accessible while Apple CarPlay is active.
- To connect the vehicle to the Internet while Apple CarPlay is active, use Wi-Fi or the vehicle's integrated modem.

If navigation guidance is being provided by Apple CarPlay, this will only be shown on the center display (not on the head-up display\* or the instrument panel).

The Apple CarPlay apps can be controlled from the center display or voice-controlled using Siri (the same as for a cell phone). Certain functions can also be controlled from the right-side steering wheel keypad. Press and hold the  button to activate Siri. If Siri cuts off too soon, press and hold the  button.

**By using Apple CarPlay you acknowledge the following: Apple CarPlay is a service**

provided by Apple Inc. under its terms and conditions. Volvo Cars is thus not responsible for Apple CarPlay or its features/applications. When using Apple CarPlay, certain information from your car (including its position) is transferred to your iPhone. In relation to Volvo Cars, you are fully responsible for your and any others person's use of Apple CarPlay.

### Starting Apple CarPlay

Voice control using Siri must be activated in the currently connected cell phone before using Apple CarPlay.

### From an iPhone that is connected for the first time

1. Connect the iPhone to the USB socket in the tunnel console. If there are two USB sockets, connect to the one with the white frame.
2. Read the information in the pop-up window that appears and tap **OK**.
3. Tap Apple CarPlay in the center display's App view.
4. Read the conditions and tap **Accept** to connect.
  - > The Apple CarPlay sub-view will open and compatible apps will be displayed.
5. Tap the desired app.
  - > The app will start.

### From a previously connected iPhone

1. Connect the iPhone to the USB socket in the tunnel console. If there are two USB sockets, connect to the one with the white frame.
  - > If the automatic start setting **has** been activated, the Apple CarPlay sub-view will open and compatible apps will be displayed.
2. If the automatic start setting **has not** been activated, open the **Apple CarPlay** app from the center display's App view.
  - > The Apple CarPlay sub-view will open and compatible apps will be displayed.
3. Tap the desired app.
  - > The app will start.

Apple CarPlay will run in the background if another app is started in the same sub-view. To return to Apple CarPlay, tap the Apple CarPlay icon in App view.

### Toggling between Apple CarPlay and iPod

#### Apple CarPlay to iPod

1. Tap **Settings** in the center display's Top view.
2. Tap **Communication → Apple CarPlay**.

3. Deselect the Apple device's box that will no longer start Apple CarPlay when it is connected.
4. Disconnect and reconnect the Apple device to the USB socket.
5. Open the **iPod** app from App view.

#### iPod to Apple CarPlay

1. Tap **Apple CarPlay** in the center display's App view.
2. Read the conditions in the pop-up window that appears and tap **OK**.
3. Disconnect and reconnect the Apple device to the USB socket.
  - > The Apple CarPlay sub-view will open.

#### Related information

- Media player (p. 427)
- Playing media (p. 432)
- Connecting a device via the AUX/USB socket (p. 426)
- Apple CarPlay settings (p. 429)

### Apple CarPlay settings

This article explains settings for a cell phone connected through Apple CarPlay.

#### Automatic start

1. Tap **Settings** in the center display's Top view.
2. Tap **Communication → Apple CarPlay** and select the following settings:
  - Select the Apple CarPlay box for automatic start when the device's USB cable is connected.
  - Deselect the Apple CarPlay box to **disable** automatic start when the device's USB cable is connected.

A maximum of 20 Apple devices can be stored in the list. When the list is full, the first (oldest) device stored will be deleted.

To erase the entire list, a factory reset has to be performed. See the article "Resetting the settings view."

#### System volume levels

1. Tap **Settings** in the center display's Top view.

2. Tap **Sound** → **System Volumes** and select the following settings:

- **Voice Control**
- **Navi Voice Guidance**
- **Phone Ringtone**

**Related information**

- Apple CarPlay (p. 428)
- Resetting the settings view (p. 113)

**Android auto\***

Android Auto makes it possible to get voice guidance from the navigation system, listen to music, make calls and to use apps from an Android device, all through a interface integrated into the center display. Android Auto can also be controlled using the buttons on the right-side steering wheel keypad or by giving voice commands while focusing on driving. Android Auto is started from the center display's App view. After Android Auto has been started once, it will then start automatically the next time the device is connected. The automatic start feature can be deactivated in Settings. Android Auto functions with selected Android devices.

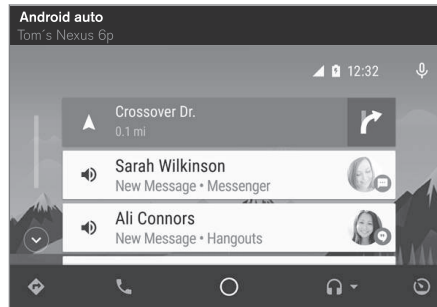

Information about the apps that are supported and the cell phones that are compatible can be found at: [www.android.com/auto/](http://www.android.com/auto/).

<b>i</b>	<b>NOTE</b>
<ul style="list-style-type: none"> <li>● Please be aware that Volvo has no control over the content of the Android Auto app.</li> <li>● If a cell phone or a media player is connected via Bluetooth, it will not be accessible while Android Auto is active because Bluetooth will be disabled. To connect the vehicle to the Internet, use Wi-Fi or the vehicle's integrated modem.</li> </ul>	

If navigation guidance is being provided by Android Auto, this will only be shown on the center display (not on the head-up display\* or the instrument panel).

The Android Auto apps can be controlled from the center display or voice-controlled (the same as for a cell phone). Certain functions can also be controlled from the right-side steering wheel keypad. Press and hold the  button to activate voice control. Press briefly to deactivate.

**By using Android Auto, you acknowledge the following: Android Auto is a service provided by Google Inc. under its terms and conditions. Volvo Cars is not responsible for Android Auto or its features or applications. When you use Android Auto, your car transfers certain information (including its location) to your connected Android phone.**

You are fully responsible for your and any other person's use of Android Auto.

## Starting Android Auto

### Connecting an Android device for the first time

1. Connect the Android device to the USB socket in the tunnel console. If there are two USB sockets, connect to the one with the white frame.
2. Read the information in the pop-up window that appears and tap **OK**.
3. Tap **Android Auto** in the center display's App view.
4. Read the conditions and tap **Accept** to connect.
  - > The Android Auto sub-view will open and compatible apps will be displayed.
5. Tap the desired app.
  - > The app will start.

### From a previously connected Android device

1. Connect the phone to the USB socket in the tunnel console. If there are two USB sockets, connect to the one with the white frame.
  - > If the automatic start setting **has** been activated, the Android Auto sub-view will open and compatible apps will be displayed.

2. If the automatic start setting **has not** been activated, open the **Android Auto** app from the center display's App view.
  - > The Android Auto sub-view will open and compatible apps will be displayed.
3. Tap the desired app.
  - > The app will start.

Android Auto will run in the background if another app is started in the same sub-view. To return to Android Auto, tap the Android Auto icon in App view.

### Related information

- Media player (p. 427)
- Playing media (p. 432)
- Connecting a device via the AUX/USB socket (p. 426)
- Connecting to the Internet (p. 439)
- Android Auto\* settings (p. 431)

## Android Auto\* settings

The following settings can be made for Android Auto.

### Automatic start

1. Tap **Settings** in the center display's Top view.
2. Tap **Communication → Android Auto** and select the following settings:
  - Select the Android Auto box for automatic start when the device's USB cable is connected.
  - Deselect the Android Auto box to **disable** automatic start when the device's USB cable is connected.

A maximum of 20 Android devices can be stored in the list. When the list is full, the first (oldest) device stored will be deleted.

To erase the entire list, a factory reset has to be performed. See the article "Resetting the settings view."

### System volume levels

1. Tap **Settings** in the center display's Top view.



2. Tap **Sound** → **System Volumes** and select the following settings:

- **Voice Control**
- **Navi Voice Guidance**
- **Phone Ringtone**

**Related information**

- Android auto\* (p. 430)
- Resetting the settings view (p. 113)

**CD (media) player\***

The CD (media) player can play commercially purchased discs as well as ones that you have burned yourself. See the article "Media player technical data" for information about compatible file formats.

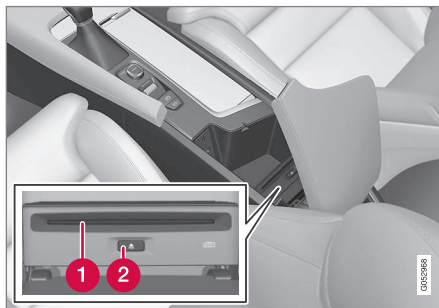

Location of the CD player in the tunnel console

- 1 Disc slot
- 2 Eject button

**Related information**

- Media player technical data (p. 437)

**Playing media**

The media player can be controlled from the right-side steering wheel keypad, the center display or by using voice commands.

The radio is also controlled from the media player. See the articles relating to the radio.

**Starting a media source**



Generic illustration

**CD**

1. Insert a CD.
2. Open the **CD** app in the center display's App view.
3. Select a track.
  - > Playback will begin.

**USB flash drive**

1. Insert the flash drive in the USB socket.
2. Open the **USB** app in the center display's App view.
3. Select a track.
  - > Playback will begin.

**Mp3 player and iPod®****NOTE**

Use the iPod app ( not the USB app) to start playback.

When an iPod is the media source, the infotainment system will use a menu structure similar to the iPod's own menu structure.

1. Connect the device.
2. Start playback in the connected device.
3. Open the **iPod, USB, AUX**) app in the center display's App view.
  - > Playback will begin.

**Bluetooth-connected device**

1. Connect the device.
2. Activate Bluetooth in the device.
3. Start playback from the connected device.
4. Open the **Bluetooth** app in the center display's App view.
  - > Playback will begin.

**Internet media**

1. Connect the vehicle to the Internet.
2. Open the app in the center display's App view.
  - > Playback will begin.

**Video**

1. Connect the device.
2. Open the **USB** app in the center display's App view.
3. Tap the title of the video content to be played.
  - > Playback will begin.

**Apple CarPlay**

Apple CarPlay is described in a separate article.

**Controlling and changing media**

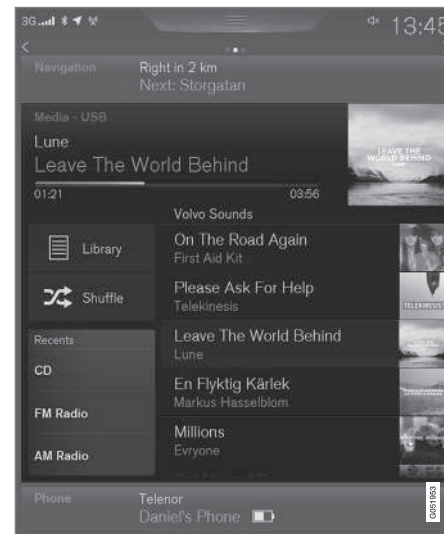

The media player can be controlled using voice commands, the right-side steering wheel keypad or the center display.





Volume: use the ▲ ▼ buttons on the right-side steering wheel keypad or turn the control under the center display to raise or lower the volume.



Play/pause: tap the track's image, press the  symbol on the keypad or press the button under the center display.

Change tracks: tap the desired track on the center display, press the   buttons under the center display or on the right-side steering wheel keypad.

Fast forward/reverse, move within a track: press the time axis on the center display and drag from side to side, press and hold the   buttons under the center display or on the right-side steering wheel keypad.

Change media source: Tap a media source under **Recents**, tap the desired app in the center display's App view or use the  button on the right-side steering wheel keypad.

**Library:** tap to play a track from the library.

**Shuffle:** tap to play tracks in random order.

**Similar:** tap to use Gracenote to search for similar music on the USB device and create a playlist based on the results. The playlist can contain up to 50 tracks.

**Change device:** tap to toggle between USB devices if more than one is connected.

**Video settings**

The following can be adjusted with the video player in full screen or by opening the center display's

Top view and tapping **Settings → Video: Audio Language, Off** and **Subtitle Language.**

**Play DivX®**

This DivX device must be registered in order to play purchased DivX Video-on-Demand (VOD) movies.

1. Open the center display's Top view and tap **Settings → Video → DivX® VOD** to get a registration code.
2. Go to vod.divx.com for additional information and to complete the registration process.

**Related information**

- CD (media) player\* (p. 432)
- Media player (p. 427)
- Voice control for radio and media (p. 121)
- Apps (applications) (p. 402)
- Connecting a Bluetooth® device (p. 426)
- Connecting a device via the AUX/USB socket (p. 426)
- Gracenote (p. 436)
- Connecting to the Internet (p. 439)
- Media searches (p. 434)
- Video (p. 437)
- Apple CarPlay (p. 428)

**Media searches**

Searches can be made for information such as artists, composers, song titles, albums, video, audio books, playlists and podcasts (digital media on the Internet).

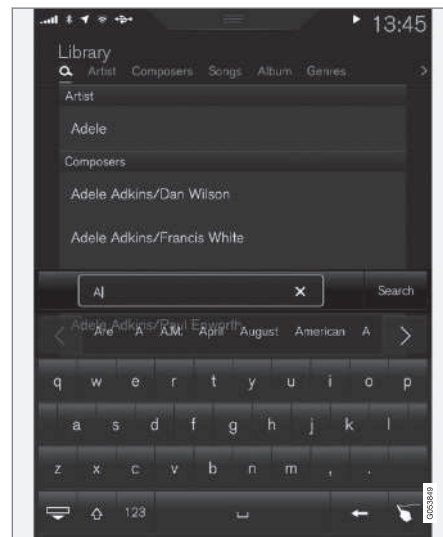

1. Tap .
  - > The center display's Search view opens and the keyboard will be displayed.
2. Enter a search word/phrase.



### 3. Tap **Search**.

- > The infotainment system will search through all connected devices and any results will be displayed by category.

Swipe the screen horizontally to display each category separately.

#### **Related information**

- Media player (p. 427)
- Playing media (p. 432)
- Using the center display keyboard (p. 31)

### **Playing media through the AUX/USB sockets**

An external media device, such as an iPod or an mp-3 player can be connected to the infotainment system.

A device with rechargeable batteries can be recharged when it is connected to the USB socket (if the ignition is on or the engine is running).

To simplify the use of a USB flash drive, it is advisable to only store files with compatible file formats on it. It will take considerably longer for the system to index the files on the drive if it contains anything other than compatible files.

In addition to audio, the vehicle's media player also supports video playback when the external device is connected to the USB socket.

Certain mp-3 players have proprietary file formats that are not supported by the infotainment system.

#### **Related information**

- Connecting a device via the AUX/USB socket (p. 426)

### **Streaming media through a Bluetooth connection**

The media player is equipped with Bluetooth® for streaming audio files from external Bluetooth®-enabled devices.

#### **Related information**

- Connecting a Bluetooth® device (p. 426)
- Playing media (p. 432)
- Voice control for radio and media (p. 121)
- Media player (p. 427)
- Ignition modes (p. 380)
- Media player technical data (p. 437)

## Media sound settings

Sound settings for the media player can be personalized.

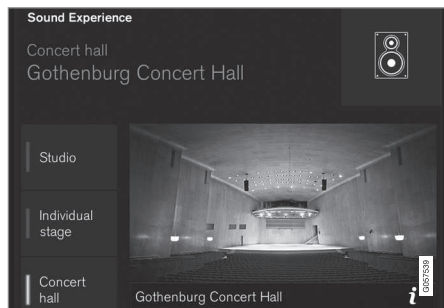

Concert hall sound setting

1. Tap **Settings** in the center display's Top view.
2. Tap **Sound** and select among the following:
  - **Sound Experience\***: this feature offers several ways of adapting media sound settings to replicate e.g., a concert hall or a recording studio. These settings override any of the ones below that may have been adjusted.
  - **Tone**: personal settings for bass, treble, equalizer, etc.
  - **Balance**: adjust the front/rear and left/right sound settings in the passenger compartment.

## System volumes for media

Open the center display's Top view and tap **Settings** → **Sound** → **System Volumes**:

- **AUX**: an external device (e.g., an mp3 player, an iPod, etc.) connected to the AUX socket may have a different volume level than the one set for the infotainment system (e.g., for the radio). This setting enables you to adjust the AUX socket's volume. Please note that if this volume is set too high, sound quality may be affected.
- **Speed and Volume Compensation**: the infotainment system will compensate for disrupting noises in the passenger compartment by increasing media volume in relation to the vehicle's speed. This can be set to one of several different levels.

## Related information

- Playing media (p. 432)
- Sound settings (p. 403)

## Gracenote

Gracenote identifies artists, albums, tracks and any associated images that can be displayed during playback.

Gracenote MusicID® is a standard for music recognition.

## Activating/deactivating Gracenote

When activated, Gracenote data will replace original data.

1. Tap **Settings** in the center display's Top view.
2. Tap **Media** → **Gracenote**®.
3. Activate/deactivate Gracenote by tapping the **Gracenote**® box.
4. Select among the following Gracenote alternatives:
  - **Gracenote**® **Online Search**: Gracenote will search through its online database for information about the currently playing media.
  - **Gracenote**® **Multiple Results**: select how Gracenote data is to be displayed if there are several search results.
    - 1: the file's original data will be used.
    - 2: Gracenote data will be used.
    - 3: Gracenote or original data can be selected.

- **None:** no results will be shown.

### Updating Gracenote

Gracenote's contents are updated continuously. For optimal functionality, always use the latest version. See [support.volvocars.com](http://support.volvocars.com) for information and downloads.

### Related information

- Infotainment system license information (p. 445)
- Playing media (p. 432)

### Video

The media player can play video from USB-connected devices.

No video will be available when the vehicle is moving. Video will resume playing when the vehicle is stationary.

See the article "Media player technical data" for a list of video formats supported by the media player.

### Related information

- Playing media (p. 432)
- Media player (p. 427)
- Media player technical data (p. 437)

### Media player technical data

The following tables list compatible file formats and other technical specifications for the media player.

#### Audio files

Format	File extension	Codec
MP3	.mp3	MPEG1 Layer III, MPEG2 Layer III, MP3 Pro (mp3 compatible), MP3 HD (mp3 compatible)
AAC	.m4a, .m4b, .aac	AAC LC (MPEG-4 part III Audio), HE-AAC (aacPlus v1/v2)
WMA	.wma	WMA8/9, WMA9/10 Pro
WAV	.wav	LPCM
FLAC	.flac	FLAC

#### Video files

Format	File extension
MP4	.mp4, .m4v
MPEG-PS	.mpg, .mp2, .mpeg, .m1v





Format	File extension
AVI	.avi
AVI (DivX)	.avi, .divx
ASF	.asf, .wmv
MKV	.mkv

**Subtitles**

Format	File extension
SubViewer	.sub
SubRip	.srt
SSA	.ssa

**DivX®**

DivX Certified devices have been tested for high quality DivX (.divx, .avi) video playback. When you see the DivX logo, you have the freedom to play your favorite DivX movies.

Profile	DivX Home Theater
Video codec	DivX, MPEG-4
Resolution	720x576
Audio speed (bit rate)	4.8Mbps
Frame per second	30 fps

File extension	.divx, .avi
Max. file size	4 GB
Audio codec	MP3, AC3
Subtitles	XSUB
Special functions	Multiple subtitles, multiple audio, resume play
Reference	Meets all requirements of the DivX® Home Theater profile. Visit divx.com for more information and software tools to convert your files into DivX® Home Theater. video.

**Storing information on a USB device**

In order for the system to read data stored on a USB device, the following specifications must be met. Any folder structures will not be shown in the center display during playback.

	Max. number
Files	15,000
Folders	1,000
Folder levels	8
Playlists	100

	Max. number
Tracks in a playlist	1,000
Subfolders	No limit

**USB socket**

- Type A socket
- Version 2.0
- Voltage 5 V
- Max. current 2.1 A

**Related information**

- CD (media) player\* (p. 432)

## Internet connected vehicle

Connecting to the Internet makes it possible to e.g., use certain navigation services, listen to web radio, stream music using apps, contact a retailer and download software.

The vehicle can connect to the Internet using Bluetooth, Wi-Fi or via the integrated modem.

When connected, it is possible to share (tether) a Wi-Fi-hotspot to allow other devices to use the connection<sup>6</sup>.

Connection status is shown in the center display's status bar.



### Related information

- Connecting to the Internet (p. 439)
- Apps (applications) (p. 402)

- Booking service and repairs (p. 484)
- System updates (p. 482)
- Volvo ID (p. 27)
- Symbols in the center display status bar (p. 43)
- Tethering (Wi-Fi sharing) (p. 443)

## Connecting to the Internet

Connect the vehicle to the Internet using Bluetooth, Wi-Fi or via the vehicle's integrated modem.

The cell phone and the network service provider must support Internet sharing (tethering) and the subscription must include data transfer.

See the terms and confidentiality information at [support.volvocars.com](http://support.volvocars.com) before connecting to the Internet.

### **i** NOTE

When using Apple CarPlay or Android Auto, an Internet connection can only be established by using Wi-Fi or the vehicle's integrated modem.

### Connect using Bluetooth

See the article "Pairing a cell phone."

### Connect using Wi-Fi



<sup>6</sup> This does not apply to Wi-Fi connections.

1. Activate tethering/personal hotspot in the cell phone.
2. Tap **Settings** in the center display's Top view.
3. Tap **Communication → Wi-Fi**.
4. Tap Wi-Fi to activate/deactivate.
5. Tap the name of the network to be used.
6. Enter the network password.
7. If a different connection was used previously, confirm the connection change.
  - > The vehicle will connect to the network.

Please be aware that certain cell phones disable tethering when the connection to the vehicle has been broken, e.g., when the phone has been removed from the vehicle. In such cases, the phone's tethering function will have to be reactivated the next time the phone is used to connect to the Internet.

When a phone is connected to the vehicle, it is saved for future use. When a max. number of 50 have been saved, the first one connected will be deleted. To show the list of saved networks or to manually delete a network, tap **Settings → Wi-Fi → Saved networks**.

See the article "Wi-Fi technology and security" for network connection requirements.

### Connect using the vehicle's integrated modem

When the vehicle is connected using the modem, Volvo On Call services will use the connection.

1. Insert a personal SIM card in the holder.

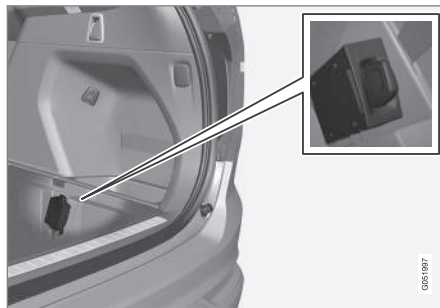

2. Tap **Settings** in the center display's Top view.
3. Tap **Communication → Vehicle Modem Internet**.
4. Tap **Vehicle modem Internet** to activate/deactivate.
5. If a different connection was used previously, confirm the connection change.
6. Enter the SIM card's PIN code.
  - > The vehicle will connect to the network.

### Related information

- Pairing a cell phone (p. 420)
- Connecting/disconnecting a cell phone (p. 421)
- Connecting a device via the AUX/USB socket (p. 426)
- Wi-Fi technology and security (p. 444)
- Apple CarPlay (p. 428)

## Bluetooth settings

The following settings apply to a Bluetooth-connected cell phone or other device.

### Bluetooth

1. Tap **Settings** in the center display's Top view.
2. Tap **Communication → Bluetooth Devices** and select among the following settings:
  - **Previously paired devices:** lists the devices that are paired and connected to the vehicle.
  - **Internet connection:** select to connect to the Internet using the device's Bluetooth connection.
  - **Add device:** begin the procedure to pair a new device.
  - **Remove device:** remove a paired device.
  - **Allowed services for this device:** select what the device will be used for: make calls, send/receive messages, stream media, Internet connection.

## Bluetooth compliance

### United States

#### FCC CAUTION

Changes or modifications not expressly approved by the party responsible for compliance could void the user's authority to operate the equip-

ment. This transmitter must not be co-located or operated in conjunction with any other antenna or transmitter.

### Canada

This device complies with Industry Canada licence-exempt RSS standard(s). Operation is subject to the following two conditions:

- (1) this device may not cause interference, and
- (2) this device must accept any interference, including interference that may cause undesired operation of the device.

### Related information

- Internet connected vehicle (p. 439)
- Pairing a cell phone (p. 420)
- Phone (p. 419)
- Media player (p. 427)
- Connecting/disconnecting a cell phone (p. 421)

## Downloading, updating and uninstalling apps

When the vehicle is connected to the Internet, apps can be added (downloaded), kept up-to-date or deleted.

### NOTE

Downloading data may affect other services that transfer data such as web radio, streaming music, etc. If this occurs, a download in progress can be cancelled or the other service can be temporarily turned off.



Apps are managed via the **Download Center** in the center display's App view.

To download, update or delete apps, the vehicle must be connected to the Internet.

## Downloading an app

1. Open the **Download Center** app.
2. Select **New apps** to open a list of apps that are available but which are not installed in the vehicle. Tap anywhere in a line for an app to expand the list for additional information.



- ◀ 3. Select **Install** to start downloading the app. It will remain in the list and a new download can be initiated if necessary.

- > Download status will be indicated while it is in progress.

A message will be displayed if a download cannot be started immediately. The app will remain in the list and a new download can be initiated if necessary.

### Canceling (aborting) a download

- Tap **Abort** to cancel a download that is currently underway.

Only a download can be cancelled. If the installation phase has begun, it cannot be interrupted.

### Updating apps

If an app is being used while an update is in progress, it will be restarted to complete the update.

#### Update (install) all

1. Open the **Download Center** app.
2. Select **Install all**.
  - > The update will begin.

#### Updating certain apps

1. Open the **Download Center** app.
2. Select **Application updates** to open a list of available updates.
3. Find the desired app and select **Install**.
  - > The update will begin.

### Uninstalling an app

An app being used must be closed before it can be uninstalled.

1. Open the **Download Center** app.
2. Select **Application updates** to open a list of apps that have been installed.
3. Find the desired app and select **Uninstall** to begin uninstalling the app.
  - > When the app has been uninstalled, it will be removed from the list.

### Related information

- Internet connected vehicle (p. 439)
- Media player (p. 427)
- System updates (p. 482)

### Internet connection troubleshooting

The following are factors that may affect the vehicle's Internet connection.

The amount of data being transmitted depends on the services or apps that are currently in use. For example, streaming audio requires a great deal of data to be transmitted, which requires a good connection and a strong signal.

#### Cell phone to the vehicle

Connection speed may vary depending on the location of the cell phone in the vehicle. Move the phone closer to the center display to increase signal strength. Be sure that there are no obstructing/screening objects between the phone and the screen.

#### Cell phone to the network operator

The speed of the mobile network may vary depending on coverage/reception in the vehicle's location. Reception is generally poorer in tunnels, in mountainous areas, in deep valleys or indoors. Connection speed may also depend on the type of subscription that you have with the service provider.

Contact your service provider in the event of data transmission problems.

#### Restarting the phone

If you experience problems making a connection, it may help to restart the phone.



## Related information

- Internet connected vehicle (p. 439)
- Connecting to the Internet (p. 439)

## Tethering (Wi-Fi sharing)

When the vehicle is connected to the Internet, this connection can be shared (tethered) with other devices<sup>7</sup>.

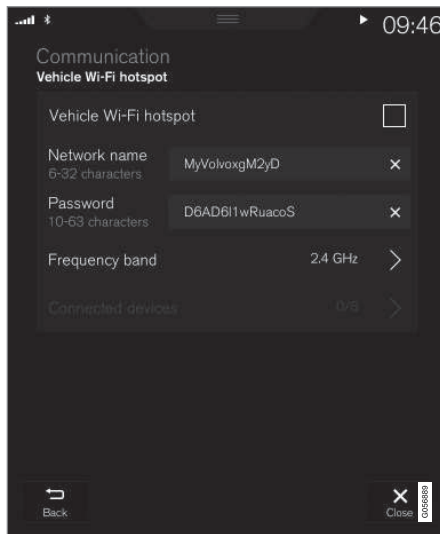

The network service provider (the SIM card) must support tethering.

1. Open the center display's Top view.

2. Tap **Settings** → **Communication** → **Vehicle Wi-Fi Hotspot**.
3. Tap **Network name** and assign a name to the hotspot.
4. Tap **Password** and create a password to be used by devices trying to connect (tether) to the hotspot.
5. Tap **Frequency band** and select a frequency that the hotspot will use to transmit data. This may not be possible in all markets.
6. Activate/deactivate by tapping the **Vehicle Wi-Fi Hotspot** box.
7. If another connection has been used previously, confirm the change of connections.
  - > It is now possible for external devices to connect to the vehicle's Wi-Fi hotspot.

Connection status will be indicated in a symbol in the center display's status bar.

Tap **Connected devices** to see a list of connected devices.

## Related information

- Internet connected vehicle (p. 439)
- Wi-Fi technology and security (p. 444)
- Symbols in the center display status bar (p. 43)
- Internet connection troubleshooting (p. 442)

<sup>7</sup> Does not apply for a Wi-Fi connection.

## Deleting Wi-Fi networks

Networks that are not used can be deleted.

1. Tap **Settings** in the center display's Top view.
2. Tap **Wi-Fi → Saved networks**.
3. Tap **Forget** to remove the network.
4. Confirm the selection.
  - > The vehicle will no longer connect to the deleted network.

## Deleting all networks

All networks can be deleted at the same time by returning (resetting) to factory settings.

If this is done, all user data and settings will be reset to their default settings.

## Related information

- Internet connected vehicle (p. 439)
- Connecting to the Internet (p. 439)

## Wi-Fi technology and security

The following are types of networks can be connect to.

It is possible to connect to the following types of networks:

- Frequency: 2.4 or 5 GHz<sup>8</sup>.
- Standards: 802.11 a/b/g/n.
- Security type: WPA2-AES-CCMP.

The vehicle's Wi-Fi system is designed to manage Wi-Fi devices in the vehicle.

If several devices are using a frequency at the same time, this may result in poorer performance.

## Related information

- Internet connected vehicle (p. 439)
- Connecting to the Internet (p. 439)
- Tethering (Wi-Fi sharing) (p. 443)
- Internet connection troubleshooting (p. 442)

## Vehicle modem settings

The vehicle is equipped with a modem that can be used to connect the vehicle to the Internet. It is also possible to share (tether) this connection via Wi-Fi.

1. Tap **Settings** in the center display's Top view.
2. Tap **Communication → Vehicle Modem Internet** and choose among the following settings:
  - **Vehicle modem Internet:** select to use the vehicle's modem to connect to the Internet.
  - **Data usage: %s:** Tap **Reset** to restart (reset) the counter for the amount of data sent/received.
  - **Network**
    - Select carrier:** select a service provider automatically or manually.
    - Data roaming:** select to allow the vehicle to connect to another network if the standard network is not available (e.g., if you are driving in another country). This could entail additional charges, consult your service provider.
  - **SIM card PIN**

<sup>8</sup> Selecting a frequency is not possible in all markets.

**Change PIN:** enter max. 4 digits.

**Disable PIN:** Allow access to the SIM card without requiring a PIN code.

- **Send request code:** this is used to download the balance remaining on a SIM card. This is specific to your service provider.

**Related information**

- Internet connected vehicle (p. 439)
- Connecting to the Internet (p. 439)

**Infotainment system license information**

The following license information pertains to Volvo's agreements with certain manufacturers/developers.

**Bowers & Wilkins**



Bowers & Wilkins and B&W are trademarks of the B&W Group Ltd. Nautilus is a trademark of B&W Group Ltd. Kevlar is a registered trademark of DuPont.

**Dirac Live**



Dirac Live technology has been used in the development and tuning of the sound in order to ensure a world-class sound experience. Dirac Live and the D-symbol are registered trademarks of Dirac Research AB.

**DivX®**



DivX®, DivX Certified® and associated logos are trademarks of DivX, LLC and are used under license.

About DIVX VIDEO: This DivX Certified® device can play DivX® Home Theater video files up to 576p (including .avi, .divx). Download free software at [www.divx.com](http://www.divx.com) to create, play and stream digital video.

About DIVX VIDEO-ON-DEMAND: This DivX Certified® device must be registered in order to play purchased DivX Video-on-Demand (VOD) movies. To obtain your registration code, locate the DivX VOD section in your device setup menu.



◀◀ Go to [vod.divx.com](http://vod.divx.com) for more information on how to complete your registration.

**Patent number**

Covered by one or more of the following U.S. patents: 7,295,673; 7,460,668; 7,515,710; 8,656,183; 8,731,369; RE45,052."

**Gracenote®**



Gracenote, Gracenote logo and logotype, "Powered by Gracenote" and Gracenote MusicID are either registered trademarks or trademarks of Gracenote, Inc in the United States and/or other countries.

**Gracenote® End User License Agreement**

This application or device contains software from Gracenote, Inc. of Emeryville, California ("Gracenote"). The software from Gracenote (the "Gracenote Software") enables this application to perform disc and/or file identification and obtain music-related information, including name, artist, track, and title information ("Gracenote Data") from online servers or embedded databases (col-

lectively, "Gracenote Servers") and to perform other functions. You may use Gracenote Data only by means of the intended End-User functions of this application or device.

You agree that you will use Gracenote Data, the Gracenote Software, and Gracenote Servers for your own personal non-commercial use only. You agree not to assign, copy, transfer or transmit the Gracenote Software or any Gracenote Data to any third party. YOU AGREE NOT TO USE OR EXPLOIT GRACENOTE DATA, THE GRACENOTE SOFTWARE, OR GRACENOTE SERVERS, EXCEPT AS EXPRESSLY PERMITTED HEREIN.

You agree that your non-exclusive license to use the Gracenote Data, the Gracenote Software, and Gracenote Servers will terminate if you violate these restrictions. If your license terminates, you agree to cease any and all use of the Gracenote Data, the Gracenote Software, and Gracenote Servers. Gracenote reserves all rights in Gracenote Data, the Gracenote Software, and the Gracenote Servers, including all ownership rights. Under no circumstances will Gracenote become liable for any payment to you for any information that you provide. You agree that Gracenote, Inc. may enforce its rights under this Agreement against you directly in its own name.

The Gracenote service uses a unique identifier to track queries for statistical purposes. The purpose of a randomly assigned numeric identifier is to allow the Gracenote service to count queries

without knowing anything about who you are. For more information, see the web page for the Gracenote Privacy Policy for the Gracenote service.

The Gracenote Software and each item of Gracenote Data are licensed to you "AS IS." Gracenote makes no representations or warranties, express or implied, regarding the accuracy of any Gracenote Data from in the Gracenote Servers. Gracenote reserves the right to delete data from the Gracenote Servers or to change data categories for any cause that Gracenote deems sufficient. No warranty is made that the Gracenote Software or Gracenote Servers are error-free or that functioning of Gracenote Software or Gracenote Servers will be uninterrupted. Gracenote is not obligated to provide you with new enhanced or additional data types or categories that Gracenote may provide in the future and is free to discontinue its services at any time.

GRACENOTE DISCLAIMS ALL WARRANTIES EXPRESS OR IMPLIED, INCLUDING, BUT NOT LIMITED TO, IMPLIED WARRANTIES OF MERCHANTABILITY, FITNESS FOR A PARTICULAR PURPOSE, TITLE, AND NON-INFRINGEMENT. GRACENOTE DOES NOT WARRANT THE RESULTS THAT WILL BE OBTAINED BY YOUR USE OF THE GRACENOTE SOFTWARE OR ANY GRACENOTE SERVER. IN NO CASE WILL GRACENOTE BE LIABLE FOR ANY CONSEQUENTIAL OR INCIDENTAL DAMAGES OR FOR ANY LOST PROFITS OR LOST REVENUES.

© Gracernote, Inc. 2009

## Sensu software

This software uses parts of sources from clib2 and Prex Embedded Real-time OS - Source (Copyright ©) 1982, 1986, 1991, 1993, 1994), and Quercus Robusta (Copyright ©) 1990, 1993), The Regents of the University of California. All or some portions are derived from material licensed to the University of California by American Telephone and Telegraph Co. or Unix System Laboratories, Inc. and are reproduced herein with the permission of UNIX System Laboratories, Inc. Redistribution and use in source and binary forms, with or without modification, are permitted provided that the following conditions are met: Redistributions of source code must retain the above copyright notice, this list of conditions and the following disclaimer. Redistributions in binary form must reproduce the above copyright notice, this list of conditions and the following disclaimer in the documentation and/or other materials provided with the distribution. Neither the name of the <ORGANIZATION> nor the names of its contributors may be used to endorse or promote products derived from this software without specific prior written permission. THIS SOFTWARE IS PROVIDED BY THE COPYRIGHT HOLDERS AND CONTRIBUTORS "AS IS" AND ANY EXPRESS OR IMPLIED WARRANTIES, INCLUDING, BUT NOT LIMITED TO, THE

IMPLIED WARRANTIES OF MERCHANTABILITY AND FITNESS FOR A PARTICULAR PURPOSE ARE DISCLAIMED. IN NO EVENT SHALL THE COPYRIGHT OWNER OR CONTRIBUTORS BE LIABLE FOR ANY DIRECT, INDIRECT, INCIDENTAL, SPECIAL, EXEMPLARY, OR CONSEQUENTIAL DAMAGES (INCLUDING, BUT NOT LIMITED TO, PROCUREMENT OF SUBSTITUTE GOODS OR SERVICES; LOSS OF USE, DATA, OR PROFITS; OR BUSINESS INTERRUPTION) HOWEVER CAUSED AND ON ANY THEORY OF LIABILITY, WHETHER IN CONTRACT, STRICT LIABILITY, OR TORT (INCLUDING NEGLIGENCE OR OTHERWISE) ARISING IN ANY WAY OUT OF THE USE OF THIS SOFTWARE, EVEN IF ADVISED OF THE POSSIBILITY OF SUCH DAMAGE.

This software is based in part on the work of the Independent JPEG Group.

This software uses parts of sources from "libtess". The Original Code is: OpenGL Sample Implementation, Version 1.2.1, released January 26, 2000, developed by Silicon Graphics, Inc. The Original Code is Copyright ©) 1991-2000 Silicon Graphics, Inc. Copyright in any portions created by third parties is as indicated elsewhere herein. All Rights Reserved. Copyright ©) [1991-2000] Silicon Graphics, Inc. All Rights Reserved. Permission is hereby granted, free of charge, to any person obtaining a copy of this software and associated documentation files (the "Software"), to deal in the Software without restriction,

including without limitation the rights to use, copy, modify, merge, publish, distribute, sublicense, and/or sell copies of the Software, and to permit persons to whom the Software is furnished to do so, subject to the following conditions: The above copyright notice including the dates of first publication and either this permission notice or a reference to <http://oss.sgi.com/projects/FreeB/> shall be included in all copies or substantial portions of the Software. THE SOFTWARE IS PROVIDED "AS IS", WITHOUT WARRANTY OF ANY KIND, EXPRESS OR IMPLIED, INCLUDING BUT NOT LIMITED TO THE WARRANTIES OF MERCHANTABILITY, FITNESS FOR A PARTICULAR PURPOSE AND NONINFRINGEMENT. IN NO EVENT SHALL SILICON GRAPHICS, INC. BE LIABLE FOR ANY CLAIM, DAMAGES OR OTHER LIABILITY, WHETHER IN AN ACTION OF CONTRACT, TORT OR OTHERWISE, ARISING FROM, OUT OF OR IN CONNECTION WITH THE SOFTWARE OR THE USE OR OTHER DEALINGS IN THE SOFTWARE. Except as contained in this notice, the name of Silicon Graphics, Inc. shall not be used in advertising or otherwise to promote the sale, use or other dealings in this Software without prior written authorization from Silicon Graphics, Inc.

This software is based in parts on the work of the FreeType Team.



◀◀ This software uses parts of SSLeay Library: Copyright ©) 1995-1998 Eric Young (eay@cryptsoft.com). All rights reserved

### Linux software

This product contains software licensed under GNU General Public License (GPL) or GNU Lesser General Public License (LGPL), etc.

You have the right of acquisition, modification, and distribution of the source code of the GPL/LGPL software.

You may download Source Code from the following website at no charge: [http://www.embedded-carmultimedia.jp/linux/oss/download/TVM\\_8351\\_013](http://www.embedded-carmultimedia.jp/linux/oss/download/TVM_8351_013)

The website provides the Source Code "As Is" and without warranty of any kind.

By downloading Source Code, you expressly assume all risk and liability associated with downloading and using the Source Code and complying with the user agreements that accompany each Source Code.

Please note that we cannot respond to any inquiries regarding the source code.

### camellia:1.2.0

Copyright ©) 2006, 2007

NTT (Nippon Telegraph and Telephone Corporation). All rights reserved.

Redistribution and use in source and binary forms, with or without modification, are permitted provided that the following conditions are met:

1. Redistributions of source code must retain the above copyright notice, this list of conditions and the following disclaimer as the first lines of this file unmodified.
2. Redistributions in binary form must reproduce the above copyright notice, this list of conditions and the following disclaimer in the documentation and/or other materials provided with the distribution.

THIS SOFTWARE IS PROVIDED BY NTT "AS IS" AND ANY EXPRESS OR IMPLIED WARRANTIES, INCLUDING, BUT NOT LIMITED TO, THE IMPLIED WARRANTIES OF MERCHANTABILITY AND FITNESS FOR A PARTICULAR PURPOSE ARE DISCLAIMED. IN NO EVENT SHALL NTT BE LIABLE FOR ANY DIRECT, INDIRECT, INCIDENTAL, SPECIAL, EXEMPLARY, OR CONSEQUENTIAL DAMAGES (INCLUDING, BUT NOT LIMITED TO, PROCUREMENT OF SUBSTITUTE GOODS OR SERVICES; LOSS OF USE, DATA, OR PROFITS; OR BUSINESS INTERRUPTION) HOWEVER CAUSED AND ON ANY THEORY OF LIABILITY, WHETHER IN CONTRACT, STRICT LIABILITY, OR TORT (INCLUDING NEGLIGENCE OR OTHERWISE) ARISING IN ANY WAY OUT OF THE USE OF THIS SOFTWARE, EVEN IF ADVISED OF THE POSSIBILITY OF SUCH DAMAGE.

### Unicode: 5.1.0

#### COPYRIGHT AND PERMISSION NOTICE

Copyright c 1991-2013 Unicode, Inc. All rights reserved. Distributed under the Terms of Use in <http://www.unicode.org/copyright.html>.

Permission is hereby granted, free of charge, to any person obtaining a copy of the Unicode data files and any associated documentation (the "Data Files") or Unicode software and any associated documentation (the "Software") to deal in the Data Files or Software without restriction, including without limitation the rights to use, copy, modify, merge, publish, distribute, and/or sell copies of the Data Files or Software, and to permit persons to whom the Data Files or Software are furnished to do so, provided that (a) the above copyright notice(s) and this permission notice appear with all copies of the Data Files or Software, (b) both the above copyright notice(s) and this permission notice appear in associated documentation, and (c) there is clear notice in each modified Data File or in the Software as well as in the documentation associated with the Data File(s) or Software that the data or software has been modified.

THE DATA FILES AND SOFTWARE ARE PROVIDED "AS IS", WITHOUT WARRANTY OF ANY KIND, EXPRESS OR IMPLIED, INCLUDING BUT NOT LIMITED TO THE WARRANTIES OF MERCHANTABILITY, FITNESS FOR A PARTICULAR PURPOSE AND

NONINFRINGEMENT OF THIRD PARTY RIGHTS. IN NO EVENT SHALL THE COPYRIGHT HOLDER OR HOLDERS INCLUDED IN THIS NOTICE BE LIABLE FOR ANY CLAIM, OR ANY SPECIAL INDIRECT OR CONSEQUENTIAL DAMAGES, OR ANY DAMAGES WHATSOEVER RESULTING FROM LOSS OF USE, DATA OR PROFITS, WHETHER IN AN ACTION OF CONTRACT, NEGLIGENCE OR OTHER TORTIOUS ACTION, ARISING OUT OF OR IN CONNECTION WITH THE USE OR PERFORMANCE OF THE DATA FILES OR SOFTWARE.

Except as contained in this notice, the name of a copyright holder shall not be used in advertising or otherwise to promote the sale, use or other dealings in these Data Files or Software without prior written authorization of the copyright holder.

### **Bluetooth® declaration of conformity United States**

#### **FCC CAUTION**

Changes or modifications not expressly approved by the party responsible for compliance could void the user's authority to operate the equipment. This transmitter must not be co-located or operated in conjunction with any other antenna or transmitter.

Canada

This device complies with Industry Canada licence-exempt RSS standard(s). Operation is

subject to the following two conditions: (1) this device may not cause interference, and (2) this device must accept any interference, including interference that may cause undesired operation of the device.

## **Terms, conditions and confidentiality**

See terms and conditions for services and customer privacy policy at [support.volvocars.com](http://support.volvocars.com).

### **Terms & Conditions for Services**

Volvo offers the best possible services to make owning and operating a Volvo safe, convenient, comfortable and enjoyable. Volvo offers a wide array of services, ranging from emergency assistance to navigation and infotainment.

### **Customer privacy policy**

This policy applies to the way in which customer-related and personal information are handled. Its purpose is to provide our present, previous and future customers a general understanding of:

- The circumstances under which we gather and process your personal information.
- The types of personal information gathered.
- The reasons for gathering your personal information.
- How we deal with your personal information.

This policy can be read in its entirety at [support.volvocars.com](http://support.volvocars.com).





WHEELS AND TIRES

### Tires

Your vehicle is equipped with tires according to the vehicle's tire information placard on the B-pillar (the structural member at the side of the vehicle, at the rear of the driver's door opening).

#### **!** CAUTION

Some Volvo models are equipped with an Ultra High Performance tire and wheel combination designed to provide maximum dry pavement performance with consideration for hydroplaning resistance. They may be more susceptible to road hazard damage and, depending on driving conditions, may achieve a tread life of less than 20,000 miles (30,000 km). Even if this vehicle is equipped with Volvo's advanced AWD or stability system, these tires are not designed for winter driving, and should be replaced with winter tires when weather conditions dictate.

The tires have good road holding characteristics and offer good handling on dry and wet surfaces. It should be noted however that the tires have been developed to give these features on snow/ice-free surfaces.

Most models are equipped with "all-season" tires, which provide a somewhat higher degree of road holding on slippery surfaces than tires without

the "all-season" rating. However, for optimum road holding on icy or snow-covered roads, we recommend suitable winter tires on all four wheels.

When replacing tires, be sure that the new tires are the same size designation, type (radial) and preferably from the same manufacturer, on all four wheels. Otherwise there is a risk of altering the car's roadholding and handling characteristics.

### Recommended tires

Your vehicle is factory-equipped with Volvo original tires that are marked VOL<sup>1</sup> on the sidewall. These tires have been carefully adapted to your vehicle. When replacing tires, it is important that the new ones also have the VOL designation in order to help maintain the vehicle's driving and handling characteristics.

### New tires

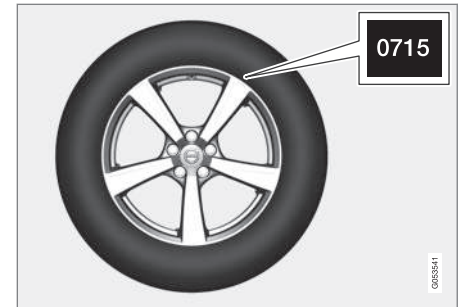

Remember that tires are perishable goods. As of 2000, the manufacturing week and year (Department of Transportation (DOT) stamp) will be indicated with 4 digits (e.g., 0715 means that the tire illustrated was manufactured during week 7 of 2015).

### Tire age

Tires degrade over time, even when they are not being used. It is recommended that tires generally be replaced after 6 years of normal service. Heat caused by hot climates, frequent high loading conditions or Ultra Violet (U.V.) exposure can accelerate the aging process. The temporary spare<sup>2</sup> should also be replaced at 6-year intervals, even if it has never been used. A tire's age can be determined by the DOT stamp on the

<sup>1</sup> There may be certain exceptions depending on the tire's dimensions.

<sup>2</sup> Not available in all models.

sidewall (see the illustration). A tire with e.g., visible cracks or discoloration should be replaced immediately.

### Tire economy

- Maintain correct tire pressure.
- Avoid fast starts, hard braking and tire screeching.
- Tire wear increases with speed.
- Correct front wheel alignment is very important.
- Unbalanced wheels impair tire economy and driving comfort.
- Tires must maintain the same direction of rotation throughout their lifetime.
- When replacing tires, the tires with the most tread should be mounted on the rear wheels to reduce the chance of oversteer during hard braking.
- Hitting curbs or potholes can damage the tires and/or wheels permanently.

### Tire rotation

Your vehicle has no required tire rotation. Tire wear is affected by a number of factors such as tire inflation, ambient temperature, driving style, etc.

#### NOTE

- If the tires are rotated, they should only be moved from front to rear or vice versa. They should never be rotated left to right/right to left.
- Ideally, tire rotation should be done the first time after approximately 3,000 miles (5,000 km) and thereafter at 6,000-mile (10,000-km) intervals. Some customers find that tire rotation may help to get extra mileage from tire life.
- Tire rotation should only be performed if front/rear tire wear is fairly even and tread height is above 1/16" (1.6 mm).

### Storing wheels and tires

When storing complete wheels (tires mounted on rims), they should be suspended off the floor or placed on their sides on the floor.

Tires not mounted on rims should be stored on their sides or standing upright, but should not be suspended.

#### CAUTION

Tires should preferably be stored in a cool, dry, dark place, and should never be stored in close proximity to solvents, gasoline, oils, etc.

#### WARNING

- The wheel and tire sizes for your Volvo are specified to meet stringent stability and handling requirements. Unapproved wheel/tire size combinations can negatively affect your vehicle's stability and handling.
- Any damage caused by installation of unapproved wheel/tire size combinations will not be covered by your new vehicle warranty. Volvo assumes no responsibility for death, injury, or expenses that may result from such installations.

### Related information

- Checking tire inflation pressure (p. 460)
- Tread wear indicator (p. 457)

### Tire sidewall designations

The following information can be found on a tire's sidewall.

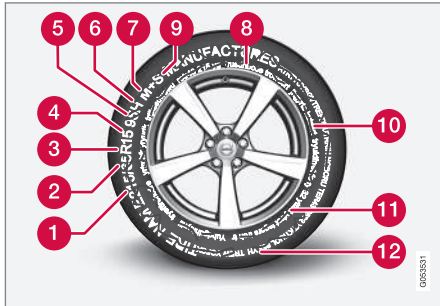

Federal law mandates that tire manufacturers place standardized information on the sidewall of all tires (see the illustration).

The vehicle has been certified with certain combinations of wheels and tires.

The following information is listed on the tire sidewall:

The tire designation:

#### **i** NOTE

Please be aware that the following tire designation is an **example only** and that this particular tire may not be available on your vehicle.

1. **215:** the width of the tire (in millimeters) from sidewall edge to sidewall edge. The larger the number, the wider the tire.
2. **65:** The ratio of the tire's height to its width in percent.
3. **R:** Radial tire (the designation **RF** and the  symbol indicate that the vehicle is equipped with optional self-supporting run flat tires<sup>3</sup>).
4. **15:** The diameter of the wheel rim (in inches).
5. **95:** The tire's load index. In this example, a load index of 95 equals a maximum load of 1521 lbs (690 kg).
6. **H:** The tire's speed rating, or the maximum speed at which the tire is designed to be driven for extended periods of time, carrying a permissible load for the vehicle, and with correct inflation pressure. For example, H indicates a speed rating of 130 mph (210 km/h).

#### **i** NOTE

The tire's load index and speed rating may not appear on the sidewall because they are not required by law.

7. **M+S or M/S** = Mud and Snow, **AT** = All Terrain, **AS** = All Season
8. **U.S. DOT Tire Identification Number (TIN):** This begins with the letters "DOT" and indicates that the tire meets all federal standards. The next two numbers or letters are the plant code where it was manufactured, the next two are the tire size code and the last four numbers represent the week and year the tire was built. For example, 1510 means that the tire was manufactured during week 15 of 2010. The numbers in between are marketing codes used at the manufacturer's discretion. This information helps a tire manufacturer identify a tire for safety recall purposes.
9. **Tire Ply Composition and Material Used:** Indicates the number of plies indicates or the number of layers of rubber-coated fabric in the tire tread and sidewall. Tire manufacturers also must indicate the ply materials in the tire and the sidewall, which include steel, nylon, polyester, and others.

<sup>3</sup> Self-supporting run flat tires may not be available on all models

10. **Maximum Load:** Indicates the maximum load in pounds and kilograms that can be carried by the tire. Refer to the vehicle's tire information placard located on the B-Pillar for the correct tire pressure for your vehicle.
11. **Treadwear, Traction, and Temperature grades.**
12. **Maximum permissible inflation pressure:** the greatest amount of air pressure that should ever be put in the tire. This limit is set by the tire manufacturer.

### Speed Symbol

A tire's Speed Symbol (SS) indicates the maximum speed for which the tire has been certified and should be at least equivalent to the vehicle's top speed.

Winter tires, with or without studs, are exceptions and may use a lower SS. When winter tires are installed, the vehicle may not be driven faster than the tires' SS.

The vehicle's speed should always be determined by the posted speed limit and traffic and road conditions, not the tire's SS.

The following table indicates the maximum permissible speed for each SS.

Speed Symbol	
M	81 mph (130 km/h)
Q	100 mph (160 km/h)
T	118 mph (190 km/h)
H	130 mph (210 km/h)
V	149 mph (240 km/h)
W	168 mph (270 km/h)
Y	186 mph (300 km/h)

### WARNING

- The wheel and tire sizes for your Volvo are specified to meet stringent stability and handling requirements. Unapproved wheel/tire size combinations can negatively affect your vehicle's stability and handling.
- Any damage caused by installation of unapproved wheel/tire size combinations will not be covered by your new vehicle warranty. Volvo assumes no responsibility for death, injury, or expenses that may result from such installations.

### Wheel (rim) designations

Wheel and rim dimensions are shown in the following table.

The vehicle has been certified with certain combinations of wheels and tires.

The following table shows an **example** of wheel dimensions: 8Jx18x42.5. This particular wheel may not be available on your vehicle.

8	Wheel width in inches
J	Rim flange profile
18	Wheel diameter in inches
42.5	Offset in mm (distance from the center of the wheel to the wheel's contact surface on the hub)

### Related information

- Tire sidewall designations (p. 454)

### Tire terminology

The following is a glossary of tire-related terms.

The tire suppliers may have additional markings, notes or warnings such as standard load, radial tubeless, etc.

- **Tire information placard:** A placard showing the OE (Original Equipment) tire sizes, recommended inflation pressure, and the maximum weight the vehicle can carry.
- **Tire Identification Number (TIN):** A number on the sidewall of each tire providing information about the tire brand and manufacturing plant, tire size and date of manufacturer.
- **Inflation pressure:** A measure of the amount of air in a tire.
- **Standard load:** A class of P-metric or Metric tires designed to carry a maximum load at 35 psi [37 psi (2.5 bar) for Metric tires]. Increasing the inflation pressure beyond this pressure will not increase the tires load carrying capability.
- **Extra load:** A class of P-metric or Metric tires designed to carry a heavier maximum load at 41 psi [43 psi (2.9 bar) for Metric tires]. Increasing the inflation pressure beyond this pressure will not increase the tire's load carrying capability.
- **kPa:** Kilopascal, a metric unit of air pressure.
- **PSI:** Pounds per square inch, a standard unit of air pressure.
- **B-pillar:** The structural member at the side of the vehicle behind the front door.
- **Bead area of the tire:** Area of the tire next to the rim.
- **Sidewall of the tire:** Area between the bead area and the tread.
- **Tread area of the tire:** Area of the perimeter of the tire that contacts the road when mounted on the vehicle.
- **Rim:** The metal support (wheel) for a tire or a tire and tube assembly upon which the tire beads are seated.
- **Maximum load rating:** a figure indicating the maximum load in pounds and kilograms that can be carried by the tire. This rating is established by the tire manufacturer.
- **Maximum permissible inflation pressure:** the greatest amount of air pressure that should ever be put in the tire. This limit is set by the tire manufacturer.
- **Recommended tire inflation pressure:** inflation pressure, established by Volvo, which is based on the type of tires that are mounted on a vehicle at the factory. This information can be found on the tire inflation placard(s) located on the driver's side B-pillar and in the tire inflation table in this chapter.
- **Cold tires:** The tires are considered to be cold when they have the same temperature as the surrounding (ambient) air. This temperature is normally reached after the vehicle has been parked for at least 3 hours.

## Tire direction of rotation

Incorrectly mounted tires impair the car's braking properties and ability to force aside rain, snow and slush.

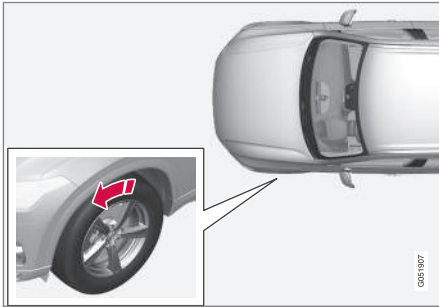

The arrows shows the direction of rotation of the tire

- The tires with the most tread should always be on the rear axle (to help reduce the risk of skidding).
- When switching between summer and winter tires, mark the tires to indicate where they were mounted on the car, e.g., LF = left front, RR = right rear
- Tires with tread designed to roll in only one direction are marked with an arrow on the sidewall.
- Contact a trained and qualified Volvo service technician if you are unsure about the tread depth.

## Related information

- Tires (p. 452)

## Tread wear indicator

The tires have wear indicator strips running across or parallel to the tread.

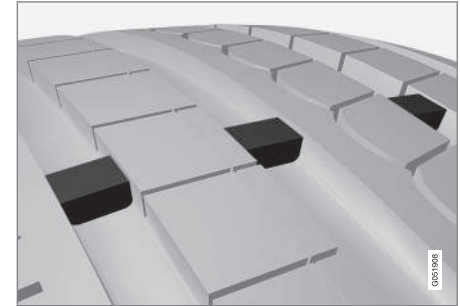

The letters TWI are printed on the side of the tire. When approximately 1/16" (1.6 mm) is left on the tread, these strips become visible and indicate that the tire should be replaced. Tires with less than 1/16" (1.6 mm) tread offer very poor traction.

When replacing worn tires, it is recommended that the tire be identical in type (radial) and size as the one being replaced. Using a tire of the same make (manufacturer) will help prevent alteration of the driving characteristics of the vehicle.

## Related information

- Tire direction of rotation (p. 457)
- Checking tire inflation pressure (p. 460)

## Loading specifications

Properly loading your vehicle will provide maximum return of vehicle design performance.

## Weight designations

Before loading your vehicle, familiarize yourself with the following terms for determining your vehicle's weight ratings, with or without a trailer, from the vehicle's Federal/Canadian Motor Vehicle Safety Standards (FMVSS/CMVSS) label, and the vehicle's tire information placard:

### Curb weight

The weight of the vehicle including a full tank of fuel and all standard equipment. It does not include passengers, cargo, or optional equipment.

### Capacity weight

All weight added to the curb weight, including cargo and optional equipment. When towing, trailer hitch tongue load is also part of cargo weight.

### Permissible axle weight

The maximum allowable weight that can be carried by a single axle (front or rear). These numbers are shown on the Federal/Canadian Motor Vehicle Safety Standards (FMVSS/CMVSS) label. The total load on each axle must never exceed its maximum permissible weight.

### Gross vehicle weight (GVW)

The vehicle's curb weight + cargo + passengers.

## Steps for Determining Correct Load Limit

1. Locate the statement "the combined weight of occupants and cargo should never exceed XXX kg or XXX lbs." on your vehicle's placard.
2. Determine the combined weight of the driver and passengers that will be riding in your vehicle.
3. Subtract the combined weight of the driver and passengers from XXX kg or XXX lbs.
4. The resulting figure equals the available amount of cargo and luggage load capacity. For example, if the "XXX" amount equals 1400 lbs. and there will be five 150 lb. passengers in your vehicle, the amount of available cargo and luggage load capacity is 650 lbs. (1400 - 750 (5 × 150) = 650 lbs.)
5. Determine the combined weight of luggage and cargo being loaded on the vehicle. That weight may not safely exceed the available cargo and luggage load capacity calculated in Step 4.
6. If your vehicle will be towing a trailer, load from your trailer will be transferred to your vehicle. Consult this manual to determine how this reduces the available cargo and luggage load capacity of your vehicle.

## WARNING

- Exceeding the permissible axle weight, gross vehicle weight, or any other weight rating limits can cause tire overheating resulting in permanent deformation or catastrophic failure.
- Do not use replacement tires with lower load carrying capacities than the tires that were original equipment on the vehicle because this will lower the vehicle's GVW rating. Use only tires with the correct load carrying capacity. Consult your Volvo retailer for information.

## Related information

- Label information (p. 532)
- Weights (p. 537)



## Uniform Tire Quality Grading

**ALL PASSENGER VEHICLE TIRES MUST CONFORM TO FEDERAL SAFETY REQUIREMENTS IN ADDITION TO THESE GRADES.**

Quality grades can be found, where applicable, on the tire sidewall between the tread shoulder and maximum section width. For example:

**Treadwear 200 Traction AA Temperature A**

### TREADWEAR

The treadwear grade is a comparative rating based on the wear rate of the tire when tested under controlled conditions on a specified government test course. For example, a tire graded 150 would wear one and one half (1 ½) times as well on the government course as a tire graded 100. The relative performance of tires depends upon the actual conditions of their use, however, and many depart significantly from the norm due to variation in driving habits, maintenance practices and differences in road characteristics and climate.

### TRACTION

The traction grades, from highest to lowest, are AA, A, B, and C, as measured under controlled conditions on specified government test surfaces of asphalt and concrete. A tire marked C may have poor traction performance. The traction grade assigned to this tire is based on braking

(straight-ahead) traction tests and is not a measure of cornering (turning) traction.

### WARNING

The traction grade assigned to this tire is based on braking (straight-ahead) traction tests and is not a measure of cornering (turning) traction.

### TEMPERATURE

The temperature grades are A (the highest), B, and C, representing the tire's resistance to the generation of heat and its ability to dissipate heat when tested under controlled conditions on a specified indoor laboratory test wheel. Sustained high temperature can cause the material of the tire to degenerate and reduce tire life, and excessive temperature can lead to sudden tire failure. The grade C corresponds to a minimum level of performance that all passenger vehicle tires must meet under the Federal Motor Safety Standard No. 109. Grades B and A represent higher levels of performance on the laboratory test wheel than the minimum required by law.

### WARNING

The temperature grade for this tire is established for a tire that is properly inflated and not overloaded. Excessive speed, under-inflation, or excessive loading, either separately or in combination, can cause heat buildup and tire failure.

## Snow tires and chains

The use of snow chains and/or winter tires can help improve traction in winter driving conditions.

Snow chains can be used on your Volvo with the following restrictions:

- Snow chains should be installed on front wheels only. Use only Volvo approved snow chains.
- If accessory, aftermarket or "custom" tires and wheels are installed and are of a size different than the original tires and wheels, chains in some cases CANNOT be used. Sufficient clearances between chains and brakes, suspension and body components must be maintained.
- Some strap-on type chains will interfere with brake components and therefore CANNOT be used.
- **All Wheel Drive models:** Snow chains should only be installed on the front wheels.
- Certain size tires may not allow the assembly of snow chains/traction devices.

Consult your Volvo retailer for additional snow chain information.



**CAUTION**

- Snow chains should not be used on wheels larger than 19".
- Always follow the chain manufacturer's installation instructions carefully. Install chains as tightly as possible and retighten periodically.
- Check local regulations regarding the use of snow chains before installing.
- Use single-sided snow chains only.
- Never exceed the chain manufacturer's specified maximum speed limit. (Under no circumstances should you exceed 31 mph (50 km/h).
- Avoid bumps, holes or sharp turns when driving with snow chains.
- The handling of the vehicle can be adversely affected when driving with chains. Avoid fast or sharp turns as well as locked wheel braking.

**Checking tire inflation pressure**

Correct tire inflation pressure helps improve driving stability, save fuel and increase the service life of the tires.

**WARNING**

- Under-inflation is the most common cause of tire failure and may result in severe tire cracking, tread separation, or "blow-out," with unexpected loss of vehicle control and increased risk of injury.
- Under-inflated tires reduce the load carrying capacity of your vehicle.

**Cold tires**

Inflation pressure should be checked when the tires are cold.

**The tires are considered to be cold when they have the same temperature as the surrounding (ambient) air.**

This temperature is normally reached after the vehicle has been parked for at least 3 hours.

After driving a distance of approximately 1 mile (1.6 km), the tires are considered to be hot. If you have to drive farther than this distance to pump your tire(s), check and record the tire pressure first and add the appropriate air pressure when you get to the pump.

When weather temperature changes occur, tire inflation pressures also change. A 10-degree

temperature drop causes a corresponding drop of 1 psi (7 kPa) in inflation pressure. Check your tire pressures frequently and adjust them to the proper pressure, which can be found on the vehicle's tire information placard or certification label.

If checking tire pressure when the tire is hot, never "bleed" or reduce air pressure. The tires are hot from driving and it is normal for pressures to increase above recommended cold pressures. A hot tire at or below recommended cold inflation pressure could be significantly under-inflated.

**Recommended inflation pressures**



Tire inflation placard

A tire inflation pressure placard is located on the driver's side B-pillar (the structural member at the side of the vehicle, at the rear of the driver's door opening). This placard indicates the designation

of the factory-mounted tires on your vehicle, as well as load limits and inflation pressure.

### **i NOTE**

- The placard shown indicates inflation pressure for the tires installed on the vehicle at the factory only.
- A certain amount of air seepage from the tires occurs naturally and tire pressure fluctuates with seasonal changes in temperature. Always check tire pressure regularly.

- Use a tire gauge to check the tire inflation pressure, including the spare<sup>4</sup>, at least once a month and before long trips. You are strongly urged to buy a reliable tire pressure gauge, as automatic service station gauges may be inaccurate.
- Use the recommended cold inflation pressure for optimum tire performance and wear.
- Under-inflation or over-inflation may cause uneven treadwear patterns.

### **Checking tire pressure**

1. Remove the cap from the valve on one tire, then firmly press the tire gauge onto the valve.

2. Add air to reach the recommended air pressure.
3. Replace the valve cap.

### **i CAUTION**

- After inflating the tires, always reinstall the valve cap to help avoid damage to the valve from dirt, gravel, etc.
- Use plastic valve caps only. Metal caps could corrode and become difficult to remove.

4. Visually inspect the tires to make sure there are no nails or other objects embedded that could puncture the tire and cause an air leak.
5. Check the sidewalls to make sure there are no gouges, cuts, bulges or other irregularities.
6. Repeat this procedure for each tire, including the spare.

### **i NOTE**

- If you overfill the tire, release air by pushing on the metal stem in the center of the valve. Then recheck the pressure with your tire gauge.
- Some spare tires require higher inflation pressure than the other tires. Consult the tire inflation pressure table or the inflation pressure placard.

<sup>4</sup> Not available in all models.

## Changing tires

When changing wheels to another dimension, always follow Volvo's instructions.

### When changing to tires of another dimension

If you mount tires with a dimension other than the factory-installed tires, contact an authorized Volvo retailer to update the vehicle's software. This may also be necessary when changing from summer to winter tires, or vice versa.

### Related information

- Snow tires and chains (p. 459)
- Spare tire (p. 463)
- Installing a wheel (p. 466)
- Removing a wheel (p. 465)

## Tools

Tools for e.g., changing wheels, etc., are located under the cargo compartment floor.



The foam block under the cargo compartment floor contains the towing eyelet, the tool for removing plastic wheel bolt covers, the jack\* and the lug wrench\*. There is also a storage space for the tool used to remove locking wheel bolts.

### Related information

- Jack (p. 462)
- Changing tires (p. 462)

## Jack

The jack is used to raise the vehicle, for example when mounting winter wheels, etc.

### **⚠ WARNING**

- The jack must correctly engage the jack attachment.
- Be sure the jack is on a firm, level, non-slippery surface.
- Never allow any part of your body to be extended under a vehicle supported by a jack.
- Use the jack intended for the vehicle when changing a tire. For any other job, use stands to support the vehicle.
- Apply the parking brake and put the gear selector in the Park (P) position.
- Block the wheels standing on the ground, use rigid wooden blocks or large stones.
- The jack should be kept well-greased and clean, and should not be damaged.
- No objects should be placed between the base of jack and the ground, or between the jack and the attachment bar on the vehicle.

**! CAUTION**

- When not in use, the jack\* should be kept in its storage compartment under the cargo compartment floor.
- The jack provided with your vehicle is intended to be used only in temporary situations such as changing wheels in the event of a flat tire. Only the jack that came with your particular model should be used to lift the vehicle. If the vehicle needs to be lifted more frequently or for a prolonged period, using a garage jack or hoist is recommended. Always follow this device's instructions for use.

**Models with leveling control\***

If the vehicle is equipped with the optional pneumatic suspension, this feature must be turned off before raising the vehicle with the jack.

To do so, go to **Settings → Vehicle → Disable Leveling Control** in the center display's Top view.

**Spare tire<sup>5</sup>**

The spare tire in your vehicle is called a "Temporary Spare".

**i NOTE**

- **The vehicle should never be driven faster than 50 mph (80 km/h) when the spare tire is being used.**
- The spare tire is only intended for temporary use. Replace it with a normal wheel as soon as possible.
- The vehicle's handling may be altered by the use of the spare tire and ground clearance will be reduced. Do not wash the vehicle in an automatic car wash if the Temporary Spare is being used.
- Recommended tire pressure (see the placard on the B-pillar) should be maintained irrespective of which position on the vehicle the temporary spare tire is used on.
- In the event of damage to this tire, a new one can be purchased from your Volvo retailer.

**! WARNING**

Current legislation prohibits the use of the "Temporary Spare" tire other than as a temporary replacement for a punctured tire. It must be replaced as soon as possible by a standard tire. Road holding and handling may be affected with the "Temporary Spare" in use. Do not exceed 50 mph (80 km/h).

**! CAUTION**

The vehicle must not be driven with wheels of different dimensions or with a spare tire other than the one that came with the vehicle. The use of different size wheels can seriously damage your car's transmission.

**! CAUTION**

The vehicle must never be driven with more than one temporary spare wheel.

The spare tire is located under the floor of the cargo compartment. A retaining bolt holds the spare tire and foam block containing tools in place.

<sup>5</sup> Not available on all models.

### ◀ Accessing the spare tire

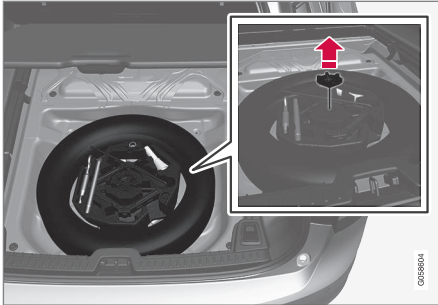

1. Lift the rear edge of the cargo compartment floor.
2. Unscrew the retaining bolt.
3. Lift out the foam block holding the tools.
4. Lift out the spare tire.

### Stowing a flat tire

1. Take out the package containing a wheel bag from the foam block and put the wheel in the bag.
2. Return the tools to the foam block and put the foam block bag in the vehicle.
3. Tighten the foam block's retaining bolt and lower the cargo area floor.
4. Place the bag containing the wheel in the cargo compartment.

### Related information

- Changing tires (p. 462)
- Removing a wheel (p. 465)
- Wheel bolts (p. 464)
- Checking tire inflation pressure (p. 460)

### Wheel bolts

The wheel bolts hold the wheel in place.

#### **!** CAUTION

Wheel bolts should be tightened to 103 ft. lbs. (140 Nm). Over-tightening could damage the threads.

Only use wheels/rims that have been tested and approved by Volvo and are included in Volvo's product range.

Use a torque wrench to check that the wheel bolts are tightened correctly.

**Never** lubricate the wheel bolts' threads.

### Locking wheel bolts\*

A tool for removing locking wheel bolts can be found in the foam block under the cargo compartment floor.

### Related information

- Changing tires (p. 462)
- Installing a wheel (p. 466)

## Removing a wheel

Wheel changes should always be carried out correctly.

1. Turn on the hazard warning flashers if the wheel change has to be done near passing traffic.
2. Apply the parking brake and put the gear selector in **P**.

### ! CAUTION

#### Models with suspension and level control\*:

Turn this function off before raising the vehicle.

To do so, go to **Settings → Vehicle → Disable Leveling Control** in the center display's Top view.

### ! WARNING

- The jack must correctly engage the jack attachment.
- Be sure the jack is on a firm, level, non-slippery surface.
- Never allow any part of your body to be extended under a vehicle supported by a jack.
- Use the jack intended for the vehicle when changing a tire. For any other job, use stands to support the vehicle.
- Apply the parking brake and put the gear selector in the Park (**P**) position.
- Block the wheels standing on the ground, use rigid wooden blocks or large stones.
- The jack should be kept well-greased and clean, and should not be damaged.
- No objects should be placed between the base of jack and the ground, or between the jack and the attachment bar on the vehicle.

### i NOTE

The jack provided with your vehicle is intended to be used only in temporary situations such as changing wheels in the event of a flat tire. Only the jack that came with your particular model should be used to lift the vehicle. If the vehicle needs to be lifted more frequently or for a prolonged period, using a garage jack or hoist is recommended. Always follow this device's instructions for use.

3. Take out the jack\*, lug wrench\*, the tool for removing the plastic covers on the wheel bolts and the towing eyelet stowed under the floor of the cargo compartment.



Tool for removing the plastic covers on the wheel bolts

Remove the plastic covers on the wheel bolts.

4. Block the wheels that are on the ground with wooden blocks or large stones.



5.

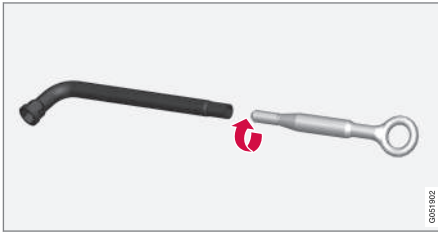

Lug wrench and towing eyelet

Screw the towing eyelet into the lug wrench as shown in the illustration.

**CAUTION**

The towing eyelet must be screwed into the lug wrench as far as possible.

6. With the vehicle still on the ground, use the lug wrench/towing eyelet to loosen the wheel bolts  $\frac{1}{2}$  – 1 turn by exerting downward (counterclockwise) pressure.

7. When hoisting the vehicle, it is essential that the jack (or garage lift arms) are positioned correctly on the underside of the vehicle. There are two jack attachment points on each side of the vehicle and there is a groove in the plastic cover at each attachment point. Position the jack under the attachment point to be used on a level, firm, non-slippery surface and crank it up until it is correctly aligned and seated in the attachment point. The pin on the jack's head must be positioned in the hole in the attachment point.



8. Raise the vehicle until the wheel to be changed is lifted off the ground. Remove the wheel bolts.

**Related information**

- Wheel bolts (p. 464)
- Installing a wheel (p. 466)
- Jack (p. 462)

**Installing a wheel**

It is important to install wheels properly.

1. Clean the contact surfaces on the wheel and hub.
2. Lift the wheel and place it on the hub.



3. Install the wheel bolts and tighten hand-tight. Using the lug wrench, tighten crosswise until all bolts are snug.
4. Lower the vehicle to the ground and alternately tighten the bolts crosswise to 103 ft. lbs. (140 Nm).
5. Press the plastic covers onto the wheel bolts.



**CAUTION**

- After inflating the tires, always reinstall the valve cap to help avoid damage to the valve from dirt, gravel, etc.
- Use plastic valve caps only. Metal caps could corrode and become difficult to remove.

**Related information**

- Wheel bolts (p. 464)
- Jack (p. 462)

**Tire Pressure Monitoring System (TPMS)**

TPMS provides a warning if inflation pressure in one or more tires is too low. It also uses a symbol (called a telltale) that will flash for 60 seconds and then glow steadily if there is a system malfunction.

TPMS uses the rotational speed of the tires in combination with signal analysis of the ABS sensor signals to determine if they are properly inflated. When a tire is under-inflated, its diameter (and consequently also its rotational speed) changes. By comparing the individual tires with each other it is possible to determine if one or more tires are under inflated. If inflation pressure is too low, an indicator symbol will illuminate in the instrument panel and a text message will be displayed.

Symbol	Explanation
	<p>The symbol illuminates to indicate low tire inflation pressure.</p> <p>If a malfunction occurs in the system, the tire pressure warning symbol will flash for approximately 1 minute and then remain illuminated.</p>

Each tire, including the spare (if provided), should be checked monthly when cold and inflated to

the inflation pressure recommended by the vehicle manufacturer on the vehicle placard or tire inflation pressure label. (If your vehicle has tires of a different size than the size indicated on the vehicle placard or tire inflation pressure label, you should determine the proper tire inflation pressure for those tires.)

As an added safety feature, your vehicle has been equipped with a tire pressure monitoring system (TPMS) that illuminates a low tire pressure telltale when one or more of your tires is significantly under-inflated. Accordingly, when the low tire pressure telltale illuminates, you should stop and check your tires as soon as possible, and inflate them to the proper pressure.

Driving on a significantly under-inflated tire causes the tire to overheat and can lead to tire failure. Under-inflation also reduces fuel efficiency and tire tread life, and may affect the vehicle's handling and stopping ability. Please note that the TPMS is not a substitute for proper tire maintenance, and it is the driver's responsibility to maintain correct tire pressure, even if under-inflation has not reached the level to trigger illumination of the TPMS low tire pressure telltale.

Your vehicle has also been equipped with a TPMS malfunction indicator to indicate when the system is not operating properly. The TPMS malfunction indicator is combined with the low tire pressure telltale.



## WHEELS AND TIRES

- ◀◀ When the system detects a malfunction, the telltale will flash for approximately one minute and then remain continuously illuminated. This sequence will continue upon subsequent vehicle start-ups as long as the malfunction exists. When the malfunction indicator is illuminated, the system may not be able to detect or signal low tire pressure as intended.

TPMS malfunctions may occur for a variety of reasons, including the installation of replacement or alternate tires or wheels on the vehicle that prevent the TPMS from functioning properly. Always check the TPMS malfunction telltale after replacing one or more tires or wheels on your vehicle to ensure that the replacement or alternate tires and wheels allow the TPMS to continue to function properly.

### Messages in the instrument panel

When the TPMS symbol illuminates, the following text messages may also be displayed:

- **Tire pressure low**
- **Tire pressure system Temporarily unavailable**
- **Tire pressure system Service required**

If TPMS cannot determine which tire(s) have low inflation pressure:

- All four tires will be shown as affected in the center display

After changing wheels, always calibrate the system to avoid false warnings.

TPMS does not replace the need for regular tire inspection and maintenance.

### NOTE

If you change to tires with a different dimension than the factory-installed ones, the TPMS system must be calibrated for these tires.

TPMS cannot be turned off.

### WARNING

Incorrect inflation pressure could lead to tire failure, resulting in a loss of control of the vehicle.

### Related information

- Checking tire inflation pressure (p. 468)
- Reinflating tires equipped with the Tire Pressure Monitoring System (TPMS) (p. 469)
- Ignition modes (p. 380)

## Checking tire inflation pressure

The Tire Pressure Monitoring System (TPMS) makes it possible to view the current inflation pressure status of all four tires.

### Checking inflation pressure

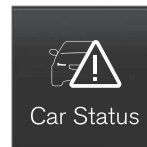

Open the **Car status** app in the center display's Application view. Tap **Status** to see the current inflation pressure status of all four tires.

The on-screen graphic displays the inflation pressure status.

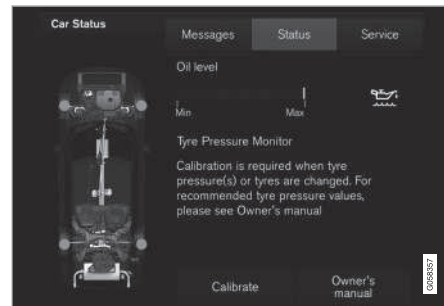

Status view. The illustration is generic and may vary from model to model or after a software update

### Color indications:

**Green:** tire pressure is above the threshold for a low inflation pressure warning.

**Yellow:** low tire pressure.

- One yellow wheel: the tire indicated is under-inflated.
- All wheels yellow: two or more tires are under-inflated.

Stop safely and check/reinflate the tire(s) as soon as possible. Calibrate TPMS after reinflating the tire(s).

**All wheels gray:**

- Calibration is underway
- Inflation pressure status is not known

It might be necessary to drive at a speed of at least 20 mph (30 km/h) for several minutes for the system to become operational.

**All wheels gray combined with the message Tire pressure system Temporarily unavailable and the TPMS symbol in the instrument panel (  ) remains illuminated after flashing for 1 minute:** the system is temporarily unavailable. It should become operational again shortly.

**All wheels gray combined with the message Tire pressure system Service required and the TPMS symbol in the instrument panel (  ) remains illuminated after flashing for 1 minute:** the system is not functioning correctly. Have it checked by a trained and qualified Volvo service technician.

**Related information**

- Calibrating the Tire Pressure Monitoring System (TPMS) (p. 470)
- Reinflating tires equipped with the Tire Pressure Monitoring System (TPMS) (p. 469)
- Tire Pressure Monitoring System (TPMS) (p. 467)

## Reinflating tires equipped with the Tire Pressure Monitoring System (TPMS)

When low tire pressure has been detected, a message will be displayed in the instrument panel and the Tire Pressure Monitoring System symbol will illuminate.

Symbol	Explanation
	When the TPMS symbol illuminates and a message is displayed, check, inflate the tire(s) and calibrate TPMS.

1. Use a tire pressure gauge to check the inflation pressure of all four tires.
2. Re-inflate the tire(s) to the correct pressure. Consult the tire pressure decal located on the driver's side B-pillar (the structural member at the side of the vehicle, at the rear of the driver's door opening) or the inflation pressure table in your printed owner's manual supplement.
3. Calibrate the Tire Pressure Monitoring System, see the article "Calibrating the Tire Pressure Monitoring System".

4. In some cases, it may be necessary to drive the vehicle for several minutes at a speed of at least 20 mph (30 km/h) to erase the TPMS telltale warning and the text message. Please be aware that the TPMS telltale warning will not go out until the low tire pressure has been corrected and calibration has been carried out.

### **i** NOTE

To help avoid incorrect tire inflation pressure, if possible only inflate the tires when they are cold. The tires are considered to be cold when they have the same temperature as the surrounding (ambient) air. This temperature is normally reached after the vehicle has been parked for at least 3 hours. After driving a distance of approximately 1 mile (1.6 km), the tires are considered to be warm.

### **!** CAUTION

When inflating tires, press the pump's mouthpiece straight onto the valve to help avoid bending or otherwise damaging the valve.

### **!** CAUTION

- After inflating the tires, always reinstall the valve cap to help avoid damage to the valve from dirt, gravel, etc.
- Use plastic valve caps only. Metal caps could corrode and become difficult to remove.

### **!** WARNING

- Incorrect inflation pressure could lead to tire failure, resulting in a loss of control of the vehicle.
- Tire monitoring systems cannot indicate sudden tire damage caused by external factors (e.g., a blowout) in advance.

### Related information

- Tire Pressure Monitoring System (TPMS) (p. 467)
- Checking tire inflation pressure (p. 468)
- Calibrating the Tire Pressure Monitoring System (TPMS) (p. 470)

## Calibrating the Tire Pressure Monitoring System (TPMS)

In order for the Tire Pressure Monitoring System to work properly, tire pressure reference values must be set correctly. This must be done each time wheels are changed or tire pressures are modified.

### Calibrating TPMS

To calibrate the system:

1. Switch off the engine.
2. Re-inflate the tire(s) to the correct pressure. Consult the tire pressure decal located on the driver's side B-pillar (the structural member at the side of the vehicle, at the rear of the driver's door opening) or the inflation pressure table in your printed owner's manual supplement.
3. Start the engine.
4. Open the **Car status** app in the center display's App view.



5. Tap **Status** to access Tire Pressure Monitoring System.

6. Tap the calibration button.
7. Tap **OK** after the tire pressure in all four tires has been checked and adjusted.
8. Drive the vehicle.
  - > The calibration process will be completed while driving and will be interrupted if the vehicle is parked and the engine is switched off. Calibration continues automatically when driving resumes.

When enough data has been collected to detect a low tire pressure situation, the tires' color in the center display will change to green. The system will not give any text confirmation when calibration is finished although it will state if calibration fails. When driving with heavy loads or at sustained highway speeds, the tire pressure should be adjusted to the recommended inflation pressures.

After adjusting inflation pressure, repeat steps 1-8.

### **NOTE**

Always remember to calibrate the Tire Pressure Monitoring System when the wheels have been changed or the tire inflation pressure has been corrected according to the tire pressure decal or tire inflation pressure table.

If correct reference values have not been set, the system cannot issue low tire pressure alerts correctly.

The vehicle must be parked with the engine running to access the calibration button and to start the calibration process.

### **WARNING**

The exhaust gases contain carbon monoxide, which is invisible and odorless but very poisonous. For this reason, always perform the calibration procedure outdoors or in a workshop with exhaust gas evacuation equipment.

### Related information

- Tire Pressure Monitoring System (TPMS) (p. 467)

## Tire sealing system<sup>6</sup>

Certain models are equipped with a tire sealing system that enables you to temporarily seal a hole in the tread surface and re-inflate a flat tire, or to adjust a tire's inflation pressure.

Models equipped with a spare tire do not have the tire sealing system.

### Location

The tire sealing system is located under the floor of the cargo compartment.

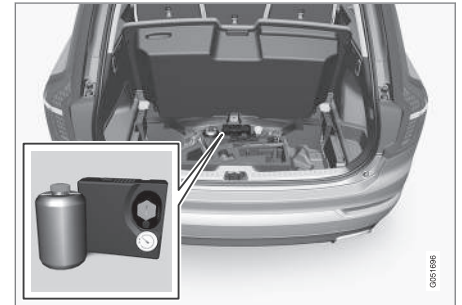

Location of the tire sealing system

### Introduction

The tire sealing system consists of an air compressor, a container for the sealing compound, wiring to connect the system to the vehicle's electrical system via one of the 12-volt sockets,

<sup>6</sup> Certain models only.

## WHEELS AND TIRES

- ◀ and a hose used to connect the system to the tire's inflation valve.

### **i** NOTE

The tire sealing system's compressor has been tested and approved by Volvo.

The 12-volt sockets are located in the front tunnel console, on the rear side of the center console in the rear seat and in the cargo area\*.

### Accessing the tire sealing system

The tire sealing system is stowed under the floor of the cargo area. To access it:

1. Lift the floor hatch in the cargo area.
2. Lift out the tire sealing system.

### **i** NOTE

- The tire sealing system is only intended to seal holes on the tire's tread area, not the sidewall.
- Tires with large holes or tears cannot be repaired with the tire sealing system.
- After use, stow the tire sealing system properly to help prevent rattling.

### **⚠** WARNING

- After using the tire sealing system, the vehicle should not be driven farther than approximately 120 miles (200 km).
- Have the tire inspected by a trained and qualified Volvo service technician as soon as possible to determine if it can be permanently repaired or must be replaced.
- The vehicle should not be driven faster than 50 mph (80 km/h) while using a tire that has been temporarily repaired with the tire sealing system.
- After using the tire sealing system, drive carefully and avoid abrupt steering maneuvers and sudden stops.

### Sealing compound container

The sealing compound container must be replaced if the tire sealing system has been used to repair a tire or if the container's expiration date has passed (see the date on decal).

### **i** NOTE

- After use, the sealing compound bottle, the hose, and certain other system components must be replaced. Please consult your Volvo retailer for replacement parts.
- If the sealing compound bottle's expiration date has passed, please take it to a Volvo retailer or a recycling station that can properly dispose of harmful substances.

**⚠ WARNING**

Please keep the following points in mind when using the tire sealing system:

- The sealing compound bottle (no. 8 in the illustration) contains 1) rubber latex, natural and 2) ethanediol. These substances are harmful if swallowed.
- The contents of this bottle may cause allergic skin reactions or otherwise be potentially harmful to the respiratory tract, the skin, the central nervous system, and the eyes.

**Precautions:**

- Keep out of reach of children.
- Do not ingest the contents.
- Avoid prolonged or repeated contact with the skin.
- Wash thoroughly after handling.

**First aid:**

- Skin: Wash affected areas of skin with soap and water. Get medical attention if symptoms occur.
- Eyes: Flush with plenty of water for least 15 minutes, occasionally lifting the upper and lower eyelids. Get medical attention if symptoms occur.
- Inhalation: Move the exposed person to fresh air. If irritation persists, get medical attention.

- Ingestion: Do **NOT** induce vomiting unless directed to do so by medical personnel. Get medical attention.
- Disposal: Dispose of this material and its container to a hazardous or special waste collection point.

**Related information**

- Inflating a tire with the tire sealing system compressor (p. 477)
- Using the tire sealing system (p. 473)

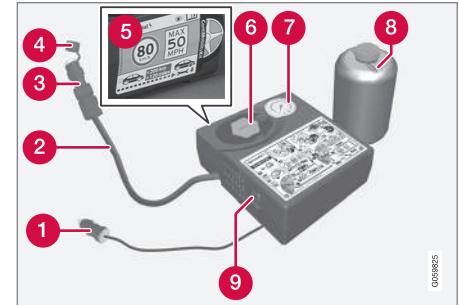
**Using the tire sealing system****Overview**

- 1 Electrical wire
- 2 Hose
- 3 Air release valve
- 4 Protective hose cover
- 5 Speed limit sticker (on the rear side of the compressor)
- 6 Bottle holder (orange cover)
- 7 Air pressure gauge
- 8 Bottle with sealing compound
- 9 On/Off switch



◀ Connecting

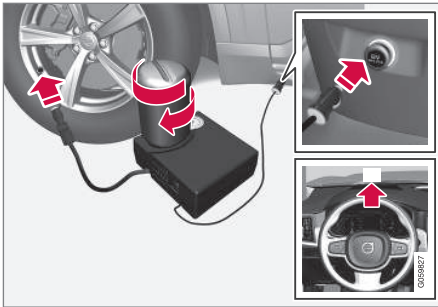

1. Activate the vehicle's hazard warning flashers if the tire sealing system is to be used in an area with traffic.  
If the flat tire was caused by a nail, etc., do not remove it from the tire. It will help to seal the hole.
2. Peel off the speed limit sticker and affix it to the windshield so that it is clearly visible to the driver. The vehicle should not be driven faster than 50 mph (80 km/h) while using a tire that has been temporarily repaired with the tire sealing system.
3. Ensure that the on/off switch is in position **0** and take out the electrical wire and hose.

**i NOTE**  
Do not break the seal on the bottle. This occurs automatically when the bottle is screwed into the holder.

**⚠ WARNING**  
Contact with the sealing compound may cause skin irritation. If contact occurs, wash the affected area immediately with soap and water.

4. Unscrew the orange cover over the bottle holder on the compressor and unscrew the cap on the bottle of sealing compound.
5. Screw the bottle into the bottle holder as far as possible.

**⚠ WARNING**  
The bottle is equipped with a catch to keep it securely in place and help prevent sealing compound leakage. Once in place, the bottle cannot be unscrewed. This must be done by a trained and qualified Volvo service technician.

6. Be sure the air release valve on the compressor's hose is completely closed. Remove the valve cap from the tire's inflation valve and screw the tire sealing system's hose connector onto the valve as tightly as possible by hand.
7. Connect the electrical wire to the nearest 12-volt socket in the vehicle.

**i NOTE**  
Be sure that none of the other 12-volt sockets is being used while the compressor is in operation.



- Start the tire sealing system's compressor by pressing the on/off switch to position I.

**⚠ WARNING**

- Never stand next to the tire being inflated when the compressor is in operation.
- If cracks, bubbles, etc. form on the tire, switch off the compressor immediately.
- If there is visible damage to the sidewall or the rim, the tire cannot be repaired. The vehicle should not be driven if this occurs. Contact a towing service or Volvo On Call Roadside Assistance if applicable.

**i NOTE**

The air pressure gauge will temporarily show an increase in pressure to approximately 88 psi (6 bar) while the sealing compound is being pumped into the tire. The pressure should return to a normal level after approximately 30 seconds.

- Pump the tire for 7 minutes.

**⚠ CAUTION**

The compressor should not be used for more than 10 minutes at a time to avoid overheating.

- Switch off the compressor and check the inflation pressure on the air pressure gauge. Inflation pressure should be between 22—51 psi (1.8—3.5 bar). Use the air release valve to release some air from the tire if necessary.

**⚠ WARNING**

If the pressure remains below 22 psi (1.8 bar) after approximately seven minutes, turn off the compressor. In this case, the hole is too large to be sealed and the vehicle should not be driven.

- Switch off the compressor and disconnect the electrical wire from the 12-volt socket.
- Unscrew the hose from the tire's inflation valve and put the cover on the hose back into place to help prevent seepage of residual sealing compound from the hose.
- Reinstall the valve cap.

**⚠ CAUTION**

- After inflating the tires, always reinstall the valve cap to help avoid damage to the valve from dirt, gravel, etc.
- Use plastic valve caps only. Metal caps could corrode and become difficult to remove.

- Immediately drive the vehicle for approximately 2 miles (3 km) at a maximum speed of 50 mph (80 km/h) to distribute the sealing compound in the tire. During the tire's first revolution, some sealing compound may spray out of the puncture hole.

**⚠ WARNING**

No one should stand closer to the vehicle than approx. 7 ft (2 m) when it drives away to help avoid being sprayed with sealing compound.

**⚠ CAUTION**

If your vehicle is equipped with the Tire Pressure Monitoring System (TPMS), the use of the sealing compound may lead to incorrect tire pressure readings or in rare cases, damage to the tire pressure sensor. Use the tire sealing system to check and adjust the damaged tire's inflation pressure.

**i NOTE**

- Safely stow the tire sealing system in a convenient place as it will soon be used again to check the tire's inflation pressure.
- The empty bottle of sealing compound cannot be removed from the bottle holder. Consult a trained and qualified Volvo serv-





ice technician to have the bottle removed and properly disposed of.

**⚠ WARNING**

If heavy vibrations, unsteady steering behavior, or noises should occur while driving, reduce speed and park the vehicle in a safe place. Recheck the tire for bumps, cracks, or other visible damage, and recheck its inflation pressure. If the pressure is below 19 psi (1.3 bar), do not continue driving. Have the vehicle towed to a trained and qualified Volvo service technician.

**15. Rechecking the pressure**

Reconnect the tire sealing system's hose to the tire's inflation valve.

16. Without starting the compressor, check the inflation pressure on the air pressure gauge.

- If the pressure is under 19 psi (1.3 bar), the puncture has not been sealed sufficiently and the vehicle should not be driven. Have the vehicle towed to a trained and qualified Volvo service technician.
- If the pressure is more than 19 psi (1.3 bar), connect the electrical wire to a 12-volt socket, start the compressor and inflate the tire to the correct pressure (see the tire pressure decal on the on the driver's side B-pillar (the structural member at the side of the vehicle, at the rear of the driver's door opening). Use the air release valve to release some air from the tire if necessary.

17. Switch off the compressor and disconnect the electrical wire from the 12-volt socket. Unscrew the hose from the tire's inflation valve and reinstall the valve cap.

Do not attempt to remove the sealing compound bottle from the tire sealing system. It cannot be turned counterclockwise.

18. Fold the hose into the sealing system box and return the components to the cargo compartment.

**⚠ CAUTION**

- After inflating the tires, always reinstall the valve cap to help avoid damage to the valve from dirt, gravel, etc.
- Use plastic valve caps only. Metal caps could corrode and become difficult to remove.

**i NOTE**

- After use, the sealing compound bottle, the hose, and certain other system components must be replaced. Please consult your Volvo retailer for replacement parts.
- If the sealing compound bottle's expiration date has passed, please take it to a Volvo retailer or a recycling station that can properly dispose of harmful substances.

**⚠ WARNING**

Always check tire inflation pressure regularly.

Volvo recommends driving to an authorized Volvo workshop to have the damaged tire repaired/replaced. Inform the workshop that the tire contains sealing compound.

**⚠ WARNING**

- After using the tire sealing system, the vehicle should not be driven farther than approximately 120 miles (200 km).
- Have the tire inspected by a trained and qualified Volvo service technician as soon as possible to determine if it can be permanently repaired or must be replaced.
- The vehicle should not be driven faster than 50 mph (80 km/h) while using a tire that has been temporarily repaired with the tire sealing system.
- After using the tire sealing system, drive carefully and avoid abrupt steering maneuvers and sudden stops.

**Related information**

- Tire sealing system (p. 471)
- Checking tire inflation pressure (p. 460)

**Inflating a tire with the tire sealing system compressor**

The compressor can be used to inflate a tire.

1. The compressor should be switched off. Ensure that the on/off switch is in position **0**. Take out the electrical wire and hose.
2. Be sure the air release valve on the compressor's hose is completely closed. Remove the valve cap from the tire's inflation valve and screw the hose connector onto the valve as tightly as possible by hand.
3. Connect the electrical wire to the nearest 12-volt socket in the vehicle and start the engine.

**⚠ WARNING**

- The vehicle's engine should be running when the tire sealing system is used to avoid battery drain. Therefore, be sure the vehicle is parked in a well ventilated place, or outdoors, before using the system. The parking brake should be securely applied and the gear selector should be in the **P** (park) position.
  - Children should never be left unattended in the vehicle when the engine is running.
4. Start the compressor by pressing the on/off switch to position **I**.

**⚠ CAUTION**

The compressor should not be used for more than 10 minutes at a time to avoid overheating.

5. Inflate the tire to the correct pressure (see the tire pressure decal on the on the driver's side B-pillar (the structural member at the side of the vehicle, at the rear of the driver's door opening). Use the air release valve to release some air from the tire if necessary.



## WHEELS AND TIRES

- ◀ 6. Turn off the compressor (press the on/off switch to position **O**) when the correct inflation pressure has been reached.

### **CAUTION**

- After inflating the tires, always reinstall the valve cap to help avoid damage to the valve from dirt, gravel, etc.
- Use plastic valve caps only. Metal caps could corrode and become difficult to remove.

7. Disconnect the electrical wire from the 12-volt socket.

### **Related information**

- Checking tire inflation pressure (p. 460)
- Tire sealing system (p. 471)

MAINTENANCE AND SERVICING

## Volvo's service program

Periodic maintenance and service performed at the intervals specified in your Warranty and Service Records Information booklet will help keep your vehicle running well.

### Introduction

The maintenance services contain several checks that require special instruments and tools and therefore must be performed by a qualified technician. To keep your Volvo in top condition, specify time-tested and proven Genuine Volvo Parts and Accessories.

### The Federal Clean Air Act – U.S.

The Federal Clean Air Act requires vehicle manufacturers to furnish written instructions to the ultimate purchaser to assure the proper servicing and function of the components that control emissions. These services, which are listed in the "Warranty and Service Records Information" booklet, are not covered by the warranty. You will be required to pay for labor and material used.

### Maintenance

Your Volvo passed several major inspections before it was delivered to you, in accordance with Volvo specifications. The maintenance procedures outlined in the Warranty and Service Records Information booklet, many of which will positively affect your vehicle's emissions, should be performed as indicated. It is recommended that receipts for vehicle emission maintenance be retained in case questions arise concerning

maintenance. Inspection and maintenance should also be performed anytime a malfunction is observed or suspected.

### Applicable warranties – U.S./Canada

In accordance with applicable U.S. and Canadian regulations, the following list of warranties is provided.

- New Vehicle Limited Warranty
- Parts and Accessories Limited Warranty
- Corrosion Protection Limited Warranty
- Seat Belt and Supplemental Restraint Systems Limited Warranty
- Emission Design and Defect Warranty
- Emission Performance Warranty

These are the federal warranties; other warranties are provided as required by state/provincial law. Refer to your separate Warranty and Service Records Information booklet for detailed information concerning each of the warranties.

## Periodic maintenance helps minimize emissions

### NOTE

- Refer to your Warranty and Service Records Information booklet for a comprehensive service and maintenance schedule up to 150,000 miles (240,000 km). This program contains inspections and services necessary for the proper function of your vehicle and includes components that affect vehicle emissions.
- The Warranty and Service Records Information booklet also contains detailed information concerning the warranties that apply to your vehicle.

## On-board Diagnostic System

OBD II is part of your vehicle's computerized engine management system. It stores diagnostic information about your vehicle's emission controls. It can light the Check Engine light (MIL) if it detects an emission control "fault." A "fault" is a component or system that is not performing within an expected range. A fault may be permanent or temporary. OBD II will store a message about any fault.

## Emission inspection readiness

### How do states use OBD II for emission inspections?

Many states connect a computer directly to a vehicle's OBD II system. The inspector can then read "faults." In some states, this type of inspection has replaced the tailpipe emission test.

### How can my vehicle fail OBD II emission inspection?

Your vehicle can fail OBD II emission inspection for any of the following reasons.

- If your Check Engine (MIL) light is lit, your vehicle may fail inspection.
- If your vehicle's Check Engine light was lit, but went out without any action on your part, OBD II will still have a recorded fault. Your vehicle may pass or fail, depending on the inspection practices in your area.
- If you had recent service that required disconnecting the battery, OBD II diagnostic information may be incomplete and "not ready" for inspection. A vehicle that is not ready may fail inspection.

### How can I prepare for my next OBD II emission inspection?

- If your Check Engine (MIL) light is lit – or was lit but went out without service, have your

vehicle diagnosed and, if necessary, serviced by a qualified Volvo technician.

- If you recently had service for a lit Check Engine light, or if you had service that required disconnecting the battery, a period of driving is necessary to bring the OBD II system to "ready" for inspection. Two half-hour trips of mixed stop-and-go/highway driving are typically needed to allow OBD II to reach readiness. Your Volvo retailer can provide you with more information on planning a trip.
- Maintain your vehicle in accordance with your vehicle's maintenance schedule.

## Owner maintenance

Periodic maintenance requirements and intervals are described in your vehicle's Warranty and Service Records Information booklet.

The following points can be carried out between the normally scheduled maintenance services.

### Each time the car is refueled:

- Check the engine oil level.
- Clean the windshield, windshield wipers, headlights, and taillights.

## Monthly:

- Check cold tire pressure in all tires. Inspect the tires for wear.
- Check that engine coolant and other fluid levels are between the indicated "min" and "max" markings.
- Clean interior glass surfaces with a glass cleaner and soft paper towels.
- Wipe driver information displays with a soft cloth.
- Visually inspect battery terminals for corrosion. Corrosion may indicate a loose terminal connector, or a battery near the end of its useful service life. Consult your Volvo retailer for additional information.

## As needed:

Wash the car, including the undercarriage, to reduce wear that can be caused by a buildup of dirt, and corrosion that can be caused by salt residues.

Clean leaves and twigs from air intake vents at the base of the windshield, and from other places where they may collect.

### NOTE

Complete service information for qualified technicians is available online for purchase or subscription at [www.volvotechinfo.com](http://www.volvotechinfo.com).

◀◀ **Related information**

- Climate system service (p. 487)

**System updates**

Updates are available for infotainment-related services and Internet connections. If system software updates are available, they can be to be downloaded all at once or separately.

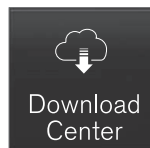

System (software) updates are handled through the **Download Center** app in the center display's App view. Tap once to start a download app in Home view's lower sub-view. If no search for updates has

been performed since the last time the infotainment system was started, a search will be initiated.

No search will begin if a software download is underway.

An icon in the **System updates** button indicates the number of updates that are currently available. Tap the button to display a list of updates that can be installed in the vehicle.

For additional information and answers to commonly asked questions pertaining to the function and downloading system updates, go to support.volvocars.com.

**Background searches for software updates is activated by default when the vehicle is delivered from the factory.**

**NOTE**

Downloading data may affect other system features that share the Internet connection. A download can be cancelled at any time or the other features can be temporarily turned off while the software download is underway.

**NOTE**

An update may be interrupted when the ignition is switched off.

However, an update does not have to be completed when the ignition is switched off; it will resume automatically when the ignition is switched on again.

**Updating all system software**

- Select **Install all** at the bottom of the list.

To avoid displaying a list, select **Install all** by the **System updates** button.

**Updating individual programs**

- Select **Install** to choose the software to be downloaded.

**Cancelling a download**

- Tap the activity indicator that replaced the **Install** button on the screen when the download began.



Keep in mind that a download can be cancelled but an installation that has already begun cannot be interrupted.

### Allowing background searches or software updates

This function can be deactivated from the center display:

1. Go to the Settings in the center display's Top view and select **Download Center**.
2. Tap **System** → **Download Center**.
3. Tap to deselect **Auto Software Update**.

If an update is available, **New software updates available** will appear in the center display's status bar. Tap the message to start a download app in Home view's lower sub-view. As soon as the download app has started, an icon in the **System updates** button will indicate the number of downloads available.

### Related information

- Center display overview (p. 28)
- Navigating in the center display's views (p. 38)

## Remote updates

With the vehicle connected to the Internet, updates for a number of the vehicle's systems can be downloaded from the center display.

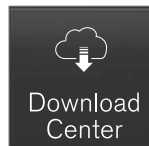

The **Download Center** app is started from the center display's App view and makes it possible to:

- search for and update system software
- update the Sensus Navigation maps
- download, update and uninstall apps

### Related information

- Downloading, updating and uninstalling apps (p. 441)
- System updates (p. 482)

## Vehicle status

The vehicle's general status can be displayed in the center display along with the possibility to book service<sup>1</sup>



The **Car status** app is started in the center display's App view and has three tabs:

- **Messages:** stored messages
- **Status:** tire pressure and engine oil level
- **Appointments:** booking service or repairs<sup>1</sup>

### Related information

- Using the center display (p. 44)
- Booking service and repairs (p. 484)
- Checking and refilling engine oil (p. 517)

<sup>1</sup> Certain markets only.

## Booking service and repairs

Connected Service Booking (CSB) makes it possible to use the vehicle's Internet connection to set up a time for service, maintenance and/or repairs.

The information is handled through the **Car status** app, which can be opened from the center display's App view.

Information about your vehicle is sent to your retailer and you can book your workshop appointment directly in your retailer's workshop planning system using the Volvo On-Line Service Scheduler with your smart phone. The system will also send a reminder as the appointment approaches and the Sensus Navigation system will provide directions to the workshop if necessary.

This feature makes it convenient to book a workshop appointment directly from your vehicle. Vehicle-related information is sent to your retailer, who prepares your visit to the workshop. After you have requested a workshop appointment, your retailer will send you an email including a link enabling you to connect directly to your retailer's booking system, where you can book the appointment at a convenient time. Information about your retailer is also available in the vehicle so that you can contact the retailer/workshop at any time using the **Call my retailer** menu option.

### NOTE

My Volvo can be found by going to [www.volvocars.com](http://www.volvocars.com) and selecting the United States or Canada.

## Before the service can be used

### Volvo ID

- The owner (primary driver) must create or have a Volvo ID (see the article "Volvo ID").
- You must enter your Volvo ID (your email address) in the vehicle as explained in the article "Volvo ID". If you have already registered a Volvo ID, use the same email address that you used to create the Volvo ID.

### Changing a Volvo ID email address

If you would like to register a different email address, open the Volvo ID app in the center display's App view and tap **Change Volvo ID**. Follow the instructions provided. See also the article "Volvo ID" for additional information.

### Selecting a Volvo retailer on the My Volvo website

By default, the retailer where you purchased your vehicle will be your preferred retailer/Volvo authorized workshop who will perform service and repairs on your vehicle. To change the preferred retailer, go to your personalized My Volvo website.

## Prerequisites for booking service from the vehicle

In order to request an appointment from the vehicle:

- The engine must be running
- The vehicle must be connected to the Internet (see the article "Internet connected vehicle")

## Using the service

When it is time for service or in certain cases if repairs are necessary, a message will appear in the instrument panel and in the center display. This message is triggered by:

- the amount of time that has elapsed since the last service
- the number of hours the engine has run since the last service
- mileage since the last service.
- Specific alerts or fault codes in the vehicle

## Booking service or repairs

Submit a booking request whenever you need a workshop appointment or when a message regarding the need for service or repairs has been displayed in the instrument panel and in the center display. This can be done directly from the vehicle as follows or alternatively by using the My Volvo personal website booking tab.

## Sending an appointment request

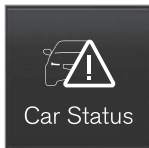

1. Open the **Car status** app in the center display's App view.
2. Tap **Appointments**.
3. Under **Appointments**, tap **Request appoint.**
4. Check that your **Volvo ID** is correct.
5. Check that the correct preferred retailer is listed. If you prefer, simply tap the button to initiate a call to the retailer.
6. Tap **Send appointment request**. Your request and vehicle data will be sent to your retailer through the vehicle's Internet connection.
  - > Volvo will send a booking invitation to your email address with a link to your preferred workshop's On-Line Service Scheduler.
7. Open the email and click the link to book your workshop appointment at a convenient time with your preferred service advisor. Add any additional preferences and free text to your booking.
8. When you have submitted your workshop booking, your appointment will be confirmed online directly by email. The booking information will also appear in the **Car status** app in the center display after a period of time as well as in your My Volvo personal website, where you can make changes to your appointment at any time.
9. Several days prior to your appointment, you will receive a reminder via email from your retailer. A notification will also appear on the center display one day prior to the appointment. You can set the interval for other reminders (e.g., two days, three days) at your My Volvo personal website.
10. On the day of your appointment, a reminder will appear again on the center display and the retailer's address can be set in your navigation system if you require directions to the workshop.

### Sending vehicle-related information

Information about the vehicle can be sent at any time using its Internet connection.

Using this function **does not send a workshop appointment request to your retailer**; only vehicle data will be transmitted to Volvo. This vehicle data can be accessed by any retailer if you call the retailer and provide your Vehicle Identification Number (VIN).



1. Open the **Car status** app in the center display's App view.
2. Tap **Appointments**.
3. Under **Appointments**, tap **Send vehicle data**.
  - > A message confirming that vehicle information has been sent via the Internet connection will appear on the center display. Transmission of the vehicle information can be cancelled at any time by tapping the X in the activity indicator.

## ◀ Viewing workshop information



1. Open the **Car status** app in the center display's App view.
2. Tap **Appointments**.
3. Under **Appointments**, tap **Workshop information**.
  - > A window with retailer information will appear.
4. If you prefer, call the retailer, or select an address or GPS coordinates to activate the navigation system.

### Appointments and vehicle information

When you make an appointment or send vehicle information from your vehicle, this information will be sent using the Internet connection<sup>2</sup>. Information about the vehicle includes:

- service requirements
- time since service was last performed
- function status
- fluid levels

- mileage (odometer reading)
- VIN (Vehicle Identification Number)
- The vehicle's software version
- Diagnostic information

### Related information

- Internet connected vehicle (p. 439)
- Volvo ID (p. 27)

## Wi-Fi connection to a workshop

The time a vehicle is in a workshop for service or repairs can be reduced by transmitting troubleshooting information as soon as the car reaches the workshop.

This is done most conveniently by selecting **Automatically connect when I arrive** in the center display's Settings menu.

Each time the vehicle slows down to a sufficiently low speed, it begins searching for a Wi-Fi network. If an authorized Volvo network (at a retailer or workshop) is found, a message will be displayed or a pop-up window will open in the center display (this applies to manual connections, see the section "Manually connecting to a workshop" below).

<sup>2</sup> There will be a slight charge for sending this information via the vehicle's Internet connection, depending on your service plan.

## Automatically connecting to a workshop

### Without driver confirmation

This is the most convenient way to transmit trouble-shooting data. The driver does not need to confirm that the vehicle will establish a connection.

If the vehicle stops at a workshop and the engine is switched off using the start knob, a message will appear above the status bar in the center display. The vehicle will be automatically connected when the driver's door is opened if the driver does not tap the **Cancel** button in the message.

To help prevent the driver from being disturbed by unwanted requests to connect (e.g., if the vehicle is often parked near a workshop with an authorized Volvo network), the vehicle will switch to manual connection if the driver cancels a connection request twice within 5 days.

### With driver confirmation

With this alternative, the driver must confirm a connection.

If the vehicle stops at a workshop and the engine is switched off using the start knob, a pop-up window will open in the center display. The vehicle will be automatically connected when the driver's door is opened if the driver taps **Connect** in the pop-up window. If the driver does nothing or taps the pop-up window's **Abort** button, no attempt will be made to establish a connection.

### NOTE

To help prevent the driver from being disturbed by unwanted requests to connect (e.g., if the vehicle is often parked near a workshop with an authorized Volvo network), the vehicle will switch to manual connection if the driver cancels a connection request twice within 5 days.

## Manually connecting to a workshop

Manual connections are handled by the service technician.

## Changing the way a connection is made

The type of connection (manual or automatic) can be changed in the center display's Settings menu.

1. Pull down the center display's Top view and tap **Settings**.
2. Tap **Communication** → **Volvo Service Networks**.
3. Select **Automatically connect when I arrive, Ask before connecting** or **Never connect and never ask** (manual connections).

## Related information

- Internet connected vehicle (p. 439)
- Settings view (p. 109)

## Climate system service

Service and repairs on the air conditioning system should only be done by a trained and qualified Volvo service technician.

## Troubleshooting and repairs

The air conditioning system contains a fluorescent tracer substance. Ultraviolet light is used to search for leaks in the system.

## Refrigerant R134a

### WARNING

The air conditioning system contains the refrigerant R134a under pressure. Service and repairs on the system should only be done by a trained and qualified Volvo service technician.

## Related information

- Climate control system (p. 182)

## Start battery

The vehicle's electrical system is single pole and uses the body and engine block as conductors.

The start (main) battery is used to power the starter motor and other electrical components and systems.

The start battery should only be replaced by a trained and qualified Volvo service technician.

The vehicle has an alternating current generator.

The start battery is an Absorbed Glass Mat (AGM) 12-volt battery that is dimensioned for use in vehicles to support electrical systems and functions and regenerative charging.

The service life of a battery is affected by factors such as driving conditions/style, the number of starts, climate, etc. Extreme cold may also further decrease the battery's starting capacity.

- Never disconnect the start battery while the engine is running.
- Check that the start battery is correctly connected and that the clamps on its terminals are properly tightened.

**⚠ WARNING**

- Never expose the battery to open flame or electric spark.
- Do not smoke near the battery.
- Battery fluid contains sulfuric acid. Do not allow battery fluid to contact eyes, skin, fabrics or painted surfaces. If contact occurs, flush the affected area immediately with water. Obtain medical help immediately if eyes are affected.

**⚠ WARNING**

**PROPOSITION 65 WARNING!**

Battery posts, terminals, and related accessories contain lead and lead compounds, chemicals known to the state of California to cause cancer and reproductive harm. Wash hands after handling.

If the start battery is being charged, the support battery will also be charged.

If an external auxiliary battery is used to start the vehicle, **use the connection points in the engine compartment.** The start battery's terminals should **never** be used. See the following illustration for the location of the connection points.

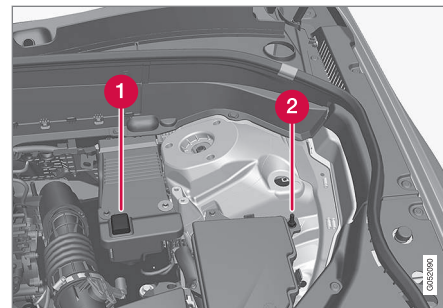

**1** Positive connection point

**2** Negative connection point

Only modern battery chargers with controlled charging current should be used to charge the start and support batteries. Quick charge functions should **not** be used and could damage the battery.

**!** **CAUTION**

- The infotainment system's energy-saving feature may not function correctly or at all, and/or a message may be displayed if a battery charger or jumper cables are not connected properly.
- The negative terminal on the battery must **never** be used to connect a jumper cable or a battery charger. Only the ground point on the chassis may be used.

**i** **NOTE**

- The service life of the start battery is shortened if it becomes discharged repeatedly.
- The service life of the start battery is affected by factors such as driving conditions and climate. Extreme cold may also further decrease the battery's start capacity.
- Because the battery's starting capacity decreases with time, it may be necessary to recharge it if the vehicle is not driven for an extended period of time or if the vehicle is usually only driven short distances.
- Driving for at least 15 minutes a week or connecting the battery to a charger with automatic maintenance charging will help keep it in good operating condition.
- Keeping the start battery fully charged will help maximize its service life.

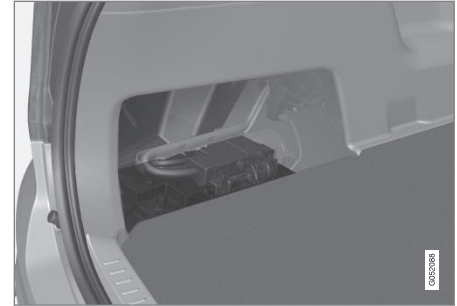

The start battery is located in the cargo compartment. The following table provides start battery specifications.

	Battery
	H7 AGM
Current (V)	12
Cold start capacity (Cold Cranking Amperes - CCA) (A)	800
Dimensions, LxWxH in. (mm)	12.4x6.9x7.5 (315x175x190)
Capacity (Ah)	80





**⚠ WARNING**

In certain models, the battery is held in place by a strap. Ensure that this strap is always securely fastened and pulled taut.

- When replacing the start battery or support battery an Absorbed Glass Mat (AGM) must be used.
- When replacing the start battery, a new battery with the same specifications and dimensions must be used. The battery should only be replaced by a trained and qualified Volvo service technician.

**Related information**

- Jump starting (p. 374)
- Support battery (p. 490)
- Battery symbols (p. 491)

**Support battery**

Vehicles equipped with Start/Stop are equipped with two 12-volt batteries.

In addition to a heavy-duty start battery, models with Start/Stop also have a support battery that provides extra current during the Start/Stop function's start sequence.



The support battery is located in a box next to the spring strut in the engine compartment

The following table shows the specifications for the support battery:

Current (V)	12
Cold start capacity (Cold Cranking Amperes - CCA) (A)	170

Dimensions, LxWxH in. (mm)	5.9x3.5x5.1 (150x90x130)
Capacity (Ah)	10

- When replacing the start battery or support battery in a vehicle with Start/Stop, an Absorbed Glass Mat (AGM) must be used.
- The greater the current consumption in the vehicle, the more the generator has to operate and the battery is charged. This increases fuel consumption.
- When the start battery's charge is below the minimum permitted level, the Start/Stop function will be disabled.

When the Start/Stop function is temporarily disabled due to high current consumption:

- The engine will auto-start, even if the brake pedal is depressed.

The support battery does not normally require more service than the start battery. If questions arise, consult a Volvo retailer or trained and qualified Volvo service technician.



**! CAUTION**

When connecting an external start battery or a battery charger, the Start/Stop function may be temporarily disabled if the negative terminal on the vehicle's start battery is used to connect an external start battery or a battery charger. Only the **negative connection point** in the engine compartment may be used as a ground point.

**i NOTE**

If the start battery is completely discharged and the vehicle has no normal electrical functions, and the engine is then started using an auxiliary battery or battery charger, the Start/Stop function will be activated. The engine can then be auto-stopped but may not auto-start again due to an insufficient charge level in the start battery.

To help ensure auto-start, the start battery should be charged first. At a temperature of approx. 60 °F (15 °C), the battery should be charged for at least 1 hour, preferably using an external battery charger. At lower temperatures, the battery should be charged for 3–4 hours.





If a charger is not available, it is advisable to disable the Start/Stop function until the battery is sufficiently recharged.

**Related information**

- Start battery (p. 488)
- Start/Stop (p. 389)
- Battery symbols (p. 491)

**Battery symbols**

There are information and warning symbols on the battery.

	<p>Wear protective goggles.</p>
	<p>See the owner's manual for additional information.</p>
	<p>Keep batteries away from children.</p>
	<p>Batteries contain corrosive acid.</p>



	<p>Avoid smoking, open flames, and/or sparks.</p>
	<p>Risk of explosion</p>
	<p>Recycle properly</p>

**i NOTE**

A used battery should be disposed of in an environmentally responsible manner. Consult your Volvo retailer or take the battery to a recycling station.

**Related information**

- Start battery (p. 488)

**Fuses**

The fuses help protect the vehicle's electrical components from overloading or short circuits.

**⚠ WARNING**

Never use metal objects or fuses with higher amperage than those stated on the lists of fuses. Doing so could seriously damage or overload the vehicle's electrical system.

If an electrical component fails to function, this may be due to a blown fuse. If the same fuse blows repeatedly, this indicates a problem with the component, which should be inspected by a trained and qualified Volvo service technician.

**Location of the fuseboxes**

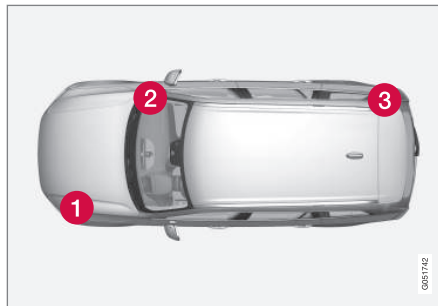

- 1** Engine compartment
- 2** Under the glove compartment

- 3** Cargo compartment

**Related information**

- Replacing fuses (p. 493)
- Fuses in the cargo compartment (p. 502)
- Fuses in the engine compartment (p. 494)
- Fuses in the passenger compartment (p. 498)

## Replacing fuses

The fuses help protect the vehicle's electrical components from overloading or short circuits.

### Fuse replacement

1. See the list of fuse boxes for their locations.
2. Pull the fuse straight out and examine it from the side to see if the curved metal wire in the fuse is intact.
3. If the wire is broken, insert a new fuse of the same color and amperage (written on the fuse).

### WARNING

Never use metal objects or fuses with higher amperage than those stated on the following pages. Doing so could seriously damage or overload the vehicle's electrical system.

### Related information

- Fuses (p. 492)
- Fuses in the cargo compartment (p. 502)
- Fuses in the engine compartment (p. 494)
- Fuses in the passenger compartment (p. 498)

### **Fuses in the engine compartment**

The fuses in the engine compartment help protect electrical components such as engine and brake functions.

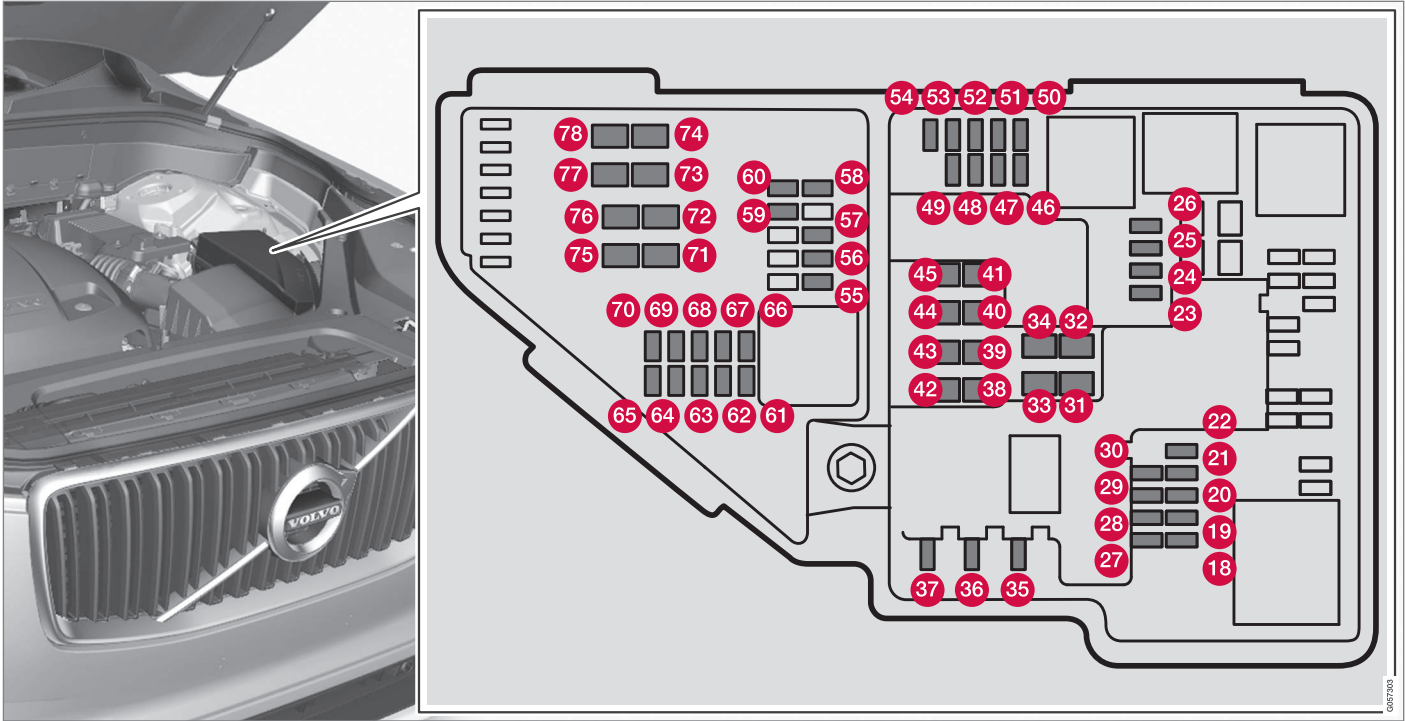

There is a fuse removal tool on the inside of the fuse box cover. There are also positions in the fuse box for several extra fuses.

**Positions**

There is a decal on the inside of the cover with a list of fuses.



## MAINTENANCE AND SERVICING

- ◀ • Fuses 18–30, 35–37, 46–54 and 55–70 are called "Micro".
- Fuses 31–34, 38–45 and 71–78 are called "MCase" and should only be replaced by a trained and qualified Volvo service technician.

	Function	A
18	–	–
19	–	–
20	–	–
21	–	–
22	–	–
23	Front USB socket*	5
24	12-volt socket in the front tunnel console	15
25	12-volt socket on the rear side of the tunnel console	15
26	12-volt socket in the cargo compartment	15
27	–	–
28	Driver's side headlight, certain LED models	15
29	Passenger's side headlight, certain LED models	15

	Function	A
30	–	–
31	Heated windshield*, driver side	Shunt
32	Heated windshield*, driver side	40
33	Headlight washers*	25
34	Windshield washer	25
35	–	–
36	Horn	20
37	Alarm siren	5
38	Brake system control module (valves, parking brake)	40
39	Windshield wipers	30
40	Tailgate window washer	25
41	Heated windshield*, passenger side	40
42	–	–
43	Brake system control module (ABS pump)	40
44	–	–

	Function	A
45	Heated windshield*, passenger side	Shunt
46	Feed when ignition is switched on to: engine control module, transmission components, electrical power steering, central electrical module; Brake system control module	5
47	–	–
48	Passenger side headlight Passenger's side headlight, certain LED models	7.5 15
49	–	–
50	–	–
51	Battery connection control module	5
52	Air bags; Occupant Weight Sensor (OWS)	5
53	Driver side headlight Driver's side headlight, certain LED models	7.5 15
54	Accelerator pedal sensor	5

	Function	A
55	Transmission control module	15
56	Engine control module	5
57	-	-
58	-	-
59	-	-
60	-	-
61	Engine control module; actuator; Turbocharger valve	20
62	Solenoids; Valves; Engine cooling system thermostat	10
63	Vacuum regulators; Valve	7.5
64	Spoiler shutter control module; Radiator shutter control module; Fuel leakage detection	5
65	-	-
66	Heated oxygen sensors (front and rear)	15
67	Oil pump solenoid; A/C magnetic coupling; heated oxygen sensor (center)	15
68	-	-

	Function	A
69	Engine control module	20
70	Ignition coil; Spark plugs	15
71	-	-
72	-	-
73	-	-
74	-	-
75	-	-
76	-	-
77	Starter motor	Shunt
78	Starter motor	40

#### Related information

- Fuses (p. 492)
- Replacing fuses (p. 493)

## **Fuses in the passenger compartment**

The fuses in the passenger compartment (located under the glove compartment) help pro-

tect electrical components such as the 120-volt socket, displays and door modules.

There is a fuse removal tool on the inside of the fuse box covers. There are also positions in the fuse box for several extra fuses.



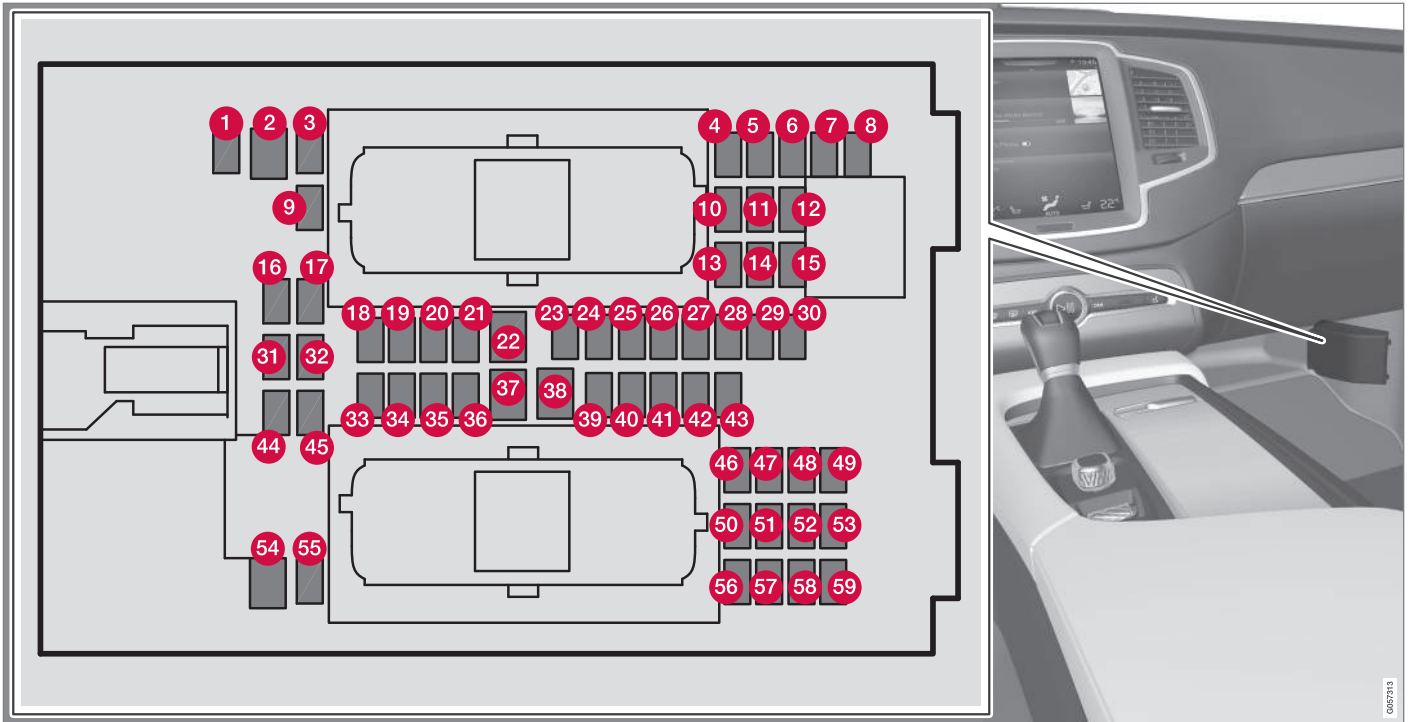

◀ **Positions**

- Fuses 1, 3-21, 23-36, 39-53 and 55-59 are called "Micro".
- Fuses 2, 22, 37-38 and 54 are called "MCASE" and should only be replaced by a trained and qualified Volvo service technician.

	Function	A
1	-	-
2	120-volt socket on the rear side of the tunnel console*	30
3	-	-
4	Alarm system movement sensor <sup>A</sup>	5
5	Media player	5
6	Instrument panel	5
7	Center console buttons	5
8	Sun sensor	5
9	-	-
10	-	-
11	Steering wheel module	5
12	Module for start knob and parking brake	5

	Function	A
13	Heated steering wheel* module	15
14	-	-
15	-	-
16	-	-
17	-	-
18	Climate system control module	10
19	-	-
20	On-board diagnostics (OBDII)	10
21	Center display	5
22	Climate system blower module (front)	40
23	-	-
24	Instrument lighting; Courtesy lighting; Auto-dim rearview mirror; Rain and light sensor; Rear tunnel console keypad*; Power front seats*; Rear door control panels	7.5
25	Control module for driver support functions	5
26	Panorama roof and sun shade*	20

	Function	A
27	Head-up display*	5
28	Courtesy lighting	5
29	-	-
30	Ceiling console display (seat belt reminder, front passenger side air-bag indicator)	5
31	-	-
32	Humidity sensor	5
33	Rear passenger-side door module	20
34	Fuses in the cargo compartment	10
35	Internet connection control module; Volvo On Call control module	5
36	Rear driver-side door module	20
37	Infotainment control module (amplifier)	40
38	Climate system blower module (rear)*	40
39	Multi-band antenna module	5
40	Front seat massage function	5
41	-	-

	Function	A
42	Tailgate window wiper	15
43	Fuel pump control module	15
44	-	-
45	-	-
46	Driver side front seat heating*	15
47	Passenger side front seat heating*	15
48	Coolant pump	10
49	-	-
50	Front driver-side front door module	20
51	Active chassis control module*	20
52	-	-
53	Sensus control module	10
54	-	-
55	-	-
56	Front passenger-side front door module	20
57	-	-

	Function	A
58	-	-
59	Circuit breaker for fuses 53 and 58	15

<sup>A</sup> Certain markets only.

### Related information

- Fuses (p. 492)
- Replacing fuses (p. 493)
- Fuses in the engine compartment (p. 494)
- Fuses in the cargo compartment (p. 502)

## **Fuses in the cargo compartment**

The fuses in the cargo compartment help protect electrical components such as power seats\*, airbags and seat belt tensioners.

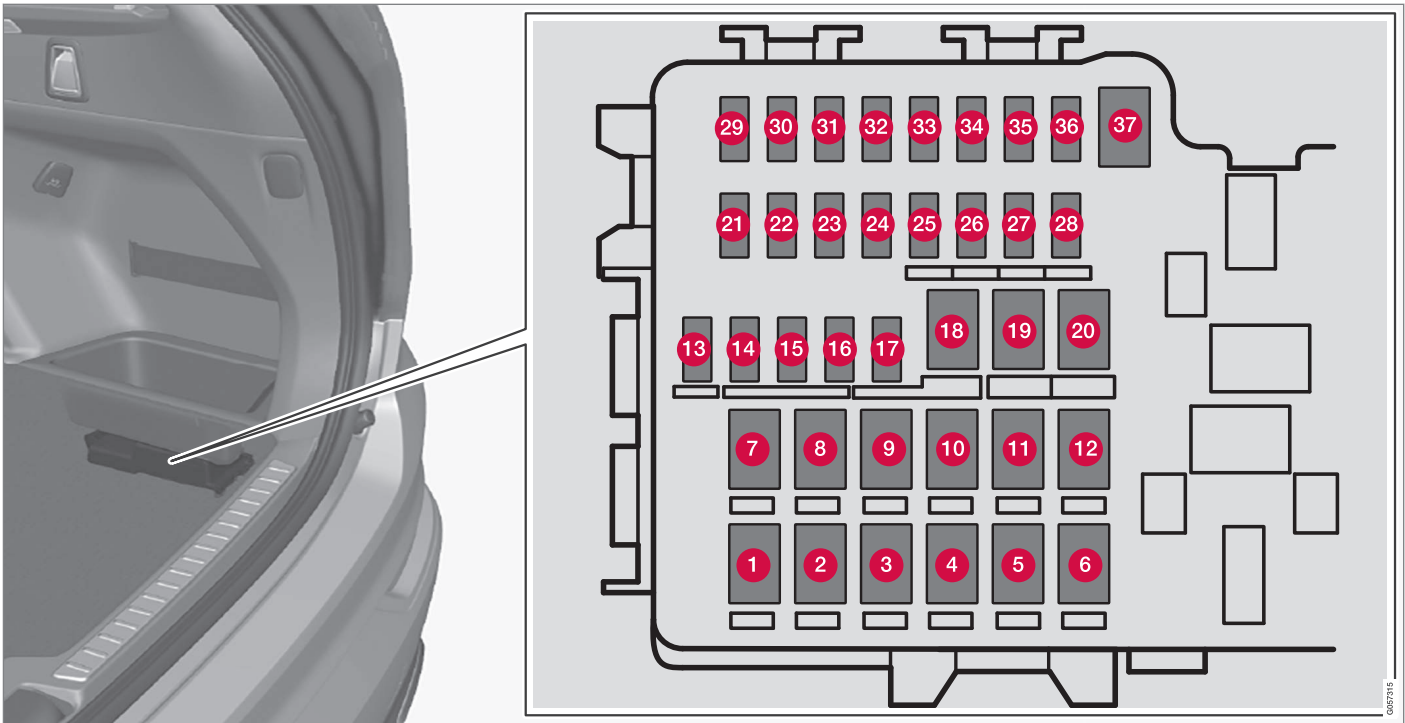

The fuse box is under the storage compartment on the right side

There is a fuse removal tool on the inside of the fuse box cover. There are also positions in the fuse box for several extra fuses.

◀ **Positions**

- Fuses 13–17 and 21–36 are called "Micro".
- Fuses 1–12, 18–20 and 37 are called "MCase" and should only be replaced by a trained and qualified Volvo service technician.

	Function	A
1	Heated rear window	30
2	–	–
3	Pneumatic suspension* compressor	40
4	Rear auxiliary electric heater (passenger side)	30
5	–	–
6	Rear auxiliary electric heater (driver side)*	30
7	–	–
8	–	–
9	Power tailgate*	25
10	Power front seat (passenger side)* module	20
11	Trailer hitch* control module	40
12	Seat belt tensioner module (passenger side)	40

	Function	A
13	Internal relay windings	5
14	–	–
15	Foot movement detection module for opening the power tailgate*	5
16	–	–
17	Module for electrically folding third row seats*	20
18	Trailer hitch* control module	25
19	Power front seat (driver seat* module)	20
20	Seat belt tensioner module (driver side)	40
21	Parking camera*	5
22	–	–
23	–	–
24	–	–
25	–	–
26	Airbag and seat belt tensioner modules	5
27	–	–

	Function	A
28	Heated rear seat (driver side)*	15
29	–	–
30	Blind Spot Information (BLIS)*	5
31	–	–
32	Seat belt tensioner modules	5
33	Emission system actuator	5
34	–	–
35	All Wheel Drive control module*	15
36	Heated rear seat (passenger side)*	15
37	–	–

**Related information**

- Replacing fuses (p. 493)
- Fuses (p. 492)
- Fuses in the passenger compartment (p. 498)
- Fuses in the engine compartment (p. 494)

## Replacing bulbs

The halogen headlight bulbs<sup>3</sup> can be replaced by the owner.

Before the halogen headlight bulbs can be replaced, that plastic covering over the headlight housing has to be removed and the housing has to be lifted out of the vehicle.

### **i** NOTE

Halogen headlights are not available on all models or in all markets.

Consult your Volvo retailer if you are uncertain about the type of headlights in your vehicle.

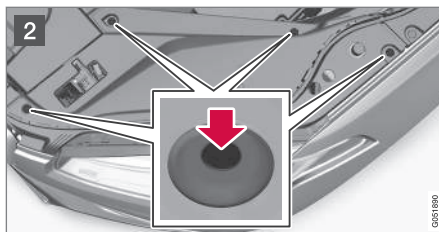

To do so:

- 1** Lift the rubber strip by pressing in toward the engine compartment.
- 2** Release the pins in the plastic covering's four clips by pressing them down with a screwdriver or similar object and remove the covering.

The turn signal, high/low beam, Daytime Running Light and parking light bulbs will be accessible when the plastic covering has been removed.

Put the covering back in place in the reverse order.

### **i** NOTE

The pins in the clips have to be pressed back completely before the clips are placed in the plastic covering.

When the covering is put back in place, the pins must be pressed so that their upper surface is flush with the surface of the clip.

<sup>3</sup> Halogen headlights are not available on all models.



**i NOTE**

- For information regarding any bulbs not mentioned in this section, please contact your Volvo retailer or a trained and authorized Volvo service technician.
- Always switch off the ignition before starting to replace a bulb.
- If an error message remains in the display after a faulty bulb has been replaced, contact an authorized Volvo workshop.
- Condensation may form temporarily on the inside of the lenses of exterior lights such as headlights, fog lights, or taillights. This is normal and the lights are designed to withstand moisture. Normally, condensation will dissipate after the lights have been on for a short time.
- The optional Active Bending Light bulbs contain trace amounts of mercury. These bulbs should always be disposed of by a trained and qualified Volvo service technician.

**! CAUTION**

Never touch the glass of bulbs with your fingers. Grease and oils from your fingers vaporize in the heat and will leave a deposit on the reflector, which will damage it.

**⚠ WARNING**

- The ignition should be switched off completely (be in ignition mode **O**) when replacing bulbs.
- If the engine has been running just prior to replacing bulbs in the headlight housing, please keep in mind that components in the engine compartment will be hot.

**Front bulbs (vehicles with halogen headlights)**

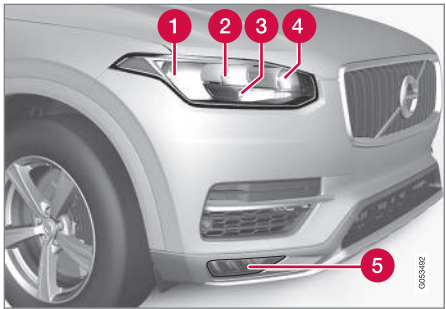

- 1** Low beam
- 2** High beam
- 3** Parking light/Daytime Running Light
- 4** Turn signal
- 5** Fog light with corner illumination (LED)



## Taillight bulbs

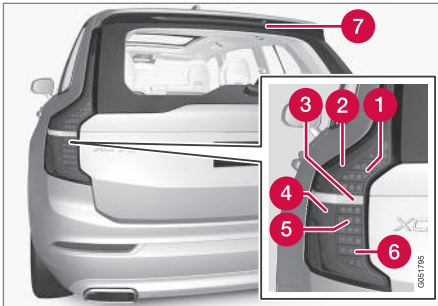

- 1 Brake light (LED)
- 2 Side marker light (LED)
- 3 Backup light<sup>4</sup>
- 4 Taillight (LED)
- 5 Turn signal (LED)
- 6 Fog light (LED)
- 7 High-mounted brake light (LED)

### Related information

- Bulb specifications (p. 511)
- Removing the rectangular headlight cover (p. 507)

- Replacing High Beam headlight bulbs (p. 509)
- Replacing low beam headlight bulbs (p. 508)
- Ignition modes (p. 380)

<sup>4</sup> Must be replaced by a trained and qualified Volvo service technician.

## Removing the rectangular headlight cover

Most of the bulbs in the headlight housing can be accessed when the rectangular cover has been removed.

Before the rectangular cover can be removed, the plastic covering must be removed, see the article "Replacing bulbs" for information.

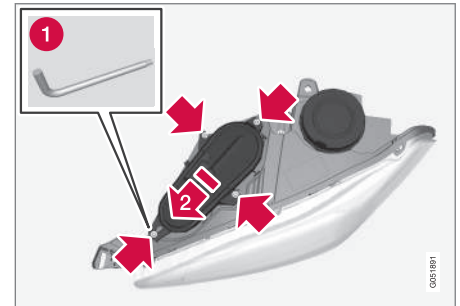

1. Loosen the cover's four screws with a T20 Torx screwdriver (1) but do not remove them completely (turning them 3-4 turns is enough).
2. Push the cover to the side.
3. Remove the cover.

Put the cover back in place in the reverse order.

◀◀ **Related information**

- Replacing bulbs (p. 505)

### Replacing low beam headlight bulbs

On models with halogen headlights, the low beam headlight bulb can be replaced by the owner.

Before the bulb can be replaced, the plastic covering over the headlight housing has to be removed, see the article "Replacing bulbs."

**!** **CAUTION**

Never touch the glass of bulbs with your fingers. Grease and oils from your fingers vaporize in the heat and will leave a deposit on the reflector, which will damage it.

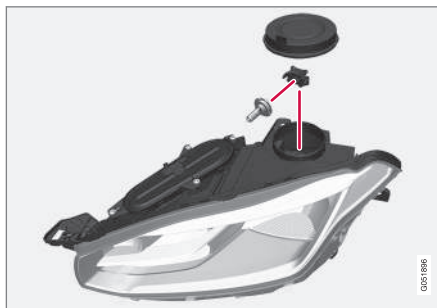

Driver's side bulb housing shown

1. Remove the low beam round rubber cover from the headlight housing.

2. Remove the connector from the bulb.
3. Remove the bulb by pressing it slightly upward and then pulling it out.
4. Insert the bulb in the socket. The bulb's guiding pin should point straight up.
5. Press the connector into place.
6. Put the rubber cover back into place.

### Related information

- Replacing bulbs (p. 505)
- Bulb specifications (p. 511)

## Replacing High Beam headlight bulbs

On models with halogen headlights, the High Beam headlight bulb can be replaced by the owner.

Before the bulb can be accessed, the headlight housing's rectangular cover must be removed, see the article "Removing the rectangular headlight cover."

### **!** CAUTION

Never touch the glass of bulbs with your fingers. Grease and oils from your fingers vaporize in the heat and will leave a deposit on the reflector, which will damage it.

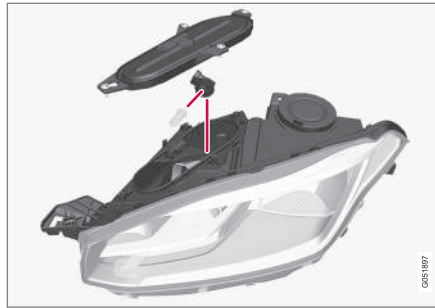

Driver's side bulb housing shown

1. Remove the bulb by turning the bulb holder upward and then pulling it straight out.
2. Carefully pry the plastic sleeve by the connector's locking lug to release it.
3. Remove the connector from the bulb.
4. Insert a new bulb.
5. Insert the bulb in the socket and turn it downward.

### Related information

- Removing the rectangular headlight cover (p. 507)
- Bulb specifications (p. 511)
- Replacing bulbs (p. 505)

## Replacing front turn signal bulbs

On models with halogen headlights, the front turn signal bulb can be replaced by the owner.

Before the bulb can be accessed, the headlight housing's rectangular cover must be removed, see the article "Removing the rectangular headlight cover."

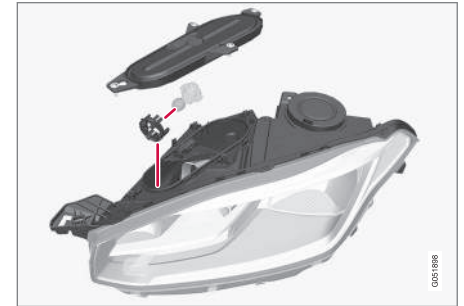

Driver's side headlight housing shown

1. Press the retaining catches together and pull the bulb holder straight out.
2. The bulb holder and bulb must be replaced as one unit.
3. Press the new bulb holder into the socket.

◀◀ **Related information**

- Removing the rectangular headlight cover (p. 507)
- Replacing bulbs (p. 505)
- Bulb specifications (p. 511)

**Replacing front parking light bulbs**

On models with halogen headlights, the front parking light bulb can be replaced by the owner.

Before the bulb can be accessed, the headlight housing's rectangular cover must be removed, see the article "Removing the rectangular headlight cover."

Remove the high beam bulb first by turning the bulb holder upward and then pulling it straight out. This makes it easier to access the parking light bulb.

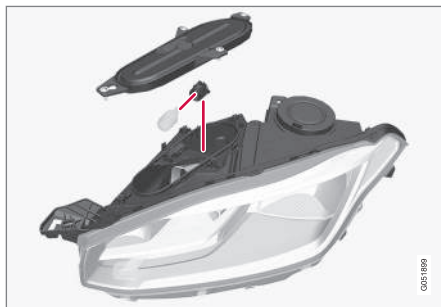

Driver's side bulb housing shown

1. Pull the bulb holder straight out.
2. Remove the bulb by pulling it straight out.
3. Insert a new bulb.
4. Insert the bulb holder in the socket and press it into place.

5. If the high beam bulb was removed, insert the bulb in the socket and turn downward.

**Related information**

- Replacing bulbs (p. 505)
- Bulb specifications (p. 511)
- Removing the rectangular headlight cover (p. 507)

## Bulb specifications

The following specifications apply to models equipped with halogen<sup>5</sup> headlights. If other bulbs need to be replaced, contact a trained and qualified Volvo service technician.

Function	[W] <sup>A</sup>	Type
Low beam	55	H11
High Beam	65	H9
Front turn signal	24	PY24W
Daytime running light/ parking light	21/5	W21/5W

<sup>A</sup> Watt

## Related information

- Replacing bulbs (p. 505)

<sup>5</sup> Halogen headlights are not available in all models.

## Hoisting the vehicle

When the vehicle is hoisted, the jack or garage lift must be positioned correctly under the vehicle.

For vehicles equipped with leveling control\*, if it is also equipped with the optional pneumatic suspension, this must be deactivated before the vehicle is hoisted. This is done from the center display:

1. Tap **Settings** in Top view.
2. Tap **My Car** → **Suspension** .
3. Select **Disable Leveling Control**.

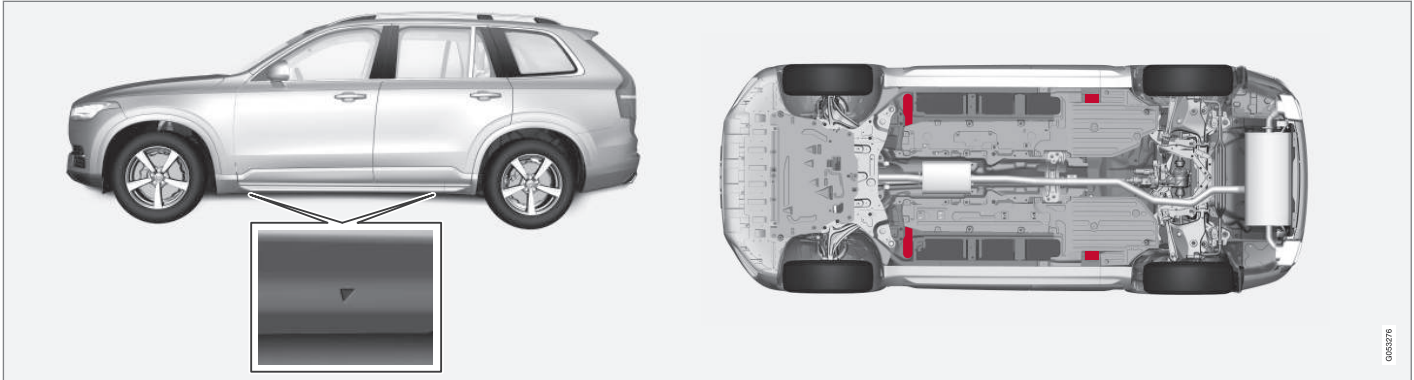

Location of the jack attachment points (triangles)/lifting points (red areas)

### **i** NOTE

The jack provided with your vehicle is intended to be used only in temporary situations such as changing wheels in the event of a flat tire. Only the jack that came with your particular model should be used to lift the vehicle. If the vehicle needs to be lifted more frequently or for a prolonged period, using a garage jack or hoist is recommended. Always follow this device's instructions for use.

### **⚠** WARNING

- Ensure that the jack is positioned so that the vehicle cannot slide off it.
- Always use axle stands or similar structures.

### Related information

- Removing a wheel (p. 465)
- Installing a wheel (p. 466)
- Jack (p. 462)

0052776

## Opening and closing the hood

The hood is opened by releasing it from the passenger compartment and then by using the handle under the front edge of the hood.

### Opening



- 1** With the hood completely closed, pull the control (located to the left of the brake pedal).

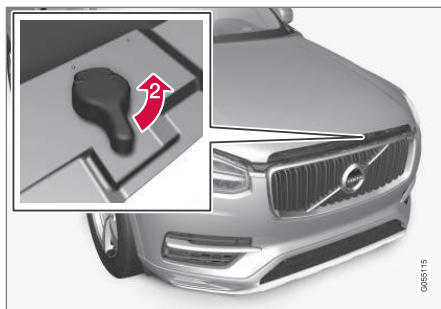

- 2** Turn the handle under the front edge of the hood counterclockwise to release it from the lock and lift.

### Warning—hood not closed



When the hood lock has been completely released, this symbol and a graphic will illuminate in the instrument panel and an audible signal will be given. If the vehicle begins to roll, the audible signal will be repeated several times.

For additional information about this symbol, see also the article "Door and seat belt reminders."

### **i** NOTE

If the warning symbol remains on or if the audible signal is given even if the hood is completely closed and locked, consult a trained and qualified Volvo service technician.

### Closing

1. Press down the hood until it begins to close due to its own weight.
2. When the handle under the front edge of the hood is in the lock, press down on the hood to close it completely.

### **!** WARNING

- Be sure the hood is completely unobstructed while it is being closed.
- Check that the hood locks properly when closed. It must audibly lock on both sides.
- Never drive if the hood is not completely closed and locked.
- While driving, if there are any indications that the hood is not locked in the closed position, stop safely as soon as possible and close it completely.





0005616



0005617

Hood completely closed

### Related information

- Engine compartment overview (p. 515)
- Door and seat belt reminders (p. 64)

## Engine compartment overview

The engine compartment overview shows some maintenance points.

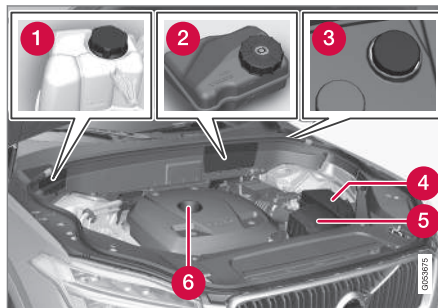

The layout of the engine compartment may differ slightly from model to model

- 1 Coolant expansion tank
- 2 Brake fluid reservoir
- 3 Washer fluid reservoir
- 4 Relay/fuse box
- 5 Air cleaner
- 6 Engine oil filler cap

## WARNING

- The cooling fan (located at the front of the engine compartment, behind the radiator) may start or continue to operate (for up to 6 minutes) after the engine has been switched off.
- Engine cleaning should only be done by a workshop. If engine cleaning agents are used when the engine has been running, there may a fire risk.
- Before performing any operations in the engine compartment, the ignition should always be completely switched off (in mode **0**) and there should be no remote keys in the passenger compartment. The gear selector should be in the **P** (park) position. If the engine has been running, wait until it has cooled before touching any components in the engine compartment.
- The distributor ignition system operates at very high voltages. Special safety precautions must be followed to prevent injury. Always turn the ignition off when replacing distributor ignition components e.g. plugs, coil, etc.
- Do not touch any part of the distributor ignition system while the engine is running. This may result in unintended movements and body injury.



#### ◀ Related information

- Ignition modes (p. 380)
- Opening and closing the hood (p. 514)
- Refilling the windshield washer fluid reservoir (p. 521)

### Engine oil

The correct oil must be used for the stated oil change (service) intervals for the warranty to apply.

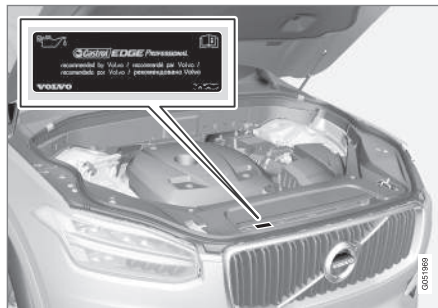

Volvo recommends:



**!** **CAUTION**

- Not checking the oil level regularly can result in serious engine damage if the oil level becomes too low.
- Oil that is lower than the specified quality can damage the engine.
- Volvo does not recommend the use of oil additives.
- Always add oil of the same type and viscosity as already used.
- Oil changes should be carried out by a trained and qualified Volvo service technician.
- Using oil of higher than the specified quality is permitted and may be necessary for demanding driving.

Also, refer to the Warranty and Service Records information booklet for information on oil change intervals and oil specifications.

#### Related information

- Checking and refilling engine oil (p. 517)
- Engine oil specifications and volume (p. 544)

## Checking and refilling engine oil

The oil level is checked electronically.



Oil filler cap<sup>6</sup>

It may be necessary to top up engine oil between regularly scheduled services.

No action is necessary until a message is displayed in the instrument panel.

### **WARNING**



If this symbol and **Engine oil level Service required** are displayed, have the vehicle checked by a trained and qualified Volvo service technician. The oil level may be too high.

Do not allow oil to spill onto or come into contact with hot exhaust pipe surfaces.

### **CAUTION**



If this symbol and **Engine oil level low Add "...."** (an amount of oil) are displayed, add the amount of oil indicated.

## Checking the oil level

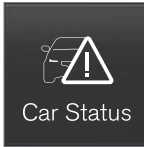

Car Status

The oil level can be checked in the center display when the engine is not running.

From the center display's Home view, swipe the screen from right to left to open App

view. Tap **Car status** and then tap **Status** to show the oil level.

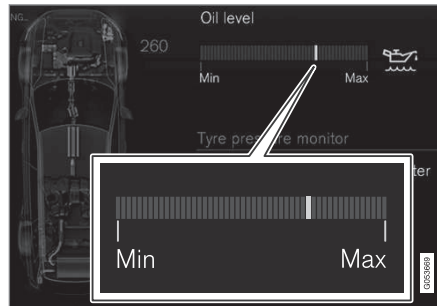

Oil level graphic in the center display

The oil level should be checked at regular intervals, particularly during the period up to the first scheduled maintenance service.

If the oil level sensor indicates that the level is too low, using the correct oil, top up with the amount of oil indicated as soon as possible.

### **NOTE**

- The system cannot detect changes in the oil level immediately. The vehicle must be driven approximately 20 miles (30 km) or have been parked on level ground with the engine off for 5 minutes before the oil level reading will be correct.
- If the necessary conditions are not met for checking the oil level electronically (time interval after the engine was switched off, if the vehicle is parked on an incline, etc.), **No values available** will be displayed. This does **not** indicate a problem with the oil level sensor.

## Related information

- Engine oil (p. 516)
- Ignition modes (p. 380)
- Engine oil specifications and volume (p. 544)

<sup>6</sup> Models with an electronic oil level sensor do not have a dipstick.

## Windshield wipers in the service position

The windshield wiper blades must be in the vertical (service) position for replacement, washing or to lift them away from the windshield when e.g., removing ice or snow.



Wipers in the service position

### **!** CAUTION

Be sure the wiper blades are not frozen in position before attempting to move them to the service position.

## Putting the windshield wipers in the service position

The service position can be activated while the vehicle is stationary and the wipers are not activated.

The service position can be activated in two ways from the center display:

### Via Function view

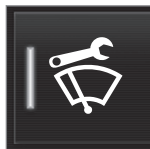

- From Function view, tap the **Wiper Service Position** button. The indicator light in the button will illuminate when the service position is activated.
  - > The windshield wipers will move to the vertical position.

### Via Settings

1. Tap **Settings** in the center display's Top view.
2. Tap **My Car → Wipers**
3. Tap the **Wiper Service Position** box.
  - > The windshield wipers will move to the vertical position.

## Deactivating service position

The service position can be deactivated in two ways from the center display:

### Via Function view



- From Function view, tap the **Wiper Service Position** button. The indicator light in the button will go out when the service position is deactivated.

### Via Settings

1. Tap **Settings** in the center display's Top view.
2. Tap **My Car → Wipers**
3. Tap the **Wiper Service Position** to deselect the box.

The wipers will also leave the service position if:

- The wipers are activated.
- The windshield washers are activated.
- The rain sensor is activated.

### **!** CAUTION

If the wiper arms have been folded out from the windshield while in the service position, fold them back against the windshield before returning the wipers to the normal position to help avoid scratching the paint on the hood.

**Related information**

- Replacing wiper blades (p. 519)
- Using the windshield wipers (p. 157)

**Replacing wiper blades**

The wiper blades should be replaced regularly for best effect.

The windshield wiper blades must be in the vertical (service) position for replacement, washing or to lift them away from the windshield when e.g., removing ice or snow.

**Replacing the windshield wiper blades**

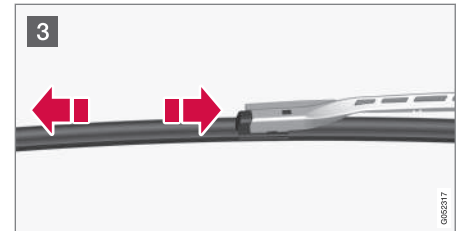
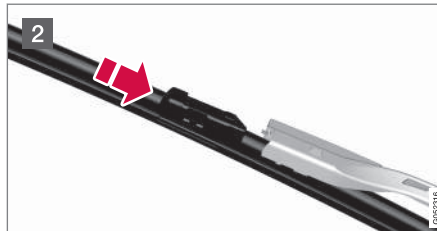
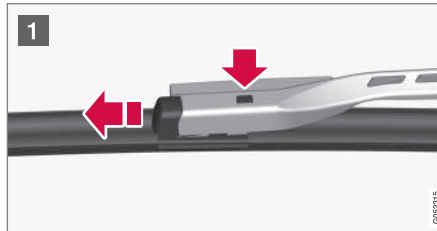

- 1 With the wipers in the service position, fold out the wiper arm from the windshield. Press the button on the wiper blade attachment and pull the wiper blade straight out, parallel with the wiper arm.
- 2 Slide in the new wiper blade until it clicks into place.
- 3 Check that the blade is securely in place.
4. Press the wipers back against the windshield.

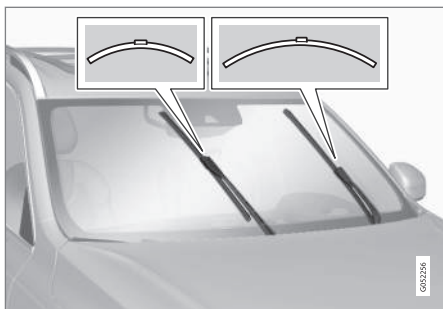

The windshield wiper blades are different lengths

**i NOTE**

The windshield wiper blades are different lengths. The blade on the driver's side is longer than the one on the passenger side.

**Cleaning**

Keeping the windshield/rear window and wiper blades clean helps improve visibility and prolongs the service life of the wiper blades. Clean the wiper blades with a stiff-bristle brush and luke-warm soap solution or car washing detergent.

**Replacing the tailgate wiper blade**

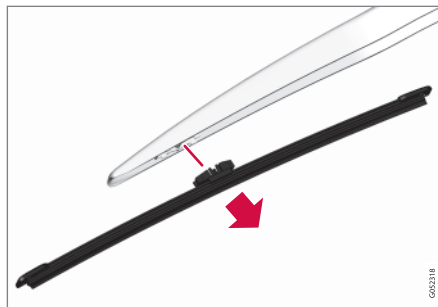

1. Fold the wiper arm outward.
2. Grasp the inner section of wiper blade (at the arrow).
3. Use one end of the wiper blade as a lever to help release it from the wiper arm.
4. Press the new wiper blade until it clicks into place and check that it seats securely.
5. Fold the wiper arm back toward the tailgate window.

**Related information**

- Windshield wipers in the service position (p. 518)
- Refilling the windshield washer fluid reservoir (p. 521)

**Refilling coolant**

Coolant helps keep the gasoline engine at the proper operating temperature. The heat transferred from the engine to the coolant can be used to warm the passenger compartment.

When refilling coolant, follow the instructions on the package and use the recommended amount of coolant. Never fill the cooling system with water only; this could lead to freezing, corrosion and engine damage.

**⚠ WARNING**

If the engine has been running, the coolant will be very hot. Allow the engine to cool before opening the coolant expansion tank. If this is not possible, open the cap very slowly to allow pressure to dissipate.

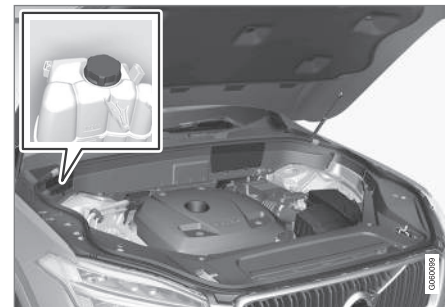

Coolant expansion tank

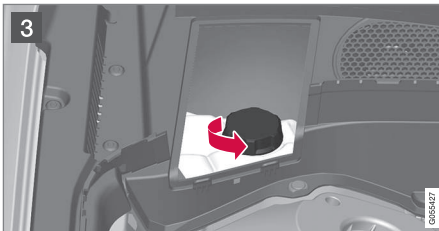
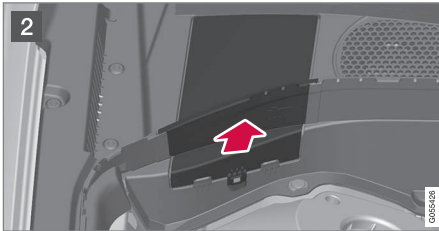
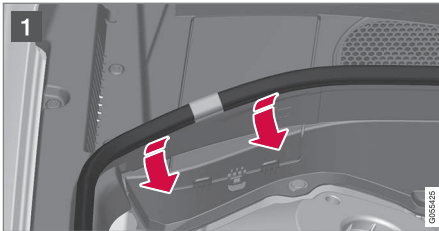

1 Lift the rubber strip by pressing it inward in the engine compartment.

2 Remove the plastic cover by folding out the catch and lifting the cover upward.

3 Unscrew the expansion tank cap and add coolant. The level should be between the **MIN** and **MAX** marks on the tank.

Put the other components back in place in the reverse order.

**! CAUTION**

- High levels of chlorine, chlorides and other salts may cause corrosion in the cooling system.
- Only use coolants with corrosion protection recommended by Volvo.
- The ratio of coolant to water is 50/50.
- Mix the coolant with tap water of drinkable quality.
- If maintenance is performed on the cooling system or if the coolant is replaced, flush the cooling system with clean water before adding new a new coolant/water mixture.
- The engine may only be operated with a properly filled cooling system. Otherwise, high temperatures and cracks in the cylinders may occur.

**Related information**

- Coolant specifications (p. 541)

**Refilling the windshield washer fluid reservoir**

Washer fluid helps keep the windshield and headlights clean.

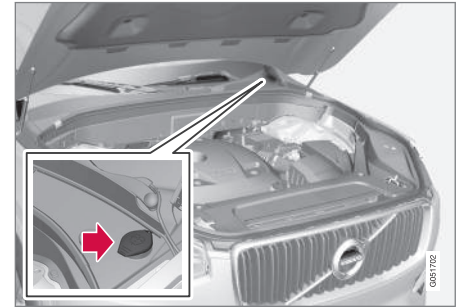

The windshield and headlight washers\* share a common reservoir. Open the blue cap to refill washer fluid (see the illustration for the location of the reservoir).

During cold weather, the reservoir should be filled with windshield washer solvent containing anti-freeze. Use Volvo Original Washer Fluid or the equivalent with a recommended pH value between 6 and 8 in a 1:1 solution.

When there is approx. 1 qt (1 liter) of washer fluid remaining in the reservoir, a text message and the  symbol will be displayed in the instrument panel.



◀◀ **Volume:**

- Models **with** headlight washers: 5.8 qts (5.5 liters).
- Models **without** headlight washers: 3.7 qts (3.5 liter).

**Related information**

- Opening and closing the hood (p. 514)
- Engine compartment overview (p. 515)

**Cleaning the exterior**

The vehicle should be washed at regular intervals since dirt, dust, insects and tar spots adhere to the paint and may cause damage. To help prevent corrosion, it is particularly important to wash the car frequently in the wintertime.

**Hand washing**

The following points should be kept in mind when washing and cleaning the vehicle:



**CAUTION**

Avoid using car washing detergents with a pH value lower than 3.5 or higher than 11.5. Doing so could result in discoloring of anodized aluminum surfaces on e.g., roof rails or the frames around the side windows.

- Avoid washing your vehicle in direct sunlight. Doing so may cause detergents and wax to dry out and become abrasive. To avoid scratching, use lukewarm water to soften the dirt before you wash with a soft sponge, and plenty of sudsy water.
- **Bird droppings:** Remove from paintwork as soon as possible. Otherwise the finish may be permanently damaged.
- A car washing detergent can be used to facilitate the softening of dirt and oil.

- Dry the vehicle with a clean chamois and remember to clean the drain holes in the doors and rocker panels.
- Tar spots can be removed with tar remover after the vehicle has been washed.
- A stiff-bristle brush and lukewarm soapy water can be used to clean the wiper blades. Frequent cleaning of the windshield and wiper blades improves visibility considerably and also helps prolong the service life of the wiper blades.
- Wash off the dirt from the underside (wheel housings, fenders, etc).
- In areas of high industrial fallout, more frequent washing is recommended.



**! CAUTION**

- During high pressure washing, the spray mouthpiece must never be closer to the vehicle than 13" (30 cm). Do not spray into the locks.
- Dirt, snow, etc., on the headlights can reduce lighting capacity considerably. Clean the headlights regularly, for example when refueling.

**Special laminated panoramic roof cautions:**

- Always close the laminated panoramic roof and sun shade before washing your vehicle.
- Never use abrasive cleaning agents on the laminated panoramic roof.
- Never use wax on the rubber seals around the laminated panoramic roof.

**i NOTE**

When washing the vehicle, remember to remove dirt from the drain holes in the doors and sills.

**Automatic car washes**

- We do NOT recommend washing your vehicle in an automatic wash during the first few

months (because the paint will not have hardened sufficiently).

- An automatic wash is a simple and quick way to clean your vehicle, but it is worth remembering that it may not be as thorough as when you yourself go over the vehicle with sponge and water. Keeping the underbody clean is most important, especially in the winter. Some automatic washers do not have facilities for washing the underbody.

**i NOTE**

Condensation may form temporarily on the inside of the lenses of exterior lights such as headlights or taillights. This is normal and the lights are designed to withstand moisture. Normally, condensation will dissipate after the lights have been on for a short time.

**! CAUTION**

When using an automatic car wash in which the vehicle has to be able to roll freely, the auto-hold brake function must be deactivated. If this is not done, the brakes will automatically be applied when the vehicle is stationary.

To deactivate this function:

1. Drive the vehicle into the car wash
2. Turn off the auto-hold function using the control on the center console
3. Turn off the parking brake's automatic function in the center display's Top view (tap **Settings**, tap **My Car** → **Parking Brake and Suspension** and deselect **Auto Activate Parking Brake**)
4. Put the gear selector in **N**
5. Switch off the ignition by turning the start knob to **STOP** and holding it in this position for at least 4 seconds

The vehicle will then be able to roll freely.





**! CAUTION**

- Before driving into an automatic car wash, turn off the optional rain sensor to avoid damaging the windshield wipers.
- Make sure that side view mirrors, auxiliary lamps, etc, are secure, and that any antenna(s) are retracted or removed. Otherwise there is risk of the machine dislodging them.
- **Chromed wheels:** Clean chrome-plated wheels using the same detergents used for the body of the vehicle. Aggressive wheel-cleaning agents can permanently stain chrome-plated wheels.

**! WARNING**

- When the vehicle is driven immediately after being washed, apply the brakes, including the parking brake, several times in order to remove any moisture from the brake linings.
- Engine cleaning agents should not be used when the engine is warm. This constitutes a fire risk.

**Exterior components**

Volvo recommends the use of special cleaning products, available at your Volvo retailer, for cleaning colored plastic, rubber, or ornamental

components such as chromed strips on the exterior of your vehicle. The instructions for using these products should be followed carefully. Solvents or stain removers should not be used.

The frames around the side windows, roof rails and door frames near the windows\* are made of anodized aluminum and should only be washed with a cleaning product with a pH value between 3.5 till 11.5.



Components that should be washed with a cleaning product with a pH value between 3.5 till 11.5 (generic illustration)

**! CAUTION**

- Avoid waxing or polishing plastic or rubber components
- Polishing chromed strips can wear away or damage the surface
- Polishes containing abrasive substances should not be used

**Related information**

- Paint damage (p. 528)
- Corrosion protection (p. 527)
- Polishing and waxing (p. 529)
- Windshield wipers in the service position (p. 518)

## Cleaning the interior

Only use cleaning agents and car care products recommended by Volvo. Clean regularly and follow the instructions included with the car care product.

### ! CAUTION

- Under no circumstances should gasoline, naphtha or similar cleaning agents be used on the plastic or the leather since these can cause damage.
- Take extra care when removing stains such as ink or lipstick since the coloring can spread.
- Use solvents sparingly. Too much solvent can damage the seat padding.
- Start from the outside of the stain and work toward the center.
- Sharp objects (e.g. pencils or pens in a pocket) or Velcro fasteners on clothing may damage the textile upholstery.
- Clothing that is not colorfast, such as new jeans or suede garments, may stain the upholstery.

## Fabric upholstery and ceiling liner

Clean with soapy water or a detergent. For more difficult spots caused by oil, ice cream, shoe polish, grease, etc., use a clothing/fabric stain remover. Consult your Volvo retailer.

## Leather\* care

Volvo's leather upholstery is manufactured with a protectant to repel soiling. Over time, sunlight, grease and dirt can break down the protection. Staining, cracking, scuffing, and fading can result.

Volvo offers an easy-to-use, non-greasy leather care kit formulated to clean and beautify your vehicle's leather, and to renew the protective qualities of its finish. The cleaner removes dirt and oil buildup. The light cream protectant restores a barrier against soil and sunlight.

Volvo also offers a special leather softener that should be applied after the cleaner and protectant. It leaves leather soft and smooth, and reduces friction between leather and other finishes in the vehicle.

Volvo recommends cleaning, protecting and conditioning your vehicle's leather two to four times a year. Ask your Volvo retailer about Leather Care Kit 951 0251 and Leather Softener 943 7429.

## Cleaning leather upholstery

1. Pour leather cleaner on a damp sponge and squeeze it until the cleaner foams.
2. Apply the foam to the stain by moving the sponge with circular movements.
3. Dampen the stain thoroughly with the sponge. Let the sponge absorb the stain, do not rub.
4. Dry the stain with soft paper towels or a towel, and allow the leather to dry completely.

## Protecting leather upholstery

1. Put a small amount of protectant cream on a cloth and apply a thin coating of cream to the upholstery with light circular movements.
2. Allow the leather to dry for 20 minutes.

This will help the leather resist staining and protect against sunlight's harmful UV rays.

## Cleaning a leather-covered steering wheel

- Remove soil, dust, etc., with a damp sponge and a neutral soap solution.
- Leather should be allowed to breathe. Never cover the steering wheel with a plastic protector.
- Volvo recommends cleaning, protecting and conditioning the steering wheel with Volvo's Leather Care Kit 951 0251 and Leather Softener 943 7429.

## If there are stains on the steering wheel:

### Type 1 (ink, wine, coffee, milk, sweat or blood)

- Use a soft cloth or sponge. Wipe the wheel with a solution with 5% ammonia. For blood stains, mix approx. 1 cup (2 dl) of water and one ounce (25g) of salt and wipe the stain.

### Type 2 (fat, oil, sauces, or chocolate)

1. Same procedure as for type 1 stains.



- ◀ 2. Finish by rubbing the wheel with absorbent paper or a towel.

**Type 3** (dry soil or dust)

1. Remove the soil/dust with a soft brush.
2. Same procedure as for type I stains.

**!** **CAUTION**

Sharp objects, such as rings, could damage the leather on the steering wheel.

**Leather panels\***

Leather should be allowed to breath. Never cover the upper side of the dashboard or door panels with a plastic protector. Ask your Volvo retailer about Leather Care Kit 951 0251 and Leather Softener 943 7429.

**Spots on interior plastic, metal, or wood surfaces**

Cleaning interior plastic components should be done with a moist microfiber cloth. Consult your Volvo retailer.

**!** **CAUTION**

- Do not use cleaning agents with high alcohol content such as washer fluid to clean instrument panel glass.
- Never spray cleaning agents or water directly onto components with electrical buttons or controls. Clean components of this type by applying the cleaning agent/water sparingly to a cloth and wiping the components so that no liquid penetrates into these components.

**Cleaning the seat belts**

Clean only with lukewarm water and a mild soap solution.

**Cleaning floor mats**

The floor mats should be vacuumed or brushed clean regularly, especially during winter when they should be taken out for drying. Spots on textile mats can be removed with a mild detergent. For best protection in winter, Volvo recommends the use of Volvo rubber floor mats. Consult your Volvo retailer.

**!** **WARNING**

- Never use more than one floor mat at a time on the driver's floor. Before driving, remove the original mat from the driver's seat floor before using any other type of floor mat. Any mat used in this position should be securely and properly anchored in the attaching pins. An extra mat on the driver's floor can cause the accelerator and/or brake pedal to catch. Check that the movement of these pedals is not impeded.
- Volvo's floor mats are specially manufactured for your car. They must be firmly secured in the clips on the floor so that they cannot slide and become trapped under the pedals on the driver's side.

**Related information**

- Cleaning the center display (p. 527)

## Cleaning the center display

Marks, stains, etc., on the center display may affect its performance and readability. Clean it regularly with a microfiber cloth.



Center display's Home button

To clean the center display:

1. Turn off the display by pressing and holding the Home button.
2. Wipe the screen clean with the microfiber cloth provided or use a similar one, using a small, circular motion. If necessary, moisten the cloth slightly.
3. Reactivate the display by pressing the Home button briefly.

### **!** CAUTION

- The microfiber cloth used should be free of sand, dirt or anything abrasive that might scratch the screen.
- Do not use rough cloths, paper towels or tissues that could scratch the screen.
- When cleaning the center display, apply only light pressure on the screen. Pressing too hard could cause damage.
- Do not spray any liquid or corrosive chemicals directly on the screen. Do not use window cleaning liquid, cleaning agents (particularly ones containing abrasives), sprays, solvents, alcohol or ammonia to clean the screen.

### Related information

- Cleaning the interior (p. 525)
- Center display overview (p. 28)

## Corrosion protection

Your vehicle is constructed with effective protection against corrosion.

### Inspection and maintenance

The corrosion protection does not normally require maintenance but keeping the vehicle clean helps prevent the onset of corrosion. The use of strong alkaline or acidic cleaning fluids should always be avoided on shiny body components. Any stone chips in the paint should be touched up as soon as possible.

### Related information

- Paint damage (p. 528)
- Touching up paint damage (p. 529)

## Paint damage

Paint damage requires immediate attention to avoid rusting. Make it a habit to check the finish regularly, for instance washing the vehicle. Touch-up if necessary.

Paint repairs require special equipment and skill. Contact your Volvo retailer for any extensive damage.

Minor scratches can be repaired by using Volvo touch-up paint.

## Color code

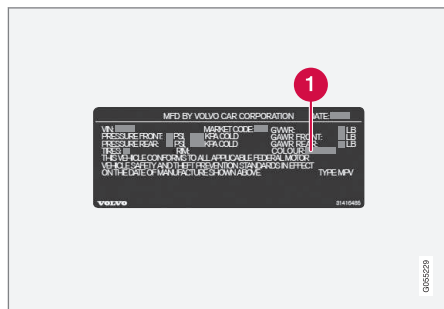

1 Sample color code (1): US models

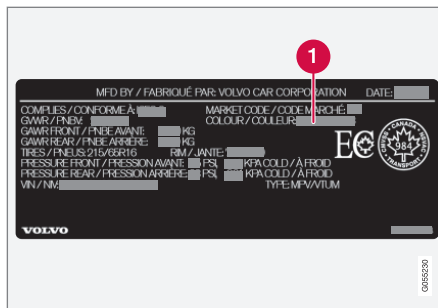

1 Sample color code (1): Canadian models

Make sure you have the right color. See also the article "Label information" for the location of this label.

## Minor stone chips and scratches

Material:

- Primer – can
- Paint – touch-up pen
- Brush
- Masking tape
- Emery cloth

If the stone chip has not gone down to the bare metal and an undamaged color coat remains, you can add paint immediately after removing dirt.

**NOTE**

When touching up the vehicle, it should be clean and dry. The surface temperature should be above 60 °F (15 °C).

## Related information

- Label information (p. 532)
- Touching up paint damage (p. 529)

## Touching up paint damage

Stone chips or other minor paint damage can be repaired by the vehicle's owner.

### Repairing stone chips

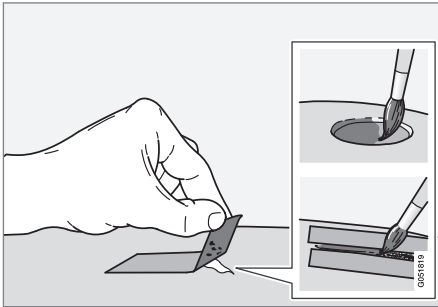

1. Place a strip of masking tape over the damaged surface. Pull the tape off so that any loose flakes of paint adhere to it.
2. Thoroughly mix the primer and apply it with a small brush.
3. When the primer surface is dry, the paint can be applied using a brush. Mix the paint thoroughly; apply several thin paint coats and let dry after each application.
4. If there is a longer scratch, you may want to protect surrounding paint by masking it off.
5. After a few days, polish the touched-up areas. Use a soft rag and a small amount of polish.

### Related information

- Paint damage (p. 528)
- Cleaning the exterior (p. 522)

## Polishing and waxing

Normally, polishing is not required during the first year after delivery, however, waxing may be beneficial.

- Before applying polish or wax the vehicle must be washed and dried. Tar spots can be removed with kerosene or tar remover. Difficult spots may require a fine rubbing compound.
- After polishing use liquid or paste wax.
- Several commercially available products contain both polish and wax.
- Waxing alone does not substitute for polishing a dull surface.
- A wide range of polymer-based waxes can be purchased today. These waxes are easy to use and produce a long-lasting, high-gloss finish that protects the bodywork against oxidation, road dirt and fading.
- Do not polish or wax your vehicle in direct sunlight (the surface of the vehicle should not be warmer than 113 °F (45 °C)).





**! CAUTION**

Volvo does not recommend the use of long-life or durable paint protection coatings, some of which may claim to prevent pitting, fading, oxidation, etc. These coatings have not been tested by Volvo for compatibility with your vehicle's clear coat. Some of them may cause the clear coat to soften, crack, or cloud. Damage caused by application of paint protection coatings may not be covered under your vehicle's paint warranty.

Do not use metal polishing agents on anodized aluminum surfaces. Doing so could result in discoloring and damage the surface finish.

**Related information**

- Paint damage (p. 528)
- Touching up paint damage (p. 529)



SPECIFICATIONS

## SPECIFICATIONS

### **Label information**

The labels in your vehicle provide information such as the chassis number, paint code, tire inflation pressure, etc.

Location of labels

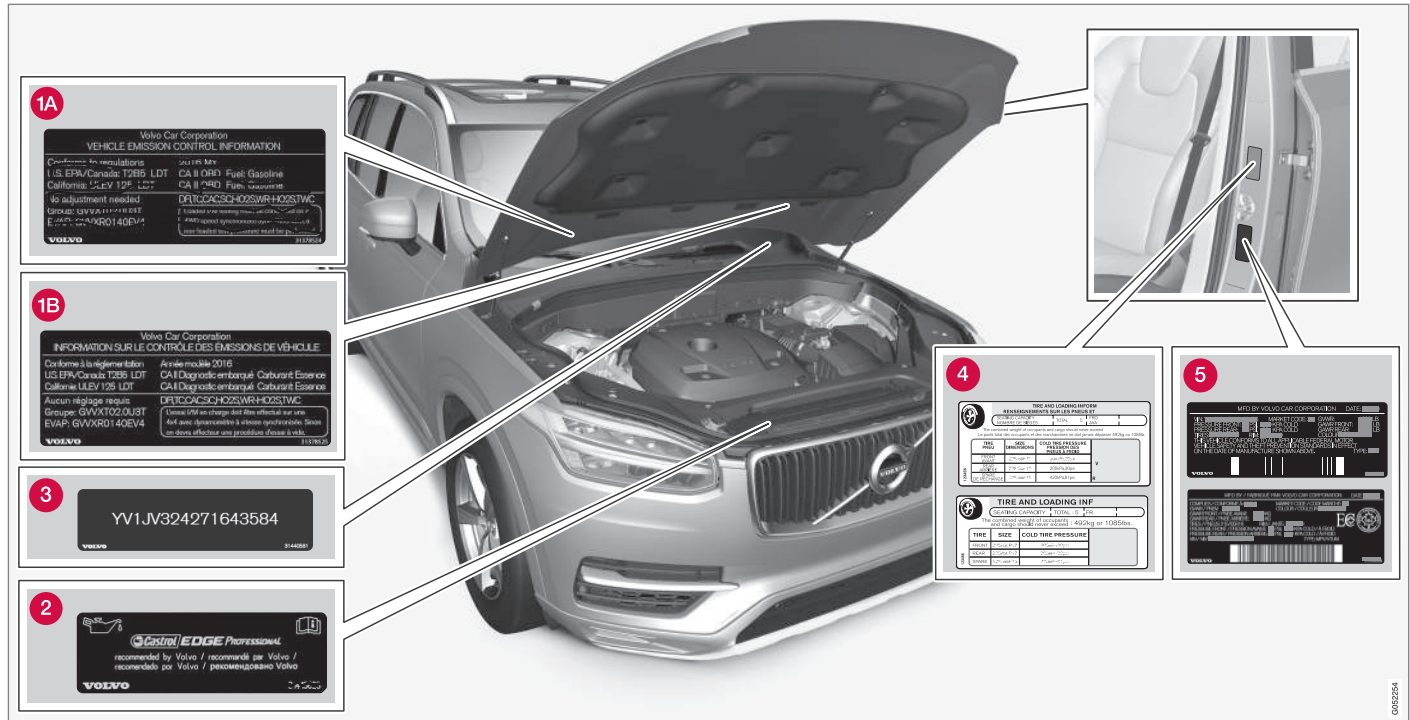

List of labels

- 1 Vehicle Emission Control Information. (A) US models, (B) Canadian models. Your Volvo

is designed to meet all applicable emission standards, as evidenced by the certification label on the underside of the hood. For fur-

ther information regarding these regulations, please consult your Volvo retailer.



## SPECIFICATIONS

- ◀◀ **2 Engine oil.** This label contains the recommended engine oil specifications.
- 3 Vehicle Identification Number (VIN).** The VIN plate is located on the top left surface of the dashboard. The Vehicle Identification Number (VIN) should always be quoted in all correspondence concerning your vehicle with the retailer and when ordering parts.
- 4 Tire inflation pressures.** This label indicates the correct inflation pressures for the tires that were on the vehicle when it left the factory.
- 5 Federal Motor Vehicle Safety Standards (FMVSS) specifications (USA) and Ministry of Transport (CMVSS) standards (Canada).** Your Volvo is designed to meet all applicable safety standards, as evidenced by the certification label on the driver's side B-pillar (the structural member at the side of the vehicle, at the rear of the driver's door opening). This label also includes codes for paint color, etc. For further information regarding these regulations, please consult your Volvo retailer. U.S. models have the upper decal; Canadian models have the lower one.

## Dimensions

The following table lists your vehicle's most important dimensions.

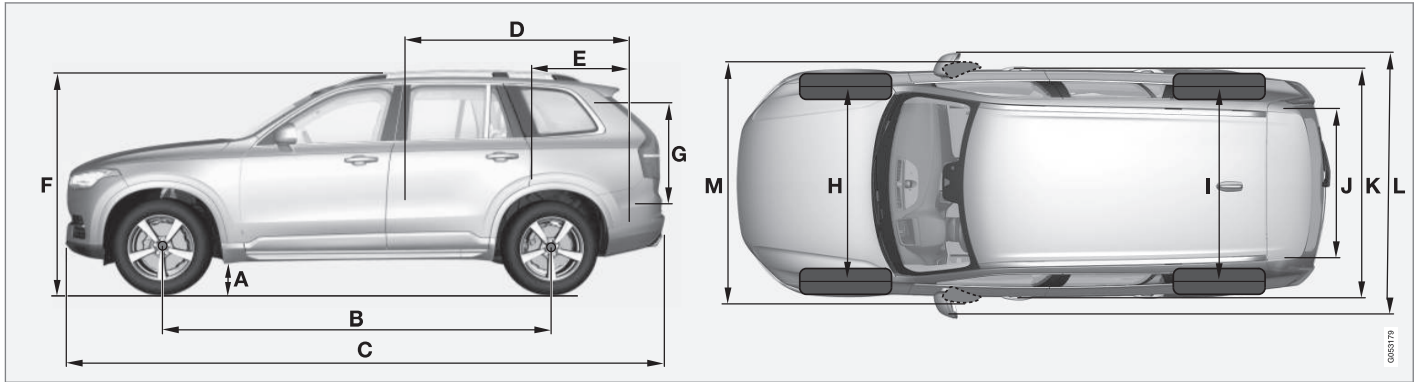

Dimension	In. (mm)
A Ground clearance (curb weight + 2 people) <sup>A</sup>	8.9 (227)
B Wheelbase	117.5 (2984)
C Length	194.9 (4950)
D Load length, floor, seat-back down	80.3 (2040)
	49.6 (1260) <sup>B</sup>

Dimension	In. (mm)
E Load length, floor	48.0 (1220) <sup>C</sup> 21.8 ( 554) <sup>D</sup>
F Height	69.9 (1776)
G Load height	32.1 (816)

Dimension	In. (mm)
H Track, front (models without pneumatic suspension)	65.9 (1673) <sup>E</sup>
	65.6 (1665) <sup>F</sup>
Track, front (models with pneumatic suspension)	66.0 (1676) <sup>E</sup>
	65.7 (1668) <sup>F</sup>



## SPECIFICATIONS



	<b>Dimension</b>	<b>In. (mm)</b>
I	Track, rear (models without pneumatic suspension)	65.8 (1675) <sup>E</sup> 66.1 (1667) <sup>F</sup>
	Track, rear (models with pneumatic suspension)	66.1 (1679) <sup>E</sup> 65.8 (1671) <sup>F</sup>
J	Load width, floor	46.9 (1192)
K	Width	75.7 (1923) <sup>G</sup>
		76.0 (1931) <sup>H</sup>
		77.1 (1958) <sup>I</sup>
L	Width incl. door mirrors (folded out)	84.3 (2140)
M	Width incl. door mirrors (folded in)	79.1 (2008)

A Varies slightly depending on tire size, chassis options, etc.

B From the second row of seats in 7-seat models\*.

C 5-seat model

D 7-seat model

E Models with 20, 21 and 22 in. wheels.

F Models with 18 and 19 in. wheels.

G Chassis width.

H Width on models with 18 and 19 in. wheels.

I Width on models with 20, 21 and 22 in. wheels.

### Related information

- Weights (p. 537)

## Weights

The following table lists important weight data for your vehicle.

Category	USA	Canada
<b>Gross vehicle weight</b>		
7-seat, 4-cyl. AWD (All Wheel Drive)	6,060 lbs	2,750 kg
7-seat 4-cyl. FWD (Front Wheel Drive)	6,005 lbs	2,725 kg
5-seat, 4-cyl. AWD	6,005 lbs	2,725 kg
5-seat 4-cyl. FWD	6,005 lbs	2,725 kg
4-seat, 4-cyl. AWD	-	2,725 kg
<b>Capacity weight</b>		
7-seat, 4-cyl.	1,210 lbs	550 kg
5-seat, 4-cyl.	1,100 lbs	500 kg
4-seat, 4 cyl. AWD	-	500 kg
<b>Permissible axle weights, front</b>		
7-seat, 4-cyl. AWD	2,885 lbs	1,310 kg
7-seat, 4-cyl. FWD	2,865 lbs	1,300 kg
5-seat, 4-cyl. AWD	2,865 lbs	1,300 kg
5-seat, 4-cyl. FWD	2,865 lbs	1,300 kg
4-seat, 4-cyl. AWD	-	1,300 kg



SPECIFICATIONS



Category	USA	Canada
<b>Permissible axle weights, rear</b>		
7-seat, 4-cyl. AWD	3,280 lbs	1,490 kg
7-seat, 4-cyl. FWD	3,280 lbs	1,490 kg
5-seat, 4-cyl. AWD	3,280 lbs	1,490 kg
5-seat, 4-cyl. FWD	3,280 lbs	1,490 kg
4-seat, 4-cyl. AWD	-	1,470 kg
<b>Curb weight</b>		
7-seat, 4-cyl.	4,370 - 4,680 lbs	1,980 - 2,130 kg
5-seat, 4-cyl.	4,290 - 4,530 lbs	1,940 - 2,060 kg
4-seat, 4 cyl.	-	2,130 - 2,140 kg
<b>Max. roof load</b>	220 lbs	100 kg



Category	USA	Canada
<b>Max. trailer weights</b>	Without brakes: 1,650 lbs With brakes (AWD): 5,000 lbs With brakes (FWD): 4,000 lbs	Without brakes: 750 kg With brakes (AWD): 2,250 kg With brakes (FWD): 1,800 kg
<b>Max. tongue weight</b>	AWD: 500 lbs FWD: 400 lbs	AWD: 225 kg FWD: 180 kg

**!** **CAUTION**

- When loading the vehicle, the maximum gross vehicle weight and permissible axle weights may not be exceeded.
- The maximum trailer weights listed are only applicable for altitudes up to 3280 ft (1,000 m) above sea level. With increasing altitude the engine power and therefore the car's climbing ability are impaired because of the reduced air density, so the maximum trailer weight has to be reduced accordingly. The weight of the car and trailer must be reduced by 10% for every further 3280 ft (1,000 m) (or part thereof).

## SPECIFICATIONS

### Air conditioning refrigerant

The air conditioning system in your car contains a CFC-free refrigerant.

#### A/C decal

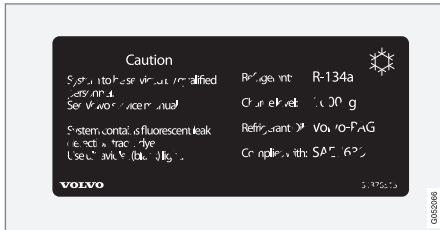

R134a decal

#### Refrigerant

Weight	Type
1.7 lbs (775 g)	R134a
2.2 lbs (1000 g) on models with A/C for the third row of seats*	

#### **⚠ WARNING**

The air conditioning system contains R134a refrigerant under pressure. Service and repairs may only be carried out by a trained and qualified Volvo service technician.

### Compressor oil

Volume	Type
2.0 fl. oz. (60 ml)	PAG SP-A2
2.7 fl. oz. (80 ml) on models with A/C for the third row of seats*	

### Evaporator

The A/C system's evaporator may never be repaired or replaced with a previously used evaporator. A new evaporator must be certified and marked according to SAE J2842.

### Related information

- Climate system service (p. 487)

### Brake fluid specification and volume

Brake fluid transfers braking force when the brake pedal is depressed to the master cylinder and to the slave cylinders on each wheel.

Topping up or replacing brake fluid should only be done by a trained and qualified Volvo service technician.

**Specification:** Volvo Original Dot 4 class 6 or equivalent

### Related information

- Engine compartment overview (p. 515)

**Coolant specifications**

Coolant specifications.

Specification: Coolant with corrosion inhibitor mixed with water (50/50 mix), see packaging.

Consult a Volvo retailer if you are uncertain.

Different types of coolant should not be mixed to help avoid health risks.

SPECIFICATIONS

**Engine specifications**

The following table provides technical data for the respective engines. Engine specifications for Special Edition vehicles may vary.

**Not all engines listed here are available in all markets.**

Specification	T6 AWD
Engine designation	B4204T27
Output (kW/rps)	235/95
Output (hp/rpm)	316/5700
Torque (Nm/rps)	400/37-90
Torque (ft. lbs./rpm)	295/2,200-5,400
No. of cylinders	4

Specification	T6
Engine designation	B4204T23
Output (kW/rps)	187/92
Output (hp/rpm)	250/5,500
Torque (Nm/rps)	350/25-80
Torque (ft. lbs./rpm)	258/1,500-4,800
No. of cylinders	4

**Related information**

- Engine oil specifications and volume (p. 544)
- Coolant specifications (p. 541)

## SPECIFICATIONS

### Engine oil specifications and volume

Full synthetic engine oil meeting the minimum ACEA A5/B5 must be used. Lower quality oils may not offer the same fuel economy, engine performance, or engine protection.

Volvo recommends:



Refer to the warranty and Service Records information booklet for information on oil change intervals and oil type requirements.

#### **i** NOTE

This vehicle comes from the factory with synthetic oil.

**Oil additives must not be used.**

### Oil viscosity

Incorrect viscosity oil can shorten engine life under normal use. SAE 5W-30 will provide good fuel economy and engine protection. See the viscosity chart.

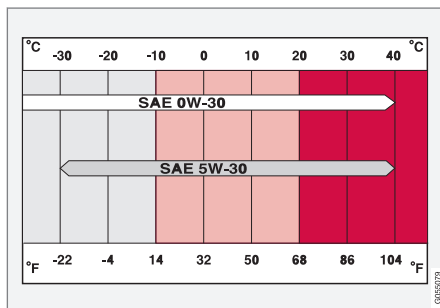

Viscosity chart

### Extreme engine operation

Volvo oil VCC RBS0-2AE/SAE 0W20 is recommended for extreme driving conditions.

### Oil volume

The oil volume for the engine is:

6.2 US qts (5.9 liters).

### Related information

- Checking and refilling engine oil (p. 517)

### Fuel tank volume

The fuel tank's volume is shown below.

The fuel tank's refillable volume is approx. 18.8 US gallons (71 liters).

### Related information

- Octane rating (p. 372)
- Opening/closing the fuel filler door (p. 373)

## Tire inflation pressure table

The following tire pressures are recommended by Volvo for your vehicle. Refer to the tire infla-

tion placard for information specific to the tires installed on your vehicle at the factory.

Tire sizes: XC90	Cold tire pressure for up to five or seven persons (depending on seating capacity)	
	Front psi (kPa)	Rear psi (kPa)
235/60 R18 235/55 R19 275/45 R20 275/40 R21 275/35 R22	38 (260)	38 (260)
Temporary spare tire T125/80 R18	60 (420)	60 (420)

### Related information

- Checking tire inflation pressure (p. 460)

## SPECIFICATIONS

### **Transmission fluid specification and volume**

Under normal driving conditions the transmission fluid does not need to be changed during its service life. However, it may be necessary under adverse driving conditions.

Transmission: TG-81SC

Specification: Transmission fluid AW-1



# INDEX

## A

---

A/C (air conditioning)	197
Accessory installation warning	21, 24
Active high beams	142
Active yaw control	251
Adaptive brake lights	358
Adaptive cruise control	269, 272, 273, 275, 276, 277, 281
passing assistance	277
pilot assist	295
Adaptive Cruise Control	
fault tracing	279
limitations	280
Airbags	
disconnecting the front passenger's	
side	69
front	65, 66
inflatable curtain	73
side impact	72
Air conditioning	197
Air distribution	201, 202
Air distribution table	204
Air filter	185
Air quality	183
Air quality sensor	183
Air vents	201, 202

Alarm	245
automatically arming/disarming	244
Deactivating	246
All Wheel Drive	397
Ambient temperature sensor	114
Android Auto	430
settings	431
Antennas	
passive entry system	236
Anti-freeze	367
Apple CarPlay	428, 429
Applications (apps)	402
App menu	155
Approach lighting	150
Apps	
changing settings	43, 113
Apps (applications)	441
Audio system	402
HD digital radio	406, 408, 409
SiriusXM® Satellite radio	410, 411, 412
sound settings	403, 436
voice control	119
Auto-hold brakes	356
Automatic locking retractor	77

Automatic transmission	
Eco (driving function)	387
gear shift indicator	394
general description	392, 394
oil	546
shifting with steering wheel paddles	396
shiftlock override	393
Axle weight	458

## B

---

Battery	
avoiding drain	382
remote key, replacing	225
support battery	490
warning symbols	491
Battery – replacing	488
Blind Spot Information	317, 318, 319
Bluetooth	
connecting devices	421
Bluetooth®	
hands-free	420
media	426, 435
microphone	422
streaming audio	435
Bluetooth cell phone connection	422
Booster cushion, integrated	87, 89, 90

## INDEX

Booster cushions	83	Cargo space	208	infant seats	79
Brake assist system	357	Car wash	522	ISOFIX/LATCH anchors	84
Brake lights	146, 358	Catalytic converter	374	top tether anchors	86
Brakes		CD, USB, iPod, AUX, Bluetooth, Recents, Library, Shuffle, Similar, Change device, Audio Language, Off, Subtitle Language, Video, DivX® VOD	432	Child safety	75
auto-hold	356	CD player	432	booster cushions	83
Brake system		Cell phone		child restraint systems	77, 85
Brake pad inspection	355	hands-free	419	convertible seats	81
fluid	540	Pairing	420	infant seats	79
general information	354, 356, 357	Cell phone voice control	120	Child safety locks	246
Bulbs	510	Center display		Child seats	
replacing	505	changing settings	30	lower attachment points	85
specifications	511	cleaning	527	City safety	304, 312
		keyboard	31	City Safety	
		navigating in	38	crossing traffic	309
		overview	28	detecting objects	307
		screen in the center console	44	limitations	312
		symbols in the status bar	43	rear collision warning	316
		Chains	459	symbols and messages	315
		Changing a wheel	462	troubleshooting	310
		Child restraints		City Safety, On/Off	306
		recalls and registration	77	City Safety™	
		Child restraint systems	77	Multi Target	310
		booster cushions	83	Cleaning	
		convertible seats	81	exterior	522
				interior	525
				Clean Zone Interior Package	184
				Climate system	186
				air distribution	201, 202, 204

## C

Camera	
driver support systems	300
limitations	301
Camera, Park Assist	340, 342, 344, 345
Capacity weight	458, 537
Cargo area, steel grid	215
Cargo area cover	217
Cargo compartment	
fuses	502
raising/lowering the level	208
Cargo net	213



## INDEX

Engine	
overheating	366
Start/Stop	389, 391
starting	382
turning off	384
Engine compartment	
fuses	494
Engine compartment overview	515
Engine oil	544
checking	516, 517
Engine specifications	542
Environment	15
Eyelet	
towing	367
Eyelets for anchoring loads	216
<b>F</b>	
Federal Clean Air Act	480
Flat tires	
repairing with tire sealing system	471, 473, 477
Floor mats	
placing correctly	382
Fluid specifications	540, 541, 546

Fog lights	
front	144
rear	145
Front airbags	65, 66
disconnecting passenger's side airbag	69
Front fog lights	144
Front park assist	336, 337, 338, 339
Front seats	
heated	198
multifunctional	166
power	163, 165
Front seats, manual adjustment	162
Fuel	
Travel Link service	417
Fuel filler door, opening	373
Fuel requirements	371, 372
Function view	36
Fuses	492
cargo compartment	502
engine compartment	494
passenger compartment	498
Fuses, replacing	493, 494, 498, 502

## G

Garage door opener	
HomeLink® Wireless Control System	98, 99
Gasoline requirements	371, 372
Glossary of tire terminology	456
Glove compartment	211
Grocery bag holder	213
Gross vehicle weight	458
Gross vehicle weight (GVW)	537

## H

Hand brake (parking brake)	360, 361, 363
Hazard warning flashers	146
HD digital radio	406, 408, 409
Headlights	
Active Bending Lights	143
active high beams	142
daytime running lights	138, 140
high/low beams	142
high beam flash	142
removing cover	507
Headlight washers	158
Head restraint - center, rear	170

Head restraints, rear seat	170	Inflation pressure	460	Interior lighting	147
Head-up display	116	Inflation pressure table	545	Internet connection	439
Heated front seats	198	Information lights	135	applications (apps)	402
Heated oxygen sensors	374	Infotainment	449	bluetooth settings	441
Heated steering wheel	197	Infotainment (Infotainment system)	402	booking service	484
High beam bulb, replacing	509	Infotainment system	406, 408, 409	establishing a connection	439
High beams	142	CD player	432	troubleshooting	442
active	142	cell phone	419	ISOFIX/LATCH anchors	84
Hill Descent Control	358	general sound settings	403		
Hill Start Assist (HSA)	360	Gracenote	436	<b>J</b>	
Hoisting the vehicle	512	introduction	402	<hr/>	
HomeLink® Wireless Control System	98, 99	media player	426, 432	Jack	462
Home safe lighting	150	media player sound settings	436	location of	462, 465
Hood, opening/closing	514	media search	434	Jump starting	370, 374
Horn, Keypad, Paddles, Signal	160	radio	404		
		searching for radio stations	405	<b>K</b>	
		sound settings	403, 436	<hr/>	
		type approval	445	Key	
		video	437	remote	177, 227
		voice control	119	Key blade	231, 243
		Inspection readiness	480	Keys	230
		Instrument lighting	139		
		Instrument overview	94		
		Instrument panel	124		
		settings	126		
		Intellisafe	16		
		Interior Air Quality System	185		
<b>I</b>					
<hr/>					
ID, Volvo	27				
Ignition modes	380				
Immobilizer (start inhibitor)	224				
Indicator lights	135				
Infant seats	79				
Inflatable Curtain	73				

## INDEX

### L

---

Labels	
list of	533
location of	533
Laminated panoramic roof	103, 104
Lane Keeping Aid	328, 331
settings	330
LATCH anchors	84
Leather care	525
Lighting panel	138
Load anchoring eyelets	216
Loading the vehicle	208, 458
Locking	233, 235
Locks and alarm	224
Low beam bulb, replacing	508
Low beams	141, 142
Low Speed Control	359

### M

---

Maintenance	480
hoisting the vehicle	512
performed by the owner	480
Malfunction indicator light	127
Manual front seat adjustment	162

Media player	426, 427
compatible file formats	437
Media player (infotainment system)	432
Menus	
instrument panel	150, 152, 154, 156
Mirrors	
defroster	194
power door	102
retractable	102
Mirrors, rearview mirror	108
Modem	444
Motor oil	
checking	516, 517
MP3 files	437
Multifunctional front seats	166
MY CAR	109, 110

### N

---

Navigation system	
voice commands	123
Net	
cargo	213

### O

---

Occupant safety	56
Occupant weight sensor	69
Octane recommendations	372
Odometer	95
Oil	
checking	516, 517
Oil quality	544
On-board diagnostics	480
On-board Diagnostic socket	21
On Call Roadside Assistance	14
Opening the hood	514
Option/accessory	48
Options	21
Outside temperature sensor	114
Overhead courtesy lighting	147
Overheating, engine	366
Owner's information	
mobile applications	20
Owner's manual	16
Ownership, changing	114
Oxygen sensors, heated	374

<b>P</b>		
<hr/>		
Paint, touching up	528, 529	
Park assist	336, 337, 338, 339	
Park Assist Camera	340, 342, 344, 345	
settings	340, 344	
Park Assist Pilot	346, 347, 350, 352	
Parking brake		
electric, applying/releasing	361, 363	
Parking light bulb, replacing	510	
Passenger compartment		
fuses	498	
Passive Entry system		
location of antennas	236	
Permissible axle weight	537	
Phone		
phone book	423	
receiving calls	422	
text messages	424, 426	
Pilot Assist	277, 283, 286, 289, 290,	
	292, 293	
Polishing	529	
Power front seat		
memory function	165	
Power mirrors	102	
defroster	194	
Power steering		
adjustable	250	
Power tailgate	240	
Power windows	107	
Pregnancy, using seat belts during	58	
PROPOSITION 65 WARNING	374	
<b>R</b>		
<hr/>		
Radar		
driver support systems	296, 300	
Radar sensor		
limitations	297	
Radio		
RBDS	405	
settings	404	
SiriusXM® Satellite radio	410, 411, 412	
Radio functions		
HD digital radio	406, 408, 409	
Rain sensor	157	
Rear Collision Warning	316	
Rear fog lights	145	
Rear park assist	336, 337, 338, 339	
Rear seat head restraints	170	
Rear seats	169	
accessing the third row	174	
adjusting backrest tilt	172	
center head restraint	170	
folding	173, 174, 175	
moving forward/rearward	171	
Rearview mirror		
compass	136, 137	
Rear window defroster	194	
Recalls	58	
Recalls, child restraints	77	
Recirculation (climate system)	194	
Refrigerant (A/C system)	540	
Refueling	371, 372	
fuel filler door	373	
Registering child restraints	77	
Remote key	227, 230, 237	
immobilizer	224	
linking to a driver profile	177	
range	229	
replacing the battery	225	
restricted (red) key	230	
Remote updates	483	
Replacing bulbs	505	
Replacing fuses	493, 494, 498, 502	
Reporting safety defects	57	
Roadside Assistance	14	
Road sign information (RSI)	324, 326	

## INDEX

Rollover Protection System (ROPS)	255	Sensus	17	deactivating/reactivating	260
Roll Stability Control (RSC)	255	Service		starting/activating	256
Run-off mitigation	333, 335	connected service booking	484	Spin control	251
<b>S</b>					
Safety, occupant	56	Settings view		Stability system	251
Safety defects, reporting	57	categories	110	sport mode	252
Safety locks, child	246	resetting	113	Start/Stop (engine function)	389, 391
Safety mode	74	system settings	112	Start and lock system	
Seat		Shiftlock		type designations	248
adjusting the passenger's seat from the driver's seat	164	override	393	Starting and driving	354
Seat belt		Side door mirrors	102	Starting the engine	382
reminder	64	Side impact airbags	72	Starting the vehicle	
Seat belts		Sirius Satellite radio		after a crash (crash mode)	74
Automatic locking retractor/Emergency locking retractor	77	Travel link	413	Start inhibitor (immobilizer)	224
buckling	62	SiriusXM® Satellite radio		Steel grid in cargo area	215
pretensioners	60, 61	traffic information	410, 411, 412	Steering wheel	160
reminder	64	Snow chains	459	adjusting	161
securing child restraint systems	79, 81, 83	Snow tires	459	heated	197
unbuckling	62	Sound settings		horn	160
use during pregnancy	58	media	436	keypad	160
using	60	ringtones	425	Steering wheel paddles	160
Seats		Sound settings, audio system	403, 436	Stone chips, touching up	528, 529
rear	169	Specifications		Storage compartments	210
		bulbs	511	Studded tires	459
		Speed camera alert	324	Sunroof	
		Speed limiter	255, 257, 261	laminated panoramic roof	103, 104
		automatic	257, 259	Sun shade	107, 109



Sun visor	219	Tire Pressure Monitoring System (TPMS)	470	Towing the vehicle	369
Suspension	398	Tires	452, 462	Traction control	251
System updates	482	changing	462	Trailer hitch	378
		changing from summer to winter	457	Trailer towing	376, 379
		glossary of terms	456	trailer hitch	378
		improving economy	452	Transmission	
		inflation pressure	460	gear shift indicator	394
		inflation pressure table	545	general description	392, 394
		installing (mounting) a wheel on the		Hill Start Assist	360
		vehicle	466	oil	546
		rotation	453	shifting with steering wheel paddles	396
		snow	459	shiftlock override	393
		spare	463	Travel Link	413
		specifications	454	Alerts	416
		storing	453	Fuel	417
		studded	459	Sports	418
		tire pressure monitoring system	467, 469	weather	415
		tire sealing system	471, 473, 477	Tread wear indicator	457
		tread wear indicator	457	Trip computer	95, 96, 97
		uniform tire quality grading	459	reset	96
		wheel bolts	464	Trip odometers	95
		Tire sealing system	471, 473, 477	Trips, long distance	363
		Top tether anchors (child restraint systems)	86	Trip statistics	97
		Touching up paint	528, 529	Turn signals	146
		Towbar	378	changing bulbs	509
		Towing a trailer	376, 379		
		trailer hitch	378		
		Towing eyelet	367		

## T

---

Tailgate					
locking/unlocking	238				
locking/unlocking (private locking)	242				
operating with the foot movement sensor	232				
power operated	240				
wiper/washer	159				
Tailgate wipers	519				
Technician certification	53				
Temperature					
perceived	182				
Temperature sensor					
ambient	114				
Temporary spare tire	463				
Tethering					
wi-fi sharing	443				
Three-way catalytic converter	374				
Tire inflation pressure	545				
Tire Pressure Monitoring System	467, 469				
calibrating	470				

## INDEX

### U

Uniform Tire Quality Grading	459
Unlocking the tailgate	238
Unlocking the vehicle	233, 235
USB/AUX connection	426, 435
User profile	175

### V

Vehicle Event Data	26
Vehicle information	14
Vehicle loading	208, 458
Vehicle maintenance	480
performed by the owner	480
Vehicle status	483
Vehicle weights	537
Voice control	
cell phones	120
giving commands	119
introduction	119
multimedia devices	121
radio	121
settings	124
Volvo and the environment	15
Volvo ID	27

Volvo maintenance	480
Volvo On Call Roadside Assistance	14
Volvo programs	14

### W

Warning flashers, hazard	146
Warning lights	135
Warning system, collision	305
Warranties	480
Washer fluid	521
Washers	
headlight	158
windshield	157
Water, driving through	365
Waxing	529
Weights	
trailer	376
Wheels	
changing	462, 465
storing	453
Whiplash Protection System	59
Wi-Fi	443, 444

Windows	
laminated glass	53
power	107
sun shade	107
Windshield	
rain sensor	157
washers	158
wipers/washers	157
Windshield washer fluid reservoir	521
Windshield wiper blades	519
Windshield wipers	
service position	518
Wiper blades	
replacing	518, 519
replacing tailgate wiper	519
WMA files	437
Workshop	
Wi-Fi connection	486



