

VOLVO
S60 & S60 R

VOLVO
for life

WEB EDITION



Volvo Service

Certain service measures, which affect the car's electrical system, can only be carried out using electronic equipment specially developed for your car. Always contact your Volvo workshop before beginning or carrying out service work which affects the electrical system.

Installing accessories

Incorrect connection and installation of accessories can negatively affect the car's electrical system. Certain accessories only function when the appropriate software has been programmed into the car's electrical system. Always contact your Volvo workshop before installing accessories which are connected to or affect the electrical system.

Recording vehicle data

One or several of the computers in your Volvo are capable of recording detailed information which may include specific – without being limited to – details regarding: frequency of seat belt use by the driver and passenger, information on various vehicle system/module functions and information regarding engine, throttle, steering, brakes and other system status.

This information may include details regarding the manner in which the driver operates the vehicle. This type of information can include specific – without being limited to – details regarding vehicle speed, use of the brakes, accelerator pedal or steering wheel position. This information can be stored while the car is being driven, during a collision or a near-collision.

The stored information may be read and used by:

- Volvo Car Corporation
- Service and repair facilities
- Police and other authorities
- Other interested parties who are entitled – or receive your permission for – access to this information.

Introduction



Contents

This owner's manual offers you advice and tips on how your car works and how it should be maintained. There is also important information regarding the safety of you and your passengers.

In addition to standard equipment, this manual also describes equipment that is optional or an accessory. Certain countries may have statutory requirements that affect the level of equipment.

The owner's manual is used as follows

Use this owner's manual to look for specific information and to better acquaint yourself with the functions of the car. This owner's manual will help you enjoy your new Volvo to the best possible extent.

The alphabetical index at the back of the manual can be used to search for words and corresponding page numbers, where you can read more information.

The specifications, design features and illustrations in this Owner's Manual are not binding. We reserve the right to make modifications without prior notice.

©Volvo Car Corporation

Thank you for choosing Volvo!

Contents

Safety	9
Instruments and controls	27
Climate control	51
Interior	63
Locks and alarm	79
Starting and driving	91
Wheels and tyres	117
Car care	123
Maintenance and service	129
Specifications	153
Audio (option)	163
Telephone (option)	183
Alphabetical index	197

Dashboard

Left-hand drive

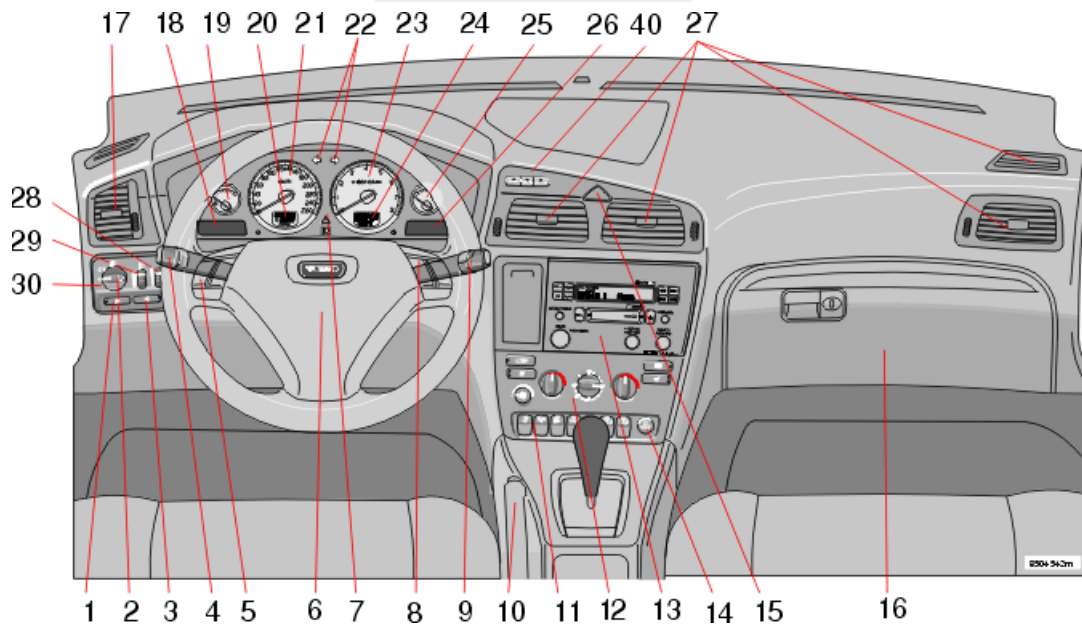

	<i>Page</i>		<i>Page</i>
1. Fog lamps	36	24. Outside temperature/Clock/ Gear position	28/28/28
2. Headlamps/ Position/Parking lights	36	25. Fuel gauge	28
3. Rear fog lamps	36	26. Indicator and warning symbols	29
4. Direction indicators/ Beam selection	37	27. Panel vents	53
5. Cruise control	41	28. Instrument lighting	36
6. Horn	6	29. Headlamp levelling	36
7. Combined instrument panel	28	30. Lighting panel	36
8. Telephone/Audio keypad	183/163	31. Reading lamps	68
9. Windscreen wipers	38	32. Interior lighting	68
10. Parking brake (handbrake)	42	33. Control, sunroof	48
11. Switch panel	34	34. Seat belt reminder	46
12. Climate control	54/58	35. Rearview mirror	46
13. Audio system	163	36. Lock button, for all doors	82
14. Electric socket/ Cigarette lighter	42	37. Blocking power windows in the rear doors	44
15. Hazard warning flashers	39	38. Controls, power windows	44
16. Glovebox	72	39. Controls, power door mirrors	46
17. Panel vents	53	40. Active chassis	29/106
18. Display	33		
19. Temperature gauge	28		
20. Odometer/Trip odometer/ Cruise control	28/28/41		
21. Speedometer	28		
22. Direction indicators	37		
23. Tachometer	28		

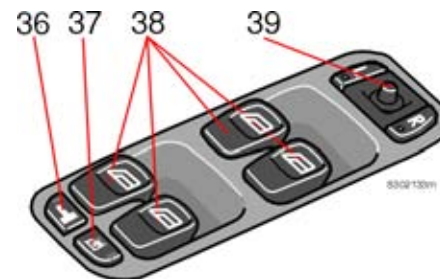

Driver's door control panel

Dashboard

Right-hand drive

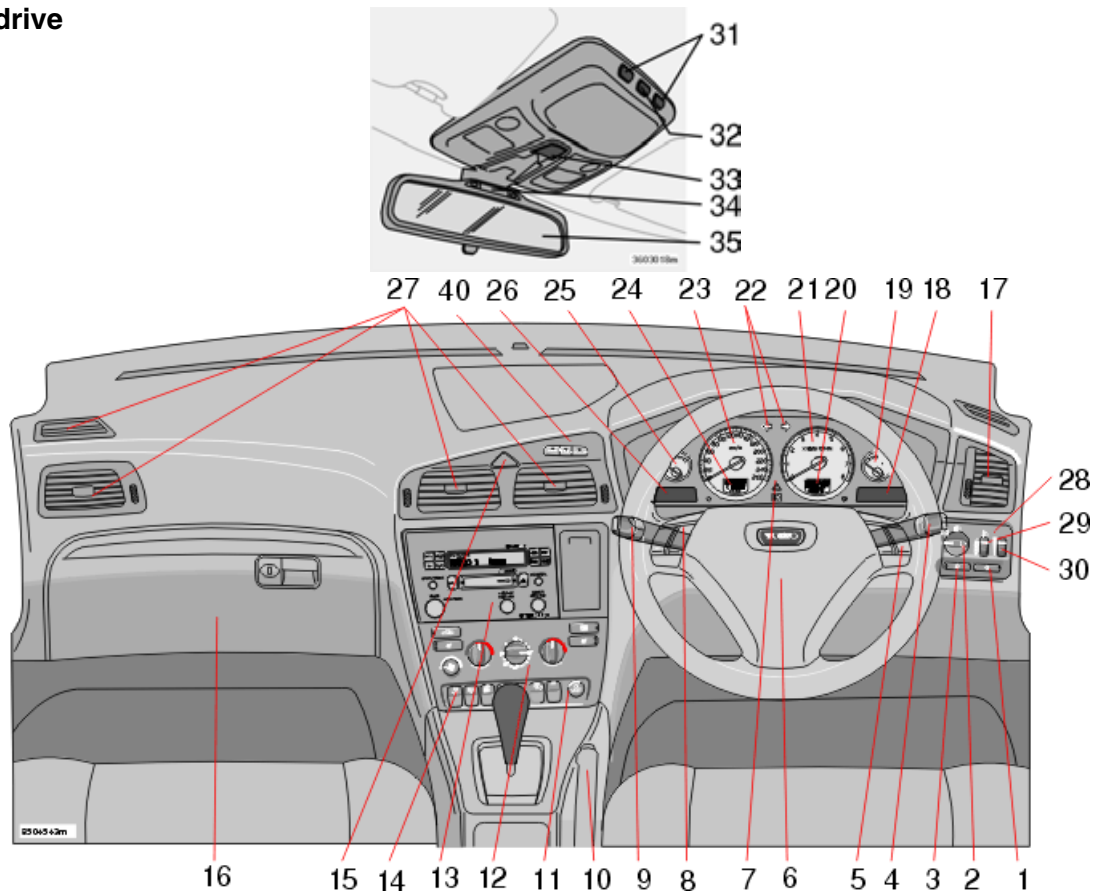

	<i>Page</i>		<i>Page</i>
1. Rear fog lamps	36	23. Speedometer	28
2. Headlamps/ Position/Parking lights	36	24. Odometer/Trip odometer/ Cruise control	28/28/41
3. Fog lamps	36	25. Temperature gauge	28
4. Windscreen wipers	38	26. Display	33
5. Telephone/Audio keypad	183/163	27. Panel vents	53
6. Horn	8	28. Lighting panel	36
7. Combined instrument panel	28	29. Headlamp levelling	36
8. Cruise control	41	30. Instrument lighting	36
9. Direction indicators/ Beam selection	37	31. Reading lamps	68
10. Parking brake (handbrake)	42	32. Interior lighting	68
11. Electric socket/ Cigarette lighter	42	33. Control, sunroof	48
12. Climate control	54/58	34. Seat belt reminder	46
13. Audio system	163	35. Rearview mirror	46
14. Switch panel	34	36. Lock button, for all doors	82
15. Hazard warning flashers	39	37. Blocking power windows in the rear doors	44
16. Glovebox	72	38. Controls, power windows	44
17. Panel vents	53	39. Controls, power door mirrors	46
18. Indicator and warning symbols	29	40. Active chassis	29/106
19. Fuel gauge	28		
20. Outside temperature/Clock/ Gear position	28/28/28		
21. Tachometer	28		
22. Direction indicators	37		

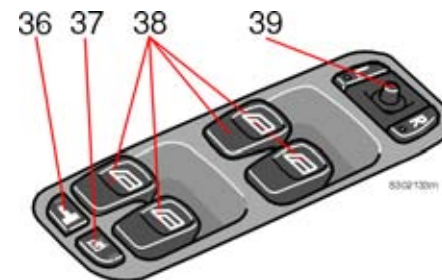

Driver's door control panel

Safety

Seat belt	10
Airbags (SRS)	12
Side airbags (SIPS bag)	15
Inflatable Curtain (IC)	17
When do the airbags and curtains inflate?	18
Inspection of airbags, inflatable curtains and seat belt tensioners	19
WHIPS	20
Child safety	22

Seat belt

Use the seat belt for all types of driving

Even hard braking can have dangerous consequences if you are not wearing a seat belt! Therefore, always ask your passengers to use seat belts! Otherwise rear seat passengers may be thrown into the front seat backrests in a collision. Everyone in the car may then be hurt.

Use the seat belt as follows: pull the belt out slowly and secure it by inserting the locking tab into the lock. A loud "click" indicates that the belt is locked.

The belt is not normally restricted and you can move freely.

The belt is restricted and cannot be pulled out further:

- if it is pulled out too fast
- during braking and acceleration

If the car leans excessively. In order for the belt to provide maximum protection, it must be fitted securely. Do not lower the backrest too far back. The belt is designed to protect passengers in a normal sitting position.

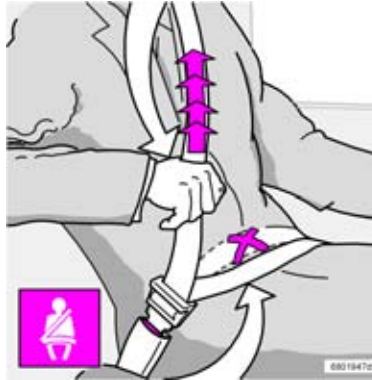

Extending the lap belt

Keep the following in mind:

- do not use clips or anything else that prevents the belt from lying correctly.
- make sure the belt is not twisted or entangled.
- the lap belt should sit low - not across the abdomen.
- extend the lap belt over the lap by pulling the diagonal shoulder belt as shown above.

Each belt is intended for **one** person only!

To release the belt: Press the red button in the lock and allow the reel to retract pull the belt. If the belt is not completely retracted, feed in the belt manually to prevent it from hanging loose.



Pregnant women

Pregnant women should be especially careful when using seat belts! Always remember to position the belt so that there is no unnecessary pressure on the womb. The lap belt of the three-point seat belt should be low.

Seat belt and seat belt tensioner

All seat belts are equipped with seat belt tensioners. A small mechanism, built into the seat belt reel, triggers at the moment of impact to tension the belt around the body and reduce slack from clothing, etc. The belt thus restrains the passenger more quickly.

Marking on seat belts with seat belt tensioners



WARNING!

If the seat belt has been subject to excessive stress, such as during a collision, the entire seat belt assembly including the reel, mountings, bolts and lock must be replaced. Although the belt may appear to be undamaged, some of the protective properties may have been lost. Replace the seat belt if it is worn or damaged. **Never** make any modifications or repairs to the seat belt. Contact an authorised Volvo workshop.

Airbags (SRS)



Right-hand drive



Left-hand drive

Location of the passenger side airbag

Driver's side airbag

To further increase interior safety, your car is equipped with an airbag (SRS¹) as a complement to the three-point seat belt. The inflatable airbag is installed folded up in the centre of the steering wheel. The wheel is marked SRS.

An inflated airbag has a volume of approx. 60 litres. The volume of the driver's side airbag is less than the passenger side airbag volume since it is located in the steering wheel. The crash protection is the same for both sides.

Passenger side airbag (option)

The passenger side airbag is folded up in a compartment above the glovebox behind a panel marked SRS. The volume of the inflated airbag is approximately 145 litres.

WARNING!

Do not attach clips or any other equipment to the dashboard or steering wheel! This can result in personal injury and/or hinder the function of the airbag when it is inflated.

WARNING!

Airbags (SRS) are designed to provide additional protection and do not replace seat belts. For maximum safety: **Always use a seat belt.**

1. Supplemental Restraint System

WARNING!

Airbag - passenger side

- **Never** put a child seat or booster cushion in the front seat if the car is equipped with an airbag (SRS) on the passenger side.
- **Never** allow a child to stand or sit in front of the front passenger seat.
- **No one** shorter than 140 cm should sit in the front seat.
- Passengers should sit as upright as possible with their feet on the floor and backs against the backrests. Seat belts should be fastened.
- No objects or accessories may be positioned or stuck on or near the SRS panel (above the glovebox) or in the area affected by the airbag.
- Do not place loose objects on the floor, seat, or on the dashboard.
- Never interfere with SRS components in the steering wheel hub or the panel above the glovebox.

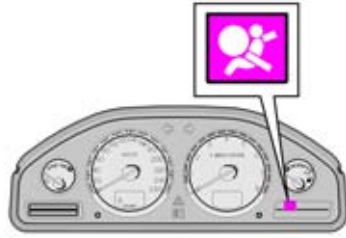

Warning lamp in the combined instrument panel

The sensor/control module continuously monitors the SRS system. A warning lamp in the combined instrument panel lights when the ignition key is turned to position I, II or III. The lamp is extinguished when the sensor/control module has checked that the SRS system is fault-free. This normally takes approx. 7 seconds.

WARNING!

If the SRS warning lamp remains lit or lights while driving, it indicates insufficient SRS system function. Contact an authorised Volvo workshop.

Airbags (SRS) (Contd)

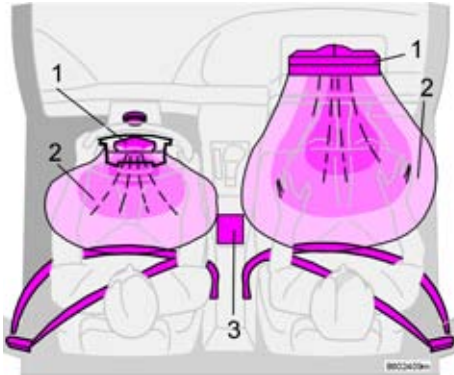

SRS system, left-hand drive

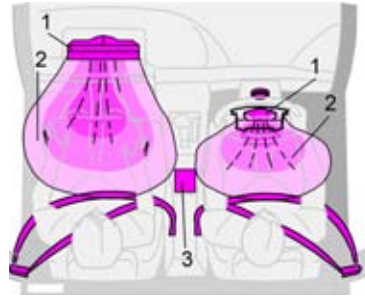

SRS system, right-hand drive

SRS System

The system consists of a gas generator (1) surrounded by the inflatable airbag (2). Upon a sufficiently violent collision, a sensor (3) reacts, activating the gas generator igniter, and the airbag inflates as it heats up. To cushion the impact, the airbag deflates when compressed. When this occurs, smoke escapes into the car. This is completely normal. The entire process, including inflation and deflation of the airbag, occurs in tenths of a second.

NOTE! The sensor (3) reacts differently depending on whether or not the driver or passenger side seat belts are in use. Crash situations may occur where only one airbag is deployed.

Volvo Dual-Stage Airbag

(Dual-stage airbags)

If a minor collision occurs which may still pose a risk for injury, the airbags will deploy to approximately half of their total capacity. The airbags deploy to full capacity if the impact is greater.

WARNING!

Never try to repair any part of the SRS or SIPS bag systems yourself. Any interference in the system could cause malfunction and serious injury. Any work should only be performed by an authorised Volvo workshop.

Side airbags (SIPS bag)

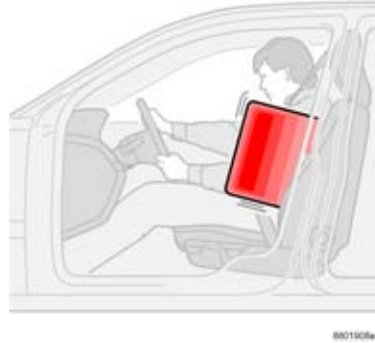

Inflated SIPS airbag

Side airbags – SIPS bag

Side airbags further increase interior safety.

The SIPS airbag system consists of two main components: side airbags and sensors. The side airbags are installed in the frames of the front seat backrests and the sensors are located in the insides of the centre pillars. The volume of an inflated side airbag is about 12 litres.

WARNING!

Side airbags (SIPS bags) are an addition to the existing SIPS system (Side Impact Protection System). For maximum protection: **Always use seat belts.**

Child seat and SIPS airbag

If the car is only equipped with SIPS airbags and no front airbag (SRS) on the passenger side, child seats/booster cushions can be placed in the front seat.

WARNING!

SIPS airbag

- Extra seat covers must not be used on the front seats if they are not Volvo Genuine covers or Volvo approved seat covers for SIPS airbags.
- No objects or accessories may be placed between the outer side of the seat and the door panel because this area may be affected by the SIPS airbag.
- Never interfere with the SIPS airbag system.

Side airbags (SIPS bag) (Contd)

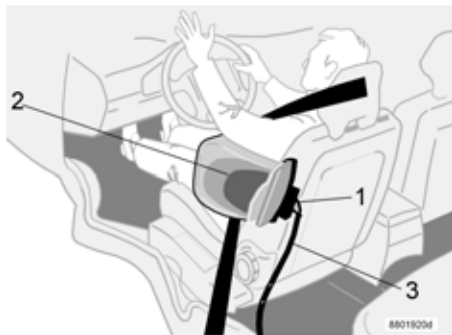

Left-hand drive

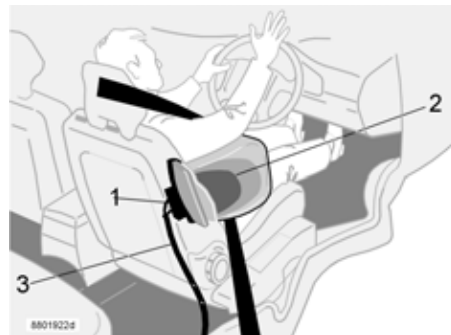

Right-hand drive

The SIPS airbag system

The SIPS bag system consists of a gas generator (1), electronic sensors, cables (3) and the side airbags (2). When a sufficiently violent collision occurs, the sensors react and activate the gas generator which inflates the side airbag. The airbag inflates between the occupant and the door panel, cushioning the impact at the moment of collision and then deflates. Normally, only the airbag on the side of the collision will deploy.

Inflatable Curtain (IC)

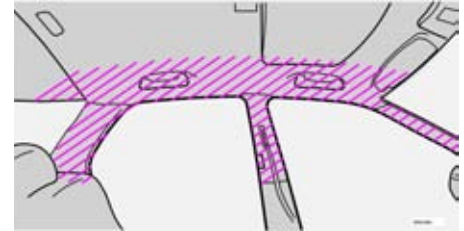
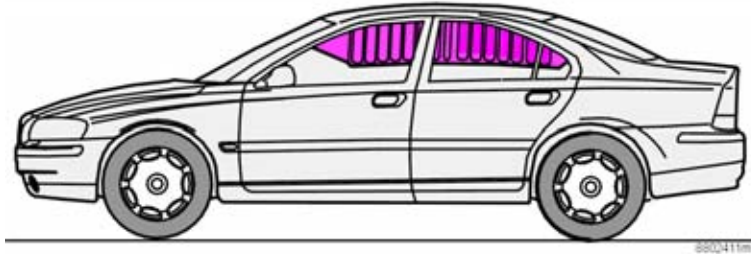

Inflatable Curtain (IC - Inflatable Curtain)

The inflatable curtain protects the head from striking the interior of the car and provides better protection from objects from the other vehicle. The IC system protects both the front seat occupants and the passengers sitting in the outer rear seats. The inflatable curtain is concealed inside the headlining. The IC system – inflatable curtain – covers the upper part of the interior for the front and rear seats.

The IC system is activated by the SIPS system collision sensors when the car is hit from the side. When the IC system is activated, the curtain is filled with gas from the gas generator, which is located in the rear of the curtain.



WARNING!

Do not screw or mount anything to the headlining, door pillars or side panels. The intended protection may be compromised.

When do the airbags and curtains inflate?

Airbags in the steering wheel and dashboard (SRS)

The airbags deploy:

- if there is a risk that front seat occupants will be injured by blows against the dashboard or steering wheel.

The SRS system senses the collision in the level of braking and the speed reduction caused by collision. The sensor determines if the collision is of the character and nature requiring airbag deployment to protect the occupants.

The bodywork of the car could be greatly deformed in a collision without airbag deployment. This does not indicate a fault in the airbags. This means that the function was not needed at that moment and the occupants were protected by the other safety systems of the car.

Side airbags and inflatable curtains (SIPS airbags and IC)

The side airbags and inflatable curtains are normally inflated:

- only during collisions from the side when the car is hit by an object with sufficient force.

NOTE! Deployment of the SRS, SIPS, and IC systems only occurs once in a collision.

If the airbags have been deployed, we recommend the following:

- Tow the car to a Volvo workshop. Do not drive the car with the airbags deployed even if the car can be driven after an accident.

Let an authorised Volvo workshop replace components in the SRS, SIPS, and IC systems.



WARNING!

Never drive with deployed airbags! This may make the car difficult to steer. Other safety systems may also be damaged. Intense exposure to the smoke and dust released when the air bags are deployed can cause skin and eye irritation. In case of problems, wash with cold water and contact a doctor. The speed of the deployment and the airbag fabric may cause friction burns on the skin.



WARNING!

The SRS system sensor is located in the centre console. If the floor of the passenger compartment has been drenched with water, disconnect the battery cables in the cargo compartment.

Do not try to start the car; the airbag may deploy. Tow the car to an authorised Volvo workshop.

Inspection of airbags, inflatable curtains and seat belt tensioners

The year and month specified on the decal in the door pillar(s) is the date you should contact your Volvo workshop to inspect, and if necessary, replace the airbags and seat belt tensioners. If you have any questions concerning either system, contact an authorised Volvo workshop.

This decal is located in the rear left door opening.

Date for inspection of:

Driver's side airbag

Passenger side airbag

Side airbag on the driver's side

Side airbag on the passenger side

Inflatable curtain on the driver's side

Inflatable curtain on the passenger side



8501995d

WHIPS

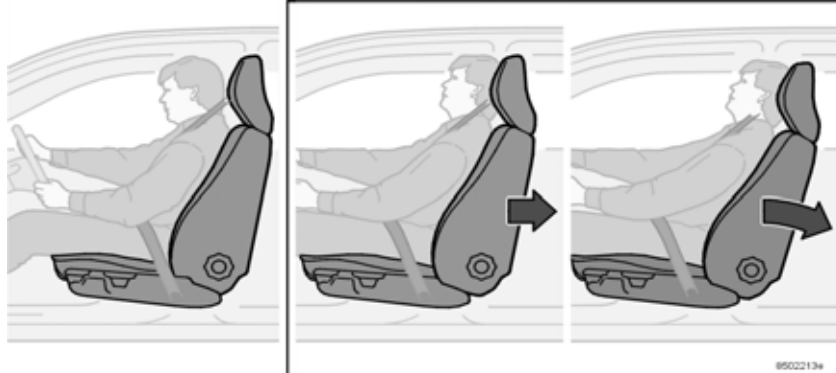

WHIPS (Whiplash Protection System)

This system consists of energy absorbing backrests and specially developed head restraints in both front seats.

WHIPS seat

WHIPS is activated upon a collision from behind based on the collision angle, speed and nature of the colliding vehicle. Upon activation, the backrests of the front seats, if occupied, move backward and the seating position of the occupants in the front seats is altered. This diminishes the risk of whiplash injury.

Correct seating position

For the best possible protection, you and your front seat passenger should sit in the centre of your seats with as little distance as possible between the head restraints and your heads.

WHIPS and child seat

The WHIPS system does not negatively affect the protective properties of the car with regard to child seats. As long as there is no passenger side airbag (SRS), a Volvo child seat may be located in the front passenger seat. The WHIPS system still functions if a rear-facing child seat is placed on the rear seat and supported against the front seat backrest.

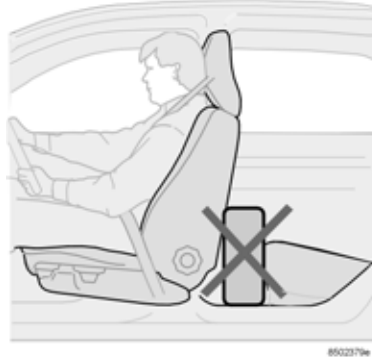
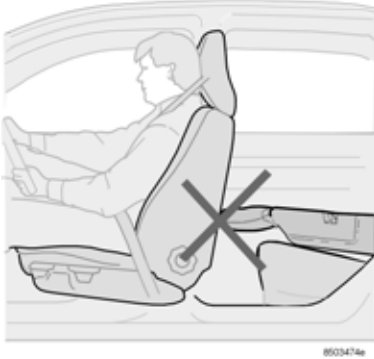

⚠ WARNING!

Be sure to never hinder the function of the WHIPS system!

- If a rear backrest is folded down, the corresponding front seat must be adjusted so that it is not in contact with the folded backrest.
- Avoid placing boxes or similar cargo so that it is clamped between the seat cushion of the rear seat and the backrest of the front seat.

⚠ WARNING!

If the seat has been exposed to a heavy load strain, such as in a rear-end collision, the WHIPS system should be inspected by an authorised Volvo workshop. Even if the seat does not appear damaged, the WHIPS system may have deployed without causing visible damage to the seat. The protective capacity of the WHIPS system may be impaired. Have the system checked at an authorised Volvo workshop even after minor rear-end collisions. Never modify or repair the seat or WHIPS system yourself!

Child safety

Children should sit comfortably and safely

Remember that children, regardless of age or size, should always be securely strapped into the car. Never allow a child to sit on the knee of a passenger!

The weight and height of the child must be considered when selecting equipment and its location, see page 25.

Volvo's own child safety equipment is designed for your car. If you select Volvo equipment, you can be sure that the mounting points and attachments are correctly positioned and sufficiently strong.

Children up to 3 years of age sit safest in a rear-facing child seat.

Many countries have regulations regarding where children should be located in the car. Find out what laws apply in the countries you will be visiting.



WARNING!

Never put a child seat/booster cushion in the front seat if the car is equipped with SRS (airbag) on the passenger side.

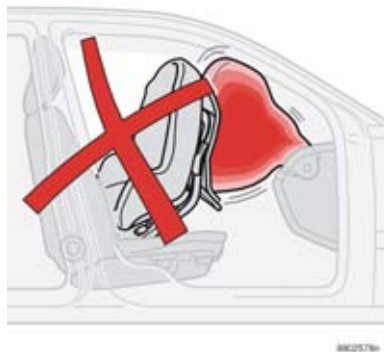

Airbags and child seats are not compatible!

Child seat and airbag

If the car has a passenger airbag, the child seat must be placed in the rear seat.

If seated in a child seat in front of a passenger airbag and the airbag inflates, the child could be seriously injured.

Passengers shorter than 140 cm must **never** sit in the front passenger seat if the car has a passenger airbag.

Position of the child

Weight/age	Front seat*	Outer rear seats	Centre rear seat
<10 kg (0–9 months)	Alternatives: 1. Rear-facing child seat, secured with seat belt. <i>L: Type approval no. E5 03160</i> 2. Rear-facing child seat, secured with Isofix mounting. <i>L: Type approval no. E5 03162</i> 3. Rear-facing child seat, secured with seat belt and mounting strap. <i>L: Type approval no. E5 03135</i>	Alternatives: 1. Rear-facing child seat, secured with seat belt and support. <i>L: Type approval no. E5 03160</i> 2. Rear-facing child seat, secured with Isofix mounting and support. <i>L: Type approval no. E5 03162</i> 3. Rear-facing child seat, secured with seat belt, support and mounting strap. <i>L: Type approval no. E5 03135</i>	1. Rear-facing child seat, secured with seat belt, support and mounting strap. <i>L: Type approval no. E5 03135</i>
9–18 kg (9–36 months)	Alternatives: 1. Rear-facing child seat, secured with seat belt. <i>L: Type approval no. E5 03161</i> 2. Rear-facing child seat, secured with Isofix attachment. <i>L: Type approval no. E5 03163</i> 3. Rear-facing child seat, secured with seat belt and mounting strap. <i>L: Type approval no. E5 03135</i>	Alternatives: 1. Rear-facing child seat, secured with seat belt and support. <i>L: Type approval no. E5 03161</i> 2. Rear-facing child seat, secured with Isofix and support. <i>L: Type approval no. E5 03163</i> 3. Rear-facing child seat, secured with seat belt, support and mounting strap. <i>L: Type approval no. E5 03135</i>	1. Rear-facing child seat, secured with seat belt, support and mounting strap. <i>L: Type approval no. E5 03135</i>
15–36 kg (3–12 years)	Not suitable for this age group.	1. Booster cushion with or without backrest. <i>L: Type approval no. E5 03139</i>	Alternatives: 1. Booster cushion with or without backrest. <i>L: Type approval no. E5 03139</i> 2. Integrated booster cushion. <i>L: Type approval no. E5 03140</i>

WARNING!

* NEVER place a child seat or booster cushion in the front seat of a car equipped with a passenger airbag.

L: Suitable for specific child seats as listed in the specified type approval. Child seats may be vehicle-specific, limited, semi-universal or universal.

Child safety (Contd)

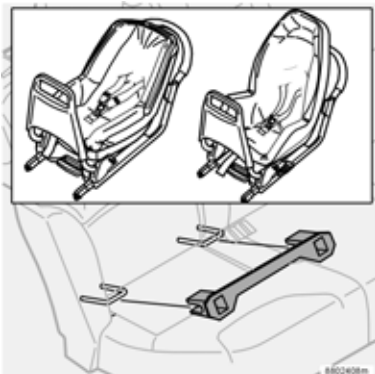

Isofix mountings

Isofix mounting system for child seats (option)

The outer rear seats are factory fitted with Isofix mountings. Contact your Volvo dealer for further information on child safety equipment.

Isofix mountings are located in both outer rear seats. The Isofix guide can be moved from one side to the other as needed.



Check that:

- the seat belt is in contact with the child's body and is not slack or twisted
- the belt lies correctly over the shoulder
- the lap belt is low over the pelvis for optimum protection
- the belt does not touch the child's throat or lie below the shoulders

Carefully adjust the position of the head restraint to suit the child.

Integrated booster cushion (option)

Volvo's integrated booster cushion is specially designed to provide optimum safety for children.

Combined with the regular seat belts, the booster cushion is approved for children weighing between 15 and 36 kg.

Folding out the booster cushion:

- fold down the booster cushion
- pull apart the Velcro
- raise the upper portion back into place

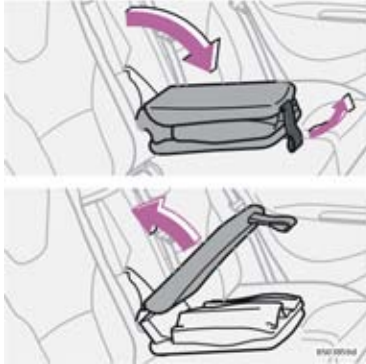

Folding out the booster cushion:

- fold down the booster cushion
- pull apart the Velcro

raise the upper portion back into place

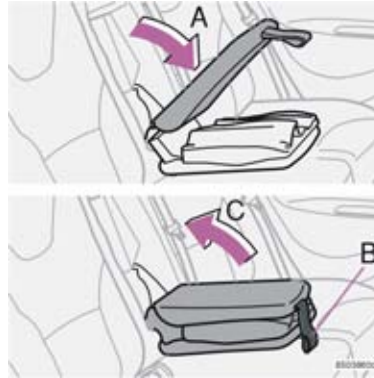

Raising the booster cushion:

- fold down the booster cushion backrest (A)
- fasten the Velcro (B)
- raise the booster cushion into the rear seat backrest (C)

NOTE! If the backrest and seat portion are not properly secured to each other before being folded up, the backrest can catch in the rear seat opening when the booster cushion is used again.

WARNING!

If an integrated booster cushion has been subjected to great stress, such as in a collision, the entire booster cushion, including the seat belt and bolts, must be replaced. Even if the integrated booster cushion appears undamaged, it may not afford the same level of protection. The booster cushion should also be replaced if it is worn or damaged. Note, however, that the cushion should only be replaced by a professional as it is vital for passenger safety that the booster cushion is correctly installed. Therefore, replacement and any repairs to the cushion should be referred to an authorised Volvo workshop. If the cushion becomes dirty, try to clean it in situ. If the upholstery is so dirty that it needs to be washed separately, the instructions provided above for replacing and installing the cushion should be followed.

Do not modify or adapt the booster cushion in any way.

Child safety (Contd)

Important tips!

When using other child safety products that are available on the market, it is **important** to read the installation instructions that accompany the product and follow them carefully. Here are some points you should consider:

- Support cushions/child seats with steel frames or another design that can lie against the seatbelt release button must not be used because they can cause accidental release of the seatbelt.
- Volvo has child safety products that are designed for and tested by Volvo.
- The child seat must always be placed according to the manufacturer's directions.
- Do not attach the child seat straps to the horizontal adjustment bar, springs or any of the rails and struts under the seat that may have sharp edges.
- Allow the backrest of the child seat to rest against the dashboard. (Applies to cars **without** a passenger side airbag (SRS).)
- Do not allow the top portion of the child seat to rest against the windscreen.

Never place a child seat in the front seat if the car is equipped with an airbag (SRS) on the passenger side.

NOTE! If there are any problems with installation of child safety products, contact the manufacturer for clearer installation instructions.

Instruments and controls

Combined instrument panel	28
Indicator and warning symbols	29
Switches in the centre console	34
Lighting panel	36
Direction indicators	37
Windscreen wipers/washer	38
Hazard warning flashers, rear window and door mirror defrosters, heated front seats	39
Trip computer (option)	40
Cruise control (option)	41
Parking brake, electric socket/ cigarette lighter	42
Steering wheel adjustment	43
Power windows	44
Rearview mirror/door mirrors	46
Power sunroof (option)	48

Combined instrument panel

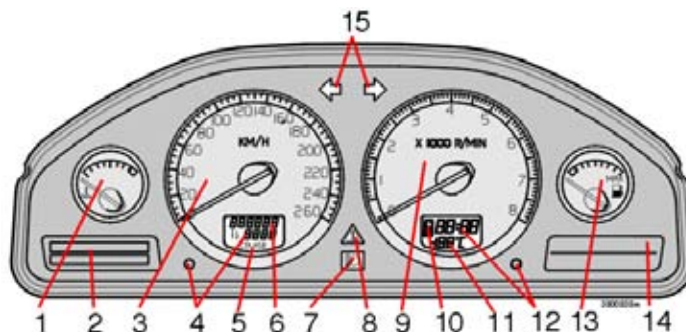

1. Temperature gauge

Displays the temperature of the engine cooling system. If the temperature is abnormally high and the needle enters the red zone, a message is shown in the display. Bear in mind that extra lamps in front of the radiator grille reduce the cooling capacity at high outside temperature and high engine loads.

2. Display

The display shows information and warning messages.

3. Speedometer

Shows the speed of the car.

4. Trip odometer

The trip odometers are used for measuring short distances. The right-hand digit displays tenths of a kilometre. Press the button for more than 2 seconds to reset. Switch between trip odometers with one quick press of the button.

5. Cruise control indicator

See page 41.

6. Odometer

The odometer indicates the total distance the car has travelled.

7. Main beam on/off

8. Warning symbol

If a fault arises, the symbol lights up and a message is shown on the display.

9. Tachometer

Indicates engine speed in thousands of revolutions per minute (RPM). Do not allow the needle of the tachometer to enter the red field.

10. Automatic gearbox indicator

The selected gearshift programme is displayed here. If you have Geartronic automatic gearbox and drive using the manual function, the current manual gear is displayed.

11. Outside temperature gauge

Displays outside temperature. When the temperature lies between +2 °C to -5 °C, a snowflake symbol is shown in the display. This symbol serves as a warning for slippery road surfaces. When the car is or was stationary, the outside temperature gauge may display a higher reading than the actual temperature.

12. Clock

Turn the button to set the clock.



13. Fuel gauge

The fuel tank holds 70 litres. There are approximately 8 litres of fuel remaining when the lamp in the instrument panel lights.

14. Indicator and warning symbols

15. Direction indicators – left/right

Indicator and warning symbols

The indicator and warning symbols light when you turn the ignition key to the driving position (position II) before starting. This shows that the symbols are functioning. When the engine is started, all symbols should switch off. If the engine is not started within 5 seconds, all symbols except  and  switch off. Certain symbols may not correspond to the indicated function depending on the car's equipment. The parking brake symbol switches off when the parking brake is released.

Warning symbol in centre of dashboard

These symbols are lit with a red or amber glow depending on the severity of the fault.

Red symbol: **Stop the car!** Read the message in the display.

Yellow symbol: Read the message in the display. Remedy!

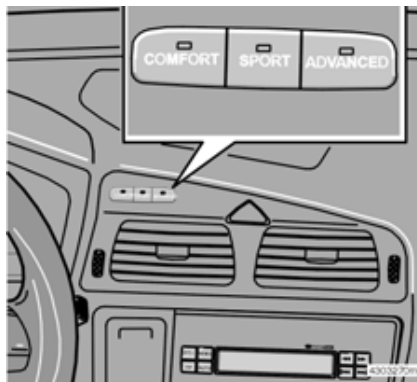

Active chassis (R version only)

The S60 R is equipped with an advanced, electronically-controlled active chassis system.

The buttons on the dashboard can be used at random in order to select from the three different settings: Comfort, Sport and Advanced.

Comfort

This setting adjusts the chassis setting so that the car “floats” over uneven surfaces in the road. Shock absorption is softer and body movements are minimal.

Sport

Shock absorption is harder in order to reduce roll during hard cornering. The car responds like a typical sports car.

Advanced

In this setting, the shock absorber movements are minimal, acceleration response is more direct and roll during cornering is minimised.

See page 106 for more detailed information about the system.

Indicator and warning symbols (Contd)

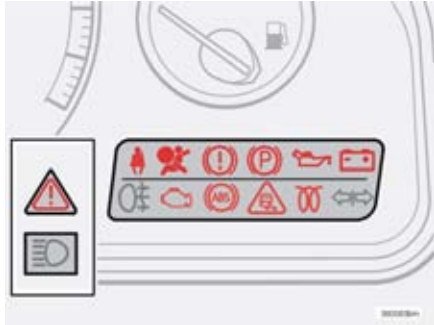

Fault in the ABS system

If the ABS symbol lights, the ABS system is malfunctioning. The car's normal braking system continues to work, but without the ABS function.

- Stop the car in a safe place and switch off the engine. Restart the engine.
- If the warning symbol goes out, continue driving. It was an indicator error.
- If the warning symbol remains lit, drive to an authorised Volvo workshop to have the ABS system checked.

Fault in braking system

If the BRAKE symbol lights, the brake fluid level may be too low.

- Stop the car in a safe place and check the brake fluid reservoir level.
- If the reservoir level is below MIN, the car should not be driven further. Have it towed to an authorised Volvo workshop to have the brake system checked.

 If the **BRAKE** and **ABS** warning symbols light at the same time, there may be a problem in the brake force distribution.

-  Stop the car in a safe place and switch off the engine. Restart the engine.
- If both symbols go out, it was an indicator error.
- If the warning symbols remain lit, check the brake fluid reservoir level.
- If the reservoir level is below MIN, the car should not be driven further. Have it towed to an authorised Volvo workshop to have the brake system checked.
- If the brake fluid level is normal and the lamps remain lit, carefully drive the car to the nearest authorised Volvo workshop to have the brake system checked.

WARNING!

If the BRAKE and ABS warning symbols light at the same time, there is a risk that the rear end will have a tendency to slide during heavy braking.

**Seat belt reminder**

This lamp lights until the driver buckles up.

**Fault in SRS**

If a fault in the SRS system is detected the warning symbol will remain lit or light up while driving. Drive to an authorised Volvo workshop to have the system checked.

**Parking brake applied**

Remember that the lamp only indicates that the parking brake is applied, not the tension on the brake. Check by pulling the lever! You must always apply the brake hard enough so that it fastens in a "notch".

**Low oil pressure**

If the lamp lights while driving, engine oil pressure is too low. Stop the engine immediately and check the oil level. If the lamp lights but the oil level is normal, stop the car and contact an authorised Volvo workshop.

**Generator not charging**

If this lamp lights while driving, there is probably a fault in the electrical system. Contact an authorised Volvo workshop.

**Rear fog lamp**

This lamp lights when the fog lamp is on.

**Fault in emissions system**

Drive to an authorised Volvo workshop to have the system checked.

**Engine preheater (diesel)**

This lamp indicates engine preheating. You can start the car when the lamp switches off. Applies to diesel cars only.

**Trailer indicator lamp**

Flashes when the direction indicators of the car and trailer are used. If the lamp does not flash, one of the direction indicator lamps on the trailer or car is defective.

Indicator and warning symbols (Contd)

Stability system STC* and DSTC*

Refer to page 34 and page 104 for a more detailed description of the STC/DSTC system. The system comprises several functions

Risk of traction loss

A **flashing** warning symbol indicates that the STC/DSTC system is operating. You may notice that the engine does not respond to normal acceleration. This can occur if you attempt to accelerate on a road with less surface friction.

- Drive carefully!

Reduced traction control

The symbol lights and shines with a steady light when the STC/DSTC system function been reduced due to high brake temperature. "TRACTION CONTROL TEMPORARILY OFF" will be displayed.

*: Option in certain markets. Standard for R version.

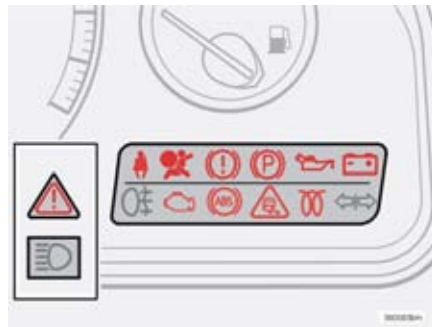

Reduced stability control

The button LED extinguishes when the STC/DSTC system function had been deactivated with the STC/DSTC button on the centre console. "SPIN CONTROL OFF" is displayed.



Fault in the STC/DSTC systems

A symbol that lights and shines with a steady light and the message "ANTI-SKID SERVICE REQUIRED" displayed without any of the systems being switched off is an indication of a system fault.

- Stop the car in a safe place and switch off the engine. Restart the engine.
- If the warning symbol goes out, the fault was temporary and it is not necessary to visit a workshop.
- If the warning symbol remains lit, drive to an authorised Volvo workshop to have the system checked.



WARNING!

Under normal driving conditions, the STC/DSTC system improves the car's road safety, but this is not an indication to increase speed. Always follow normal safety precautions for cornering and driving on slippery surfaces.

Messages in the display

A message appears in the display whenever a warning or indicator symbol lights. Once you have read and understood the message, press the READ button (A). Read messages are then erased from the display and stored in a memory. Messages regarding faults remain in the memory until the fault has been remedied.

Very serious fault messages cannot be erased from the display. They remain in the display until the fault is remedied.

Messages stored in the memory can be read again. Press the READ button (A) to view stored messages. Scroll through the messages stored in the memory by pressing the READ button. Press the READ button to return read messages to the memory.

NOTE! If a warning message interrupts when you are in the trip computer menu or wish to use the telephone, you must first acknowledge the message by pressing the READ button (A).

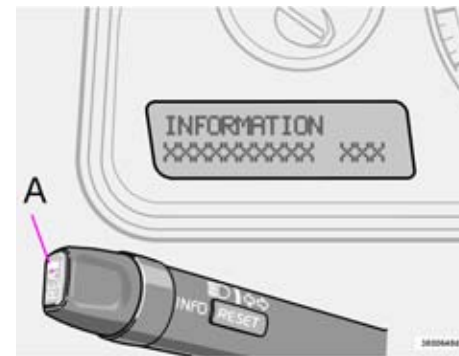

Message	Specification
STOP SAFELY	Stop and switch off the engine. Serious risk of damage.
STOP ENGINE	Stop and switch off the engine. Serious risk of damage.
SERVICE URGENT	Take your car in for service immediately.
SEE MANUAL	Consult your owner's manual.
SERVICE REQUIRED	Take your car in for service as soon as possible.
FIX NEXT SERVICE	Have your car checked at the next service interval.
TIME FOR REGULAR SERVICE	When this message is shown, the car is due for a service. When the message is displayed is affected by the distance travelled, number of months since last service and engine running time.
1) OIL LEVEL LOW – FILL OIL*	Low engine oil level. Check and remedy as soon as possible. See page 135 for more information.
2) OIL LEVEL LOW – STOP SAFELY*	Low engine oil level. Stop the car safely and check the oil level. See page 135.
2) OIL LEVEL LOW – STOP ENGINE*	Low engine oil level. Stop the car safely, switch off the engine and check the oil level. See page 135.
2) OIL LEVEL LOW – SEE MANUAL*	Low engine oil level. Stop the car safely, switch off the engine and check the oil level. See page 135.

*: R-version only.

- 1) Displayed together with an **orange** warning triangle
- 2) Displayed together with a **red** warning triangle

Switches in the centre console

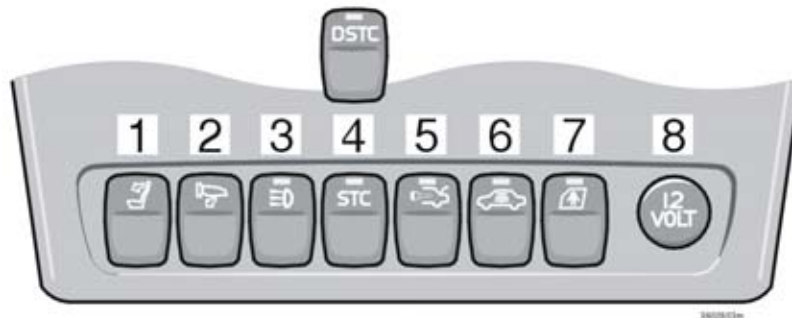

1. Tilting the outer rear seat head restraints (option)

Do not tilt the head restraints forward if there are passengers in any of the outer seats.

- Turn the ignition key to position I or II.
- Press button 1 to tilt the rear head restraints forward for a better rear view.

The head restraints are tilted back manually.

NOTE! The head restraints must be in the upright position if you wish to fold the rear backrests down.

2. Retractable door mirrors (option)

This button is used to fold in the door mirrors if they are folded out or to fold them out if they are folded in.

Do as follows if a door mirror has been accidentally folded in or out:

- Manually fold the door mirror forward as far as possible.
- Turn the ignition key to position II.
- Fold the door mirror inward and then outward using the button. The door mirrors have now returned to their original fixed positions.

3. Auxiliary lamps (accessory)

Use this button to switch the auxiliary lamps on or off. The LED in the button is lit when the lamps are on.

4. STC/DSTC system*

This button is used to deactivate or reactivate STC/DSTC system functions.

When the button LED is lit, the STC/DSTC system is active (if no faults have occurred).

NOTE! – For safety reasons –, the button must be held for at least 0.5 s in order to deactivate the STC/DSTC system. "SPIN CONTROL OFF" is displayed.

Deactivate the system if you must use a wheel with different dimensions.

The STC/DSTC system is re-activated when the engine is restarted.

WARNING!

Keep in mind that car's driving characteristics may change if you deactivate the STC/DSTC system.

*: Option in certain markets. Standard for R version.

5. Locking the boot lid (certain countries)

Press this button in order to lock the boot lid. The boot lid remains locked even if the doors are unlocked manually with the master key, the master key remote control or the service key.

6. Deactivating the deadlock function and detectors

Use this button if you wish to switch off the deadlock function (doors cannot be opened from the inside when locked). This button can also be used when deactivating the alarm system movement and tilt detectors – e.g. when transporting the car by ferry. The LED lights when the functions are deactivated.

7. Child safety locks in the rear doors (option)

Use this button when you wish to activate or deactivate the electric child safety locks in the rear doors. The ignition key must be in position I or II. When the child safety locks are activated, the LED in the button lights. A message is shown in the display when you activate or deactivate the child safety locks.

8. Electric socket/Cigarette lighter (option)

The electric socket can be used for various 12V accessories, such as mobile phones or coolers. The cigarette lighter is activated by pushing in the button. Once the lighter has been heated, the button pops out. For safety reasons, always keep the cover on the socket when not in use. The maximum socket current is 10A.

Lighting panel

A - Headlamps and position/parking lamps

0 All lighting off.

Cars with automatic dipped beam (certain countries)

Ignition key in position II: Dipped beam on (plus front and rear position/parking lamps, numberplate lighting and instrument illumination). Dipped beam lights automatically when the ignition key is switched to the driving position and cannot be switched off. Before trips to certain countries, your Volvo workshop can help you deactivate the daytime running lights.

3/E Front and rear position/parking lamps.

Ignition key in position 0: All lighting off.

Ignition key in position II: headlamps on (plus front and rear position/parking lamps, numberplate lighting and instrument lighting).

You must always turn the light switch to this position to switch on the main beam.

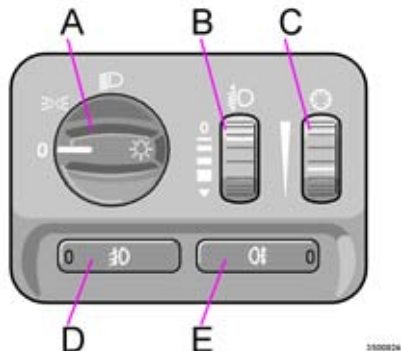

B - Headlamp levelling

Each headlamp is equipped with an actuator which allows for headlamp beam length adjustment in order to compensate for car load. Control up: Normal beam. Control down: Lowered beam.

Cars with Bi-Xenon headlamps (option) have automatic headlamp levelling.

C - Instrument lighting

Move the control upward: brighter lighting.

Move the control downward: dimmer lighting.

A twilight sensor (see page 54) automatically adjusts the brightness of the instrument lighting.

D - Front fog lamps (option)

Ignition key in position II. Press the button. The fog lamps light in combination with the position/parking lamps and main/dipped beam. The LED in the button lights while the fog lamps are on.

NOTE! In some countries, dipped beam may not be used in combination with front fog lamps.

E - Rear fog lamps

Ignition key in position II. Press the button. The rear fog lamps light in combination with the main/dipped beam. The LED in the button and the symbol in the combined instrument panel light at the same time.

Please remember: Regulations for use of front and rear fog lamps vary from country to country.

Direction indicators

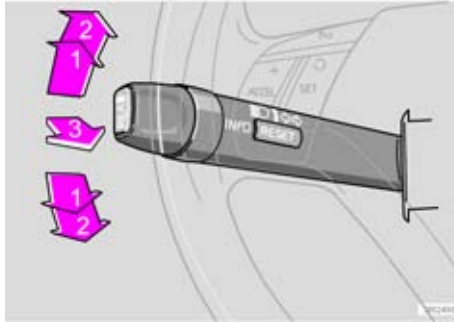

1. Resistance point position

When changing lanes or overtaking, move the lever until you feel a distinct resistance. The lever returns when released.

2. Normal turns

The direction indicators light when you move the lever in the direction the wheel moves during the turn. When the wheel returns after a turn, the direction indicators switch off automatically.

3. Main beam "flash"

Pull the lever lightly towards you (until you feel a slight resistance). The main beam remains lit until the lever is released.

3. Switching, main/dipped beam

Pull the lever towards you past the "flash position" and release it to change between main and dipped beam.

3. Approach lighting

Do as follows when you leave your car when it is dark out:

- Remove the key from the ignition switch.
- Pull the left lever (direction indicator) towards you.
- Exit the car.
- Lock the doors.

The dipped-beam lighting, position/parking lights, numberplate lighting and door mirror lamps (option) will switch on. These lamps will remain lit for 30, 60 or 90 seconds. Your authorised Volvo workshop can select a suitable time setting.

Windscreen wipers/washer



Windscreen wipers

O When the windscreen wipers are switched off and the lever is in position 0, the wipers will sweep one stroke at a time as long as you hold the lever up.

Intermittent wiping

You can adjust and set a suitable speed for intermittent wiping. Rotate the ring (see A in illustration) upwards to increase wiper stroke frequency. Rotate the ring downwards to decrease wiper stroke frequency.

Rain sensor (option)

The rain sensor replaces the intermittent function. The windscreen wiper speed is automatically increased or decreased based on the amount of water on the windscreen indicated by the sensor. **Sensitivity** can be adjusted using the ring (see illustration).

To activate the rain sensor:

- Turn on the ignition.

Move the lever from the 0 position to the position for intermittent wiping.

The rain sensor is deactivated when the ignition is switched off. To reactivate the rain sensor:

- Turn on the ignition.
- Move the lever to the 0 position and then to the position for intermittent wiping.

NOTE! Automatic car wash: Disengage the rain sensor (move the lever to position 0) or switch off the ignition completely. Otherwise, the windscreen wipers will begin operating and may be damaged.

 The wipers swipe at normal speed.

 The wipers swipe at high speed.

3 - Windscreen/headlamp washer

Pull the lever towards the steering wheel to start the windscreen and headlamp washers.

Reduced washing

If only approx. 1 litre of washer fluid remains in the reservoir, the supply to the headlamps and the rear window is cut off in order to prioritise cleaning of the windscreen.

Hazard warning flashers, rear window and door mirror defrosters, heated front seats



Hazard warning flashers

Use the hazard warning flashers (all direction indicators flash) should you be forced to stop or park where the car becomes a possible traffic hazard or obstruction.

Press the button to activate the function.

Keep in mind: Regulations for hazard warning use varies from country to country.

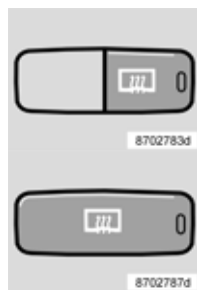

Door mirror and rear window defroster

Use the defroster to remove ice and misting from the rear window and door mirrors. Pressing the switch starts defrosting the rear window and door mirrors simultaneously.

The LED in the switch lights to indicate this. A built-in timer automatically disconnects the defroster from the door mirrors after about 6 minutes and from the rear window after about 12 minutes.



Heated front seats

See page 56 or 59 for further information.

Trip computer (option)

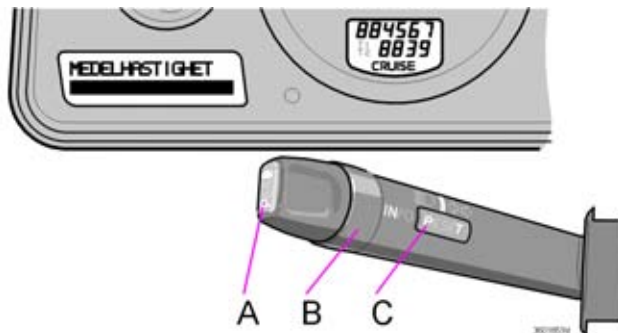

Controls

To access the trip computer information, you must turn the ring (B) in steps, either forward or backward. By turning again, you return to the starting point.

NOTE! If a warning message interrupts while you are using the trip computer, you must first acknowledge the message by pressing the READ button (A) to return to the trip computer.

Functions

The trip computer receives a great deal of data that is continuously evaluated by a microprocessor. The system has four functions which are shown in the display:

- Average speed
- Current fuel consumption
- Average fuel consumption
- Driving distance until the tank is empty

Average speed

The average speed since the last reset (RESET). When the ignition is switched off, the average speed is stored and used as the basis of the new value when you continue driving. This can be reset with the RESET button (C) on the lever.

Current fuel consumption

Continuous information on current fuel consumption. Fuel consumption is calculated every second. The figure in the display is updated every couple of seconds. When the car is stationary, "----" is shown in the display.

NOTE: The displayed value may be slightly off if a fuel-driven heater is used.

Average fuel consumption

The average fuel consumption since the last reset (RESET). When the ignition is switched off, the average fuel consumption is stored and remains until reset with the RESET button (C) on the lever.

NOTE: The displayed value may be slightly off if a fuel-driven heater is used.

Driving distance until the tank is empty

Displays the distance that can be driven with the remaining fuel, calculated using the average fuel consumption over the last 30 km and the remaining quantity of fuel. When the range to empty is less than 20 km, "----" is shown in the display.

NOTE: The displayed value may be slightly off if a fuel-driven heater is used.

Cruise control (option)

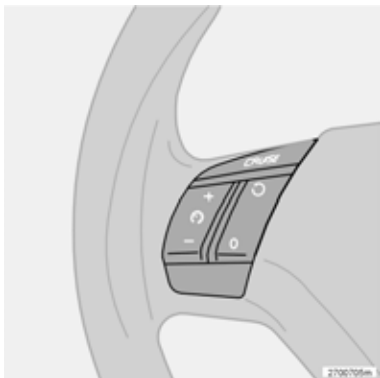

Activating

The controls for cruise control are to the left of the steering wheel.

Setting desired speed:

- Press the CRUISE button. "CRUISE" is displayed on the combined instrument panel.
 - Increase or decrease to the desired speed by pressing + or –.
- NOTE!** Cruise control cannot be engaged at speeds under 35 km/h.

Lightly press + or – in order to lock the desired speed.

Temporary disengagement

Press 0 to temporarily disengage the cruise control.

Depressing the brake or clutch pedal disengages the cruise control. The previously set speed is stored in the memory.

The cruise control is also temporarily disengaged when:

- the speed drops below the lower limit for activation
- the gear selector is moved to position N
- during wheel spin or wheel lock.

Return to a speed

Press  to resume the previously set speed.

Acceleration

A temporary increase in speed, when overtaking for example, does not affect the cruise control setting. The car resumes the previously set speed. If cruise control is already connected, the speed can be increased or decreased by pressing the + or – button. A short press corresponds to 1.6 km/h. The speed of the car when the button is released will be programmed instead.

Disengagement

Press CRUISE to switch off the cruise control. "CRUISE" will extinguish on the combined instrument panel.

The cruise control is automatically disengaged when the ignition is switched off.

NOTE! If one of the cruise control buttons is depressed for more than one minute, the system will be disengaged. You must then turn the ignition off to reset the cruise control.

Parking brake, electric socket/cigarette lighter

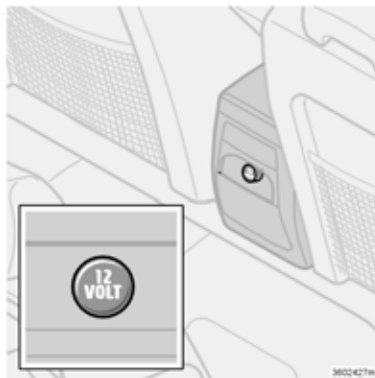
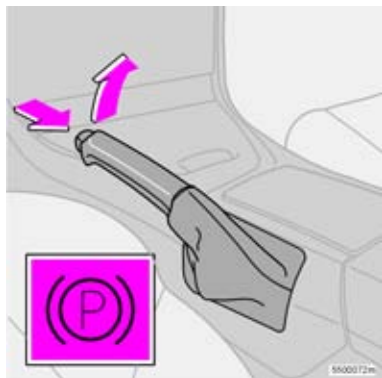

Parking brake (handbrake)

The lever is located between the front seats. The parking brake operates on the rear wheels. The warning symbol in the combined instrument panel lights when the brake is applied. Pull up the lever slightly and press in the button to release the brake.

Remember that the warning symbol in the combined instrument panel lights even if the parking brake is only "slightly" applied. Check that the brake is applied correctly. You must always pull the lever hard enough to fasten it in a "notch".

Electric socket/Cigarette lighter in the rear seat (option)

The electric socket can be used for different 12 V accessories, such as mobile phones and coolers.

The cigarette lighter is activated by pushing in the button. Once the lighter has been heated, the button pops out again. Pull out the lighter to use it.

For safety reasons, always keep the socket covered when not in use. The maximum current is 10A.

Steering wheel adjustment

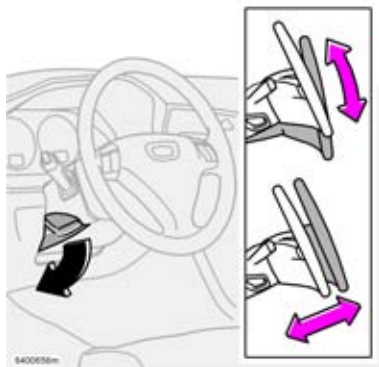

The steering wheel can be adjusted both vertically and front-rear. Press down the control on the left-hand side of the steering column. Then adjust the steering wheel to the position that suits you best. Press the control back into place to lock the steering wheel. If this is difficult, press the steering wheel slightly while pressing the control back.

WARNING!

Adjust the steering wheel before driving, never while driving. Ensure that the steering wheel is locked.

Power windows

The power windows are operated using the controls in the door armrests. The ignition key must be turned to position I or II for the power windows to work. Once you finish driving and remove the ignition key, the windows can still be opened or closed as long as the front doors remain closed.

Open a window by depressing the front of the control, and close it by pulling up the front of the control.

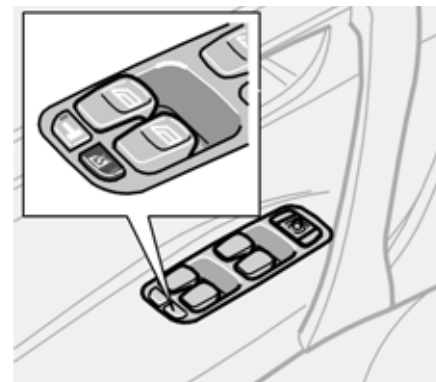
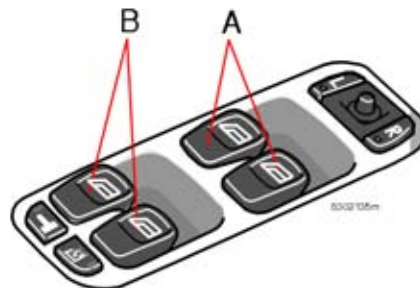

Power windows in the front doors

Windows can be opened or closed from the front seat two ways.

1. Press the control (A) **gently** downward or pull it **gently** upward. The power windows raise or lower as long as you hold the control.
2. Lower controls (A) **completely** or raise **completely** and **release**; the windows will open or close automatically. Movement is stopped if the window is blocked in any way. NOTE! The automatic up function on the passenger side is available in certain markets only.

Controls (B) to operate windows in the rear doors.

Blocking power windows in the rear doors

The power windows in the rear seat can be blocked with the switch on the driver's door control panel. Always remember to switch off current to the power windows (i.e. remove the ignition key and open one of the front doors) when you leave children in the car unattended.

LED in the switch is unlit:

Rear door windows can be operated with rear door controls and driver's door controls.

LED in the switch is lit:

Rear door windows can only be operated with the driver's door controls.



Power window in the front passenger seat

The control for the power window at the front passenger seat operates that window only.

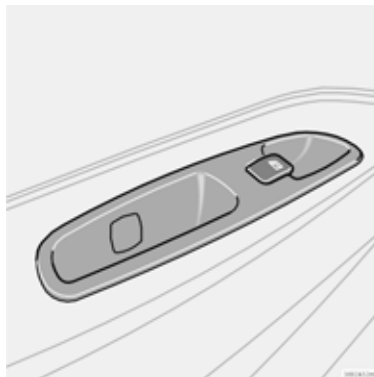

Power windows in the rear doors.

The rear door windows can be operated with the controls on the doors and the switch on the driver's door. If the LED in the switch for blocking power windows in the rear doors (located in the driver's door control panel) is lit, the rear door windows can only be operated from the driver's door.



WARNING!

If there are children in the car:
Make sure that their hands are free when closing the windows.
If operating the rear windows from the driver's seat:
Check that the back seat passenger's hands are free before closing the windows.

Rearview mirror/door mirrors

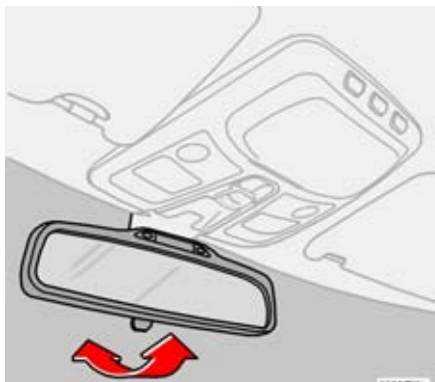

Rearview mirror

A: normal position.

B: dimming position. Use this if the glow from car headlamps behind irritate causes irritation.

Certain models have an **autodim** function, which provides automatic dimming based on existing light conditions. Your Volvo workshop can adjust the sensitivity.

Seat belt reminder

The seat belt warning symbol above the rearview mirror flashes until the driver fastens his or her seatbelt. On certain models, the seat belt reminder switches off after 6 seconds.

If the driver's seat belt is unfastened, the reminder switches back on at speeds exceeding 10 km/h and switches off if the speed drops below 5 km/h. If the belt is unfastened, the function reactivates at speeds exceeding 10 km/h.



WARNING!

Adjust the mirrors before you begin driving!

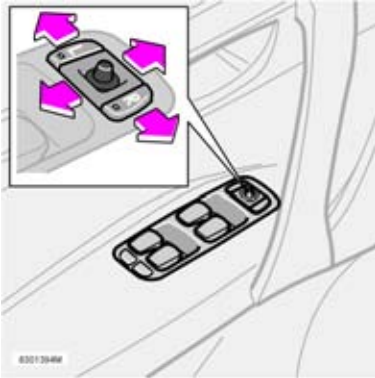

Door mirrors with memory function

If the car is equipped with door mirrors with memory function, they work together with the memory function of the seat, page 66.

Storing mirror settings in the remote control

When you unlock the car with the remote control and change the setting of the door mirrors, these new settings are saved in the remote control. The next time you unlock the car with the same remote control and open the driver's door within two minutes, the mirrors will assume their stored positions.

Door mirrors

The controls for setting the two door mirrors are at the front of the armrest on the driver's door.

- Press the L or R button (L = left door mirror, R = right door mirror). The LED in the button lights.
- Adjust the position with the adjustment control in the centre. Press the button again. The LED should no longer be lit.

Do not use ice scrapers with steel blades to remove ice from the mirrors as the glass could be scratched!

Power sunroof (option)

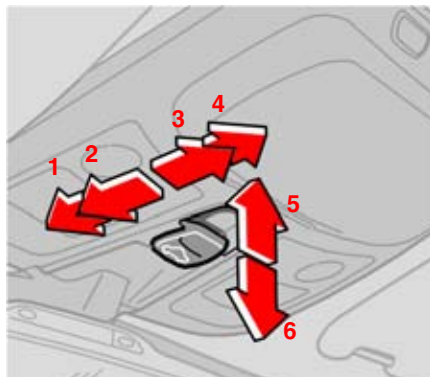
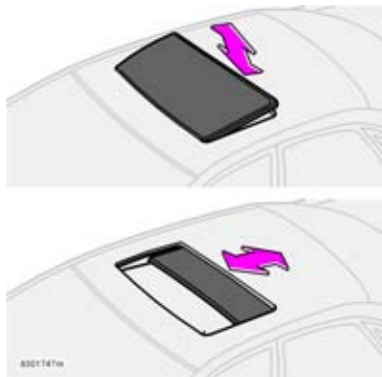

Opening positions

Sunroof controls are located in the headlining. The sunroof can be opened in two different ways:

- Raise/lower trailing edge – ventilation position
- Rearwards/forwards – opening position/comfort position*

The ignition key must be in position I or II.

Ventilation position

Open: Push the trailing edge of the control (5) upward.

Close: Pull the trailing edge of the control (6) downward.

Switch from **ventilation position** to **comfort position***: pull the control rearwards to its end position (4) and release.

*: In comfort position, the sunroof is not completely open in order to reduce the level of wind noise.

1. *Automatic closing*
2. *Manual closing*
3. *Manual opening*
4. *Automatic opening*
5. *Opening ventilation position*
6. *Closing ventilation position*

Opening position/comfort position*

Automatic control

Move the control over the resistance point position (3) to the rearmost end position (4) or over the resistance point position (2) to the front end position (1) and release. The sunroof will open to the **comfort position*** or will close completely.

In order to open from **comfort position*** to maximum opening: Pull the control to the rear once more to the end position (4) and release.

Manual control

Open: Pull the control rearwards to the resistance point position (3). The sunroof will move towards maximum opening position as long as the control is held in this position.

Close: Press the control forwards to the resistance point (2). The sunroof will move towards its closing position as long as the switch is held in this position.



WARNING!

If you have children in the car, make sure that their hands are clear when closing the sunroof.

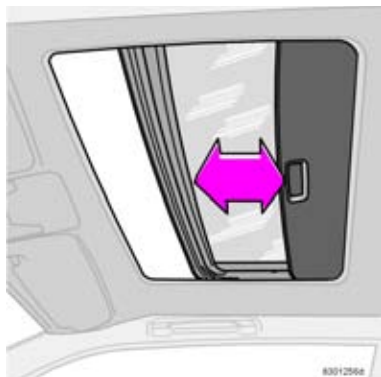

Sun screen

The sunroof also features a manually-operated sliding inner sun screen. The sun screen slides back automatically when the sunroof is opened.

Close the sun screen: Grasp the handle and slide the screen forwards.

Pinch protection

The sunroof pinch protection function is activated if the hatch is blocked by an object. If blocked, the sunroof will stop and automatically open to the previous open position.



WARNING!

Pinch protection functions only in the opening position – not in ventilation position.

Make sure the sunroof is properly closed before leaving the car.

Climate control

General on climate control	52
Air distribution	53
Electronic Climate Control (ECC)	54
Manual climate control with air conditioning, AC	58
Parking heater (option)	61

General on climate control

Misting on window interiors

A good way to reduce the problem of misting on the insides of the windscreen and other windows is to clean them. Use a normal window cleaner. Bear in mind that you must clean them more often if someone smokes in the car.

Ice and snow

Remove ice and snow from the climate control air intake (the grille between the bonnet and the windscreen).

Particle filter

Make sure the particle filter is replaced regularly. Consult your Volvo workshop.

Fault tracing

Your Volvo workshop has the instruments and tools required for fault tracing and repair of your climate control system. Checks and repairs should be performed by trained personnel only.

Environmental care

Refrigerant R134a is in the air conditioning system. This contains no chlorine, which means it is harmless to the ozone layer.

Use only R134a when topping up/refilling refrigerant. This work should be performed by an accredited workshop.

Cars with ECC

Actual temperature – ECC

The temperature you select corresponds to the physical experience with reference to air speed, humidity, exposure to sun, etc. which affect the interior and exterior of the car.

Sensors – ECC

The sun sensor is located on the upper portion of the dashboard. Do not cover the sun sensor or the passenger compartment temperature sensor located on the climate control panel.

Side windows and sunroof

To ensure that the air conditioning works satisfactorily, close all side windows and the sunroof (if fitted). Also, make sure the air ducts in the parcel are not blocked.

Acceleration

The air conditioning system switches off temporarily at full acceleration. You may feel a temporary rise in temperature.

Condensation/Drying

In warm weather, condensation from the air conditioning system may drip under the car. This is normal. If necessary, the fan will start 50 minutes after the ignition key is turned to position 0 in order to dry the climate control system for seven minutes. The fan then switches off automatically.

Fuel economy – Electronic Climate Control (ECC)

With ECC, the air conditioning system is controlled automatically and is used just enough to cool the passenger compartment and dehumidify the incoming air. This provides better fuel economy compared to conventional systems where the air conditioning cools the air to just above freezing point.

Air distribution

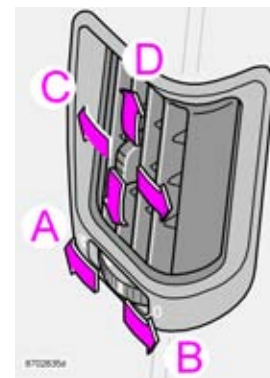
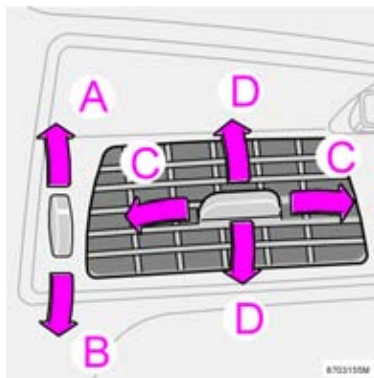
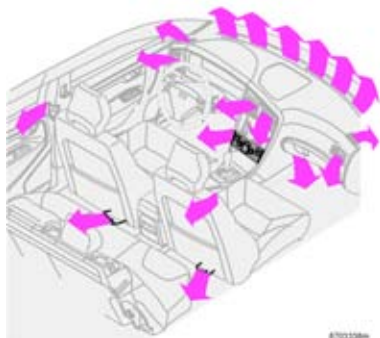

Air distribution

The incoming air is distributed through several different vents located throughout the car.

Air vents in the dashboard

A: Open.
 B: Closed.
 C: Lateral airflow.
 D: Vertical airflow.

- Aim the outer vents towards the side windows to remove misting.
- In cold climates: close the centre vents for the most comfortable climate and best demisting.

Air vents in the door pillars (standard with ECC - option in certain markets)

A: Open.
 B: Closed.
 C: Lateral airflow.
 D: Vertical airflow.

- Aim the vents toward the rear side windows to remove misting.
- Aim the vents inwards in the car for a comfortable climate in the rear seat.

Bear in mind that small children can be sensitive to airflow and draughts.

Electronic Climate Control (ECC)

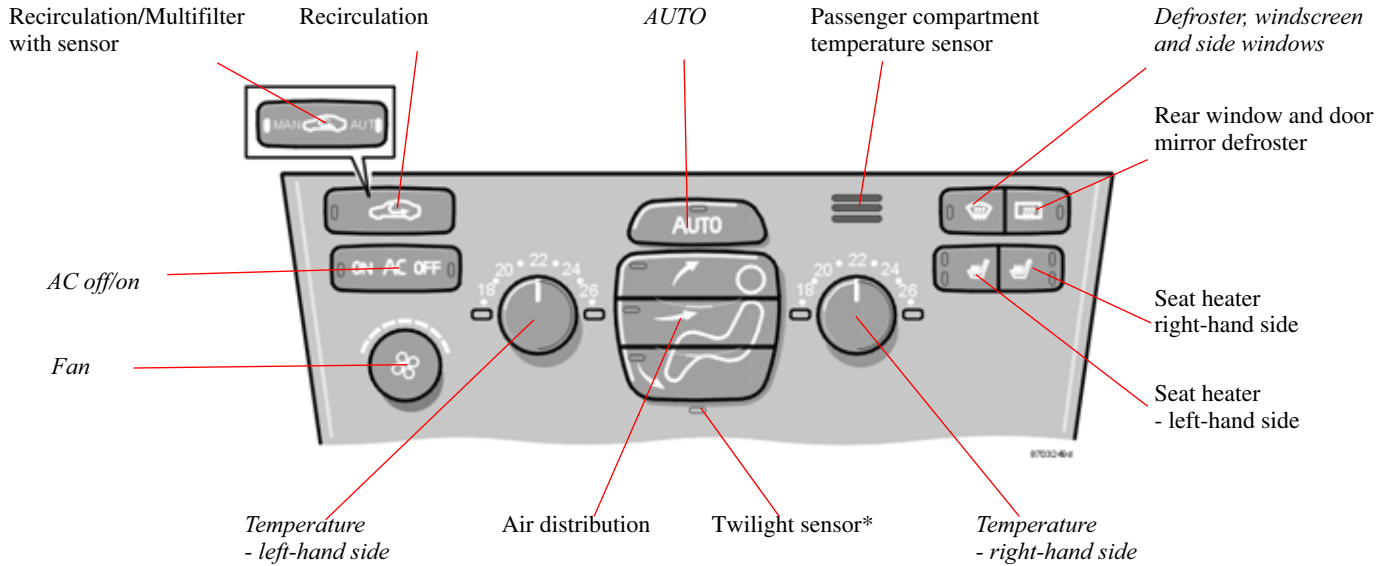

* Automatically regulates illumination of instruments.



AUTO

The AUTO function automatically regulates climate control so that the desire temperature is attained. The automatic

function controls heating, air conditioning, fan speed, recirculation, and air distribution. If you select one or more functions manually, the other functions continue operating automatically. All manual settings are switched off when AUTO is switched on.



Rear window and door mirror defrosters

Use this button to quickly remove misting and ice from the rear

window and door mirrors, see page 39 for more information about this function.



Temperature

The two knobs can be used to set the temperature for the passenger and driver's sides of the car. Remember that the car does not heat up or

cool down any more quickly even if you select a higher or lower temperature than you want in the passenger compartment.

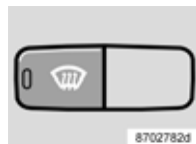

Defroster - windscreen and side windows

Use this button to quickly remove misting and ice from the

windscreen and side windows. The air flows to the windows at high fan speed. The LED in the defroster button lights when this function is activated. The air conditioning system is now controlled so that the air is maximally dehumidified. The air is not recirculated.



Fan

Fan speed can be increased or decreased by turning the knob. If AUTO is selected, fan speed is controlled

automatically. The previously set fan speed is disconnected.

NOTE! If the knob for the fan has been turned so far that the left LED above the knob lights up with an orange light, the fan and the air conditioning system are switched off.

Electronic Climate Control (ECC) (Contd)



Air distribution

Air to windows

Air to head and body

Air to legs and feet

Press AUTO to return to automatic air distribution.



AC - ON/OFF

The air conditioning system is controlled automatically by the system when the ON LED is lit. This way, incoming air is cooled and dehumidified sufficiently. When AC OFF is selected and the OFF LED lights, the air conditioning system is disconnected; other functions are still controlled automatically. The air conditioning system operates down to approximately 0 °C.

When you select Defroster  the air conditioning system is controlled so that air is maximally dehumidified.



Heated front seats

Do as follows for heated front seat(s):

- Press once: High heat – both LEDs in the switch light up.
- Press twice: Low heat – one LED in the switch lights up.
- Press three times: Heating switched off – no LEDs in the switch light up.

Your Volvo workshop can adjust the temperature.





Recirculation

Recirculation can be used to shut out bad air, exhaust, etc. from the passenger compartment. The air in the passenger compartment is then recirculated, i.e. no air from outside the car is taken into the car when this function is activated.

If you allow the air in the car to recirculate, there is a risk of icing and misting, especially in winter.

The **timer function** (cars with Multifilter and air quality sensor have no timer function) minimises the risk for ice, misting and bad air.

Activate the function as follows:

- Press  for more than 3 seconds. The LED flashes for 5 seconds. The air recirculates in the car for 3-12 minutes depending on the outside temperature.
- The timer function is activated each time you press .

To switch off the timer function:

- Press  again for more than 3 seconds. The LED lights for 5 seconds to confirm your selection.

Recirculation is always disconnected when you

select  Defroster.



Multifilter with air quality sensor (option)

Certain cars are equipped with a "Multifilter" and air quality sensor. The

Multifilter separates gases and particles, thus reducing the volume of odours and pollutants entering the car. The air quality sensor detects increased levels of contaminants in the outside air. When the air quality sensor detects contaminated outside air, the air intake is closed and the air in the compartment is recirculated. The Multifilter also cleans the air recirculating in the compartment.

When the air quality sensor is active, the green AUT LED lights in .

Operation

Press  to activate the air quality sensor (normal setting).

Or:

Select one of the following three functions by pressing  repeatedly.

1. The AUT LED lights. The air quality sensor is now activated.
2. No LED lights. Recirculation is not activated unless needed to cool in a warm climate.
3. The LED MAN lights. Recirculation is now activated.

Keep in mind the following:

- Make it a rule to have the air quality sensor activated at all times.
- Recirculation is limited in cold climates to avoid misting.
- If misting occurs, you should deactivate the air quality sensor.
- If misting occurs, you can use the defroster functions for the windscreen, side windows and rear window. See page 55.
- Follow the Volvo service program for the recommended replacement interval of the Multifilter. If the car is used in environments where more contaminants are present, it may be necessary to change the Multifilter more often.

Manual climate control with air conditioning, AC

- You must turn the fan knob (from the 0 position) to connect the air conditioning.
- Use the air conditioning at low temperatures (0–15 °C) to dehumidify incoming air.

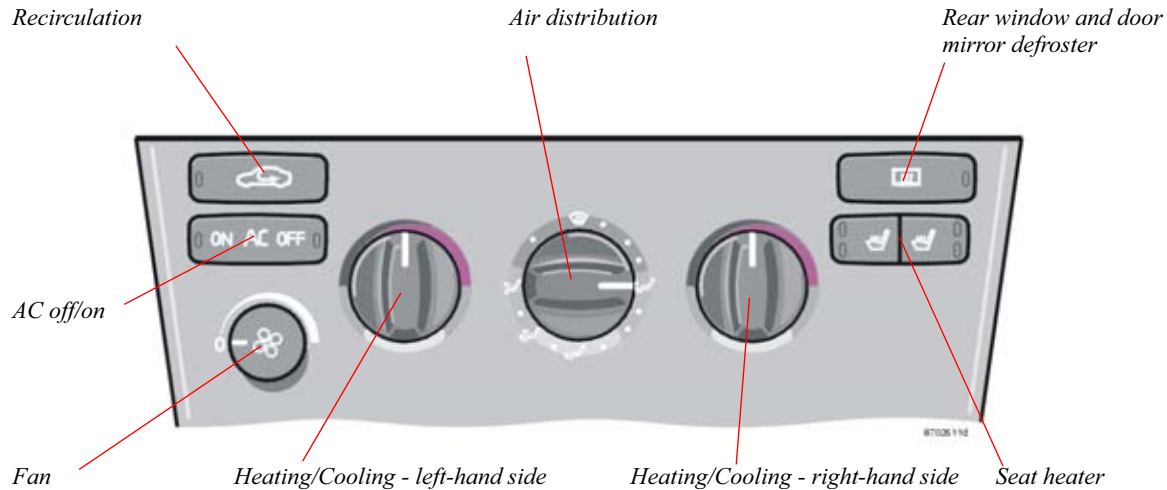



AC - ON/OFF

The air conditioning is connected to the cooling and dehumidification function with the ON LED lights. The air

conditioning is disconnected with the OFF LED lights.

When you select Defroster , the air conditioning is connected as long as the fan is not set to position 0.



Fan

Fan speed can be increased or decreased by turning the knob. If the knob is set to 0, the air conditioning is disconnected.



Heating/Cooling - left/right-hand side

Turn to set how warm or cold the incoming air should be. For cooler air, the air conditioning must be connected.

window and door mirrors, see page 39 for more information about this function.



Heated front seats

Do as follows for heated front seat(s):

- Press once: High heat – both LEDs in the switch light up.
- Press twice: Low heat – one LED in the switch lights up.
- Press three times: Heating switched off – no LEDs in the switch light up.

Your Volvo workshop can adjust the temperature.

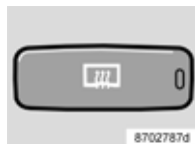

Rear window and door mirror defroster

Use this button to quickly remove misting and ice from the rear

Manual climate control with air conditioning, AC (Contd)





Recirculation

Recirculation can be used to shut out bad air, exhaust, etc. from the passenger compartment.

The air in the passenger compartment is then recirculated, i.e. no air from outside the car is taken into the car when this function is activated. Recirculation (together with the air conditioning system) cools the passenger compartment more quickly in a warm climate.

If you allow the air in the car to recirculate, there is a risk of icing and misting, especially in winter. The timer function minimises the risk of ice, misting and bad air.

Activate the function as follows:

- Press  for more than 3 seconds. The LED flashes for 5 seconds. The air recirculates in the car for 3-12 minutes depending on the outside temperature.
- The timer function is activated each time you press .

To switch off the timer function:



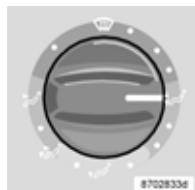

- Press  again for more than 3 seconds. The LED lights for 5 seconds to confirm your selection.

Recirculation is always disconnected when you select  Defroster.



Air distribution

Use the air distribution control positions (marked with dots) between the different symbols to fine-tune air distribution for maximum comfort.

Air distribution	Use
 Air through front and rear air vents.	When you want good cooling in a warm climate.
 Air to windows. Air is not recirculated in this position. Air conditioning is always connected. There is a certain amount of airflow to the air vents.	When you want to remove ice and misting. High fan speed is good for this.
 Air to both floor and windows. There is a certain amount of airflow to the air vents.	When you want comfortable conditions and good demisting in a cold climate. Not too low a fan speed.
 Air to floor. There is a certain amount of airflow to the air vents and the defroster vents for the windscreen and side windows.	When you want to warm your feet.
 Air to floor and air vents.	In sunny weather with cool outside temperature.

Parking heater (option)

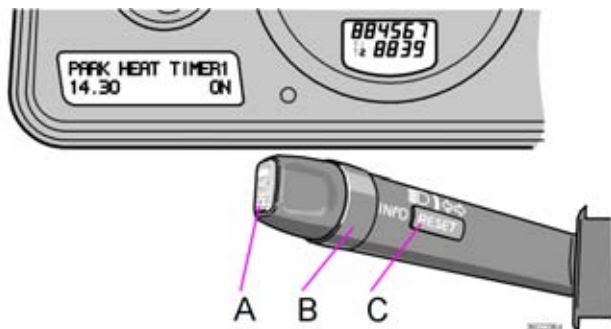

The parking heater can be started immediately or set for two different start times using TIMER 1 and TIMER 2. Start time refers to the time when the car should be warmed and ready. The car's electronic system calculates the start time based on the outdoor temperature. If the outdoor temperature exceeds 25 °C, no heating will occur. At temperatures of -7 °C and below, the maximum heater running time is 60 minutes.

If repeated attempts to start the parking heater are unsuccessful, an error message is shown in the display - contact a Volvo workshop.

The car must be outdoors

Remember that the car must be outdoors when using petrol and diesel heaters.

Parking on a hill

If you park your car on a steep incline, the front of the car should be facing up the slope to ensure the supply of fuel to the parking heater.

Immediate heater start

- Use the thumb wheel (B) to select DIRECT START.

Press the RESET button (C) to make ON and OFF selections available.
Select ON.

Brief press of RESET (C)	setting of hours and minutes
Long press of RESET	timer activated (ON)
Long press of RESET	timer switched off (OFF)
ON lamp lights with a steady glow	the timer is activated
ON lamp flashes	the parking heater is activated

The heater will run for 60 minutes. Heating in the passenger compartment starts as soon as the engine coolant has reached a temperature of 20°C.

Deactivation of heater after direct start

- Use the thumb wheel (B) to select DIRECT START.
- Press the RESET button (C) to make ON and OFF selections available.
- Select OFF.

Parking heater (option) (Contd)

Setting TIMER 1 or 2

For reasons of safety, you can only programme times for the following 24 hours, not several days in a row.

1. Use the thumb wheel (B) to select TIMER 1.
2. Briefly press the RESET button (C) so that the hours setting starts to flash.
3. Use the thumb wheel to set the desired number of hours.
4. Give the RESET button (C) a short press to come to the flashing minutes setting.
5. Use the thumb wheel to set the desired number of minutes.
6. Give the RESET button (C) a short press to confirm your setting.
7. Press the RESET button (C) to activate the timer.

Once you have set TIMER 1, you can toggle to TIMER 2. Make settings the same way as for TIMER 1.

Deactivation of timer-started heater

Do as follows to manually switch off the heater before the set time has elapsed:

1. Press the READ button (A)
2. Use the thumb wheel (B) to scroll to the text PARK HEAT TIMER 1 or 2. The text ON flashes.

Press the RESET button (C). The text OFF is displayed with a steady glow and the heater is switched off.

Messages in the display

Once TIMER 1, TIMER 2 and Immediate start are activated, the amber symbol in the combined instrument panel lights and explanatory text is shown in the display.

When you leave the car, you will receive a message regarding the current settings of the system.

Car clock/timer

For safety reasons, all timer settings will be cleared if the car clock is reset after timer settings have been made.

Battery and fuel

If the battery is not sufficiently charged or the petrol tank is close to empty, the parking heater will be switched off.

If this is the case, you will receive a message in the display. Confirm the message using the READ button (A).

IMPORTANT!

Repeated use of the parking heater combined with only short journeys can discharge the battery and impair starting.

In order to ensure that the generator receives sufficient time to produce the amount of energy needed without discharging the battery as a result of regular heater use, drive the car for a period equalling the time during which the heater has been active.

Interior

Front seats	64
Interior lighting	68
Storage compartments in the passenger compartment	70
Rear seat and cargo compartment	75
Spare wheel and tools	77
Warning triangle (certain countries)	78

Front seats

Height adjustment

The front edges of the driver's and passenger seats can be adjusted to seven different settings and the rear edges to nine different settings.

The front level (A) - adjusts the front edge of the seat.

The rear lever (B) - adjusts the rear edge of the seat.

Front-rear adjustment

The seat can be moved forward or backward when the bracket is lifted.

Check that the seat has locked into position after adjusting.



WARNING!

Adjust the seat before you begin driving.

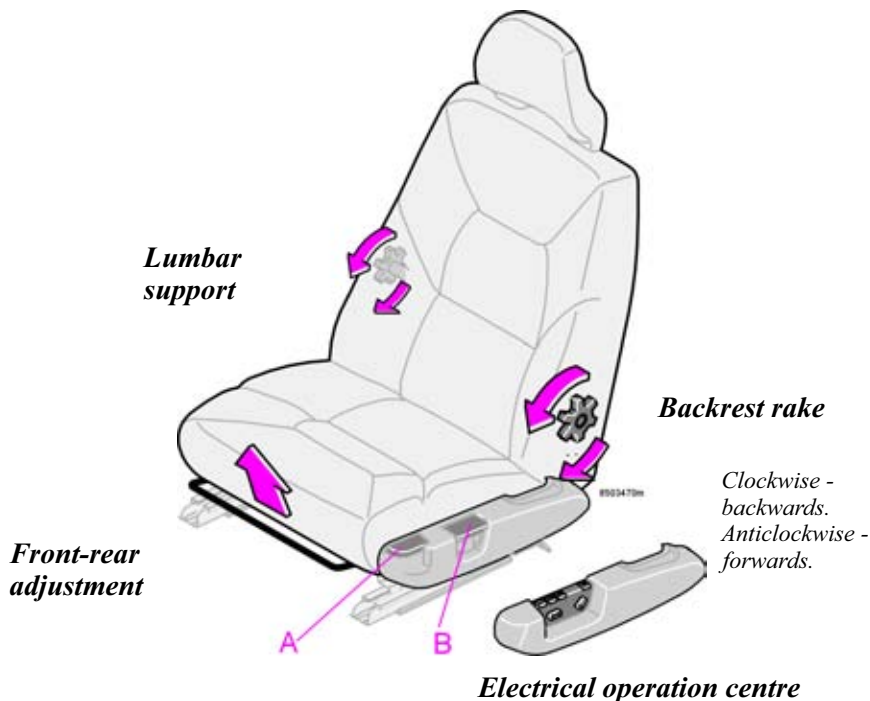

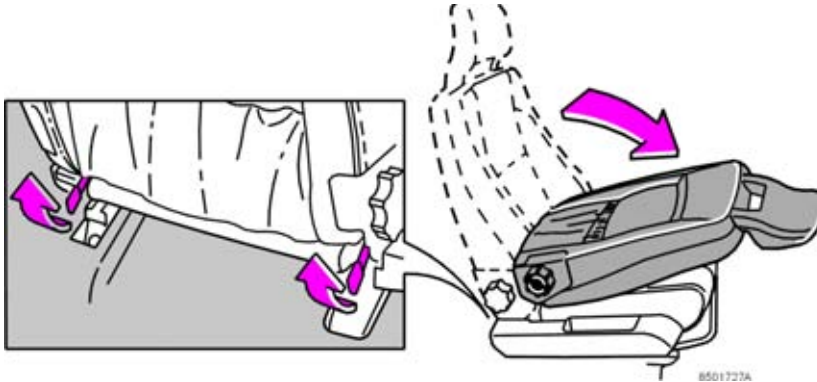

Tipping the front seat backrest

The front passenger seat backrest can be folded to a horizontal position to make room for a long load. Fold the backrest as follows:

- Move the seat as far back as possible.
- Adjust the backrest to the upright position.
- Lift the catches on the rear of the backrest.
- Fold the backrest forward.

Front seats (Contd)

Power seat (option)

Preparations

Passenger seat: The seat can only be adjusted if the ignition key is in position I or II.

Driver's seat: The seat can be adjusted if the ignition key is in position I or II. It can also be adjusted in the following circumstances:

1. Within 40 seconds of the ignition key being turned to position 0 or removed from the ignition switch.
2. After you have unlocked the driver's door with the key or remote control, the driver's seat can be adjusted during a 10 minute period **if the door remains open**. If the door is closed, the seat can be adjusted for 40 seconds. The ignition key can be in position 0 or not yet inserted in the ignition switch.

Storing seat settings in the remote control

When you unlock the car with the remote control and change the position of the driver's seat, these new settings are saved in the remote control. The next time you unlock the car with the same remote control and open the driver's door within two minutes, the driver's seat will assume its stored position.

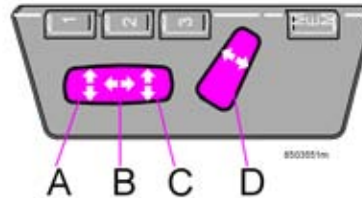

Seat adjustment

If your Volvo is equipped with power seats, the following may be adjusted with the two switches at the side of the seat:

- A - Height of front seat edge.
- B - Forwards - backwards.
- C - Height of rear seat edge.
- D - Backrest rake.

NOTE! The power seats have an overload protector that activates if a seat is blocked by any object. If this occurs, switch off the ignition (key in position 0) and wait about 20 seconds before using the seat again.

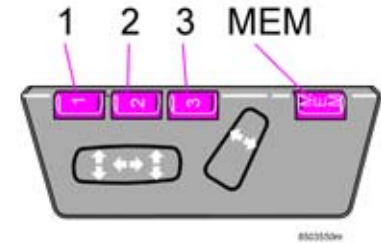

Seats with memory function (option)

Three positions can be stored. After adjusting the seat and the door mirrors, hold the MEM button depressed while pressing button 1. Further seat and door mirror settings can be stored in the memory using buttons 2 and 3.

Setting preset positions

Hold memory button 1, 2 or 3 pressed until the seat stops.

For reasons of safety, the seat will stop moving if one of the setting buttons is released.

Emergency stop

If the seat accidentally begins to move, press one of the buttons to stop the seat.

**WARNING!**

When adjusting, ensure that there are no objects in front of or behind the seat.

Make sure that the rear seat passengers will not be pinched. To avoid this possibility, do not let children play with the switches.

Interior lighting



General lighting

General lighting can be switched on and off with the centre button. General lighting has a built-in automatic function, which means that general lighting switches on and remains lit for 30 seconds:

- When you unlock the car from the outside using the key or remote control.
- When you have stopped the engine and turned the ignition key to position 0.

General lighting switches on and remains lit for 10 minutes:

- When one of the doors is open.
- When general lighting does not switch off.

General lighting switches off:

- When the engine is started.
- When you lock the car from outside using the key or remote control.

General lighting switches off automatically 10 minutes after the ignition has been turned off if not switched off manually.

General lighting can be switched off or on in all situations by briefly pressing the button.

You can disconnect the automatic function by pressing the button for more than 3 seconds. When you then briefly press the button, the automatic function reconnects.

The pre-programmed times of 30 seconds and 10 minutes can be changed. Contact an authorised Volvo workshop.



Front and rear reading lamps

Switch on the front seat or rear seat reading lamps with the corresponding button.

The lamps switch off automatically 10 minutes after the ignition has been turned off if not switched off manually.



Floor mats (option)

Volvo offers custom made floor mats for your car. They must be properly placed and secured in the mat clips on order that they not become entangled the pedals.

Vanity mirror

The lamp comes on when you open the cover.

Storage compartments in the passenger compartment

Storage pocket

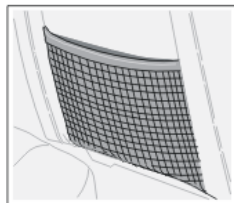

Door panel compartment

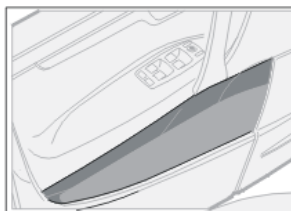

Ticket clip



Cup holder

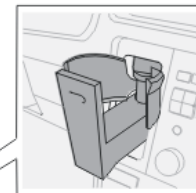

Glovebox

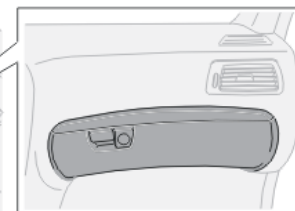

⚠ WARNING!

Make sure no hard, sharp or heavy objects lie or protrude in such a way that they could cause injury during heavy braking.

Always fasten large, heavy objects with one of the seat belts.

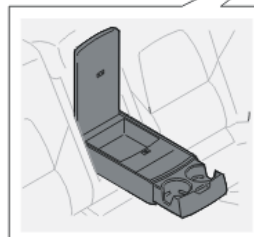

Cup holder in the armrest, rear seat

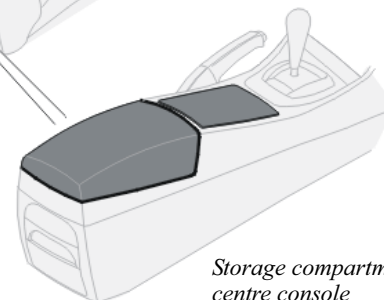

Storage compartment in the centre console

8503195m

Storage compartments in the centre console

Cup holder (option)

Certain models are equipped with cup holders for the front seat passengers.

You can use the storage compartment in the centre console for CDs and the like.

Coin compartment

If you wish to remove the coin compartment, pull it directly upwards.

Ashtray (option)

Pull out the insert to empty the ashtray.

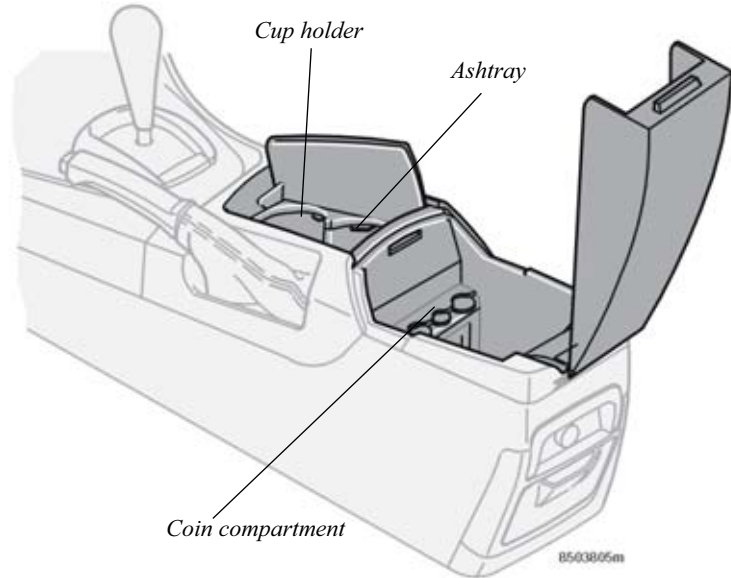

Storage compartments in the passenger compartment (Contd)

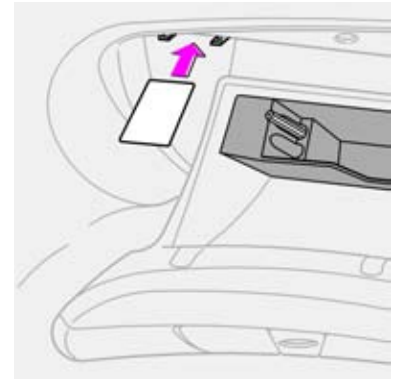
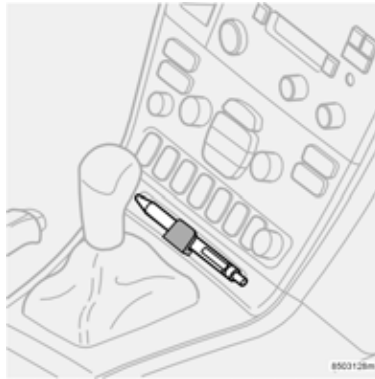
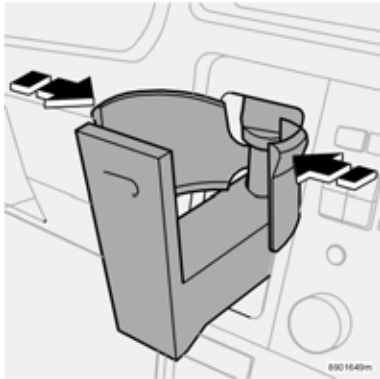

Dashboard cup holder (option)

- Press the holder to open.
- Adjust the holder to the size of the cup by pressing the arms inward.
- Press the holder in after use.

Pen holder

The dashboard contains a penholder.

Glovebox

The glovebox can be used to store things such as the owner's manual, maps, pens and petrol cards.

NOTE! Never use glass bottles. Remember also that hot drinks may cause burns.

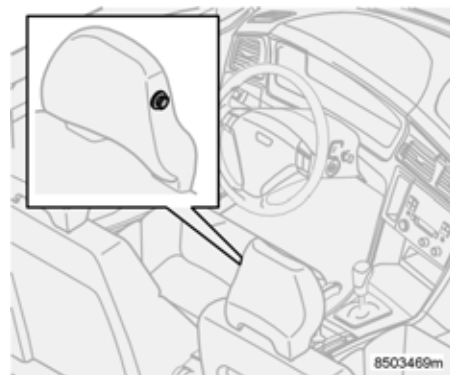

Coat hanger

Use the coat hanger for clothes of normal weight.

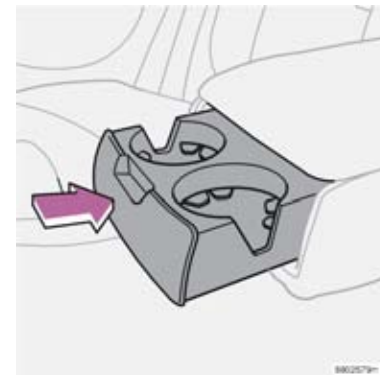

Cup holder in the armrest, rear seat

Storage compartments in the passenger compartment (Contd)

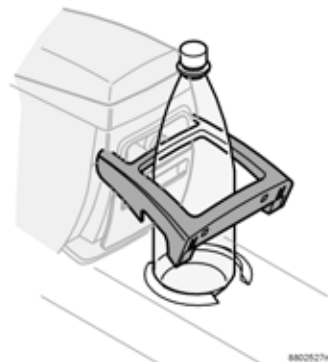
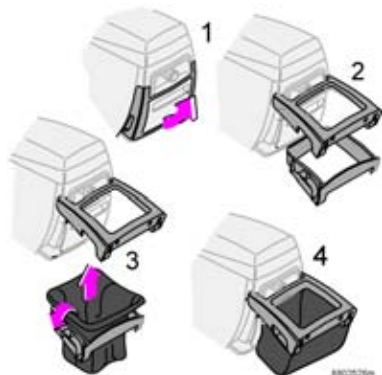

Waste bin/bottle holder for the rear seat (option)

Proceed as follows to change the bin bag:

1. Open the holder.
2. Use both hands to press out the bottom of the holder.
3. Fit the bag around the bottom portion and press it back onto the top portion.
4. The bag is ready for use.

NOTE! The bin does not require special bags.
– Use a regular plastic bag.

The waste bin can also be used to hold large bottles.

NOTE! For reasons of safety, glass bottles should never be used anywhere in the car!

Rear seat and cargo compartment

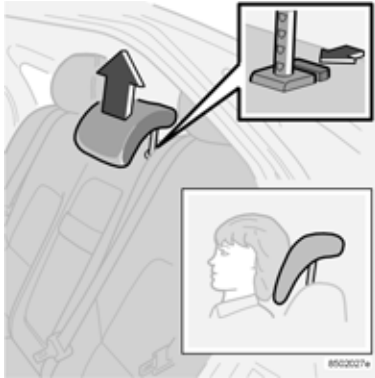

Adjust the head restraint vertically

Rear seat head restraints

The centre seat head restraint can be adjusted vertically to suit the height of the passenger. Raise the head restraint as needed. The release button on the right-hand support must be pressed to push the head restraint down. See the illustration!

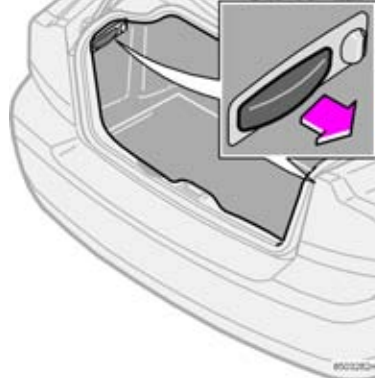

Tipping the rear seat backrest

Both rear seat backrests can be tipped forward, together or individually. This makes it easier to transport long objects.

Fold the rear seat backrests as follows:

- Check first that the head restraint is folded down.
- Pull the handle in the cargo compartment as shown in the illustration.
- Fold the backrest forward.

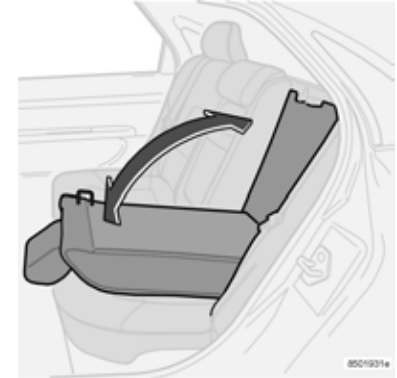

WARNING!

Always secure the load. During heavy braking the load may otherwise shift, causing personal injury. Cover sharp edges with something soft. Turn off the engine and apply the parking brake when loading or unloading long objects! You may accidentally knock the gear lever or gear selector with the load and cause a gear to engage and the car to move off.

Rear seat and cargo compartment (Contd)

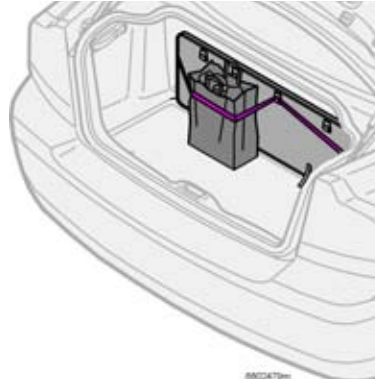
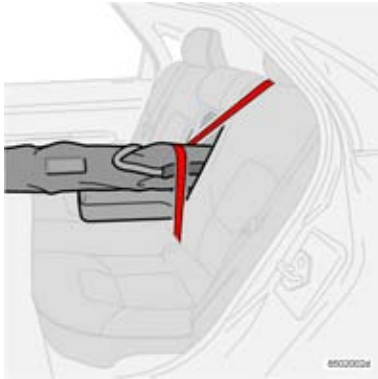

Hatch for long objects

A hatch in the right-hand rear backrest allows you to transport long objects such as skis and planks. Open the hatch as follows:

- Tip the right-hand backrest forwards. See page 75.
- Release the hatch by pushing the catch upward while folding the hatch forward.
- Tip the backrest back into position with the hatch open.
- Use the seat belt to secure the load.

Grocery bag holder (option)

Open the boot lid. Hang or secure your grocery bags using the tensioning straps or holders.

Spare wheel and tools

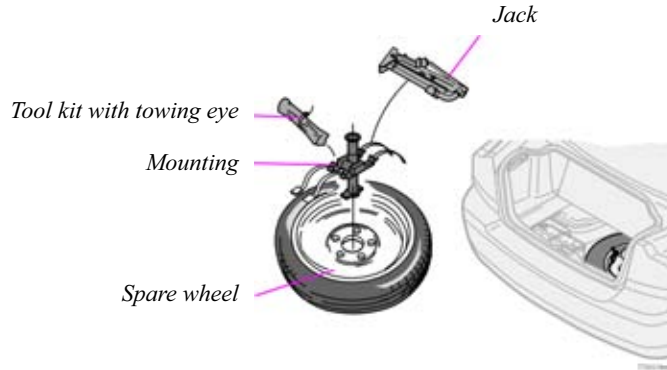

Spare wheel, tools and jack

The spare wheel, jack and tool kit are located under the floor of the cargo compartment. Remove the spare wheel as follows:

- Pull up the floor mats, front and rear
- Remove the jack and tool kit.
- Unscrew the spare wheel and lift it out.

If the car is equipped with a grocery bag holder:

- Turn the two clips, which are located at the rear corner of the mat, 90°.
- Pull the front of the floor mat back towards the boot lid opening.
- Lift the mat slightly and turn 90° to lift it out.
- Lift the mat out of the cargo compartment.
- Unscrew the spare wheel and lift it out.
- Return and secure everything in reverse order. Make sure that the spare wheel is securely in place and that the jack and tool kit are properly secured.

Warning triangle (certain countries)

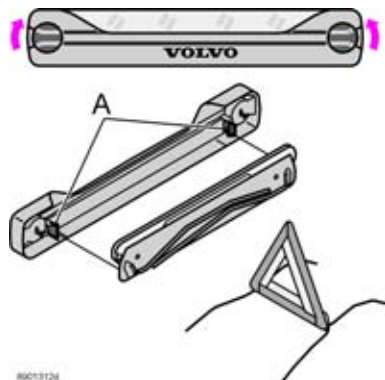

After use:

- Pack everything in reverse order.
- Make sure the warning triangle and its case are properly secured in the boot lid.

Warning triangle

Follow the warning triangle regulations of the country you are in.

Use the warning triangle as follows:

- Turn both attachment screws to the vertical position.
- Carefully remove the warning triangle case.
- Remove the warning triangle from its case (A).
- Fold out the four support legs on the warning triangle.
- Fold out both red sides of the warning triangle. Place the warning triangle in a location that is appropriate for the traffic situation.

Locks and alarm

Keys and remote controls	80
Locking and unlocking	82
Child safety locks	85
Alarm (option)	87

Keys and remote controls

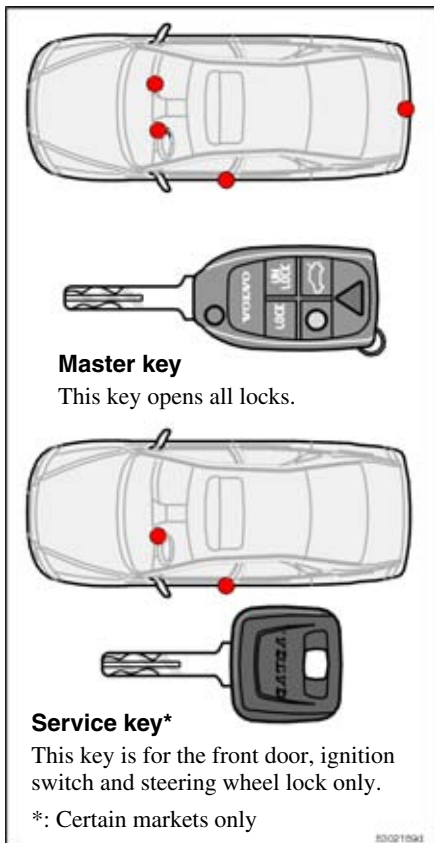

Keys - Immobilizer

Your car is delivered with two master keys and one service key. One of the master keys is foldable and equipped with an integrated remote control.

Loss of key

If you should lose one of your keys, bring the remaining keys to an authorised Volvo workshop. As a crime prevention measure, the code for the lost key is erased from the system and the other keys must be re-coded in the system.

The mechanical code numbers for the keys are recorded on a separate label accompanying the keys. Store the label in a safe place. Take the label to your Volvo dealer if you wish to order new keys. A maximum of six remote controls/keys can be programmed and used.

Immobilizer

Each key has an integrated coded chip. The code must be the same as the code in the ignition switch receiver. The car can only be started if the correct key with the correct code is used.



1. Unlock
2. Open boot lid
3. Alarm function
4. Approach lighting
5. Lock
6. Fold/open key

Remote control functions

1. Unlocking

Button 1 unlocks all doors, boot lid and fuel filler flap.

2. Boot lid

Press button 2 to unlock the boot lid only.

3. Alarm function

The alarm function can be used to attract attention during emergency situations. If the red button (3) is held for at least 3 seconds or is pressed twice in succession during the same amount of time, the direction indicators and horn will be activated. The alarm can be deactivated with any of the remote control buttons or it will shut off automatically after 25 seconds.

4. Approach lighting

Do the following when you approach the car:

- Press the yellow button (4) on the remote control.

The interior lighting, position/parking lights, numberplate lighting and door mirror lamps (option) will switch on. These lamps will remain lit for 30, 60 or 90 seconds. A Volvo workshop can set a suitable duration for your car.

To extinguish the approach lighting:

- Press the yellow button again.

6. Folding/opening key

The key can be folded by pressing button 6 while folding the key blade into the keypad.

The folding key will open automatically with one press of the button.

5. Locking

Lock all doors, boot lid and fuel filler flap with button 5.

There is a delay of approx. 10 minutes for the fuel filler flap.

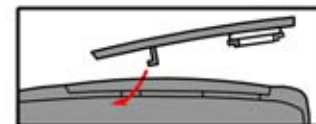
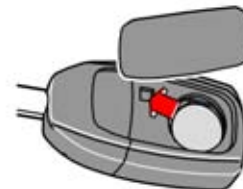

XC90 1600

Changing the remote control battery

Replace the battery after repeated failure by the locks to respond when remote control signals are transmitted within a normal distance.

- Remove the cover by carefully prising up the rear edge of with a small screwdriver.
- Replace the battery (type CR 2032, 3 volt) – the plus side should face up. Avoid touching the battery or its contact surfaces with your fingers.
- Refit the cover. Make sure the rubber seal is properly fitted and free from damage to prevent water from entering.

Turn the old battery in to your Volvo workshop so that it can be disposed of in an environmentally-friendly manner.

Locking and unlocking



Locking and unlocking the car from the outside

Using the master key or its remote control, all doors and the boot lid can be locked and unlocked simultaneously – from the outside. – In this mode, all door locks and inside door handles are inoperative.

The fuel filler flap can be opened when the car is unlocked. The filler flap remains unlocked for ten minutes after the car has been locked.

Automatic re-locking

If none of the doors or the boot lid are opened within two minutes of unlocking from the outside with the remote control, all locks relock automatically. This function prevents you from unintentionally leaving the car unlocked.

For cars with alarms, see page 88.



Locking and unlocking the car from the inside

Using the control in the door panel, you can lock or unlock all doors and the boot lid simultaneously.

All doors can also be locked or unlocked with the lock buttons.

The above applies only if the car was not locked from the outside!



Opening/locking the boot lid with the remote control

Do as follows to unlock the boot lid only:

- Press the boot lid button on the remote control slowly twice. The boot lid will then open.

If all doors are locked when you close the boot lid, it locks automatically.

Unlocking the boot lid manually with the master key

The master key should be used when unlocking the boot lid manually during emergencies only, e.g. if the remote control does not function or the car is without power. Open the boot lid as follows:

- Insert the master key into the upper or lower section of the lid covering the lock.
- Twist up or down in order to prise the lid off.
- Unlock the boot lid.

Locking the boot lid* (certain countries)

Press this button to lock the boot lid. The boot lid then remains locked even if the doors are unlocked with one of the keys or remote controls.

- Turn the master key to position II.
- Press in the button. An LED in the button lights when the function is activated and a message is shown in the display.
- Turn the key to position II and press in the button again to switch off the function.

*: Master key only

Locking and unlocking (Contd)

Locking the glovebox

The glovebox can be locked/opened with the master key only – not with the service key.

Deadlocks

Your car has a special deadlock function, which means that the doors cannot be opened from the inside if they are locked.

Deadlocks can only be activated from the outside by the driver's door being locked with the key or remote control. All doors must be closed before deadlocks can be activated. Once activated, the doors cannot be opened from the inside. The car can only be unlocked from the outside via the driver's door or by using the remote control.

Deadlocks are engaged after a 25 second delay once the doors have been locked.

Temporary deactivation of deadlocks and any detectors.

If others prefer to remain seated in the car with the doors locked from the outside – e.g. during transport by ferry, – it is possible to deactivate the deadlocks.

- Insert the key in the ignition switch, turn it to position II and then back to position I or 0.
- Press the button.

If the car is equipped with an alarm, movement and tilt detectors are also deactivated. See page 88.

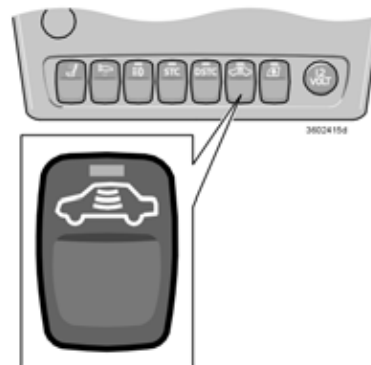

The LED in the button lights until you lock the car with the key or remote control. A message is shown in the display as long as the key remains in the ignition switch. The detectors will be reactivated the next time you switch on the ignition.



WARNING!

Do not allow anyone to remain in the car without first deactivating the deadlock.

Child safety locks

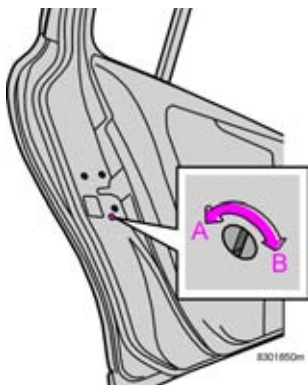

Control for child safety lock - left rear door

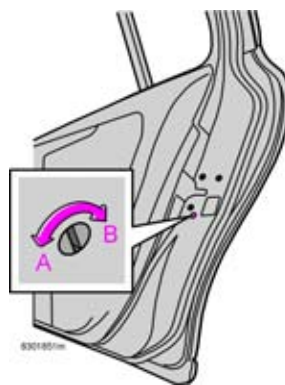

Child safety lock controls - right rear door.

Manual child safety locks - rear doors

The controls for the child safety locks are in the rear edges of the rear doors and are only accessible when the door is open. Use the ignition key to turn the control and thus activate or deactivate the child safety lock.

A - Doors cannot be opened from the inside (turn outwards).

B - Doors can be opened from the inside (turn inwards).



WARNING!

Remember that in the event of an accident, rear seat passengers cannot open rear doors from the inside if the child safety locks are activated.

Therefore, keep the doors unlocked while driving!

In the event of an accident, rescue personnel will then be able to enter the car quickly from the outside.

Child safety locks (Contd)

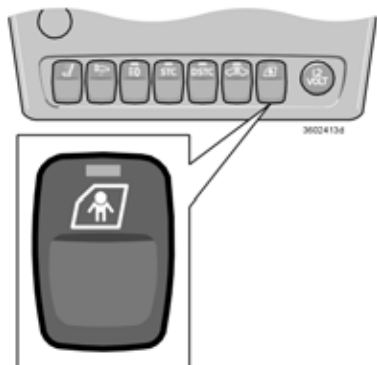

All settings in the manual child safety system are set aside when you **activate** the electric child safety locks.

Electric child safety locks - rear doors (option)

Use the button in the centre console to activate or deactivate the child safety locks in the rear doors. The ignition key must be in position I or II. The LED in the button comes on when the child safety lock is activated. A message appears in the display when you activate or deactivate the child safety lock.

NOTE! The rear doors cannot be opened from the inside while the **electric** child safety locks are activated.

Alarm (option)

The alarm system

When the alarm is engaged, it continually monitors all alarm points. The alarm is triggered if:

- the bonnet is opened
- the boot lid is opened
- a side door is opened
- the ignition switch is turned with a non-approved key or subjected to force
- movement is detected in the passenger compartment (if a motion sensor is fitted - option for certain markets only)
- the car is raised or towed away (if a tilt sensor is fitted - option for certain markets only)
- the battery cable is disconnected
- an attempt is made to disconnect the siren.

Activating the alarm

Press the LOCK button on the remote control. A long flash signal from the direction indicators of the car confirm that the alarm is activated and all doors are closed. In certain markets, the key or the control in the driver's door can be used to arm the alarm.

Deactivating the alarm

Press the UNLOCK button on the remote control. Two short flash signals from the direction indicators of the car confirm that the alarm is deactivated. In certain markets, the key can be used to deactivate the alarm.

Automatic alarm reset

If none of the doors or the boot lid are opened within two minutes of the alarm being deactivated, and the car was unlocked with the remote control, the car reactivates the alarm automatically. The car locks at the same time. This function prevents you from accidentally leaving the car without the alarm on.

In certain countries (e.g. Belgium, Israel) the alarm is reactivated after a certain delay if the driver's door was opened and closed but the car was not re-locked.

Deactivating a triggered alarm

Press the UNLOCK button on the remote control if the alarm sounds and you wish to deactivate it. Two short flashes of the direction indicators are given as confirmation.

Audio signal - Alarm

The audio signal is given from a siren with a reserve battery. Each alarm signal lasts 25 seconds.

Visual signal - Alarm

When the alarm is triggered, all direction indicators flash for 5 minutes or until the alarm is deactivated as described earlier.

NOTE! Even if your remote control does not work or you have lost it, you can start the car as follows: open the driver's door with the key. The alarm is triggered and the siren sounds. Start the car as usual. The alarm will then be deactivated.

Alarm (option) (Contd)



Temporary deactivation of detectors and deadlocks

To avoid inadvertently triggering of the alarm, for example when leaving a dog in the car or during a ferry crossing, the movement and tilt detectors can be temporarily deactivated:

- Insert the key in the ignition switch, turn it to position II and then back to position I or 0.
- Press the button.

The LED in the button lights until you lock the car with the key or remote control.

A message will be shown in the display as long as the key remains in the ignition switch. The sensors will be reactivated when the ignition is restarted.

If your car has deadlocks, they are reactivated at the same time. See page 84.

Indicator lamp on the dashboard (certain countries)

An indicator lamp (LED) at the top of the dashboard indicates alarm status:

- Lamp not lit: Alarm is deactivated.
- Lamp flashes once a second: The alarm is activated.
- Lamp flashes quickly, after deactivating the alarm and until the ignition is switched on: The alarm has been triggered.

If a fault has occurred in the alarm system, a message will be shown in the display.

If the alarm system is not functioning properly, have your car checked at an authorised Volvo workshop.

WARNING!

Do not attempt to repair or modify alarm system components. All such attempts can affect terms of insurance.

Testing the alarm system

Testing the passenger compartment motion sensor:

1. Open all windows.
2. Activate the alarm. Alarm activation is confirmed with a slow flash of the LED.
3. Wait 30 seconds.
4. Test the movement detector in the passenger compartment by lifting a bag or the like from the seat. The alarm should now sound and flash.
5. Deactivate the alarm by unlocking with the remote control.

Testing the doors:

1. Activate the alarm.
2. Wait 30 seconds.
3. Unlock with the key on the driver's side.
4. Open one of the doors. The alarm system should sound and flash.
5. Repeat the test for the other doors.
6. Deactivate the alarm by unlocking with the remote control.

Testing the bonnet:

1. Get into the car and deactivate the movement detector.
2. Arm the alarm (remain in the car and lock the doors with the button on the remote control).
3. Wait 30 seconds.
4. Open the bonnet with the handle under the dashboard. The alarm should now sound and flash.
5. Deactivate the alarm by unlocking with the remote control.

Testing the boot lid:

1. Activate the alarm.
2. Wait 30 seconds.
3. Unlock with the key on the driver's side.
4. Open the boot lid. The alarm should now sound and flash.
5. Deactivate the alarm by unlocking with the remote control.

If the alarm system does not function correctly, have an authorised Volvo workshop examine the car.

Starting and driving

Refuelling	92
Starting the car	93
General	94
Manual gearbox	96
Automatic gearbox (option)	97
Geartronic (option)	99
All-Wheel Drive (option)	101
Braking system	102
Stability system (option*)	104
Towing	108
Jump starting	109
Driving with a trailer	110
Towing bracket	112
Load on the roof	116

Refuelling



Opening the fuel filler flap

The fuel filler flap can be opened when the car is unlocked.

NOTE! The filler flap remains unlocked for ten minutes after the car has been locked.

Fuel cap

The fuel cap is inside the fuel filler flap on the right rear wing.

There may be overpressure in the tank if outdoor temperatures are high. Open the cap slowly. Do not overfill the fuel tank. Stop refuelling when the pump cuts out for the first time! If the tank is overfilled fuel may overflow at high temperatures!

After refuelling, replace the fuel cap and turn until one or more clicks is heard.

Refuelling

NOTE! Do not add cleaning additives unless specifically recommended by a Volvo workshop.

Important!

Petrol-powered cars must always be refuelled with unleaded petrol so as not to damage the catalytic converter.

Filling up with diesel

At low temperatures, paraffin can emanate from diesel fuel (-5°C - -40°C), which may cause problems when starting. Make sure you use a special winter grade fuel during cold weather.



WARNING!

Always switch off your mobile telephone during refuelling - the ring signal can cause sparks which may ignite petrol fumes and lead to fires or personal injury.

Starting the car

Starting the engine (petrol)

1. Apply the parking brake (handbrake).
2. **Automatic gearbox:**
Gear selector in P or N position.
Manual gearbox
Gear lever in neutral and the clutch pedal completely depressed. This is especially important in severe cold.
3. Turn the ignition key to the start position. If the engine does not start within 5-10 seconds, release the key and try again.

Starting the engine (Diesel)

1. Apply the parking brake (handbrake).
2. **Automatic gearbox**
Gear selector in P or N position.
Manual gearbox
Gear lever in neutral and the clutch pedal completely depressed. This is especially important in severe cold.
3. Turn the ignition key to the driving position. An lamp on the combined instrument panel will come on indicating that the engine preheater is activated. Turn the key to the start position when the lamp extinguishes.

NOTE! Depending on the temperature of the engine during start, idle speed during cold starts may be higher than normal for certain engine types – for a short duration –.

For this reason, Volvo wishes to provide the correct emission control system operating temperature as quickly as possible in their efforts to minimise exhaust emissions.

Ignition keys and electronic immobilizer

Do not let several ignition keys, each containing a chip, dangle on the same keyring when inserting the key in the ignition switch. The immobilizer could be activated. If this happens, take away the excess keys and restart the car.

Never rev the engine hard straight after a cold start! If the engine does not start or misfires, contact a Volvo workshop!

WARNING!

Never remove the ignition key from the steering wheel lock while driving or while the car is being towed! Never switch off the ignition (key in position 0) or remove the ignition key while the car is moving. The steering wheel lock can be activated, which would make steering impossible.

Ignition switch and steering wheel lock

0 - Locked position

The steering wheel locks when the ignition key is removed.

I - Intermediate position – "radio position"

Certain electrical components can be connected. The engine electrical system is not connected.

II - Driving position

The key position when driving. The car's entire electrical system is connected.

III - Start position

The starter motor is connected. Release the key once the engine has started. The key automatically springs back to the driving position. If the key is hard to turn, the front wheels may be turned in such a way that there is tension in the steering wheel lock. Turn the wheel back and forth to make it easier to turn the key.

Ensuring that the steering wheel is locked when you leave the car minimises the risk of theft.

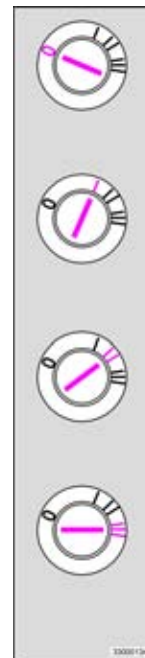

General

Economical driving

Economical driving results from driving gently with anticipation and adapting your driving style and speed to the situation.

Keep in mind the following:

- Drive the engine to operating temperature as soon as possible! That is to say: do not let the engine idle, but drive with a light load as soon as you can.
- A cold engine consumes more fuel than a warm one.
- Avoid driving short distances where the engine never has time to reach operating temperature.
- Drive gently! Avoid unnecessary quick accelerations and heavy braking.
- Do not drive with unnecessary, heavy loads in the car.
- Do not use winter tyres when the roads are clear and dry.
- Remove the load carrier when it is not in use.
- Do not open side windows unnecessarily.

Do not drive with an open boot lid!

If you drive with the boot lid open, some of the exhaust gases and poisonous carbon monoxide could be sucked into the car through the cargo compartment. If you must drive a short distance with the boot lid open, do as follows:

- Close all windows.
- Distribute the air between the windscreen and floor while running the fan at high speed.

Your new car – slippery road surfaces

Driving on a slippery road may feel different depending on whether you choose a car with a manual or an automatic gearbox. Practice skid driving under controlled conditions so that you know how your new car reacts.

Automatic gearbox – cold starts

When starting in low temperatures, gear shifts may feel harder. This is due to viscosity of the gearbox oil at low temperatures.

To minimise engine emissions, the gearbox shifts up later than normal if the engine has been started at low temperature.

When the engine is cold, the transmission shifts gears at higher engine speeds than normal. This is to help the catalytic converter reach normal operating temperature quickly.

Automatic gearbox adaptive system

The gearbox is controlled by an "adaptive system". The control module continually "learns" how the gearbox behaves. It senses how the gearbox shifts gear and achieves optimal gear shifts each time. The control module also senses the way you drive, such as how hard you depress the accelerator, and adjusts the sensitivity of the shift schedule to your driving style.

Automatic gearbox safety systems

Cars with automatic gearbox have special safety systems:

Keylock

The ignition key must be in position I to move the gear selector from position P to other gear positions. The gear selector must be in position P to remove the ignition key after driving.

Shiftlock

The brake pedal must be depressed to move the gear selector from position P to other gear positions when the key is in position I or II.

If you have started the engine and the car remains stationary:

Hold your foot on the brake pedal when moving the gear selector to another position!

Do not allow the engine and cooling system to overheat

Under certain conditions, e.g. when driving in hilly terrain and with a heavy load, especially in warm weather, there is a risk of the engine and cooling system overheating.

To avoid overheating in the cooling system:

- Drive at low speeds if driving with a trailer up a long incline.
- Switch off the air conditioning temporarily.
- Avoid letting the engine idle.
- Do not turn the engine off immediately you stop if the car has been driven hard.
- Remove any auxiliary lamps from in front of the grille if driving in extreme high temperatures.

To avoid the engine overheating:

Do not exceed engine speeds of 4500 rpm if driving with a trailer or caravan in hilly terrain. The oil temperature can become too high.

Manual gearbox



Gear positions 5-speed

Depress the clutch pedal fully with each gear change. Remove your foot from the clutch pedal between gear changes! Follow the appropriate shifting pattern.

Use 5th gear as often as possible for the best possible fuel economy.



Reverse gear inhibitor

Engage reverse gear when the car is stationary or at very low speeds!

To put the car in reverse, the gear lever must first be moved to neutral (between 3rd and 4th gear). Thus, reverse cannot be directly selected from 5th gear due to the reverse gear inhibitor.



Gear positions, 6-speed

Use the higher gears as often as possible to achieve the best possible fuel economy.

Automatic gearbox (option)

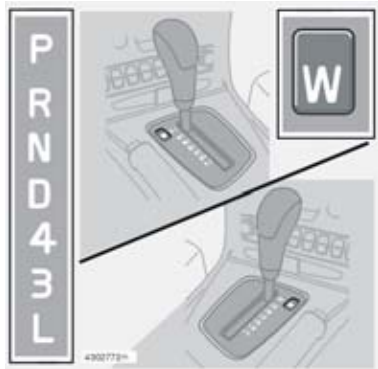

P – Park

Select this position when you wish to start the engine or park the car.

The car should be stationary when you select P!

In **P** the gearbox is mechanically locked. Always apply the parking brake when parking the car.

R – Reverse

The car should be stationary when you select R!

N – Neutral

N is the neutral position. The engine can be started, but no gear is selected. Apply the

parking brake when the car is stationary with the gear lever in **N**.

D – Drive

D is the normal driving position. The car automatically shifts between the different gears of the gearbox based on the level of acceleration and speed. The car should be stationary when selecting **D** from position **R**.

4 – Low gear

Up and downshifts between 1st, 2nd, 3rd and 4th are automatic. There is no upshift to 5th gear.

Position 4 can be used:

- for mountain driving
- when driving with a trailer
- to increase engine braking

3 – Low gear

Up and downshifts between 1 st, 2 nd, and 3 rd are automatic. There is no upshift to 4 th gear.

Position 3 can be used:

- for mountain driving
- when driving with a trailer
- to increase engine braking

L – Low gear

Select **L** if you wish to drive in 1st or 2nd. Position **L** gives the best engine braking for mountain driving, etc.

Downshift inhibitor

There is a built-in inhibitor in the gearbox that prevents over-revving in the engine when you select one of the low gears.

Automatic gearbox (option) (Contd)

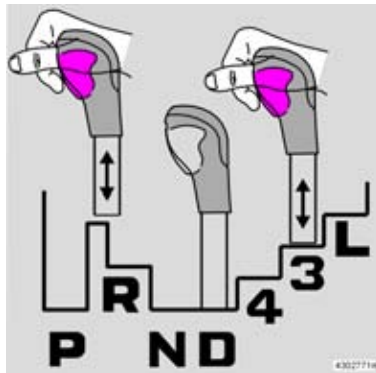

W – Winter

Use the button to engage or disengage the winter program **W**.

The winter program makes it easier to drive at low speeds in slippery road conditions. When the program is engaged, the driving wheels utilise less power than normal and all upshifting occurs at a lower engine rpm.

The **W** symbol is displayed in the combined instrument panel.

NOTE! The **W** program cannot be engaged if you have selected one of the manual positions – it can only be selected in position **D**.

Gear selector inhibitor

You can always move the gear lever freely forward or backward between **N** and **D**. Other positions are locked with a latch that you can control with the inhibitor button on the gear lever.

Press the inhibitor button to move the gear lever forward or backward between **R** and **N**, and between **D**, **4**, **3** and **L**.

"Kick-down"

When you press the accelerator all the way down – beyond the position normally regarded as full acceleration – a lower gear is automatically engaged. This is called "kick-down" downshifting. When you reach the maximum speed for the gear or release the accelerator pedal from the "kick-down" position, there is an automatic upshift.

Use "kick-down" when you want maximum acceleration, such as when overtaking.

Geartronic (option)

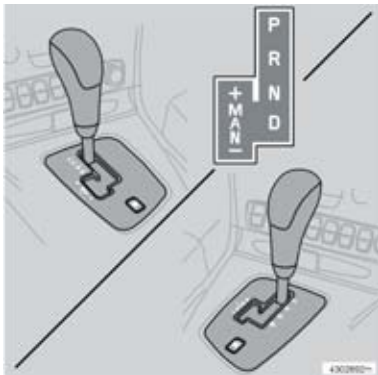

P – Park

Select this position when you wish to start the engine or park the car.

The car should be stationary when you select P!

In **P** the gearbox is mechanically locked. Always apply the parking brake when parking!

R – Reverse

The car should be stationary when you select **R**!

N – Neutral

N is the neutral position. The engine can be started, but no gear is selected. Apply the parking brake when the car is stationary with the gear lever in **N**.

D – Drive

D is the normal driving position. The car automatically shifts between the different gears of the gearbox based on the level of acceleration and speed. The car should be stationary when selecting **D** from position **R**.

Gear selector manual position

To move from automatic position **D** to manual shifting mode, move the lever to the left. To move from **MAN** to **D**, move the lever to the right to **D**.

3rd, 4th and 5th gears have the Lock-up function (locked gears), which gives better engine braking and lower fuel consumption.

While driving:

The manual gear positions can be selected at any time while driving. The selected gear is locked until another gear is selected. The car only downshifts if you slow to a very low speed.

If you move the gear selector to minus (–), the car shifts down one gear while braking the engine. If you move the gear selector to plus (+), the car shifts up one gear.

3rd is the highest gear you can use when starting.

The Kick-down function is not available while you are in manual shifting mode. You must return to automatic position **D**.

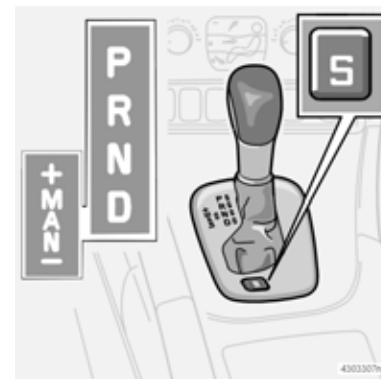

Geartronic for the R version (option)

The S60 R is equipped with an automatic gearbox which has an S-button instead of a W-button located near the gear selector.

Activate the gearbox sport program with the S button; an LED in the button lights when the program is active.

The S-program allows for sportier performance and higher gear rpm as well as a more rapid acceleration response. Use of a lower gear is prioritised during active driving - which implies delays during upshifts.

Geartronic (option) (Contd)



W – winter*

Use the button to engage or disengage the winter program **W**.

The winter program makes it easier to drive at low speeds in slippery road conditions. When the program is engaged, the driving wheels utilise less power than normal and all upshifting occurs at a lower engine rpm.

The symbol **W** is displayed in the combined instrument panel.

NOTE! The **W** program cannot be engaged if you have selected one of the manual positions – it can only be selected in position **D**.

*: Not in the R version which instead has an S-button and FOUR-C program.

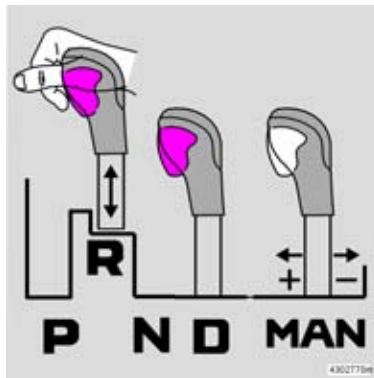

Gear selector inhibitor

You can always move the gear selector freely forward and back between **D**, **N** and the **manual positions**. Other positions are locked with a latch which you control with the inhibitor button on the gear selector. Press the inhibitor button to move the gear selector forward or back between **P**, **R**, **N** and **D**.

"Kick-down"

When you press the accelerator all the way down – beyond the position normally regarded as full acceleration – a lower gear is automatically engaged. This is called "kick-down" downshifting. When you reach the maximum speed for the gear or release the accelerator pedal from the "kick-down" position, there is an automatic upshift. Use "kick-down" when you want maximum acceleration, such as when overtaking.

NOTE! The **Kick-down function** is not available while you are in manual shifting mode. You must return to automatic position.

All-Wheel Drive (option)

AWD – All-Wheel Drive

The all-wheel drive system in your Volvo is constantly engaged and meets very high technical requirements. Used correctly, all-wheel drive provides the driver better control on various road surfaces than conventional rear-wheel drive.

All-wheel drive means that all four road wheels are driven. Power is automatically distributed between front and rear wheels. An electronically controlled clutch system distributes the power to the pair of wheels that grips best. This provides the best traction and prevents wheel spin.

Under normal driving conditions, the majority of power is transmitted to the front wheels.

The greater traction improves driving safety in rain, snow and icy conditions.

Tyre dimensions and pressure

Volvo recommends driving with tyres which have the same make, size, specifications, load designation, and speed rating. The recommended tyre pressure is specified in the table on the inside of the fuel filler flap.

Snow chains

Snow chains may only be fitted to the front wheels on all-wheel drive cars.

Important!

In order to prevent damage to wheel housing components: use chains designed for AWD models only.

Speed-dependent power steering*

S60-R is equipped with speed-dependent power steering.

The S60 R is equipped with speed-dependent power steering, a system that allows the car to be steered more easily at low speeds, which in turn facilitates parking, etc.

When speed is increased, steering force is adjusted in order to provide the driver with an improved feeling for the road.

*: R version only.

Braking system



If a brake circuit fails

Braking is still possible if a fault occurs in one of the circuits.

Depress the gas pedal once using a higher than normal pressure – do not pump the brakes. The brake pedal can be depressed further and may feel somewhat softer than normal. More pressure is required in order to achieve a normal braking effect.

The brake servo only works when the engine is running. If the car is rolling or being towed with the engine switched off, you must apply approximately 5 times more pressure on the brake pedal than when the engine is running.

The brake pedal feels rigid and hard.

Moisture on the brake discs and brake lining alter braking characteristics!

Brake components become wet when the car is driven in heavy rain or through pools of water or when the car is washed. This alters brake pad friction characteristics so that there is a delay before braking effect is noticed. Depress the brake pedal lightly from time to time when driving long distances in rain or slush and before parking your car in such conditions. This helps the brake lining warm up and dry out. You should also do this when driving after washing the car and when starting in damp or cold weather conditions.

If the brakes are heavily loaded

When driving in the Alps or other roads with similar characteristics, the car's brakes are heavily loaded even if you are not pressing the pedal especially hard. Because speed is often low, the brakes are not cooled as effectively as when driving on flat roads.

In order to prevent brake overload, shift down and use the same gear uphill and downhill instead of using the brake (manual gearbox). This uses engine braking more efficiently and requires braking during short periods only.

Keep in mind that the brakes are even more heavily loaded when driving with a trailer.



Antilock braking system (ABS)

The ABS system (Anti-lock Braking System) is designed so

that the wheels do not lock when braking. This retains the best possible steering response when braking. This improves your ability to swerve to avoid obstacles. The ABS system does not increase your total braking capacity. However, as the driver you have increased ability to steer and thus better control over the car, which in turn increases safety.

After the engine has started and reached a speed of about 20 km/h, a short self-test can be both heard and felt. When the ABS system functions, you can hear and feel pulses in the brake pedal. This is completely normal.

NOTE! You must depress the brake pedal fully to take maximum advantage of the ABS system. Do not release the pedal when you hear and feel the ABS pulses. Practice braking with the ABS system at a suitable spot such as a track to practice skidding.

The ABS symbol lights and shines with a constant glow:



- For approximately two seconds during the system test when the car is started.
- If the ABS system has shut down due to a fault.

Electronic Brakeforce Distribution (EBD)

The Electronic Brakeforce Distribution system (EBD) is an integrated part of the ABS system. The EBD system controls the brake force to the rear wheels so that the best possible braking force is always available. Pulses will be heard and felt through the brake pedal when the system regulates brake force.



WARNING!

If the **BRAKE** -  and **ABS** -  warning symbols light simultaneously, there is a risk that the rear end will have a tendency to slide during heavy braking. If the brake fluid level is normal, carefully drive the car to the nearest authorised Volvo workshop to have the brake system checked.

Stability system (option*)



Stability and Traction Control STC/DSTC*

The STC system (Stability and Traction Control) includes the SC and TC functions.

The DSTC system (Dynamic Stability and Traction Control) functions include TC, SC, AYC and EBA.

Traction Control (TC)

The Traction Control function transfers power from the spinning drive wheel to the drive wheel with traction by braking the spinning drive wheel. In order to improve forward traction during similar situations, exert more pressure on the accelerator pedal than normal. An audible pulsating sound, which accompanies proper Traction Control, is completely normal for system function. The TC function is most active at lower speeds and cannot be switched off.

Stability Control (SC)

The Stability Control function is designed to prevent the drive wheels from slipping on the road surface during acceleration by reducing engine torque output to the drive wheels. This improves traction and driving safety in slippery conditions. Certain driving conditions such as driving with snow chains or driving in deep snow or sand may require SC deactivation in order to increase traction. The function can be deactivated with the STC/DSTC button.

Active Yaw Control (AYC)

The AYC (Active Yaw Control) function provides automatic braking for one or more wheels, which allows for more stability in the event of a skid. If braking occurs in such a situation, the brake pedal will feel more rigid than normal and will be accompanied by an audible pulsating sound. The AYC function is continuously active and cannot be switched off for reasons of safety.

AYC in the R version

The function can be switched off with the DSTC button. However, the function deactivation/reactivation procedure requires that the command be repeated three times (push the button five times: on-off-on-off-on).

Emergency Brake Assistance (EBA)

The Emergency Brake Assistance function is integrated in the DSTC system and is designed to provide immediate maximum brake force whenever rapid braking is necessary. The system detects the need for heavier braking by registering how quickly the brake pedal is applied.

The EBA function is active at all speeds. For – safety reasons, – it cannot be switched off.

NOTE! When the EBA function is activated, the brake pedal sinks while maximum braking force is applied. Continue braking without releasing the brake pedal. The EBA function disengages when the pressure on the brake pedal is released.

Road Friction Detection (RFD) (option)

Road Friction Detection is an advanced system which discerns the amount of friction between the tyres and the road. The system is designed as an early warning system which alerts the driver when road conditions are slippery.

The RFD system is active at low speed and upwards and cannot be switched off for reasons of safety.

The warning symbol lights when:

- The RFD system detects low road surface friction.

The warning symbol lights with a fixed, yellow glow and the additional text “RFD SERVICE REQUIRED” when:

- The RFD system has been switched off due to a fault.

*: The STC and DSTC systems are options in certain markets.

STC/DSTC-button

The button in the centre console is used to deactivate or reactivate the STC/DSTC system.

A glowing **LED in the button** indicates that the STC/DSTC system is **activated** (if no faults have occurred).

During deactivation, Stability Control (SC) and Active Yaw Control (AYC) are deactivated. Other functions are not affected.

NOTE! For safety reasons, press the button for at least one-half second in order to deactivate the STC/DSTC function.

The **LED** in the button **extinguishes** and the display shows: "**STC/DSTC SPIN CONTROL OFF**".

The STC/DSTC system is automatically activated when the engine is started.

The warning symbol  **flashes when:**

- The SC function is working to prevent the drive wheels from slipping.
- The TC function is working to improve traction.
- The AYC function is working to prevent skidding.

The warning symbol  **lights and goes out again after 2 seconds when:**

- the car is started. (The lamp lights for a system check.)

The **LED** in the button **extinguishes** and "**STC/DSTC SPIN CONTROL OFF**" is **displayed when:**

- STC/DSTC system SC function has been deactivated with the STC/DSTC button.

The warning symbol  **lights and shines with a constant glow** and "**TRACTION CONTROL TEMPORARILY OFF**" is **displayed when:**

- The brake system TC function has been temporarily reduced due to high brake temperature. The TC function will be reactivated automatically when the brake temperature returns to a normal level.

The warning symbol  **lights and shines with a constant glow** and "**ANTI-SKID SERVICE REQUIRED**" is **displayed when:**

- the DSTC system has shut down due to a fault.

 **WARNING!**

Under normal driving conditions, the STC/DSTC systems improve the car's driving safety, which should not present itself as an opportunity to increase speed. Always follow normal safety precautions regarding safe cornering and driving on slippery surfaces.

Keep in mind that the car's driving characteristics are altered if you deactivate the STC/DSTC system.

Stability system (option*) (Contd)

Active chassis – FOUR-C*

The S60 R is equipped with the advanced, electronically-controlled active chassis system FOUR-C (Continuously Controlled Chassis Concept). System functions are based on a number of sensors which continuously adjust vehicle movements and reactions, for example vertical and lateral acceleration, vehicle speed and wheel movement.

The FOUR-C control unit analyses data from the sensors and performs the necessary shock absorber setting adjustments up to 500 times per second. This results in extremely fast and accurate individual shock absorber control, which contributes to variations in chassis characteristics.

The buttons on the dashboard (see illustration) can be used at random in order to select from the three different settings: Comfort, Sport and Advanced.

The driver can adjust the chassis characteristics while driving – when switching driving style or when the character of the road surface changes. Adjustments occur within a few milliseconds.

The effect which occurs when the accelerator pedal is depressed relates to the chassis setting selection: the Advanced setting provides a quicker acceleration response.

*: R version only

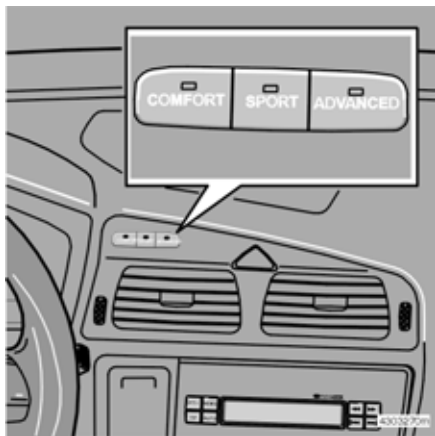

Comfort

Comfort adjusts the chassis setting so that the body is insulated from uneven sections of the road surface, which allows for better glide. Shock absorption is softer and body movements are minimal. This setting is recommended for long-distance driving or driving on slippery road surfaces.

When the ignition is switched off in Comfort setting, the chassis will resume the same mode when the car is re-started.

Sport

The Sport setting provides quicker steering response than the Comfort setting. The suspension is harder and the body follows the road in order to reduce roll during rapid cornering. The car responds like a typical sports car.

When the ignition is switched off in Sport setting, the chassis will resume the same mode when the car is re-started.

Advanced

With the Advanced setting, shock absorber movements are minimal and optimised for maximum traction. Acceleration response is more direct, the automatic gearbox shift schedule is sportier and roll during cornering is minimised. This setting is recommended for flat, even road surfaces only.

When the ignition is switched off in Advanced setting, the chassis will resume the same mode when the car is re-started.

Towing

Do not tow start (bump start) the engine

If you bump start a car with manual gearbox, the catalytic converter(s) may be damaged. Cars with automatic gearbox cannot be bump started. Use a booster battery if the battery is flat.

If the car must be towed

- Unlock the steering wheel lock so that the car can be steered.
- **Keep in mind the highest legally permissible speed.**
- Remember that the brake and power steering servos do not function with the engine is switched off! You must exert approximately five times more pressure on the brake pedal and steering is considerably harder than usual.
- Drive gently.
- Keep the towline taut in order to avoid unnecessary jerking.

For automatic gearboxes

- The gear selector should be in position N.
- The highest permitted speed for AW gearbox: 80 km/h.
- Longest permitted distance: 80 km.
- The engine cannot be towed to start (bump started). See " Jump starting " on the next page.

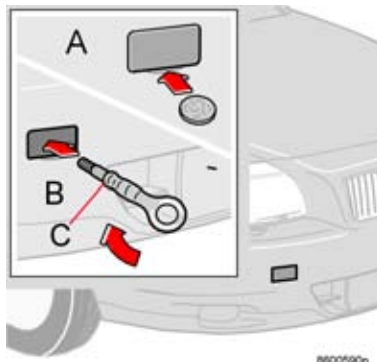

Towing eye, front

Towing eye*

The towing eye is located in the tool kit in the cargo compartment. You must screw the towing eye into place before towing. The sockets and covers for the towing eye are located on the right-hand side of each bumper.

Remove the cover as follows:

A. Loosen the bottom edge of the cover with a coin.

B. Screw the towing eye securely into place up to the flange (C). You can use a wheelbrace.

After use, unscrew the towing eye and refit the cover.

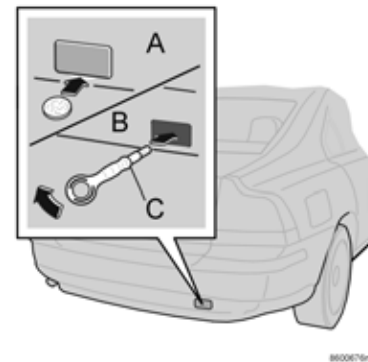

Towing eye, rear

Recovery

The towing eye may only be used for towing on roads, not for recovery after driving into a ditch or the like. Professional help should be called for recovery.

* (certain models) To screw the towing eye into place, you must first remove a plastic screw in the console for the rear towing eye. Use the wheelbrace from the tool kit to remove the plastic screw. Refit the plastic screw after use.

Jump starting

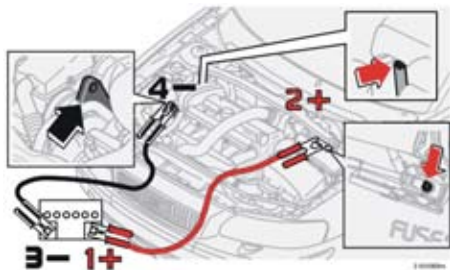

Jump start with a booster battery as follows:

If for some reason the battery in your car is discharged, you can "borrow" current from a spare battery or another car's battery to start the engine. Always check that the clamps are fastened properly to prevent sparking during the start attempt.

To avoid the risk of explosion, we recommend you do exactly as follows.

- Turn the ignition key to position 0.
- Ensure that the booster battery has **12 volt current**.

- If the booster battery is in another car, stop the engine of that car and make sure the cars are not touching.
- Connect the red cable between the booster battery positive terminal (1+) and the red connection in the engine compartment (2+). Attach the clamp to the contact point located beneath a small black cover with a plus sign which is integrated in the fuse box cover.
- Connect one clamp of the black cable to the negative terminal of the booster battery (3-).
- Connect the other clamp of the black cable to the lifting eye on your car's engine (4-).
- Start the engine of the "booster car". Let the engine run a few minutes at a speed slightly higher than idle, 1500 rpm.
- Start the engine of the car with the discharged battery.
- Remove the clamps in reverse order.

NOTE! Do not remove the clamps during the start attempt (risk of spark build-up).

WARNING!

Keep in mind that the batteries, especially the booster battery, contain highly explosive oxyhydrogen. Sparks, which may occur when jump start cables are incorrectly placed, may cause the battery to explode and cause damage to the car or personal injury. The battery contains sulphuric acid which may cause serious corrosive damage. If the acid comes into contact with eyes, skin or clothing: Flush with large quantities of water. Contact a doctor immediately if acid makes contact with your eyes!

Driving with a trailer

- The towing bracket on the car must be of an approved type. Your Volvo dealer can advise you as to which towing bracket to use.
- Distribute the load in the trailer so that the weight on the towing bracket is approximately 50 kg for trailer weights under 1200 kg and approximately 75 kg for trailer weights over 1200 kg.
- Increase tyre pressure so that it corresponds to the pressure for full load. See the tyre pressure table!
- Clean the towing bracket regularly and grease the towball* and all moving parts to prevent unnecessary wear.
- Do not drive with a heavy trailer when your car is brand new! Wait until it has gone at least 1000 km.
- The brakes are loaded much more than usual on long and steep downhill slopes. Downshift to a lower gear and adjust your speed.
- If the car is driven with a heavy load in a hot climate, the engine and gearbox may overheat. The temperature gauge in the combined instrument panel goes into the red zone when the car overheats. Stop and let the engine idle a few minutes.
- If the car overheats, the air conditioning system can be temporarily switched off.
- The gearbox reacts with a built-in protection function if the car overheats. See the message in the display!
- The engine is loaded more heavily than usual when driving with a trailer.
- For reasons of safety, you should not drive faster than 80 km/h, even if the laws of certain countries permit higher speeds.
- The highest trailer weight permitted for a trailer without brakes is 750 kg.
- If you park with a trailer, always set the gear selector to P (automatic gearbox) or put the car in a gear (manual gearbox). If you park on a steep hill, put chocks under the wheels.
- Avoid driving on inclines exceeding 12% if the trailer weight exceeds 1200 kg. Do not drive with a trailer at all on inclines exceeding 15%.

*: Does not apply to ball hitch with vibration damper.

Maximum permissible trailer weight for a trailer with brakes	Maximum permissible weight on the towing bracket
0-1200 kg	50 kg
1201-1600 kg	75 kg

NOTE! The following are the highest trailer weights permitted by Volvo Car Corporation. Remember that national traffic regulations may further limit trailer weight and speed. Towbars may be certified for higher tow weights than the car may tow.

WARNING!

If you do not follow the given recommendations, the trailer and car may be difficult to control during evasive manoeuvres and braking, which can be dangerous to you and others on the road.

Driving with trailer – automatic gearbox

- When parking on hills, you should apply the parking brake before moving the gear selector to P. When you start on a hill, you should first put the gear selector in drive and then release the parking brake.
- Select a low gear in the gearbox when driving on steep inclines or when driving slowly. This prevents the gearbox from upshifting if you have an automatic gearbox. The gearbox oil will be cooler.
- If you have a Geartronic gearbox, do not use a higher manual gear than the engine can "handle". It is not always economical to drive in high gears.

NOTE! An automatic gearbox oil cooler for trailer towing is required for a number of models. Consult your Volvo dealer for information regarding your car's specifications if the towbar has been installed after purchase.



Levelling

If your car is equipped with automatic levelling, the rear suspension always retains the correct ride height regardless of the load. When the car is stationary, the rear suspension sinks, which is completely normal.

Towing bracket

Fixed towbar (A)

Always remember to fasten the trailer's safety cable to the attachment. See the illustration!

Detachable towbar (B)

Always follow mounting instructions carefully.

Always remember to fasten the trailer's safety cable to the attachment. See the illustration!

Always remember to clean and grease the connector pin regularly.

Use recommended grease 8624203.

NOTE! Your car may have a towing bracket with a 13 pin contact that you must connect to a trailer with a 7 pin contact. In such a case, use a Volvo Genuine adapter cable. Make sure that the cable does not drag on the ground.

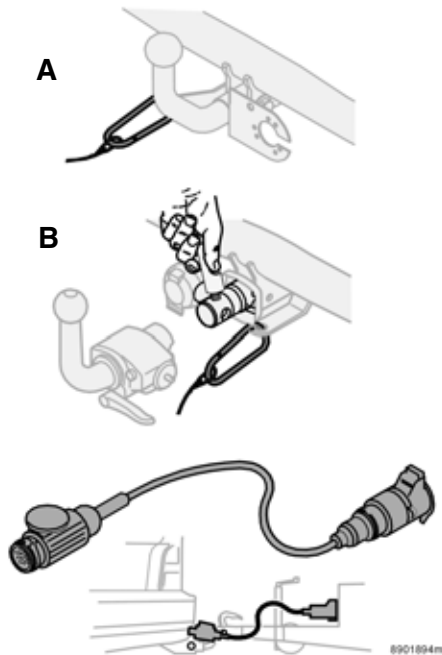

WARNING!

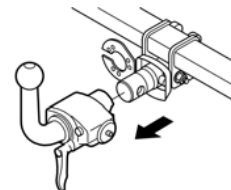

If your car is equipped with a Volvo detachable towbar:

- Make sure that the towbar is locked before you begin driving.
- The red signal pin (see the arrow in the illustration above) should not be visible.
- Use the key to lock it. See the description on page 114.

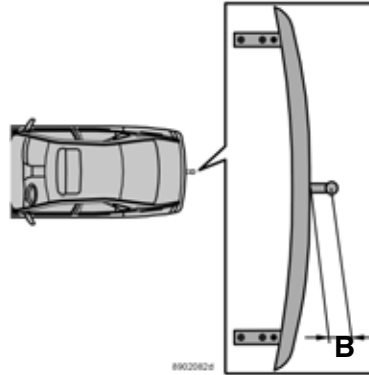
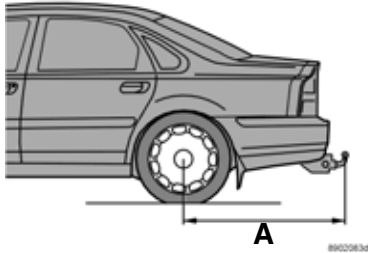

Attachment points under the car

Specifications

Distance A

Fixed towbar: 1057 mm

Detachable towbar: 1078 mm

Distance B

Fixed towbar: 83 mm

Detachable towbar: 104 mm

Maximum permissible weight on the towing bracket: 75 kg

Towing bracket (Contd)

Detachable towbar - mounting towball section

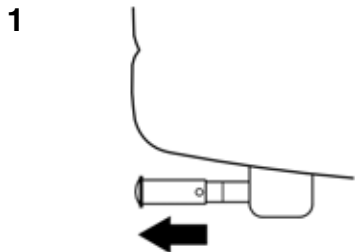

Remove the connector pin cover.

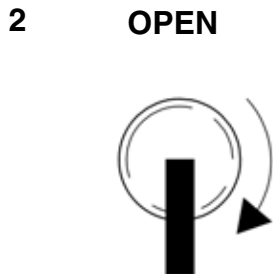

Put in the key and turn it clockwise to the unlocked position.

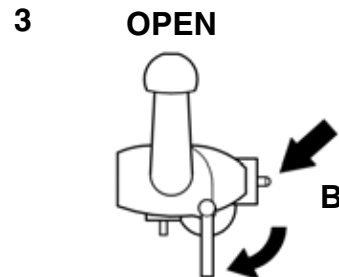

Take the towball section and turn the handle clockwise until it stops.

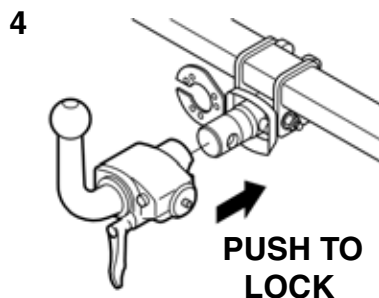

Push the towball section in until it locks. Be careful of the handle as it can change position quickly!

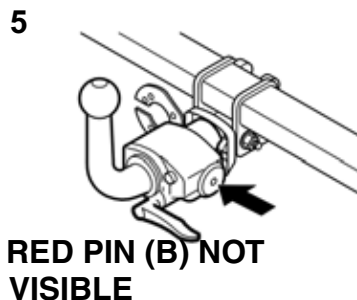

Check that the signal pin (B) is pushed in.

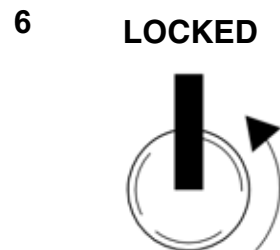

Turn the key anticlockwise to the locked position and remove it from the lock.

Detachable towbar - removing towball section**1 OPEN**

Put in the key and turn it clockwise to the unlocked position.

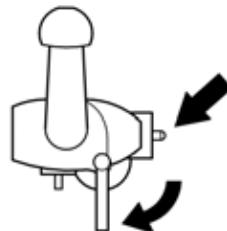
2 OPEN

Turn the handle clockwise until it stops.

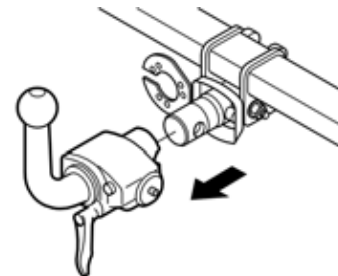
3

Pull the towball section from the connector pin.

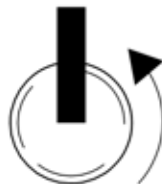
4 LOCKED

Turn the key anticlockwise to the locked position and remove it from the lock.

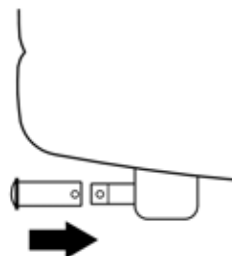
5

Refit the connector pin cover as in the illustration.

Load on the roof

Using load carriers (accessory)

To avoid damaging your car and to achieve the best level of safety when driving, we recommend that you only use load carriers that Volvo has specially designed for your car.

- Check periodically that the load carriers and load are properly secured. Lash the load securely with suitable straps.
- You can carry a **maximum of 100 kg** on the roof (including load carriers).
- Distribute the load evenly over the load carriers. Do not load lopsidedly. Place the heaviest items at the bottom.
- Remember that the car's centre of gravity and driving characteristics change if you have a load on the roof.
- Keep in mind that the car's wind resistance and fuel consumption increase in proportion to the size of the load.
- Drive gently. Avoid quick accelerations, heavy braking and taking curves hard.
- Remove the load carrier when it is not in use. This reduces wind resistance and fuel consumption.

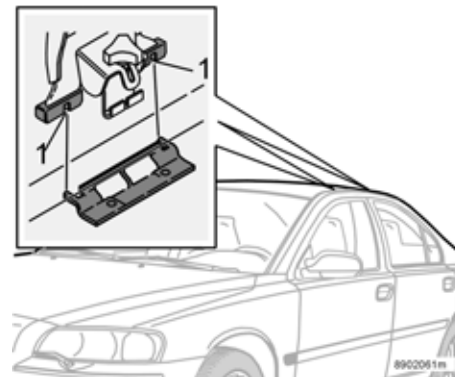
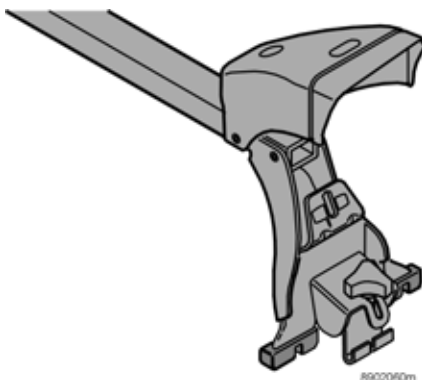

Fitting load carriers

1. Make sure the load carrier is placed in the right direction (see the marking on the decal under the cover).
2. Fit the guide pins into the guide holes (1).
3. Carefully lower the bracket on the other side to the roof.
4. Screw the knob up a bit.
5. Press the knob against the roof bracket and catch the hook in the roof bracket under the roof rail.
6. Screw the load carrier in place.
7. Fit the guide pins of the other brackets into the guide holes.
8. Screw the load carrier in place.
9. Check that the hook is properly secured in the roof bracket.
10. Tighten the knobs alternately until the carrier feels secure.
11. Replace the cover.
12. Check that the roof rack is properly secured.
13. Check the knobs regularly to see that they are properly tightened.

Wheels and tyres

General	118
Changing wheels	120

General

General information about wheels and tyres

All tyres have a dimension designation.

Example of designation: **215/55R16 93W**.

These tyre size designations, which are used by all tyre manufacturers, can be interpreted as follows:

- 215 section width (mm).
- 55 relationship between section height and width (%)
- R radial tyre
- 16 Wheel rim diameter in inches (")
- 93 code digits for maximum permissible tyre load, in this case 650 kg
- W specifies that the tyre is manufactured for speeds up to 270 km/h

Your vehicle has "whole vehicle type approval", which means that you are not permitted to modify it from the dimension(s) and/or performance classes specified in the vehicle registration certificate. The only exception from these regulations are winter tyres and studded tyres, which may deviate in size and speed rating if such are specified in the registration certificate. If you select such a tyre type, it must not be driven faster than the tyre can handle.

The most common speed ratings are specified in the following table.

Note that the maximum permissible speed is indicated.

Q	160 km/h, used most often with studded tyres
T	190 km/h
H	210 km/h
V	240 km/h
W	270 km/h

When replacing tyres: be careful to use the same type, i.e. radial, dimension, designation, and brand on all four wheels. Otherwise there is a risk that the driving characteristics of the car will change.

Check with your dealer as to which sizes are available for your car.

Bear in mind that the road surface conditions determine how fast you may drive, not the tyre speed rating.

NOTE! This is extremely important for All Wheel Drive models (AWD) since even small size differences between wheels can cause transmission damage.

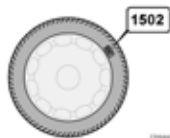

New tyres

Keep in mind that tyres are perishable goods – they will begin to harden after a few years and their friction properties will be reduced.

Try to use fresh tyres when changing, which is especially important for winter tyres. The week and year of manufacture is indicated with 4 digits, for example 1502. The tyres shown in the illustration were manufactured week 15, 2002.



WARNING!

The only Volvo approved "special wheel rims" are those that are tested by Volvo and are **Volvo Genuine accessories**.

Winter tyres

Volvo recommends winter tyres with dimension 195/65 R15, except for cars with petrol-driven turbo engines (B5204T5, B5234T3 and B5244T3). Winter tyres with dimension 205/55R16 are recommended for these cars. Winter tyres of size 235/ 45R17 or 235/40R18 are to be used on S60 R.

Always use winter tyres on all four wheels!

NOTE! Consult your Volvo dealer for advice on which rim and tyre type you should use for your car.

Studded tyres

Studded winter tyres should be "broken in" 500-1000 km, softly and gently so that the studs sit correctly in the tyre. This extends the service life of both the tyres and the studs while making the drive a bit quieter.

Remember that regulations for use of studded tyres vary from country to country.

Snow chains

Snow chains may only be used on the front wheels.

Avoid driving on bare surfaces unnecessarily as this generates much wear on both the snow chains and the tyres.

Important!

Only Volvo-approved snow chains are permitted. Use of other snow chains could damage your car.

Never drive faster than 50 km/h when snow chains are fitted!

Never use "quick links" because the space between the disc brakes and the wheels is too small.

Tyre pressure is important!

Check the tyre pressure regularly. The correct pressure is listed in the adjacent table and on the decal on the inside of the fuel filler flap.

If you drive with incorrect tyre pressure, the car's driving characteristics are impaired and tyre wear increases.

Note that the values in the table refer to cold tyres (outside temperature). Tyres get warm and pressure increases after just a few kilometres driving. This is normal, so do not let out air if you check the pressure when the tyres are warm. However, you should increase pressure if it is too low.

Remember that tyre pressure can vary depending on the outside temperature. Therefore check tyre pressure outdoors when the tyres are cold.

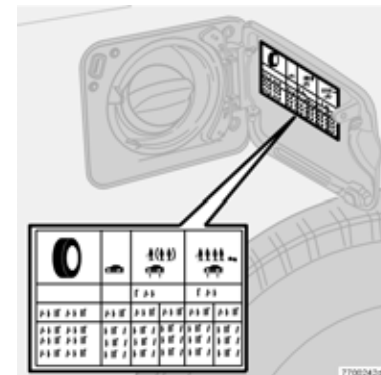

Tyre pressure

The decal located on the inside of the fuel filler flap indicates the correct tyre pressure.

Changing wheels

Tyres with tread wear indicators

Tread wear indicators are narrow, raised areas across the tread that have approximately

1.6 mm less tread depth

than the remainder of

the tyre (the letters TWI are on the side of the tyre). When this bar is visible, only 1.6 mm of tread remains and the tyre should be replaced immediately. Bear in mind that road grip and the tyre's ability to push water out of the way is already markedly affected when there is 3-4 mm of remaining tread.

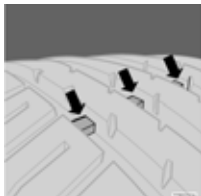

Replacing wheels – summer/winter

When replacing winter tyres with summer tyres, mark the tyre location, e.g. L = left, R = right.

NOTE!

Tyres should rotate in the same direction during their entire service life.

Tyres meant to rotate in one direction only have an arrow indicating rotation direction.

If the tyres are incorrectly installed, braking ability and traction are impaired in rain, snow and slush.

IMPORTANT!

Tyres with the deepest tread must always be mounted in the rear, irrespective of front wheel or all wheel drive.

Consult your nearest Volvo dealer if you are unsure.

Tyres should be stored on their sides or suspended, never standing upright.

Driving characteristics and tyres

Tyres affect driving characteristics greatly.

Tyre type, dimension and pressure are important to how the car performs. When you change wheels, be sure to use the same type, dimension and brand on all four wheels. Follow the recommendations regarding tyre pressure.

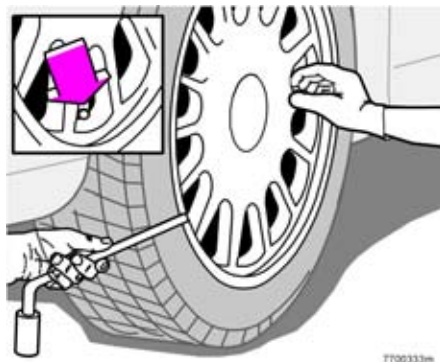

Spare wheel "Temporary Spare"

The "Temporary Spare" should only be used for the short time it takes to repair or replace the normal tyre.

By law, it is only legal to use the spare wheel/tyre temporarily in connection with damage to a tyre. A wheel/tyre of this type should be replaced with a normal wheel/tyre as soon as possible.

Remember also that this tyre combined with the normal tyres will affect driving characteristics. The maximum speed with the "Temporary Spare" is therefore 80 km/h.

NOTE! Only use the car's own genuine spare wheel! Tyres with other dimensions may cause damage to your car. Only **one** spare wheel may be used at a time.

Changing wheels

Remember to set out the warning triangle if you must change a wheel in a trafficked area. The spare wheel is under the plastic trough in the cargo compartment.

1. Apply the parking brake and engage 1st gear if the car has a manual gearbox - P if it has automatic gearbox. Place chocks on either side the wheels remaining on the ground; use heavy wooden blocks or large stones.

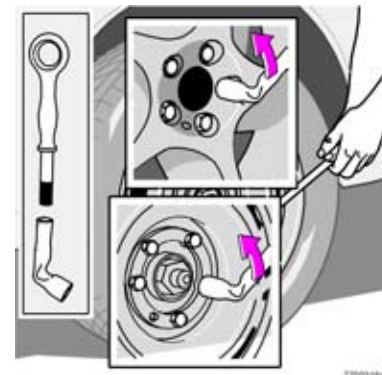

2. Cars with steel wheel rims have removable wheel covers. Prise off the wheel cover with a thick screwdriver or the like. If tools are not available, the wheel cover can be prised off by hand. Use protective gloves. When refitting the wheel cover, make sure the cover is properly aligned over the air valve.
3. Loosen the wheel bolts 1/2-1 with the socket wrench. Loosen the nuts by turning them anticlockwise.

Changing wheels (Contd)

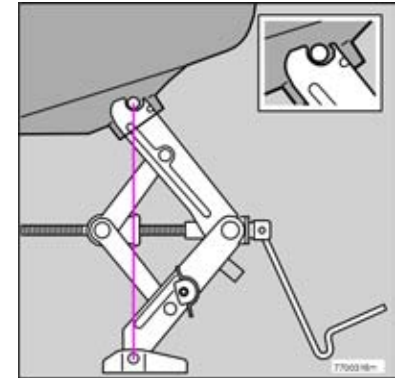
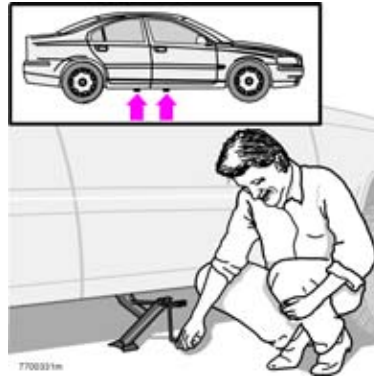
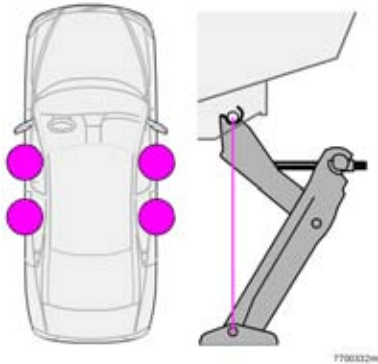

Jack for all-wheel drive cars

- There are two jacking points on either side of the car.
Hold the jack against the pin in the jacking point as shown and wind down the jack foot so that it is pressed flat against the ground. Check that the jack sits securely in the anchorage as shown and that the foot is positioned vertically underneath the anchorage.
- Lift the car so that the wheel is free. Remove the wheel nuts and lift off the wheel.
- Lower the car so that the wheels cannot rotate. Screw the wheel nuts crosswise and in torque steps. Tightening torque: 140 Nm (14.0 kpm). It is important that they are tightened to the correct torque. Use a torque wrench to check the torque.
- Fit the hub cap. Screw the jack together completely before returning it to the cargo compartment. Make sure the jack and tool kit are properly secured in order to prevent rattling.

Fitting

Clean the contact surfaces on the wheel and hub.

- Fit the wheel. Screw the wheel nuts.

WARNING!

Never crawl under the car when it is raised on a jack!

- The car and jack should be on a solid horizontal surface. The car's original jack should be used when changing wheels. All other work on the car should be done using workshop jacks and axle stands under that part of the car that is raised. Make sure the car is completely stationary when changing a wheel.
- The jack screw should be kept well lubricated.

Car care

Cleaning	124
Repairing paintwork damage	126
Rustproofing	127

Cleaning

Wash the car often!

Wash the car as soon as it becomes dirty, especially in the winter when road salt and moisture can lead to corrosion.

Wash the car as follows:

- Thoroughly rinse dirt off the underbody of the car.
- Rinse the entire car until the dirt has softened. When using high pressure washer: Make sure nozzle of the high pressure washer does not come closer than 30 cm from the bodywork. Do not spray directly at the locks.
- Wash with a sponge using a lot of water with or without detergent.
- Use warm water (max. 35 °C), not water that is too hot.
- If the dirt is ingrained, you can wash the car with cold degreasing agent, but be sure that there is a drain separator where you are washing the car. When using cold degreasing agent, make sure that the car is not in direct sunlight or that the paint is warm from sunlight or a warm engine. Sunlight and heat can cause permanent damage. Consult your Volvo workshop.
- Dry the car with a clean, soft chamois.
- Clean the wiper blades with a lukewarm soap solution.

Suitable detergent:

Car shampoo.

Keep the following in mind:

Always remove **bird droppings** from the paintwork as soon as possible. Bird droppings contain chemicals that can affect and discolour paintwork very quickly. Discoloration cannot be removed with polish.



WARNING!

Do not wash the engine when it is warm. Risk of fire! Allow a specialist to wash the engine.

Automatic car wash

An automatic car wash is a simple and fast solution for washing your car. Bear in mind, however, that an automatic car wash cannot replace a proper hand washing –car wash brushes cannot reach all surfaces.

During the first months, we recommend washing by hand.



WARNING!

After washing: always test the brakes so that moisture and corrosion do not affect the brake lining and impair the brakes! Lightly depress the brake pedal now and then when driving long distances in rain or slush so that the brake lining warms and dries. You should also do this when you begin driving after damp or cold weather.

Cleaning (Contd)

Cleaning the upholstery

Treating marks on fabric

A special cleaning agent available at your Volvo dealer is recommended when cleaning fabric upholstery. Other chemicals can impair the fire retardant qualities of the upholstery.

Treating marks on vinyl

- **Never** scrape or rub a stain.
- **Never** use powerful stain removers.
- Wash with weak soap solution and lukewarm water.

Treating marks on leather

A special cleaning agent available at your Volvo dealer is recommended when cleaning leather upholstery.

Use the Volvo leather care kit once or twice a year to preserve suppleness and comfort.

Never use strong detergent, petrol, alcohol, white spirit, etc. as such strong substances can damage fabric, vinyl and leather upholstery.

Cleaning seat belts

Use water and synthetic detergent.

Polishing and waxing

Polish and wax the car when you feel the paintwork is matte and when you wish to give the paintwork extra protection, such as before winter.

The car does not usually need polishing until after one year. It can be waxed earlier.

Wash and dry the car thoroughly before you begin polishing and/or waxing. Clean of asphalt and tar stains with white spirit. More stubborn marks can be removed with fine rubbing paste designed for paintwork. Polish first with a polish and then wax with fluid or solid wax. Carefully follow the instructions on the package. Many preparations contain both polish and wax.

Do not polish or wax surfaces warmer than 45 °C.

Repairing paintwork damage

Paint

Paint is an important part of the car's rustproofing and should therefore be checked regularly. Repair paintwork damage immediately so that it does not start to rust. The most common types of paintwork damage that you can repair yourself are:

- minor stone chips and scratches
- damage to wing edges and doors

When repairing paintwork, the car should be clean and dry with a temperature above + 15 °C.

Colour code

Make sure you have the right colour. The colour code number is on the data plate in the engine compartment.



Minor stone chips and scratches

Material:

- Primer in a can
- Paint in a can or a touch-up pen
- Brush
- Masking tape
- If the stone chip has not gone down to the bare metal and an unpainted colour coat remains, you can add paint immediately after removing dirt.

Do as follows if the stone chip went down to the bare metal:

- Fasten a piece of masking tape over the damaged surface. Then remove the tape, removing any paint residue (illustration 1).
- Stir the primer thoroughly and apply using a fine brush or matchstick (illustration 2).
- When the primer is dry, apply the surface coat with a brush.
- Make sure the paint is well stirred and apply several thin coats; allowing it to dry between coats.
- The procedure is the same for scratches, but masking tape can be used to protect undamaged paintwork (illustration 3).
- Wait a day or so and then finish the repair by polishing. Use a soft rag and apply lapping paste sparingly.

Remove any paint residue with tape

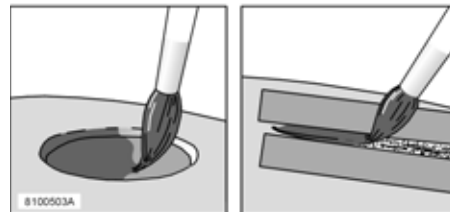
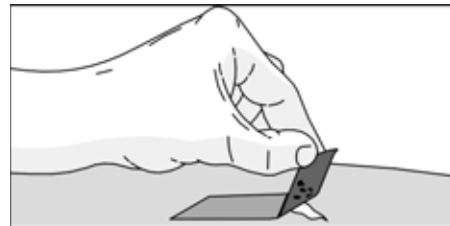

Mask if necessary

Rustproofing

Rustproofing – check and repair

Your car received a thorough and complete rustproofing at the factory. Parts of the body are made of galvanised sheet metal. The underbody is protected by a wear-resistant anti-corrosion compound. Members, cavities and enclosed sections are sprayed with a thin, penetrating rust inhibitor.

The car's rustproofing is maintained by doing the following:

- Keep the car clean! Hose down the underbody.
During high pressure washing - hold the nozzle at least 30 cm from painted surfaces!
- Check and repair the rustproofing regularly.

The car's rustproofing does not normally require treatment for approximately 8 years. After that time, it should be treated at three year intervals. If your car requires treatment, consult your Volvo workshop.

Repair

If you want to repair the rustproofing yourself, make sure the area is clean and dry. Hose down, wash and dry the car thoroughly. Use a rustproofing agent in a spray can or one that is intended for brush application.

There are two different types of rustproofing agents:

- a) thin (colourless), for visible areas
- b) thick, for areas prone to wear on the underbody

Possible repair areas with these agents:

- Visible welds and sheet metal joints - thin fluid
- Underbody - thick fluid
- Door hinges - thin fluid
- Bonnet hinges and catch - thin fluid

Once you have finished treatment, excess rustproofing can be wiped off with a rag dipped in a recommended cleaning agent. Parts of the engine and suspension strut mountings in the engine compartment are treated at the factory with a wax-based, colourless rustproofing. This withstands normal detergents without dissolving and losing its rustproofing ability.

If you wash the engine using aromatic solvents, such as turpentine or white spirit (especially those that do not contain emulsifiers), the protective wax should be renewed after washing. Your Volvo dealer handles such waxes.

Maintenance and service

Volvo service	130
Maintenance	131
Bonnet and engine compartment	132
Diesel	133
Oils and fluids	134
Wiper blades	138
Battery	139
Bulbs	141
Fuses	148

Volvo service

Volvo service programme

Before the car left the factory, it was thoroughly test driven. It was checked again in accordance with Volvo Car Corporation regulations before it was handed over to you.

To keep your Volvo as safe and reliable as possible, follow the Volvo service programme specified in the Warranty and Service Manual. We advise that you always let an authorised Volvo workshop perform service and maintenance work. Your Volvo workshop has the personnel, special tools and service literature that guarantees the highest quality of service. Your Volvo workshop always uses Volvo Genuine parts. The Volvo service programme is developed for normal driving conditions.

IMPORTANT!

For the Volvo warranty to apply, check and follow the instructions in the Service and Warranty Manuals.

Adverse driving conditions

Change engine oil and replace air and oil filters more often than recommended in the Service and Warranty manual when driving in adverse conditions.

Adverse driving conditions include:

- Prolonged driving in dusty/sandy conditions
- Prolonged driving with caravan or trailer
- Prolonged driving in mountainous areas
- Prolonged driving at high speeds
- Prolonged idling and/or driving at low speeds
- Driving in low temperatures – below 0 °C – along shorter distances; less than 10 km.

Environmental care

There are many examples of environmental care within the Volvo field of activity. We use a chlorine-free refrigerant in our climate control systems that is harmless to the ozone layer and contributes very little to the greenhouse effect. Asbestos-free brakes, engines with catalytic converters and biogas operation are other examples of what Volvo Car Corporation is doing for the environment.

Our specific services are also of importance to the environment, such as using Volvo Genuine parts, maintaining ignition and fuel systems, and other measures that directly reduce exhaust emission. We would also like to point out the care taken by our Volvo workshops in regards to handling environmentally dangerous substances.

Maintenance

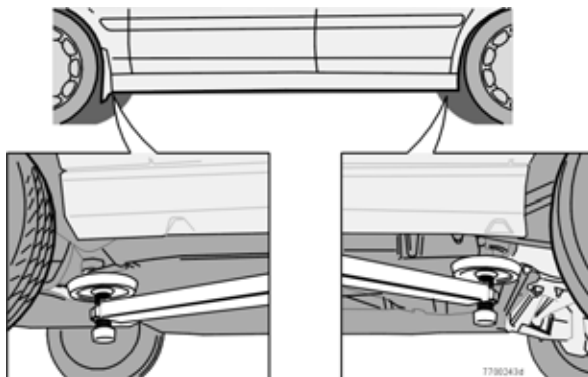

Note the following before you begin working on your car:

Battery

- Ensure that the battery cables are correctly connected and tightened.
- Never disconnect the battery when the engine is running (e.g. when replacing the battery).
- Never use a fast charger to charge the battery. The battery cables should be disconnected when recharging.
- The battery contains acid that is both corrosive and poisonous. It is important that the battery is handled in an environmentally friendly way. Let your Volvo dealer assist you.

Lifting the car

If the car is lifted with a workshop jack, it should sit with the front edge on the engine support arm. Do not damage the splashguard under the engine. Ensure that the jack is positioned so that the car cannot slide off the jack. Always use axle stands or the like.

- If you lift the car using a two pillar workshop lift, ensure that the front and rear lift arms are fixed under the lifting points on the door sill. See the illustration.

WARNING!

Never try to repair any part of the SRS or SIPS bag systems yourself. Any interference in the system could cause malfunction and serious injury. Any work should only be performed by an authorised Volvo workshop.

WARNING!

The car ignition system has very high voltage!
The voltage in the ignition system is dangerous!

Do not touch spark plugs, ignition cables or the ignition coil when the engine is running or the ignition is switched on!

The ignition should be switched off when:

- Conducting engine tests.
- Replacing parts in the ignition system, such as spark plugs, ignition coil, distributor, ignition cables, etc.

Bonnet and engine compartment



Pull the handle...

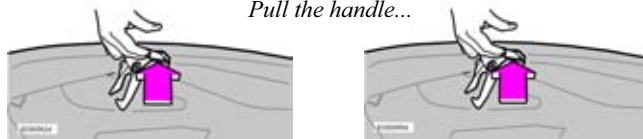

...press up and open

Left-hand drive

Right-hand drive

Opening the bonnet

Pull the handle on the far left or right under the dashboard. You will hear when the lock releases. Insert your hand in the centre of the front edge and press up the safety catch handle. Open the bonnet.

WARNING!

Check that the bonnet locks properly when you close it!

Engine compartment

1. Expansion tank, cooling system
2. Power steering fluid reservoir
3. Washer fluid reservoir
4. Engine oil dipstick
5. Radiator
6. Radiator fan
7. Engine oil filler pipe
- 8a. Clutch/brake fluid reservoir (left-hand drive)
- 8b. Clutch/brake fluid reservoir (right-hand drive)
9. Relay/fuse box

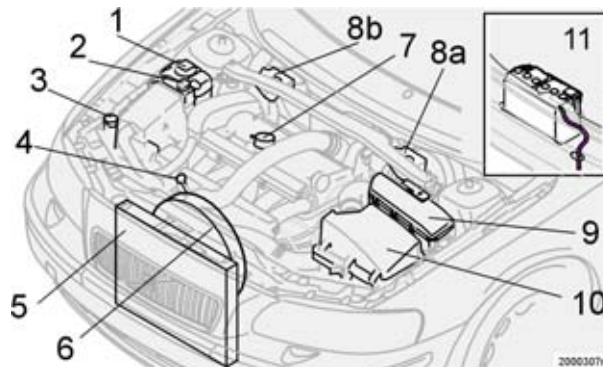

10. Air filter

11. Battery (in cargo compartment)

WARNING!

The radiator fan (6) can start automatically **after** the engine has been switched off! Risk of injury!

WARNING!

Do not wash the engine when it is warm. Risk of fire! Allow a specialist to wash the engine.

Diesel

Fuel system

Diesel engines are sensitive to contaminants.

Only use diesel from a well-know oil company. Never fill up with diesel if the quality is dubious. Special diesel for winter use is available from the large oil companies. This fuel is less viscous at low temperatures and reduces the risk of wax building up in the fuel system.

The risk of condensation building up in the tank is reduced if the tank is kept well filled. When refuelling, check that the area around the fuel filler pipe is clean.

Avoid spilling onto the paintwork. Wash off any spills with detergent and water.

Empty tank

No special procedures are required if the tank runs dry. The fuel system is bled automatically.

RME (Rape Methyl Ester)

Diesel may be mix with max. 5% RME.

Draining condensation from the fuel filter

The fuel filter removes condensation, which could otherwise affect engine function, from the fuel. The fuel filter should be drained as specified in the Service and Warranty Book, and when you suspect that the car has been filled with contaminated fuel.

Oils and fluids

Oil grade:

Petrol engines: ACEA A1

ACEA A3 grade oil can also be used. Note that the same oil can comply with both ACEA A1 and ACEA B1, regardless of whether it is a mineral, semi-synthetic or fully synthetic oil.

For engines in S60 R cars, engine oil which complies with ACEA A3 requirements is recommended.

Diesel engines: ACEA B4

Note that the same oil can comply with ACEA A3, ACEA B3 and ACEA B4, regardless of whether the oil is a mineral oil, semi-synthetic or fully synthetic.

Do not use extra additives. These can damage the engine.

Castrol® fully synthetic engine oil is recommended for cars with turbocharged petrol engines and turbo diesel engines.

Volvo recommends Castrol® oil products.

Changing the oil and oil filter

Your Service and Warranty Manuals contain instructions regarding suitable intervals for changing oil and oil filters. Shorter intervals are recommended for driving in adverse conditions*.

*: See page 130

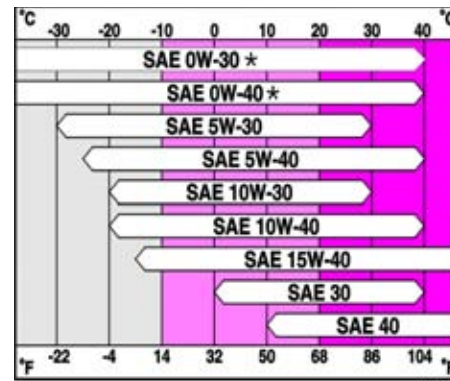

* Oils with a viscosity of 0W-30 and 0W-40 must fulfil ACEA A3 requirements (petrol engines).

Viscosity

(assumes constant air temperature)

In extreme driving conditions that give abnormally high oil temperature or oil consumption, such as driving in the mountains with a great deal of engine braking and motorway driving at high speed, oils fulfilling the requirements of ACEA A3 (petrol engines) are recommended.

Check the oil level

Volvo recommends that the oil level is checked every 2500 km.

Checking the engine oil level is especially important before the first scheduled oil change. Park the car on a level surface and wait at least 5 minutes after switching off the engine so that the oil has time to run back to the oil sump. The most accurate measurement is made on a cold engine before starting. Wipe the dipstick before checking.

R version

The S60-R is also equipped with a system which displays warning messages in the combined instrument panel when the engine oil level is too low.

When the orange warning triangle and the warning message “OIL LEVEL LOW – FILL OIL” are displayed, top up with one litre of oil. After filling, check that the oil level is within the markings on the dipstick before restarting the engine.

When the red warning triangle and the warning message “OIL LEVEL LOW – STOP SAFELY/- STOP ENGINE/- SEE MANUAL” are displayed, top up with at least one litre of oil but no more than 1.5 litres.

After filling, check that the oil level is within the markings on the dipstick before restarting the engine.

For more information regarding oil level checking for the R version, see page 33.

The oil level should fall within the markings on the dipstick.

The distance between the MAX and MIN marks on the dipstick corresponds to approximately 1.5 litres for petrol engines* and approx. 2.0 litres for diesel engines.

If the oil level is at MIN, top up with:

Cold engine: 1 litre.

Warm engine: 0.5 litre.

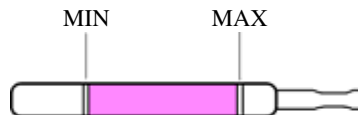

*Approx. 1.5 litres for petrol engines**

Approx. 2.0 litres for diesel engines

**: approx. 1.2 litres for the R version*



WARNING!

Do not spill oil on the hot exhaust pipes.
Rise of fire!

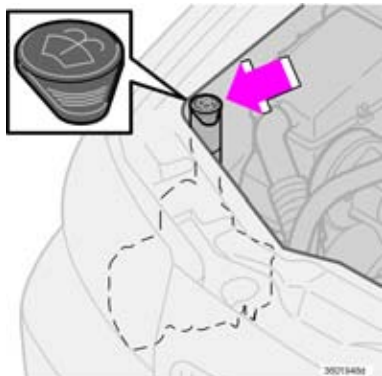

Washer fluid reservoir

Washer fluid reservoir

The wipers for the windscreen and headlamps share the same fluid reservoir. It is located under the bonnet and has a capacity of 4.5 litres.

Use washer fluid during the winter so that the fluid does not freeze in the pump, reservoir and hoses.

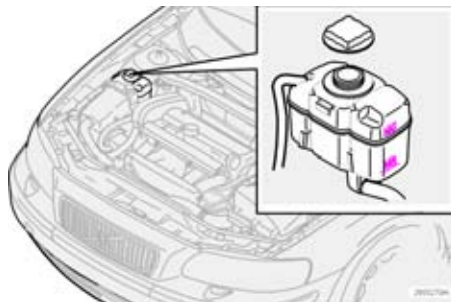

Coolant reservoir

Coolant

Never top up with ordinary water only! Use a mixture of half water, half Volvo coolant all year round. It is important to use equal amounts. The risk of freezing increases with both too little and too much coolant.

NOTE! Certain engine components are manufactured with aluminium alloy. It is therefore very important to use Volvo coolant with superior anti-corrosion properties! When the car is new, the coolant can withstand approximately -35°C .

Check coolant regularly!

The level should lie between the MIN and MAX marks on the expansion tank. Top up the coolant if the level falls below the MIN mark.

If you need to top up the coolant when the engine is warm, unscrew the expansion tank cap slowly so that the overpressure dissipates.

NOTE! The engine must only be run with a well-filled cooling system. If the system is not well filled, high temperatures can occur, causing a risk of cracks in the cylinder head.



WARNING!

If you need to top up the coolant when the engine is warm, unscrew the expansion tank cap slowly so that the overpressure dissipates.

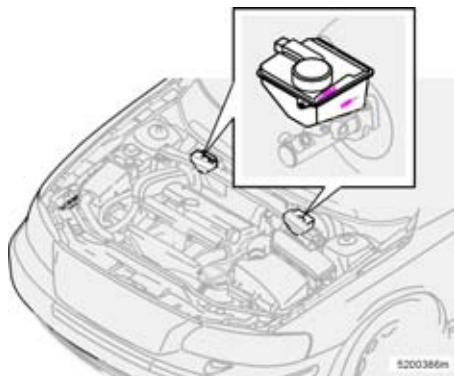

Clutch and brake fluid reservoir

The brake and clutch have the same reservoir. The location of the reservoir differs between right and left-hand drive cars.

The level should lie between the MIN and MAX marks.

Fluid grade: Brake fluid DOT 4+.

Check the level regularly.

Change the fluid every other year or at every other regular service interval.

NOTE! The fluid should be changed annually on cars that drive in conditions requiring hard, frequent braking, such as driving in mountains or tropical climates with high humidity. This change is not part of a service schedule, but should be done in connection with a service at your Volvo workshop.

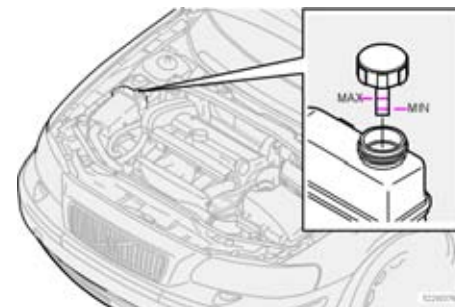

Power steering fluid reservoir

The level should lie between the MIN and MAX marks.

Grade: Power steering fluid of type Pentosin CHF 11S or the like.

Check the level at every service. It is not necessary to change the fluid.

NOTE! It is possible to steer if a fault should occur in the power steering system or if the car loses electrical power and requires towing. Bear in mind that steering will be more difficult than normal and more force will be required to turn the steering wheel.

Wiper blades

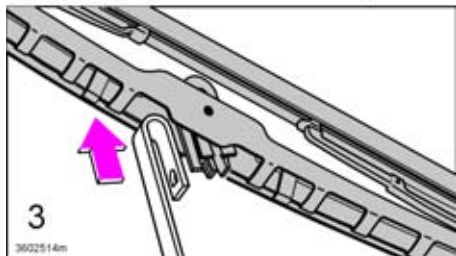
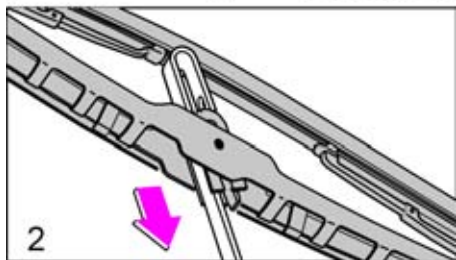
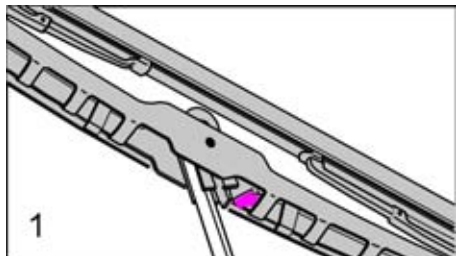

Changing windscreen wiper blades

1. Fold out the wiper arm and hold the wiper blade at 45 ° to the wiper arm. Press in the spring on the wiper blade.
2. Press the entire wiper blade down so that the wiper arm eye passes through the hold in the wiper blade mounting.
3. Then pull the blade up so that the wiper arm eye passes beside the wiper blade mounting. Fit the new blade in reverse order and **check that it is securely in place.**

NOTE! Keep in mind that the wiper blade on the driver's side is straight and has a spoiler while the one on the passenger side is curved. The spoiler on the driver's side should sit on the lower side of the blade. The curve of the blade should follow the curve of the bottom edge of the windscreen.

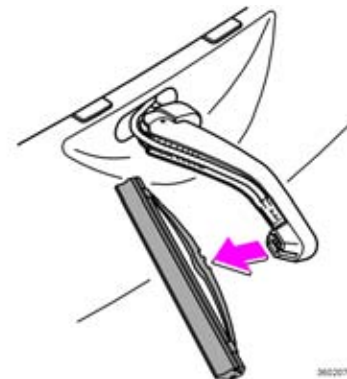

Changing headlamp wiper blades

Fold the wiper arm forward. Remove the wiper blade outwards. Press the new wiper blade into position.

Check that it is properly secured!

Battery

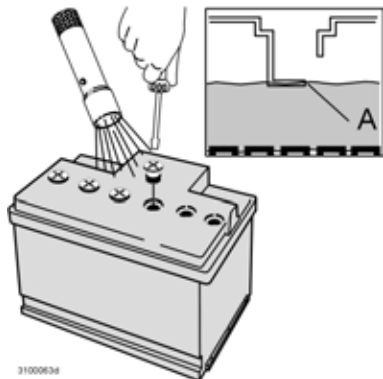

Battery care

The function and life of the battery are affected by driving conditions, driving style, number of starts, climate conditions, etc. For the battery to function satisfactorily, you should consider the following:

- Regularly check that the battery fluid level is correct (A).
- Check all battery cells. Use a screwdriver to remove the cover. A flashlight is useful for checking the fluid level. Each cell has a maximum mark (A).
- As needed: fill the battery with water up to the maximum mark.

NOTE! Never fill above the maximum mark (A)!

- Do not use normal tap water. Use distilled or deionised water (battery water).
- If you wish to charge your battery for any reason, you must check the fluid level after charging and top up with water as needed.
- Make sure that the plugs are properly tightened

NOTE! The number of times the battery is run flat negatively affects its service life.



WARNING!

- Remember that the battery contain oxyhydrogen, which is highly explosive. An open flame or smoking near the battery is enough to cause the battery to explode and cause you injury and/or damage the car.
- The battery also contains sulphuric acid, which can cause serious corrosive damage. If the acid comes into contact with your eyes, skin or clothes, flush with large quantities of water. If acid splashes into your eyes contact a doctor immediately.

Symbols:



Use protective goggles



Further information in the owner's manual.



Store the battery out of the reach of children.



The battery contains corrosive acid.



Avoid sparks and open flames.



Risk of explosion.

Battery (Contd)

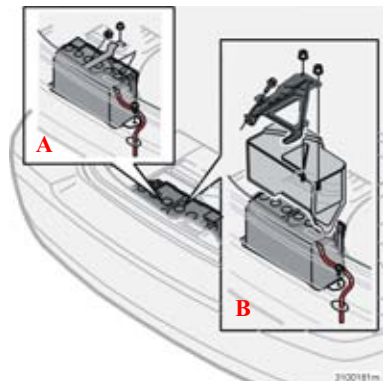

Replacing the battery

A. Battery without cover (see illustration)

- Check that the ignition is switched off.
- **Wait** at least 10 minutes before touching any electrical terminals (so that the information in the car's electrical system can be stored in the different control modules).
- Undo the bolts from the lock brace over the battery and remove the brace.
- **Disconnect the negative lead first.**
- Fold up the plastic cover over the positive terminal of the battery.

- Disconnect the positive lead and remove the plastic cover from the positive terminal.
- Detach the oxyhydrogen gas evacuation hose from the battery.
- Undo the nut from the lower bracket and remove the bracket.
- Lift out the old battery.
- Put the new battery in place.
- Fit the lower bracket and tighten the nut.
- Press the plastic cover of the positive battery terminal in place and connect the positive lead.
- Fold down the plastic cover over the positive terminal and then connect the negative lead.
- Make sure the evacuation hose is correctly connected to both the battery and the outlet in the bodywork.
- Fit the lock brace over the battery and tighten the bolts.

B. Battery with cover (see illustration)

Once you have unscrewed the bracket and the cover from over the battery, remove the battery as described in version A.

Important!

Repeated use of the parking heater and other great power consumers in combination with short trips can lead to battery discharge and thereby difficulty starting.

If great power consumers are used regularly, the car should be driven for the same amount of time as these consumers were connected in order to ensure that the generator is able to produce enough energy to compensate for the amount consumed.



WARNING!

Evacuation of oxyhydrogen gas

The battery can develop oxyhydrogen gas, which is extremely explosive. To prevent oxyhydrogen gas from remaining in the cargo and passenger compartments, there is an evacuation hose that leads any oxyhydrogen gas from the battery to the outside of the car.

If the battery must be replaced for some reason, make certain that the evacuation hose is connected to the new battery and it is run downwards to its intended outlet in the bodywork.

Bulbs

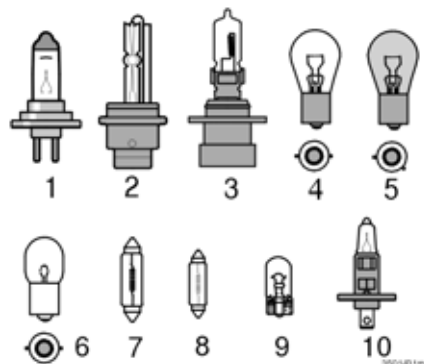

The following bulbs are used in the car:

- | | |
|--|-------------------|
| 1. Dipped beam | 55W H7 |
| 2. Bi-Xenon (option)
(gas discharge lamp) | 35W D2R |
| 3. Main beam | 55W HB3 |
| 4. Brake light | P21W |
| Fog lamp, rear | P21W |
| 5. Direction indicator,
rear + front | PY21W
(yellow) |
| 6. Tail lamps,
Position/parking lamps | P5W |
| Side marker light, rear | P10W |
| 7. Courtesy lighting | W5W |
| Cargo compartment lighting | W5W |
| 8. Vanity mirror | 1.2 W |

- | | |
|---------------------------------------|-----------------|
| 9. Numberplate lighting | W5W |
| Position/parking lamps
in headlamp | W5W |
| Side indicator lamp | W5W
(yellow) |
| 10. Fog lamps | 55W H1 |
| R version | 55W H3 |

NOTE! Never touch the glass of bulbs 1, 2, 3 and 10 with your fingers. Grease and oil from your fingers vaporise when the lamp is hot, coating and damaging the reflector.

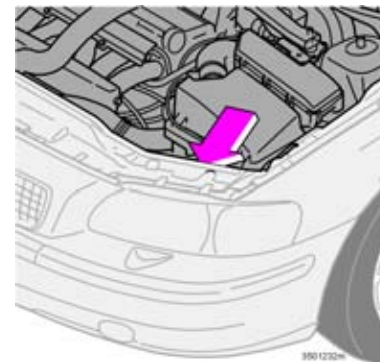

Replacing dipped beam and main beam bulb

Both headlamp bulbs are replaced from the engine compartment.

WARNING!

If your car is equipped with Bi-Xenon headlamps (option), the bulbs must be replaced by an authorised Volvo workshop due to the high voltage.

NOTE! Bi-Xenon lamps contain a small quantity of mercury; dispose of used lamps properly. Consult your Volvo dealer or authorised Volvo workshop.

Bulbs (Contd)

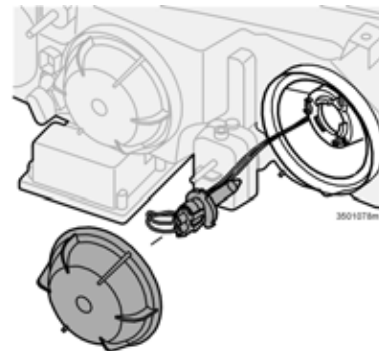
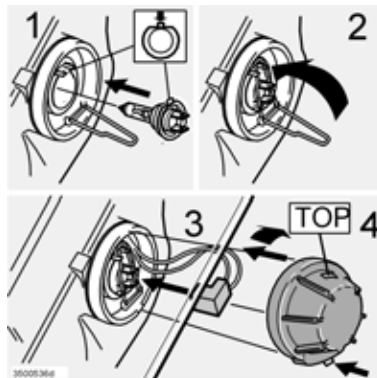
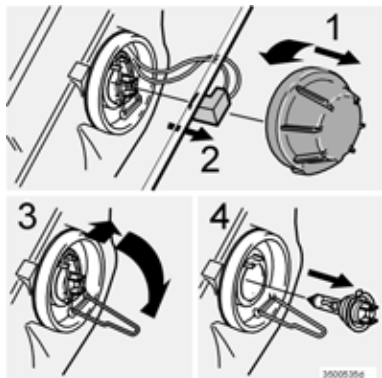

Dipped beam bulb

Removing the bulb

- Switch off all lights and turn ignition key to position 0.
- Open the bonnet.
- Undo the outer cover by turning it anticlockwise (1).
- Pull off the connector (2).
- Disconnect the spring clamp. First push to the right so that the spring disconnects and then out and down (3).
- Pull out the bulb and replace it with a new one (4).

Fitting the bulb

- Put the new bulb in place (1). It can only be fitted in one position.
- Press the clamp spring upwards and a little to the left so that it secures in its catch (2).
- Press the connector back into place (3).
- Screw the cover into place; "TOP" should face up (4).

Main beam bulb

- Switch off all lights and turn ignition key to position 0.
- Open the bonnet.
- Undo the inner cover by turning it anticlockwise.
- Twist the bulb anticlockwise, pull it out and fit a new bulb. Note how it sits!
- Put the lamp back into place. It can only be fitted in one position.
- Screw the cover into place; "TOP" should face up.

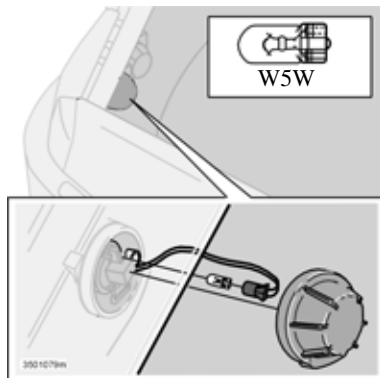

Replacing the front position/ parking lamp bulb

- Switch off all lights and turn ignition key to position 0.
- Undo the dipped beam* cover by turning it anticlockwise.
- Pull out the bulb and its socket. Replace the bulb.
- Press the bulb and its socket back into place.
- Check that the new bulb lights.
- Screw the cover back into place; "TOP" should be up!

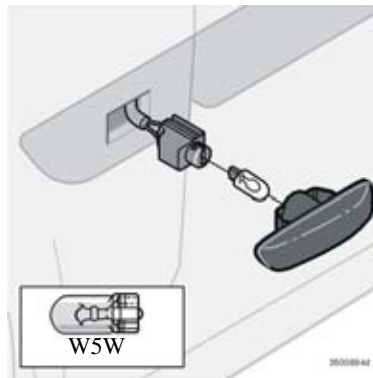

Replacing side direction indicator bulb

- Open the front door halfway.
- Insert your hand behind the front fender and push the lamp out. Let the cables remain in the bulb holder.
- Turn the bulb holder 1/4 turn anticlockwise and pull straight out.
- Pull the defective bulb straight out.
- Replace with a new bulb and press the lamp straight in.

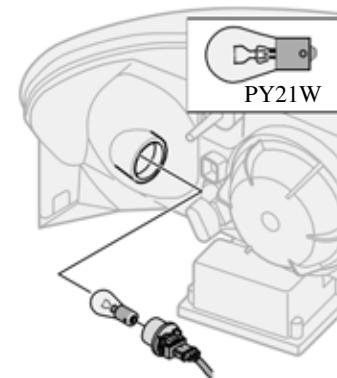

Replacing the direction indicator* bulb in the front left-hand corner

- Switch off all lights and turn ignition key to position 0.
- Twist the bulb holder anticlockwise and remove it.
- Press the bulb inwards, turn it anticlockwise and remove it from the bulb holder.
- Replace with a new bulb and refit the bulb holder in the lamp housing.

Switch on the ignition and check that the new bulb lights.

* This lamp is located in the direction indicator lamp housing for cars with Bi-Xenon headlamps.

Bulbs (Contd)

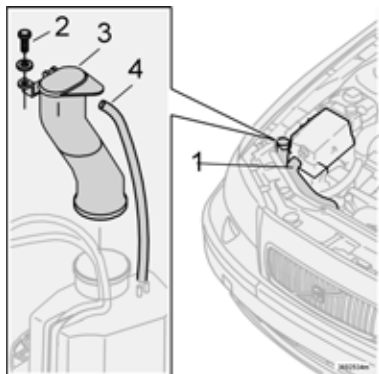

Replacing the direction indicator bulb in the front right-hand corner

- Switch off all lights and turn ignition key to position 0.
- Remove the radiator hose (1) from the radiator.
- Remove the screw (2) to the filler pipe.
- Pull the pipe (3) straight up.
- Remove the ventilation hose (4) from the pipe.
- Remove the bulb holder by turning **clockwise**.
- Press the bulb inwards, turn it anticlockwise and remove it from the bulb holder.

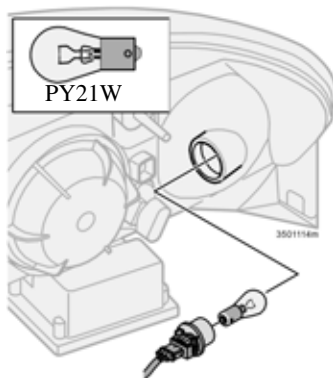

- Replace with a new bulb and refit the bulb holder in the lamp housing.
- Check that the washer fluid reservoir gasket between the filler pipe and the holder is properly secured.
- Put the filler pipe (3) back into place.
- Refit the ventilation hose onto the filler pipe (4).
- Retighten the filler pipe screw (2).
- Refit the radiator hose to the radiator (1).

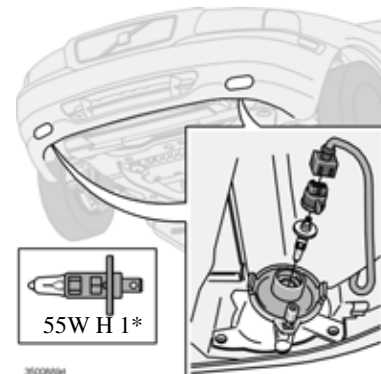

Replacing the fog lamp bulb (option)

- Switch off all lights and turn ignition key to position 0.
- Turn the bulb holder slightly anticlockwise.
- Remove the bulb.
- Put the new bulb in place. The profile of the bulb holder matches the one on the foot of the lamp.
- Refit the bulb holder by twisting slightly clockwise. " TOP " should face up!

*: H3 in the R version

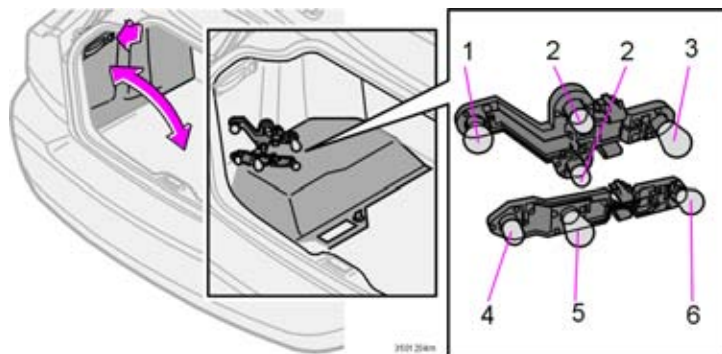

Replacing bulbs in the rear lamp cluster

All bulbs in the rear lamp cluster can be replaced from inside the cargo compartment.

- Switch off all lights and turn ignition key to position 0.
- Unlock and fold down the side panel to access the bulbs.

The bulbs are located in two separate bulb holders, an upper and a lower. Each bulb holder has a locking pin.

Replace bulbs in the upper and lower bulb holders as follows:

- To ease the work: disconnect the cable from the bulb holder.
- Press the catches together and pull out the holder.
- Replace the bulb.
- Reconnect the cable.
- Close and secure the side panel.

Location of bulbs

- | | |
|-----------------------------|------------------|
| 1. Brake light | 21 W BA 15 |
| 2. Position/parking lamp | 5 W BA 15 |
| 3. Rear fog lamp (one side) | 21 W BA 5 |
| 4. Side marker light | 10W |
| 5. Direction indicator | PY 21 W (yellow) |
| 6. Reversing lamp | 21 W BA 15 |

High-level brake light

These bulbs are of a special type. We recommend that you ask your Volvo workshop for assistance when replacing them.

Bulbs (Contd)



Replacing the numberplate lighting bulb

- Switch off all lights and turn ignition key to position 0.
- Remove the screw with a screwdriver.
- Carefully remove the entire lamp housing and pull it out. Turn the contact anticlockwise and pull out the bulb.
- Replace the bulb.
- Refit the contact and turn clockwise.
- Refit the entire lamp housing and screw it into place.

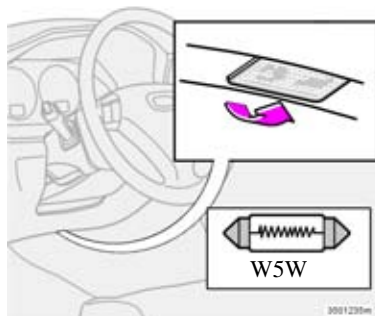

Replacing the courtesy lighting bulb

Courtesy lighting is located under the dashboard on the driver and passenger sides. Replace the bulb as follows:

- Insert a screwdriver and gently turn so that the lamp housing loosens.
- Remove the faulty bulb.
- Replace the bulb. Check that the bulb lights.
- Refit the lamp housing.

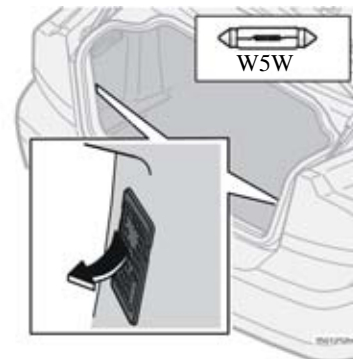

Replacing the bulb in the cargo compartment

- Insert a screwdriver and gently turn so that the lamp housing loosens.
- Remove the faulty bulb.
- Replace the bulb. Check that the bulb lights.
- Refit the lamp housing.

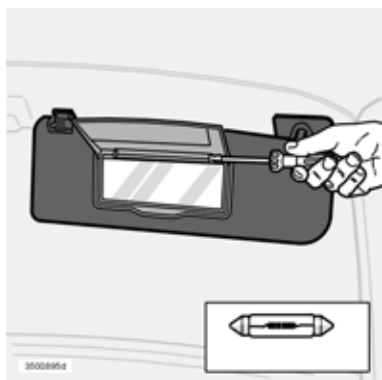

Vanity mirror

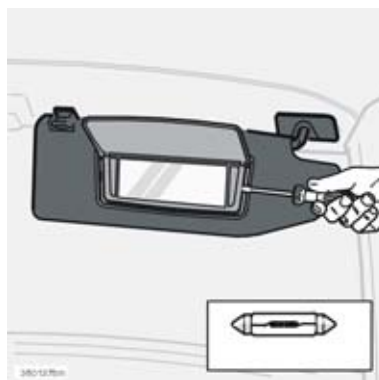

Vanity mirror, certain models.



Replacing vanity mirror bulb

- Insert a screwdriver and gently turn so that the glass loosens.
- Prise out the bulb and replace with a new one.
- First press the bottom of the lamp glass back into place above the four hooks. Then press the top in place.

Roof lighting with front reading lamps

These bulbs are of a special type. We recommend that you ask your Volvo workshop for assistance when replacing them.

Bulbs (cont.)



Rear reading lamps

These bulbs are of a special type. We recommend that you ask your Volvo workshop for assistance when replacing them.

Fuses



Fuses

All electrical functions and components are protected with a number of fuses to protect your car's electrical system from damage by short-circuits or overloads.

Fuses are located in three different locations in the car:

- A. Relay/fuse box in the engine compartment.
- B. Fuse box in the passenger compartment.
- C. Relay/fuse box in the cargo compartment.

If an electrical component or function does not work, it may be because the component's fuse was temporarily overloaded and blew. Look in the fuse diagram to locate the affected fuse. Pull out the fuse and look at it from the side to see if the curved wire is burned out. If this is the case, replace with a new fuse with a fuse of the same colour and amperage. The fuse box in the engine compartment contains a number of spare fuses. There are also pliers to assist you in removing and replacing fuses.

If the same fuse blows repeatedly, there is a fault in the component. Contact an authorised Volvo workshop to have it checked.

Relay/Fuse box in the engine compartment

This fuse box contains 24 fuse positions. Be sure to replace a blown fuse with a new fuse with the same colour and amperage.

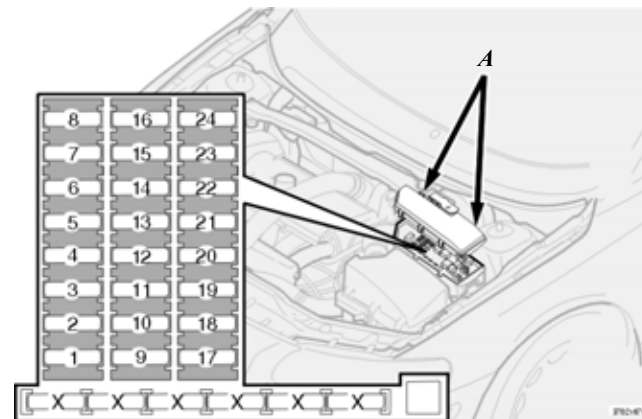
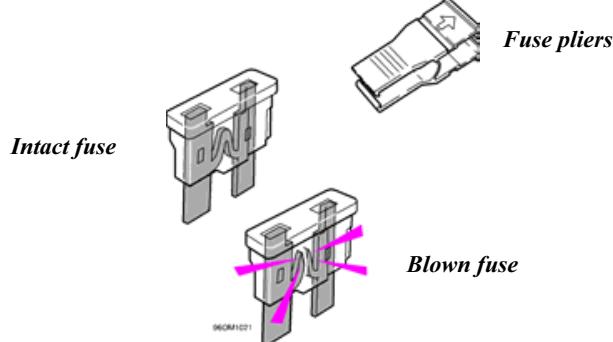

A. Press in the plastic lugs on the back of the box and pull the lid upwards.

Fuses in the engine compartment

No.	Amperage	
1.	25	Parking heater (option)
2.	20	Auxiliary lamps (option)
3.	–
4.	20	Lambda sensors, engine control module (diesel), high-pressure valve (diesel)
5.	10	Crankcase ventilation heater, solenoid valves Fuel valve (Bi-Fuel)
6.	15	Mass air flow sensor, engine control module, injectors
	5	Mass air flow sensor (diesel)
7.	10	Throttle module
8.	10	AC compressor, accelerator pedal position sensor, E-box fan
9.	15	Horn
10.	–
11.	20	A/C compressor, ignition coils, solenoid valves (diesel)
12.	5	Brake light contact
13.	25	Windscreen wipers
14.	30	ABS/STC/DSTC
15.	15	Gas tank valve (Bi-Fuel)
16.	15	Windscreen washers, headlamp washers
17.	10	Dipped beam (right)
18.	10	Dipped beam (left)
19.	30	ABS/STC/DSTC
20.	15	Main beam (left)
21.	15	Main beam (right)
22.	40	Starter motor
23.	5	Engine control module
24.	–

Fuses in the passenger compartment

This fuse box contains 38 fuse positions. The fuses plus several spare fuses are located inside the panel on the end of the dashboard.

No.	Amperage
1. Headlamps (dipped beam), Bi-Xenon (option).....	15
2. Headlamps (main beam).....	20
3. Power driver's seat.....	30
4. Power passenger seat.....	30
5. Speed-dependent power steering, vacuum pump.....	15
6. Gas tank valve (Bi-Fuel).....	5
7. Heated seat (front left).....	15
8. Heated seat (front right).....	15
9. ABS/STC/DSTC.....	5
10.....	-
11.....	-
12. Headlamp levelling, headlamp wipers.....	15
13. Electric socket 12V.....	15
14. Power passenger seat.....	5
15. Audio, RTI (option).....	5
16. Audio.....	20
17. Amplifier.....	30
18. Fog lamps (front).....	15
19. RTI-display (option).....	10
20.....	-
21. Extended D2 feed: automatic gearbox, shiftlock.....	10
22. Direction indicators.....	20
23. Light switch module, climate control unit, diagnostic socket, steering wheel lever control unit.....	5
24. Extended D1-feed, climate control system, power seat (driver), combined instrument panel, parking heater (option).....	10
25. Ignition switch (30-feed), Central Electronic Module, relay starter motor, engine control module.....	10

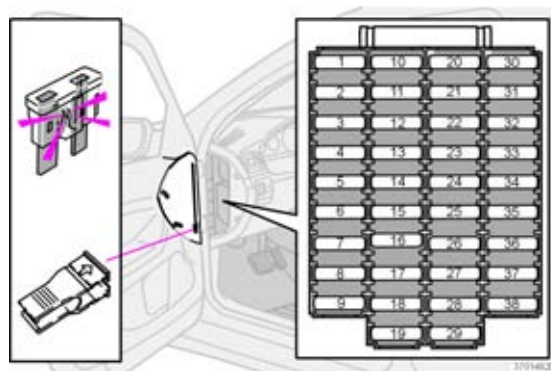

26. Climate control system fan.....	30
27. Active chassis FOUR-C.....	15
28. Electronic module (roof), interior lighting (ceiling).....	10
29. Telephone (option).....	10
30. Position/parking lamps (left - front and rear).....	7.5
31. Position/parking lamps (right - front and rear), numberplate lighting.....	7.5
32. Central electronic module, vanity mirror lighting, power steering, general lighting, glovebox lighting.....	10
33. Fuel pump.....	15
34. Sunroof.....	15
35. Central locking, power window, door mirror (front left).....	25
36. Central locking, power window, door mirror (front right).....	25
37. Power windows (rear), child safety lock.....	30
38. Alarm siren.....	5

Fuses in the cargo compartment

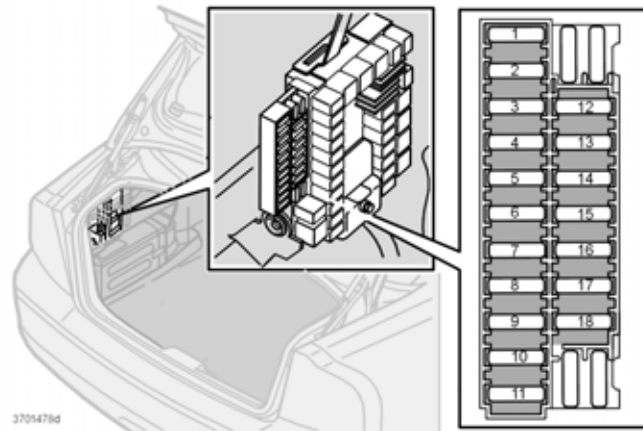
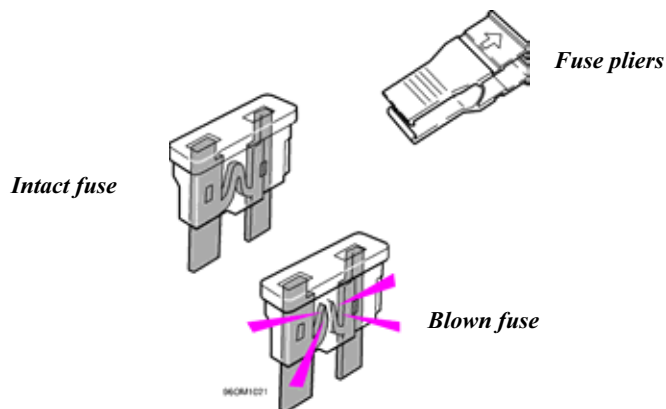

No.	Amperage
1. Rear Electronic Module (REM), lighting (cargo compartment).....	10
2. Rear fog lamps	10
3. Brake light.....	15
4. Reversing lamp	10
5. Rear window defroster, relay 151-feed (rear)	5
6. Tailgate opening.....	10
7. Folding head restraints.....	10
8. Rear door locks, fuel filler flap.....	15
9. Towbar (30 feed).....	15
10. CD changer (option), RTI (option)	10
11. Accessory Electronic Module - AEM (option).....	15
12.	-
13.	-
14. Brake light.....	7.5
15. Towbar (151 feed)	20
16. Electric socket, cargo compartment (option).....	15
17. Heated fuel filter (diesel) Control module, all-wheel drive (AWD cars).....	7.5
18. Heated fuel filter (diesel)	15

Specifications

Type designations	154
Measurements, weights, capacities	155
Lubricants	156
Cooling system	156
Catalytic converter	157
Petrol	158
Suspension, spring suspension	159
Electrical system	160
Engine specifications	161

Type designations

When contacting your Volvo dealer about your car and when ordering spare parts and accessories, it makes things easier if you know your car's type designation, vehicle identification number and engine number.

1. Type and model year designation and vehicle identification number

Stamped in the engine compartment underneath the windscreen.

2. Type designation, vehicle identification number, maximum permissible weights, codes for colour and upholstery and type approval number.

Plate on the wing liner behind the right headlamp.

3. Engine type designation, component and serial number

On the right-hand side of the engine

4. Gearbox type designation and serial number

a: Manual gearbox: on front side

b: Automatic gearbox AW: on the upper side

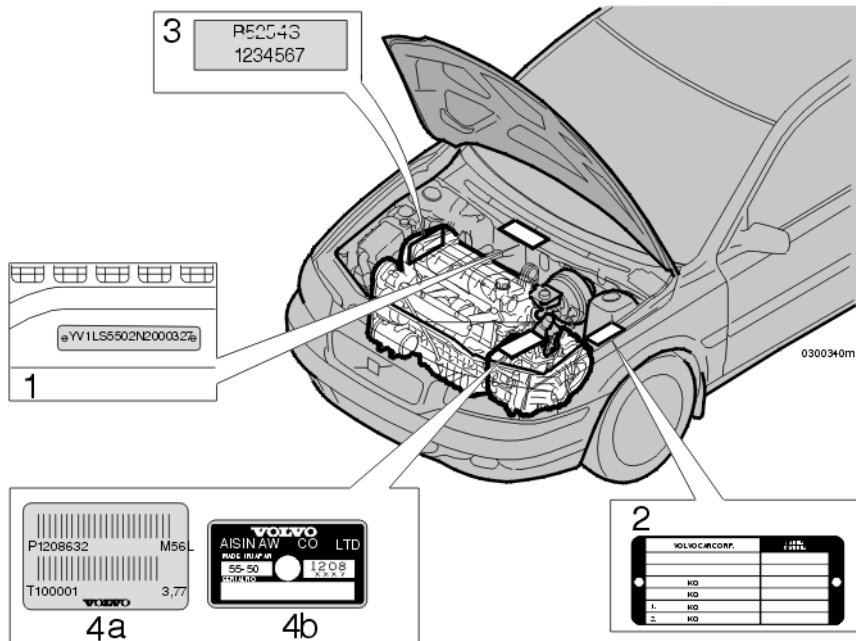

Measurements, weights, capacities

Measurements and weights

Length	458 (R: 461) cm
Width	180 cm
Height	143 cm
Wheelbase	272 cm
Front track	156 cm
Rear track	156 cm

Permissible weight (excluding driver) =
Total weight – service weight

Chassis data plate with weight specification on the plate in the engine compartment

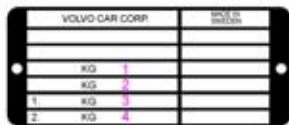

1. Max. total weight
2. Max. train weight (car+trailer)
3. Max. front axle load
4. Max. rear axle load

Max. load, see registration papers

Maximum roof load	100 kg
Maximum trailer weight	1600 kg

Capacities

Fuel tank (litres)

Petrol	70
AWD-Diesel	68

Engine oil, incl. filter change¹(litre)

B5204T5	5.5
B5234T3	5.5
B5234T7	5.5
B5244S (170 hk)	5.5
B5244S2 (140 hk)	5.5
B5254T2 2.5T	5.5
B5254T4 R	5.5
D5244T D5	7.0
D5244T2 2.4D	7.0
D5244T3 2.4D	7.0

Gearbox oil (litres)

Manual (5-speed)	2.1
Manual (6-speed)	2.0
Automatic	7.2

Miscellaneous

Power steering	0.9 litres
Windscreen washer fluid reservoir	4.5 litres
Brake and clutch fluid	0.6 litres
Air conditioning system	1000 grams

¹: To verify which engine is in the car - see the type designation stamped into the engine compartment (previous page, point 3).

Important!

After changing the oil, use the dipstick to check that the engine has the correct amount of oil. Warm up the engine and then check the oil a few minutes after the engine is switched off.

Lubricants

Engine

Petrol engines: ACEA A1

ACEA A3 grade oil can also be used. Note that the same oil can comply with both ACEA A1 and ACEA B1, regardless of whether it is a mineral, semi-synthetic or fully synthetic oil.

Volvo fully synthetic engine oil is recommended for cars with turbocharged petrol engines and turbo diesel engines.

Diesel engines: ACEA B4

Note that the same oil can comply with ACEA A3, ACEA B3 and ACEA B4, regardless of whether the oil is a mineral oil, semi-synthetic or fully synthetic.

Do not use extra additives. These can damage the engine.

Viscosity

(assumes constant air temperature)

In extreme driving conditions that give abnormally high oil temperature or oil consumption, such as driving in the mountains with a great deal of engine braking and motorway driving at high speed, oils fulfilling the requirements of ACEA A3 (petrol engines) are recommended.

See also page 134.

NOTE! Oils with a viscosity of 0W-30 and 0W-40 must fulfil the requirements of ACEA A3 (petrol engines).

Gearbox

Manual

Use Volvo synthetic gearbox oil only.

Automatic

Volvo gearbox oil
part no. 1161540-8 only.
Do not mix with any other oil!

Power steering

Grade: Power steering fluid of type Pentosin CHF 11S or the like.

Volume: approx. 0.9 litre

Brake fluid

Fluid type: Brake fluid DOT 4+

Volume: approx. 0.6 litre

Important!

If in doubt about the correct oil grade - contact a Volvo workshop.

Cooling system

Engine

Petrol without turbo

Petrol with turbo

Diesel

Volume (litre)

approx. 8.0

approx. 9.0

approx. 12.5

All systems are closed overpressure systems.
The thermostat starts to open at 90°C.

Catalytic converter

Catalytic converter

The catalytic converter is an additional part of the exhaust system. Its purpose is to purify exhaust. The converter primarily consists of a housing with two monoliths that are designed so that the exhaust gases pass through a honeycomb of channels. The channel walls are lined with a thin layer of platinum, rhodium and palladium. These metals act as catalysts, i.e. they participate in and accelerate a chemical reaction without being used up themselves.

Lambda-sond TM (heated oxygen sensor, petrol engines only)

The lambda sensor is part of a management system intended to reduce emissions and improve fuel economy. An oxygen sensor monitors the oxygen content of the exhaust gases leaving the engine. These values are fed into an electronic system that continuously controls the injectors. The ratio of air to fuel is continuously adjusted. These adjustments create optimal conditions for efficient combustion, and together with the three-way catalytic converter reduce harmful emissions (hydrocarbons, carbon monoxide and nitrous oxides).

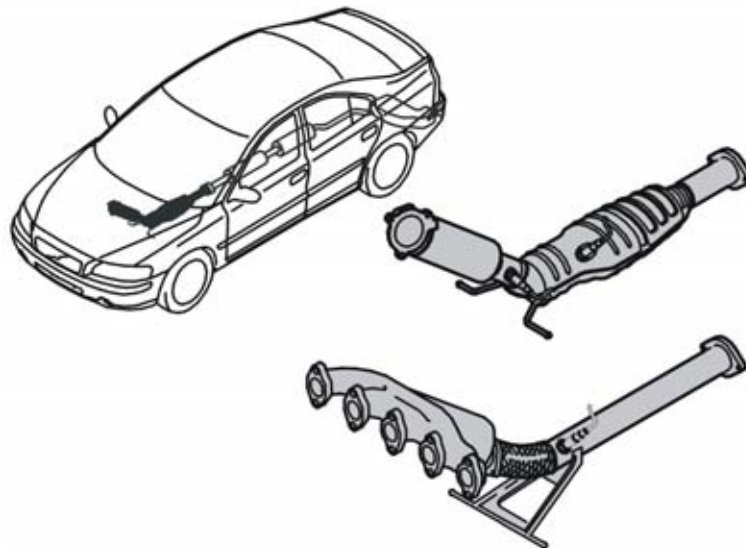

Fuel

Petrol

The engine can be run with octane ratings of 91, 95 and 98 RON.

- 98 RON is recommended for maximum effect and minimum fuel consumption.
- 95 RON can be used for normal driving.
- 91 RON should only be used as an exception. However, the engine will not be damaged by this fuel grade.

Standard DIN 51600

Min. 91 Octane RON Unleaded

Fuel consumption and carbon dioxide

Engine		Gearbox	Consumption in litres/100 km	Carbon dioxide emission (CO ₂) g/km
B5204T5		Manual	9.1 - 9.2	215 - 218
		Automatic	9.9 - 10.1	236 - 240
B5234T3		Manual	9.2 - 9.3	219 - 222
		Automatic	10.0 - 10.2	236 - 240
B5244S		Manual	8.9 - 9.0	212 - 215
		Automatic	9.5 - 9.6	226 - 229
B5244S2		Manual	8.8 - 8.9	209 - 212
		Automatic	9.5 - 9.6	226 - 229
B5254T2	2.5T	Manual	9.1 - 9.2	217 - 220
FWD		Automatic	9.8 - 9.9	232 - 236
B5254T2	AWD 2.5T	Manual	9.8	234
		Automatic	10.3 - 10.5	246 - 251
B5254T4	R	Manual	10.5 - 10.7	252 - 256
		Automatic	10.9 - 11.1	261 - 266
D5244T	D5	Manual	6.3 - 6.5	166 - 171
		Automatic	7.6	201
D5244T2	2.4D	Manual	6.3 - 6.5	167 - 171
		Automatic	7.6	201
D5244T3	2.4D	Manual	6.3 - 6.5	167 - 171

Diesel

Standard EN 590

Official fuel consumption figures are based on a standard driving cycle; EU directive 80/1268 comb.

Fuel consumption figures may be altered if the car is equipped with extra options which affect car weight. The manner in which the car is driven and other non-technical factors can affect fuel consumption.

Suspension, spring suspension

Front end

MacPherson-type spring strut. Unitary construction of shock absorbers and spring. Rack and pinion steering. Safety type steering shaft. The values apply to an unladen car with full tank, coolant and spare wheel.

Rear suspension

Independent suspension with individually sprung wheels with shock absorbers. The suspension consists of trailing arms, upper and lower control arms, track rods and anti-roll bar.

Wheel angles

Toe-in front (degrees) $0.1^{\circ} \pm 0.1^{\circ}$ $0.1^{\circ} \pm 0.1^{\circ}$

Toe-in rear (degrees) $0.2^{\circ} \pm 0.2^{\circ}$ $0.2^{\circ} \pm 0.2^{\circ}$

Electrical system

12-volt system with voltage regulated alternating current generator. Single pole system in which the chassis and engine block are used as conductors. The negative pole is connected to the chassis.

Battery

Voltage	12 V	12 V	12 V (diesel)
Cold start capacity (CCA)	520 A	600 A	800 A*
Reserve capacity (RC)	90 min	115 min	

If you must replace your battery, be sure to replace it with a battery of the same cold start capacity and reserve capacity as the original (See the decal on the battery).

Generator max. current	140 A
Starter motor , power	1.4 kW

*Cars with parking heater have a 800 A battery.

Bulbs

	Output	Socket
Dipped beam	55 W	H 7
Main beam	55 W	HB3
Bi-Xenon	35 W	D2R
Fog lamps	55 W	H 1 ¹
Position/parking lamp, front	5 W	W 2.1x9.5 d
Side indicator lamps	5 W	W 2.1x9.5 d
Direction indicators, front (yellow)	21 W	BA 15
Direction indicators, rear (yellow)	21 W	BA 15
Position/parking lamp, rear	5 W	BA 15
Brake light	21 W	BA 15
Reversing lamp	21 W	BA 15
Rear fog lamp, rear position/parking lamp	21/4 W	BA 15
Numberplate lighting	5 W	W 2.1x9.5 d
Courtesy lighting, front	5 W	SV 8.5
Cargo compartment	5 W	SV 8.5
Glovebox lighting	3 W	BA 9
Vanity mirror	1.2 W	SV 5.5

¹: R version H3

Engine specifications

	B5204T5	B5234T3	B5234T7	B5244S (170)	B5244S2 (140)	B5254T2 2.5T FWD/AWD
Output*(kW/rps) (hp/rpm)	132/88 180/5300	184/87 250/5200	147/83 200/5000	125/100 170/6000	103/75 140/4500	154/83 210/5000
Torque* (Nm/rps) (kpm/rpm)	240/37-88 24.5/2200-5300	330/42-87 33.7/2500-5200	285/33-83 29.1/2000-5000	225/75 23.0/4500	220/55 22.4/3300	320/25-75 32.6/1500-4500
No. of cylinders	5	5	5	5	5	5
Bore (mm)	81	81	81	83	83	83
Stroke (mm)	77	90	90	90	90	93.2
Cylinder displacement (dm ³ (l))	1.98	2.32	2.32	2.44	2.44	2.52
Compression ratio	9.5:1	8.5:1	8.5:1	10.3:1	10.3:1	9.0:1
Spark plugs						
electrode gap (mm)	0.7-0.8	0.7-0.8	0.7-0.8	1.2	1.2	0.7-0.8
tightening torque (Nm)	30	30	30	30	30	30

*: Output and torque as per testing standard EU 80/1269. For petrol engines, 98 octane is used for this test.

To verify which engine is in the car - see the type designation stamped into the engine compartment (Type designations - page 154, point 3).

Specifications

	B5254T4	B5244SG	B5244SG2	D5244T	D5244T2	D5244T3
	R	CNG (gas)	LPG (gas)	D5	2.4D	2.4D
Output*(kW/rps)	220/90	103/97	103/85	120/67	96/67	85/67
(hp/rpm)	300/5400	140/5800	140/5100	163/4000	130/4000	116/4000
Torque* (Nm/rps)	400/31-95	192/75	214/75	340/29-50	280/29-50	280/29-50
(kpm/rpm)	40.7/1850-5700	19.6/4500	21.8/4500	34.7/1750-3000	28.6/1750-3000	28.6/1750-3000
No. of cylinders	5	5	5	5	5	5
Bore (mm)	83	83	83	81	81	81
Stroke (mm)	93.2	90	90	93.2	93.2	93.2
Cylinder displacement (dm ³ (l))	2.52	2.44	2.44	2.40	2.40	2.40
Compression ratio	8.5:1	10.3:1	10.3:1	18.0:1	18.0:1	18.0:1
Spark plugs						
electrode gap (mm)	0.7	1.2	1.2	–	–	–
tightening torque (Nm)	28	30	30	–	–	–

*: Output and torque as per testing standard EU 80/1269. For petrol engines, 98 octane is used for this test.

To verify which engine is in the car - see the type designation stamped into the engine compartment (Type designations - page 154, point 3).

Audio (option)

Overview HU-403	164
Overview HU-603	165
Overview HU-803	166
Radio (HU-403, 603, 803)	167
Cassette player (HU-403, 603)	176
CD player (HU-603)	177
CD player with internal CD changer (HU-803)	178
External CD changer (HU-403, 603, 803) (accessory)	179
Dolby Surround Pro Logic	180
Specifications	182

Overview HU-403

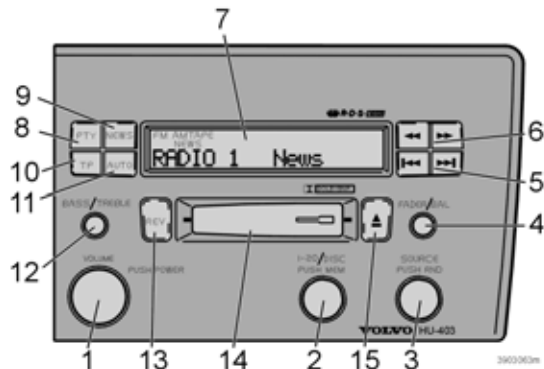

1. **On/Off** - press
Volume - turn
2. **Selector knob:**
Stored radio stations
CD changer (option)
TV (option)
3. **Selector knob:**
Radio
Cassette
CD changer (option)
TV (option)
4. **Fader** - press and turn
Balance - press, pull and turn
5. **Radio** - Station seek up/down
Cassette - Select next/previous track
6. **Radio** - Manual station selection
Cassette - Fast forward/rewind
7. **Display**
8. **Programme type**
9. **News/Radio text**
10. **Traffic information**
11. **Automatic presetting of stations**
12. **Bass** - press and turn
Treble - press, pull and turn
13. **Tape direction selector**
14. **Cassette opening**
15. **Cassette eject**

Overview HU-603

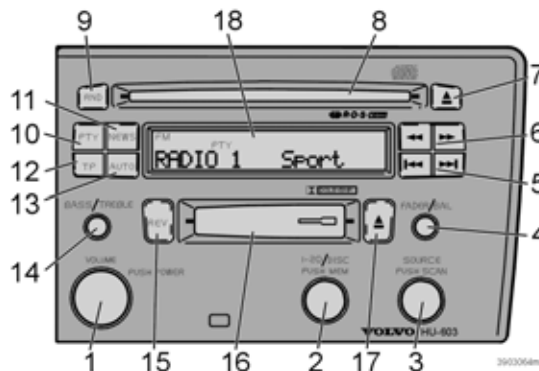

1. **On/Off** - press
Volume - turn
2. **Selector knob:**
Stored radio stations
CD changer (option)
3. **Selector knob:**
Radio
Cassette
CD
CD changer (option)
TV (option)
4. **Fader** - press and turn
Balance - press, pull and turn
5. **Radio** - Station seek up/down
Cassette - Select next/previous track
CD - Select next/previous track
6. **Radio** - Manual station selection
Cassette - Fast forward/rewind
CD - Fast forward/rewind
7. **CD eject**
8. **CD opening**
9. **CD random**
10. **Programme type**
11. **News/Radio text**
12. **Traffic information**
13. **Automatic presetting of stations**
14. **Bass** - press and turn
Treble - press, pull and turn
15. **Tape direction selector**
16. **Cassette opening**
17. **Cassette eject**
18. **Display**

Overview HU-803

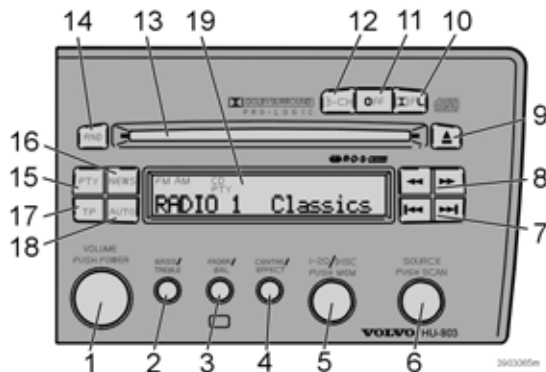

- | | | |
|---|--|---|
| <ol style="list-style-type: none"> 1. On/Off - press
Volume - turn 2. Bass - press and turn
Treble - press, pull and turn 3. Fader - press and turn
Balance - press, pull and turn 4. Centre volume - press and turn
Output volume - press, pull and turn 5. Selector knob:
Stored radio stations
Internal CD changer - select disc
External CD changer - select disc | <ol style="list-style-type: none"> 6. Selector knob:
Radio
CD
CD changer (option)
TV (option) 7. Radio - Station seek up/down
CD - Select next/previous track 8. Radio - Manual station selection
CD - Fast forward/rewind 9. CD eject 10. Dolby Pro Logic 11. 2-channel stereo 12. 3-channel stereo | <ol style="list-style-type: none"> 13. CD opening 14. CD random 15. Programme type 16. News/Radio text 17. Traffic information 18. Automatic presetting of stations 19. Display |
|---|--|---|

Radio (HU-403, 603, 803)

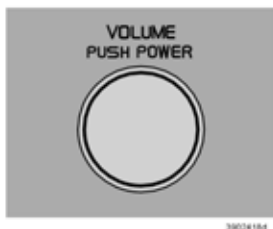

On/Off switch

Press the knob to turn on or switch off the radio.

Volume control

Turn the knob clockwise to increase volume. Volume control is electronic and lacks an end stop. If you have a steering wheel keypad, increase or decrease volume with (+) or (-) buttons.

Volume control - TP/PTY/NEWS

If a cassette or CD is playing when the radio receives a traffic bulletin, news or selected programme type, the function is interrupted and the bulletin or message is broadcast with the volume selected for traffic information, news or programme type. When the bulletin or message is finished, the unit immediately returns to the previously set volume and resumes playing the cassette or CD.

Volume control for integrated telephone (option)

If the telephone rings while the radio is playing, the radio volume is lowered when the telephone is engaged. When the telephone call is ended, radio volume returns to the previously selected level. It is possible to adjust radio volume when the telephone is engaged in order to maintain the new volume level when the call is ended. When active, telephone information is shown in the display.

This function only applies to the Volvo integrated telephone system. See page 183.

Radio (HU-403, 603, 803) (Contd)



Wavelength selector

Turn the **SOURCE** knob to select FM or AM. The station and wavelength are shown in the display.

This knob can also be used to select cassette player, CD or CD changer (if installed).

Scanning

Press the **SOURCE** knob to begin scanning. When the radio finds a station, scanning is interrupted for a few seconds and then resumes. When you wish to select a preferred station, press the **SOURCE** knob.

If the audio system is in cassette mode (HU-403, 603), each track is played for a few seconds.

If the audio system is in CD or cassette mode (HU-403, 603, 803), each track is played for a few seconds. When you have found the specific song or track, press the **SOURCE** knob again.



Fader - Balance front/rear

Set a suitable balance between the front and rear speakers by pressing out the knob and turning it to the right (volume of front pair higher) or the left (volume of rear pair higher). Balance is normalised in the centre position. Press the knob back to its original position after setting.

Balance right/left

Set a suitable balance between the by pressing and pulling out the knob. Turn it to the left or right. Balance is normalised in the centre position. Press the knob back to its original position after setting.

Bass

Set the bass by pressing out the knob and turning it to the left or right. Bass is normalised in the centre position. Press the knob back to its original position after setting.



Treble

Set the treble by pressing and pulling out the knob then turning it to the left or right. Treble is normalised in the centre position. Press the knob back to its original position after setting.

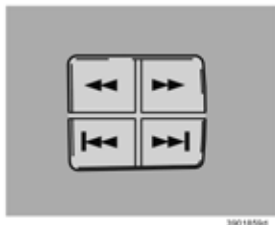

Radio (HU-403, 603, 803) (Contd)



Station setting

Press the button on the left  to select lower frequencies. Press the button on the right  for higher frequencies. Frequency settings are shown in the display.

Station seek up/down

Press the left  or right-hand  side of the button to seek lower or higher frequencies. The radio seeks the next audible station and sets it. Press the button again to continue seek.

Steering wheel keypad

If you have a keypad in the steering wheel, press the right or left arrow to select preset stations.

NOTE! If the car is equipped with an integrated telephone, the steering wheel keypad cannot be used for radio functions while the telephone is in use. Telephone information is continuously displayed while the telephone is in use. Switch off the telephone with . For switching off a telephone without an SIM card, see page 186.



Setting stations

AUTO - Automatic station preset

This function automatically seeks and stores up to 10 strong AM or FM stations in a separate memory. This function is especially useful in areas where you are not familiar with the radio stations.

1. Press and hold the **AUTO** button for at least two seconds. A number of stations with strong signals (max. 10) from the set wavelength are automatically stored in the memory. "AUTO" is shown in the display. If no stations with sufficient signal strength are found, "NO STATION" is displayed.
2. Turn the **1-20/DISC** knob to change to another of the automatically preset stations. A new station is set with each turn (A0-A9).
3. To once again choose from the programmed presets, press the **AUTO** button again. AUTO then disappears from the display.

Manual station selection

1. Set the desired frequency with the arrows.
2. Press the **1-20/DISC** knob. Select where to store the station by turning forward or backward (you can store 20 different stations). Press again to store the desired frequency and station.

Preset

In order to select a pre-programmed radio station, turn the **1-20/DISC** knob to the stored number. The preset number will be shown in the display.

Radio (HU-403, 603, 803) (Contd)



TP

Traffic information

Press the TP button to hear traffic information from RDS stations. "TP" is displayed when the function is connected. When the system is in cassette or CD mode, the radio automatically works in the background to find an FM station with a strong signal that is sending traffic information. If a cassette or CD is playing when the radio receives a traffic bulletin, the function is interrupted and the bulletin is broadcast with the volume selected for traffic information.

As soon as the bulletin is over, the system returns to the previously set volume and resumes playing the cassette or CD.

- Traffic information can only be heard when TP and TP# are displayed at the same time.
- If only TP is displayed, it means that no traffic information is being broadcast from the current transmitter.
- If you do not wish to listen to an ongoing traffic bulletin, press the TP button. The TP function, however, is still connected and the radio waits for the next traffic bulletin.
- Press the TP button to switch off the TP function. TP will no longer be shown in the display.

NEWS

News on/off

Activate the news function with the NEWS button; NEWS will be displayed with lower case letters. Press the NEWS button again to switch off the function.

As soon as the news broadcast starts, the cassette, CD or CD changer is interrupted so the news can be heard.

If you do not wish to listen to the news programme when it is sent, press the NEWS button. The current programme is interrupted. The news function, however, is still connected and the radio waits for the next news broadcast. Press NEWS again to switch off the function. NEWS then disappears from the display.

Radio text

Certain RDS stations broadcast information regarding programme content, artists, etc. This information is shown in text form in the display. Press the NEWS button for a few seconds in order to gain access to Radio Text broadcasts, which will be shown in the display. Press the NEWS button to end the Radio Text display.



Programme type

The PTY function allows you to directly select programmes with different subject types. Seek a certain programme type as follows:

1. Press the **PTY** button. The set station's programme type will be shown in the display.
2. You can scroll through the list of programme types by turning the **1-20/DISC** knob.
3. Once you have found the desired programme type, press the **1-20/DISC** knob to confirm your selection and start the search.

4. If the radio finds a station with the selected programme type, it sets it. If no station with the selected programme type is found, the radio returns to its previous function. PTY is on standby until the selected programme type is sent, at which time the radio automatically changes to the station with the selected programme type.
5. If there is more than one station with the selected programme type, you can select with **[<=>]**, **[>=>]** or the **SCAN** button. The PTY function remains in active mode until the radio finds the desired programme type and as long as the selected station sends it.
6. Press **PTY** again to return to standby mode. Any CD or cassette will resume playing until the selected programme type is sent again.
7. Press **PTY** once again to deactivate PTY standby. The PTY symbol goes out.

Programme type	Displayed
News	News
Current affairs	Current
Information	Info
Sport	Sport
Education	Educ
Theatre	Theatre
Culture and Art	Culture

Programme type	Displayed
Science	Science
Entertainment	Enterta
Pop music	Pop
Rock music	Rock
Easy listening	Easy list
Light classical	L Class
Classical music	Classical
Other music	Other M
Weather	Weather
Economy	Economy
For children	For children
Social issues	Social
Spiritual issues	Spiritual
Telephone watch	Telephone
Travel and holiday	Travel
Leisure and hobby	Leisure
Jazz music	Jazz
Country music	Country
National music	Nation M
Golden oldies	"Oldies"
Folk music	Folk
Documentary	Document
Alarm test	Alarm test
!!ALARM!!	!!Alarm!!
PTY missing	Pty Miss

Radio (HU-403, 603, 803) (Contd)

Advanced User Mode

1. With the radio switched off, press and hold the Volume knob at least 5 seconds to start the Advanced User Mode.
2. Turn the **1-20/DISC** knob to select a function (see the function list on page 175).
3. Once you have selected a function, the function's default will blink. Press the **1-20/DISC** knob to select other alternatives of the function (ON/OFF, LOW/MID/HIGH, mm, depending on the function).
4. Continue selecting functions/alternatives.

In order to *restore* all functions to factory settings, turn the **1-20/DISC** knob until "SET TO DEFAULT" is shown in the radio display and press the same button again. All functions resume their default setting and the radio returns to normal mode (music, news, etc.)

In order to *save* changes and resume normal mode, turn the **1-20/DISC** knob until "BACK and SAVE" is shown in the radio display and press the same button. Confirm by pressing the **1-20 DISC** knob again.

In order to return to normal mode *without saving* changes, turn the **1-20/DISC** knob until "BACK without SAVE" is shown in the display and press the same button again. Confirm by pressing the **1-20 DISC** knob again.

Functions in Advanced User Menu

(default is underlined)

- SET TO DEFAULT (Se page 174).
- AF SWITCHING ON/OFF (Automatic frequency update) – The AF function makes sure that the strongest available transmitter for a chosen programme is used.
- REGIONAL ON/OFF (Regional radio programme with automatic frequency update activated) – This function makes it possible to stay tuned to a regional transmitter even if the signals are weak.
- EON (Enhanced Other Networks) LOCAL/DISTANT – This function is used to indicate if the radio programme you are listening to is to be interrupted for traffic bulletins or news broadcasts (if these functions are selected) only if the signal is strong (LOCAL) or if the radio should also try to pick up weaker signals (DISTANT).
- NETWORK ALL/TUNED – This function is used to indicate if the radio programme you are listening to is to be interrupted for traffic bulletins or news broadcasts (if these functions are selected) only if the message comes from the channel you are listening to, such as P1 (TUNED), or if the programme is to be interrupted regardless of which radio channel the bulletin/broadcast comes from (ALL).
- LANGUAGE – Select which language is to be used in the radio display (English, German, French or Swedish). Only works in PTY mode.
- ASC (Active Sound Control) ON/OFF (Active volume control) – The ASC function automatically adjusts the radio volume according to the speed of the car.
- ASC TABLE – Choose a level for the ASC function (LOW/MID/HIGH).
- SRC ON/OFF – This is used to activate/deactivate the function that reduces the treble when reception is poor. This might seem like improved reception.
- SRC TABLE - Choose a level for the SRC function (LOW/MID/HIGH).
- TAPE DOLBY ON/OFF – Activate/deactivate Dolby Noise Reduction when you listen to a cassette (HU 403/603).
- BACK and SAVE (See left column).
- BACK without SAVE (See left column).

Cassette player (HU-403, 603)

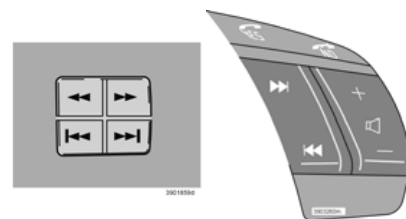
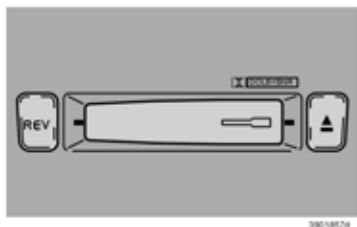

Cassette opening

Slide the cassette into the cassette opening with the tape to the right. TAPE Side A is shown in the display. When one side has finished playing, the system will automatically begin playing the other side (auto reverse). If a cassette is already in the cassette player, you can play the cassette by pressing the SOURCE knob.

Changing tape direction

Press the REV button in order to play the other side of the cassette; the side being played will be shown in the display.



Cassette eject

If you press the button, the tape stops and the cassette is ejected. Turn the SOURCE knob to select a new programme source. The cassette can be inserted or ejected even if the system is switched off.



Dolby B Noise Reduction

This is a preset function which can be switched off as follows: press and hold the REV button until the Dolby symbol  disappears from the display. Press the same button again in order to reactivate the Dolby function.

Fast forward/rewind

Fast forward the cassette with  and rewind with . The display will show "FF" (fast forward) and "REW" (rewind) when the functions are in use. Fast forward/rewind functions are stopped once the button is pressed again.

Next track, Previous track

If you press in the  button, the cassette is automatically wound forward to the next track. If you press in the  button, the cassette is automatically rewound to the previous track. There must be a five second break between each track for this function to work. If you have a keypad in the steering wheel, you can use the arrows.

CD player (HU-603)



3901862d

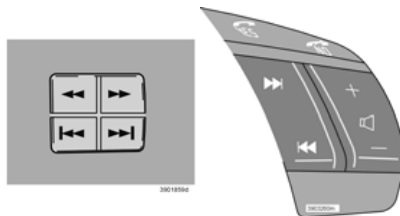

3901862e



3901861c

CD player

Insert a CD. If this was already done, select CD by turning the SOURCE knob.

CD eject

If you press the button shown in the illustration, the CD player stops playing and the disc is ejected.

NOTE! For reasons of traffic safety, you have twelve seconds to handle the ejected disc. The CD player then pulls it back in and continues play.

Fast forward/rewind

Press or to seek within a track.

Changing tracks

Press in order to skip ahead to the next track or to return to the previous track; the track number will be shown in the display. The arrows in the steering wheel keypad can also be used if available.

Random

Press RND (random) to connect the random function. The system plays tracks from the disc in random order. "RND" is displayed as long as this function is activated.

NOTE! If CD quality does not comply with EN60908 standards or if the CD has been recorded using substandard equipment, sound quality may be poor or missing altogether.

Important!

Do not use compact discs with labels; the heat from the CD player can cause the label to loosen which may cause damage to the CD player.

CD player with internal CD changer (HU-803)



3001854c



300185b



3001861c

CD player



HU-803 includes an internal 4-disc CD changer.

Turn the **SOURCE** knob to activate the CD player. The CD player resumes playing the disc and track last played. You can insert 4 discs in the CD player. To insert a new disc, you must have an available position in the player. Turn the **1-20/DISC** knob to find an available position. Make sure that "LOAD DISC" is displayed before inserting a new disc.



Selecting disc number

Turn the **1-20/DISC** knob; disc and track numbers will be shown in the display.

Fast forward/rewind

Press  or  to seek within a track.

Changing tracks

Press  in order to skip ahead to the next track or  to return to the previous track. The disc and track numbers will be shown in the display. The arrows in the steering wheel keypad can also be used if available.

Random

Press **RND** (random) to connect the random function. A randomly selected disc plays a randomly selected track. A new disc and track are then chosen the same way. "RND" is displayed as long as this function is activated.

NOTE! Use only 12 cm CDs! Do not use CDs of a smaller dimension!

External CD changer (HU-403, 603, 803) (accessory)

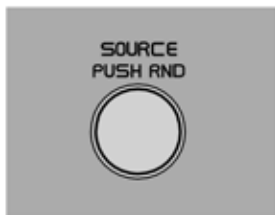

3901875d

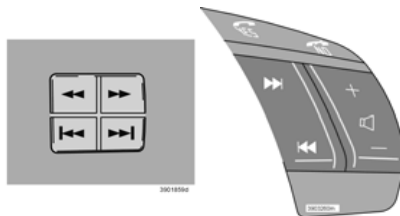

3901880a



3901861c

CD changer functions can only be used if the audio system is connected to Volvo's CD changer, which is available as an accessory.

CD changer

Activate the CD changer mode by turning the SOURCE knob; the CD changer resumes playing the previous disc and track. If the CD player cartridge is empty, "LOAD CARTRIDGE" will be shown in the display.

Selecting disc number

Turn the 1-20 DISC knob; disc and track numbers will be shown in the display.

Fast forward/rewind

Press or to seek within a track.

Changing tracks

Press in order to skip ahead to the next track or to return to the previous track. The disc and track numbers will be shown in the display. The arrows in the steering wheel keypad can also be used if available.

Random

Press RND (HU-603 and 803) to activate the random function. If you have an HU-403 radio, press the SOURCE knob. A track selected at random will be played from a randomly selected disc. A new disc and track are then chosen the same way. "RND" is displayed as long as this function is activated.

Dolby Surround Pro Logic

Dolby Surround Pro Logic together with a centre loudspeaker in the dashboard offers you a sound experience very close to reality.

The normal left - right stereo channels are divided to left - centre - right. In addition, ambient surround sound is produced by the rear loudspeakers. This ambient surround sound mirrors the resonance in the recording studio.

Most recordings today are made so that the vocalist/soloist is heard from straight ahead while the orchestra is heard over the entire left-right panorama and from behind. The result with Dolby Surround Pro Logic is a sound experience very close to being there.

Note that the sound experience for rear seat passengers when using Dolby Surround Pro Logic is different than that of the driver and front seat passenger.

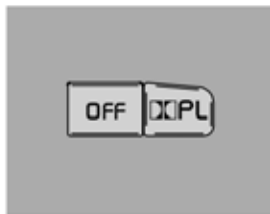

Surround Sound Mode*

Select Dolby Surround Pro Logic Mode by pressing "DOL PL"; "Dolby Pro Logic" will be shown in the display. Resume 2-channel stereo function by pressing **OFF**.

* Dolby Surround Pro Logic Mode is available for CD, cassette or FM mode only. If you are listening to a radio transmission, select 3-channel stereo (3-CH) instead.



3-channel stereo

Select 3-channel stereo by pressing **3-CH**; "3 ch" will be shown in the display. Resume 2-channel stereo function by pressing **OFF**.



Centre loudspeaker volume

Set the centre loudspeaker volume by pressing out the knob and turning it right or left. Volume is normalised in the centre position. Press the knob back to its original position after setting.

Rear loudspeaker output level (surround sound)

Set the output level of the rear loudspeakers by pressing out the knob, pulling it out further and turning it right or left. Output level is normalised in the centre position. Press the knob back to its original position after setting. This control regulates the surround speaker's level when listening in Dolby Surround Pro Logic Mode.

Specifications

HU-403

Output	4 x 25 W
Impedance	4 Ohm
Voltage required	12 V, negative ground

Radio

Frequency	
U (FM)	87.5 - 108 MHz
M (AM)	522 - 1611 kHz
L (AM)	53 - 279 kHz

HU-603

Output	4 x 25 W
Impedance	4 Ohm
Voltage required	12 V, negative ground
External amplifier (option)	4 x 50 W or 4 x 75 W

Radio

Frequency	
U (FM)	87.5 - 108 MHz
M (AM)	522 - 1611 kHz
L (AM)	153 - 279 kHz

HU-803

Output	1 x 25 W (centre loudspeaker)
Impedance	4 Ohm
Voltage required	12 V, negative ground
External amplifier	4 x 50 W or 4 x 75 W

HU-803 must be connected to an external amplifier.

Radio

Frequency	
U (FM)	87.5 - 108 MHz
M (AM)	522 - 1611 kHz
L (AM)	153 - 279 kHz

Alarm

"Alarm!" is shown in the radio display when an alarm message is broadcast. This function warns motorists for serious collisions or other hazardous situations such as a collapsed bridge or nuclear mishap.

Dolby Noise Reduction is manufactured under license of Dolby Laboratories Licensing Corporation. Dolby and the double D symbol  are trademarks of Dolby Laboratories Licensing Corporation.

Dolby Surround Pro Logic is a registered trademark of Dolby Laboratories Licensing Corporation. Dolby Pro Logic Surround System is licensed from Dolby Laboratories Licensing Corporation.

Telephone (option)

Telephone system	184
Operating	186
Call options	187
Memory functions	190
Menu functions	191
Miscellaneous information	195

Telephone system

General rules

- Put traffic safety first! If when driving you require to use the privacy handset in the armrest, park the car in a safe place first.
- Switch off the system when refuelling the car.
- Switch off the system near blasting work.
- Let only authorised personnel service your telephone system.

Emergency calls

Emergency calls to emergency services can be made without the ignition key or the SIM card.

- Press the ON/OFF button.
- Ring the emergency number that applies to your region (within EU: 112).
- Press the green button .

1. Keypad on centre console

You can control all telephone functions using the keypad on the centre console.

2. Steering wheel keypad

You can control the majority of telephone functions using the steering wheel keypad. The steering wheel keypad can only be used for telephone functions when the telephone is activated. Telephone information is continuously displayed when the telephone is engaged. The telephone must be deactivated before the keypad can be used for radio settings, page 186.

3. Display

The display will show menu functions, messages, telephone numbers, etc.

4. Privacy handset

The privacy handset can be used for private conversations when you do not wish to be disturbed.

5. SIM card

Insert the SIM card into the front of the keypad on the centre console. Switch off and deactivate the telephone whenever an SIM card is not in use. Otherwise, messages from other functions cannot be displayed.

6. Microphone

The microphone is integrated in the rearview mirror.

7. Loudspeaker

The loudspeaker is built into the driver's seat head restraint.

8. Antenna

The antenna is mounted against the windscreen in front of the rearview mirror.

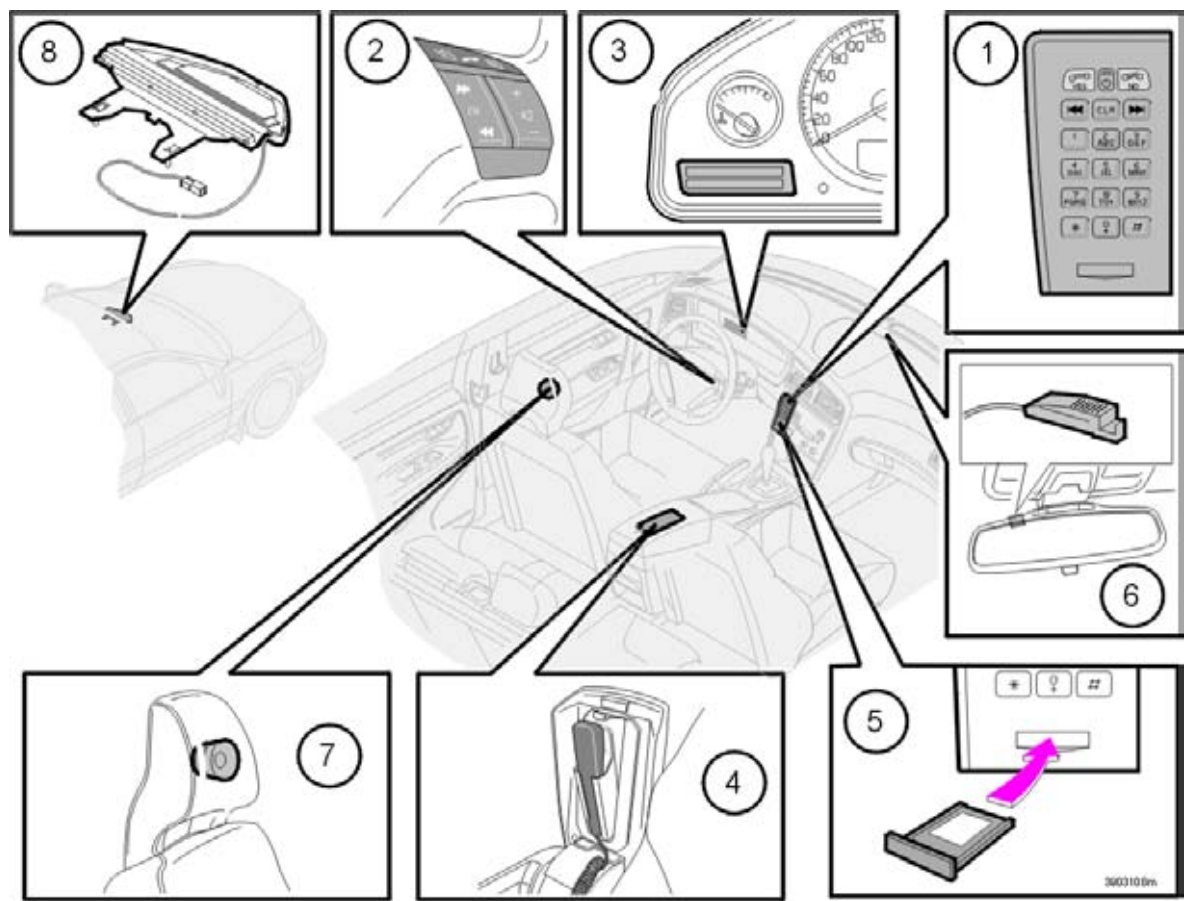

Operating

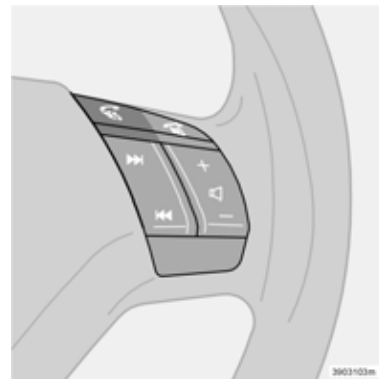
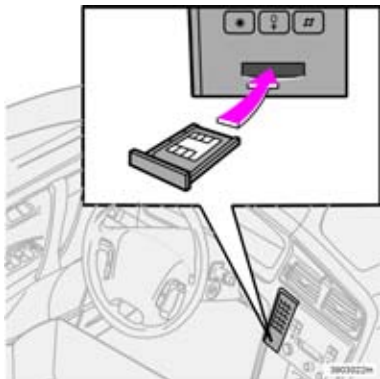

SIM card

The telephone can only be used together with a valid SIM card (Subscriber Identity Module). Your network operator will provide you with a SIM card.

Always use the SIM card during telephone use; the name of your network operator will be displayed.

Switch off and deactivate the telephone whenever an SIM card is not in use. Otherwise, messages from other functions cannot be displayed and the steering wheel keypad radio controls cannot be used.

Switching the system on and off

To switch the system on: Turn the ignition key to position I. Press the button marked in the illustration.

To switch the system off, press the same button for about three seconds. If you switch off the ignition with the telephone on, the telephone will be on the next time you switch on the ignition.

Telephone calls cannot be received if the telephone system is switched off.

Active mode

The telephone must be in active mode to use the functions of the telephone system (does not apply to receiving calls).

Activate the telephone by pressing the  button on the keypad on the centre console or the steering wheel keypad.

Telephone information is shown continuously in the display when the telephone is activated.

Press  to deactivate the telephone.

Call options

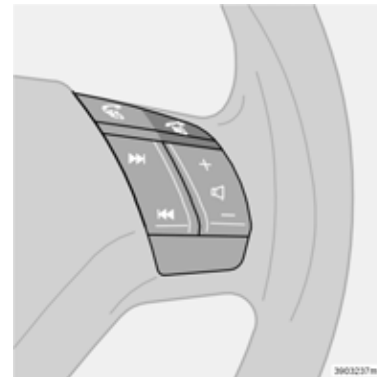
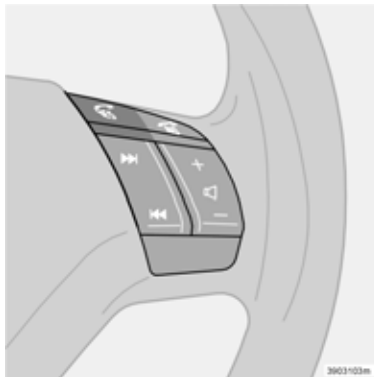
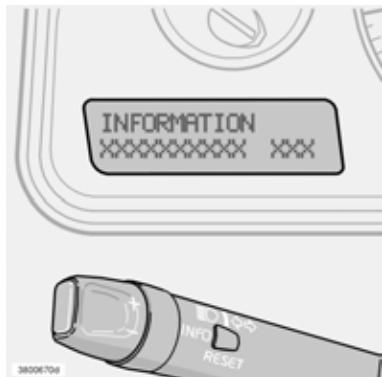

Display

The display will show the function in use, for example menu selections, messages, telephone numbers or settings.

Making and receiving calls

To **call**: dial the number and press  on the steering wheel or centre console keypad (or lift the handset).

To **receive** an incoming call: press  (or lift the privacy handset). You can also select Automatic Answer, refer to menu function 4.3.

The car audio system will be muted automatically while a telephone conversation is in progress. Refer to menu function 5.6.5 for information about audio system volume levels.

Ending a call

To end a call, press  on one of the keypads or hang up the handset. The audio system resumes its previous mode.

Call options (Contd)

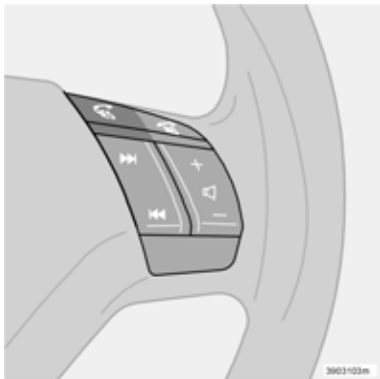

Last number called

The telephone automatically stores the last telephone numbers/names called.

1. Press on one of the keypads.
2. Use the arrows to scroll forward or backward through the last numbers called.

Press (or lift the privacy handset) to make the call.

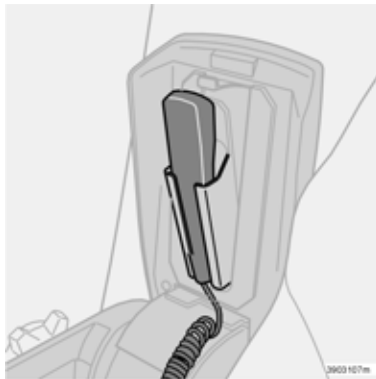

Privacy handset

If you wish to talk undisturbed, use the privacy handset.

1. Lift the handset. Dial the number on the centre console keypad. Press to call. Adjust the volume with the dial on the side of the handset.
2. The call is ended when you replace the handset in its holder.

If you wish to switch to handsfree without ending the call: press and select Handsfree. Press and put the handset down, page 189.

Speed dial

Storing speed dial numbers

A number stored in the telephone book can be linked to a speed dial button (1-9) as follows:

1. Scroll with to Edit memory (menu 3) and press YES .
2. Scroll to Speed dial (Menu 3.4) and press YES .
3. Choose the digit that is to be the speed dial number. Press YES to confirm.
4. Find the desired name or telephone number in the memory and press YES to select it.

Using speed dial

Press the desired speed dial button for about two seconds to make a call.

NOTE! Once you switch on the telephone, wait a moment before using speed dial.

If you wish to use a speed dial number, Menu 4.5 must be activated. See page 194.

Functions during a call

The following functions are available **during a call** (scroll with the arrows and press YES to make a selection):

Secret mode/ Secret mode off	Secret mode
Hold/No hold	Choose if the call is to be parked, i.e. put on hold.
Handset/ Handsfree	Use the handset or handsfree
Memory	Show stored numbers

The following functions are available when you have a **current call** and a **parked call** (scroll with the arrows and press YES to make a selection):

Secret mode/ Secret mode off	Secret mode
Handset/ Handsfree	Use the handset or handsfree
Memory	Show stored numbers
Three-way calling	Speak with both parties simultaneously (conference call)
Switch	Switch between the two calls

The following functions are available during **three-way calling** (scroll with the arrows and press YES to make a selection):

Secret mode/ Secret mode off	Secret mode
Handset/ Handsfree	Use the handset or handsfree
Memory	Show stored numbers



Call waiting

If you hear a tone in the speaker when the telephone is engaged followed by a two-tone signal, another party is placing a call to your phone.

The two-tone signal will repeat until you answer the call or ringing ceases.

When this occurs, you may accept or decline the call.

If you **do not** wish to take the call, press  or do nothing.

If you **do** wish to take the call, press . Your current call will be put in "park mode". If you press , both calls will be terminated.

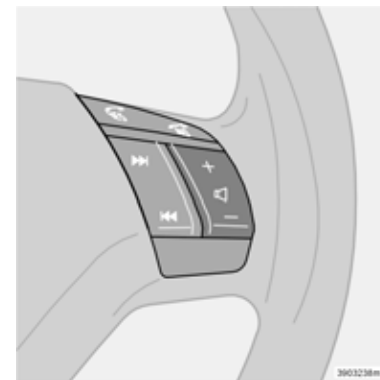

SMS

A single two-tone signal indicates that you have received an SMS message.

Volume

Raise the volume with the (+) button in the steering wheel keypad. Lower the volume with the (-) button.

When the telephone is activated, the steering wheel keypad only controls the telephone functions.

If you wish to adjust the audio system settings using these buttons you must first deactivate the telephone, page 186.

Memory functions

Telephone numbers and names can be stored in either the telephone memory or the SIM card memory.

When you accept a telephone call from a party whose number is stored in the memory, their name will be shown in the display.

The telephone memory can store up to 255 names.

Storing telephone numbers with names

1. Press and toggle to Edit memory (Menu 3). Press .
2. Scroll to Enter item in memory (Menu 3.1) and press .
3. Enter a number and press .
4. Enter a name and press .
5. Choose in which memory to save with and press .

Enter a name (or message)

Press the button with the desired character: once for the first character, twice for the second, etc. Press 1 to enter a space.

	space 1- ? ! , . : ' ()
	a b c 2 ä å à á â æ ç
	d e f 3 è é ê ë
	g h i 4 ì í î ï
	j k l 5
	m n o 6 ñ ò ó ô õ
	p q r s 7 ß
	t u v 8 ü ù ú û
	w x y z 9
	if you enter two letters in a row from the same button, press * between them or wait a few seconds
	+ 0 @ * # & \$ £ / %
	change between capital and lower case letters
	delete the last letter or number entered. If you press for a long time, the enter number or text is deleted.

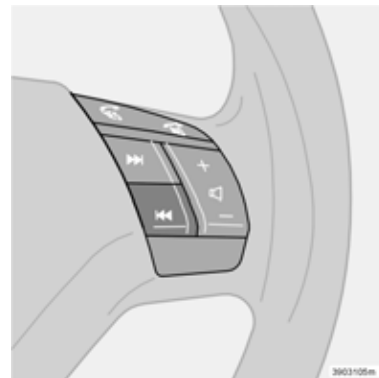

Calling from the memory

1. Press .
2. Choose from the following alternatives:
 - Press and scroll with the arrows until you find the desired name.
 - Press the key of the first letter in the name (or enter the name) and press .
3. Press to call the selected number.





Menu functions

Use the menu function when checking functions, changing settings and programming new functions in your system. The various menu selections will be shown in the display.

Menu function



Press  to access the menu function.

The following applies in the menu function:

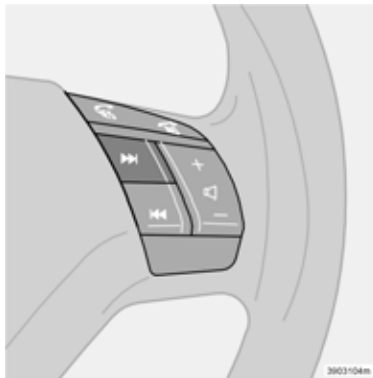
- A long press on  means you exit the menu function.
- A short press on  means that you retract, cancel or reject an alternative.
- A press on  means that you confirm or select, or that you scroll from a submenu to the next submenu.
- The right arrow  leads to the next side menu. The left arrow  leads to the previous side menu.



Shortcuts

When you use the right arrow  to enter the menu system, you can use numbers instead of the arrows and the green button  to select the right menu on the main menu level (1, 2, 3, etc.), first submenu level (1.1, 2.1, 3.1, etc.) and the second submenu level (1.1.1, 2.1.1, etc.). The numbers are shown in the display together with the menu alternative.

Traffic safety

For reasons of safety, the menu system cannot be accessed at speeds in excess of 8 km/h. You may only complete activities in the menu system that have already been started.

The speed limiter can be disconnected using menu function 5.7.

Menu functions (Contd)

Main menus/submenus

1. Call register

- 1.1. Missed calls
- 1.2. Received calls
- 1.3. Dialed calls
- 1.4. Erase list
 - 1.4.1. All
 - 1.4.2. Missed
 - 1.4.3. Received
 - 1.4.4. Dialed
- 1.5. Call duration
 - 1.5.1. Last call
 - 1.5.2. Number of calls
 - 1.5.3. Total time
 - 1.5.4. Clear

2. Messages

- 2.1. Read
- 2.2. Write
- 2.3. Voice message
- 2.4. Settings
 - 2.4.1. SMSC number
 - 2.4.2. Validity
 - 2.4.3. Type

3. Edit memory

- 3.1. Enter item
- 3.2. Search
 - 3.2.1. Edit
 - 3.2.2. Erase
 - 3.2.3. Copy
 - 3.2.4. Move
- 3.3. Copy all
 - 3.3.1. SIM to phone
 - 3.3.2. Phone to SIM
- 3.4. Speed dial
- 3.5. Empty SIM
- 3.6. Empty memory
- 3.7. Status

4. Call options

- 4.1. Transmit number
- 4.2. Call waiting
- 4.3. Automatic answer
- 4.4. Automatic redial
- 4.5. Speed dial
- 4.6. Call divert service
 - 4.6.1. All calls
 - 4.6.2. When busy
 - 4.6.3. When not answered
 - 4.6.4. If unreachable
 - 4.6.5. Fax calls
 - 4.6.6. Computer calls
 - 4.6.7. Cancel all divers

5. Settings

- 5.1. Factory settings
- 5.2. Network selection
- 5.3. Language
 - 5.3.1. English UK
 - 5.3.2. English US
 - 5.3.3. Svenska
 - 5.3.4. Dansk
 - 5.3.5. Suomi
 - 5.3.6. Deutsch
 - 5.3.7. Nederlands
 - 5.3.8. Français FR
 - 5.3.9. Français CAN
 - 5.3.10. Italiano
 - 5.3.11. Español
 - 5.3.12. Português P
 - 5.3.13. Português BR
- 5.4. SIM security
 - 5.4.1. On
 - 5.4.2. Off
 - 5.4.3. AUTO
- 5.5. Change codes
 - 5.5.1. PIN code
 - 5.5.2. Telephone code
- 5.6. Volume
 - 5.6.1. Ringer volume
 - 5.6.2. Ringer tone
 - 5.6.3. Button click
 - 5.6.4. Speed volume
 - 5.6.5. Radio Auto Suppression
 - 5.6.6. New SMS
- 5.7. Traffic safety

Menu 1. Call register

1.1. Missed calls

A list of missed calls is shown here. You can choose to call, erase or store the number in the telephone or SIM card memory for later use.

1.2. Received calls

A list of received calls is shown here. You can choose to call, erase or store the number in the telephone or SIM card memory for later use.

1.3. Dialed calls

A list of dialed numbers is shown here. You can choose to call, erase or store the number in the telephone or SIM card memory for later use.

1.4. Erase list

This option can be used to erase the list of menus 1.1, 1.2 and 1.3 as follows.

- 1.4.1. All
- 1.4.2. Missed
- 1.4.3. Received
- 1.4.4. Dialed

1.5. Call duration

Here you can see the duration of all your calls or the most recent. You can also see the number of calls and clear the call timer.

- 1.5.1. Last call
- 1.5.2. Number of calls
- 1.5.3. Total time
- 1.5.4. Clear

Resetting the call timer requires the telephone code (see Menu 5.5).

Menu 2. Messages

2.1. Read

Here you can read received text messages. You can then choose to erase the message, forward it, change or save the entire message or parts of it.

2.2. Write

You can write a text message using the keypad. Then choose to save or send it.

2.3. Voice message

Listen to received messages.

2.4. Settings

Enter the number (SMSC number) of the message centre to which you want your messages transferred. Specify how the message is to reach the addressee and how long it is to be stored in the message centre.

- 2.4.1. SMSC number
- 2.4.2. Validity
- 2.4.3. Type

Contact your service provider for information on these settings and for an SMSC number.

Menu 3. Edit memory

3.1. Enter item

You can store names and telephone numbers in the telephone or SIM card memory. See the section on memory functions for more information.

3.2. Search

Changes in the memory can be made here.

- 3.2.1. Edit: Change data in the different memories.
- 3.2.2. Erase: Remove a saved name.
- 3.2.3. Copy: Copy a saved name.
- 3.2.4. Move: Transfer information between the memory of the telephone and the SIM card.

3.3. Copy all: Copy SIM card telephone numbers and names and store in the telephone memory.

- 3.3.1. From SIM to telephone memory
- 3.3.2. From telephone to SIM memory

3.4. Speed dial

A number stored in the telephone book can be stored as a speed dial number.

3.5. Empty SIM

The entire memory of the SIM card can be erased.

3.6. Empty memory

The entire memory of the phone can be erased.

3.7. Status

See how many places in the SIM card or telephone memory are occupied by names and numbers.

Menu functions (Contd)

Menu 4. Call options

4.1. Transmit number

Choose whether or not your own number should be displayed to the person you call. Contact your network operator regarding ex-directory numbers.

4.2. Call waiting

Choose whether or not you want to be alerted during a phone call that there is another call coming in.

4.3. Automatic answer

Chose to answer without using the keypad.

4.4. Automatic redial

Choose to call a previously dialled number that was busy.

4.5. Speed dial

Here you set whether or not speed dial is to be active. The function must be activated if you wish to dial using speed dial numbers.

4.6. Call divert service

Here you can choose when and what type of calls are to be diverted to a specified telephone number.

- 4.6.1. All calls (this setting only applies during the call in progress).
- 4.6.2. When busy
- 4.6.3. When not answered
- 4.6.4. If unreachable
- 4.6.5. Fax calls
- 4.6.6. Computer calls
- 4.6.7. Cancel all diverts

Menu 5. Settings

5.1. Factory settings

Function to return to the system's factory settings.

5.2. Network selection

Choose a network automatically or manually.

- 5.2.1. AUTO
- 5.2.2. Manual

5.3. Language

Here you can choose which language the telephone is to display.

- 5.3.1. English UK
- 5.3.2. English US
- 5.3.3. Svenska
- 5.3.4. Dansk
- 5.3.5. Suomi
- 5.3.6. Deutsch
- 5.3.7. Nederlands
- 5.3.8. Français FR
- 5.3.9. Français CAN
- 5.3.10. Italiano
- 5.3.11. Español
- 5.3.12. Português P
- 5.3.13. Português BR

5.4. SIM security

Choose if the PIN code is to be on, off, or automatic.

- 5.4.1. On
- 5.4.2. Off
- 5.4.3. AUTO

5.5. Change codes

Change the PIN code or telephone code.

- 5.5.1. PIN code
- 5.5.2. Telephone code (use 1234 until you change to your own code). The telephone code is used to reset the call timer.

NOTE! Make a note of your code as save it in a safe place.

5.6. Volume

- 5.6.1. Ringer volume: Here you can choose the volume of the ringer for incoming calls.
- 5.6.2. Ringer tone: There are eight different ringer tones to choose from.
- 5.6.3. Button click: On or Off.
- 5.6.4. Speed volume: Choose whether the volume should be adjusted according to speed.
- 5.6.5. Radio Auto Suppression: Here you choose whether the volume of the radio should remain the same during telephone calls.
- 5.6.6. New SMS: Select whether or not you wish the telephone to notify of new SMS messages with an audible signal.

5.7. Traffic safety

Here you can choose to disengage the speed limiter for the menu system, i.e. choose to use the menu system even while driving.

Miscellaneous information

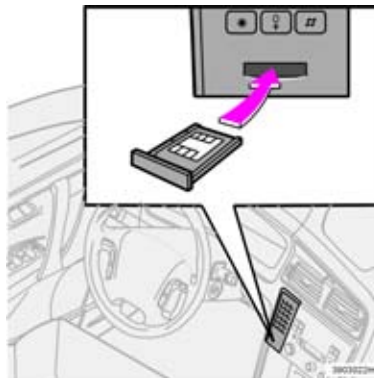
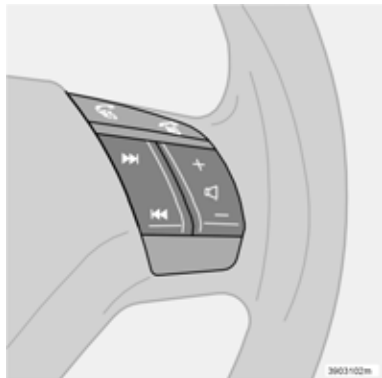

Radio/Telephone

The four lower buttons on the steering wheel keypad are common to the audio system and telephone.

To control telephone functions using these buttons requires the system to be activated, page 186. If you wish to change audio system settings with these buttons, the telephone must be deactivated. Press .

Double SIM card

Many network operators offer double SIM cards, one for your car and one for another telephone. A double SIM card allows you to have the same number for two different telephones. Ask your network operator about the offers available and the use of double SIM cards.

Specifications

Output	2 W
SIM card	little
Memory positions	255 ^a
SMS (Short Message Service)	Yes
Computer/Fax	No
Dualband	Yes (900/1800)

- a. The telephone memory contains 255 positions. The number of SIM card memory positions varies depending on your subscription.

IMEI number

To block the telephone, you must provide your network operator with the telephone's IMEI number. This is a 15-digit serial number that is programmed in the phone. To display this number, press *#06#. Make a note of this number and keep it in a safe place.

Alphabetical index

A	
ABS	30, 103
AC	56, 59
Active mode	186
Advanced user functions	173
Advanced User Mode	174
Air	132
Air distribution	56, 60
Air filter	132
Air quality sensor	56, 57
Air vents	53
Airbags	12
Alarm	87
All	101
All-Wheel Drive	101
Approach lighting	37
Ashtray	71
Audio	163
AUTO	55
Automatic gearbox	94, 97
Automatic re-locking	82
Auxiliary lamps	34
Average fuel consumption	40
AWD	101
B	
Backrest	65, 75
Balance	169
Bass	169
Battery	131, 139, 160
Bonnet	132
Boost starting	109
Booster cushion	24
Bottle holder	74
Brake circuit	102
Brake fluid	137
Brake lights	145
Braking system	30, 102
Bulbs	141, 160
C	
Call options	187
Capacities	155
Carbon dioxide emissions	158
Cargo compartment	75
Cargo compartment lighting	146
Cassette player	176
Catalytic converter	157
CD changer	179
CD player	177, 178
Centre console	71
Changing wheels	120
Child safety	22
Child safety locks	35, 85
Child seat	22, 24
Cigarette lighter	35, 42
Cleaning	124
Clock	28
Coin compartment	71
Cold starts	94

Colour code	126
Comfort position	48
Coolant	136
Cooling system	156
Courtesy lighting	146
Cruise control	41
Cup holder	71, 72
Current fuel consumption	40

D

D - drive	97, 99
Deactivating the deadlock function	35
Deadlocks	84
Defroster	55
Diesel	133, 158
Dimension designation	118
Dipped beam	37
Dipped beam bulb	142
Direction indicator	143, 145
Direction indicators	28, 37
Display	28
Dolby Surround Pro Logic	180
Door mirror defroster	39
Door mirrors	34
Downshift inhibitor	97
DSTC	32, 35

E

EBD	103
EBS	104
ECC	54
Economical driving	94

Electric child safety locks	86
Electric socket	35, 42
Electrical system	160
Emergency calls	184
Emissions system	31
Engine compartment	132
Engine preheater	31
Engine specifications	161

F

Fader	169
Fan	55, 59
Filling up with diesel	92
Floor mats	69
Fog lamp	145
Fog lamps	31, 144
Front seats	64
Fuel.....	158
Fuel cap	92
Fuel consumption	158
Fuel gauge	28
Fuel tank	155
Fuses	148

G

Gear positions	96
Geartronic	99
General lighting	68
Glovebox	84
Grocery bag holder	76

H

Hazard warning flashers	39
Head restraints	75
Headlamp	141
Headlamp levelling	36
Headlamp washers	38
Headlamp wiper blades	138
Headlamps	36
Heated front seats	56, 59

I

IC	17
Ignition switch and steering wheel lock	93
IMEI number	195
Immobilizer	80, 93
Indicator and warning symbols	28, 29
Indicator lamp	88
Inflatable Curtain	17
Instrument lighting	36
Integrated booster cushion	24
Interior lighting	68
Intermittent wiping	38
Isofix	24

J

Jack	77, 122
Jump starting	109

K

Keylock	95
Keys	80

L

L - low gear	97
Lambda-sond TM	157
Lighting panel	36
Locking	82
Low gear	97
Lubricants	156

M

Main beam	28, 37
Main beam "flash"	37
Main beam bulb	142
Manual climate control with air conditioning	58
Manual gearbox	96
Measurements and weights	155
Menu functions	191
Multifilter with air quality sensor	57

N

N - neutral	97, 99
NEWS	172
Normal turns	37
Numberplate lighting	146

O

Odometer	28
Oil	134
Oil filter	134
Oil pressure	31
Outer rear seat head restraint	34

Outside temperature gauge28

P

P - park97, 99
 Paint126
 Paintwork damage126
 Parking brake31, 42
 Parking heater61, 62
 Parking lamps36
 Particle filter52
 Petrol158
 Polishing124
 Position143
 Position lamps36
 Power seat66
 Power steering101
 Power windows44
 Privacy handset188
 Programme type PT173

R

R - reverse97, 99
 Radiator132
 Radiator fan132
 Radio167
 Rain sensor38
 Range to empty fuel tank40
 Reading lamp148
 Reading lamps68
 Rear fog lamps36
 Rear seat75
 Rear window defroster39, 59

Rearview mirror/door mirrors46
 Recirculation56, 60
 Recovery108
 Refuelling92
 Remote controls80
 Resistance point position37
 Reverse gear inhibitor96
 Reversing lamp145
 Roof lighting147
 Rustproofing127

S

Seat belt10
 Seat belt reminder31, 46
 Seat belt tensioner11
 Service130
 Shiftlock95
 Side airbags15
 Side marker light145
 SIM card184, 186, 195
 SIM cards195
 SIPS bag15
 Snow chains101, 119
 Spare wheel77, 121
 Specifications153
 Speedometer28
 Spoiler lamps36
 SRS12
 Stability system104
 Starting the car93
 STC32, 34, 104
 Steering wheel adjustment42

Stone chips126
 Storage compartments71
 Storage compartments in the passenger compartment70
 Studded tyres118
 Sun screen48
 Sunroof48
 Suspension159
 Switches in the centre console34

T

Tachometer28
 Telephone183
 Temperature55
 Temperature gauge28
 Temporary Spare121
 Tools77
 Towbar112
 Towing108
 Towing bracket112
 Towing eye108
 Traffic information TP172
 Trailer110
 Trailer indicator lamp31
 Tread wear indicators120
 Treble169
 Trip computer40
 Trip odometer28
 Type designations154
 Tyre pressure119
 Tyres118

U

Unlocking	82
Upholstery	125

V

Ventilation position	48
Viscosity	134

W

W - winter	98, 100
Warning symbol	29
Warning triangle	78
Washer fluid reservoir	132, 136
Washing the car	124
Waste bin	74
Waxing	125
Wheels	118
Windscreen washer	38
Windscreen wiper blades	138
Windscreen wipers	38
Winter tyres	118
Wiper blades	138

Check regularly

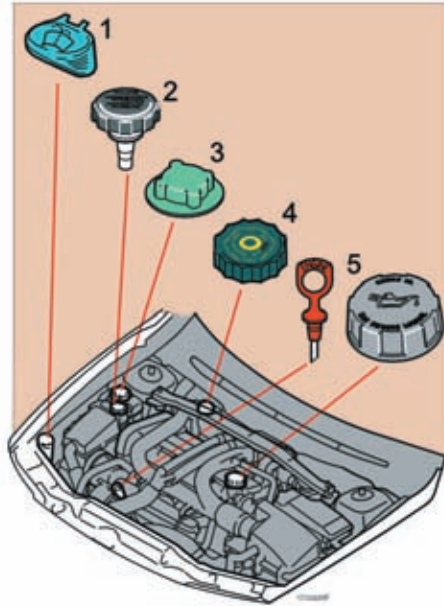

1. Washer fluid: Make sure that the reservoir is always well filled. Add frost protection in the winter! See page 136.

2. Power steering: The fluid level should lie between the MIN and MAX marks. See page 137.

3. Coolant: The fluid level should lie between the MIN and MAX marks on the expansion tank. See page 136.

4. Brake fluid: The level should lie between the MIN and MAX marks. See page 137.

5. Oil: The oil level should lie between the marks on the dipstick. See page 135.

Bulbs

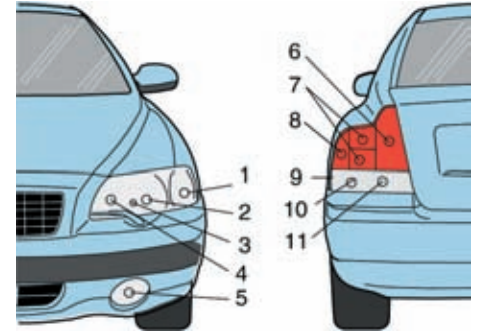

1. Direction indicator	PY21W (yellow)
2. Dipped beam	55W H7
3. Position/parking lamp	W5W
4. Main beam	55W HB3
5. Fog lamps	55W H1 R version 55W H3
6. Rear fog lamp	21W BA5
7. Position/parking lamp and tail lamp	5W BA15
8. Brake light	21W BA15
9. Side marker light	P10W
10. Direction indicator	PY21W (yellow)
11. Reversing lamp	21W BA15

VOLVO

Volvo Car Corporation
S-40531 Gothenburg, Sweden