

California Proposition 65 Warning

WARNING: This product contains or emits chemicals known to the state of California to cause cancer and birth defects or other reproductive harm.

Event Data Recorders

This vehicle is equipped with an event data recorder (EDR).

The main purpose of an EDR is to record, in certain crash or near crash-like situations, such as an air bag deployment or hitting a road obstacle, data that will assist in understanding how a vehicle's systems performed. **The EDR is designed to record data related to vehicle dynamics and safety systems for a short period of time, typically 30 seconds or less. The EDR in this vehicle is designed to record such data as:**

- **How various systems in your vehicle were operating;**
- **Whether or not the driver and passenger safety belts were buckled/fastened;**
- **How far (if at all) the driver was depressing the accelerator and/or brake pedal; and,**
- **How fast the vehicle was traveling.**

These data can help provide a better understanding of the circumstances in which crashes and injuries occur. NOTE: EDR data are recorded by your vehicle only if a non-trivial crash situation occurs; no data are recorded by the EDR under normal driving conditions and no personal data (e.g., name, gender, age, and crash location) are recorded. However, other parties, such as law enforcement, could combine the EDR data with the type of personally identifying data routinely acquired during a crash investigation.

To read data recorded by an EDR, special equipment is required, and access to the vehicle or the EDR is needed. In addition to the vehicle manufacturer, other parties, such as law enforcement, that have the special equipment, can read the information if they have access to the vehicle or the EDR.

The data belongs to the vehicle owner and may not be accessed by anyone else except as legally required or with the permission of the vehicle owner.

Service Diagnostic Recorders

This vehicle is equipped with service-related devices that record information about powertrain performance. The data can be used to verify emissions law requirements and/or help technicians diagnose and solve service problems. It may also be combined with data from other sources for research purposes, but it remains confidential.

California Perchlorate Contamination Prevention Act

The airbags, seat belt tensioners, and CR type batteries in this vehicle may contain perchlorate materials - special handling may apply. See www.dtsc.ca.gov/hazardouswaste/perchlorate/

As you read this manual, you will find information that is preceded by a **NOTICE** symbol. This information is intended to help you avoid damage to your vehicle, other property, or the environment.

A Few Words About Safety

Your safety, and the safety of others, is very important. And operating this vehicle safely is an important responsibility.

To help you make informed decisions about safety, we have provided operating procedures and other information on labels and in this manual. This information alerts you to potential hazards that could hurt you or others.

Of course, it is not practical or possible to warn you about all the hazards associated with operating or maintaining your vehicle. You must use your own good judgment.

You will find this important safety information in a variety of forms, including:

- **Safety Labels** - on the vehicle.
- **Safety Messages** - preceded by a safety alert symbol  and one of three signal words: **DANGER**, **WARNING**, or **CAUTION**. These signal words mean:

 **DANGER**

You **WILL** be **KILLED** or **SERIOUSLY HURT** if you don't follow instructions.

 **WARNING**

You **CAN** be **KILLED** or **SERIOUSLY HURT** if you don't follow instructions.

 **CAUTION**

You **CAN** be **HURT** if you don't follow instructions.

- **Safety Headings** - such as Important Safety Precautions.
- **Safety Section** - such as Safe Driving.
- **Instructions** - how to use this vehicle correctly and safely.

This entire book is filled with important safety information - please read it carefully.

This owner's manual should be considered a permanent part of the vehicle and should remain with the vehicle when it is sold.

This owner's manual covers all models of your vehicle. You may find descriptions of equipment and features that are not on your particular model.

Images throughout this owner's manual (including the front cover) represent features and equipment that are available on some, but not all, models. Your particular model may not have some of these features.

This owner's manual is for vehicles sold in the United States and Canada.

The information and specifications included in this publication were in effect at the time of approval for printing. Honda Motor Co., Ltd. reserves the right, however, to discontinue or change specifications or design at any time without notice and without incurring any obligation.

➤ Safe Driving P. 27

For Safe Driving P. 28 Seat Belts P. 33 Airbags P. 41

➤ Instrument Panel P. 69

Indicators P. 70 Gauges and Displays P. 94

➤ Controls P. 129

Lock P. 130 Locking and Unlocking the Doors P. 132
Opening and Closing the Moonroof* P. 154
Adjusting the Seats P. 177
Climate Control System* P. 203

➤ Features P. 207

Audio System P. 208 Audio System Basic Operation P. 216, 234
Customized Features P. 274 HomeLink® Universal Transceiver* P. 285

➤ Driving P. 351

Before Driving P. 352 Towing a Trailer P. 357
Parking Your Vehicle P. 425 Multi-View Rear Camera P. 426

➤ Maintenance P. 435

Before Performing Maintenance P. 436 Maintenance Minder™ P. 439
Checking and Maintaining Wiper Blades P. 471

➤ Handling the Unexpected P. 493

Tools P. 494 If a Tire Goes Flat P. 495
Overheating P. 507 Indicator, Coming On/Blinking P. 509

➤ Information P. 519

Specifications P. 520 Identification Numbers P. 522
Emissions Testing P. 525 Warranty Coverages P. 527

Contents

Child Safety P. 54

Exhaust Gas Hazard P. 67

Safety Labels P. 68

Opening and Closing the Tailgate P. 142
Operating the Switches Around the Steering Wheel P. 155
Interior Lights/Interior Convenience Items P. 187

Security System P. 149

Opening and Closing the Windows P. 152
Adjusting the Mirrors P. 175
Heating and Cooling System* P. 200

Audio Error Messages P. 265
Bluetooth® HandsFreeLink® P. 288, 317

General Information on the Audio System P. 271
Compass P. 347

Off-Highway Driving Guidelines P. 362
Refueling P. 429

When Driving P. 364
Fuel Economy P. 432

Braking P. 412
Accessories and Modifications P. 433

Maintenance Under the Hood P. 450
Checking and Maintaining Tires P. 475
Heating and Cooling System*/Climate Control System* Maintenance P. 487

Replacing Light Bulbs P. 462
Battery P. 484

Remote Transmitter Care P. 485
Cleaning P. 488

Engine Does Not Start P. 501
Fuses P. 513

Jump Starting P. 504
Emergency Towing P. 516

Shift Lever Does Not Move P. 506
When You Cannot Open the Tailgate P. 517

Devices that Emit Radio Waves P. 523
Authorized Manuals P. 529

Reporting Safety Defects P. 524
Customer Service Information P. 530

Quick Reference Guide P. 4

Safe Driving P. 27

Instrument Panel P. 69

Controls P. 129

Features P. 207

Driving P. 351

Maintenance P. 435

Handling the Unexpected P. 493

Information P. 519

Index P. 532

Visual Index

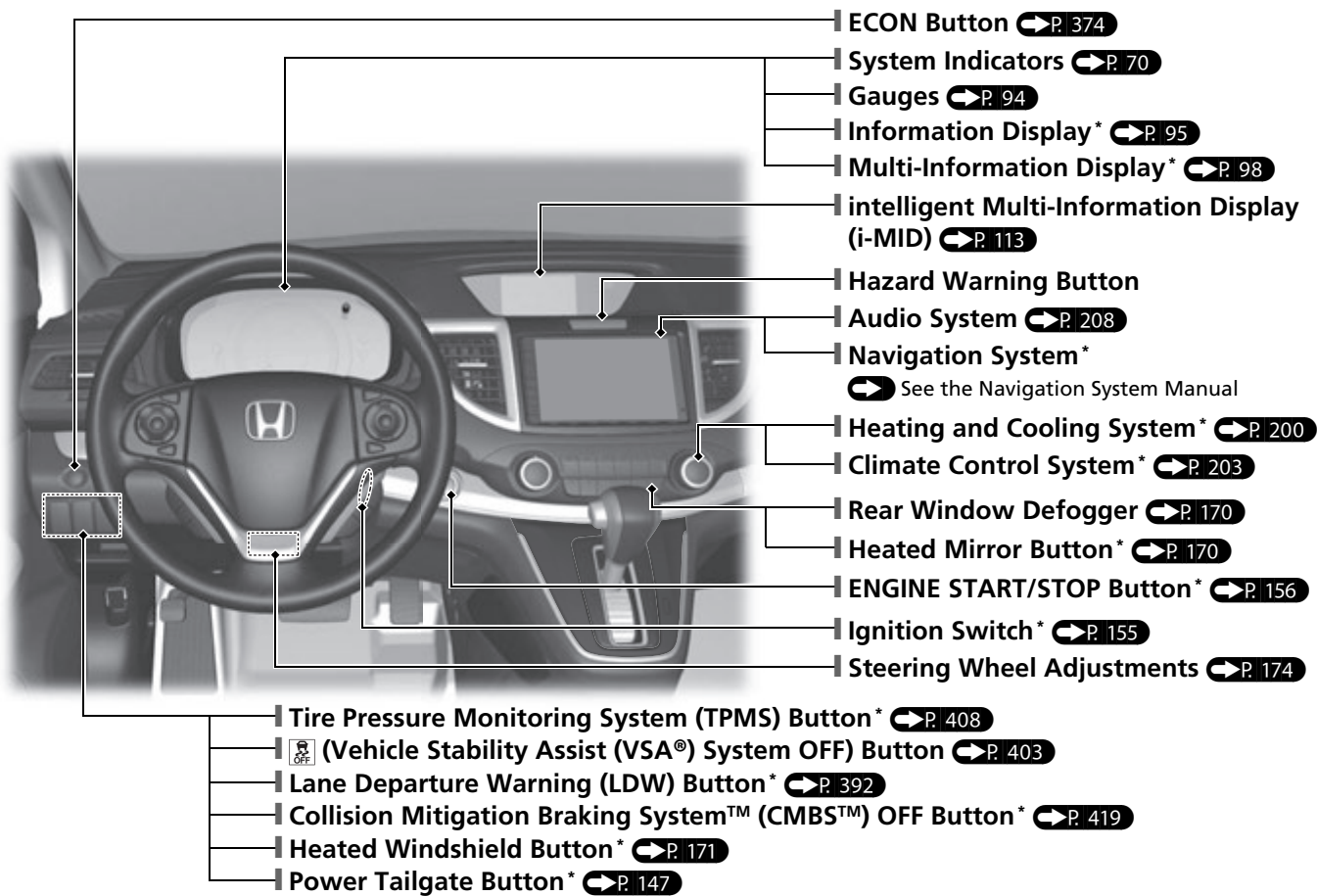

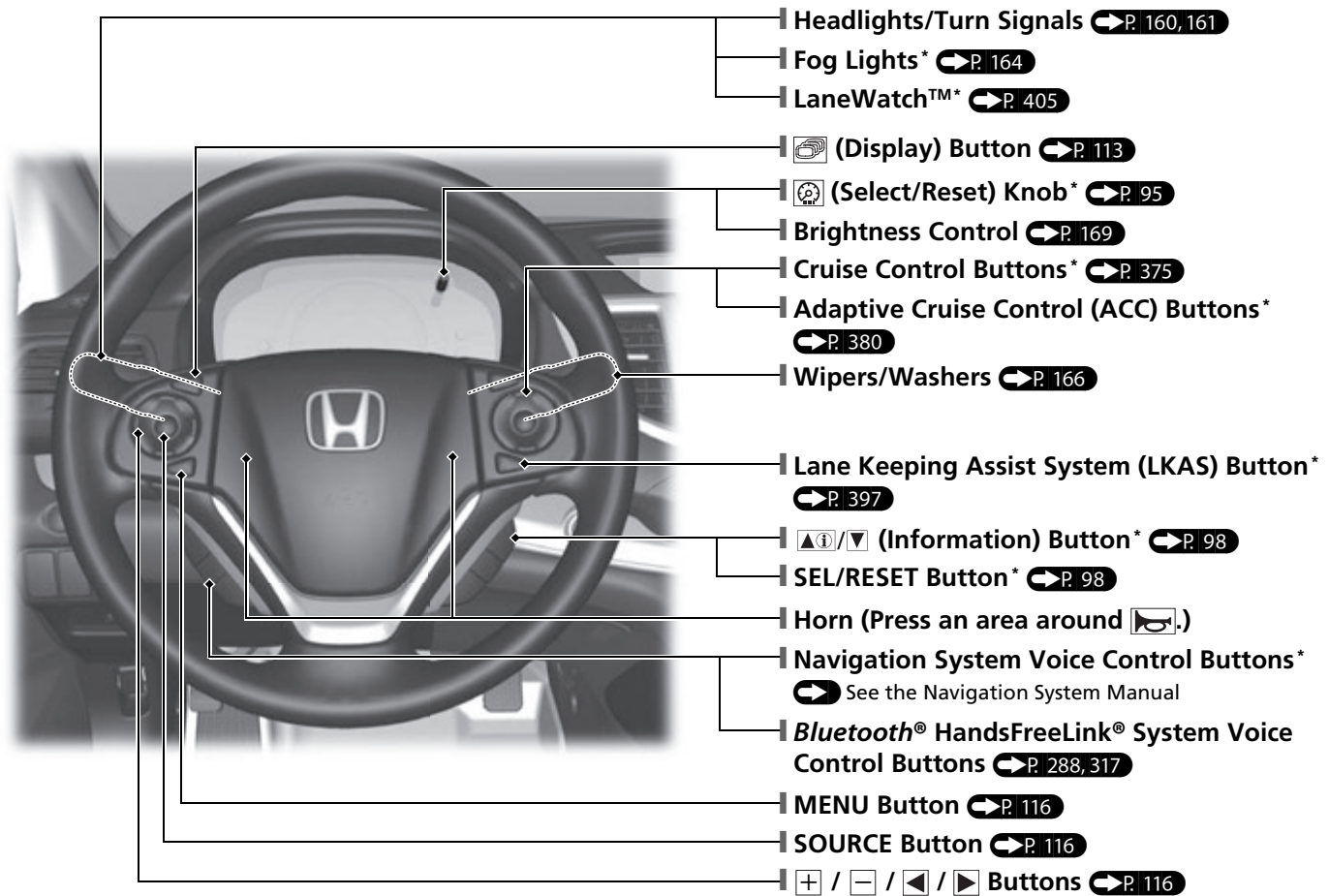

* Not available on all models

Visual Index

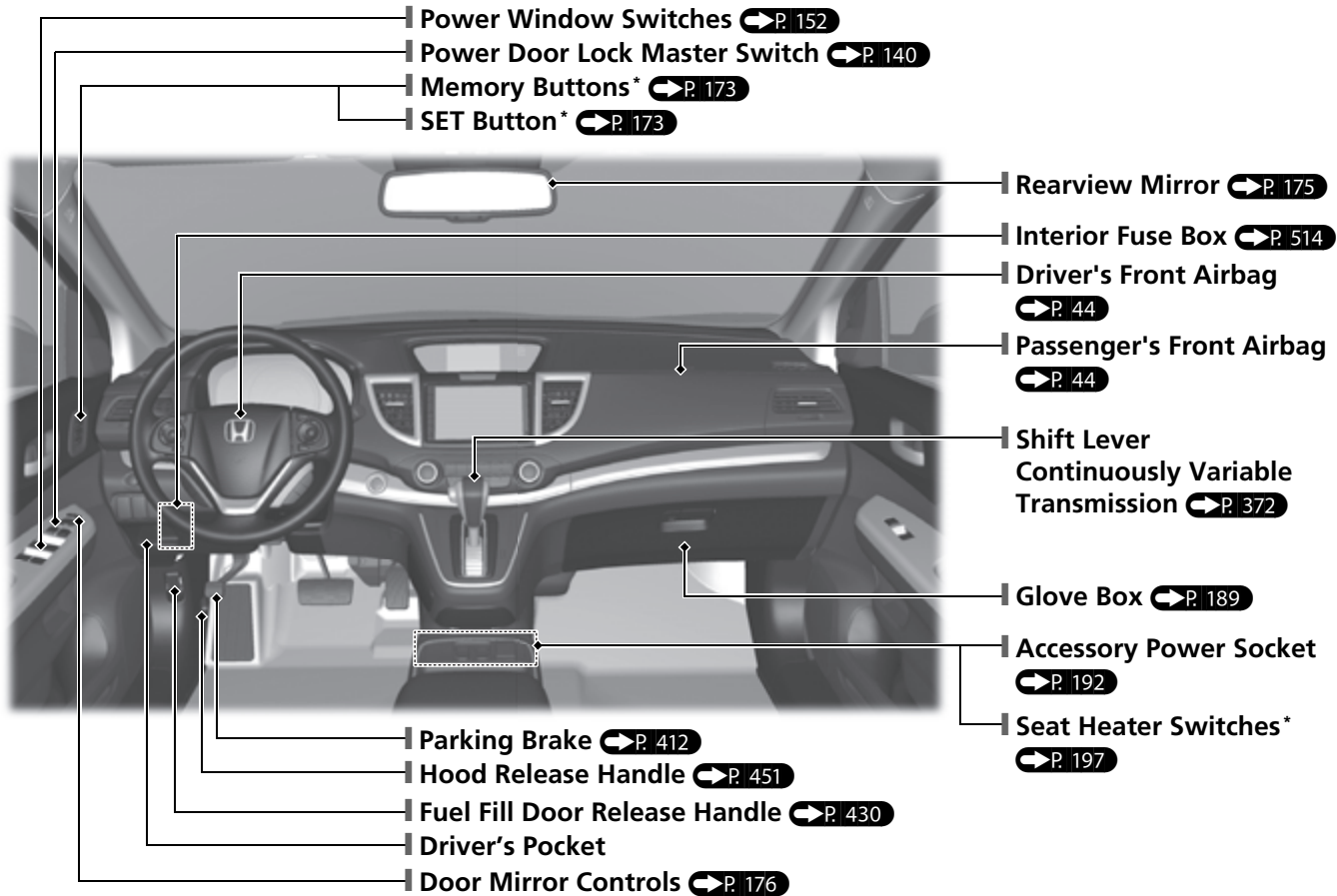

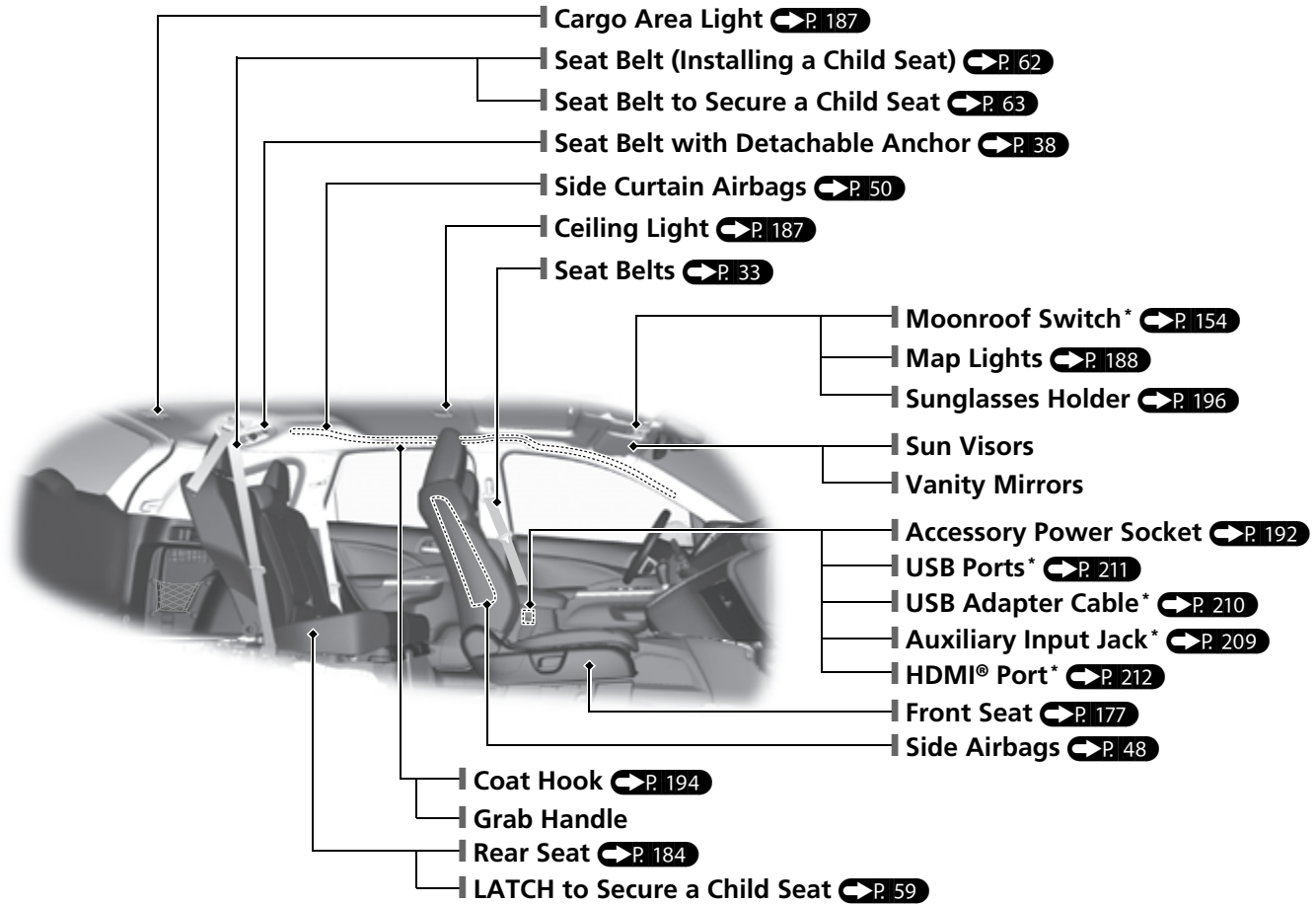

Visual Index

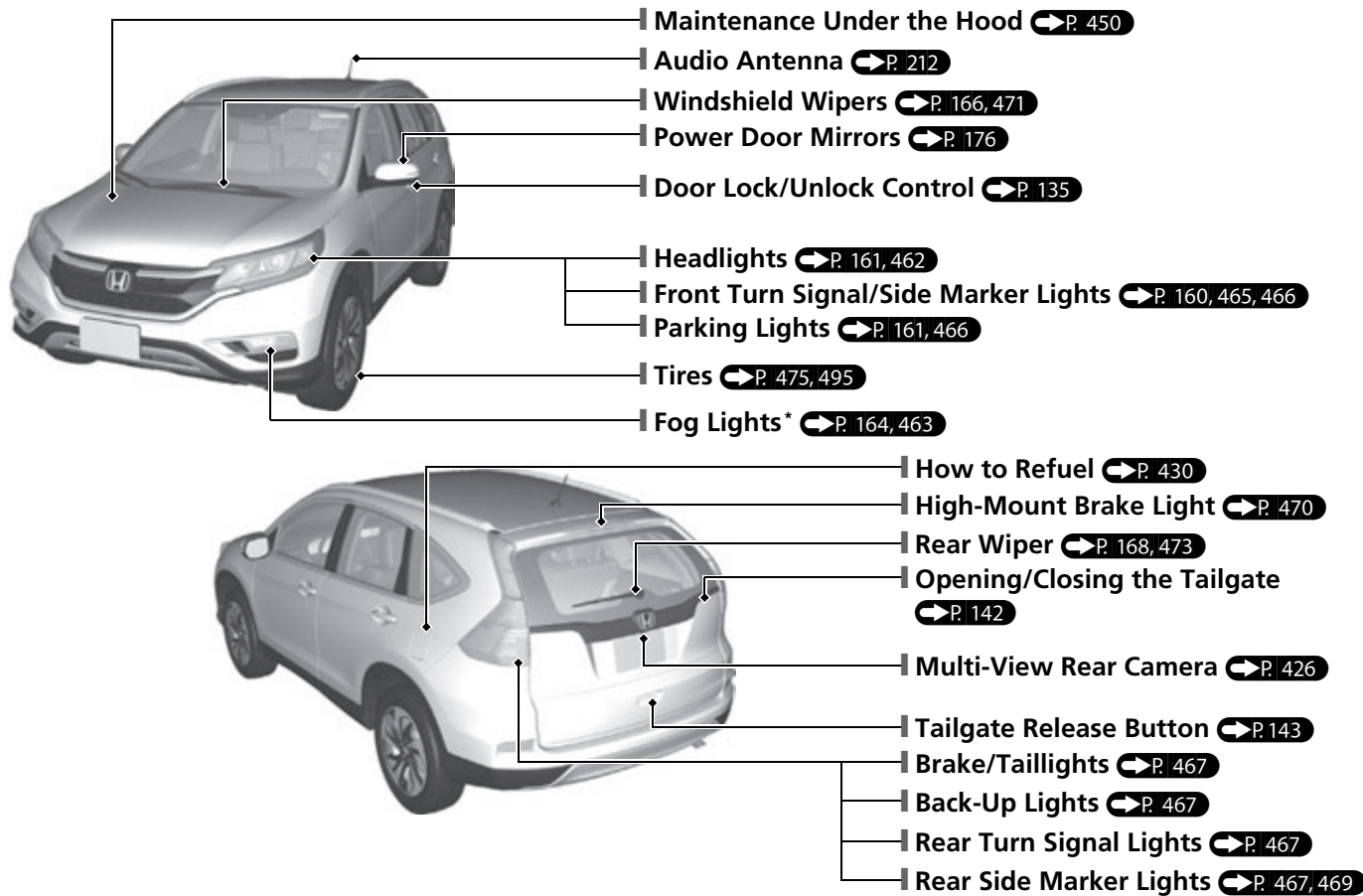

Eco Assist System P. 374

Ambient Meter

- Changes color to reflect your driving style.
Green: Fuel efficient driving
Yellow: Moderate acceleration/ deceleration
White: Aggressive acceleration/ deceleration
- The ambient meter color changes in accordance with your brake or accelerator pedal operation.

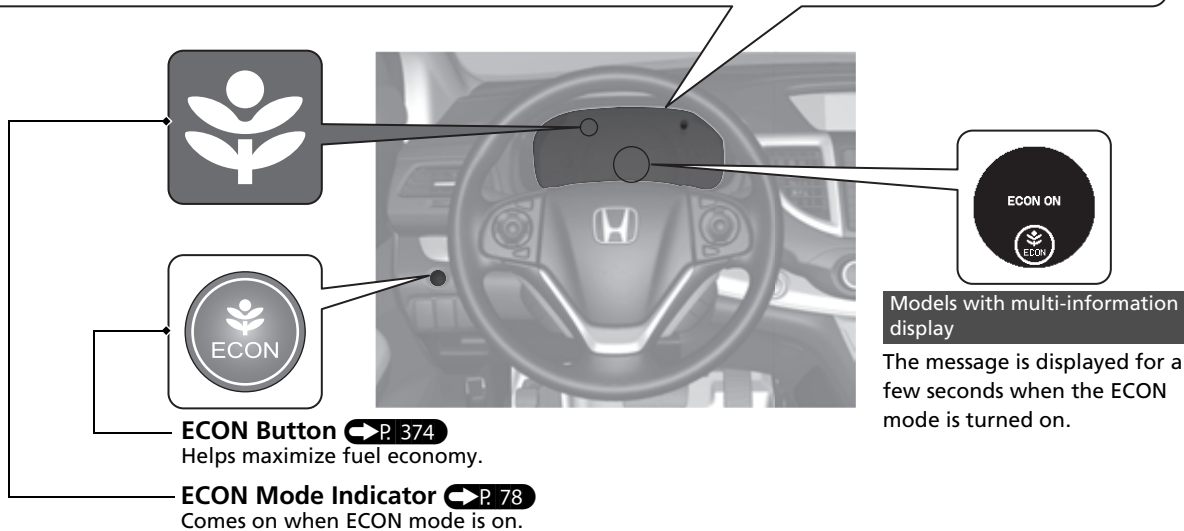
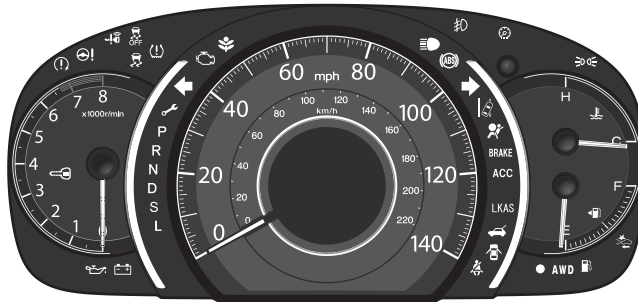

Safe Driving P. 27

Airbags P. 41

- Your vehicle is fitted with airbags to help protect you and your passengers during a moderate-to-severe collision.

Child Safety P. 54

- All children 12 and younger should be seated in the rear seat.
- Smaller children should be properly restrained in a forward-facing child seat.
- Infants must be properly restrained in a rear-facing child seat.

Exhaust Gas Hazard P. 67

- Your vehicle emits dangerous exhaust gases that contain carbon monoxide. Do not run the engine in confined spaces where carbon monoxide gas can accumulate.

Seat Belts P. 33

- Fasten your seat belt and sit upright well back in the seat.
- Check that your passengers are wearing their seat belts correctly.



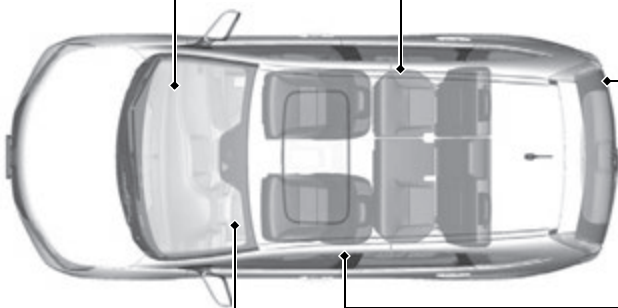

Before Driving Checklist P. 32

- Before driving, check that the front seats, head restraints, steering wheel, and mirrors have been properly adjusted.

















Fasten your lap belt as low as possible.

Instrument Panel P. 69



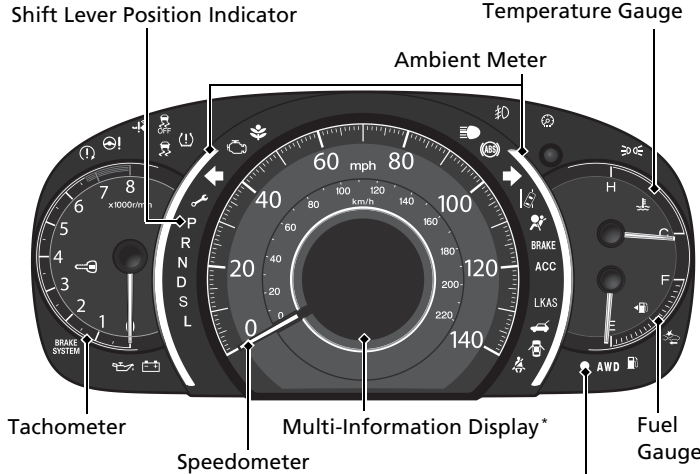

Gauges  P. 94 / Information Display*  P. 95 / Multi-Information Display*  P. 98 / intelligent Multi-Information Display (i-MID)  P. 113 / System Indicators  P. 70

System Indicators

-  Low Tire Pressure/TPMS Indicator
-  Malfunction Indicator Lamp
-  Low Oil Pressure Indicator
-  Charging System Indicator
-  Anti-lock Brake System (ABS) Indicator
-  Smart Entry System Indicator*
-  Vehicle Stability Assist (VSA®) System Indicator
-  VSA® OFF Indicator
-  Door and Tailgate* Open Indicator
-  Tailgate Open Indicator*
-  ECON Mode Indicator
-  Immobilizer System Indicator
-  BRAKE U.S. Parking Brake and Brake System Indicator (Red)
-  BRAKE Canada
-  System Message Indicator*



System Indicators













-  BRAKE SYSTEM U.S. Brake System Indicator (Amber)
-  BRAKE Canada
-  ACC Adaptive Cruise Control (ACC) Indicator*
-  LKAS Lane Keeping Assist System (LKAS) Indicator*

Security System Alarm Indicator*

Lights Indicators

-  Lights On Indicator
-  High Beam Indicator
-  Fog Light Indicator*

System Indicators

-  AWD All-Wheel Drive (AWD) System Indicator*
-  Turn Signal and Hazard Warning Indicators
-  Electric Power Steering (EPS) Indicator
-  Low Fuel Indicator
-  Seat Belt Reminder Indicator
-  Supplemental Restraint System Indicator
-  Starter System Indicator*
-  Collision Mitigation Braking System™ (CMBS™) Indicator*
-  Lane Departure Warning Indicator*
-  CRUISE MAIN Indicator*
-  CRUISE CONTROL Indicator*
-  Maintenance Minder Indicator*
-  Washer Level Indicator*

* Not available on all models

Controls P. 129

Clock P. 130

Models with navigation system

The navigation system receives signals from GPS satellites, updating the clock automatically.

Models without navigation system

Models with two displays

The clock in the i-MID is automatically updated along with the audio system's clock display.

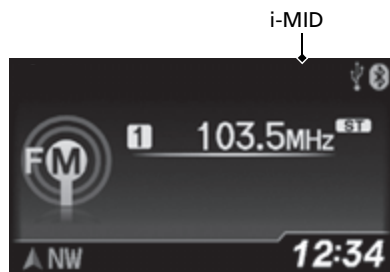

Models with one display

- 1 Press the **CLOCK (AUX)** button until the displayed time begins flashing.
- 2 Press the **[4]** (Hour) or **[5]** (Minute) button to set the time. Press the **[6]** (Reset) button to set the time to the nearest hour.
- 3 Press the **CLOCK** button again to set the time.

To set the time to the nearest hour:
Press and hold the **CLOCK** button until the clock display begins to blink, then press the **[6]** (Reset) button.

Depending on the displayed time, the clock sets forward or backward.

Example:



1:06 will reset to 1:00

1:53 will reset to 2:00

Models with two displays

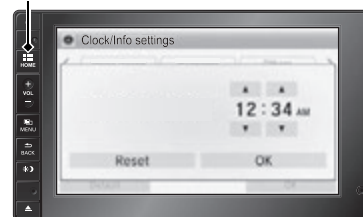
 (Home) Button



- 1 Press the  (Home) button, then select **Settings**.
- 2 Select **Clock/Info**, then **Clock Adjustment**.
- 3 Touch the  icon to adjust the numbers up or down.
- 4 Select **OK**.

ENGINE START/STOP

Button*

Press the button to change the vehicle's power mode.



Turn Signals

Turn Signal Control Lever

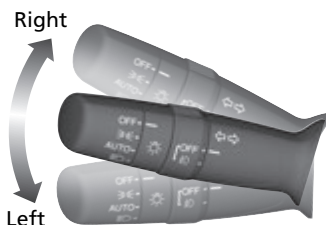

Lights

Light Control Switches

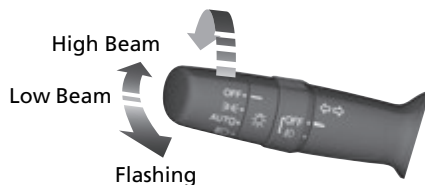

Wipers and Washers

Wiper/Washer Control Lever

MIST
OFF
AUTO^{*1}: Wiper speed varies automatically
INT^{*2}: Low speed with intermittent
LO: Low speed wipe
HI: High speed wipe

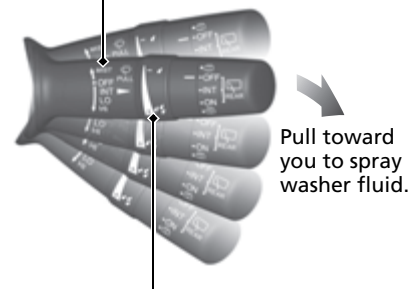

Adjustment Ring
☹: Low Sensitivity^{*1}
: Lower speed, fewer sweeps^{*2}
☹☹: High Sensitivity^{*1}
: Higher speed, more sweeps^{*2}

*1: Models with automatic intermittent wipers

*2: Models without automatic intermittent wipers

* Not available on all models

Steering Wheel P.174

- To adjust, pull the adjustment lever towards you, adjust to the desired position, then lock the lever back in place.

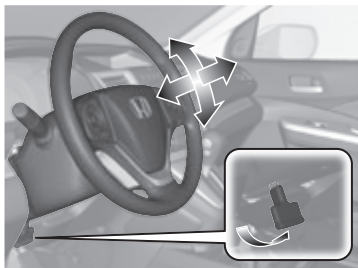

Unlocking the Front Doors from the Inside

 P.139

- Pull either front door inner handle to unlock and open it at the same time.

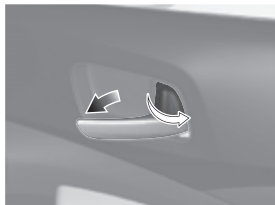

Tailgate P.142

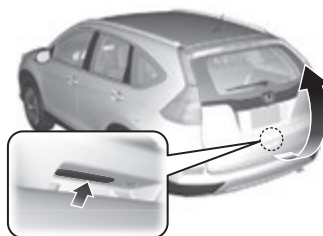

Models without smart entry system

- With all the doors unlocked, press the tailgate release button and lift open the tailgate.

Models with smart entry system

- Press the tailgate release button to unlock and open the tailgate when you have the smart entry remote on you. If your model is equipped with a power tailgate, you can press the power tailgate button on the driver side control panel, or press the remote transmitter.

Power Door Mirrors

 P.176

- With the ignition switch in ON ^{*1}, move the selector switch to L or R.
- Push the appropriate edge of the adjustment switch to adjust the mirror.

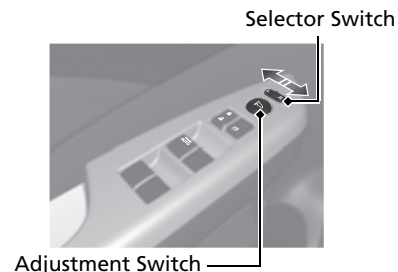

*1: Models with the smart entry system have an **ENGINE START/STOP** button instead of an ignition switch.





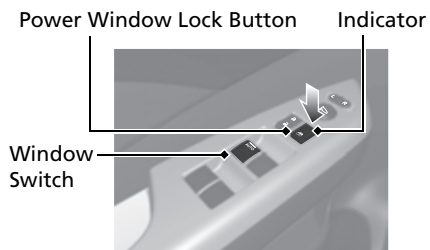











Power Windows

- With the ignition switch in ON *1, open and close the power windows.
- If the power window lock button is in the off position, each passenger's window can be opened and closed with its own switch.
- If the power window lock button is in the on position (indicator on), each passenger's window switch is disabled.





*1: Models with the smart entry system have an **ENGINE START/STOP** button instead of an ignition switch.

Heating and Cooling System*

- Rotate the fan control dial to adjust the fan speed.
- Press the Mode buttons ( /  /  /  /  /  /  /  /  /  /  /  /  /  /  /  / /





Climate Control System* P. 203

- Press the **AUTO** button to activate the climate control system.
- Press the  button to turn the system on or off.
- Press the  button to defrost the windshield.

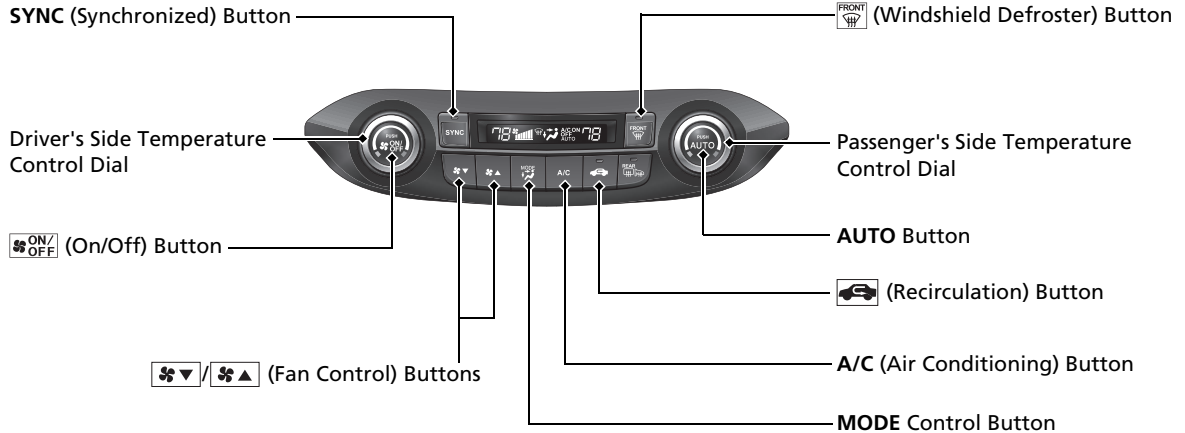
Models with navigation system

The climate control system is voice operable. See the Navigation System Manual for complete details.



-  Air flows from dashboard vents and back of the center console.
-  Air flows from floor and dashboard vents and back of the center console.
-  Air flows from floor vents.
-  Air flows from floor and windshield defroster vents.

Features ➔ P. 207

Audio Remote Controls

➔ P. 214

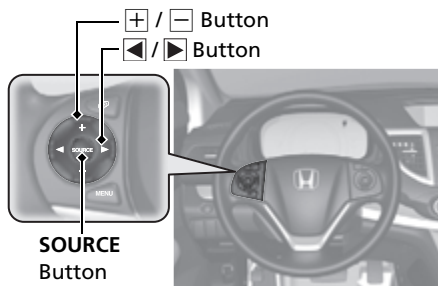

- **+ / - Button**
Press to adjust the volume up/down.

- **SOURCE Button**

Models with one display

Press to change the audio mode: FM1/
FM2/AM/CD/AUX.

Models with two displays

Press to change the audio mode: FM/AM/
SiriusXM®*/CD/USB/iPod/Pandora®*/Aha™/
Apps/Bluetooth® Audio/AUX HDMI.

- **◀ / ▶ Button**

Radio: Press to change the preset station.
Press and hold to select the next or
previous strong station.

CD/USB device:

Press to skip to the beginning of
the next song or return to the
beginning of the current song.
Press and hold to change a folder.

Audio System ➔ P. 208

For navigation system operation ➔ See the Navigation System Manual

Models with one display

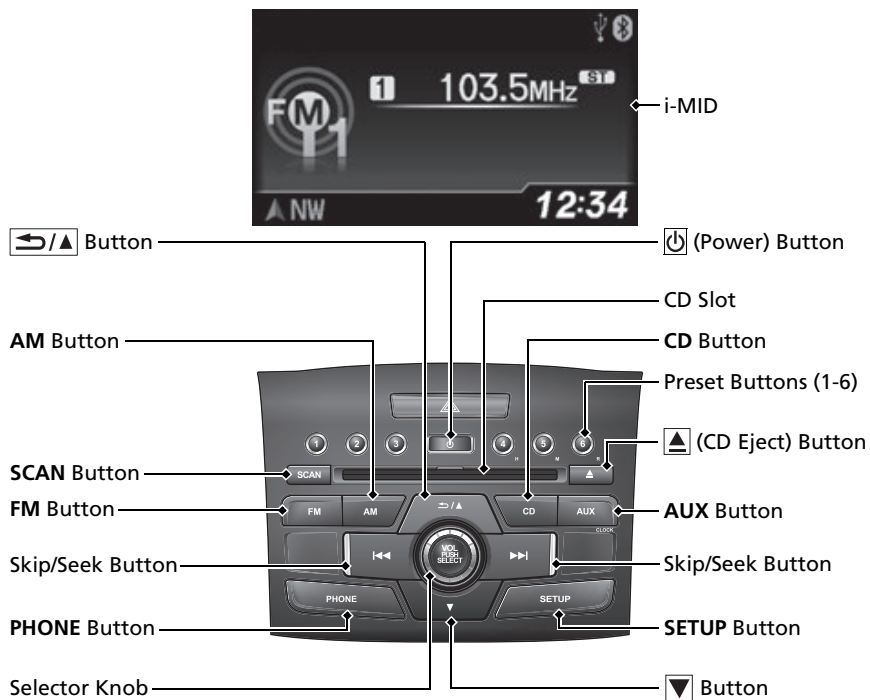

Models with two displays

i-MID

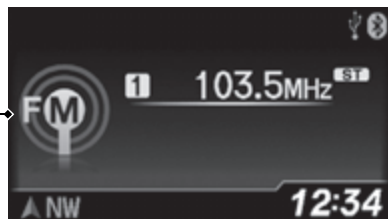

Audio/Information Screen

(Power) Button

(Home) Button

VOL (Volume) Buttons

(Menu) Button

(Back) Button

Button

(Eject/CLOSE) Button



Microphones

- Press the (Eject/CLOSE) button to open the screen.

(Eject/CLOSE) Button CD Slot



- Press the (Eject/CLOSE) button to return the screen to the upright position.

Driving ➔ P. 351

Continuously Variable Transmission ➔ P. 372

- Shift to **P** and depress the brake pedal when starting the engine.

● Shifting

P **Park**
Turn off or start the engine.
Transmission is locked.

R **Reverse**
Used when reversing

N **Neutral**
Transmission is not locked.

D **Drive**
Normal driving.

S **Drive (S)**

- Better acceleration
- Used to increase engine braking
- Used when going up or down hills

L **Low**

- Used to further increase engine braking
- Used when going up or down hills

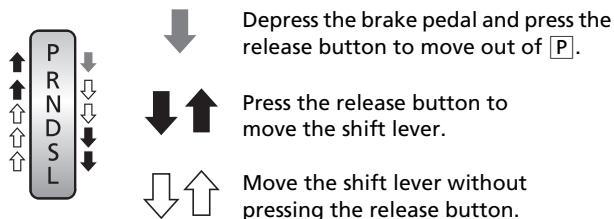
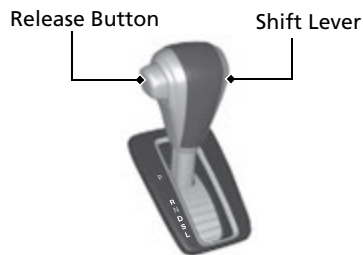

VSA® OFF Button P. 404

- The vehicle stability assist (VSA®) system helps stabilize the vehicle during cornering, and helps maintain traction while accelerating on loose or slippery road surfaces.
- VSA® comes on automatically every time you start the engine.
- To turn VSA® on or off, press and hold the button until you hear a beep.

Cruise Control* P. 375

- Cruise control allows you to maintain a set speed without keeping your foot on the accelerator pedal.
- To use cruise control, press the **CRUISE*/MAIN*** button, then press **-/SET** once you have achieved the desired speed (above 25 mph or 40 km/h).

Tire Pressure Monitoring System (TPMS) P. 408

- Detects a change in tire conditions and overall dimensions due to decrease in tire pressures.
- The TPMS is turned on automatically every time you start the engine.
- A calibration procedure must be performed when certain conditions arise.

Collision Mitigation Braking System™ (CMBS™) OFF Button *

 P. 419

- When a possible collision is likely unavoidable, the CMBS™ can help you to reduce the vehicle speed and the severity of the collision.
- To turn the CMBS™ on or off, press and hold the button until you hear a beep.

Refueling P. 429

Fuel recommendation: Unleaded gasoline with a pump octane number 87 or higher required

Fuel tank capacity: 15.3 US gal (58 L)

- 1** Pull the fuel fill door release handle.



- 2** Turn the fuel fill cap slowly to remove the cap.

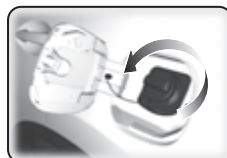

- 3** Place the cap in the holder on the fuel fill door.



- 4** After refueling, screw the cap back on until it clicks at least once.

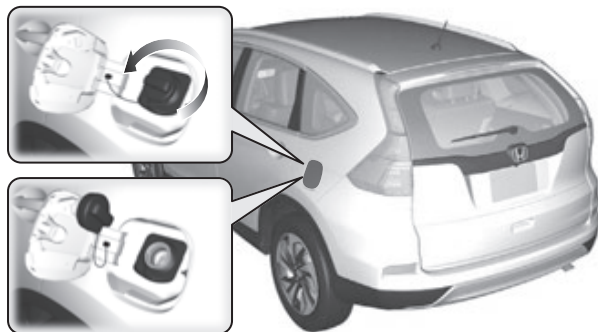

Maintenance P. 435

Under the Hood P. 450

- Check engine oil, engine coolant, and windshield washer fluid. Add when necessary.
- Check brake fluid.
- Check the battery condition monthly.

- 1 Pull the hood release handle under the corner of the dashboard.

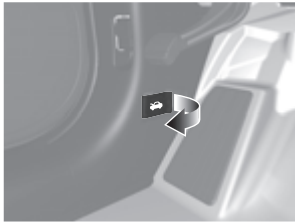

- 2 Locate the hood latch lever, pull the lever back, and lift up the hood.

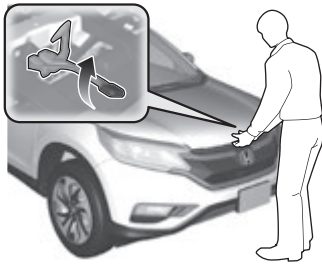

- 3 When finished, close the hood and make sure it is firmly locked in place.

Wiper Blades P. 471

- Replace blades if they leave streaks across the windshield.



Tires P. 475

- Inspect tires and wheels regularly.
- Check tire pressures regularly.
- Install snow tires for winter driving.

Lights P. 462

- Inspect all lights regularly.

Handling the Unexpected P.493

Flat Tire P.495

- Park in a safe location and replace the flat tire with the compact spare tire in the cargo area.



Engine Won't Start P.501

- If the battery is dead, jump start using a booster battery.

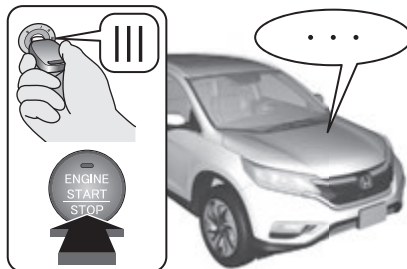

Overheating P.507

- Park in a safe location. If you do not see steam under the hood, open the hood, and let the engine cool down.



Indicators Come On

 P.509

- Identify the indicator and consult the owner's manual.



Blown Fuse P.513

- Check for a blown fuse if an electrical device does not operate.

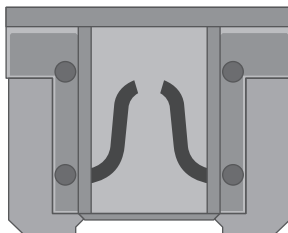

Emergency Towing P.516

- Call a professional towing service if you need to tow your vehicle.

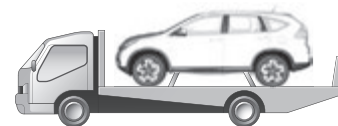

What to Do If

Q **Models with smart entry system*1**
The power mode does not change from **VEHICLE OFF (LOCK)** to **ACCESSORY**.
Why?

Models without smart entry system
The ignition switch does not turn from **0** to **1**.
Why?

A **Models with smart entry system*1**

- The steering wheel may be locked.
- Move the steering wheel left and right while pressing the **ENGINE START/STOP** button at the same time.

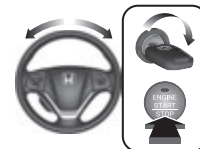

Models without smart entry system

- Try to turn the steering wheel left and right while turning the ignition key.

Q **Models with smart entry system**
The power mode does not change from **ACCESSORY** to **VEHICLE OFF (LOCK)**.
Why?

Models without smart entry system
The ignition switch does not turn from **1** to **0** and I cannot remove the key.
Why?

A The shift lever should be moved to **P**.



*1: Canadian models

Q Why does the brake pedal pulsate slightly when applying the brakes?

A This can occur when the ABS activates, and does not indicate a problem. Apply firm, steady pressure on the brake pedal. Never pump the brake pedal.

Q The rear door cannot be opened from inside the vehicle. Why?

A Check if the childproof lock is in the lock position. If so, open the rear door with the outside door handle. To cancel this function, push the lever to the unlock position.



Q Why do the doors lock after I unlocked the doors using a remote transmitter?

A If you do not open the doors within 30 seconds, the doors are relocked automatically for security.

Q Why does the beeper sound when I open the driver's door?

A The beeper sounds when:

- The key is left in the ignition switch*.
- The power mode* is in ACCESSORY.
- The exterior lights are left on.



Why does the beeper sound when I start driving?



The beeper sounds when:

- Driver and/or front passenger are not wearing their seat belts.
- The parking brake lever is not fully released.



Why do I hear a screeching sound when I apply the brake pedal?



The brake pads may need to be replaced. Have your vehicle inspected by a dealer.

Safe Driving

You can find many safety recommendations throughout this chapter, and throughout this manual.

For Safe Driving

| | |
|-------------------------------------|----|
| Important Safety Precautions | 28 |
| Important Handling Information..... | 30 |
| Your Vehicle's Safety Features..... | 31 |

Seat Belts

| | |
|----------------------------|----|
| About Your Seat Belts..... | 33 |
| Fastening a Seat Belt..... | 36 |
| Seat Belt Inspection..... | 40 |

Airbags

| | |
|-------------------------------|----|
| Airbag System Components..... | 41 |
| Types of Airbags | 44 |
| Front Airbags (SRS) | 44 |

| | |
|-------------------------------|----|
| Side Airbags | 48 |
| Side Curtain Airbags | 50 |
| Airbag System Indicators..... | 51 |
| Airbag Care | 53 |

Child Safety

| | |
|--|----|
| Protecting Child Passengers | 54 |
| Safety of Infants and Small Children | 56 |
| Safety of Larger Children | 65 |

Exhaust Gas Hazard

| | |
|--------------------------|----|
| Carbon Monoxide Gas..... | 67 |
|--------------------------|----|

Safety Labels

| | |
|-----------------------|----|
| Label Locations | 68 |
|-----------------------|----|

The following pages explain your vehicle's safety features and how to use them properly. The safety precautions below are ones that we consider to be among the most important.

Important Safety Precautions

■ Always wear your seat belt

A seat belt is your best protection in all types of collisions. Airbags are designed to supplement seat belts, not replace them. So even though your vehicle is equipped with airbags, make sure you and your passengers always wear your seat belts, and wear them properly.

■ Restrain all children

Children ages 12 and under should ride properly restrained in a back seat, not the front seat. Infants and small children should be restrained in a child seat. Larger children should use a booster seat and a lap/shoulder seat belt until they can use the belt properly without a booster seat.

■ Be aware of airbag hazards

While airbags can save lives, they can cause serious or fatal injuries to occupants who sit too close to them, or are not properly restrained. Infants, young children, and short adults are at the greatest risk. Be sure to follow all instructions and warnings in this manual.

■ Don't drink and drive

Alcohol and driving don't mix. Even one drink can reduce your ability to respond to changing conditions, and your reaction time gets worse with every additional drink. So don't drink and drive, and don't let your friends drink and drive, either.

ⓘ Important Safety Precautions

Some states, provinces and territories prohibit the use of cell phones other than hands-free devices by the driver while driving.

■ **Pay appropriate attention to the task of driving safely**

Engaging in cell phone conversation or other activities that keep you from paying close attention to the road, other vehicles, and pedestrians could lead to a crash. Remember, situations can change quickly, and only you can decide when it is safe to divert some attention away from driving.

■ **Control your speed**

Excessive speed is a major factor in crash injuries and deaths. Generally, the higher the speed, the greater the risk, but serious injuries can also occur at lower speeds. Never drive faster than is safe for current conditions, regardless of the maximum speed posted.

■ **Keep your vehicle in safe condition**

Having a tire blowout or a mechanical failure can be extremely hazardous. To reduce the possibility of such problems, check your tire pressures and condition frequently, and perform all regularly scheduled maintenance.

Important Handling Information

Your vehicle has higher ground clearance than a passenger vehicle designed for use only on pavement. Higher ground clearance has many advantages for off-highway driving. It allows you to travel over bumps, obstacles, and rough terrain. It also provides good visibility so you can anticipate problems earlier.

These advantages come at some cost. Because your vehicle is taller and rides higher off the ground, it has a higher center gravity making it more susceptible to tripping or roll over if you make abrupt turns. Utility vehicles have a significantly higher rollover rate than other types of vehicles. In a rollover crash, an unbelted person is significantly more likely to die than a person wearing a seat belt. As a reminder, make sure you and your passengers always wear seat belts.

Important Handling Information

For information on how to reduce the risk of rollover, read:

► **Precautions While Driving** P. 370

► **Off-Highway Driving Guidelines** P. 362

Failure to operate your vehicle correctly might result in a crash or a rollover.

Your Vehicle's Safety Features

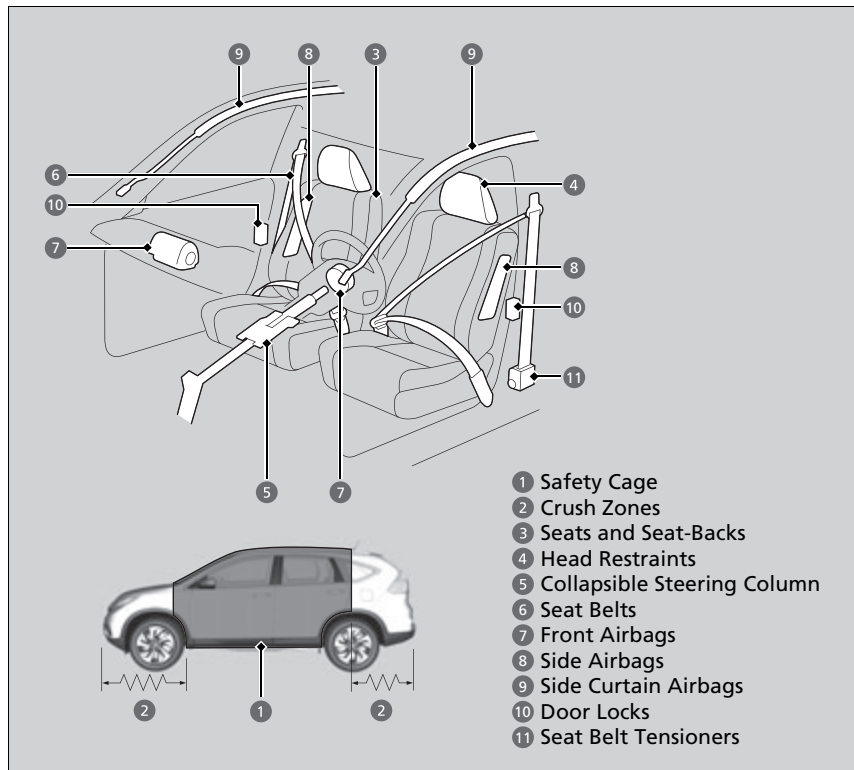

- 1 Safety Cage
- 2 Crush Zones
- 3 Seats and Seat-Backs
- 4 Head Restraints
- 5 Collapsible Steering Column
- 6 Seat Belts
- 7 Front Airbags
- 8 Side Airbags
- 9 Side Curtain Airbags
- 10 Door Locks
- 11 Seat Belt Tensioners

The following checklist will help you take an active role in protecting yourself and your passengers.

▣ Your Vehicle's Safety Features

Your vehicle is equipped with many features that work together to help protect you and your passengers during a crash.

Some features do not require any action on your part. These include a strong steel framework that forms a safety cage around the passenger compartment, front and rear crush zones, a collapsible steering column, and tensioners that tighten the front seat belts in a sufficient crash.

However, you and your passengers cannot take full advantage of these features unless you remain seated in the correct position and always wear your seat belts. In fact, some safety features can contribute to injuries if they are not used properly.

■ Safety Checklist

For the safety of you and your passengers, make a habit of checking these items each time before you drive.

- After everyone has entered the vehicle, be sure all doors and the tailgate are closed and locked. Locking the doors and the tailgate helps prevent an occupant from being ejected and an outsider from unexpectedly opening a door or the tailgate.
 - ▶ **Locking/Unlocking the Doors from the Inside** P. 139
- Adjust your seat to a position suitable for driving. Be sure the front seats are adjusted as far to the rear as possible while allowing the driver to control the vehicle. Sitting too close to a front airbag can result in serious or fatal injury in a crash.
 - ▶ **Adjusting the Seats** P. 177
- Adjust head restraints to the proper position. Head restraints are most effective when the center of the head restraint aligns with the center of your head. Taller persons should adjust their head restraint to the highest position.
 - ▶ **Adjusting the Head Restraints** P. 180
- Always wear your seat belt, and make sure you wear it properly. Confirm that any passengers are properly belted as well.
 - ▶ **Fastening a Seat Belt** P. 36
- Protect children by using seat belts or child seats according to a child's age, height and weight.
 - ▶ **Child Safety** P. 54

▶ Safety Checklist

If the door and/or the tailgate open indicator will come on and a message appears on the multi-information display*, a door and/or the tailgate is not completely closed. Close all doors and the tailgate tightly until the indicator goes off.

- ▶ **Door and Tailgate Open Indicator** P. 75
- ▶ **Door Open Indicator** P. 75
- ▶ **Tailgate Open Indicator** P. 75

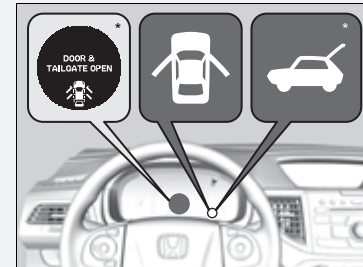

About Your Seat Belts

Seat belts are the single most effective safety device because they keep you connected to the vehicle so that you can take advantage of many built-in safety features. They also help keep you from being thrown against the inside of the vehicle, against other passengers, or out of the vehicle. When worn properly, seat belts also keep your body properly positioned in a crash so that you can take full advantage of the additional protection provided by the airbags.

In addition, seat belts help protect you in almost every type of crash, including:

- frontal impacts
- side impacts
- rear impacts
- rollovers

■ Lap/shoulder seat belts

All five seating positions are equipped with lap/shoulder seat belts with emergency locking retractors. In normal driving the retractor lets you move freely while keeping some tension on the belt. During a collision or sudden stop the retractor locks to restrain your body.

The front passenger's and rear seat belts also have a lockable retractor for use with child seats.

➤ **Installing a Child Seat with a Lap/Shoulder Seat Belt** P. 62

ⓘ About Your Seat Belts

⚠ WARNING

Not wearing a seat belt properly increases the chance of serious injury or death in a crash, even though your vehicle has airbags.

Be sure you and your passengers always wear seat belts and wear them properly.

Seat belts cannot completely protect you in every crash. But in most cases, seat belts can reduce your risk of serious injury.

Most states and all Canadian provinces and territories require you to wear seat belts.

The emergency locking retractor may lock if you lean forward too quickly. Slower movements will allow the belt to extend fully without locking.

■ Proper use of seat belts

Follow these guidelines for proper use:

- All occupants should sit upright, well back in the seat, and remain in that position for the duration of the trip. Slouching and leaning reduce the effectiveness of the belt and can increase the chance of serious injury in a crash.
- Never place the shoulder part of a lap/shoulder seat belt under your arm or behind your back. This could cause very serious injuries in a crash.
- Two people should never use the same seat belt. If they do, they could be very seriously injured in a crash.
- Do not put any accessories on the seat belts. Devices intended to improve comfort or reposition the shoulder part of a seat belt can reduce the protective capability and increase the chance of serious injury in a crash.

■ Seat Belt Reminder



Your vehicle monitors front seat belt use. If the ignition switch is turned to ON ^{*1} before the driver's seat belt is fastened, the beeper will sound and the indicator will blink. If the driver does not fasten the belt before the beeper stops, the indicator will remain on.

The beeper will periodically sound and the indicator will blink while driving until the driver's and front passenger's seat belts are fastened.

*1: Models with the smart entry system have an **ENGINE START/STOP** button instead of an ignition switch.

* Not available on all models

▶ About Your Seat Belts

If a rear seat passenger moves around and extends the seat belt, the lockable retractor may activate. If this happens, release the retractor by unfastening the seat belt and allow the belt to retract completely. Then refasten the belt.

▶ Seat Belt Reminder

The indicator will also come on if a front passenger does not fasten their seat belt within six seconds after the ignition switch is turned to ON ^{*1}.

When no one is sitting in the front passenger's seat, the indicator will not come on and the beeper will not sound.

The indicator also may not come on and the beeper may not sound when the occupant is not heavy enough to trigger the weight sensor. Such occupants (e.g., infants and smaller children) should be moved to the rear seat as a deploying front airbag likely will injure or kill them.

 **Protecting Child Passengers** P. 54

Automatic Seat Belt Tensioners

The front seats are equipped with automatic seat belt tensioners to enhance safety.

The tensioners automatically tighten the front seat belts during a moderate-to-severe frontal collision, sometimes even if the collision is not severe enough to inflate the front airbags.

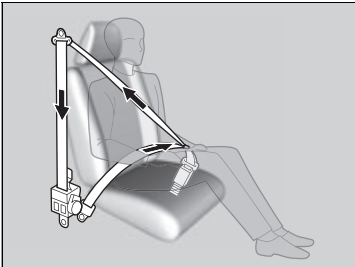

Automatic Seat Belt Tensioners

The seat belt tensioners can only operate once. If a tensioner is activated, the SRS indicator will come on. Have a dealer replace the tensioner and thoroughly inspect the seat belt system as it may not offer protection in a subsequent crash.

During a moderate-to-severe side impact, the tensioner on that side of the vehicle also activates.

Fastening a Seat Belt

After adjusting a front seat to the proper position, and while sitting upright and well back in the seat:

➤ **Adjusting the Seats** P. 177

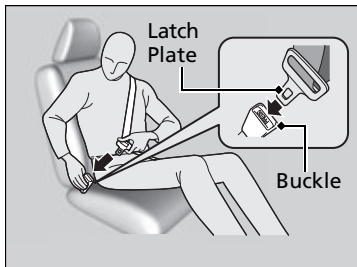
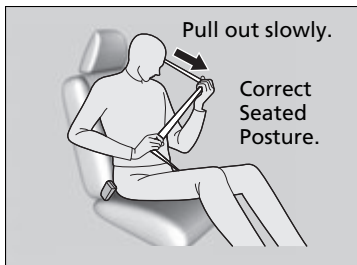

1. Pull the seat belt out slowly.

2. Insert the latch plate into the buckle, then tug on the belt to make sure the buckle is secure.

▶ Make sure that the belt is not twisted or caught on anything.

Fastening a Seat Belt

No one should sit in a seat with an inoperative seat belt or one that does not appear to be working correctly. Using a seat belt that is not working properly may not protect the occupant in a crash. Have a dealer check the belt as soon as possible.

Never insert any foreign objects into the buckle or retractor mechanism.

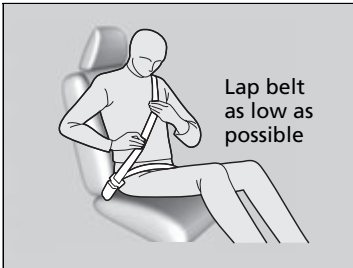

3. Position the lap part of the belt as low as possible across your hips, then pull up on the shoulder part of the belt so the lap part fits snugly. This lets your strong pelvic bones take the force of a crash and reduces the chance of internal injuries.
4. If necessary, pull up on the belt again to remove any slack, then check that the belt rests across the center of your chest and over your shoulder. This spreads the forces of a crash over the strongest bones in your upper body.

■ Adjusting the Shoulder Anchor

The front seats have adjustable shoulder anchors to accommodate taller and shorter occupants.

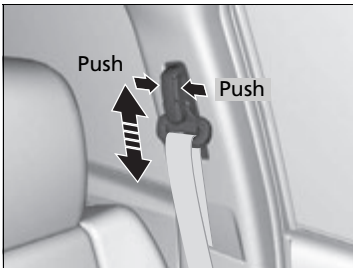

1. Move the anchor up and down while holding the release buttons.
2. Position the anchor so that the belt rests across the center of your chest and over your shoulder.

☒ Fastening a Seat Belt

⚠ WARNING

Improperly positioning the seat belts can cause serious injury or death in a crash.

Make sure all seat belts are properly positioned before driving.

To release the belt, push the red **PRESS** button then guide the belt by hand until it has retracted completely.

When exiting the vehicle, be sure the belt is out of the way and will not get caught by closing the door.

☒ Adjusting the Shoulder Anchor

The shoulder anchor height can be adjusted to four levels. If the belt contacts your neck, lower the height one level at a time.

After an adjustment, make sure that the shoulder anchor position is secure.

Seat Belt with Detachable Anchor

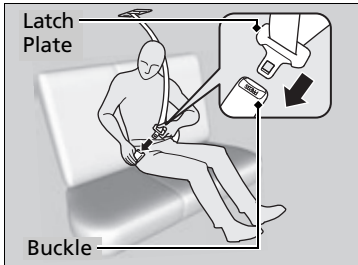
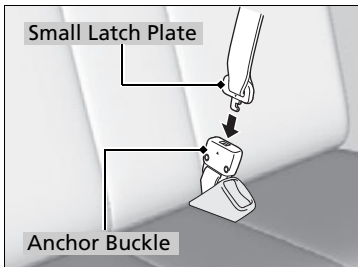
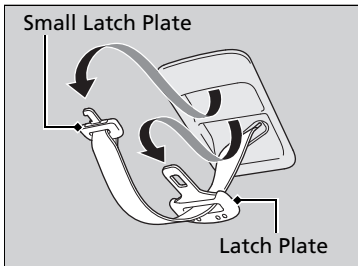

1. Pull out the seat belt's small latch plate and the latch plate from each holding slot in the ceiling.

2. Line up the triangle marks on the small latch plate and anchor buckle. Make sure the seat belt is not twisted. Attach the belt to the anchor buckle.

3. Insert the latch plate into the buckle. Properly fasten the seat belt the same way you fasten the lap/shoulder seat belt.

Seat Belt with Detachable Anchor

WARNING

Using the seat belt with the detachable anchor unlatched increases the chance of serious injury or death in a crash.

Before using the seat belt, make sure the detachable anchor is correctly latched.

To unlatch the detachable anchor, insert the latch plate into the slot on the side of the anchor buckle.

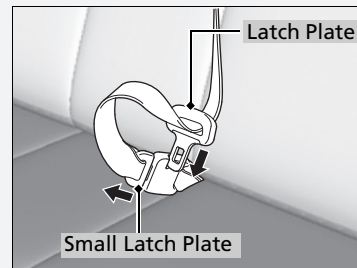

Advice for Pregnant Women

If you are pregnant, the best way to protect yourself and your unborn child when driving or riding in a vehicle is to always wear a seat belt and keep the lap part of the belt as low as possible across the hips.

Wear the shoulder belt across the chest avoiding the abdomen.



Wear the lap part of the belt as low as possible across the hips.

Advice for Pregnant Women

Each time you have a checkup, ask your doctor if it is okay for you to drive.

To reduce the risk of injuries to both you and your unborn child that can be caused by an inflating front airbag:

- When driving, sit upright and adjust the seat as far back as possible while allowing full control of the vehicle.
- When sitting in the front passenger's seat, adjust the seat as far back as possible.

Seat Belt Inspection

Regularly check the condition of your seat belts as follows:

- Pull each belt out fully, and look for frays, cuts, burns, and wear.
- Check that the latches work smoothly and the belts retract easily.
 - ▶ If a belt does not retract easily, cleaning the belt may correct the problem. Only use a mild soap and warm water. Do not use bleach or cleaning solvents. Make sure the belt is completely dry before allowing it to retract.

Any belt that is not in good condition or working properly will not provide proper protection and should be replaced as soon as possible.

A belt that has been worn during a crash may not provide the same level of protection in a subsequent crash. Have your seat belts inspected by a dealer after any collision.

▶▶ Seat Belt Inspection

WARNING

Not checking or maintaining seat belts can result in serious injury or death if the seat belts do not work properly when needed.

Check your seat belts regularly and have any problem corrected as soon as possible.

Airbag System Components

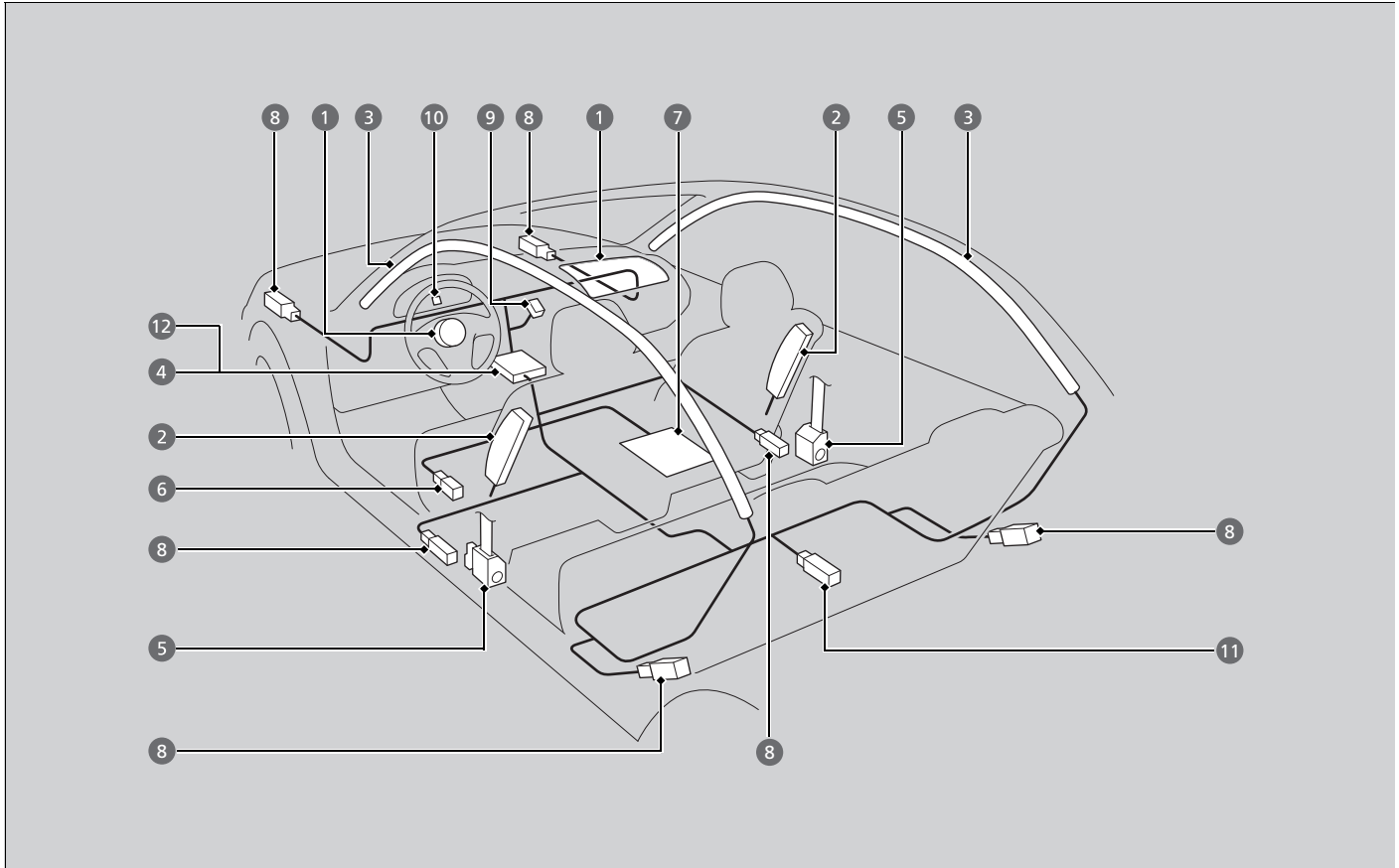

The front, front side, and side curtain airbags are deployed according to the direction and severity of impact. Both side curtain airbags are deployed in a rollover. The airbag system includes:

- 1 Two SRS (Supplemental Restraint System) front airbags. The driver's airbag is stored in the center of the steering wheel; the front passenger's airbag is stored in the dashboard. Both are marked **SRS AIRBAG**.
- 2 Two side airbags, one for the driver and one for a front passenger. The airbags are stored in the outer edges of the seat-backs. Both are marked **SIDE AIRBAG**.
- 3 Two side curtain airbags, one for each side of the vehicle. The airbags are stored in the ceiling, above the side windows. The front and rear pillars are marked **SIDE CURTAIN AIRBAG**.
- 4 An electronic control unit that continually monitors and can record information about the sensors, the airbag activators, the seat belt tensioners, and driver and front passenger seat belt use when the ignition switch is in ON *1.
- 5 Automatic front seat belt tensioners. The driver's and front passenger's seat belts incorporate sensors that detect whether or not they are fastened.
- 6 A driver's seat position sensor. If the seat is too far forward, the airbag will inflate with less force.
- 7 Weight sensors in the front passenger's seat. The front passenger's airbag will be turned off if the weight on the seat is 65 lbs (29 kg) or less (the weight of an infant or small child).
- 8 Impact sensors that can detect a moderate-to-severe front or side impact.
- 9 An indicator on the dashboard that alerts you that the front passenger's front airbag has been turned off.
- 10 An indicator on the instrument panel that alerts you to a possible problem with your airbag system or seat belt tensioners.
- 11 Safing Sensor
- 12 A rollover sensor that detects whether the vehicle is about to roll over.

*1: Models with the smart entry system have an **ENGINE START/STOP** button instead of an ignition switch.

Important Facts About Your Airbags

Airbags can pose serious hazards. To do their job, airbags must inflate with tremendous force. So, while airbags help save lives, they can cause burns, bruises, and other minor injuries, sometimes even fatal ones if occupants are not wearing their seat belts properly and sitting correctly.

What you should do: Always wear your seat belt properly, and sit upright and as far back from the steering wheel as possible while allowing full control of the vehicle. A front passenger should move their seat as far back from the dashboard as possible.

Remember, however, that no safety system can prevent all injuries or deaths that can occur in a severe crash, even when seat belts are properly worn and the airbags deploy.

Do not place hard or sharp objects between yourself and a front airbag.

Carrying hard or sharp objects on your lap, or driving with a pipe or other sharp object in your mouth, can result in injuries if your front airbag inflates.

Do not attach or place objects on the front airbag covers. Objects on the covers marked **SRS AIRBAG** could interfere with the proper operation of the airbags or be propelled inside the vehicle and hurt someone if the airbags inflate.

Important Facts About Your Airbags

Do not attempt to deactivate your airbags. Together, airbags and seat belts provide the best protection.

When driving, keep hands and arms out of the deployment path of the front airbag by holding each side of the steering wheel. Do not cross an arm over the airbag cover.

Types of Airbags

Your vehicle is equipped with three types of airbags:

- **Front airbags:** Airbags in front of the driver's and front passenger's seats.
- **Side airbags:** Airbags in the driver's and front passenger's seat-backs.
- **Side curtain airbags:** Airbags above the side windows.

Each is discussed in the following pages.

Front Airbags (SRS)

The front SRS airbags inflate in a moderate-to-severe frontal collision to help protect the head and chest of the driver and/or front passenger.

SRS (Supplemental Restraint System) indicates that the airbags are designed to supplement seat belts, not replace them. Seat belts are the occupant's primary restraint system.

Housing Locations

The front airbags are housed in the center of the steering wheel for the driver, and in the dashboard for the front passenger. Both airbags are marked **SRS AIRBAG**.

Types of Airbags

The airbags can inflate whenever the ignition switch is in ON *1.

After an airbag inflates in a crash, you may see a small amount of smoke. This is from the combustion process of the inflator material and is not harmful. People with respiratory problems may experience some temporary discomfort. If this occurs, get out of the vehicle as soon as it is safe to do so.

Front Airbags (SRS)

Dual-Stage, Multiple-Threshold Front Airbags (SRS)

Your vehicle is equipped with dual-stage, multiple-threshold front airbags (SRS).

During a frontal crash severe enough to cause one or both front airbags to deploy, the airbags can inflate at different rates, depending on the severity of the crash, whether the seat belts are latched, and/or other factors. Frontal airbags are designed to supplement the seat belts to help reduce the likelihood of head and chest injuries in frontal crashes.

*1: Models with the smart entry system have an **ENGINE START/STOP** button instead of an ignition switch.

■ Operation

Front airbags are designed to inflate during moderate-to-severe frontal collisions. When the vehicle decelerates suddenly, the sensors send information to the control unit which signals one or both front airbags to inflate.

A frontal collision can be either head-on or angled between two vehicles, or when a vehicle crashes into a stationary object, such as a concrete wall.

■ How the Front Airbags Work

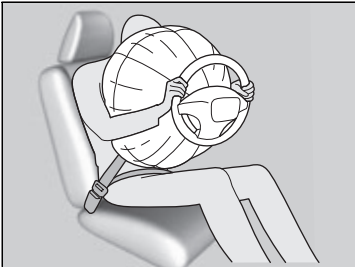

While your seat belt restrains your torso, the front airbag provides supplemental protection for your head and chest.

The front airbags deflate immediately so that they won't interfere with the driver's visibility or the ability to steer or operate other controls.

The total time for inflation and deflation is so fast that most occupants are not aware that the airbags deployed until they see them lying in front of them.

☒ How the Front Airbags Work

Although the driver's and front passenger's airbags normally inflate within a split second of each other, it is possible for only one airbag to deploy. This can happen if the severity of a collision is at the margin, or threshold that determines whether or not the airbags will deploy. In such cases, the seat belt will provide sufficient protection, and the supplemental protection offered by the airbag would be minimal.

■ When front airbags should not deploy

Minor frontal crashes: Front airbags were designed to supplement seat belts and help save lives, not to prevent minor scrapes, or even broken bones that might occur during a less than moderate-to-severe frontal crash.

Side impacts: Front airbags can provide protection when a sudden deceleration causes a driver or front passenger to move toward the front of the vehicle. Side airbags and side curtain airbags have been specifically designed to help reduce the severity of injuries that can occur during a moderate-to-severe side impact which can cause the driver or passenger to move toward the side of the vehicle.

Rear impacts: Head restraints and seat belts are your best protection during a rear impact. Front airbags cannot provide any significant protection and are not designed to deploy in such collisions.

Rollovers: Seat belts and, in vehicles equipped with a rollover sensor, side airbags and side curtain airbags offer the best protection in a rollover. Because front airbags could provide little if any protection, they are not designed to deploy during a rollover.

■ When front airbags deploy with little or no visible damage

Because the airbag system senses sudden deceleration, a strong impact to the vehicle framework or suspension might cause one or more of the airbags to deploy. Examples include running into a curb, the edge of a hole, or other low fixed object that causes a sudden deceleration in the vehicle chassis. Since the impact is underneath the vehicle, damage may not be readily apparent.

■ When front airbags may not deploy, even though exterior damage appears severe

Since crushable body parts absorb crash energy during an impact, the amount of visible damage does not always indicate proper airbag operation. In fact, some collisions can result in severe damage but no airbag deployment because the airbags would not have been needed or would not have provided protection even if they had deployed.

Advanced Airbags

Your front airbags have advanced features to help reduce the likelihood of airbag related injuries to smaller occupants.

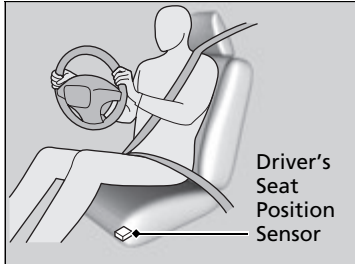

The driver's advanced front airbag system includes a seat position sensor.

If the seat is too far forward, the airbag inflates with less force, regardless of the severity of the impact.

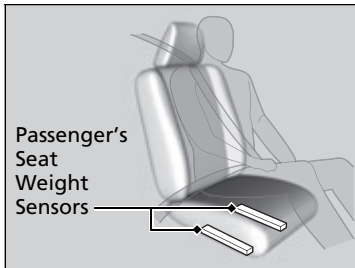

The passenger's advanced front airbag system has weight sensors.

Although we recommend against carrying an infant or small child in front, if the sensors detect the weight of a child (up to about 65 lbs or 29 kg), the system will automatically turn off the passenger's front airbag.

Advanced Airbags

If there is a problem with the driver's seat position sensor, the SRS indicator will come on and the airbag will inflate with full (normal) force, regardless of the driver's seating position.

For both advanced front airbags to work properly:

- Do not spill any liquid on or under the seats.
- Do not put any object under the passenger's seat.
- Make sure any objects are positioned properly on the floor. Improperly positioned objects can interfere with the advanced airbag sensors.
- All occupants should sit upright and wear their seat belts properly.
- Do not place any cover over the passenger side dashboard.

Side Airbags

The side airbags help protect the torso and pelvis of the driver or a front passenger during a moderate-to-severe side impact.

Housing Locations

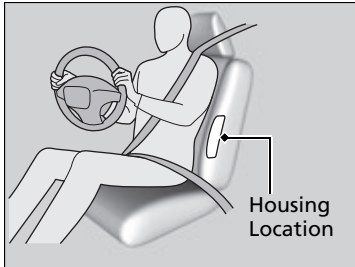

The side airbags are housed in the outside edge of the driver's and passenger's seat-backs.

Both are marked **SIDE AIRBAG**.

Operation

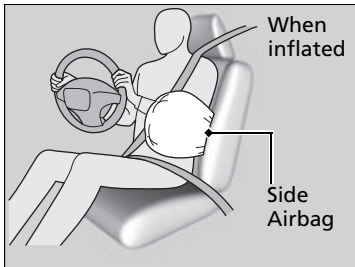

When the sensors detect a moderate-to-severe side impact, the control unit signals the side airbag on the impact side to immediately inflate.

Side Airbags

Do not let the front passenger lean sideways with their head in the deployment path of the side airbag. An inflating side airbag can strike with strong force and seriously injure the passenger.

Do not attach accessories on or near the side airbags. They can interfere with the proper operation of the airbags, or hurt someone if an airbag inflates.

If the impact is on the passenger's side, the airbag may not deploy when there is no passenger in the front passenger seat.

Do not cover or replace the front seat-back covers without consulting a dealer.

Improperly replacing or covering front seat-back covers can prevent your side airbags from properly deploying during a side impact.

■ When a side airbag deploys with little or no visible damage

Because the airbag system senses sudden acceleration, a strong impact to the side of the vehicle's framework can cause a side airbag to deploy. In such cases, there may be little or no damage, but the side impact sensors detected a severe enough impact to deploy the airbag.

■ When a side airbag may not deploy, even though visible damage appears severe

It is possible for a side airbag to not deploy during an impact that results in apparently severe damage. This can occur when the point of impact was toward the far front or rear of the vehicle, or when the vehicle's crushable body parts absorbed most of the crash energy. In either case, the side airbag would not have been needed nor provided protection even if it had deployed.

Side Curtain Airbags

The side curtain airbags help protect the heads of the driver and passengers in outer seating positions during a moderate-to-severe side impact. The side curtain airbags equipped in this vehicle are also designed to help reduce the likelihood of partial and complete ejection of vehicle occupants through side windows in crashes, particularly rollover crashes.

Housing Locations

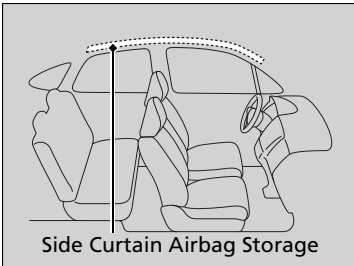

The side curtain airbags are located in the ceiling above the side windows on both sides of the vehicle.

Operation

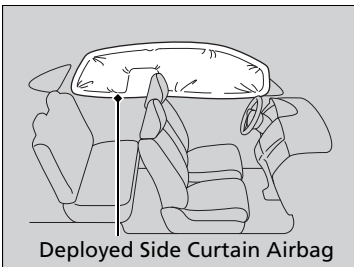

The side curtain airbag is designed to deploy in a rollover or a moderate-to-severe side impact.

Side Curtain Airbags

If the SRS control unit senses that your vehicle is about to rollover, it immediately deploys both side curtain airbags and activates both front seat belt tensioners.

If the impact is on the passenger's side, the passenger's side curtain airbag will inflate even if there are no occupants on that side of the vehicle.

To get the best protection from the side curtain airbags, occupants should wear their seat belts properly and sit upright and well back in their seats.

Do not attach any objects to the side windows or roof pillars as they can interfere with the proper operation of the side curtain airbags.

■ When side curtain airbags deploy in a frontal collision

One or both side curtain airbags may also inflate in a moderate-to-severe angled frontal collision.

Airbag System Indicators

If a problem occurs in the airbag system, the SRS indicator will come on and a message appears on the multi-information display*.

■ Supplemental Restraint System (SRS) Indicator

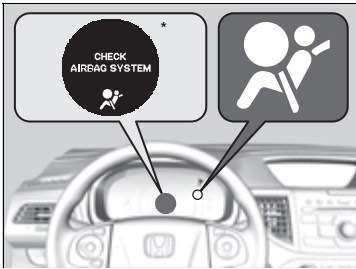

■ When the ignition switch is turned on **ON II***1

The indicator comes on for a few seconds, then goes off. This tells you the system is working properly.

If the indicator comes on at any other time, or does not come on at all, have the system checked by a dealer as soon as possible. If you don't, your airbags and seat belt tensioners may not work properly when they are needed.

*1: Models with the smart entry system have an **ENGINE START/STOP** button instead of an ignition switch.

* Not available on all models

⊠ Supplemental Restraint System (SRS) Indicator

⚠ WARNING

Ignoring the SRS indicator can result in serious injury or death if the airbag systems or tensioners do not work properly.

Have your vehicle checked by a dealer as soon as possible if the SRS indicator alerts you to a possible problem.

Continued

■ Passenger Airbag Off Indicator

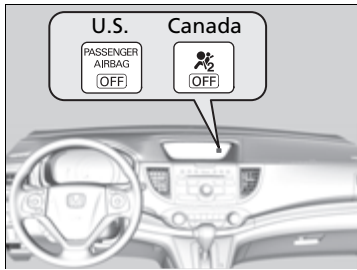

■ When the passenger airbag off indicator comes on

The indicator comes on to alert you that the passenger's front airbag has been turned off. This occurs when the weight sensors detect 65 lbs (29 kg) or less, the weight of an infant or small child, on the seat.

Infants and small children should always ride properly restrained in a back seat.

📄 **Child Safety** P. 54

Objects placed on the seat can also cause the indicator to come on.

If the front passenger seat is empty, the passenger's front airbag will not deploy and the indicator will not come on.

📄 Passenger Airbag Off Indicator

If the indicator comes on with no front passenger and no objects on the passenger's seat, or with an adult riding there, something may be interfering with the weight sensors, such as:

- An object hanging on the seat or in the seat-back pocket.
- A child seat or other object pressing against the rear of the seat-back.
- A rear passenger pushing or pulling on the back of the front passenger's seat.
- The front seat or seat-back is forced back against an object on the seat or floor behind it.
- An object placed under the front passenger's seat.

If none of these conditions exist, have your vehicle checked by a dealer as soon as possible.

The passenger airbag off indicator may come on and goes off repeatedly if the total weight on the seat is near the airbag cutoff threshold.

Airbag Care

You do not need to, and should not, perform any maintenance on or replace any airbag system components yourself. However, you should have your vehicle inspected by a dealer in the following situations:

■ When the airbags have deployed

If an airbag has inflated, the control unit and other related parts must be replaced. Similarly, once an automatic seat belt tensioner has been activated, it must be replaced.

■ When the vehicle has been in a moderate-to-severe collision

Even if the airbags did not inflate, have your dealer inspect the following: the driver's seat position sensor, weight sensors in the passenger's seat, front seat belt tensioners, and each seat belt that was worn during the crash.

■ Do not remove or modify a front seat without consulting a dealer

This would likely disable the driver's seat position sensor or the weight sensors in the passenger's seat. If it is necessary to remove or modify a front seat to accommodate a person with disabilities, contact a Honda dealer, or for U.S. vehicles, American Honda Automobile Customer Service at 800-999-1009 and for Canadian vehicles, Honda Canada Customer Relations at 888-9-HONDA-9.

⌘ Airbag Care

We recommend against the use of salvaged airbag system components, including the airbag, tensioners, sensors, and control unit.

Protecting Child Passengers

Each year, many children are injured or killed in vehicle crashes because they are either unrestrained or not properly restrained. In fact, vehicle accidents are the number one cause of death of children ages 12 and under.

To reduce the number of child deaths and injuries, every state, Canadian province and territory requires that infants and children be properly restrained when they ride in a vehicle.

Children should sit properly restrained in a rear seat. This is because:

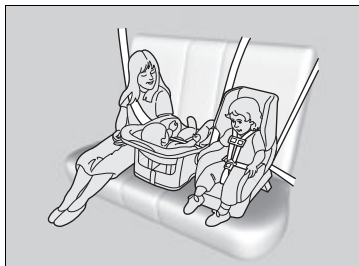

- An inflating front or side airbag can injure or kill a child sitting in the front seat.
- A child in the front seat is more likely to interfere with the driver's ability to safely control the vehicle.
- Statistics show that children of all sizes and ages are safer when they are properly restrained in a rear seat.

Protecting Child Passengers

WARNING

Children who are unrestrained or improperly restrained can be seriously injured or killed in a crash.

Any child too small for a seat belt should be properly restrained in a child seat. A larger child should be properly restrained with a seat belt, using a booster seat if necessary.

The National Highway Traffic Safety Administration and Transport Canada recommend that all children ages 12 and under be properly restrained in a rear seat. Some states or provinces/territories have laws restricting where children may ride.

- Any child who is too small to wear a seat belt correctly must be restrained in an approved child seat that is properly secured to the vehicle using either the lap belt portion of the lap/shoulder belt or the lower anchors of the LATCH system.
- Never hold a child on your lap because it is impossible to protect them in the event of a collision.
- Never put a seat belt over yourself and a child. During a crash, the belt would likely press deep into the child and cause serious or fatal injuries.
- Never let two children use the same seat belt. Both children could be very seriously injured in a crash.
- Do not allow children to operate the doors, windows or seat adjustments.
- Do not leave children in the vehicle unattended, especially in hot weather when the inside of the vehicle can get hot enough to kill them. They could also activate vehicle controls causing it to move unexpectedly.

▶▶ Protecting Child Passengers

⚠ WARNING

Allowing a child to play with a seat belt or wrap one around their neck can result in serious injury or death.

Instruct children not to play with any seat belt and make sure any unused seat belt a child can reach is buckled, fully retracted, and locked.

To deactivate a lockable retractor, release the buckle and allow the seat belt to wind up all the way.

To remind you of the passenger's front airbag hazards and child safety, your vehicle warning came with a label on the dashboard (U.S. models) and has labels on the front visors. Please read and follow the instructions on these labels.

▶▶ **Safety Labels** P. 68

Safety of Infants and Small Children

■ Protecting Infants

An infant must be properly restrained in a rear-facing, reclining child seat until the infant reaches the seat manufacturer's weight or height limit for the seat, and the infant is at least one year old.

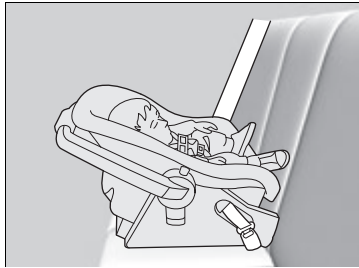

■ Positioning a rear-facing child seat

Child seats must be placed and secured in a rear seating position.

When properly installed, a rear-facing child seat may prevent the driver or a front passenger from moving their seat all the way back, or from locking their seat-back in the desired position.

It can also interfere with proper operation of the passenger's advanced front airbag system.

➤ **Airbags** P. 41

If this occurs, we recommend that you install the child seat directly behind the front passenger's seat, move the seat as far forward as needed, and leave it unoccupied. Or, you may wish to get a smaller rear-facing child seat.

▶▶ Protecting Infants

⚠ WARNING

Placing a rear-facing child seat in the front seat can result in serious injury or death during a crash.

Always place a rear-facing child seat in the rear seat, not the front.

Rear-facing child seats should never be installed in a forward facing position.

Always refer to the child seat manufacturer's instructions before installation.

Protecting Smaller Children

If a child is at least one year old and within the weight range indicated by the child seat manufacturer, the child should be properly restrained in a firmly secured forward-facing child seat.

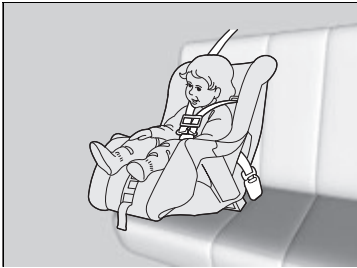

Forward-facing child seat placement

We strongly recommend placing a forward-facing child seat in a rear seating position.

Placing a forward-facing child seat in the front seat can be hazardous, even with advanced front airbags that automatically turn the passenger's front airbag off. A rear seat is the safest place for a child.

Protecting Smaller Children

⚠ WARNING

Placing a forward-facing child seat in the front seat can result in serious injury or death if the front airbag inflates.

If you must place a forward-facing child seat in front, move the vehicle seat as far back as possible, and properly restrain the child.

Educate yourself about the laws and regulations regarding child seat use where you are driving, and follow the child seat manufacturer's instructions.

Many experts recommend use of a rear-facing seat for a child up to two years old if the child's height and weight are appropriate for a rear-facing seat.

■ Selecting a Child Seat

Most child seats are LATCH-compatible (Lower Anchors and Tethers for Children). Some have a rigid-type connector while others have a flexible-type connector. Both are equally easy to use. Some existing and previously owned child seats can only be installed using the seat belt. Whichever type you choose, follow the child seat manufacturer's use and care instructions as well as the instructions in this manual. Proper installation is key to maximizing your child's safety.

In seating positions and vehicles not equipped with LATCH, a LATCH-compatible child seat can be installed using the seat belt and a top tether for added security. This is because all child seats are required to be designed so that they can be secured with a lap belt or the lap part of a lap/shoulder belt. In addition, the child seat manufacturer may advise that a seat belt be used to attach a LATCH-compatible seat once a child reaches a specified weight. Please read the child seat owner's manual for proper installation instructions.

■ Important consideration when selecting a child seat

Make sure the child seat meets the following three requirements:

- The child seat is the correct type and size for the child.
- The child seat is the correct type for the seating position.
- The child seat is compliant with Federal Motor Vehicle Safety Standard 213 or Canadian Motor Vehicle Safety Standard 213.

► Selecting a Child Seat

Installation of a LATCH-compatible child seat is simple.

LATCH-compatible child seats have been developed to simplify the installation process and reduce the likelihood of injuries caused by incorrect installation.

Installing a LATCH-Compatible Child Seat

A LATCH-compatible child seat can be installed in rear seats. A child seat is attached to the lower anchors with either the rigid or flexible type of connectors.

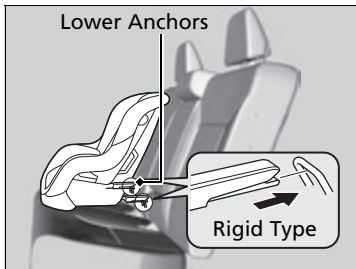
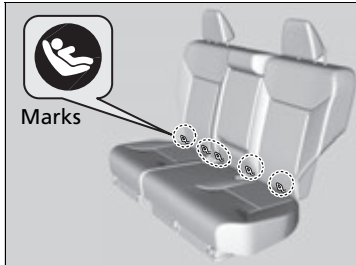

1. Locate the lower anchors under the marks.

2. Place the child seat on the vehicle seat, then attach the child seat to the lower anchors according to the instructions that came with the child seat.

▶ When installing the child seat, make sure that the lower anchors are not obstructed by the seat belt or any other object.

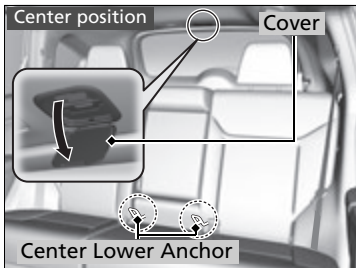
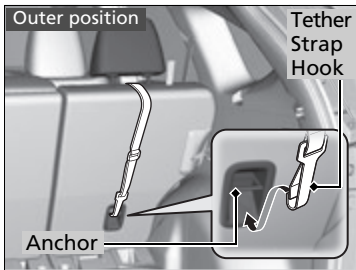
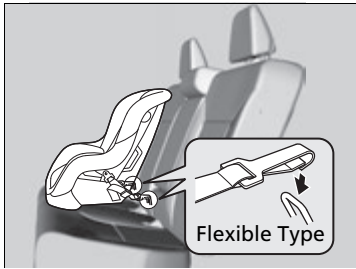

▶▶ Installing a LATCH-Compatible Child Seat

For your child's safety, when using a child seat installed using the LATCH system, make sure that the child seat is properly secured to the vehicle. A child seat that is not properly secured will not adequately protect a child in a crash and may cause injury to the child or other vehicle occupants.

Outer position

3. Put the head restraint to its upper-most position, then route the tether strap between the head restraint legs, and secure the tether strap hook onto the anchor.
4. Go to step 7.

Center position

3. Lower the head restraint to its lowest position.
4. Open the anchor cover.

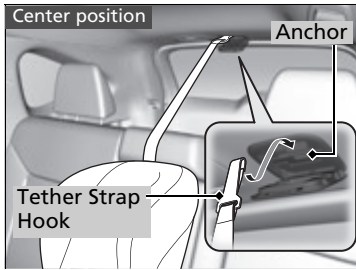

5. Route the tether strap over the head restraint. Make sure the strap is not twisted.
6. Secure the tether strap hook onto the anchor.

All models

7. Tighten the tether strap as instructed by the child seat manufacturer.
8. Make sure the child seat is firmly secured by rocking it forward and back and side to side; little movement should be felt.
9. Make sure any unused seat belt that a child can reach is buckled, the lockable retractor is activated, and the belt is fully retracted and locked.

■ Installing a Child Seat with a Lap/Shoulder Seat Belt

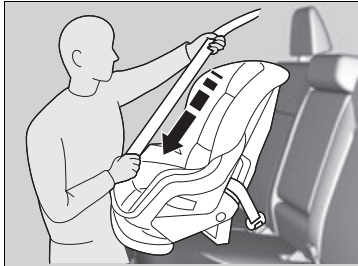
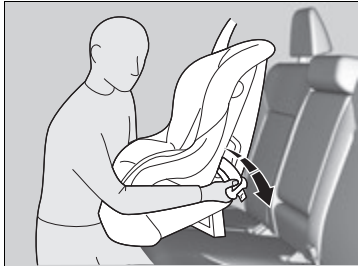

1. Place the child seat on the vehicle seat.
2. Route the seat belt through the child seat according to the seat manufacturer's instructions, and insert the latch plate into the buckle.
 - Insert the latch plate fully until it clicks.
3. Slowly pull the shoulder part of the belt all the way out until it stops. This activates the lockable retractor.
4. Let the seat belt if it is completely retracted it unlocks wind up into the retractor, then try to pull it out to make sure the retractor is locked.
 - If you are able to pull the shoulder belt out, the lockable retractor is not activated. Pull the seat belt all the way out, and repeat steps 3 – 4.

▣ Installing a Child Seat with a Lap/Shoulder Seat Belt

A child seat that is not properly secured will not adequately protect a child in a crash and may cause injury to the child or other vehicle occupants.

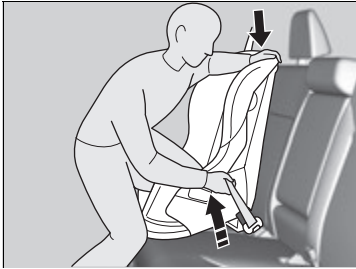

5. Grab the shoulder part of the seat belt near the buckle, and pull up to remove any slack from the lap part of the belt.

▶ When doing this, place your weight on the child seat and push it into the vehicle seat.



6. Make sure the child seat is firmly secured by rocking it forward and back and side to side; little movement should be felt.

7. Make sure any unused seat belt that a child can reach is buckled, the lockable retractor is activated, and the belt is fully retracted and locked.

■ Adding Security with a Tether

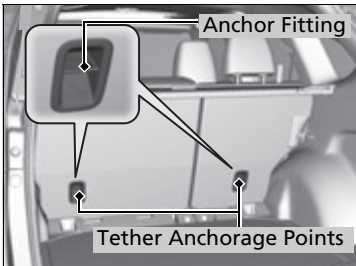

Two tether anchorage points are provided behind the rear outer seating positions and one in the ceiling for the rear center.

If you have a child restraint system that comes with a tether but can be installed with a seat belt, the tether may be used for additional security.

▣ Installing a Child Seat with a Lap/Shoulder Seat Belt

To deactivate a lockable retractor, release the buckle and allow the seat belt to wind up all the way.

▣ Adding Security with a Tether

Since a tether can provide additional security to the lap/shoulder seat belt installation, we recommend using a tether whenever one is available.

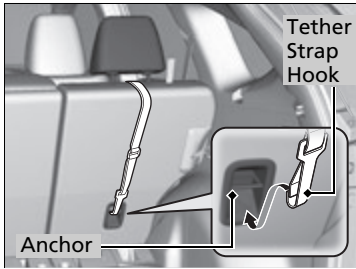

■ Using an outer anchor

1. Put the head restraint to its upper-most position, then route the tether strap through the head restraint legs. Make sure the strap is not twisted.
2. Secure the tether strap hook onto the anchor.
3. Tighten the tether strap as instructed by the child seat manufacturer.

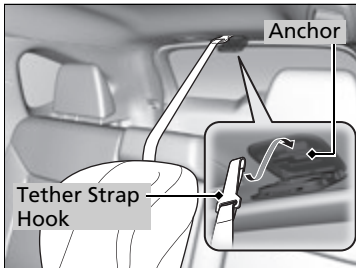

■ Using the center anchor

1. Lower the head restraint to its lowest position.
2. Open the anchor cover.
3. Route the tether strap over the head restraint. Make sure the strap is not twisted.
4. Secure the tether strap hook onto the anchor.
5. Tighten the tether strap as instructed by the child seat manufacturer.

Safety of Larger Children

■ Protecting Larger Children

The following pages give instructions on how to check proper seat belt fit, what kind of booster seat to use if one is needed, and important precautions for a child who must sit in front.

■ Checking Seat Belt Fit

When a child is too big for a child seat, secure the child in a rear seat using the lap/shoulder seat belt. Have the child sit upright and all the way back, then answer the following questions.



■ Checklist

- Do the child's knees bend comfortably over the edge of the seat?
- Does the shoulder belt cross between the child's neck and arm?
- Is the lap part of the seat belt as low as possible, touching the child's thighs?
- Will the child be able to stay seated like this for the whole trip?

If you answer yes to all these questions, the child is ready to wear the lap/shoulder seat belt correctly. If you answer no to any question, the child needs to ride on a booster seat until the seat belt fits properly without a booster seat.

▶▶ Safety of Larger Children

⚠ WARNING

Allowing a child age 12 or under to sit in front can result in injury or death if the passenger's front airbag inflates.

If a larger child must ride in front, move the vehicle seat as far to the rear as possible, have the child sit up properly and wear the seat belt properly, using a booster seat if needed.

Booster Seats



If a lap/shoulder seat belt cannot be used properly, position the child in a booster seat in a rear seating position. For the child's safety, check that the child meets the booster seat manufacturer's recommendations.

Protecting Larger Children-Final Checks

Your vehicle has a rear seat where children can be properly restrained. If you ever have to carry a group of children, and a child must ride in front:

- Make sure you read and fully understand the instructions and safety information in this manual.
- Move the front passenger seat as far back as possible.
- Have the child sit upright and well back in the seat.
- Check that the seat belt is properly positioned so that the child is secure in the seat.

Monitoring child passengers

We strongly recommend that you keep an eye on child passengers. Even older, more mature children sometimes need to be reminded to fasten their seat belts and sit up properly.

Booster Seats

When installing a booster seat, make sure to read the instructions that came with it, and install the seat accordingly.

There are high- and low-type booster seats. Choose a booster seat that allows the child to wear the seat belt correctly.

Some U.S. states, and Canadian provinces and territories require children to use a booster seat until they reach a given age or weight (e.g. six years or 60 lbs). Be sure to check current laws in the state or province, or territory where you intend to drive.

Carbon Monoxide Gas

The engine exhaust from this vehicle contains carbon monoxide, a colorless, odorless, and highly toxic gas. As long as you properly maintain your vehicle, carbon monoxide gas will not get into the interior.

■ Have the exhaust system inspected for leaks whenever

- The exhaust system is making an unusual noise.
- The exhaust system may have been damaged.
- The vehicle is raised for an oil change.

When you operate a vehicle with the tailgate open, airflow can pull exhaust gas into the interior and create a hazardous condition. If you must drive with the tailgate open, open all the windows and set the heating and cooling system*/climate control system* as shown below.

1. Select the fresh air mode.
2. Select the  mode.
3. Set the fan speed to high.
4. Set the temperature control to a comfortable setting.

Adjust the heating and cooling system*/climate control system* in the same manner if you sit in your parked vehicle with the engine running.

* Not available on all models

Carbon Monoxide Gas

⚠ WARNING

Carbon monoxide gas is toxic. Breathing it can cause unconsciousness and even kill you.

Avoid any enclosed areas or activities that expose you to carbon monoxide.

An enclosed area such as a garage can quickly fill up with carbon monoxide gas. Do not run the engine with the garage door closed. Even when the garage door is open, drive out of the garage immediately after starting the engine.

Label Locations

These labels are in the locations shown. They warn you of potential hazards that can cause serious injury or death. Read these labels carefully.

If a label comes off or becomes hard to read (except for the U.S. dashboard label which may be removed by the owner), contact a dealer for a replacement.

Sun Visor
U.S. models

▲ WARNING

EVEN WITH ADVANCED AIR BAGS

- ▶ Children can be killed or seriously injured by the air bag.
- ▶ This seat is for the child seat or child.
- ▶ Never put a rear-facing child seat in the front.
- ▶ Always use seat belts and child restraints.
- ▶ See owner's manual for more information about air bags.



Canadian models

CAUTION

TO AVOID SERIOUS INJURY:

- FOR MAXIMUM SAFETY PROTECTION IN ALL TYPES OF CRASHES YOU MUST ALWAYS WEAR YOUR SAFETY BELT.
- DO NOT INSTALL REARWARD-FACING CHILD SEATS IN ANY FRONT PASSENGER SEAT POSITION.
- DO NOT SIT OR LEAN UNNECESSARILY CLOSE TO THE AIR BAG.
- DO NOT PLACE ANY OBJECTS OVER THE AIR BAG OR BETWEEN THE AIR BAG AND YOURSELF.
- SEE THE OWNER'S MANUAL FOR FURTHER INFORMATION AND EXPLANATIONS.

PRECAUTIONS:

POUR EVITER DES BLESSURES GRAVES:

- POUR PROFITER D'UNE PROTECTION MAXIMALE LORS D'UNE COLLISION BOUCLEZ TOUJOURS VOTRE CEINTURE DE SECURITE.
- N'INSTALLEZ JAMAIS UN SIEGE POUR ENFANTS FAISANT FACE A L'ARRIERE SUR LE SIEGE DU PASSENGER AVANT.
- NE VOUS APPUYEZ PAS ET NE VOUS ASSOYEZ PAS PRES DU COUSSIN GONFLABLE.
- NE DEPOSEZ AUCUN OBJET SUR LE COUSSIN GONFLABLE ET VOUS.
- LISEZ LE GUIDE UTILISATEUR POUR DE PLUS AMPLES RENSEIGNEMENTS.

Dashboard
U.S. models only

This Vehicle is Equipped with Advanced Air Bags

Even with Advanced Air Bags

Children can be killed or seriously injured by the air bag. The back seat is the safest place for children. Never put a rear-facing child seat in the front. Always use seat belts and child restraints. See owner's manual for more information about air bags.

To be removed by owner only.

Radiator Cap

DANGER
WARNING

危險
警告

▶ NEVER OPEN WHEN HOT
Hot coolant will scald you.
▶ N'OUVREZ PAS QUAND CHAUD.
Hot fluid may cause serious injury.
▶ 熱い液体を開くと危険です。

1.1

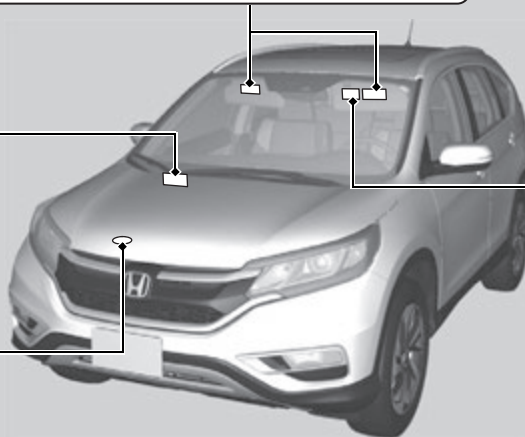

Sun Visor
U.S. models only

▲ WARNING: HIGHER ROLLOVER RISK



Avoid Abrupt Maneuvers and Excessive Speed.
Always Buckle Up.
See Owner's Manual For Further Information.



Instrument Panel







This chapter describes the buttons, indicators, and gauges that are used while driving.





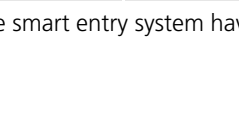
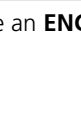

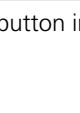
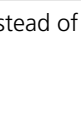

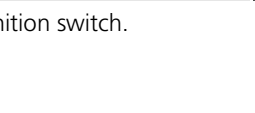
| | |
|---|-----|
| Indicators | 70 |
| Display Warning and Information Messages* | 88 |
| Gauges and Displays | |
| Gauges | 94 |
| Information Display* | 95 |
| Multi-Information Display* | 98 |
| intelligent Multi-Information Display (i-MID) | 113 |

* Not available on all models

Indicators











| Indicator | Name | On/Blinking | Explanation | Message * |
|--|--|---|--|---|
|  | Parking Brake and Brake System Indicator (Red) | <ul style="list-style-type: none"> Comes on for a few seconds when you turn the ignition switch to ON ^{*1}, then goes off if the parking brake has been released. Comes on when the parking brake is applied, and goes off when it is released. Comes on when the brake fluid level is low. Comes on if there is a problem with the brake system. The beeper sounds and the indicator comes on if you drive with the parking brake not fully released. | <ul style="list-style-type: none"> Comes on while driving - Make sure the parking brake is released. Check the brake fluid level. <ul style="list-style-type: none"> ➤ What to do when the indicator comes on while driving P. 511 Comes on along with the ABS indicator - Have your vehicle checked by a dealer. <ul style="list-style-type: none"> ➤ If the Brake System Indicator (Red) Comes On P. 511 |       |
|  | Low Oil Pressure Indicator | <ul style="list-style-type: none"> Comes on when you turn the ignition switch to ON ^{*1}, and goes off when the engine starts. Comes on when the engine oil pressure is low. | <ul style="list-style-type: none"> Comes on while driving - Immediately stop in a safe place. <ul style="list-style-type: none"> ➤ If the Low Oil Pressure Indicator Comes On P. 509 |  |

*1: Models with the smart entry system have an **ENGINE START/STOP** button instead of an ignition switch.









| Indicator | Name | On/Blinking | Explanation | Message* |
|---|--------------------------------|--|--|---|
|  | Malfunction Indicator Lamp | <ul style="list-style-type: none"> • Comes on when you turn the ignition switch to ON ^{*1}, and goes off when the engine starts, or after several seconds if the engine did not start. If "readiness codes" have not been set, it blinks five times before it goes off. • Comes on if there is a problem with the emissions control systems. • Blinks when a misfire in the engine's cylinders is detected. | <ul style="list-style-type: none"> • Readiness codes are part of the on board diagnostics for the emissions control systems. <ul style="list-style-type: none"> ➤ Testing of Readiness Codes P. 525 • Comes on while driving - Have your vehicle checked by a dealer. • Blinks while driving - Stop in a safe place where there are no flammable objects. Stop the engine for 10 minutes or more, and wait for it to cool down. Then, take your vehicle to a dealer. <ul style="list-style-type: none"> ➤ If the Malfunction Indicator Lamp Comes On or Blinks P. 510 |  |
|  | Charging System Indicator | <ul style="list-style-type: none"> • Comes on when you turn the ignition switch to ON ^{*1}, and goes off when the engine starts. • Comes on when the battery is not charging. | <ul style="list-style-type: none"> • Comes on while driving - Turn off the heating and cooling system*/climate control system* and rear defogger to reduce electricity consumption. <ul style="list-style-type: none"> ➤ If the Charging System Indicator Comes On P. 509 |  |
|  | Shift Lever Position Indicator | <ul style="list-style-type: none"> • Indicates the current shift lever position. | <ul style="list-style-type: none"> ➤ Shifting P. 372 | — |

*1: Models with the smart entry system have an **ENGINE START/STOP** button instead of an ignition switch.

* Not available on all models







| Indicator | Name | On/Blinking | Explanation | Message * |
|---|------------------------------|--|---|--|
|  | Transmission Indicator | <ul style="list-style-type: none"> Comes on for a few seconds when you turn the ignition switch to ON *1, then goes off. Blinks if the transmission system has a problem. | <ul style="list-style-type: none"> Blinks while driving - Avoid sudden starts and acceleration and have your vehicle checked by a dealer immediately. |  |
|  | Seat Belt Reminder Indicator | <ul style="list-style-type: none"> Comes on and the beeper sounds if you are not wearing a seat belt when you turn the ignition switch to ON *1. If the front passenger is not wearing a seat belt, the indicator comes on a few seconds later. Blinks while driving if either you or the front passenger has not fastened a seat belt. The beeper sounds and the indicator blinks at regular intervals. | <ul style="list-style-type: none"> The beeper stops and the indicator goes off when you and the front passenger fasten their seat belts. Stays on after you or the front passenger has fastened the seat belt - A detection error may have occurred in the sensor. Have your vehicle checked by a dealer.  Seat Belt Reminder P. 34 |   |
|  | Low Fuel Indicator | <ul style="list-style-type: none"> Comes on when the fuel reserve is running low (approximately 2.3 U.S. gal./8.6 Liter left). Blinks if there is a problem with the fuel gauge. | <ul style="list-style-type: none"> Comes on - Refuel your vehicle as soon as possible. Blinks - Have your vehicle checked by a dealer. |  |

*1: Models with the smart entry system have an **ENGINE START/STOP** button instead of an ignition switch.







| Indicator | Name | On/Blinking | Explanation | Message* |
|---|---|--|---|---|
|  | Anti-lock Brake System (ABS) Indicator | <ul style="list-style-type: none"> Comes on for a few seconds when you turn the ignition switch to ON *1, then goes off. If it comes on at any other time, there is a problem with the ABS. | <ul style="list-style-type: none"> Stays on constantly - Have your vehicle checked by a dealer. With this indicator on, your vehicle still has normal braking ability but no anti-lock function. <ul style="list-style-type: none"> ➤ Anti-lock Brake System (ABS) P. 414 |  |
|  | Supplemental Restraint System Indicator | <ul style="list-style-type: none"> Comes on for a few seconds when you turn the ignition switch to ON *1, then goes off. Comes on if a problem with any of the following is detected: <ul style="list-style-type: none"> - Supplemental restraint system - Side airbag system - Side curtain airbag system - Seat belt tensioner | <ul style="list-style-type: none"> Stays on constantly or does not come on at all - Have your vehicle checked by a dealer. |  |
| AWD | All-Wheel Drive (AWD) System Indicator* | <ul style="list-style-type: none"> Comes on for a few seconds when you turn the ignition switch to ON *1, then goes off. Comes on if there is a problem with the AWD. Blinks when the AWD system is overheated. The system is inactive. | <ul style="list-style-type: none"> Stays on constantly - the engine drives the front wheels only in this state. Have your vehicle checked by a dealer. Blinks while driving - the engine drives the front wheels only in this state. Stop in a safe place, shift to , and idle the engine until the indicator goes off. If the indicator does not stop blinking, take your vehicle to a dealer. <ul style="list-style-type: none"> ➤ Real Time AWD with Intelligent Control System™* P. 407 |  |

*1: Models with the smart entry system have an **ENGINE START/STOP** button instead of an ignition switch.

* Not available on all models



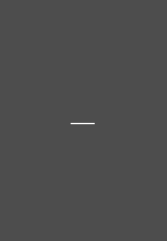

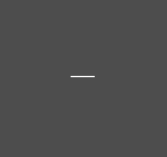



| Indicator | Name | On/Blinking | Explanation | Message * |
|---|--|--|--|---|
|  | Vehicle Stability Assist (VSA®) System Indicator | <ul style="list-style-type: none"> • Comes on for a few seconds when you turn the ignition switch to ON *1, then goes off. • Blinks when VSA® is active. • Comes on if there is a problem with the VSA® system. • Comes on if there is a problem with the hill start assist system. | <ul style="list-style-type: none"> • Stays on constantly - Have your vehicle checked by a dealer. <ul style="list-style-type: none"> ➤ Vehicle Stability Assist (VSA®), aka Electronic Stability Control (ESC), System P. 403 | <div style="text-align: center;">  <p>CHECK VSA SYSTEM</p> </div> <div style="text-align: center; margin-top: 10px;">  <p>CHECK HILL START ASSIST SYSTEM</p> </div> |
|  | VSA® OFF Indicator | <ul style="list-style-type: none"> • Comes on for a few seconds when you turn the ignition switch to ON *1, then goes off. • Comes on when you deactivate VSA®. | <ul style="list-style-type: none"> ➤ VSA® On and Off P. 404 | — |

*1: Models with the smart entry system have an **ENGINE START/STOP** button instead of an ignition switch.





| Indicator | Name | On/Blinking | Explanation | Message* |
|---|--|---|--|--|
|  | <p>Models with multi-information display</p> <p>Door and Tailgate Open Indicator</p> | <ul style="list-style-type: none"> Comes on for a few seconds when you set the power mode to ON, then goes off. Comes on if any door or the tailgate is not completely closed. The beeper sounds and the indicator comes on if any door or the tailgate is opened while driving. | <ul style="list-style-type: none"> Goes off when all doors and the tailgate are closed. |   |
| | <p>Models without multi-information display</p> <p>Door Open Indicator</p> | <ul style="list-style-type: none"> Comes on for a few seconds when you turn the ignition switch to ON *1, then goes off. Comes on if any door is not completely closed. The beeper sounds and the indicator comes on if any door is opened while driving. | <ul style="list-style-type: none"> Goes off when all doors are closed. |  |
|  | <p>Models without multi-information display</p> <p>Tailgate Open Indicator</p> | <ul style="list-style-type: none"> Comes on for a few seconds when you turn the ignition switch to ON *1, then goes off. Comes on if the tailgate is not completely closed. | <ul style="list-style-type: none"> Goes off when the tailgate is closed. |  |

*1: Models with the smart entry system have an **ENGINE START/STOP** button instead of an ignition switch.











* Not available on all models

| Indicator | Name | On/Blinking | Explanation | Message * |
|---|--|--|---|--|
|  | Electric Power Steering (EPS) System Indicator | <ul style="list-style-type: none"> Comes on when you turn the ignition switch to ON ^{*1}, and goes off when the engine starts. Comes on if there is a problem with the EPS system. | <ul style="list-style-type: none"> Stays on constantly or does not come on at all - Have your vehicle checked by a dealer. <ul style="list-style-type: none"> ➤ If the Electric Power Steering (EPS) System Indicator Comes On P. 511 |  |
|  | Low Tire Pressure/TPMS Indicator | <ul style="list-style-type: none"> Comes on for a few seconds when you turn the ignition switch to ON ^{*1}, then goes off. May come on briefly if the ignition switch is turned to ON ^{*1} and the vehicle is not moved within 45 seconds, to indicate the calibration process is not yet complete. Comes on when: <ul style="list-style-type: none"> - One or more tires' pressures are determined to be significantly low. - The system has not been calibrated. Blinks for about one minute, and then stays on if there is a problem with the TPMS, or when a compact spare tire is temporarily installed. | <ul style="list-style-type: none"> Comes on while driving - Stop in a safe place, check tire pressures, and inflate the tire(s) if necessary. Stays on after the tires are inflated to the recommended pressures - The system needs to be calibrated. <ul style="list-style-type: none"> ➤ TPMS Calibration P. 408 Blinks and remains on - Have your vehicle checked by a dealer. If the vehicle is fitted with a compact spare, get your regular tire repaired or replaced and put back on your vehicle as soon as you can. |   |





*1: Models with the smart entry system have an **ENGINE START/STOP** button instead of an ignition switch.

| Indicator | Name | On/Blinking | Explanation | Message* |
|---|---|--|---|----------|
|  | Turn Signal and Hazard Warning Indicators | <ul style="list-style-type: none"> • Blinks when you operate the turn signal lever. • Blinks along with all turn signals if you press the hazard warning button. | <ul style="list-style-type: none"> • Does not blink or blinks rapidly - A turn signal light bulb has blown. Change the bulb immediately.  Replacing Light Bulbs P. 467 | — |
|  | High Beam Indicator | <ul style="list-style-type: none"> • Comes on when the high beam headlights are on. | — | — |
|  | Lights On Indicator | <ul style="list-style-type: none"> • Comes on whenever the light switch is on, or in AUTO* when the exterior lights are on. | <ul style="list-style-type: none"> • If you remove the key from the ignition switch*¹ while the lights are on, a chime sounds when the driver's door is opened. | — |
|  | Fog Light Indicator* | <ul style="list-style-type: none"> • Comes on when the fog lights are on. | — | — |





*1: Models with the smart entry system have an **ENGINE START/STOP** button instead of an ignition switch.

| Indicator | Name | On/Blinking | Explanation | Message * |
|---|----------------------------------|--|--|---|
|  | Immobilizer System Indicator | <ul style="list-style-type: none"> Comes on briefly when you turn the ignition switch to ON *1, then goes off. Comes on if the immobilizer system cannot recognize the key information. | <ul style="list-style-type: none"> Blinks - You cannot start the engine. Turn the ignition switch to LOCK *1, pull the key out, and then insert the key and turn it to ON *1 again. Repeatedly blinks - The system may be malfunctioning. Have your vehicle checked by a dealer. Do not attempt to alter this system or add other devices to it. Electrical problems can occur. | — |
|  | Security System Alarm Indicator* | <ul style="list-style-type: none"> Blinks when the security system alarm has been set. |  Security System Alarm * P. 149 | — |
|  | ECON Mode Indicator | <ul style="list-style-type: none"> Comes on when you turn the ignition switch to ON *1, then goes off. Comes on when ECON mode is on. |  ECON Button P. 374 |  |







*1: Models with the smart entry system have an **ENGINE START/STOP** button instead of an ignition switch.

| Indicator | Name | On/Blinking | Explanation | Message* |
|---|-------------------------------------|---|---|----------|
|  | CRUISE MAIN Indicator* | <ul style="list-style-type: none"> Comes on when you press the CRUISE button. | <ul style="list-style-type: none"> ➤ Cruise Control* P. 375 | — |
|  | CRUISE CONTROL Indicator* | <ul style="list-style-type: none"> Comes on when you have set a speed for cruise control. | <ul style="list-style-type: none"> ➤ Cruise Control* P. 375 | — |
|  | Washer Level Indicator* | <ul style="list-style-type: none"> Comes on when the washer fluid gets low. | <ul style="list-style-type: none"> Refill washer fluid. ➤ Refilling Window Washer Fluid P. 461 | — |
|  | Maintenance Minder Indicator* | <ul style="list-style-type: none"> Comes on when you turn the ignition switch to ON ^{*1}, then goes off. Comes on when the scheduled maintenance is due soon. | <ul style="list-style-type: none"> ➤ Maintenance Minder™ P. 439 | — |

*1: Models with the smart entry system have an **ENGINE START/STOP** button instead of an ignition switch.

| Indicator | Name | On/Blinking | Explanation | Message * |
|---|-------------------------------|---|--|--|
|  | Smart Entry System Indicator* | <ul style="list-style-type: none"> Comes on for a few seconds when you set the power mode to ON. Comes on as soon as a problem is detected in the smart entry system or push button starting system. | <ul style="list-style-type: none"> Stays on constantly or does not come on at all - Have your vehicle checked by a dealer. |   |
|  | Starter System Indicator* | <ul style="list-style-type: none"> Comes on for a few seconds when you turn the ignition switch to ON *1, then goes off. Comes on if the starter system has a problem. | <ul style="list-style-type: none"> As a temporary measure, press and hold the ENGINE START/STOP button for up to 15 seconds while pressing the brake pedal and manually start the engine. Have your vehicle checked by a dealer. | — |

*1: Models with the smart entry system have an **ENGINE START/STOP** button instead of an ignition switch.



| Indicator | Name | On/Blinking | Explanation | Message* |
|---|--------------------------------|--|---|---|
|  | System Message Indicator* | <ul style="list-style-type: none"> • Comes on for a few seconds when you turn the ignition switch to ON *1, then goes off. • Comes on along with a beep when a problem is detected. A system message on the multi-information display appears at the same time. | <ul style="list-style-type: none"> • While the indicator is on, press the  (information) button to see the message again. • Refer to the Indicators information in this chapter when a system message appears on the multi-information display. Take the appropriate action for the message. • The multi-information display does not return to the normal screen unless the warning is canceled, or the  button is pressed. | — |
|  | Brake System Indicator (Amber) | <ul style="list-style-type: none"> • Comes on for a few seconds when you turn the ignition switch to ON *1, then goes off. • Comes on if there is a problem with a system related to braking other than the conventional brake system. | <ul style="list-style-type: none"> • Comes on while driving - Have your vehicle checked by a dealer. • With this indicator on, your vehicle still has normal braking ability. |  |



*1:Models with the smart entry system have an **ENGINE START/STOP** button instead of an ignition switch.

* Not available on all models



Continued

Models with ACC



| Indicator | Name | On/Blinking | Explanation | Message * |
|--|---|--|--|---|
| <p style="font-size: 2em; font-weight: bold; margin: 0;">ACC</p> | <p>Adaptive Cruise Control (ACC) Indicator*</p> | <ul style="list-style-type: none"> Comes on for a few seconds when you set the power mode to ON, then goes off. Comes on if there is a problem with ACC. | <ul style="list-style-type: none"> Comes on - Have your vehicle checked by a dealer. |  |
| | | <ul style="list-style-type: none"> Comes on if anything covers the radar sensor cover and prevents the sensor from detecting a vehicle in front. May come on when driving in bad weather (rain, snow, fog, etc.) ACC has been automatically canceled. | <ul style="list-style-type: none"> When the radar sensor gets dirty, stop your vehicle in a safe place, and wipe off dirt using a soft cloth. Have your vehicle checked by a dealer if the message does not disappear even after you clean the sensor cover. |  |

| Indicator | Name | On/Blinking | Explanation | Message* |
|-------------------|--|---|---|---|
| <p>ACC</p> | <p>Adaptive Cruise Control (ACC) Indicator*</p> | <ul style="list-style-type: none"> Comes on when ACC is in operation, but the temperature inside the front sensor camera is too high. ACC cancels automatically. The beeper sounds simultaneously. | <ul style="list-style-type: none"> Use the climate control system to cool down the camera. Goes off - The camera has been cooled down and the system activates normally. |  |
| | | <ul style="list-style-type: none"> Comes on when the area around the camera is blocked by dirt, mud, etc. Stop your vehicle in a safe place, and wipe it off with a soft cloth. May come on when driving in bad weather (rain, snow, fog, etc.) | <ul style="list-style-type: none"> Have your vehicle checked by a dealer if the indicator and message come back on after you cleaned the area around the camera. |  |

* Not available on all models

| Indicator | Name | On/Blinking | Explanation | Message * |
|--------------------|---|---|---|---|
| <p>LKAS</p> | <p>Lane Keeping Assist System (LKAS) Indicator*</p> | <ul style="list-style-type: none"> • Comes on for a few seconds when you set the power mode to ON, then goes off. • Comes on if there is a problem with the LKAS. | <ul style="list-style-type: none"> • Comes on - Have your vehicle checked by a dealer. |  |
| | | <ul style="list-style-type: none"> • Comes on when the LKAS is in operation, or the LKAS button is pressed, but the temperature inside the front sensor camera is too high. The LKAS cancels automatically. The beeper sounds simultaneously. | <ul style="list-style-type: none"> • Use the climate control system to cool down the camera. • Goes off - The camera has been cooled down and the system activates normally. <ul style="list-style-type: none"> ➤ Front Sensor Camera* P. 378 |  |
| | | <ul style="list-style-type: none"> • Comes on when the area around the camera is blocked by dirt, mud, etc. Stop your vehicle in a safe place, and wipe it off with a soft cloth. • May come on when driving in bad weather (rain, snow, fog, etc.) | <ul style="list-style-type: none"> • Have your vehicle checked by a dealer if the indicator and message come back on after you cleaned the area around the camera. |  |





Models with CMBS™





| Indicator | Name | On/Blinking | Explanation | Message* |
|---|---|---|--|---|
|  | Collision Mitigation Braking System™ (CMBS™) Indicator* | <ul style="list-style-type: none"> • Comes on for a few seconds when you set the power mode to ON, then goes off. • Comes on when you deactivate the CMBS™. A multi-information display message appears for five seconds. • Comes on if there is a problem with the CMBS™. | <ul style="list-style-type: none"> • Stays on constantly without the CMBS™ off - Have your vehicle checked by a dealer. <ul style="list-style-type: none"> ▣ Collision Mitigation Braking System™ (CMBS™)* P. 416 |  |

Instrument Panel

* Not available on all models



Models with CMBS™





| Indicator | Name | On/Blinking | Explanation | Message * |
|---|---|---|--|---|
|  | Collision Mitigation Braking System™ (CMBS™) Indicator* | <ul style="list-style-type: none"> Comes on when the CMBS™ system shuts itself off. | <ul style="list-style-type: none"> Stays on - The area around the camera is blocked by dirt, mud, etc. Stop your vehicle in a safe place, and wipe it off with a soft cloth. <ul style="list-style-type: none"> ➤ Front Sensor Camera* P. 378 |  |
| | | <ul style="list-style-type: none"> When the radar sensor gets dirty, stop your vehicle in a safe place, and wipe off dirt using a soft cloth. Have your vehicle checked by a dealer if the message does not disappear even after you clean the sensor cover. <ul style="list-style-type: none"> ➤ Collision Mitigation Braking System™ (CMBS™)* P. 416 |  | |
| | | <ul style="list-style-type: none"> Stays on - The temperature inside the camera is too high. Use the climate control system to cool down the camera. The system activates when the temperature inside the camera cools down. <ul style="list-style-type: none"> ➤ Front Sensor Camera* P. 378 |  | |

| Indicator | Name | On/Blinking | Explanation | Message* |
|---|---|--|---|---|
|  | Lane Departure Warning (LDW) Indicator* | <ul style="list-style-type: none"> • Comes on for a few seconds when you change the power mode to ON, then goes off. • Comes on if there is a problem with the LDW system. | <ul style="list-style-type: none"> • Stays on constantly - Have your vehicle checked by a dealer. |  |
| | | <ul style="list-style-type: none"> • Comes on when the LDW system shuts itself off. | <ul style="list-style-type: none"> • Stays on - The temperature inside the camera is too high. Use the climate control system to cool down the camera. The system activates when the temperature inside the camera cools down. ➤ Front Sensor Camera* P. 378 |  |
| | | | <ul style="list-style-type: none"> • Stays on - The area around the camera is blocked by dirt, mud, etc. Stop your vehicle in a safe place, and wipe it off with a soft cloth. • Have your vehicle checked by a dealer if the indicator and message come back on after you cleaned the area around the camera. ➤ Front Sensor Camera* P. 378 |  |



* Not available on all models

Display Warning and Information Messages*



The following messages appear on the multi-information display* or intelligent multi-information display (i-MID). Press the / (information) button to see the message again with the system message indicator on.

| Message | Condition | Explanation |
|---|---|---|
|  | <ul style="list-style-type: none"> Appears when the engine coolant temperature gets abnormally high. | <p> Overheating P. 507</p> |
| <p>Canadian models</p>  | <ul style="list-style-type: none"> Appears when the washer fluid is low. | <ul style="list-style-type: none"> Refill washer fluid. <p> Refilling Window Washer Fluid P. 461</p> |

Models with AWD system

| Message | Condition | Explanation |
|---|--|--|
|  | <ul style="list-style-type: none"> Appears when the differential temperature is too high. | <p>Stop in a safe place, shift to P, and idle the engine until the message goes off. If it does not go off, take your vehicle to a dealer.</p> <p> Real Time AWD with Intelligent Control System™* P. 407</p> |

Models with smart entry system



| Message | Condition | Explanation |
|--|--|---|
|  | <ul style="list-style-type: none"> Appears when you close the door with the power mode in ON without the keyless remote inside the vehicle. | <ul style="list-style-type: none"> Disappears when you bring the keyless remote back inside the vehicle, and close the door. <ul style="list-style-type: none"> ► Smart Entry Remote Reminder P. 158 |
|  | <ul style="list-style-type: none"> Appears when the smart entry remote battery becomes weak. | <ul style="list-style-type: none"> Replace the battery as soon as possible. <ul style="list-style-type: none"> ► Smart Entry Remote* P. 486 |
|  | <ul style="list-style-type: none"> Appears when the starter system has a problem. | <ul style="list-style-type: none"> As a temporary measure, press and hold the ENGINE START/STOP button for 15 seconds while depressing the brake pedal and manually start the engine. Have your vehicle checked by a dealer. <ul style="list-style-type: none"> ► Starting the Engine P. 366 |

* Not available on all models



Models with power tailgate system







| Message | Condition | Explanation |
|--|---|--|
|  <p>The image shows two instrument panel messages for a power tailgate system. The top message is for U.S. models, featuring a white rectangular box with 'U.S.' inside, a black circle with 'CHECK POWER TAILGATE' text, and a white rectangular box with 'TAIL GATE' text. The bottom message is for Canada models, featuring a white rectangular box with 'Canada' inside, a black circle with 'CHECK POWER TAILGATE' text, and a white icon of a car with an exclamation mark.</p> | <ul style="list-style-type: none"> • Appears when there is a problem with the power tailgate system. | <ul style="list-style-type: none"> • Manually open or close the power tailgate. • Have your vehicle checked by a dealer. |

Models with LKAS

| Message | Condition | Explanation |
|--|---|---|
|  | <ul style="list-style-type: none"> Blinks when you fail to steer the vehicle. | <ul style="list-style-type: none"> Operate the steering wheel to resume the LKAS. |
|  | <ul style="list-style-type: none"> Appears when the vehicle is driving out of a detected line. The beeper sounds simultaneously. | <ul style="list-style-type: none"> Keep the vehicle within the lane you are driving. |
|  | <ul style="list-style-type: none"> Appears when the LKAS button is pressed or the LKAS automatically canceled. The beeper sounds simultaneously. | <ul style="list-style-type: none"> If any other system indicators come on, such as the VSA®, ABS and brake system, take appropriate action. ► Indicators P. 82 |

Models with smart entry system

| Message | Condition | Explanation |
|---|--|--|
|  | <ul style="list-style-type: none"> • Appears after you unlock and open the driver's door. | <p>► Starting the Engine P. 366</p> |
|  | <ul style="list-style-type: none"> • Appears three seconds after the TO START ENGINE: BRAKE + PUSH messages appears. • Appears three seconds after you bring the smart entry remote in front of the ENGINE START/STOP button when TO START, HOLD REMOTE NEAR START BUTTON appears. TO START ENGINE: BRAKE + PUSH appears sequentially. | <p>► Changing the Power Mode P. 156</p> |

| Message | Condition | Explanation |
|--|--|--|
|  | <ul style="list-style-type: none"> • Appears when the steering wheel is locked. | <ul style="list-style-type: none"> • Move the steering wheel left and right while pressing the ENGINE START/STOP button. |
|  | <ul style="list-style-type: none"> • Appears if you press the ENGINE START/STOP button to turn the engine off without the shift lever in P. | <ul style="list-style-type: none"> • Press the ENGINE START/STOP button twice after moving the shift lever to P. |
|  | <ul style="list-style-type: none"> • Appears when the power mode is in ACCESSORY. | <p style="text-align: center;">—</p> |
|  | <ul style="list-style-type: none"> • Appears after the driver's door is opened when the power mode is in ACCESSORY. | <ul style="list-style-type: none"> • Press the ENGINE START/STOP button twice with your foot off the brake pedal to change the power mode to VEHICLE OFF. |
|  | <ul style="list-style-type: none"> • Appears if the smart entry remote's battery is too weak to start the engine or the key is not within operating range to start the engine. A beeper sounds six times. | <p style="text-align: center;">  If the Smart Entry Remote Battery is Weak P. 502 </p> |

Gauges

Gauges include the speedometer, tachometer, fuel gauge, and related indicators. They are displayed when the ignition switch is in ON *1.

■ Speedometer

Displays your driving speed in mph (U.S.) or km/h (Canada).

■ Tachometer

Shows the number of engine revolutions per minute.

■ Fuel Gauge

Displays the amount of fuel left in the fuel tank.

■ Temperature Gauge

Displays the temperature of the engine coolant.

*1: Models with the smart entry system have an **ENGINE START/STOP** button instead of an ignition switch.

⌘ Fuel Gauge

NOTICE

You should refuel when the reading approaches . Running out of fuel can cause the engine to misfire, damaging the catalytic converter.

The actual amount of remaining fuel may differ from the fuel gauge reading.

⌘ Temperature Gauge

NOTICE

Driving with the temperature gauge pointer in the upper zone can cause serious engine damage. Pull safely to the side of the road and allow engine temperature to return to normal.

 **Overheating** P. 507

Information Display*

The information display shows the odometer, trip meter, engine oil life and maintenance service item codes, and other gauges.

Switching the Display

Press the  (Select/Reset) knob to change the display.

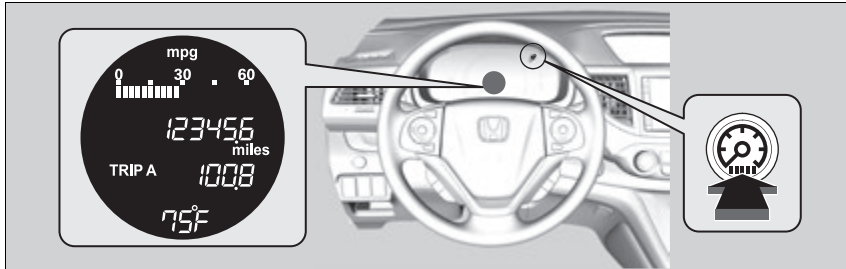

Odometer

Shows the total number of miles or kilometers that your vehicle has accumulated.

Switching the Display

Each time you press the  knob, the information display changes as follows:

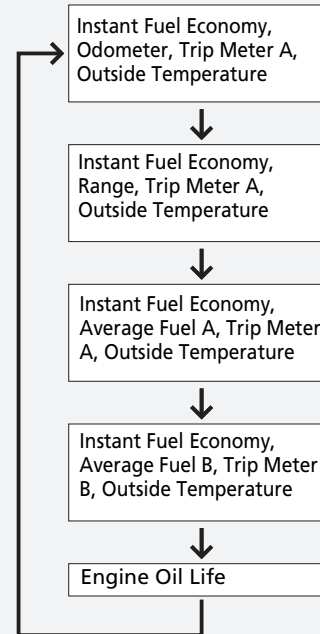

Some of the items on the information display also appear on the i-MID. They also change along with the information display changes while the fuel consumption is shown.

* Not available on all models

■ Trip Meter

Shows the total number of miles or kilometers driven since the last reset. Meters A and B can be used to measure two separate trips.

■ Resetting a trip meter

To reset a trip meter, display it, then press and hold the  knob. The trip meter is reset to **0.0**.

■ Average Fuel Economy

Shows the estimated average fuel economy of each trip meter in mpg (U.S.) or l/100 km (Canada). The display is updated at set intervals. When a trip meter is reset, the average fuel economy is also reset.

■ Engine Oil Life

Shows the remaining oil life and Maintenance Minder™.

➤ **Maintenance Minder™** P. 439

■ Range

Shows the estimated distance you can travel on the remaining fuel. This distance is estimated from the fuel economy of your previous trips.

■ Check Fuel Cap

Appears when the fuel fill cap is loose or is not installed.

➤ **Check/Tighten Fuel Cap Message** P. 510

» Trip Meter

Switch between trip meter A and trip meter B by pressing the  knob.

■ Outside Temperature

Shows the outside temperature in Fahrenheit (U.S.) or Celsius (Canada).

■ Adjusting the outside temperature display

Adjust the temperature reading up to $\pm 5^{\circ}\text{F}$ or $\pm 3^{\circ}\text{C}$ if the temperature reading seems incorrect.

☒ Outside Temperature

The temperature sensor is in the front bumper. Road heat and exhaust from another vehicle can affect the temperature reading when your vehicle speed is less than 19 mph (30 km/h).

It may take several minutes for the display to be updated after the temperature reading has stabilized.

Use the i-MID's customized features to correct the temperature.



☒ **Customized Features** P. 116

Multi-Information Display*

The multi-information display shows the odometer, trip meter, outside temperature indicator, and other gauges.

It also displays important messages such as warnings and other helpful information.

Switching the Display

Press the / (information) button or the **SEL/RESET** button to change the display.

Main displays

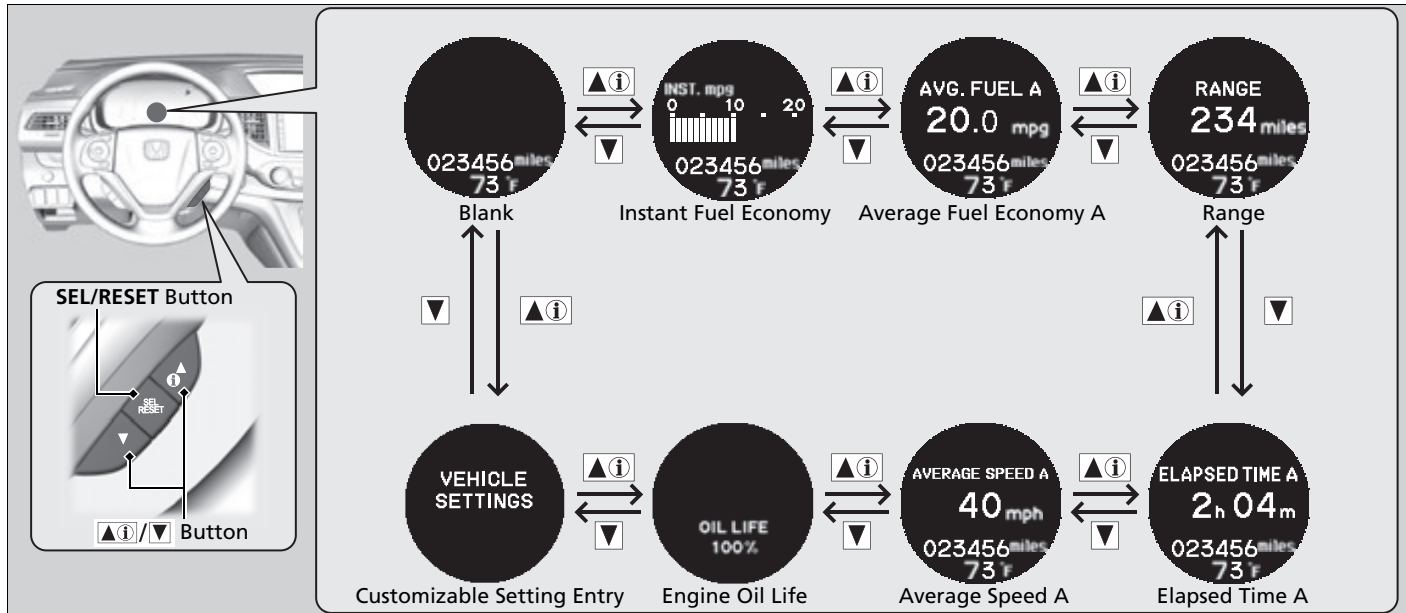

■ Lower displays

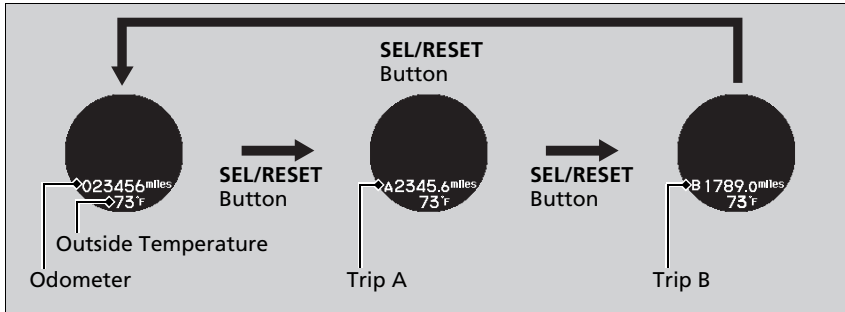

■ Odometer

Shows the total number of miles or kilometers that your vehicle has accumulated.

■ Trip Meter

Shows the total number of miles or kilometers driven since the last reset. Meters A and B can be used to measure two separate trips.

■ Resetting a trip meter

To reset a trip meter, display it, then press and hold the **SEL/RESET** button. The trip meter is reset to **0.0**.

▣ Trip Meter

Switch between trip meter A and trip meter B by pressing the **SEL/RESET** button.

■ Outside Temperature

Shows the outside temperature in Fahrenheit (U.S.) or Celsius (Canada).

■ Adjusting the outside temperature display

Adjust the temperature reading up to $\pm 5^{\circ}\text{F}$ or $\pm 3^{\circ}\text{C}$ if the temperature reading seems incorrect.

■ Instant Fuel Economy Gauge

Shows the instant fuel economy as a bar graph in mpg (U.S.) or l/100 km (Canada).

■ Average Fuel Economy

Shows the estimated average fuel economy of each trip meter in mpg (U.S.) or l/100 km (Canada). The display is updated at set intervals. When a trip meter is reset, the average fuel economy is also reset.

■ Engine Oil Life

Shows the remaining oil life and Maintenance Minder™.

➤ **Maintenance Minder™** P. 439

⌘ Outside Temperature

The temperature sensor is in the front bumper. Road heat and exhaust from another vehicle can affect the temperature reading when your vehicle speed is less than 19 mph (30 km/h).

It may take several minutes for the display to be updated after the temperature reading has stabilized.

Use the multi-information display's customized features to correct the temperature.

➤ **Customized Features** P. 102

⌘ Average Fuel Economy

You can change when to reset the average fuel economy.

➤ **Customized Features** P. 102

■ Range

Shows the estimated distance you can travel on the remaining fuel. This distance is estimated from the fuel economy of your trips in the past.

■ Elapsed Time

Shows the time elapsed since the last time Trip A or Trip B was reset.

■ Average Speed

Shows the average speed in mph (U.S.) or km/h (Canada) since the last time Trip A or Trip B was reset.

⌘ Elapsed Time

You can change when to reset the elapsed time.

➤ **Customized Features** P. 102

⌘ Average Speed



You can change when to reset the average speed.

➤ **Customized Features** P. 102

■ Customized Features

Use the multi-information display to customize certain features.

■ How to customize

Select the **VEHICLE SETTINGS** screen by pressing the  button while the ignition switch is in ON *1. The screen switches to **CHANGE SETTINGS**.

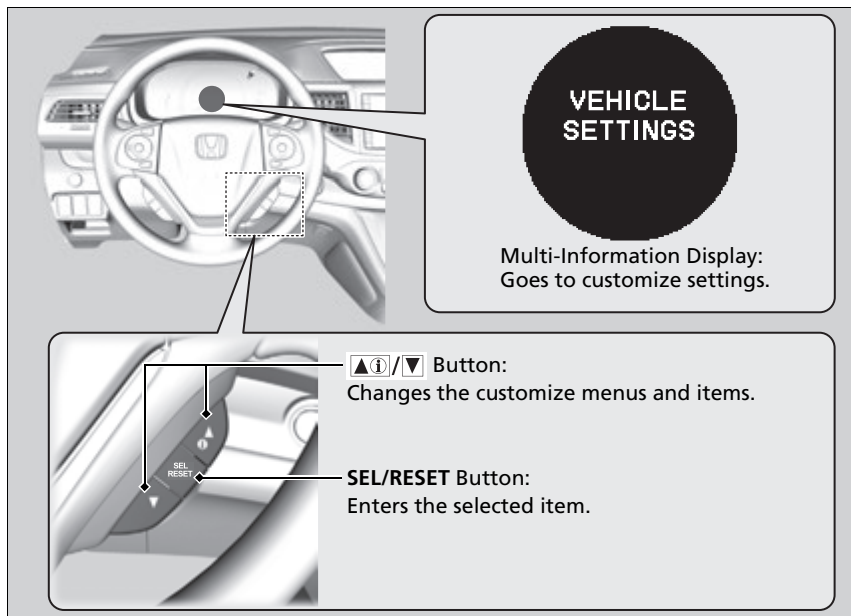

*1: Models with the smart entry system have an **ENGINE START/STOP** button instead of an ignition switch.

☒ Customized Features

To select customizing items, press the **SEL/RESET** button on the **CHANGE SETTINGS** screen, then press the .

- ☒ **List of customizable options** P. 106
- ☒ **Example of customization settings** P. 111

When you customize settings, shift to .

■ Customization flow

Press the ▲(i)/▼ button.

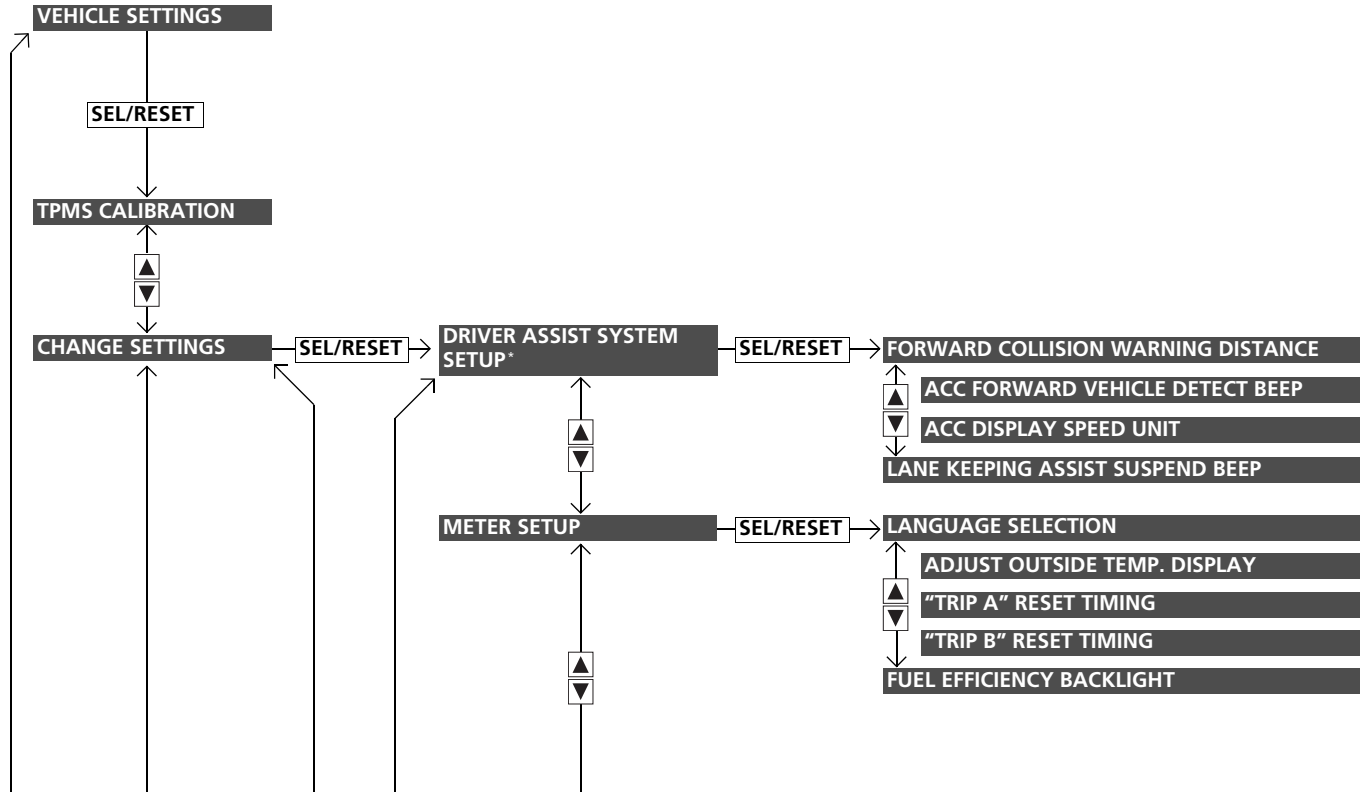

* Not available on all models

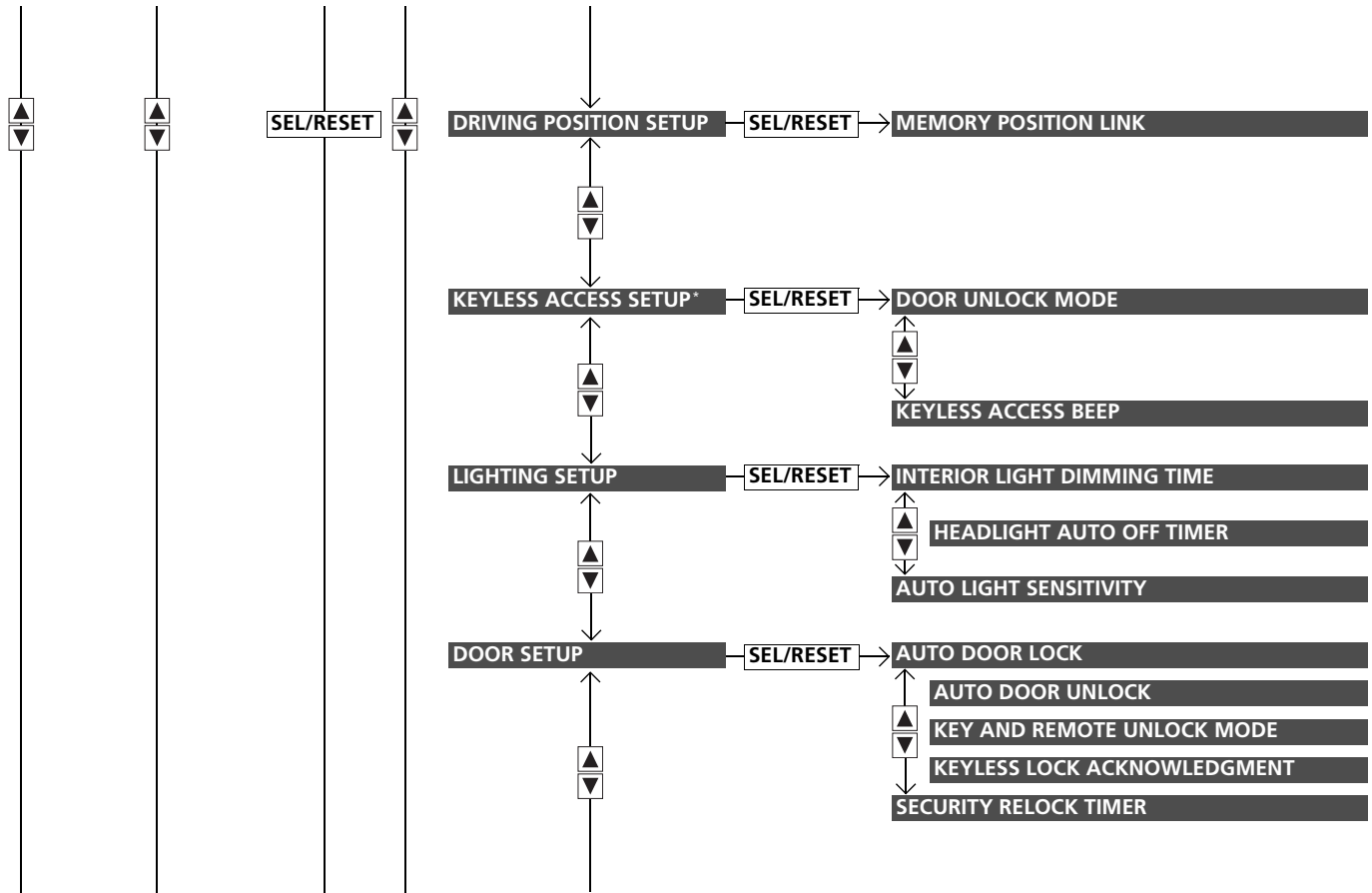

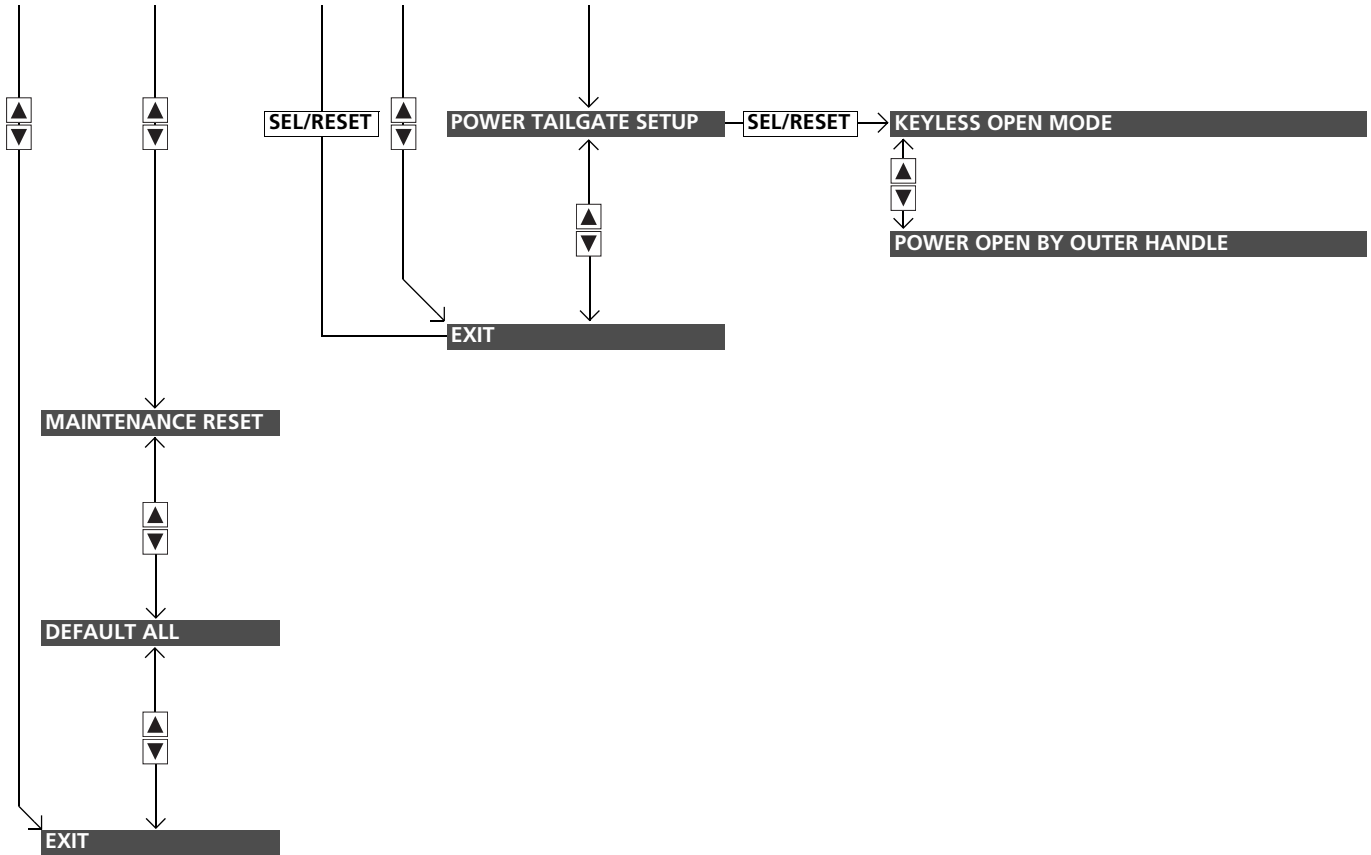

■ List of customizable options

| Setup Group | Customizable Features | Description | Selectable settings | |
|-------------------------|--|---|--|--|
| TPMS CALIBRATION | — | Calibrates the TPMS. | CANCEL/CALIBRATE | |
| CHANGE SETTINGS | DRIVER ASSIST SYSTEM SETUP* | FORWARD COLLISION WARNING DISTANCE | Changes the distance to activate the collision alert when a vehicle ahead of you gets too close. | LONG/NORMAL*¹/ SHORT |
| | ACC FORWARD VEHICLE DETECT BEEP* | Causes the system to beep when the system detects a vehicle, or when the vehicle goes out of the ACC range. | ON/OFF*¹ | |
| | ACC DISPLAY SPEED UNIT* | Changes the displayed measurement of the set vehicle speed on the multi-information display. | mph*¹/km/h (U.S.) mph/km/h*¹ (Canada) | |
| | LANE KEEPING ASSIST SUSPEND BEEP* | Causes the system to beep when the LKAS is suspended. | ON/OFF*¹ | |

*1:Default Setting

| Setup Group | Customizable Features | Description | Selectable settings | |
|------------------------|-----------------------|-------------------------------------|--|--|
| CHANGE SETTINGS | METER SETUP | LANGUAGE SELECTION | Changes the displayed language. | ENGLISH*¹/FRANCAIS/ESPANOL |
| | | ADJUST OUTSIDE TEMP. DISPLAY | Adjusts the temperature reading by a few degrees. | -5°F ~ ±0°F*¹ ~ +5°F (U.S.) -3°C ~ ±0°C*¹ ~ +3°C (Canada) |
| | | "TRIP A" RESET TIMING | Changes the setting of how to reset trip meter A, average fuel economy A, average speed A, and elapsed time A. | WHEN REFUELED/IGN OFF/MANUALLY RESET*¹ |
| | | "TRIP B" RESET TIMING | Changes the setting of how to reset trip meter B, average fuel economy B, average speed B, and elapsed time B. | WHEN REFUELED/IGN OFF/MANUALLY RESET*¹ |
| | | FUEL EFFICIENCY BACKLIGHT | Turns the ambient meter feature on and off. | ON*¹/OFF |

*1:Default Setting

| Setup Group | Customizable Features | | Description | Selectable settings |
|------------------------|--------------------------------|------------------------------------|---|-------------------------------------|
| CHANGE SETTINGS | DRIVING POSITION SETUP* | MEMORY POSITION LINK | Turns the driving position memory system on and off. | ON*1/OFF |
| | KEYLESS ACCESS SETUP* | DOOR UNLOCK MODE | Changes which doors unlock when you grab the driver's door handle and tailgate handle. When you press the tailgate release button, if you chose DRIVER DOOR ONLY , only tailgate is unlatched. If you chose ALL DOORS , tailgate is unlatched and all doors are unlocked. | DRIVER DOOR ONLY*1/ALL DOORS |
| | | KEYLESS ACCESS BEEP | Causes the beeper to sound when you unlock/lock the doors. | ON*1/OFF |
| | LIGHTING SETUP | INTERIOR LIGHT DIMMING TIME | Changes the length of time the interior lights stay on after you close the doors. | 60 sec/30 sec*1/15 sec |
| | | HEADLIGHT AUTO OFF TIMER | Changes the length of time the exterior lights stay on after you close the driver's door. | 60 sec/30 sec/15 sec*1/0 sec |
| | | AUTO LIGHT SENSITIVITY* | Changes the timing for the headlights to come on. | MAX/HIGH/MID*1/LOW/MIN |

*1:Default Setting

| Setup Group | Customizable Features | Description | Selectable settings | |
|------------------------|-----------------------|------------------------------------|---|--|
| CHANGE SETTINGS | DOOR SETUP | AUTO DOOR LOCK | Changes the setting for when the doors automatically lock. | OFF/WITH VEH SPD*¹/SHIFT FROM P |
| | | AUTO DOOR UNLOCK | Changes the setting for when the doors automatically unlock. | WHEN DRIVER'S DOOR OPENS*¹/WHEN SHIFTING INTO PARK/ WHEN IGNITION SWITCHED OFF/OFF |
| | | KEY AND REMOTE UNLOCK MODE | Sets up either the driver's door or all doors to unlock on the first operation of the remote or ignition key. | DRIVER DOOR*¹/ALL DOORS |
| | | KEYLESS LOCK ACKNOWLEDGMENT | Turns on or off the keyless lock acknowledgment of: LOCK/UNLOCK- The exterior lights flash. | ON*¹/OFF |
| | | SECURITY RELOCK TIMER | Changes the time it takes for the doors to relock and the security system to set after you unlock the vehicle without opening any door. | 90 sec/60 sec/30 sec*¹ |

*1:Default Setting

| Setup Group | Customizable Features | | Description | Selectable settings |
|------------------------|------------------------------|-----------------------------------|--|---|
| CHANGE SETTINGS | POWER TAILGATE SETUP* | KEYLESS OPEN MODE | Changes the keyless setting for when the power tailgate opens. | ANYTIME*¹/WHEN UNLOCKED |
| | | POWER OPEN BY OUTER HANDLE | Changes the setting to open power tailgate by tailgate outer handle. | OFF (MANUAL ONLY)/ON (POWER/MANUAL)*¹ |
| | MAINTENANCE RESET | — | Resets/Cancel the engine oil life display when you have performed the maintenance service. | CANCEL/RESET |
| DEFAULT ALL | | | Cancels/Resets all the customized settings as default. | SET/CANCEL |

*1:Default Setting

■ Example of customization settings

The steps for changing the “TRIP A” RESET TIMING setting to **WHEN REFUELD** are shown below. The default setting for “TRIP A” RESET TIMING is **MANUALLY RESET**.



1. Press the /▼ button until **VEHICLE SETTINGS** appears on the display, then press the **SEL/RESET** button.
2. Press the /▼ button until **CHANGE SETTINGS** appears on the display, then press the **SEL/RESET** button.

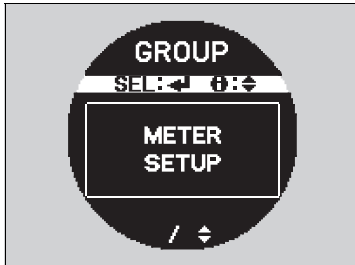

3. Press the /▼ button until **METER SETUP** appears on the display, then press the **SEL/RESET** button.
 - ▶ **LANGUAGE SELECTION** appears first in the display.

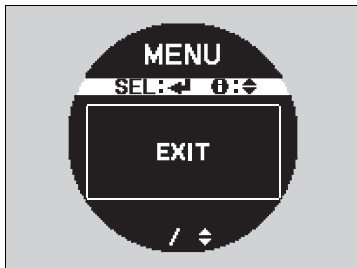

4. Press the /▼ button until **"TRIP A" RESET TIMING** appears on the display, then press the **SEL/RESET** button.
 - The display switches to the customization setup screen, where you can select **WHEN REFUELED**, **MANUALLY RESET**, **IGN OFF**, or **EXIT**.
5. Press the /▼ button and select **WHEN REFUELED**, then press the **SEL/RESET** button.
 - The **WHEN REFUELED** setup screen appears, then the display returns to the customization menu screen.
6. Press the /▼ button until **EXIT** appears in the display, then press the **SEL/RESET** button.
7. Repeat Step 6 until you return to the normal screen.

intelligent Multi-Information Display (i-MID)

Shows useful information, such as audio status. It also displays the compass direction and clock.

Switching the Display

Press the  (display) button to change the display.

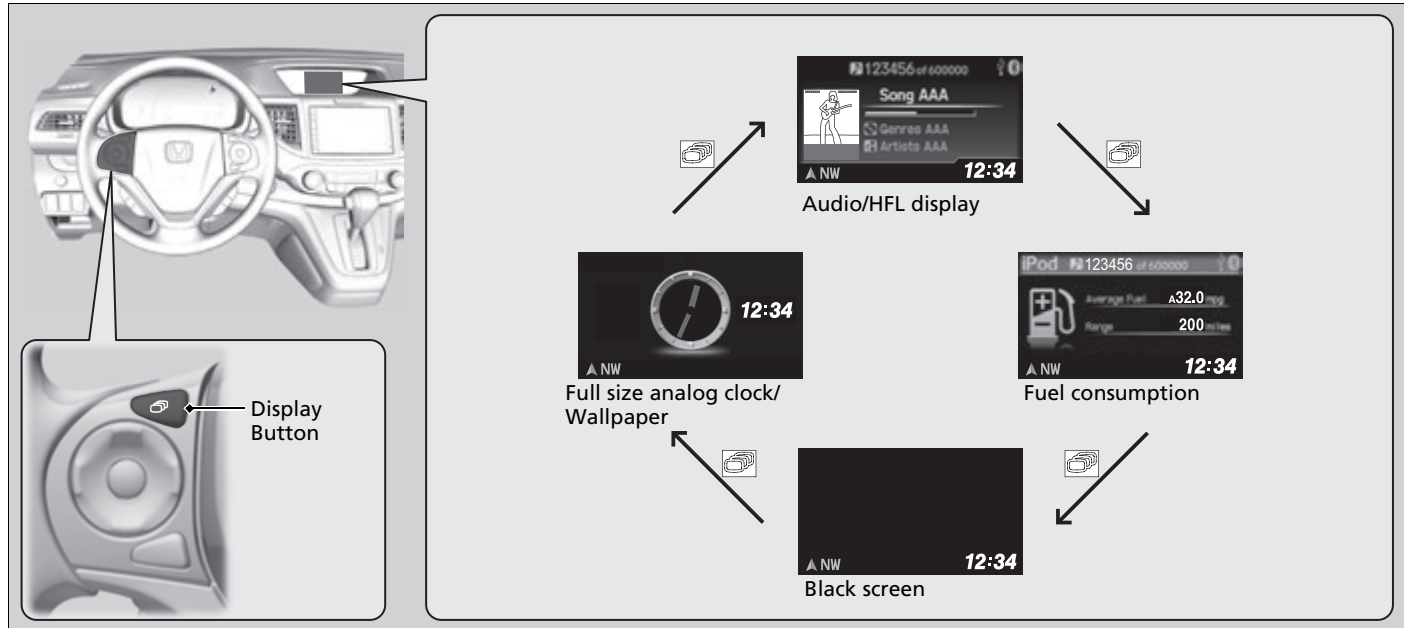

■ Average Fuel Economy

Shows the estimated average fuel economy of each trip meter in mpg (U.S.) or l/100 km (Canada). The display is updated at set intervals. When a trip meter is reset, the average fuel economy is also reset.

■ Range

Shows the estimated distance you can travel on the remaining fuel. This distance is estimated from the fuel economy of your previous trips.

■ Elapsed Time

Shows the time elapsed since Trip A or Trip B was reset.

■ Average Speed

Shows the average speed in mph or km/h since Trip A or Trip B was reset.

⌘ Average Fuel Economy

You can choose an item to be displayed in the fuel consumption screen. Range, elapsed time, or average speed can be selected.

➤ **Customized Features** P. 116

You can change when to reset the average fuel economy.

➤ **Customized Features** P. 116

⌘ Elapsed Time

You can change when to reset the elapsed time.

➤ **Customized Features** P. 116

⌘ Average Speed

You can change when to reset the average speed.

➤ **Customized Features** P. 116

■ Engine Oil Life and Maintenance Items

Shows the remaining oil life and Maintenance Minder™.

➤ **Maintenance Minder™** P. 439

■ Compass Direction

Shows the vehicle's traveling direction.

➤ **Compass** P. 347

■ Turn-by-Turn Directions *

Shows you turn-by-turn driving directions to your destination linked with the navigation system.

➤ **See the Navigation System Manual**

☒ Turn-by-Turn Directions *

You can select whether the turn-by-turn display comes on or not during the route guidance.

➤ **Customized Features** P. 116

■ Customized Features

Use the i-MID to customize certain features.

■ How to customize

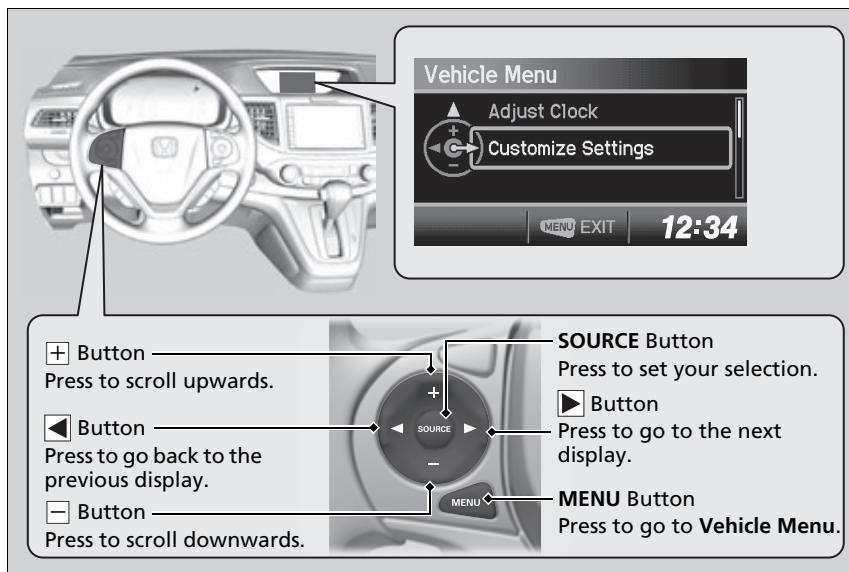

Select the **Vehicle Menu** screen by pressing the **MENU** button while the ignition switch is in ON ^{*1}, and the vehicle is at a complete stop. Select **Customize Settings**, then press the **SOURCE** button.



*1: Models with the smart entry system have an **ENGINE START/STOP** button instead of an ignition switch.

* Not available on all models

▶ Customized Features

To customize other features, press the  /  button.

- ▶ **List of customizable options** P. 120
- ▶ **Example of customizing wallpapers*** P. 125

When you customize settings, shift to .

■ Customization flow

Press the **MENU** button.

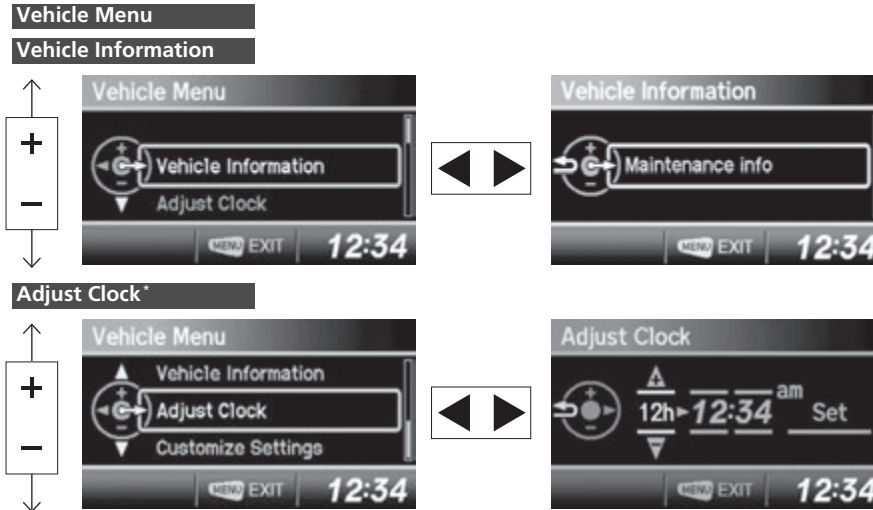

▶ Customized Features

You can exit the customizing screen at any time by pressing the **MENU** button.

* Not available on all models

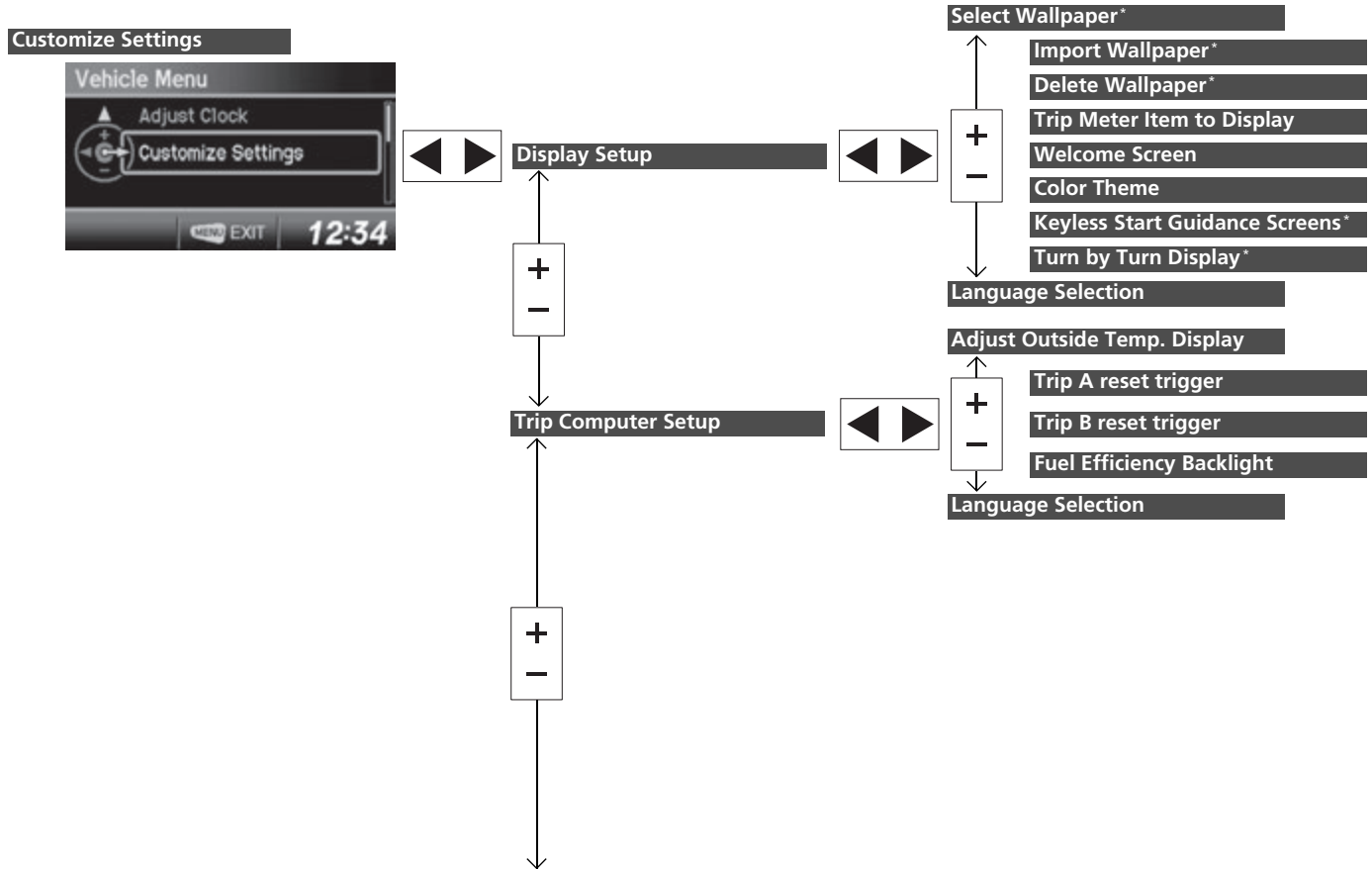



Instrument Panel

* Not available on all models

■ List of customizable options

| Setup Group | Customizable Features | Description | Selectable settings |
|----------------------------|-------------------------|---|--|
| Vehicle Information | Maintenance info | Reset the Maintenance Minder™. | No/Yes |
| Adjust Clock* | | Selects the 12 hour or 24 hour clock display, and adjusts the time. | 12h^{*1}/24h |
| Customize Settings | Display Setup | Select Wallpaper* Selects the full-size analogue clock or the wallpaper. | Clock^{*1}/Image 1/Image 2/Image 3 |
| | | Import Wallpaper* Imports an image file for a new wallpaper. | Three images can be stored. ▶ Importing wallpapers from USB P. 125 |
| | | Delete Wallpaper* Deletes an image file for a wallpaper. | Image 1/Image 2/Image 3 |
| | | Trip Meter Item to Display Selects an item to be displayed along with average fuel economy. | Range^{*1}/Elapsed time/Average speed |

*1:Default Setting

| Setup Group | Customizable Features | Description | Selectable settings | |
|---------------------------|-----------------------|---|---|---|
| Customize Settings | Display Setup | Welcome Screen | Selects whether the welcome screen comes on or not when you turn the ignition switch to ON  * ³ . | On * ¹ / Off |
| | | Color Theme | Changes the color of the screen. | Blue * ¹ / Red/Amber/Gray |
| | | Keyless Start Guidance Screens * | Displays the push button start guidance when conditions are met to change power mode. | On/Off * ¹ |
| | | Turn by Turn Display * ¹ , * ² | Selects whether the turn-by-turn display comes on or not during the route guidance. | On * ¹ / Off |
| | | Language Selection | Changes the displayed language. | English * ¹ / Francais/Español |

*1:Default Setting

*2:See the Navigation System Manual

*3:Models with the smart entry system have an **ENGINE START/STOP** button instead of an ignition switch.

| Setup Group | Customizable Features | Description | Selectable settings | |
|---------------------------|-------------------------------------|---|--|---|
| Customize Settings | Adjust Outside Temp. Display | Adjusts the temperature reading by a few degrees. | -5°F ~ ±0°F*¹ ~ +5°F (U.S.) -3°C ~ ±0°C*¹ ~ +3°C (Canada) | |
| | Trip Computer Setup | Trip A reset trigger | Changes the setting of how to reset trip meter A, average fuel economy A, average speed A, and elapsed time A. | With refuel/Manual only*¹/IGN Off |
| | | Trip B reset trigger | Changes the setting of how to reset trip meter B, average fuel economy B, average speed B, and elapsed time B. | With refuel/Manual only*¹/IGN Off |
| | | Fuel Efficiency Backlight | Turns the ambient meter feature on and off. | On*¹/Off |
| | | Language Selection | Changes the displayed language. | English*¹/Francais/Espanol |
| | Driving Position Setup* | Memory Position Link | Turns the driving position memory system on and off. | On*¹/Off |

*1:Default Setting

| Setup Group | Customizable Features | Description | Selectable settings | |
|---------------------------|---|--|--|--|
| Customize Settings | Keyless Access Beep | Causes the beeper to sound when you unlock/lock the doors. | On^{*1}/Off | |
| | Keyless Access Setup[*] | Door Unlock Mode | Changes which doors unlock when you grab the driver's door handle and tailgate handle. When you press the tailgate release button, if you chose Driver Door Only , only tailgate is unlatched. If you chose All Doors , tailgate is unlatched and all doors are unlocked. | Driver Door Only^{*1}/All Doors |
| | | Interior Light Dimming Time | Changes the length of time the interior lights stay on after you close the doors. | 60sec/30sec^{*1}/15sec |
| | Lighting Setup | Headlight Auto Off Timer | Changes the length of time the exterior lights stay on after you close the driver's door. | 60sec/30sec/15sec^{*1}/0sec |
| | | Auto Light Sensitivity[*] | Changes the timing for the headlights to come on. | Max/High/Mid^{*1}/Low/Min |

*1:Default Setting

* Not available on all models

| Setup Group | Customizable Features | Description | Selectable settings |
|---------------------------|--|--|---|
| Customize Settings | Auto Door Lock | Changes the setting for when the doors automatically lock. | Off/With Vehicle Speed*¹/Shift from P |
| | Door Lock Mode | Sets up either the driver's door or all doors to unlock on the first operation of the remote or ignition key. | Driver Door*¹/All Doors |
| | Auto unlock All doors | Changes the setting for when the doors automatically unlock. | Off/When Driver's Door Opens*¹/When Shift To Park/When Ignition Off |
| | Keyless Lock Acknowledgment | Turns on or off the keyless lock acknowledgment of: LOCK/UNLOCK- The exterior lights flash. LOCK (2nd push)- The beeper sounds. | On*¹/Off |
| | Security Relock Timer | Changes the time it takes for the doors to relock and the security system* to set after you unlock the vehicle without opening any door. | 90sec/60sec/30sec*¹ |
| Default All | Cancels/Resets all the customized settings as default. | | Cancel Reset All Defaults |

*1:Default Setting

■ Example of customizing wallpapers*

You can customize the display from clock to wallpaper.

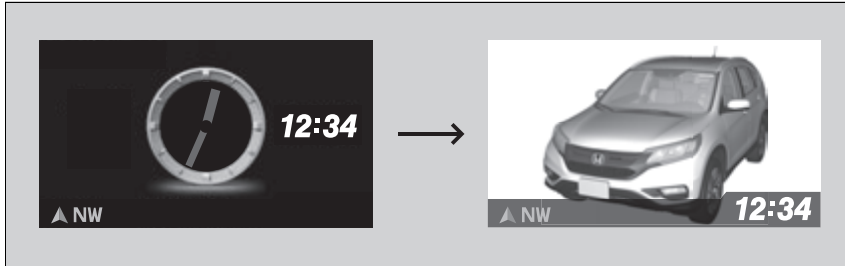

Importing wallpapers from USB

You can import up to three images, one at a time for wallpaper from a USB flash drive.

Select **Import Wallpaper** from **Customize Settings** and properly connect a USB flash drive to store an image.

1. Connect the USB flash drive to the adapter cable.

➤ **USB Adapter Cable*** P. 210

2. Press the **MENU** button.

3. Select **Customize Settings** with the $\boxed{+}$ / $\boxed{-}$ button, then press the **SOURCE** button.

Customized Features

- When importing wallpaper files, the image must be in the USB flash drive's root directory. Images in a folder cannot be imported.
- The file format of the image that can be imported is BMP (bmp) or JPEG (jpg).
- Each image file can be up to 2 MB.
- The maximum image size is 1,680 x 936 pixels. If the image size is less than 420 x 234 pixels, the image is displayed in the middle of the screen with the extra area appearing in black.
- The number of files that can be selected is up to 255.
- Up to 64 characters can be displayed in the file name.

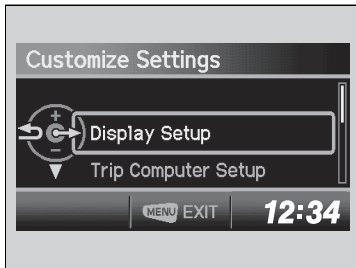

4. Select **Display Setup** with the $\boxed{+}$ / $\boxed{-}$ button, then press the **SOURCE** button.

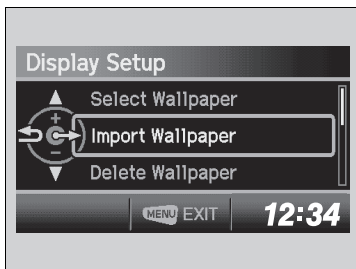

5. Select **Import Wallpaper** with the $\boxed{+}$ / $\boxed{-}$ button, then press the **SOURCE** button.
▶ The file names are displayed on the screen.

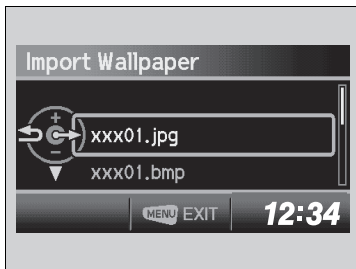

6. Press the $\boxed{-}$ button until the file name you want to store appears on the center of the display, then press the **SOURCE** button.



7. The preview of the imported data is displayed. Press the **SOURCE** button if it is OK.
8. Press the **SOURCE** button to save the image file.



9. Select the location you want to store the image file in with the \oplus / \ominus button, then press the **SOURCE** button.
10. Press the **MENU** button to exit the customizing screen.

Selecting a wallpaper



1. Press the **MENU** button.
2. Select **Customize Settings** with the $\boxed{+}$ / $\boxed{-}$ button, then press the **SOURCE** button.
3. Select **Display Setup** with the $\boxed{+}$ / $\boxed{-}$ button, then press the **SOURCE** button.
4. Select **Select Wallpaper** with the $\boxed{+}$ / $\boxed{-}$ button, then press the **SOURCE** button.
5. Select the image file you want with the $\boxed{+}$ / $\boxed{-}$ button, then press the **SOURCE** button.
 - ▶ When the scroll is stopped, the thumbnail is displayed.
6. Press the **MENU** button to exit the customizing screen.

Controls

This chapter explains how to operate the various controls necessary for driving.



| | |
|--|-----|
| Clock | 130 |
| Locking and Unlocking the Doors | |
| Key Types and Functions | 132 |
| Low Smart Entry Remote Signal Strength* | 134 |
| Locking/Unlocking the Doors from the Outside | 135 |
| Locking/Unlocking the Doors from the Inside | 139 |
| Childproof Door Locks | 140 |
| Auto Door Locking/Unlocking | 141 |
| Opening and Closing the Tailgate | 142 |
| Security System | 149 |
| Immobilizer System | 149 |
| Security System Alarm* | 149 |
| Opening and Closing the Windows | 152 |

| | |
|---|-----|
| Opening and Closing the Moonroof* .. | 154 |
| Operating the Switches Around the Steering Wheel | |
| Models without smart entry system | |
| Ignition Switch | 155 |
| Models with smart entry system | |
| ENGINE START/STOP Button | 156 |
| Ignition Switch and Power Mode Comparison | 159 |
| Turn Signals | 160 |
| Light Switches | 161 |
| Fog Lights* | 164 |
| Daytime Running Lights | 165 |
| Wipers and Washers | 166 |
| Brightness Control | 169 |

| | |
|--|-----|
| Defogger/Heated Door Mirror* | 170 |
| Driving Position Memory System* | 172 |
| Adjusting the Steering Wheel | 174 |
| Adjusting the Mirrors | 175 |
| Interior Rearview Mirror | 175 |
| Power Door Mirrors | 176 |
| Adjusting the Seats | 177 |
| Adjusting the Seat Positions | 177 |
| Interior Lights/Interior Convenience Items .. | 187 |
| Heating and Cooling System* | 200 |
| Using Vents, Heating and A/C | 200 |
| Climate Control System* | 203 |
| Using Automatic Climate Control | 203 |
| Automatic Climate Control Sensors | 206 |

* Not available on all models

Adjusting the Clock

Models with navigation system



The navigation system receives signals from GPS satellites, updating the clock automatically.

All models









You can adjust the time in the clock display with the ignition switch in ON *1.

Models with one display

■ Using the MENU button

1. Press the **MENU** button.
2. Select **Adjust Clock** with the  /  button, then press the **SOURCE** button.











3. Press the  /  button to change the setting between **12h** and **24h**.
4. Select hour or minute with the  /  button.
5. Press the  /  button to adjust the numbers up or down.
6. Select **Set** with the  /  button, then press the **SOURCE** button to enter your selection.
 - ▶ The display will return to the **Adjust Clock** display.

*1: Models with the smart entry system have an **ENGINE START/STOP** button instead of an ignition switch.

Models with one display



■ Using the **SETUP** button

1. Press the **SETUP** button.
2. Rotate  to select **Adjust Clock**, then press .
3. Rotate  to select the item you want to change (12/24 hour mode, hour, minute). Then press .
4. Rotate  to make the adjustment.
5. Press  to enter your selection. The display returns to **Adjust Clock**. Repeat steps 4 to 6 to adjust other items.
6. To enter the selection, Rotate  and select **Set**, then press .
7. Press the **SETUP** button to go back to the normal display.

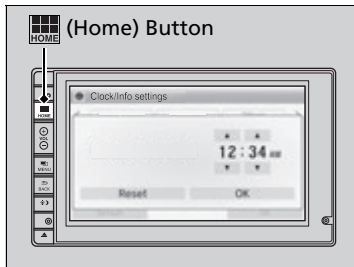

Models with two displays

■ Using the audio with touch screen



1. Press the  (Home) button, then select **Settings**.
2. Select **Clock/Info**, then **Clock Adjustment**.
3. Adjust the hours and minutes by selecting /.
4. Select **OK** to set the time.

▶▶ Using the **SETUP** button

These indications are used to show how to operate the selector knob.
 Rotate  to select.
 Press  to enter.

To set the time to the nearest hour:
 Press and hold the **CLOCK** button until the clock display begins to blink, then press the  (Reset) button.

Depending on the displayed time, the clock sets forward or backward.

Example:

1:06 will reset to 1:00

1:53 will reset to 2:00

▶▶ Using the audio with touch screen

You can customize the clock display to show the 12 hour clock or 24 hour clock.

▶ **Customized Features** P. 274

Key Types and Functions

This vehicle comes with the following key:

Keys

Ignition Keys with Remote Transmitter*



Smart Entry Remote*



Use the key to start and stop the engine, and to lock and unlock the doors and tailgate. You can also lock and unlock the doors and tailgate pressing the buttons on remote transmitter.

Key Types and Functions

All the keys have an immobilizer system. The immobilizer system helps protect against vehicle theft.

Immobilizer System P. 149

The keys contain precision electronics. Adhere to the following advice to prevent damage to the electronics:

- Do not leave the keys in direct sunlight, or in locations with high temperature or high humidity.
- Do not drop the keys or set heavy objects on them.
- Keep the keys away from liquids.
- Do not take the keys apart except for replacing the battery.

If the circuits in the keys are damaged, the engine may not start, and the remote transmitter may not work.

If the keys do not work properly, have them inspected by a dealer.

■ **Smart entry remote***

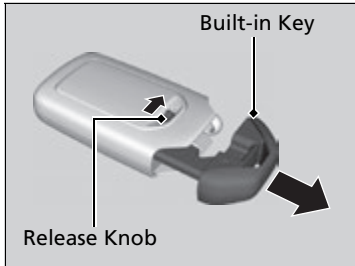

The built-in key can be used to lock/unlock the doors when the smart entry remote battery becomes weak and the power door lock/unlock operation is disabled. To remove the built-in key, pull it out while sliding the release knob. To reinstall the built-in key, push the built-in key into the smart entry remote until it clicks.

■ **Valet Key***

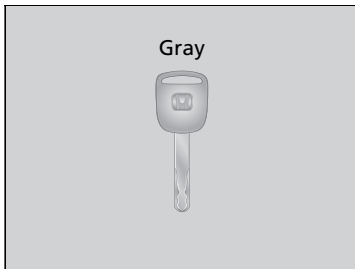

Can be used to start and stop the engine, and lock and unlock driver's door.

▣ **Valet Key***

When you need to leave a key with a third party, leave the valet key.

* Not available on all models

Continued

■ Key Number Tag

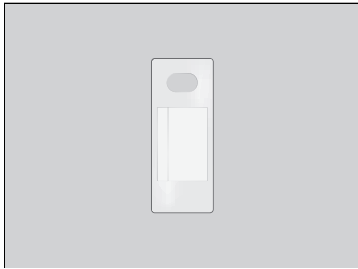

Contains a number that you will need if you purchase a replacement key.

Low Smart Entry Remote Signal Strength *

The vehicle transmits radio waves to locate the smart entry remote when locking/unlocking the doors, opening the tailgate, or to start the engine.

In the following cases, locking/unlocking the doors, opening the tailgate, or starting the engine may be inhibited or operation may be unstable:

- Strong radio waves are being transmitted by nearby equipment.
- You are carrying the smart entry remote together with telecommunications equipment, laptop computers, cell phones, or wireless devices.
- A metallic object is touching or covering the smart entry remote.

☒ Key Number Tag

Keep the key number tag separate from the key in a safe place outside of your vehicle. If you wish to purchase an additional key, contact a dealer.

If you lose your key and you cannot start the engine, contact a dealer.

☒ Low Smart Entry Remote Signal Strength *

Communication between the smart entry remote and the vehicle consumes the smart entry remote's battery.

Battery life is about two years, but this varies depending on regularity of use.

The battery is consumed whenever the smart entry remote is receiving strong radio waves. Avoid placing it near electrical appliances such as televisions and personal computers.

Locking/Unlocking the Doors from the Outside

■ Using the Smart Entry with Push Button Start System *

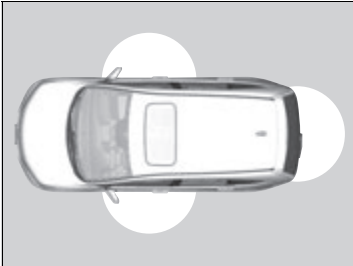

When you carry the smart entry remote, you can lock/unlock the doors and open the tailgate.

You can lock/unlock the doors within a radius of about 32 inches (80 cm) of the outside door handle. You can open the tailgate within about 32 inches (80 cm) radius from the tailgate release button.

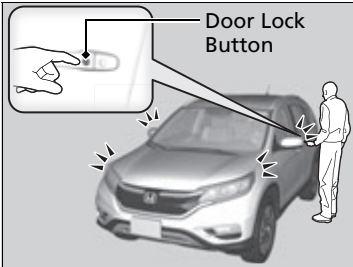

■ Locking the doors and tailgate

Press the door lock button on the front door or the tailgate.

- ▶ Some exterior lights flash; the beeper sounds; all the doors and tailgate lock; and the security system sets.

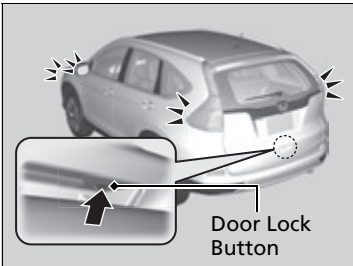

▣ Locking/Unlocking the Doors from the Outside

If the interior light switch is in the door activated position, the interior light comes on when you unlock the doors and tailgate.

No doors opened: The light fades out after 30 seconds.

Doors and tailgate relocked: The light goes off immediately.

▣ **Interior Lights** P. 187

▣ Using the Smart Entry with Push Button Start System *

If you do not open a door or the tailgate within 30 seconds of unlocking the vehicle with the smart entry system, the doors and tailgate will automatically relock.

You can change the relock timer setting.

▣ **Customized Features** P. 102, 116

You can lock or unlock doors using the smart entry system only when the power mode is in VEHICLE OFF.

* Not available on all models

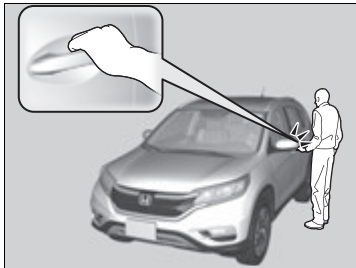

■ Unlocking the doors and tailgate

Grab the driver's door handle:

- ▶ The driver's door unlocks.
- ▶ Some exterior lights flash twice and the beeper sounds twice.

Grab the front passenger's door handle:

- ▶ All the doors and tailgate unlock.
- ▶ Some exterior lights flash twice and the beeper sounds twice.

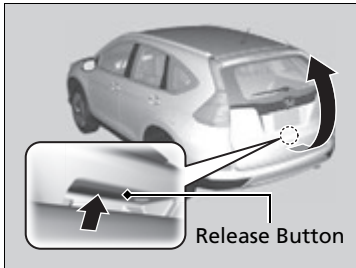

Press the tailgate release button:

- ▶ The tailgate unlocks.
- ▶ Some exterior lights flash twice and the beeper sounds twice.

■ Using the Tailgate Release Button

P. 143

■ Using the Smart Entry with Push Button Start System *

- Do not leave the smart entry remote in the vehicle when you get out. Carry it with you.
- Even if you are not carrying the smart entry remote, you can lock/unlock the doors and tailgate while someone else with the remote is within range.
- The door may be unlocked if the door handle is covered with water in heavy rain or in a car wash if the smart entry remote is within range.
- If you grip a front door handle wearing gloves, the door sensor may be slow to respond or may not respond by unlocking the doors.
- You cannot unlock the door by gripping the handle after two seconds of unlocking it.
- The door might not open if you pull it immediately after gripping the door handle. Grip the handle again and confirm that the door is unlocked before pulling the handle.
- Even within the 32 inches (80 cm) radius, you may not be able to lock/unlock the doors with the smart entry remote if it is above or below the outside handle.
- The smart entry remote may not operate if it is too close to the door and door glass.

Using the Remote Transmitter

Ignition keys with remote transmitter

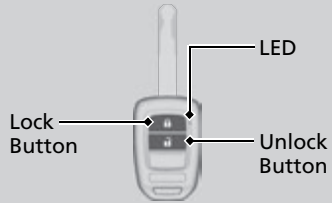

Models with smart entry remote

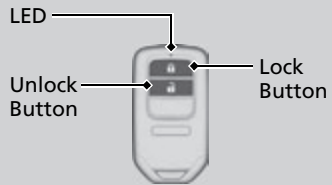

Locking the doors

Press the lock button.

Once:

- ▶ Some exterior lights flash, all the doors and tailgate lock, and the security system sets.

Twice (within five seconds after the first push):

- ▶ The beeper sounds and verifies the security system is set.

Unlocking the doors

Press the unlock button.

Once:

- ▶ Some exterior lights flash twice, and the driver's door unlocks.

Twice:

- ▶ The remaining doors and tailgate unlock.

Using the Remote Transmitter

If you do not open a door or the tailgate within 30 seconds of unlocking the vehicle with the remote transmitter, the doors and tailgate will automatically relock.

You can change the relock timer setting.

➤ **Customized Features** P. 102, 116

The remote transmitter will not work when:

Ignition keys with remote transmitter

- The key is in the ignition switch.

Models with smart entry remote

- The power mode is in VEHICLE OFF.

The remote transmitter uses low-power signals, so the operating range may vary depending on the surroundings.

The remote will not lock the vehicle when a door is open.

If the distance at which the remote transmitter works varies, the battery is probably low.

If the LED does not come on when you press a button, the battery is dead.

➤ **Replacing the Button Battery** P. 485

You can customize the door unlock mode setting.

➤ **Customized Features** P. 102, 116

■ Locking/Unlocking the Doors Using a Key

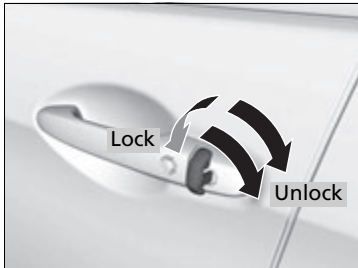

Fully insert the key and turn it.

■ Locking a Door Without Using a Key

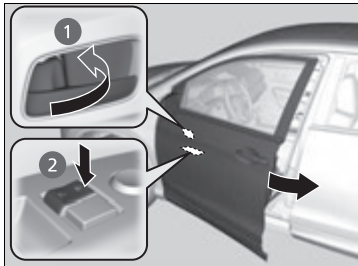

■ **Locking the driver's door**
Push the lock tab forward ① or push the master door lock switch in the lock direction ②, and close the door.

■ **Locking the passenger's doors**
Push the lock tab forward and close the door.

■ Lockout prevention system

Ignition keys with remote transmitter

The doors and tailgate cannot be locked when the key is in the ignition switch.

Models with smart entry remote

The doors and tailgate cannot be locked when the smart entry remote is inside the vehicle.

▶▶ Locking/Unlocking the Doors Using a Key

When you lock the driver's door with a key, all the other doors and tailgate lock at the same time. When unlocking, the driver's door unlocks first. Turn the key a second time within a few seconds to unlock the remaining doors and the tailgate.

You can customize the door unlock mode setting.

▶▶ **Customized Features** P. 102, 116

▶▶ Locking a Door Without Using a Key

When you lock the driver's door, all the other doors and tailgate lock at the same time. Make sure you have the key in your hand before locking the door to prevent it from being locked in the vehicle.

Locking/Unlocking the Doors from the Inside

■ Using the Lock Tab

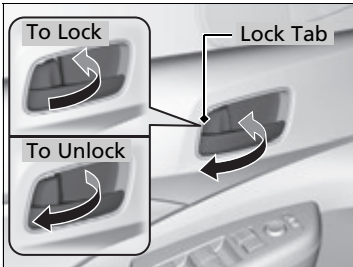

■ **Locking a door**
Push the lock tab forward.

■ **Unlocking a door**
Pull the lock tab rearward.

■ Unlocking Using the Front Door Inner Handle

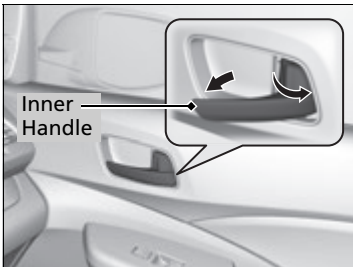

Pull the front door inner handle.
▶ The door unlocks and opens in one motion.

☒ Using the Lock Tab

When you lock the door using the lock tab on the driver's door, all the other doors and tailgate lock at the same time.

When you unlock the door using the lock tab on the driver's door, only the driver's door will unlock.

☒ Unlocking Using the Front Door Inner Handle

The front door inner handles are designed to allow front seat occupants to open the door in one motion. However, this feature requires that front seat occupants never pull a front door inner handle while the vehicle is in motion.

Children should always ride in a rear seat where childproof door locks are provided.

☒ **Childproof Door Locks** P. 140

■ Using the Master Door Lock Switch

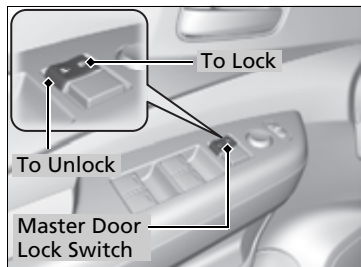

Press the master door lock switch in as shown to lock or unlock all doors and the tailgate.

▣ Using the Master Door Lock Switch

When you lock/unlock the driver's door using the master door lock switch, all the other doors and the tailgate lock/unlock at the same time.

The front passenger's door also has the master door lock switch.

Childproof Door Locks

The childproof door locks prevent the rear doors from being opened from the inside regardless of the position of the lock tab.

▣ Childproof Door Locks

To open the door from the inside when the childproof door lock is on, put the lock tab in the unlock position, lower the rear window, put your hand out of the window, and pull the outside door handle.

■ Setting the Childproof Door Locks

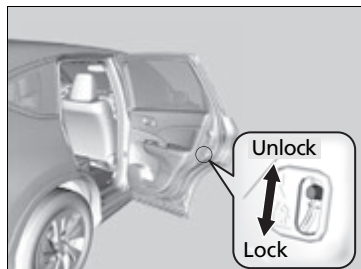

Slide the lever in the rear door to the lock position, and close the door.

■ When opening the door

Open the door using the outside door handle.

Auto Door Locking/Unlocking

Your vehicle locks all doors and unlocks the driver's door automatically when a certain condition is met.

■ Auto Door Locking

■ Drive lock mode

All doors and tailgate lock when the vehicle's speed reaches about 10 mph (15 km/h).

■ Auto Door Unlocking

■ Driver's door open mode

All doors unlock when the driver's door is opened.

☒ Auto Door Locking/Unlocking

You can turn off or change to another auto door locking/unlocking setting using the i-MID.

☒ **Customized Features** P. 116

Precautions for Opening/Closing the Tailgate

Always make sure individuals and objects are clear of the tailgate before opening or closing it.

■ Opening the tailgate

- Open the tailgate all the way.
 - ▶ If it is not fully opened, the tailgate may begin to close under its own weight.
- Be careful when it is windy. The wind may cause the tailgate to close.

■ Closing the tailgate

Keep the tailgate closed while driving to:

- ▶ Avoid possible damage.
- ▶ Prevent exhaust gas from leaking into the vehicle.
- **Carbon Monoxide Gas** P. 67

⚠ Precautions for Opening/Closing the Tailgate

Be careful not to hit your head on the tailgate or to put your hands between the tailgate and the cargo area when closing the tailgate.

When you are storing or picking up luggage from the cargo area while the engine is idling, do not stand in front of the exhaust pipe. You may get burned.

Do not allow any passenger in the cargo space. They may get hurt during hard braking, a sudden acceleration, or a crash.

■ Using the Tailgate Release Button

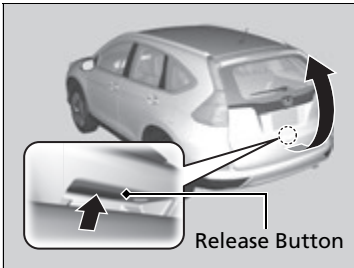

When all the doors are unlocked or press the tailgate unlock button on the remote transmitter, the tailgate is unlocked.

Models without power tailgate

Press the tailgate release button and lift open the tailgate.

Models with power tailgate

Press the tailgate release button for more than one second, and wait until you hear two beeps before you lift open the tailgate.

- ▶ Releasing the release button within one second with one beep enables the power tailgate operations.

➤ **Opening/Closing the Power Tailgate***
P. 145

Models with smart entry system

If you are carrying the smart entry remote, you do not have to unlock the tailgate before opening it.

⌘ Using the Tailgate Release Button

Do not leave the key, remote transmitter*, or smart entry remote* in the cargo area before closing the tailgate.

Models with smart entry system

Even if you are not carrying the smart entry remote, you can lock/unlock the tailgate while someone else with the remote is within range.

Models with power tailgate

You can change the power tailgate operation setting on and off.

➤ **Customized Features** P. 102

* Not available on all models

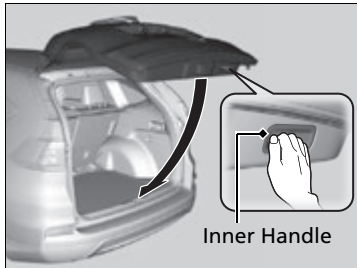

To close the tailgate, grab the inner handle, pull the tailgate down, and push it closed from outside.

■ Using the Remote Transmitter*

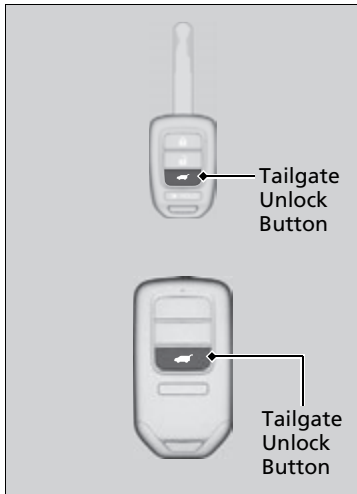

Press the tailgate unlock button to unlock the tailgate.

▣ Using the Remote Transmitter*

If you have unlocked and opened the tailgate using the remote transmitter or smart entry remote*, when closing, the tailgate locks automatically.

Opening/Closing the Power Tailgate*

The power tailgate can be operated by pressing the power tailgate button on the remote transmitter, pressing the power tailgate button in the driver side control panel, or pressing the button on the tailgate.

■ The power tailgate can be opened when:

- The tailgate is fully closed.
- The shift lever is in **P**.

■ The power tailgate can be closed when:

- The tailgate is fully open.
- The shift lever is in **P**.

ⓘ Opening/Closing the Power Tailgate*

⚠ WARNING

Closing a power tailgate while anyone is in the path of the tailgate can cause serious injury.

Make sure everyone is clear before closing the power tailgate.

NOTICE

Do not push or pull on the power tailgate when it is being automatically opened or closed. Forcibly opening or closing the power tailgate while in operation can deform the tailgate frame.

When operating the power tailgate, make sure there is enough space around your vehicle. People near the tailgate may be seriously hurt if the tailgate hits or closes on their heads. Be especially cautious if children are around.

The power tailgate may not open or close under the following conditions:

- You start the engine while the tailgate is automatically opening or closing.
- The vehicle is parked on a steep hill.
- The vehicle is swayed in a strong wind.
- The tailgate or the roof is covered with snow or ice.

If you close the power tailgate with all the doors locked, the power tailgate locks automatically.

Remote Transmitter

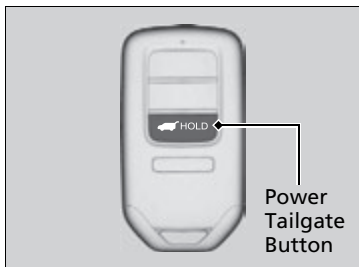

Press the power tailgate button for more than one second to operate when the power mode is in VEHICLE OFF (LOCK).

To reverse direction while the power tailgate is in operation, press the button again. The beeper sounds three times and the tailgate reverses direction.

Customizing when to open the tailgate

ANYTIME: The power tailgate unlocks and opens at the same time. This is the default setting.

WHEN UNLOCKED: The tailgate opens when all doors are unlocked.

➤ **Customized Features** P. 102, 116

Opening/Closing the Power Tailgate*

If you close the power tailgate when all the doors are locked, the power tailgate locks automatically.

If you replace the battery or the power tailgate fuse while the tailgate is open, the power tailgate may be disabled. The power tailgate resumes once you manually close the tailgate.

Installing aftermarket components other than genuine Honda accessories on the power tailgate may prevent it from fully opening or closing.

Make sure the power tailgate is fully open before you get your luggage in and out.

Make sure the power tailgate is fully closed before you start the vehicle.

The beeper sounds when you start driving while the power tailgate is still open, or closing.

Power Tailgate Button

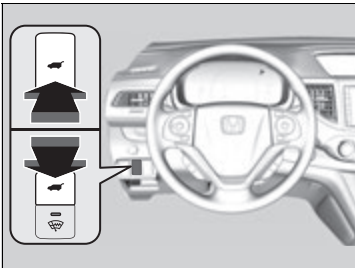

To open: Press and hold the tailgate button in the driver side control panel for about one second.

- ▶ Some exterior lights flash and the beeper sounds.

To close: Press and hold the tailgate button in the driver side control panel for about one second.

- ▶ Some exterior lights flash and the beeper sounds.

To reverse direction while the power tailgate is in operation, press the button again.

Power Tailgate Close Button

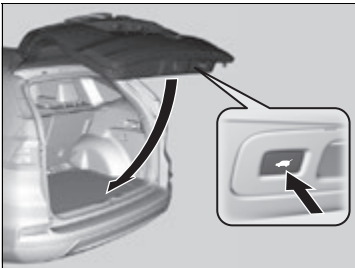

Press the button on the tailgate to close the power tailgate.

If you press the button again while the power tailgate is closing, it stops and reverses direction.

Opening/Closing the Power Tailgate*

If the power tailgate meets resistance while opening or closing, the auto reverse feature reverses the direction. The beeper sounds three times.

The auto reverse function stops sensing when the tailgate is almost closed to make sure that it fully closes.

Do not touch the sensors located on both sides of the tailgate. The power tailgate does not close if you touch either sensor when you are trying to close the tailgate.

Be careful not to scratch the sensors with a sharp object. If scratched, they can be damaged, and the power tailgate closing feature malfunctions.

Power Tailgate Close Button

If you press the tailgate release button inside the handle while the tailgate is automatically opening or closing, the power tailgate operation stops. Use caution if the tailgate stops in the middle of either operation. It may suddenly swing up or down.

* Not available on all models

■ Auto-Closer

If you manually close the power tailgate, it latches automatically.

■ Power Tailgate Fall Detection

Automatically lowers the power tailgate when there is a possibility that the fully opened power tailgate can fall down by its own weight (for example, by snow on the tailgate). The beeper sounds while the power tailgate lowers.

☒ Auto-Closer

The auto-closer feature does not activate if you push the tailgate open button while the power tailgate is closing.

Do not put any force on the tailgate while the power tailgate is latching.

Keep your hands away from the tailgate when you manually close the tailgate and let it latch automatically. It is dangerous to put your hands around the tailgate as it starts to latch itself.

☒ Power Tailgate Fall Detection

If you try to manually close the power tailgate immediately after it fully opens, the power tailgate fall detection may activate

Once the power tailgate fall detection activates, wait until the power tailgate fully closes. Keep away from the power tailgate when it is in motion.

If the power tailgate fall detection constantly activates, consult at a dealer.

Immobilizer System

The immobilizer system prevents a key that has not been pre-registered from starting the engine. Each key contains electronic transmitters that use electronic signals to verify the key.

Pay attention to the following when inserting the key into the ignition switch or pressing the **ENGINE START/STOP** button*:

- Do not allow objects that emit strong radio waves near the ignition switch*1.
- Make sure the key is not covered by or touching a metal object.
- Do not bring a key from another vehicle's immobilizer system near the ignition switch.

Security System Alarm*

The security system alarm activates when the tailgate, hood or doors are forcibly opened. The alarm does not go off if the tailgate or doors are opened with the key, remote transmitter or smart entry system.

However, the alarm goes off when a door is opened with the key, then the shift lever is moved out of **P** or the hood is opened before the ignition switch is in ON **II***1.

■ When the security system alarm activates

The horn sounds intermittently and all the exterior lights flash.

*1: Models with the smart entry system have an **ENGINE START/STOP** button instead of an ignition switch.

* Not available on all models

☒ Immobilizer System

NOTICE

Leaving the ignition key in the vehicle can result in theft or accidental movement of the vehicle. Always take the ignition key with you whenever you leave the vehicle unattended.

Do not alter the system or add other devices to it. Doing so may damage the system and make your vehicle inoperable.

☒ Security System Alarm*

The security alarm continues for a maximum of two minutes until the security system deactivates.

■ To deactivate the security system alarm

Unlock the vehicle using the remote transmitter or smart entry system. The system, along with the horn and flashing lights, is deactivated.

■ Setting the security system alarm

The security system alarm automatically sets when the following conditions have been met:

- The ignition switch is in LOCK **[0]***1, and the key has been removed from the ignition switch.
- The hood and tailgate are closed.
- All doors and tailgate are locked with the key or the remote transmitter.

■ When the security system alarm sets

The security system alarm indicator in the instrument panel blinks. When the blinking interval changes after about 15 seconds, the security system alarm is set.

■ To cancel the security system alarm

The security system is canceled when the vehicle is unlocked using the remote transmitter, or smart entry system, or the ignition switch is in ON **[II]***1. The security system indicator goes off at the same time.

*1: Models with the smart entry system have an **ENGINE START/STOP** button instead of an ignition switch.

* Not available on all models

⌘ Security System Alarm*

Do not set the security system alarm when someone is in the vehicle or a window is open. The system can accidentally activate when:

- Unlocking the door with the lock tab.
- Opening the hood with the hood release handle.
- Moving the shift lever out of **[P]**.

If the battery goes dead after you have set the security system alarm, the security alarm may go off once the battery is recharged or replaced.

If this occurs, deactivate the security system alarm by unlocking a door using the key or remote transmitter.

Do not attempt to alter this system or add another device to it.

■ Panic Mode

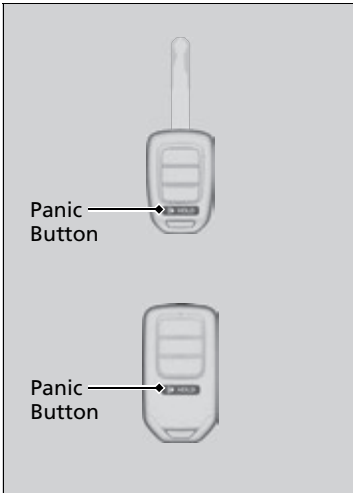

■ The panic button on the remote transmitter

If you press the panic button for approximately one second, the following will occur for about 30 seconds:

- The horn sounds.
- Some exterior lights flash.

■ Canceling panic mode

Press any button on the remote transmitter, or turn the ignition switch to ON *1.

*1: Models with the smart entry system have an **ENGINE START/STOP** button instead of an ignition switch.

Opening/Closing the Power Windows

The power windows can be opened and closed when the ignition switch is in ON **II***1, using the switches on the doors. The driver side switches can be used to open and close all the windows.

The power window lock button on the driver side must be switched off (not pushed in, indicator off) to open and close the windows from anywhere other than the driver's seat.

When the power window lock button is switched on (pushed in, indicator on), you can only operate the driver's window. Turn the power window lock button on if a child is in the vehicle.

Opening/Closing the Power Windows

WARNING

Closing a power window on someone's hands or fingers can cause serious injury.

Make sure your passengers are away from the windows before closing them.

The power windows can be operated for up to 10 minutes after you turn the ignition switch off. Opening either front door cancels this function.

Auto Reverse

If a power window senses resistance when closing automatically, it stops closing and reverse direction.

The driver's window auto reverse function is disabled when you continuously pull up the switch.

The auto reverse function stops sensing when the window is almost closed to ensure that it fully closes.

Opening/Closing Windows with Auto-Open/Close Function

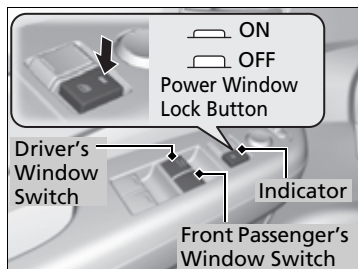

Automatic operation

To open: Push the switch down firmly.

To close: Pull the switch up firmly.

The window opens or closes completely. To stop the window at any time, push or pull the switch briefly.

Manual operation

To open: Push the switch down lightly, and hold it until the desired position is reached.

To close: Pull the switch up lightly, and hold it until the desired position is reached.

*1: Models with the smart entry system have an **ENGINE START/STOP** button instead of an ignition switch.

■ Opening/Closing Windows without Auto-Open/Close Function

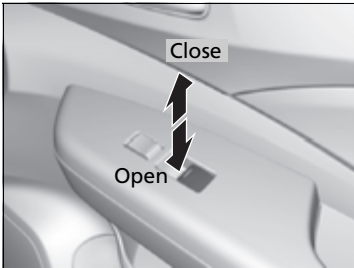

To open: Push the switch down.

To close: Pull the switch up.

Release the switch when the window reaches the desired position.

Opening/Closing the Moonroof

You can operate the moonroof when the ignition switch is in ON *1. Use the switch in the front of the ceiling to open and close the moonroof.

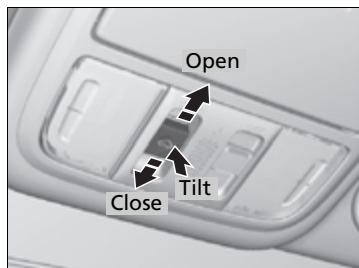

Automatic operation

To open: Pull the switch back firmly.

To close: Push the switch forward firmly.

The moonroof automatically opens or closes all the way. To stop the moonroof midway, touch the switch briefly.

Manual operation

To open: Pull the switch back lightly, and hold it until the desired position is reached.

To close: Push the switch forward lightly, and hold it until the desired position is reached.

Tilting the moonroof up

To tilt: Push on the center of the moonroof switch.

To close: Push the switch forward firmly, then release.

Opening/Closing the Moonroof

WARNING

Opening or closing the moonroof on someone's hands or fingers can cause serious injury.

Make sure all hands and fingers are clear of the moonroof before opening or closing it.

NOTICE

Opening the moonroof in below freezing temperature or when it is covered with snow or ice can damage the moonroof panel or motor.

The power moonroof can be operated for up to 10 minutes after you turn the ignition switch off. Opening either front door cancels this function.

When resistance is detected, the auto reverse function causes the moonroof to change directions, then stop. Auto reverse stops sensing when the moonroof is almost closed to ensure that it fully closes.

*1: Models with the smart entry system have an **ENGINE START/STOP** button instead of an ignition switch.

* Not available on all models

Operating the Switches Around the Steering Wheel

Models with ignition keys with remote transmitter

Ignition Switch

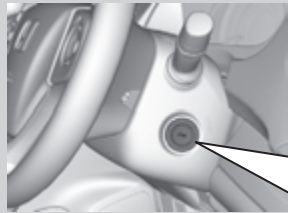

- 0** LOCK: Insert and remove the key in this position.
- I** ACCESSORY: Operate the audio system and other accessories in this position.
- II** ON: This is the position when driving.
- III** START: This position is for starting the engine. The switch returns to ON **II** when you let go of the key.

Ignition Switch

You cannot take the key out unless the shift lever is in **P**.

If you open the driver's door when the key is in LOCK **0** or ACCESSORY **I**, a warning buzzer will sound to remind you to take the key out.

If the key won't turn from LOCK **0** to ACCESSORY **I**, turn the key while moving the steering wheel left and right. The steering wheel will unlock, allowing the key to turn.

Models with smart entry remote

ENGINE START/STOP Button

Changing the Power Mode

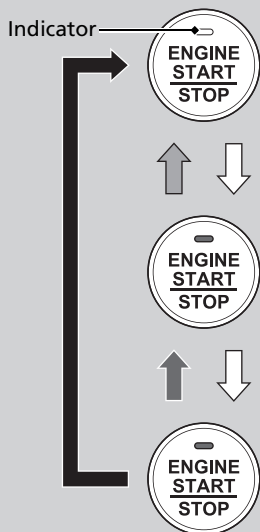

VEHICLE OFF (LOCK)

Indicator in the button is off.
The steering wheel is locked*1.
The power to all electrical components is turned off.

ACCESSORY

Indicator in the button is on.
Indicator in the button blinks (from ON to ACCESSORY).
Operate the audio system and other accessories in this position.

ON

Indicator in the button is on.
All electrical components can be used.

Without pressing the brake pedal

- ➡ Press the button without the shift lever in **P**.
- ➡ Shift to **P** then press the button.

➡ Press the button.

U.S. models
➡ Shift to **P**.

ENGINE START/STOP Button

ENGINE START/STOP Button Operating Range

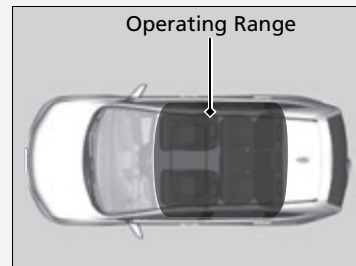

You can start the engine when the smart entry remote is inside the vehicle.
The engine may also run if the smart entry remote is close to the door or window, even if it is outside the vehicle.

ON mode:
Indicator in the button is off, if the engine is running.

If the smart entry remote battery is weak, beeper sounds and the **TO START, HOLD REMOTE NEAR START BUTTON** message appears on the i-MID.

⚠ If the Smart Entry Remote Battery is Weak
P. 502

Do not leave the power mode in ACCESSORY or ON when you get out.

*1: Canadian models

Automatic Power Off

If you leave the vehicle for 30 to 60 minutes with the shift lever in **[P]** and the power mode in ACCESSORY, the vehicle automatically goes into the mode similar to VEHICLE OFF (LOCK) to avoid the battery drain.

Canadian models

When in this mode:

The steering wheel does not lock.

You cannot lock or unlock doors with the remote transmitter or the smart entry system.

Press the **ENGINE START/STOP** button three times to switch the mode to VEHICLE OFF (LOCK).

ENGINE START/STOP Button

Canadian models

If the power mode does not change from VEHICLE OFF to ACCESSORY, press the **ENGINE START/STOP** button while moving the steering wheel left and right. The steering wheel will unlock, allowing the mode to change.

■ Power Mode Reminder

If you open the driver's door when the power mode is set to ACCESSORY, a warning buzzer sounds.

■ Smart Entry Remote Reminder

Smart Entry Remote Reminder

Models without multi-information display



Models with multi-information display



Warning buzzers may sound from inside or/ and outside the vehicle to remind you that the smart entry remote is out of the vehicle. If the buzzer continues even after the remote is put back inside, place it within its operational range.

■ When the power mode is in ON

If the smart entry remote is taken out of the vehicle, and the driver's door is closed, warning buzzers sound from both inside and outside the vehicle. A warning message on the information display/multi-information display notifies the driver inside that the remote is out.

■ When the power mode is in ACCESSORY

If the smart entry remote is taken out of the vehicle, and all the doors are closed, a warning buzzer sounds from outside the vehicle.

When the smart entry remote is within the system's operational range, and the driver's door is closed, the warning function cancels.

If the smart entry remote is taken out of the vehicle after the engine has been started, you can no longer change the **ENGINE START/STOP** button mode or restart the engine. Always make sure if the remote is in your vehicle when you operate the **ENGINE START/STOP** button.

Removing the smart entry remote from the vehicle through a window does not activate the warning buzzer.

Do not put the smart entry remote on the dashboard or in the glove box. It may cause the warning buzzer to go off. Under some other conditions that can prevent the vehicle from locating the remote, the warning buzzer may also go off even if the remote is within the system's operational range.

Ignition Switch and Power Mode Comparison

| Ignition Switch Position | LOCK (0) (with/without the key) | ACCESSORY (I) | ON (II) | START (III) |
|---|--|--|---|---|
| Without Smart Entry System | <ul style="list-style-type: none"> • Engine is turned off and power is shut down. • The steering wheel is locked. • No electrical components can be used. | <ul style="list-style-type: none"> • Engine is turned off. • Some electrical components such as the audio system can be operated. | <ul style="list-style-type: none"> • Normal key position while driving. • All electrical components can be used. | <ul style="list-style-type: none"> • Use this position to start the engine. • The ignition switch returns to the ON (II) position when you release the key. |
| Power Mode | VEHICLE OFF (LOCK) | ACCESSORY | ON | START |
| With Smart Entry System and ENGINE START/STOP Button | Indicator-Off <ul style="list-style-type: none"> • Engine is turned off and power is shut down. • The steering wheel is locked*1. • No electrical components can be used. | Indicator-On or blinking <ul style="list-style-type: none"> • Engine is turned off. • Some electrical components such as the audio system can be operated. | Indicator- On (engine is turned off) Off (engine is running) <ul style="list-style-type: none"> • All electrical components can be used. | Indicator-Off <ul style="list-style-type: none"> • The mode automatically returns to ON after the engine starts. |

*1:Canadian models

Turn Signals

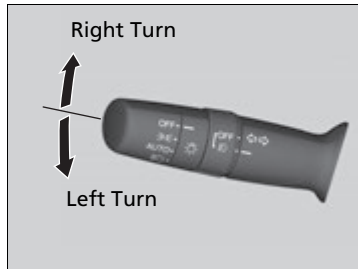

The turn signals can be used when the ignition switch is in ON **II***1.

■ One-touch turn signal

When you lightly push up or down and release the turn signal lever, the exterior turn signals and turn signal indicator blink three times.

This feature can be used when signaling for a lane change.

*1: Models with the smart entry system have an **ENGINE START/STOP** button instead of an ignition switch.

Light Switches

Manual Operation

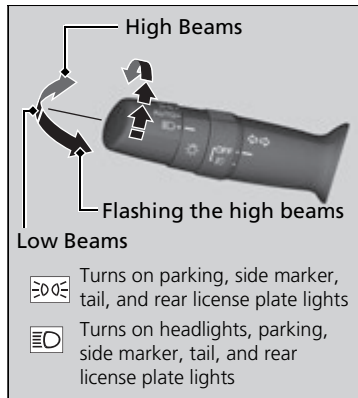

Rotating the light switch turns the lights on and off, regardless of the position of the ignition switch.

■ High beams

Push the lever forward until you hear a click.

■ Low beams

When in high beams, pull the lever back to return to low beams.

■ Flashing the high beams

Pull the lever back, and release it.

Light Switches

Models without smart entry system

If you remove the key from the ignition switch with the lights on, a light on reminder chime sounds when you open the driver's door.

Models with smart entry system

If you leave the power mode in VEHICLE OFF (LOCK) while the lights are on, a chime sounds when the driver's door is opened.

All models

Do not leave the lights on when the engine is off because it will cause the battery to discharge.

■ Automatic Lighting Control*

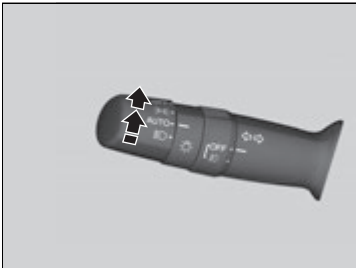

Automatic lighting control can be used when the power mode is in ON.

When you turn the light switch to **AUTO**, the headlights and other exterior lights will switch on and off automatically depending on the ambient brightness.

▶ You can change the auto light sensitivity setting.

▶ **Customized Features** P. 102, 116

■ Headlight Integration with Wipers*

The headlights automatically come on when the wipers are used several times within a certain interval with the headlight switch in **AUTO**.

The headlights automatically go off a few minutes later if the wipers are stopped.

▶▶ Automatic Lighting Control*

We recommend that you turn on the lights manually when driving at night, in a dense fog, or in dark areas such as long tunnels or parking facilities.

The light sensor is in the location shown below. Do not cover this light sensor with anything; otherwise, the automatic lighting system may not work properly.

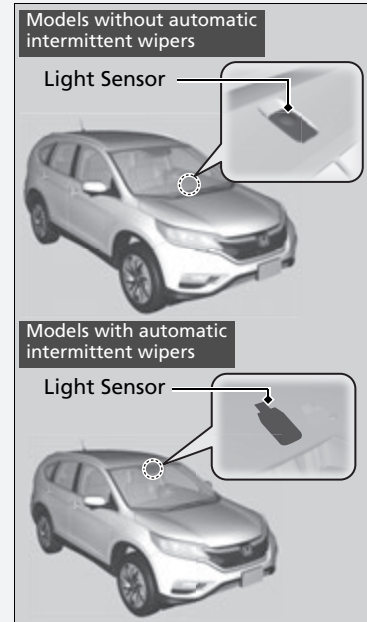

Automatic Lighting Off Feature

The headlights, all other exterior lights, and the instrument panel lights turn off 15 seconds after you remove the key or set the power mode to VEHICLE OFF (LOCK), take the remote with you, and close the driver's door.

▶ You can change the headlight auto off timer setting.

🔧 **Customized Features** P. 102, 116

If you turn the ignition switch to LOCK *1 with the headlight switch on, but do not open the door, the lights turn off after 10 minutes (three minutes, if the switch is in the **AUTO** position).

The lights turn on again when you unlock or open the driver's door. If you unlock the door, but do not open it within 15 seconds, the lights go off. If you open the driver's door, you will hear a lights on reminder chime.

*1: Models with the smart entry system have an **ENGINE START/STOP** button instead of an ignition switch.

* Not available on all models

Automatic Lighting Control*

Adjust the auto light sensitivity as follows:

| Setting | The exterior lights come on when the ambient light is at | |
|---------|---|--------|
| Max |  | |
| High | | Bright |
| Mid | | |
| Low | | |
| Min | | Dark |

Fog Lights*

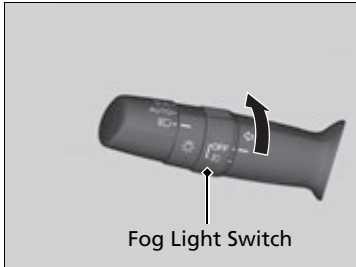

Can be used when the low beam headlights are on.

Rotate the switch up from the **OFF** position to the  position.

⌘ Fog Lights*

When the fog lights are on, the indicator in the instrument panel will be on.

The fog lights go off when the headlights turn off, or when the daytime running lights are on.

Daytime Running Lights

Models without smart entry system

The high beam headlights come on slightly dimmer than normal when the following conditions have been met:

- The ignition switch is in ON **II**.
- The headlight switch is off.
- The parking brake is released.

The lights remain on even if you set the parking brake. Turning off the ignition switch will turn off the daytime running lights.

The high beam headlights return to the original brightness once the headlight switch is turned on.

Models with smart entry system

The daytime running lights come on when the following conditions have been met:

- The power mode is set to ON.
- The headlight switch is off.
- The parking brake is released.

The lights remain on even if you set the parking brake. Setting the power mode to VEHICLE OFF turns off the daytime running lights.

The daytime running lights are off the headlight switch is turned on, or when the headlight switch is in **AUTO** and it is getting darker outside.

Wipers and Washers

■ Windshield Wipers/Washers

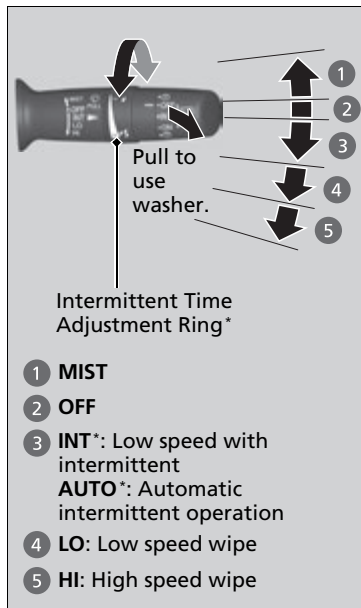

The windshield wipers and washers can be used when the ignition switch is in ON *1.

■ MIST

The wipers run at high speed until you release the lever.

■ Wiper switch (OFF, INT*, LO, HI)

Change the wiper switch setting according to the amount of rain.

■ AUTO*

Automatic Intermittent Wipers* P. 167

■ Adjusting wiper operation*

Turn the adjustment ring to adjust wiper operation.

Lower speed, fewer sweeps

Higher speed, more sweeps

■ Washer

Sprays while you pull the lever toward you. When you release the lever for more than one second, the spray stops, the wipers sweep two or three more times to clear the windshield, then stop.

»» Wipers and Washers

NOTICE

Do not use the wipers when the windshield is dry. The windshield will get scratched, or the rubber blades will get damaged.

NOTICE

In cold weather, the blades may freeze to the windshield, becoming stuck. Operating the wipers in this condition may damage the wipers. Use the defroster to warm the windshield, then turn the wipers on.

Turn the washers off if no washer fluid comes out. The pump may get damaged.

Models with intermittent time adjustment ring

If the vehicle speeds up while the wipers are operating intermittently, the length of the wiper interval shortens. When the vehicle starts moving, the wipers make a single sweep.

When the vehicle speeds up, the wiper operation's shortest delay setting and the **LO** setting become the same.

If the wiper stops operating due to any obstacle such as the build-up of snow, park the vehicle in a safe place. Rotate the wiper switch to **OFF**, and turn the ignition switch to ACCESSORY or LOCK *1, then remove the obstacle.

*1: Models with the smart entry system have an **ENGINE START/STOP** button instead of an ignition switch.

* Not available on all models

Automatic Intermittent Wipers*

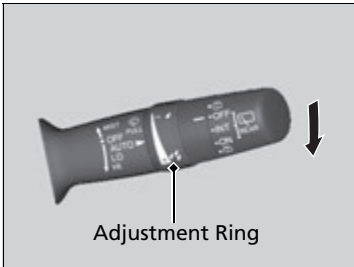

When you push the lever down to **AUTO**, the windshield wipers sweep once, and go into the automatic mode.

The wipers operate intermittently, at low speed, or at high speed and stops in accordance with the amount of rainfall the rainfall sensor detects.

■ AUTO sensitivity adjustment

When in **AUTO**, you can also adjust the rainfall sensor sensitivity using the adjustment ring.

Sensor sensitivity



Low Sensitivity: Wipers will operate when more rainfall is detected.

High Sensitivity: Wipers will operate when less rainfall is detected.

Wipers and Washers

The wiper motor may stop motor operation temporarily to prevent an overload. Wiper operation will return to normal within a few minutes, once the circuit has returned to normal.

Automatic Intermittent Wipers*

The rainfall sensor is in the location shown below.

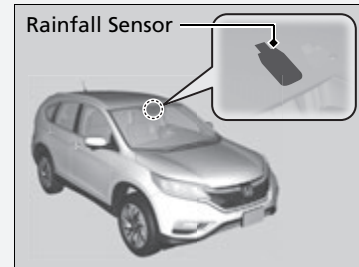

Do not put the wiper lever in **AUTO** when cleaning the windshield or driving through a car wash. If the wiper lever is in **AUTO**, and the power mode is in ON, the rainfall sensor may respond to your hand or car wash liquids, and the wipers may operate automatically.

* Not available on all models

■ Rear Wiper/Washer

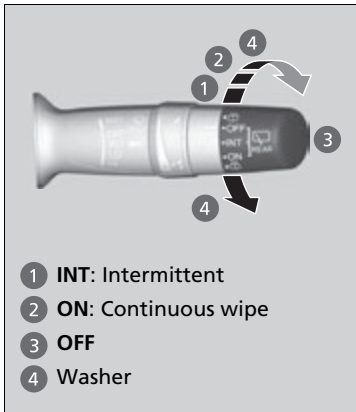

The rear wiper and washer can be used when the ignition switch is in ON *1.

■ Wiper switch (OFF, INT, ON)

Change the wiper switch setting according to the amount of rain.

■ Washer ()

Sprays while you rotate the switch to this position.

Hold it to activate the wiper and to spray the washer. Once released, it stops operating after a few more sweeps.

■ Operating in reverse

When you shift the transmission to  with the windshield wipers activated, the rear wiper operates automatically as follows even if its switch is off.

| Front Wiper Position | Rear Wiper Operation |
|---|----------------------|
| INT (Intermittent) | Intermittent |
| LO (Low speed wipe) HI (High speed wipe) | Continuous |

*1: Models with the smart entry system have an **ENGINE START/STOP** button instead of an ignition switch.

Brightness Control

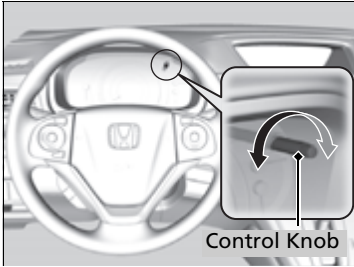

When the parking lights are turned on and the ignition switch is in ON *1, you can use the brightness control knob to adjust instrument panel brightness.

Brighten: Turn the knob to the right.

Dim: Turn the knob to the left.

You will hear a beep when the brightness reaches minimum or maximum. The information display will return to its original state several seconds after you adjust the brightness.

■ Brightness level indicator

The brightness level is shown on the information display while you are adjusting it.

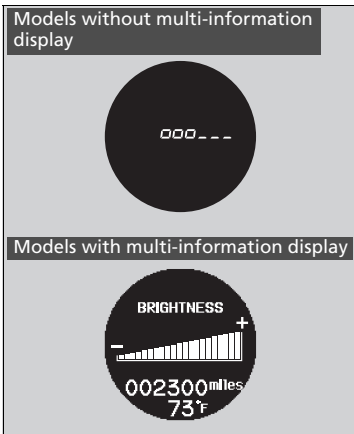

*1: Models with the smart entry system have an **ENGINE START/STOP** button instead of an ignition switch.

☒ Brightness Control

Instrument panel brightness differs between when the exterior lights are on and when they are off. The instrument panel dims to reduce glare when the lights are on.

Pressing the  (Select/Reset) knob changes to a different display.

If you turn the knob to the right until the brightness display is up to max, the beeper sounds. This cancels the reduced instrument panel brightness when the exterior lights are on.

Defogger/Heated Door Mirror*

■ Rear Defogger/Heated Door Mirror* Button

Press the rear defogger and heated door mirror button to defog the rear window and mirrors when the ignition switch is in ON ^{*1}.

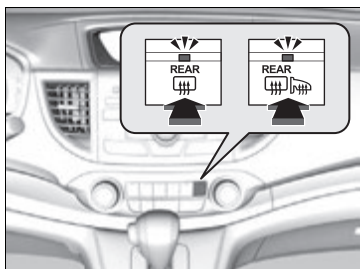

Models with heating and cooling system

The rear defogger and heated door mirrors automatically switch off after 20 minutes. However, if the outside temperature is 18°F (−8°C) or below, they do not automatically switch off.

Models with climate control system

The rear defogger and heated door mirrors automatically switch off after 10-30 minutes depending on the outside temperature. However, if the outside temperature is 32°F (0°C) or below, they do not automatically switch off.

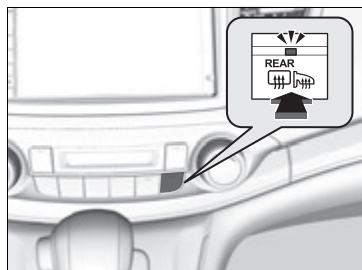

▣ Rear Defogger/Heated Door Mirror* Button

NOTICE

When cleaning the inside of the rear window, be careful not to damage the heating wires. It is critical to wipe the window from side to side along the defogger heating wires.

This system consumes a lot of power, and may weaken the battery, making it difficult to start the engine. Turn it off when the window has been defogged. Also, do not use the system for a long period even if the engine is idling.

*1: Models with the smart entry system have an **ENGINE START/STOP** button instead of an ignition switch.

* Not available on all models

Canadian models

■ Heated Windshield Button*

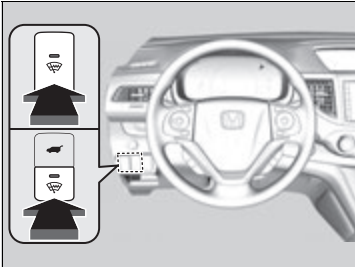

Press the heated windshield button to deice the windshield when the power mode is in ON.

The front defogger automatically switches off after 15 minutes.

⌘ Heated Windshield Button*

This system consumes a lot of power, and may weaken the battery, making it difficult to start the engine. Turn it off when the window has been defogged.

Also, do not use the system for a long period even if the engine is idling.

* Not available on all models

Driving Position Memory System*

You can store two driver's seat positions (except for power lumbar) with the driving position memory system.

When you unlock and open the driver's door with a remote transmitter or the smart entry system, the seat adjusts automatically to one of the two preset positions.

- **DRIVER 1** transmitter is linked to memory button 1.
- **DRIVER 2** transmitter is linked to memory button 2.



Storing a Position in Memory

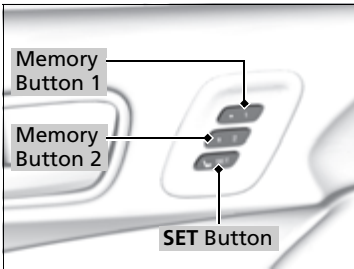

1. Set the power mode to ON. Adjust the driver's seat to the desired position.
2. Press the **SET** button.
 - ▶ You will hear a beep, and the memory button indicator light will blink.
3. Press and hold memory button **1** or **2** within five seconds of pressing the **SET** button.
 - ▶ Once the seat position has been memorized, the indicator light on the button you pressed stays on.

Recalling the Stored Position

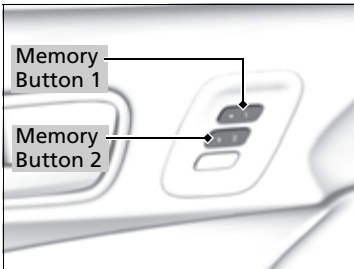

1. Move the shift lever to **P**.
2. Apply the parking brake.
3. Press a memory button (**1** or **2**).
 - ▶ You will hear a beep, and the indicator light will blink.

The seat will automatically move to the memorized position. When it has finished moving, you will hear a beep, and the indicator light stays on.

Storing a Position in Memory

After you press the **SET** button, the storing operation will be canceled when:

- You do not press the memory button within five seconds.
- You readjust the seat position before the double-beep.
- You set the power mode to any position except ON.

Recalling the Stored Position

The seat will stop moving if you:

- Press the **SET** button, or a memory button (**1** or **2**).
- Adjust the seat position.
- Shift into any position except **P**.

Adjusting the Steering Wheel

The steering wheel height and distance from your body can be adjusted so that you can comfortably grip the steering wheel in an appropriate driving posture.

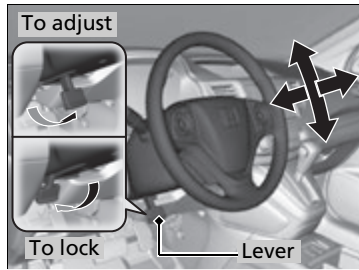

1. Pull the steering wheel adjustment lever up.
 - ▶ The steering wheel adjustment lever is under the steering column.
2. Move the steering wheel up or down, and in or out.
 - ▶ Make sure you can see the instrument panel gauges and indicators.
3. Push the steering wheel adjustment lever down to lock the steering wheel in position.
 - ▶ After adjusting the position, make sure you have securely locked the steering wheel in place by trying to move it up, down, in, and out.

Adjusting the Steering Wheel

WARNING

Adjusting the steering wheel position while driving may cause you to lose control of the vehicle and be seriously injured in a crash.

Adjust the steering wheel only when the vehicle is stopped.

Make any steering wheel adjustments before you start driving.

Adjusting the Mirrors

Interior Rearview Mirror

Adjust the angle of the rearview mirror when you are sitting in the correct driving position.

Rearview Mirror with Day and Night Positions*

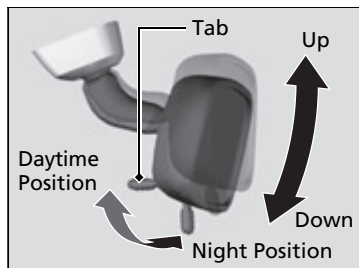

Flip the tab to switch the position. The night position will help reduce the glare from headlights behind you when driving after dark.

Automatic Dimming Rearview Mirror*

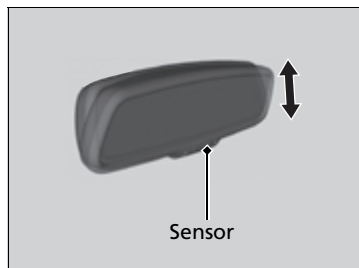

When driving after dark, the automatic dimming rearview mirror reduces the glare from headlights behind you. This feature is always active.

Adjusting the Mirrors

Keep the inside and outside mirrors clean and adjusted for best visibility.

Adjust the mirrors before you start driving.

➤ **Adjusting the Seat Positions** P. 177

Automatic Dimming Rearview Mirror*

The auto dimming function cancels when the shift position is in **R**.

* Not available on all models

Power Door Mirrors

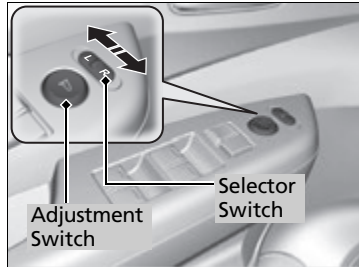

You can adjust the door mirrors when the ignition switch is in ON *1.

■ Mirror position adjustment

L/R selector switch: Select the left or right mirror. After adjusting the mirror, return the switch to the center position.

Mirror position adjustment switch: Press the switch left, right, up, or down to move the mirror.

■ Expanded View Driver's Mirror

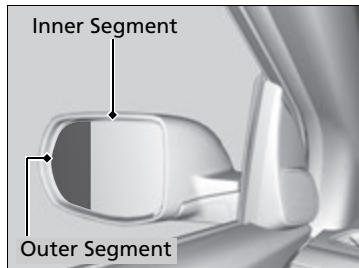

The driver side door mirror has outer and inner segments.

The outer segment is slightly curved to provide a wider angle view than a standard flat mirror. This wider view may help you check areas that are not visible using a standard door mirror.

⊗ Expanded View Driver's Mirror

Objects visible in the outer segment of the driver side door mirror appears smaller than objects in the rest of the mirror. But in fact, they are closer than they appear.

Do not rely on your mirrors. Always look to the side and behind your vehicle before changing lanes.

*1: Models with the smart entry system have an **ENGINE START/STOP** button instead of an ignition switch.

Adjusting the Seat Positions

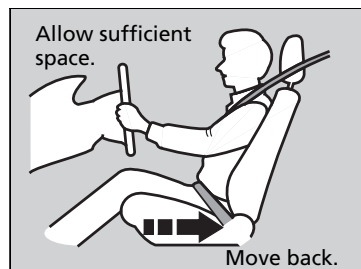

Adjust the driver's seat as far back as possible while allowing you to maintain full control of the vehicle. You should be able to sit upright, well back in the seat and be able to adequately press the pedals without leaning forward, and grip the steering wheel comfortably. The passenger's seat should be adjusted in a similar manner, so that it is as far back from the front airbag in the dashboard as possible.

■ Adjusting the driver's power seat*

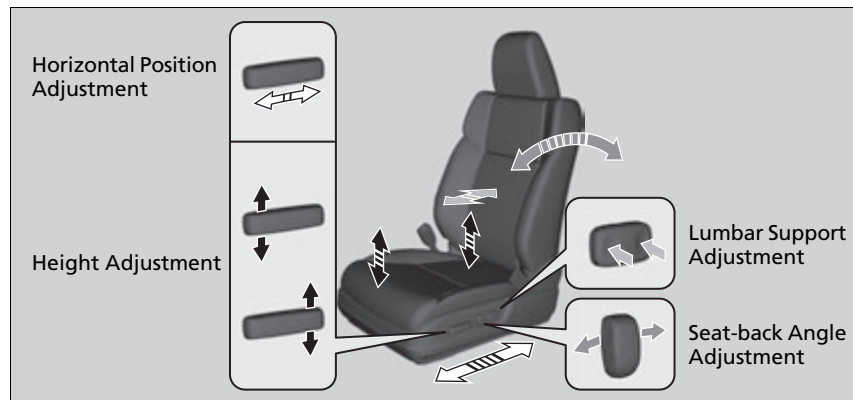

* Not available on all models

Continued

Adjusting the Seats

⚠ WARNING

Sitting too close to a front airbag can result in serious injury or death if the front airbags inflate.

Always sit as far back from the front airbags as possible while maintaining control of the vehicle.

The National Highway Traffic Safety Administration and Transport Canada recommend that drivers allow at least 10 inches (25 cm) between the center of the steering wheel and the chest.

Always make seat adjustments before driving.

■ Adjusting the front manual seat(s)

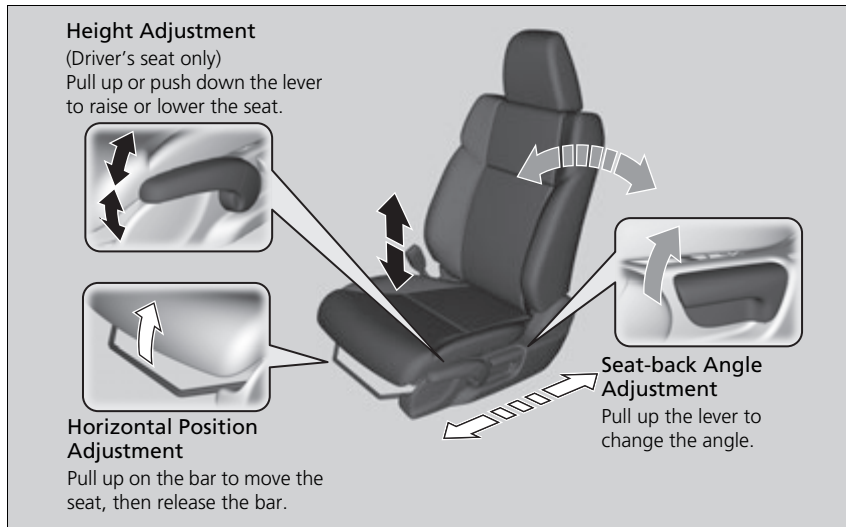

▶ Adjusting the front manual seat(s)

Once a seat is adjusted correctly, rock it back and forth to make sure it is locked in position.

■ Adjusting the Seat-Backs

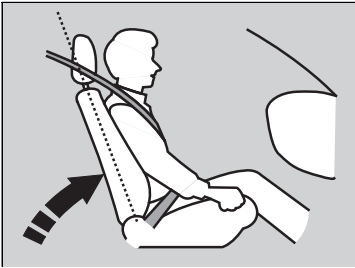

Adjust the driver's seat-back to a comfortable, upright position, leaving ample space between your chest and the airbag cover in the center of the steering wheel.

The front seat passenger should also adjust their seat-back to a comfortable, upright position.

Reclining a seat-back so that the shoulder part of the belt no longer rests against the occupant's chest reduces the protective capability of the belt. It also increases the chance of sliding under the belt in a crash and being seriously injured. The farther a seat-back is reclined, the greater the risk of injury.

▣ Adjusting the Seat-Backs

⚠ WARNING

Reclining the seat-back too far can result in serious injury or death in a crash.

Adjust the seat-back to an upright position, and sit well back in the seat.

Do not put a cushion, or other object, between the seat-back and your back.

Doing so may interfere with proper seat belt or airbag operation.

If you cannot get far enough away from the steering wheel and still reach the controls, we recommend that you investigate whether some type of adaptive equipment may help.

■ Adjusting the Head Restraints

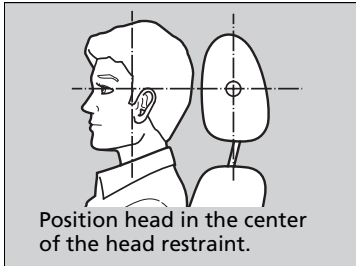

Your vehicle is equipped with head restraints in all seating positions.

Head restraints are most effective for protection against whiplash and other rear-impact crash injuries when the center of the back of the occupant's head rests against the center of the restraint. The tops of the occupant's ears should be level with the center height of the restraint.

■ Adjusting the front head restraint positions

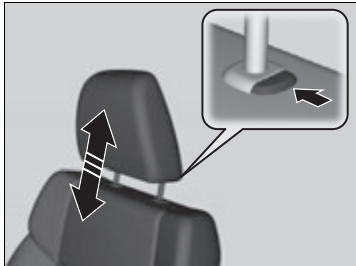

To raise the head restraint: Pull it upward.

To lower the head restraint: Push it down while pressing the release button.

►► Adjusting the Head Restraints

⚠ WARNING

Improperly positioning head restraints reduces their effectiveness and increases the likelihood of serious injury in a crash.

Make sure head restraints are in place and positioned properly before driving.

In order for the head restraint system to work properly:

- Do not hang any items on the head restraints, or from the restraint legs.
- Do not place any objects between an occupant and the seat-back.
- Install each restraint in its proper location.

■ Changing the Rear Center Seat Head Restraint Position

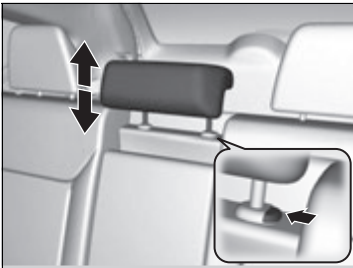

A passenger sitting in the center back seating position should adjust the height of their head restraint to an appropriate position before the vehicle begins moving.

To raise the head restraint:

Pull it upward.

To lower the head restraint:

Push it down while pressing the release button.

■ Removing and Reinstalling the Head Restraints

Front and rear center head restraints

Head restraints can be removed for cleaning or repair.

To remove a head restraint:

Pull the restraint up as far as it will go. Then push the release button, and pull the restraint up and out.

To reinstall a head restraint:

Insert the legs back in place, then adjust the head restraint to an appropriate height while pressing the release button. Pull up on the restraint to make sure it is locked in position.

▣ Removing and Reinstalling the Head Restraints

⚠ WARNING

Failure to reinstall, or correctly reinstall, the head restraints can result in severe injury during a crash.

Always replace the head restraints before driving.

■ Folding Down the Rear Outer Head Restraint

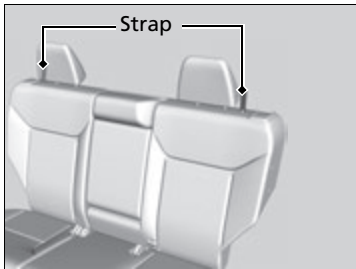

A passenger in an outer back seating position should put the head restraint in the upright position before the vehicle begins moving.

To fold down the head restraint:

Pull the strap.

To put the head restraint back in the upright position:

Pull up the head restraint and push rearward until it latches.

■ Maintain a Proper Sitting Position

After all occupants have adjusted their seats and head restraints, and put on their seat belts, it is very important that they continue to sit upright, well back in their seats, with their feet on the floor until the vehicle is safely parked and the engine is off.

Sitting improperly can increase the chance of injury during a crash. For example, if an occupant slouches, lies down, turns sideways, sits forward, leans forward or sideways, or puts one or both feet up, the chance of injury during a crash is greatly increased.

In addition, an occupant who is out of position in the front seat can be seriously or fatally injured in a crash by striking interior parts of the vehicle or being struck by an inflating front airbag.

ⓘ Maintain a Proper Sitting Position

WARNING

Sitting improperly or out of position can result in serious injury or death in a crash.

Always sit upright, well back in the seat, with your feet on the floor.

Rear Seats

Folding Down the Rear Seats

The rear seats can be folded down separately to allow for additional storage space.

To fold down the seat

1. Store the center seat belt first. Insert the latch plate into the slot on the side of the anchor buckle.
2. Retract the seat belt into the holder on the ceiling.
 Seat Belt with Detachable Anchor P. 38
3. Lower the center head restraint to its lowest position. Put the armrest back into the seat-back.



From the rear door side

4. Pull the release strap.
 - The seat cushion flips forward, the head restraints tilt downward, and the seat-back then folds flat.

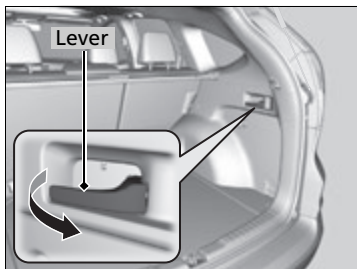

From the cargo area side

4. Pull the release lever.
 - The seat cushion flips forward, the head restraints tilt downward, and the seat-back then folds flat.

Folding Down the Rear Seats

Make sure all items in the cargo area or items extending to the rear seats are properly secured. Loose items can fly forward if you have to brake hard.

Remove any items from the rear seat cushion and floor before you fold down the rear seat.

Make sure the seat-back completely lowers (a click sounds). Otherwise it will not re-latch when returned to the upright position.

The front seat(s) must be far enough forward so they do not interfere with the rear seats as they fold down.

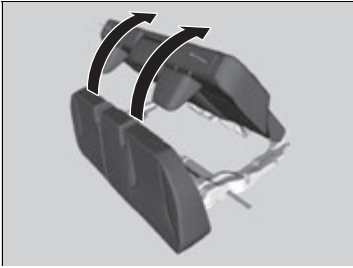

■ To return the seat to the original position

1. Pull the seat-back up and push back into place until a click is heard.
2. Push the head restraint up to its original position.
3. Pull the seat cushion up and push it down into its original position.

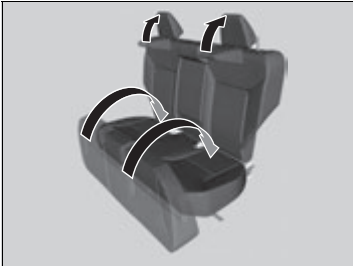

☒ To return the seat to the original position

Make sure the seat-back, head restraints and seat cushion are securely latched back into place before driving.

■ Rear Seat-back Adjusting

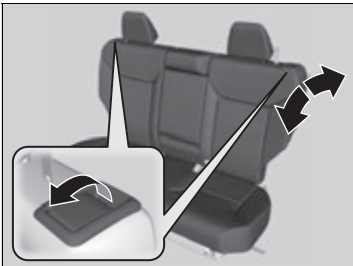

Pull the lever on the right to change the angle of the right half of the seat-back, and left for the left half.

Armrest

■ Using the Front Seat Armrest



The console lid can be used as an armrest.

To adjust:

Slide the armrest to a desired position.

■ Using the Rear Seat Armrest

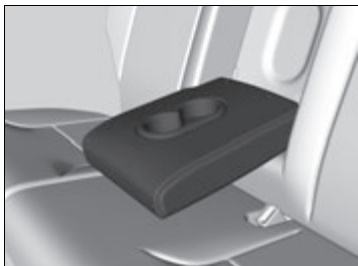

Pull down the armrest in the center seat-back.

Interior Lights

Interior Light Switches

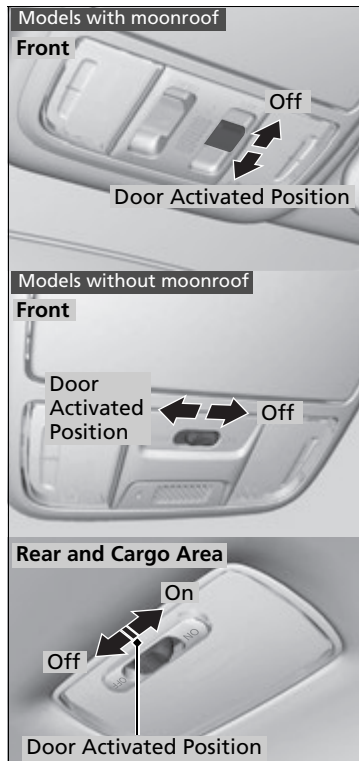

■ ON

The interior lights come on regardless of whether the doors are open or closed.

■ Door activated

The interior lights come on in the following situations:

- When any doors are opened.
- You unlock the driver's door.

Models without smart entry system

- You remove the key from the ignition switch.

Models with smart entry system

- When the power mode is set to VEHICLE OFF (LOCK).

Only the cargo area light comes on when the tailgate is opened.

■ OFF

The interior lights remain off regardless of whether the doors are open or closed.

Interior Light Switches

In the door activated position, the interior lights fade out and go off about 30 seconds after the doors are closed. The lights go off after 30 seconds in the following situations:

- When you unlock the driver's door but do not open it.

Models without smart entry system

- When you remove the key from the ignition switch but do not open a door.

Models with smart entry system

- When you set the power mode to VEHICLE OFF (LOCK) but do not open a door.

You can change the interior lights dimming time.

➤ **Customized Features** P. 102, 116

The interior lights go off immediately in the following situations:

- When you lock the driver's door.

Models without smart entry system

- When you close the driver's door with the key in the ignition switch.

Models with smart entry system

- When you close the driver's door in ACCESSORY mode.
- When you turn the ignition switch to ON **II***1.

If you leave any doors open in VEHICLE OFF (LOCK) mode, or without the key in the ignition switch, the interior lights go off after about 15 minutes.

*1: Models with the smart entry system have an **ENGINE START/STOP** button instead of an ignition switch.

■ Map Lights

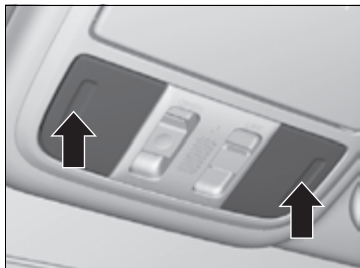

The map lights can be turned on and off by pressing the lenses.

▣ Map Lights

When the interior light switch is in the door activated position and any door is open, pressing the lens does not turn off the map light.

Interior Convenience Items

■ Glove Box

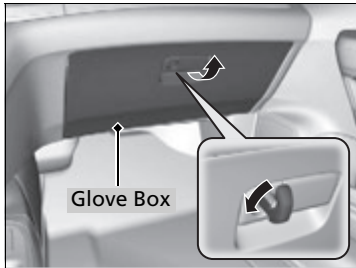

Pull the handle to open the glove box. You can lock the glove box with the master key or the built-in key.

■ Console Compartment

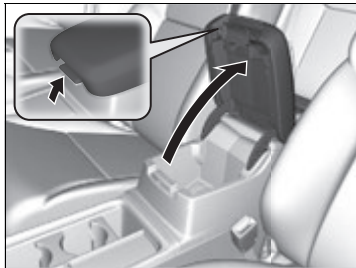

Pull the handle to open the console compartment.

☒ Glove Box

⚠ WARNING

An open glove box can cause serious injury to your passenger in a crash, even if the passenger is wearing the seat belt.

Always keep the glove box closed while driving.

■ Beverage Holders

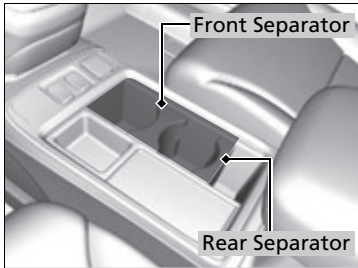

■ **Front seat beverage holders**
Are located in the console between the front seats.

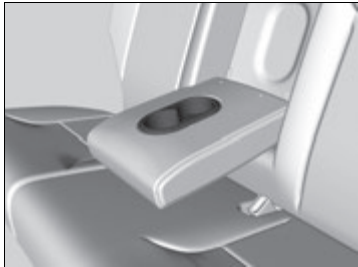

■ **Rear seat beverage holders**
Fold the armrest down to use the rear seat beverage holders.

☒ Beverage Holders

NOTICE

Spilled liquids can damage the upholstery, carpeting, and electrical components in the interior.

Be careful when you are using the beverage holders. Hot liquid can scald you.

The front and rear separators are not interchangeable, and are labeled with their appropriate locations. Always ensure they are positioned as shown.

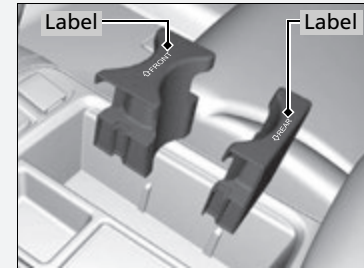

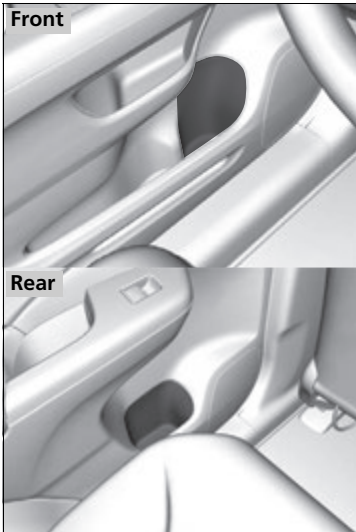



■ **Door side beverage holders**

Are located on the both of front and rear door side pockets.

■ Accessory Power Sockets

The accessory power sockets can be used when the ignition switch is in ACCESSORY  or ON *1.



■ Accessory power socket on the console panel

Open the cover to use it.

▶▶ Accessory Power Sockets

NOTICE

Do not insert an automotive type cigarette lighter element.

This can overheat the power socket.

The accessory power socket is designed to supply power for 12 volt DC accessories that are rated 180 watts or less (15 amps).

To prevent battery drain, only use the power socket with the engine running.

*1: Models with the smart entry system have an **ENGINE START/STOP** button instead of an ignition switch.

Models with smart entry system



Models without smart entry system

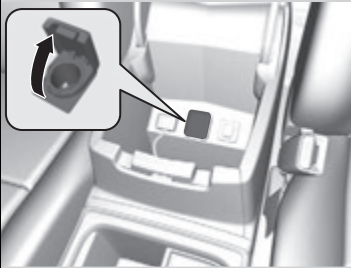

■ **Accessory power socket in the console compartment**

Open the console lid and the cover to use it.

■ Coat Hook

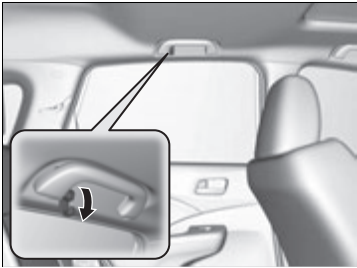

There is a coat hook on the rear left grab handle. Pull it down to use it.

■ Cargo Side Net



Use the cargo side net to secure items to the side.

☒ Coat Hook

The coat hook is not designed for large or heavy items.

■ Tie-down Anchors

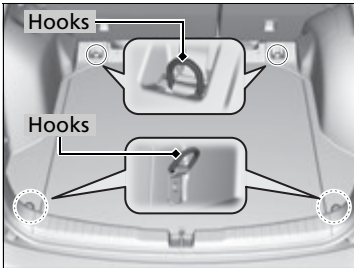

The tie-down anchors on the cargo area floor can be used to install a net for securing items.

■ Cargo Hooks

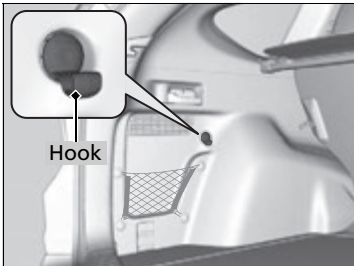

The cargo hooks on both sides of the cargo area can be used to hang a light items.

☒ Tie-down Anchors

Do not let anyone access items in the cargo area while driving. Loose items can cause injury if you have to brake hard.

☒ Cargo Hooks

NOTICE

Do not hang a large object or an object that weighs more than 6 lbs (3 kg) on the side cargo hooks. Hanging heavy or large objects may damage the hooks.

■ Sunglasses Holder

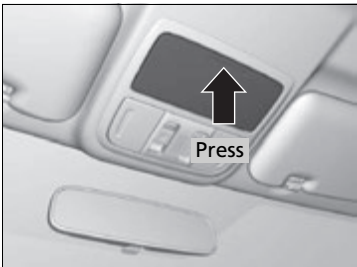

To open the sunglasses holder, press and release the indent. To close, press it again until it latches.

You can store eyeglasses and other small items in this holder.



■ Conversation mirror

The sunglasses holder comes with a mirror. Open the sunglasses holder fully, then push it back to the first detent.

You can use the mirror to view the rear seats.

☞ Sunglasses Holder

Keep the holder closed while driving except when accessing stored items.

Seat Heaters*

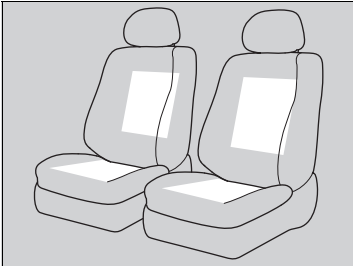

The ignition switch must be in ON **II***1 to use the seat heaters. The **HI** setting heats the seats faster than the **LO** setting.

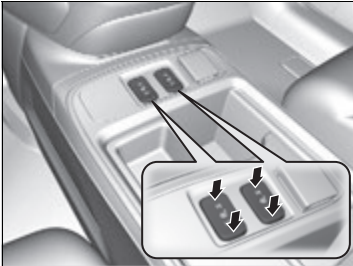

The indicator for your setting comes on while the seat heater is in use. Press the button on the opposite side to turn the heater off. The indicator goes off.

While in **HI**, the heater cycles on and off. When a comfortable temperature is reached, select **LO** to keep the seat warm.

*1: Models with the smart entry system have an **ENGINE START/STOP** button instead of an ignition switch.

* Not available on all models

Seat Heaters*

WARNING

Heat induced burns are possible when using seat heaters.

Persons with a diminished ability to sense temperature (e.g., persons with diabetes, lower-limb nerve damage, or paralysis) or with sensitive skin should not use seat heaters.

Do not use the seat heaters even in **LO** when the engine is off. Under such conditions, the battery may be weakened, making the engine difficult to start.

In the **LO** setting, the heater runs continuously and does not automatically turn off.

Continued

■ Tonneau Cover*

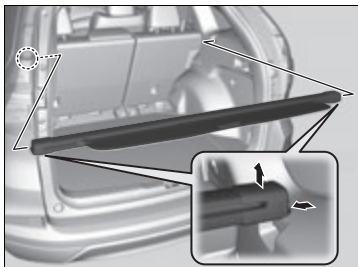
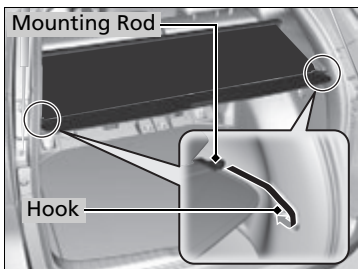
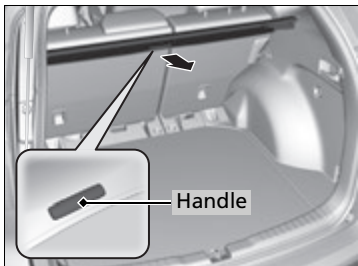

The tonneau cover can be used to conceal items in the cargo area and protect them from direct sunlight.

■ To extend:

Pull the handle on the center edge, then clip the mounting rods in the hooks on both sides of the tailgate opening.

■ To retract:

Slip the rods out of the hooks, then slowly roll it back until it is completely retracted.

■ To remove:

Push either end of the housing inward, then lift it out of its position.

► Tonneau Cover*

Do not let anyone access items in the cargo area while driving. Loose items can cause injury if you have to brake hard.

Do not stack objects higher than the top of the seat in the cargo area. They could block your view and be thrown about the vehicle during a sudden stop.

To prevent tonneau cover damage:

- Do not place items on the tonneau cover.
- Do not put weight on the tonneau cover.

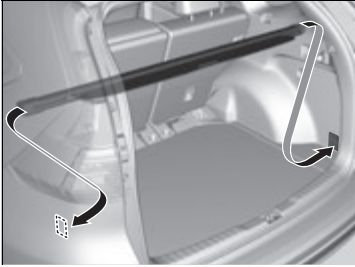

■ **To store:**

The housing unit can be stored on the cargo area floor to make more space available.

Push one end of the unit into the hole on one side panel, then insert the other end into the hole on the other side.

After storing the unit, rock it up and down to make sure it is securely placed.

Using Vents, Heating and A/C

Mode Buttons

Change airflow.

Floor and defroster vents

Floor vents

Dashboard and floor vents and
back of the center console

Dashboard vents and back
of the center console

Windshield Defroster Button

Turns on the A/C, selects airflow from the defroster vents at the base of the windshield, and switches the mode to fresh air.

Fan Control Dial

Adjusts the fan speed.
Rotate the dial all the way to **OFF** to turn everything off.

MAX A/C Button

Turns on the A/C, selects airflow from the dashboard vents, and switches the mode to recirculation.

A/C Button

Press to cool the interior or dehumidify while heating.

(Recirculation) Button

Press the  button and switch the mode depending on environmental conditions.

Recirculation mode (indicator on):
Recirculates air from the vehicle's interior through the system.

Fresh air mode (indicator off):
Maintains outside ventilation. Keep the system in fresh air mode in normal situations.

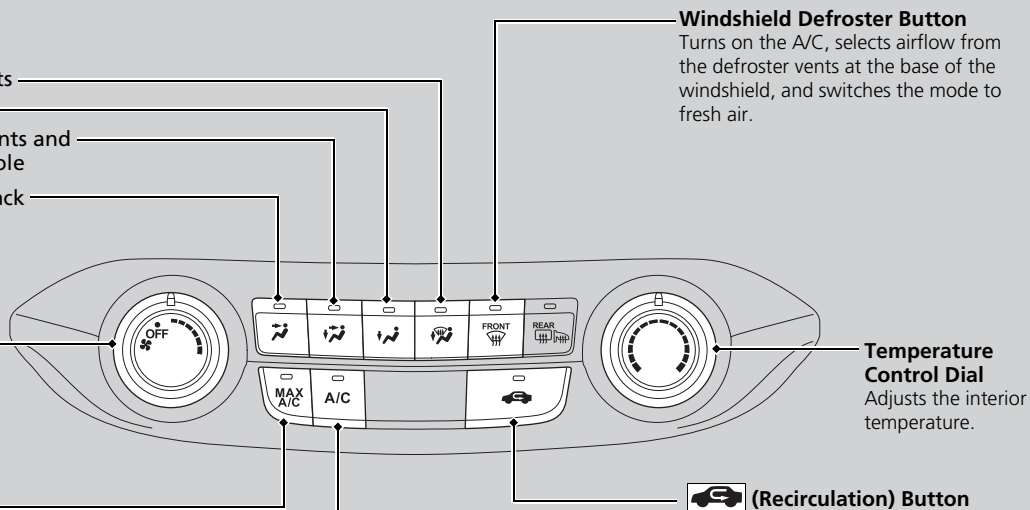



Temperature Control Dial

Adjusts the interior temperature.

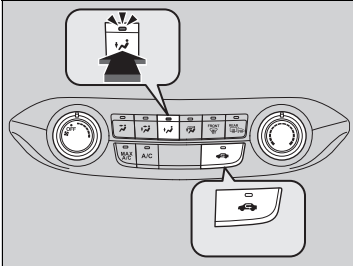

■ Heating



The heater uses heat from the engine coolant to warm the air.

1. Adjust the fan speed using the fan control dial.
2. Select .
3. Adjust the temperature using the temperature control dial.
4. Press the  button (indicator off).

■ To rapidly warm up the interior

1. Set the fan to the maximum speed.
2. Select .
3. Set the temperature to maximum high.
4. Press the  button (indicator on).

■ To dehumidify the interior

When used in combination with the heater, the air conditioning system makes the interior warm and dry and can prevent the windows from fogging up.

1. Adjust the fan speed using the fan control dial.
2. Press the **A/C** button to turn on the air conditioning system.
3. Select .
4. Adjust the temperature using the temperature control dial.

▣ Heating

When you select , the mode automatically switches to fresh air.

▣ To rapidly warm up the interior

Change to fresh air mode as soon as the interior gets warm enough. The windows may fog up if kept in recirculation mode.

■ Cooling

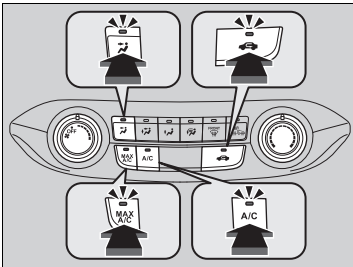



1. Adjust the fan speed using the fan control dial.
2. Select .
3. Adjust the temperature using the temperature control dial.
4. Press the **A/C** button (indicator on).

■ To rapidly cool down the interior

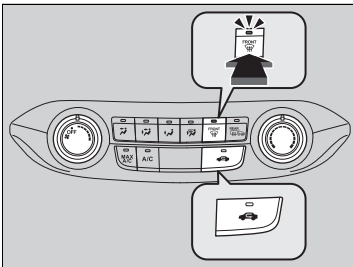

1. Set the fan to the maximum speed.
2. Set the temperature to maximum low.
3. Press the  button (indicator on).

■ Defrosting the Windshield and Windows



Pressing the  button turns the air conditioning system on and automatically switches the system to fresh air mode.

■ To rapidly defrost the windows

1. Set the fan to the maximum speed.
2. Press the  button.
3. Press the  button.
4. Set the temperature to maximum high.

►► To rapidly cool down the interior

If the interior is very warm, you can cool it down more rapidly by partially opening the windows.

While in the ECON mode, the system has greater temperature fluctuations.

Pressing the  button bypasses the ECON mode control, and cools down the interior more rapidly.

 **ECON Button** P. 374

►► Defrosting the Windshield and Windows

For your safety, make sure you have a clear view through all the windows before driving.

Do not set the temperature near the upper or lower limit.

When cold air hits the windshield, the outside of the windshield may fog up.

If the side windows fog up, adjust the vents so that the air hits the side windows.

►► To rapidly defrost the windows

After defrosting the windows, switch over to fresh air mode.

If you keep the system in recirculation mode, the windows may fog up from humidity. This impedes visibility.

Using Automatic Climate Control

The automatic climate control system maintains the interior temperature you select. The system also selects the proper mix of heated or cooled air that raises or lowers the interior temperature to your preference as quickly as possible.

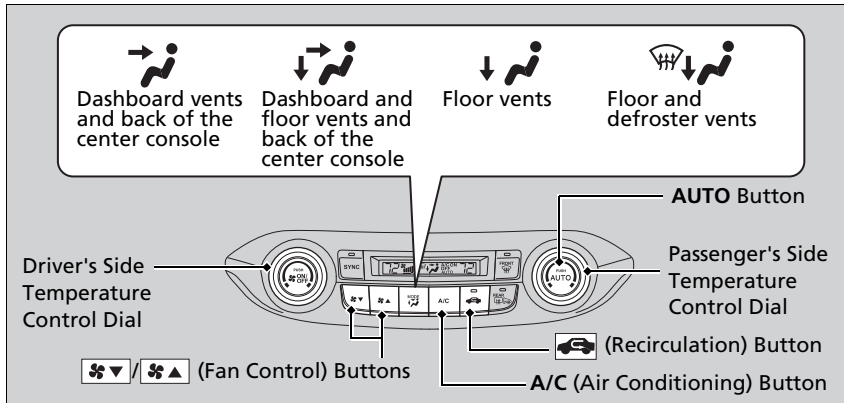

Use the system when the engine is running.

1. Press the **AUTO** button.
2. Adjust the interior temperature using the driver's side or passenger's side temperature control dial.
3. Press the  button to cancel.

■ Switching between the recirculation and fresh air modes

Press the  button and switch the mode depending on environmental conditions. Recirculation mode (indicator on): Recirculates air from the vehicle's interior through the system.

Fresh air mode (indicator off): Maintains outside ventilation. Keep the system in fresh air mode in normal situations.

* Not available on all models

Continued

☒ Using Automatic Climate Control

If any button is pressed while in **AUTO**, the function of that button takes priority.

The **AUTO** indicator goes off, but functions of other buttons pressed are still in auto mode.

To prevent cold air from blowing in from outside, the fan may operate at low speed for a while after the **AUTO** button has been pressed.

If the interior is very warm, you can cool it down more rapidly by partially opening the windows, turning the system on **AUTO**, and setting the temperature to low. Change the fresh air mode to recirculation mode until the temperature cools down.

When you set the temperature to the lower or upper limit, **Lo** or **Hi** is displayed.

Pressing the  button switches the climate control system between on and off. When turned on, the system returns to your last selection.

While in **ECON** mode, the system has greater temperature fluctuations.

☒ **ECON Button** P. 374

■ Defrosting the Windshield and Windows

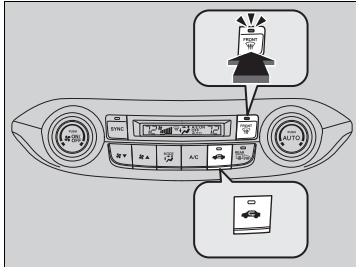

Pressing the  button turns the air conditioning system on and automatically switches the system to fresh air mode.

Pressing the  button again to turn off, the system returns to the previous settings.

■ To rapidly defrost the windows

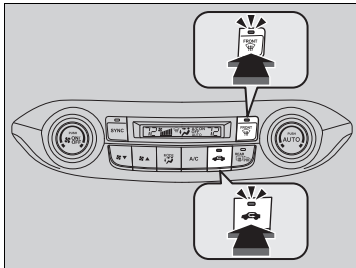

1. Press the  button.
2. Press the  button.

▶▶ Defrosting the Windshield and Windows

For your safety, make sure you have a clear view through all the windows before driving.

Do not set the temperature near the upper or lower limit.

When cold air hits the windshield, the outside of the windshield may fog up.

If the side windows fog up, adjust the vents so that the air hits the side windows.

▶▶ To rapidly defrost the windows

After defrosting the windows, switch over to fresh air mode. If you keep the system in recirculation mode, the windows may fog up from humidity. This impedes visibility.

Synchronized Mode

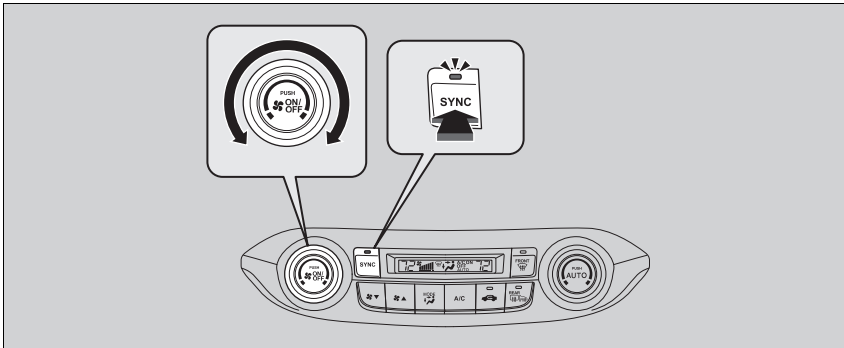

You can set the temperature synchronously for the driver side and the passenger side in synchronized mode.

1. Press the **SYNC** button.
 - ▶ The system switches to synchronized mode.
2. Adjust the temperature using driver's side temperature control dial.

Press the **SYNC** button to return to dual mode.

☒ Synchronized Mode

When you press the  button, the system changes to synchronized mode.

When the system is in dual mode, the driver side temperature and the passenger side temperature can be set separately.

Automatic Climate Control Sensors

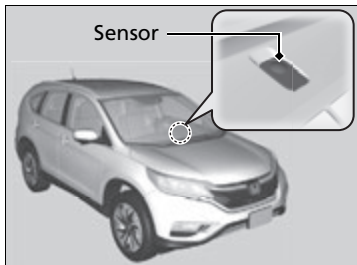

The automatic climate control system is equipped with sensors. Do not cover or spill any liquid on them.

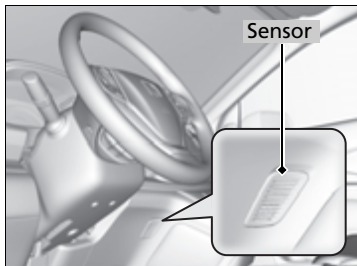

Features

This chapter describes how to operate technology features.

Audio System

| | |
|-------------------------------------|-----|
| About Your Audio System | 208 |
| Auxiliary Input Jack* | 209 |
| USB Ports* | 211 |
| HDMI® Port* | 212 |
| Audio Antenna | 212 |
| Audio System Theft Protection | 213 |
| Audio Remote Controls..... | 214 |

Models with one display

| | |
|---|-----|
| Audio System Basic Operation | 216 |
| Adjusting the Sound | 217 |
| Playing AM/FM Radio | 218 |
| Playing a CD | 221 |
| Playing an iPod | 224 |

| | |
|---------------------------------------|-----|
| Playing Internet Radio | 227 |
| Playing a USB Flash Drive | 229 |
| Playing <i>Bluetooth</i> ® Audio..... | 232 |

Models with two display

| | |
|---|-----|
| Audio System Basic Operation | 234 |
| Adjusting the Sound | 240 |
| Playing AM/FM Radio | 242 |
| Playing SiriusXM® Radio* | 245 |
| Playing a CD | 248 |
| Playing an iPod | 251 |
| Playing Internet Radio | 254 |
| Playing a USB Flash Drive | 256 |
| Playing <i>Bluetooth</i> ® Audio..... | 259 |
| Playing a Video Using the HDMI® | 261 |

| | |
|-----------------------------------|-----|
| Smartphone Apps..... | 263 |
| Siri Eyes Free | 264 |
| Audio Error Messages | 265 |

General Information on the Audio System

| | |
|--|-----|
| Customized Features | 274 |
| Defaulting All the Settings | 284 |
| HomeLink® Universal Transceiver* .. | 285 |

Models with one display

| | |
|--|-----|
| Bluetooth® HandsFreeLink® | 288 |
|--|-----|

Models with two displays

| | |
|--|-----|
| Bluetooth® HandsFreeLink® | 317 |
| Compass | 347 |

* Not available on all models

About Your Audio System

The audio system features AM/FM radio and the SiriusXM® Radio* service. It can also play audio CDs, WMA/MP3/AAC files, USB flash drives, and iPod, iPhone, and Bluetooth® devices.

You can operate the audio system from the buttons and switches on the panel, or the remote controls on the steering wheel.

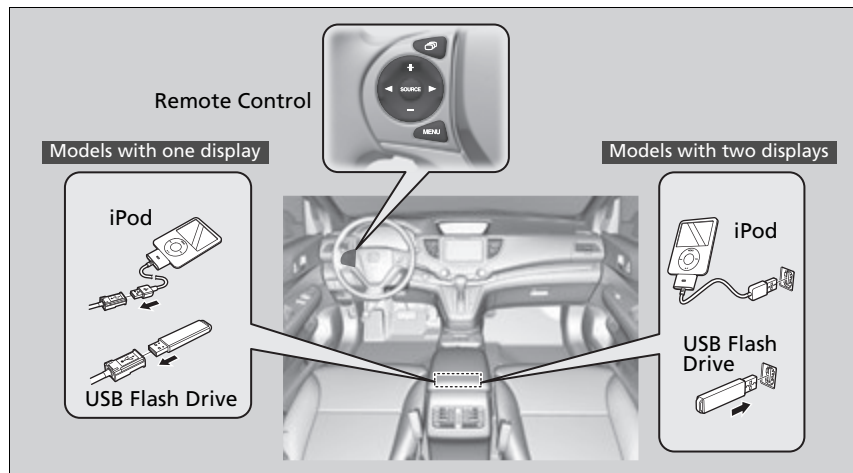

About Your Audio System

SiriusXM® Radio* is available on a subscription basis only. For more information on SiriusXM® Radio*, contact a dealer.

General Information on the Audio System P. 271

SiriusXM® Radio* is available in the United States and Canada, except Hawaii, Alaska, and Puerto Rico.

SiriusXM®* is a registered trademark of SiriusXM Radio, Inc.

Video CDs, DVDs, and 3-inch (8-cm) mini CDs are not supported.

iPod, iPhone and iTunes are trademarks of Apple Inc.

State or local laws may prohibit the operation of handheld electronic devices while operating a vehicle.

Auxiliary Input Jack*

Use the jack to connect a standard audio device.

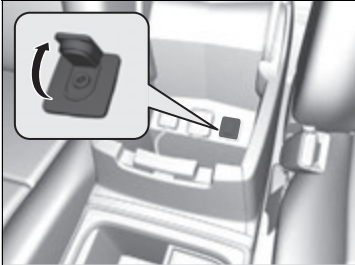

1. Open the AUX cover.
2. Connect a standard audio device to the input jack using a 1/8 inch (3.5 mm) stereo miniplug.
 - ▶ The audio system automatically switches to the AUX mode.

▶▶ Auxiliary Input Jack*

To switch the mode, press any of the audio mode buttons. You can return to the AUX mode by pressing the **AUX** button.

* Not available on all models

USB Adapter Cable*

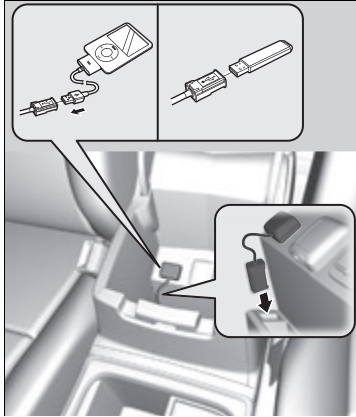

1. Unclip the USB connector and loosen the adapter cable.
2. Install the iPod dock connector or the USB flash drive to the USB connector.

⚠ USB Adapter Cable*

- Do not leave the iPod or USB flash drive in the vehicle. Direct sunlight and high temperatures may damage it.
- Do not use an extension cable with the USB adapter cable.
- Do not connect the iPod or USB flash drive using a hub.
- Do not use a device such as a card reader or hard disk drive, as the device or your files may be damaged.
- We recommend keeping your data backed up before using the device in your vehicle.
- Displayed messages may vary depending on the device model and software version.

If the audio system does not recognize the iPod, try reconnecting it a few times or reboot the device. To reboot, follow the manufacturer's instructions provided with the iPod or visit the following website:

- U.S.: www.apple.com/ipod.
- Canada: www.apple.com/ca/ipod.

USB Ports*

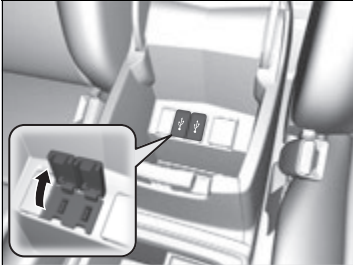

1. Open the cover.
2. Install the iPod USB connector or the USB flash drive to the USB port.

USB Ports*

- Do not leave the iPod or USB flash drive in the vehicle. Direct sunlight and high temperatures may damage it.
- Do not use an extension cable with the USB port.
- Do not connect the iPod or USB flash drive using a hub.
- Do not use a device such as a card reader or hard disk drive, as the device or your files may be damaged.
- We recommend keeping your data backed up before using the device in your vehicle.
- Displayed messages may vary depending on the device model and software version.

If the audio system does not recognize the iPod, try reconnecting it a few times or reboot the device. To reboot, follow the manufacturer's instructions provided with the iPod or visit the following website:

- U.S.: www.apple.com/ipod.
- Canada: www.apple.com/calipod.

* Not available on all models

HDMI® Port*

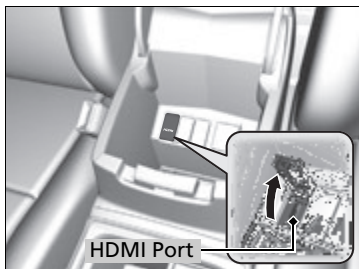

1. Open the cover.
2. Install the HDMI® cable to the HDMI® port.

⌘ HDMI® Port*

- Do not leave the HDMI® connected device in the vehicle. Direct sunlight and high temperatures may damage it.
- We recommend your data backed up before using the device in your vehicle.
- Displayed messages may vary depending on the device model and software version.

The terms HDMI and HDMI High-Definition Multimedia Interface, and the HDMI Logo are trademarks or registered trademarks of HDMI Licensing LLC in the United States and other countries.

⌘ Audio Antenna

Audio Antenna

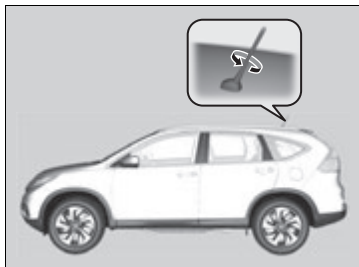

Your vehicle is equipped with a removable antenna at the rear of the roof.

NOTICE

Before using a “drive-through” car wash, remove the antenna by unscrewing it by hand. This prevents the antenna from being damaged by the car wash brushes.

Audio System Theft Protection

The audio system is disabled when it is disconnected from the power source, such as when the battery is disconnected or goes dead. In certain conditions, the system may display **ENTER CODE***¹/**Enter Code***².

■ Reactivating the audio system

1. Turn the ignition switch to ON *³.
2. Turn on the audio system.
3. Press and hold the audio system power button for more than two seconds.
 - ▶ The audio system is reactivated when the audio control unit establishes a connection with the vehicle control unit. If the control unit fails to recognize the audio unit, you must go to a dealer and have the audio unit checked.

*1: Models with one display

*2: Models with two displays

*3: Models with the smart entry system have an **ENGINE START/STOP** button instead of an ignition switch.

Audio Remote Controls

Allow you to operate the audio system while driving.

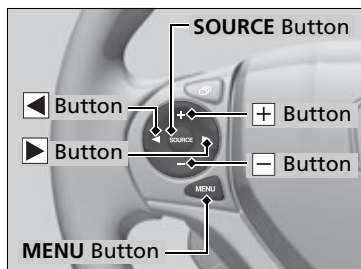

SOURCE Button

Cycles through the audio modes as follows:

Models with one display

FM1→FM2→AM→CD→AUX

Models with two displays

FM→AM→SiriusXM®*→CD→USB→iPod→

Pandora®*→Aha™→Apps→Bluetooth®

Audio→AUX HDMI®

+ - (Volume) Buttons

Press +: To increase the volume.

Press -: To decrease the volume.

◀ ▶ Buttons

- When listening to the radio
 - Press** ▶: To select the next preset radio station.
 - Press** ◀: To select the previous preset radio station.
- When listening to a CD, iPod, USB flash drive, or Bluetooth® Audio
 - Press** ▶: To skip to the next song.
 - Press** ◀: To go back to the beginning of the current or previous song.
- When listening to a CD or USB flash drive
 - Press and hold** ▶: To skip to the next folder.
 - Press and hold** ◀: To go back to the previous folder.
- When listening to Pandora®*
 - Press** ▶: To skip to the next song.
 - Press and hold** ◀: To select the previous station.
 - Press and hold** ▶: To select the next station.

▶▶ Audio Remote Controls

Some sources will only appear when available, such as when a CD is inserted or when a compatible device is connected.

Models with two displaysSteering Wheel **MENU** Button

- When listening to the radio
Press and hold the MENU button: To select the radio station by **Scan, Save Preset, or Seek.**
- When listening to the SiriusXM® radio*
Press and hold the MENU button: To select **Scan, Save Preset, Channel, or Category.**
- When listening to a CD or USB flash drive
Press and hold the MENU button: To select the song by **Scan, Repeat, or Random.**
- When listening to an iPod
Press and hold the MENU button: To select the song by **Repeat or Shuffle.**
- When listening to Internet radio*
Press and hold the MENU button: To select **Bookmark, or Play/Pause.**
- When listening to a *Bluetooth*® Audio
Press and hold the MENU button: To select **Pause or Play** for the song.

* Not available on all models

Audio Remote Controls

The **MENU** button is available only when the audio mode is FM, AM, CD, USB, iPod, Pandora®, Aha™, or *Bluetooth*® Audio.

Models with one display

To use the audio system, the ignition switch must be in ACCESSORY  or ON .

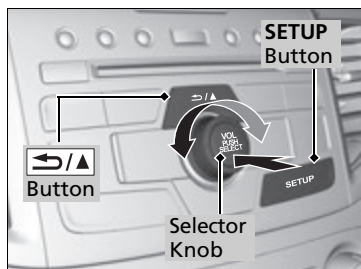

Use the selector knob or **SETUP** button to access some audio functions.

Press  to switch between the normal and extended display for some functions.

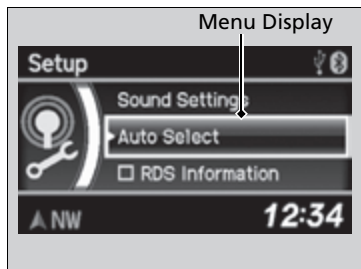

Selector knob: Rotate left or right to scroll through the available choices. Press  to set your selection.

SETUP button: Press to select any mode such as the **Auto Select**, **RDS Information**, **Sound Settings**, **Play Mode**, **Resume/Pause**, or **Adjust Clock**.





←/▲ button: Press to go back to the previous display.

▶▶ Audio System Basic Operation

These indications are used to show how to operate the selector knob.

Rotate  to select.

Press  to enter.

Press the **SOURCE**, , ,  or  button on the steering wheel to change any audio setting.

▶ **Audio Remote Controls** P. 214

Setup menu items

▶ **Auto Select** P. 219

▶ **RDS information** P. 220

▶ **Sound Settings** P. 217

▶ **Play Mode** P. 223

▶ **Resume/Pause** P. 233

▶ **Adjust Clock** P. 130

Adjusting the Sound

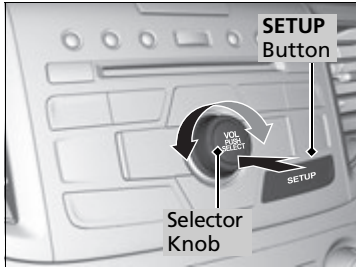

Press the **SETUP** button, and rotate to select **Sound Settings**, then press . Rotate to scroll through the following choices:

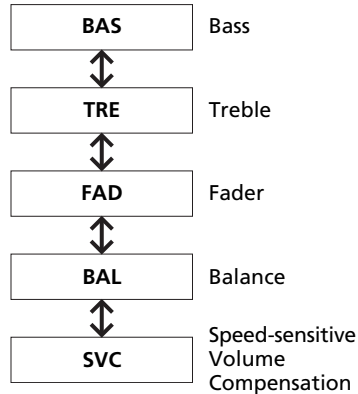
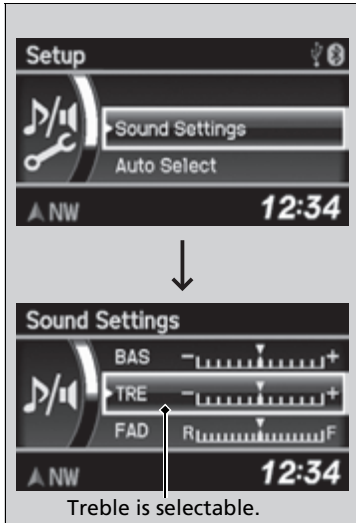

Adjusting the Sound

The SVC has four modes: **Off**, **Low**, **Mid**, and **High**. SVC adjusts the volume level based on the vehicle speed. As you go faster, audio volume increases. As you slow down, audio volume decreases.

Playing AM/FM Radio

◀/▶ / ▲/▼ Buttons

Press to display and select an RDS category.

AM Button

FM Button

Press to select a band.

SCAN Button

Press to sample each of the strongest stations on the selected band for 10 seconds. To turn off scan, press the button again.

Seek/Skip Buttons

Press to search up and down the selected band for a station with a strong signal.

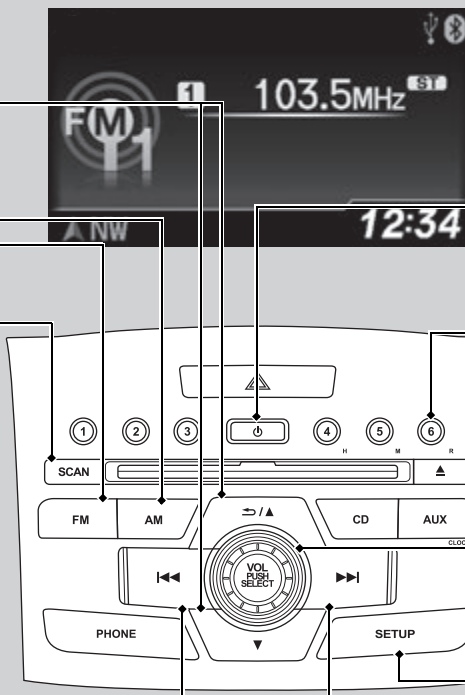

⏻ (Power) Button

Press to turn the audio system on and off.

Preset Buttons (1-6)

To store a station:

1. Tune to the selected station.
2. Pick a preset button and hold it until you hear a beep.

To listen to a stored station, select a band, then press the preset button.

Selector Knob

Turn to adjust the volume. Press and turn to tune the radio frequency.

SETUP Button

Press to display menu items.

Auto Select

Use the auto select feature to scan both bands and store the strongest station in each preset.

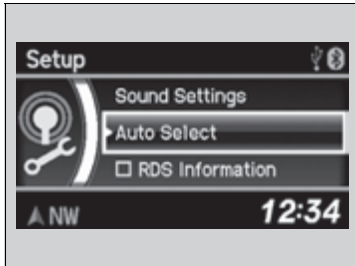

1. Press the **SETUP** button.
2. Rotate  to select **Auto Select**, then press .

To turn off auto select, press  again. This restores the presets you originally set.

▶▶ Playing AM/FM Radio

The ST indicator appears on the display indicating stereo FM broadcasts. Stereo reproduction in AM is not available.

To switch the audio mode, press the **SOURCE** button on the steering wheel.

▶▶ **Audio Remote Controls** P. 214

You can store 6 AM stations and 12 FM stations into the preset button memory. FM1 and FM2 let you store 6 stations each.

Auto Select function scans and stores up to 6 AM stations and 12 FM stations with a strong signal into the preset button memory.

If you do not like the stations auto select has stored, you can manually store your preferred frequencies.

■ Radio Data System (RDS)

Provides text data information related to your selected RDS-capable FM station.

■ RDS information

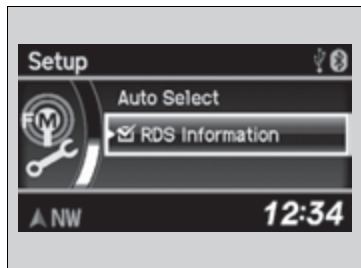

1. Press the **SETUP** button and rotate to select **RDS Information**.
2. Each time you press , the RDS Information switches between on and off.

■ To find an RDS station from your selected program category

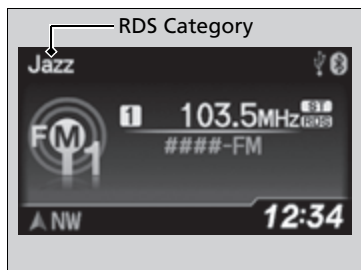

1. Press the / / button to display and select an RDS category.
2. Use Seek/Skip or **SCAN** to select an RDS station.

Playing a CD

Your audio system supports audio CDs, CD-Rs and CD-RWs in either MP3 or WMA format. With the CD loaded, press the **CD** button.

SCAN Button

You will get a 10-second sampling of each song.

- Press to sample all tracks on the CD (all files in the current folder in MP3 or WMA).
- Press twice to sample the first file in each of the main folders (MP3 or WMA).
- To turn off scan, press and hold the button.

◀/▶ / ▾ Buttons

Press **◀/▶** to skip to the next folder, and **▾** to skip to the beginning of the previous folder in MP3 or WMA.

Seek/Skip Buttons

Press **◀◀** or **▶▶** to change tracks (files in MP3 or WMA).

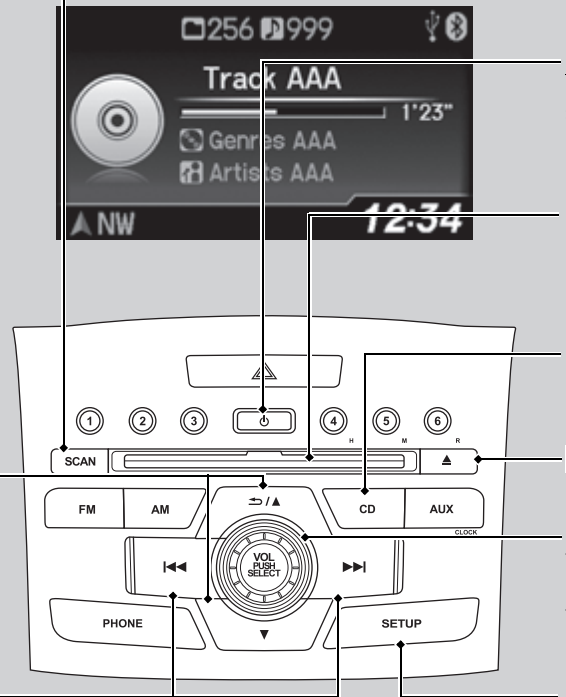

⏻ (Power) Button

Press to turn the audio system on and off.

CD Slot

Insert a CD about halfway into the CD slot.

CD Button

Press to play a CD.

⏏ (CD Eject) Button

Press to eject a CD.

Selector Knob

Turn to adjust the volume. Press and turn to select an item, then press to set your selection.

SETUP Button

Press to display menu items.

How to Select a File from a Folder with the Selector Knob (MP3/WMA)

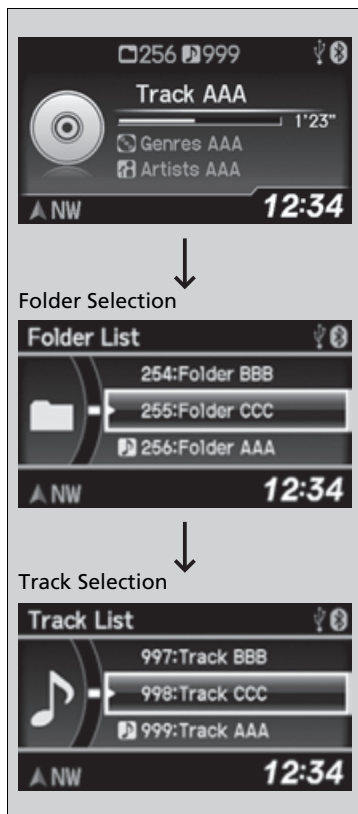

1. Press  to switch the display to a folder list.

2. Rotate  to select a folder.

3. Press  to change the display to a list of files in that folder.

4. Rotate  to select a file, then press .

▶▶ Playing a CD

NOTICE

Do not use CDs with adhesive labels. The label can cause the CD to jam in the unit.

WMA files protected by digital rights management (DRM) cannot be played.

The audio system displays **Unsupported**, then skips to the next file.

Text data appears on the display under the following circumstances:

- When you select a new folder, file, or track.
- When you change the audio mode to CD.
- When you insert a CD.

If you eject the CD but do not remove it from the slot, the system reloads the CD automatically after several seconds.

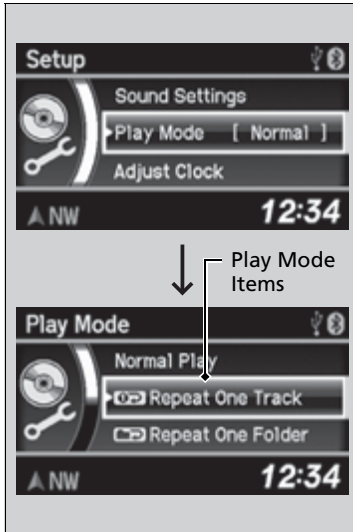

How to Select a Play Mode

You can select repeat and random modes when playing a track or file.



1. Press the **SETUP** button.

2. Rotate  to select **Play Mode**, then press .

3. Rotate  to select a mode, then press .

To turn off a play mode

1. Press the **SETUP** button.

2. Rotate  to select **Play Mode**, then press .

3. Rotate  to select **Normal Play**, then press .

How to Select a Play Mode

Play mode menu items

Normal Play

Repeat One Track: Repeats the current track/file(s).

Repeat One Folder (MP3/WMA): Repeats all files in the current folder.

Random in Folder (MP3/WMA): Plays all files in the current folder in random order.

Random All: Plays all tracks/files in random order.

Playing an iPod

Connect the iPod using your dock connector to the USB adapter cable, then press the **AUX** button.

➤ **USB Adapter Cable** * P. 210

Album Art

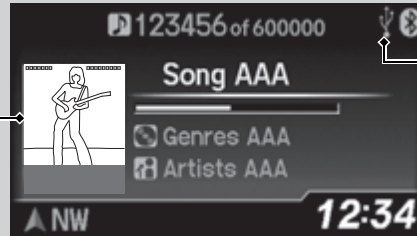



USB Indicator

Comes on when an iPod is connected.

 /  /  **Buttons**

Press  /  to go back to the previous display.

Press  to set your selection.

 **(Power) Button**

Press to turn the audio system on and off.

AUX Button

Press to select iPod (if connected).

Selector Knob

Turn to adjust the volume.

Press and turn to select an item, then press to set your selection.

Seek/Skip Buttons

Press  or  to change songs.

SETUP Button

Press to display menu items.

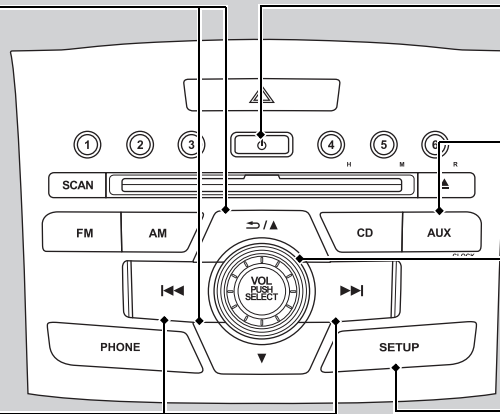

How to Select a File from the iPod Menu

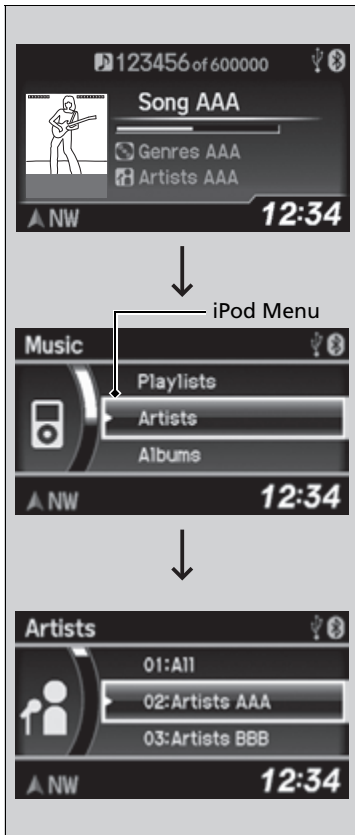

1. Press to display the iPod menu.

2. Rotate to select a menu.

3. Press to display the items on that menu.

4. Rotate to select an item, then press .

▶▶ Playing an iPod

Available operating functions vary on models or versions. Some functions may not be available on the vehicle's audio system.

If there is a problem, you may see an error message on the i-MID.

iPod/USB Flash Drive P. 266

How to Select a Play Mode

You can select repeat and shuffle modes when playing a track.

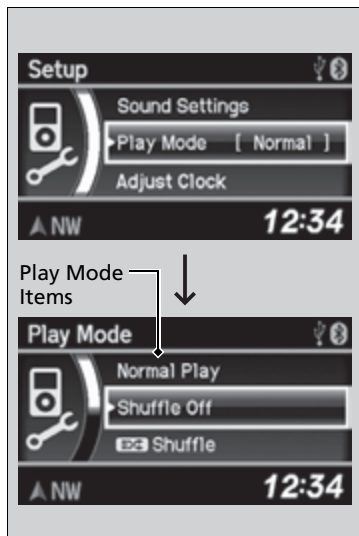

1. Press the **SETUP** button.

2. Rotate to select **Play Mode**, then press .

3. Rotate to select a mode, then press .

To turn off a play mode

1. Press the **SETUP** button.

2. Rotate to select **Play Mode**, then press .

3. Rotate to select **Normal Play**, then press .

How to Select a Play Mode

Play mode menu items

Normal Play

Shuffle Off: Turns off the shuffle mode.

Shuffle: Plays all available tracks in a selected list (playlists, artists, albums, songs, genres, or composers) in random order.

Shuffle Albums: Plays all available albums in a selected list (playlists, artists, albums, songs, genres, or composers) in random order.

Repeat Off: Turns off the repeat mode.

Repeat One Track: Repeats the current track.

U.S. models

iPhone use only

Playing Internet Radio

Activate Pandora®, and connect the iPhone using your dock connector to the USB adapter cable, then press the **AUX** button.

📌 **USB Adapter Cable*** P. 210

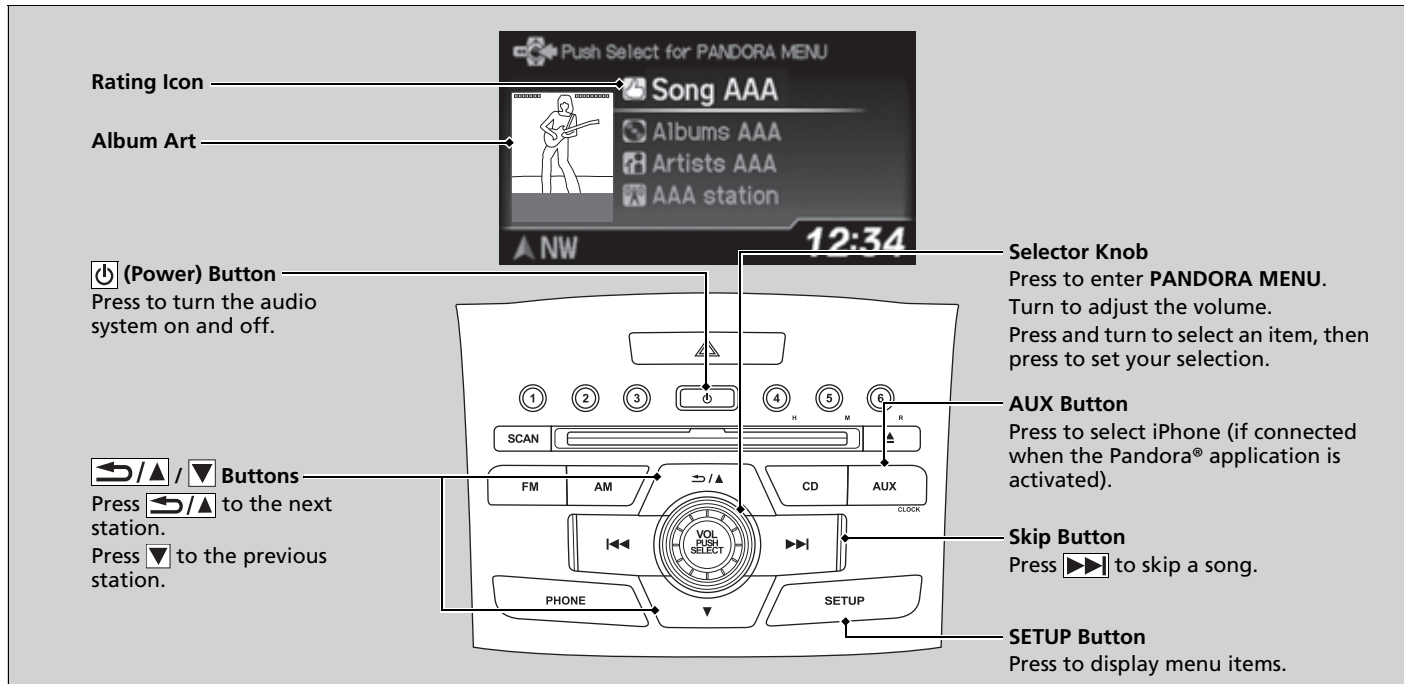

* Not available on all models



■ Pandora® Menu

You can operate some of the Pandora menu items from your vehicle's audio system. The available items are:

- **Station List** (**QuickMix** is also available)
- **Like**
- **Dislike**
- **Resume/Pause**
- **SKIP**
- **Bookmark this song**
- **Bookmark this artist**

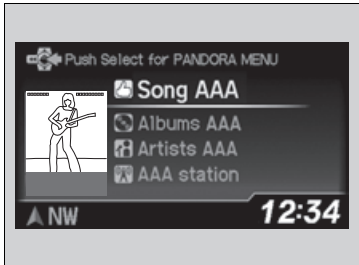
■ Operating a menu item



1. Press  to display the **PANDORA MENU**.
2. Rotate  to select a menu.
3. Press  to display the items on that menu.

▶▶ Playing Internet Radio

Pandora® is a personalized Internet radio service that selects music based on an artist, song, or genre a user enters, and streams what is likely to be of interest.

To use this service in your vehicle, the Pandora® app must first be installed on your iPhone. Visit www.pandora.com for more information.

If you cannot operate Pandora® through the audio system, it may be streaming through *Bluetooth®* Audio. Make sure Pandora® mode on your audio system is selected.

▶▶ Pandora® Menu

Available operating functions vary on software versions. Some functions may not be available on the vehicle's audio system.

If there is a problem, you may see an error message on the i-MID.

 **Pandora®** P. 268

There are restrictions on the number of songs you can skip or dislike in a given hour.

Playing a USB Flash Drive

Your audio system reads and plays sound files on a USB flash drive in either MP3, WMA or AAC*1 format.

Connect your USB flash drive to the USB adapter cable, then press the **AUX** button.

📄 **USB Adapter Cable** * P. 210

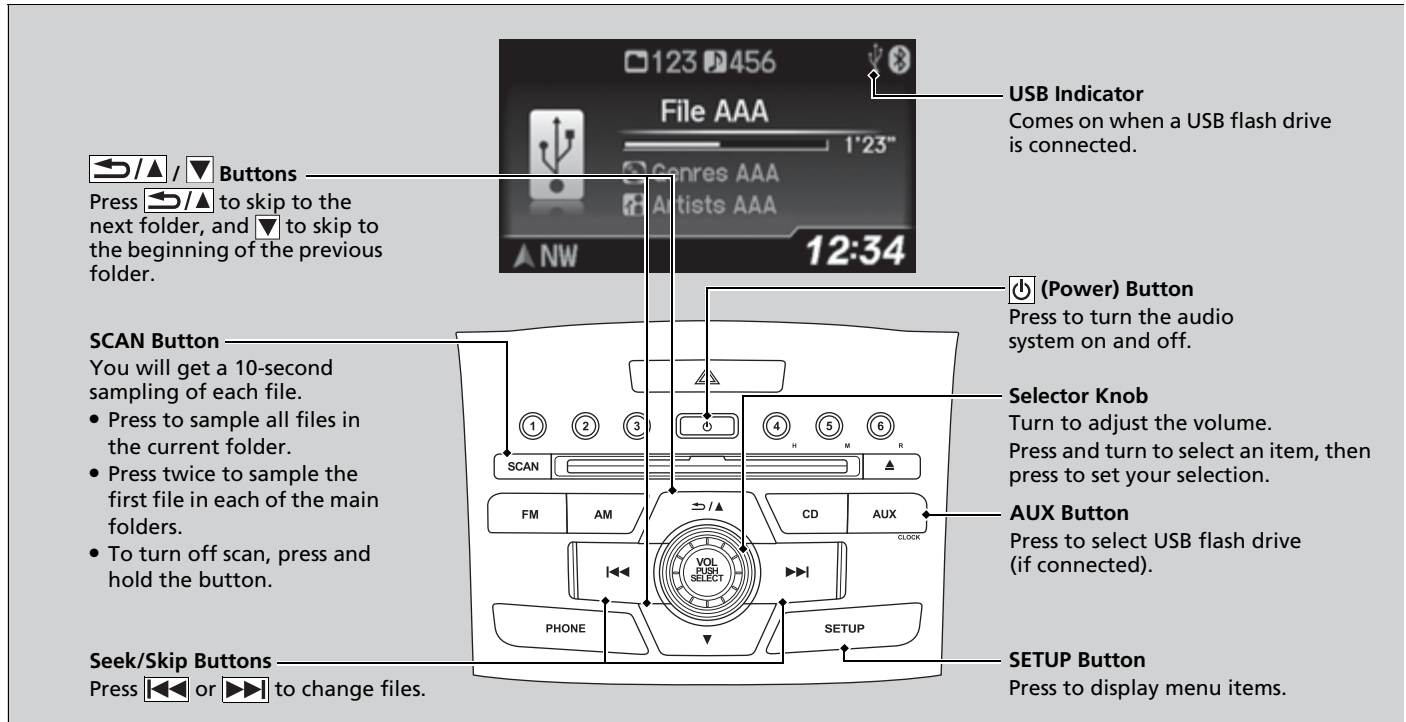

*1: Only AAC format files recorded with iTunes are playable on this unit.

* Not available on all models

How to Select a File from a Folder with the Selector Knob

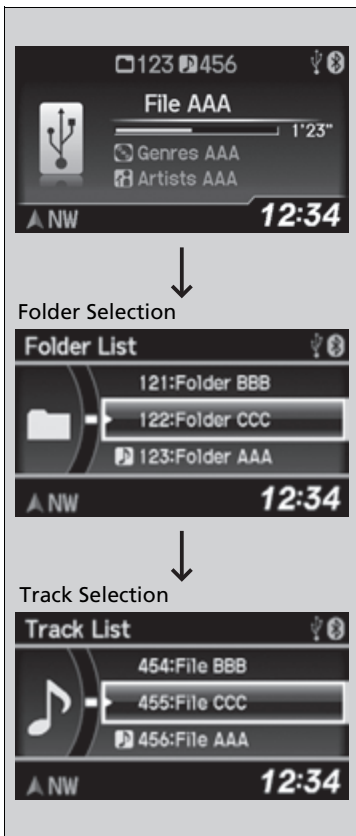

1. Press to switch the display to a folder list.

2. Rotate to select a folder.

3. Press to change the display to a list of files in that folder.

4. Rotate to select a file, then press .

▶▶ Playing a USB Flash Drive

Use the recommended USB flash drives.

General Information on the Audio System
P. 271

Files in WMA format protected by digital rights management (DRM) are not played.

The audio system displays **Unplayable File**, and then skips to the next file.

If there is a problem, you may see an error message on the i-MID.

iPod/USB Flash Drive P. 266

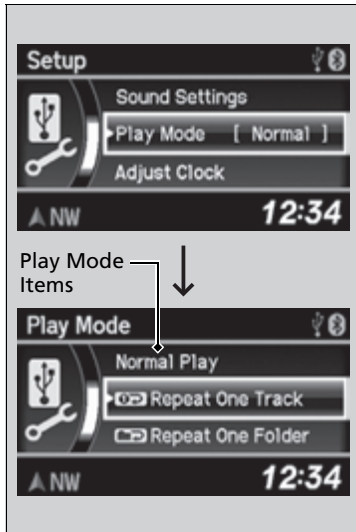

How to Select a Play Mode

You can select repeat and random modes when playing a file.



1. Press the **SETUP** button.

2. Rotate  to select **Play Mode**, then press .

3. Rotate  to select a mode, then press .

■ To turn off a play mode

1. Press the **SETUP** button.

2. Rotate  to select **Play Mode**, then press .

3. Rotate  to select **Normal Play**, then press .

▶▶ How to Select a Play Mode

Play mode menu items

Normal Play

Repeat One Track: Repeats the current file.

Repeat One Folder: Repeats all files in the current folder.

Random in Folder: Plays all files in the current folder in random order.

Random All: Plays all files in random order.

Playing *Bluetooth*® Audio

Your audio system allows you to listen to music from your *Bluetooth*-compatible phone.

This function is available when the phone is paired and connected to the vehicle's *Bluetooth*® HandsFreeLink® (HFL) system.

☑ **Phone Setup** P. 295

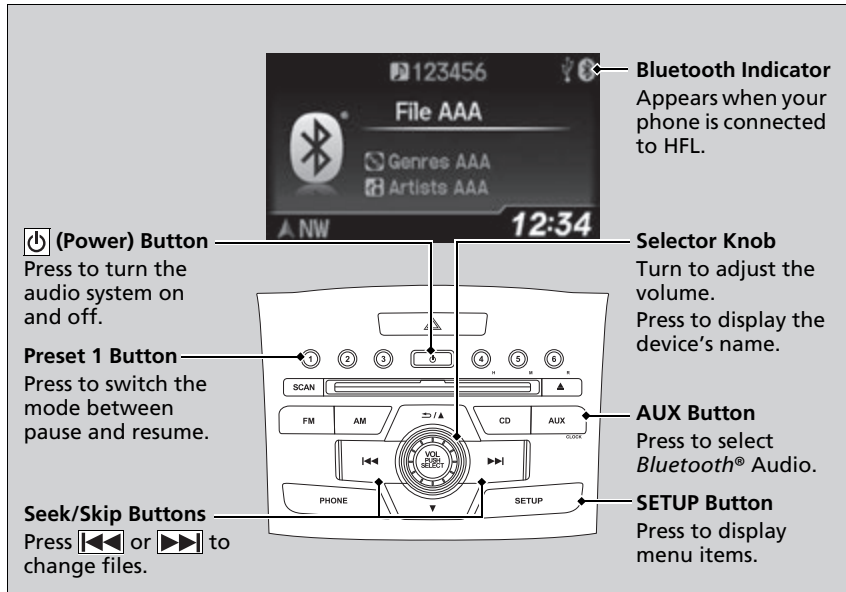

▶▶ Playing *Bluetooth*® Audio

Not all *Bluetooth*-enabled phones with streaming audio capabilities are compatible with the system.

For a list of compatible phones:

- U.S.: Visit www.acura.com/handsfreelink, or call 1-888-528-7876.
- Canada: Visit www.handsfreelink.ca, or call 1-888-528-7876.

In some states, it may be illegal to operate devices that use data while driving.

If more than one phone is paired to the HFL system, there will be a delay before the system begins to play.

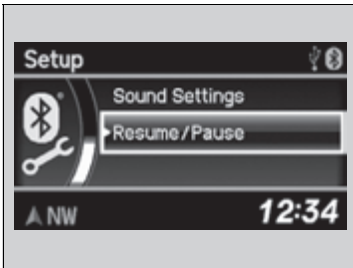

To Play *Bluetooth*® Audio Files



1. Make sure that your phone is paired and connected to HFL.
2. Press the **AUX** button.

If the phone is not recognized, another HFL-compatible phone, which is not compatible for *Bluetooth*® Audio, may already be connected.

■ To pause or resume a file

1. Press the **SETUP** button.
2. Rotate  to select **Resume/Pause**, then press .

Each time you press , the setting switches between pause and resume.

▶▶ To Play *Bluetooth*® Audio Files

To play the audio files, you may need to operate your phone. If so, follow the phone maker's operating instructions.

The pause function may not be available on some phones.

If any audio device is connected to the auxiliary input jack, you may need to press the **AUX** button repeatedly to select the *Bluetooth*® Audio system.

Switching to another mode pauses the music playing from your phone.

Models with two displays

To use the audio system function, the power mode must be in ACCESSORY or ON.

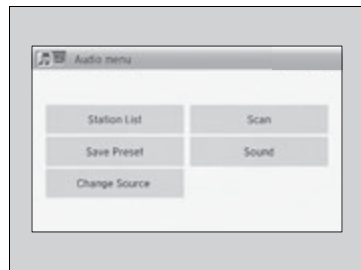
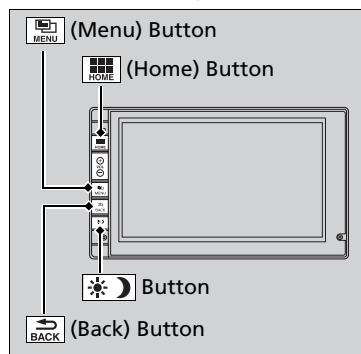





 (Home) Button: Press to go to the home screen.

➤ **Switching the Display** P. 236

 (Menu) Button: Press to select any mode. The available mode includes **Change Source**, **Station List**, **Save Preset**, **Radio Text**, **Music Search**, and play modes. Play modes can be also selected from **Scan**, **Random/Repeat**, and so on.

 (Back) Button: Press to go back to the previous display when it is displayed.

 **button**: Press to change the audio/information screen brightness. Press  once and select  or  to make an adjustment.

▶ Each time you press , the mode switches between the daytime mode, nighttime mode and **OFF** mode.

Audio System Basic Operation

Audio Menu Items

- **Station List** P. 243
- **Music Search** P. 249, 252, 257
- **Random/Repeat** P. 250, 258
- **Scan** P. 244, 250, 258

■ How to access the disc slot

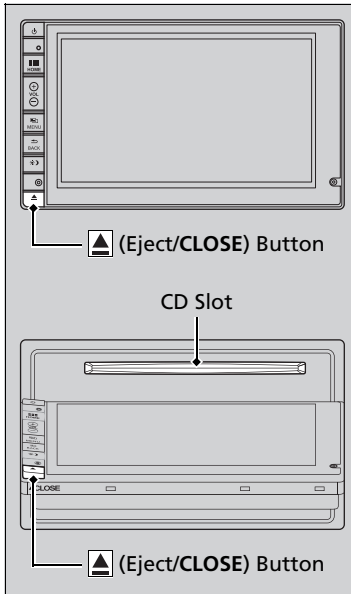

Press the  (Eject/**CLOSE**) button to open the screen.

▶ The screen folds back, and the CD slot appears.

Press the  (Eject/**CLOSE**) button to return the screen to the upright position.

☒ How to access the disc slot

If you eject the CD but do not remove it from the slot, the system reloads the CD automatically after several seconds.

Do not use the folded down screen as a tray.

You cannot open the screen when the power mode is in VEHICLE OFF.

Audio/Information Screen

Displays the audio status and wallpaper. From this screen, you can go to various setup options.

■ Switching the Display

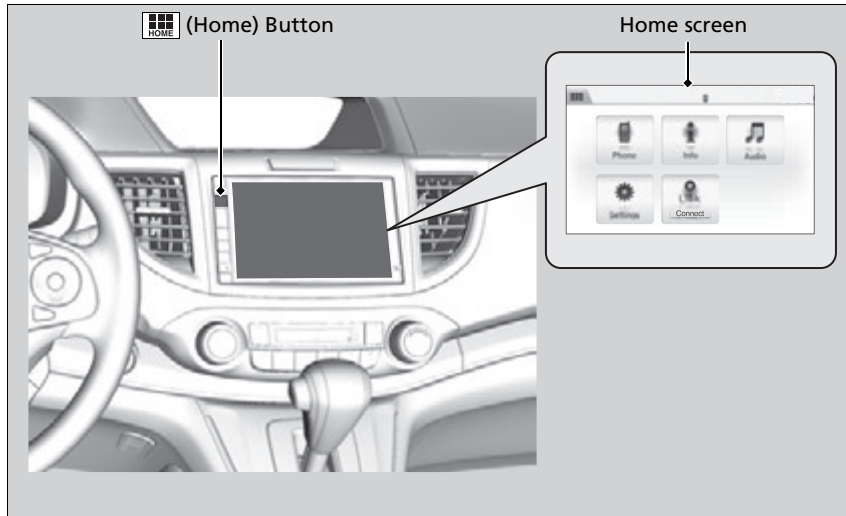

Press the  button to go to the home screen.
Select **Phone**, **Info**, **Audio**, **Settings**, or **Connect**.

■ Phone

Shows the HFL information.

➔ **Bluetooth® HandsFreeLink®** P. 317

■ Info

Shows the **Trip Computer, Clock/Wallpaper, Voice Info, or System/Device Information.**

■ Audio

Shows the current audio information.

■ Settings

Enters the customizing menu screen.

📄 **Customized Features** P. 274

■ Connect Apps

Connects with your smartphone*1 to play personalized music, information, and social media streams.

📄 **Smartphone Apps** P. 263

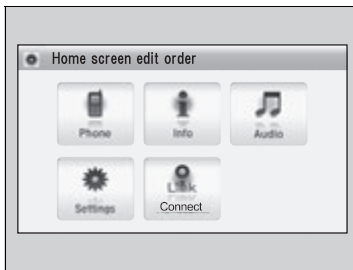
■ Changing the Home screen icon Layout

1. Press the  button.
2. Select **Settings** to go to the settings screen.
3. Select **System**.
4. Select the **Home** tab.
5. Select **Home Screen Edit Order**.
6. Select and hold the icon then, drag it to the desired position.

*1: Available on specific phones only. Check handsfreelink.honda.com for compatible phones and hondalink.com for feature details.

Continued

■ Wallpaper Setup

You can change, store, and delete the wallpaper on the audio/information screen.

■ Import wallpaper

You can import up to five images, one at a time, for wallpaper from a USB flash drive.

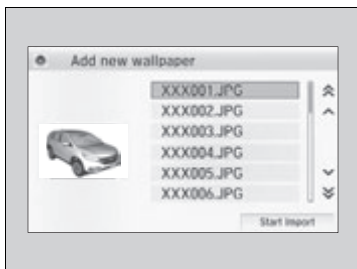
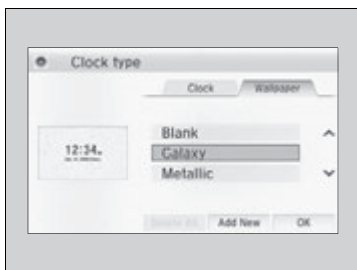

1. Connect the USB flash drive to the USB port.
 ▶ **USB Ports*** P. 211
2. Select **Settings** to go to the settings screen.
3. Select **Clock/Info**.
4. Select **Clock/Wallpaper Type**, then the **Wallpaper** tab.
5. Select **Add New**.
 ▶ The picture name is displayed on the list.
6. Select a desired picture.
 ▶ The preview is displayed on the left side on the screen.
7. Select **Start Import** to save the data.
 ▶ Then the display will return to the wallpaper list.

▣ Wallpaper Setup

- When importing wallpaper files, the image must be in the USB flash drive's root directory. Images in a folder cannot be imported.
- The file name must be fewer than 64 characters.
- The file format of the image that can be imported is BMP (bmp) or JPEG (jpg).
- The individual file size limit is 5 MB.
- The maximum image size is 4,096 x 4,096 pixels. If the image size is less than 800 x 480 pixels, the image is displayed in the middle of the screen with the extra area appearing in black.
- If the USB flash drive does not have any pictures, the **No files detected** message appears.

■ Select wallpaper

1. Select **Settings** to go to the settings screen.
2. Select **Clock/Info**.
3. Select **Clock/Wallpaper Type**, then the **Wallpaper** tab.
 - ▶ The screen changes to the wallpaper list.
4. Select a desired wallpaper.
 - ▶ The preview is displayed on the left side on the screen.
 - ▶ The pop-up menu appears on the screen.
5. Select **Set**.
 - ▶ The display will return to the wallpaper list.

■ To view wallpaper once it is set

1. Press the  button.
2. Select **Info**.
3. Press the  button.
4. Select **Clock/Wallpaper**.

■ Delete wallpaper

1. Select **Settings** to go to the settings screen.
2. Select **Clock/Info**.
3. Select **Clock/Wallpaper Type**, then the **Wallpaper** tab.
 - ▶ The screen changes to the wallpaper list.
4. Select a wallpaper that you want to delete.
 - ▶ The preview is displayed on the left side on the screen.
 - ▶ The pop-up menu appears on the screen.
5. Select **Delete**.
 - ▶ The confirmation message will appear.
6. Select **Yes** to delete completely.
 - ▶ The display will return to the wallpaper list.

▶▶ Wallpaper Setup

From the pop-up menu, select **Preview** to see a preview at full-size screen.

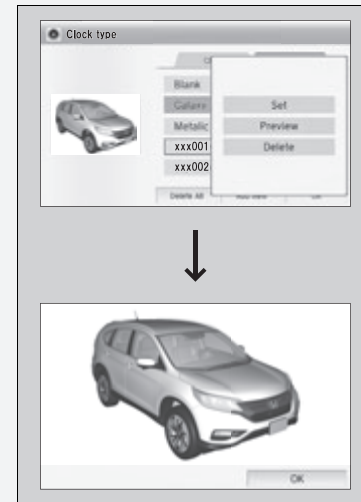



To go back to the previous screen, select **OK**, or press the **BACK** button.

When the file size is large, it takes a while to be previewed.

To delete all wallpapers you add, select **Delete All**, then **Yes**.

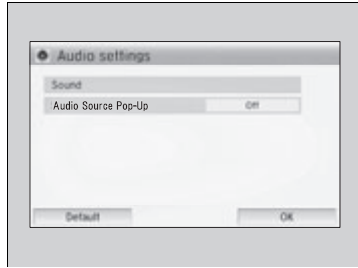
Adjusting the Sound



1. Press the  button.
2. Select **Settings**.
3. Select **Audio**.
4. Select **Sound**.

Select the tabs to adjust the following choices:
BASS, TREBLE, FADER, BALANCE, Subwoofer, SVC (Speed-sensitive Volume Compensation)

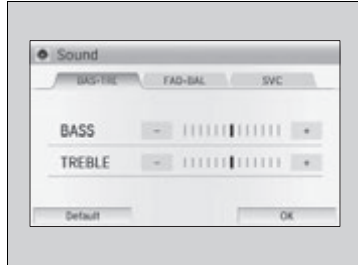

▶▶ Adjusting the Sound

The SVC has four modes: **Off, Low, Mid, and High**. SVC adjusts the volume level based on the vehicle speed. As you go faster, audio volume increases. As you slow down, audio volume decreases.

Display Setup

You can change the brightness or color theme of the audio/information screen.

Changing the Screen Brightness

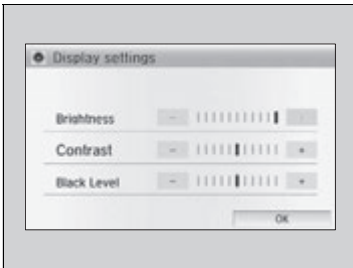

1. Press the  button.
2. Select **Settings** to go to the **Settings** screen.
3. Select **System**.
4. Select the **Display** tab.
5. Select **Display Settings**.
6. Select the setting you want.
7. Select **OK**.

Changing the Screen's Color Theme

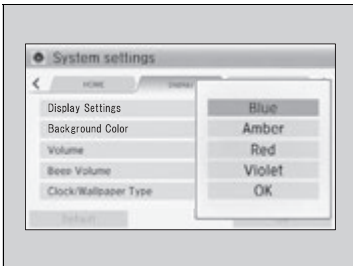

1. Press the  button.
2. Select **Settings** to go to the **Settings** screen.
3. Select **System**.
4. Select the **Display** tab.
5. Select **Background Color**.
6. Select the setting you want.
7. Select **OK**.

Changing the Screen Brightness

You can change the **Contrast** and **Black level** settings in the same manner.

Playing AM/FM Radio

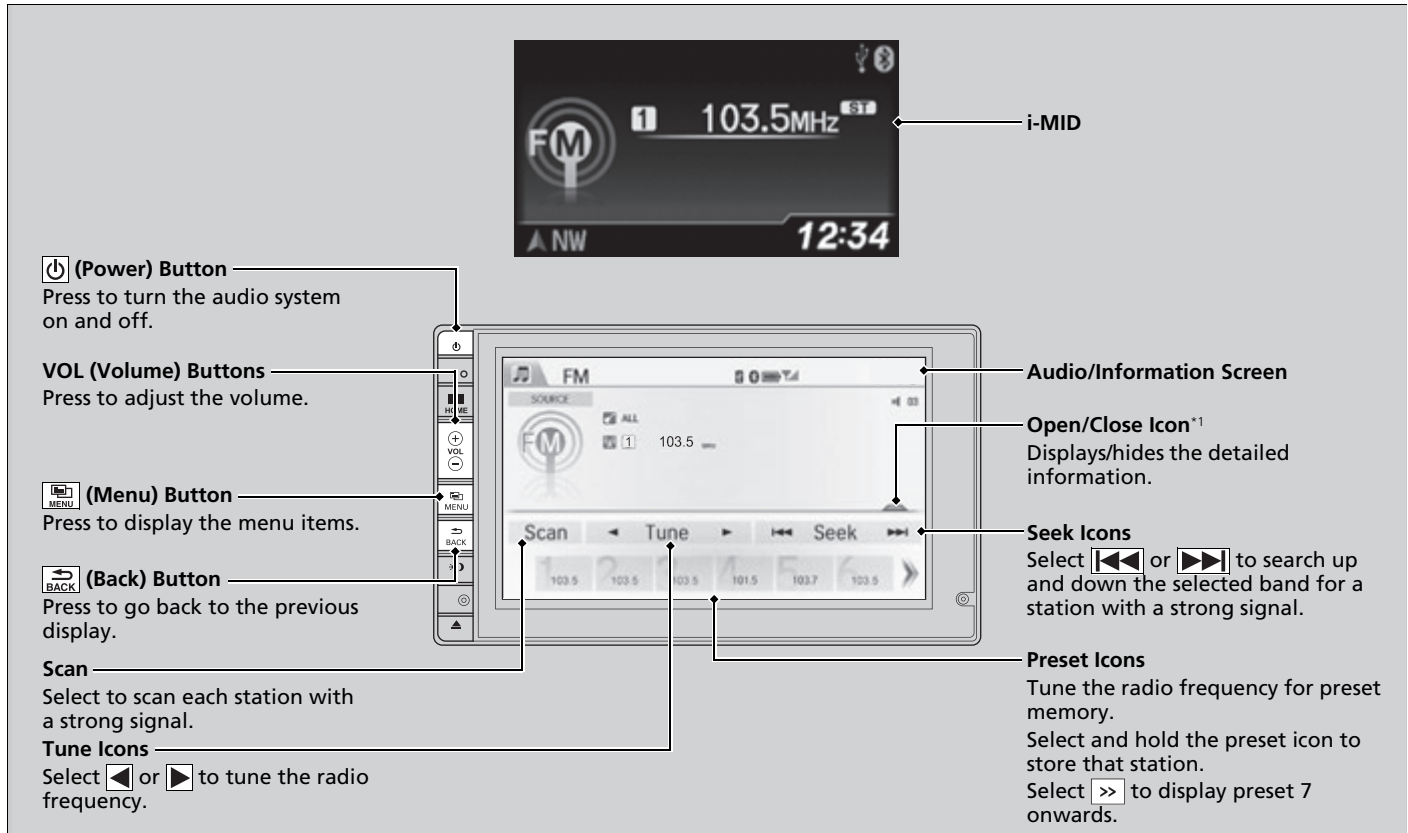

*1: Some or all of the lists may not be displayed.

■ Preset Memory

To store a station:

1. Tune to the selected station.
2. Press the  button.
3. Select **Save Preset**.
4. Select the preset number for the station you want to store.

You can also store a preset station by the following procedure.

1. Select open/close icon to display a channel list.
2. Select **Preset** tab.
3. Press and hold the preset number for the station you want to store until you hear a beep.

■ Radio Data System (RDS)

Provides text data information related to your selected RDS-capable FM station.

■ To find an RDS station from Station List

1. Press the  button while listening to an FM station.
2. Select **Station List**.
3. Select the station.

■ Manual update

Updates your available station list at any time.

1. Press the  button while listening to an FM station.
2. Select **Station List**.
3. Select **Refresh**.

⌘▶▶ Playing AM/FM Radio

The **ST** indicator appears on the display indicating stereo FM broadcasts.
Stereo reproduction in AM is not available.

Switching the Audio Mode
Press the **SOURCE** button on the steering wheel or select **SOURCE** on the list.

▶▶ **Audio Remote Controls** P. 214

You can also switch the mode by selecting **Change Source** on the **MENU** screen.

You can store 6 AM stations and 12 FM stations into the preset memory.

⌘▶▶ Radio Data System (RDS)

When you select an RDS-capable FM station, the RDS automatically turns on, and the frequency display changes to the station name. However, when the signals of that station become weak, the display changes from the station name to the frequency.

■ Radio text

Displays the radio text information of the selected RDS station.

1. Press the  button.
2. Select **View Radio Text**.

■ Scan

Samples each of the strongest stations on the selected band for 10 seconds.

1. Press the  button.
2. Select **Scan**.

To turn off scan, select **Cancel** or .

Playing SiriusXM® Radio *

i-MID

Audio/Information Screen

Open/Close Icon*¹
Displays/hides the detailed information.

Channel Icons
Select **◀◀** or **▶▶** to go to the previous or next channel.
Select and hold a channel icon can move channels the rapidly.

Preset Icons
Tune the radio frequency for preset memory.
Select and hold the preset icon to store that station.
Select **>>** to display preset 7 onwards.

(Power) Button
Press to turn the audio system on and off.

VOL (Volume) Buttons
Press to adjust the volume.

(Menu) Button
Press to display the menu items.

(Back) Button
Press to go back to the previous display.

Scan
Select to scan each station with a strong signal.

Category Icons
Select **◀** or **▶** to display and select an SiriusXM® Radio category.

*1: Some or all of the lists may not be displayed.

* Not available on all models

■ To Play SiriusXM® Radio

1. Select SiriusXM® mode.

▶ **Audio Remote Controls** P. 214

▶ **Audio/Information Screen** P. 236

From the Status Mode screen:

2. Select a channel using the ◀ or ▶ icon.

To select a preset station:

2. Select open/close icon to display a preset channel list.

3. Select a channel from the list.

To switch between channel and category modes:

1. Select SiriusXM® mode.

2. Press the  button.

3. Select **XM Tune Mode**.

4. Select **Channel Mode** or **Category Mode**.

▶▶ Playing SiriusXM® Radio*

In channel mode, all available channels are selectable. In category mode, you can select a channel within a category (Jazz, Rock, Classical, etc.).

There may be instances when SiriusXM® Radio does not broadcast all the data fields (artist name, title). This does not indicate a problem with your audio system.

■ Preset Memory

To store a station:

1. Tune to the selected station.
2. Press the  button.
3. Select **Save Preset**.
4. Select the preset number for the station you want to store.

You can also store a preset station by the following procedure.

1. Tune to the selected station.
2. Select open/close icon. The preset channel list appears.
3. Select **Preset** tab.
4. Press and hold the preset number for the station you want to store until you hear a beep.

■ To Select a Channel from a List

1. Press the  button.
2. Select **Channel List**.
3. Select the station.

■ Scan

1. Press the  button.
2. Select **Scan**.
 - ▶ In channel mode, all channels are sampled for a few seconds each.
 - ▶ In category mode, channels within a category are sampled for a few seconds each.
3. Select **Cancel** to stop scanning channels and to continue listening to the sampling channel.

* Not available on all models

▶▶ Playing SiriusXM® Radio*

Switching audio mode

Press the **SOURCE** button on the steering wheel or select **SOURCE** on the list.

 **Audio Remote Controls** P. 214

You can also switch the mode by selecting **Change Source** on the **MENU** screen.

You can store 12 SiriusXM® stations into the preset memory.

Playing a CD

Your audio system supports audio CDs, CD-Rs, and CD-RWs in either MP3 or WMA, or AAC*1 format. With the CD loaded, select the CD mode.

(Power) Button
Press to turn the audio system on and off.

VOL (Volume) Buttons
Press to adjust the volume.

(Menu) Button
Press to display the menu items.

(Back) Button
Press to go back to the previous display.

(Eject/CLOSE) Button
Press to eject a CD.

Folder Icons
Select to skip to the next folder, and to skip to the beginning of the previous folder in MP3, WMA, or AAC.

i-MID

Audio/Information Screen

Open/Close Icon*2
Displays/hides the detailed information.

Track Icons
Select or to change tracks (files in MP3, WMA, or AAC). Select and hold to move rapidly within a track.

*1: Only AAC format files recorded with iTunes are playable on this unit.

*2: Some or all of the lists may not be displayed.

How to Select a File from the Music Search List (MP3/WMA/AAC)

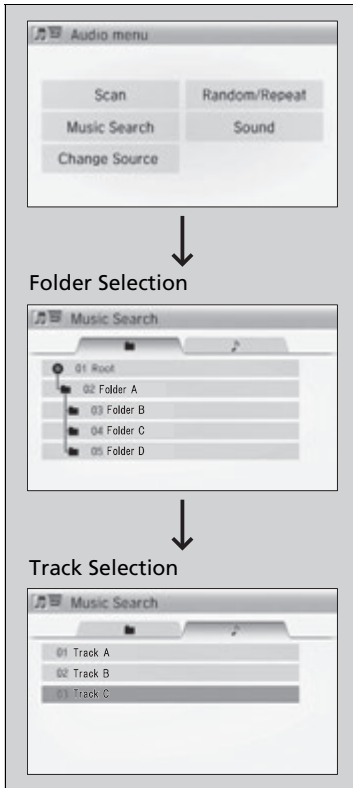

1. Press the  button and select **Music Search**.

2. Select a folder.

3. Select a track.

▶▶ Playing a CD

NOTICE

Do not use CDs with adhesive labels. The label can cause the CD to jam in the unit.

WMA files protected by digital rights management (DRM) cannot be played.

The audio system displays **Unplayable File**, then skips to the next file.

Text data appears on the display under the following circumstances:

- When you select a new folder, file, or track.
- When you change the audio mode to CD.
- When you insert a CD.

If you eject the CD but do not remove it from the slot, the system reloads the CD automatically after several seconds.

■ How to Select a Play Mode

You can select scan, repeat, and random modes when playing a track or file.

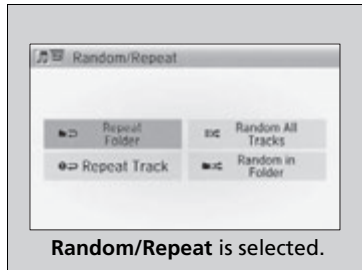

1. Press the  button.
2. Select **Scan** or **Random/Repeat**.
3. Select a mode.

■ To turn off a play mode

1. Press the  button.
2. Select the mode you want to turn off.

▶▶ How to Select a Play Mode

Play Mode Menu Items

Scan

Scan Folders (MP3/WMA/AAC): Provides 10-second sampling of the first file in each of the main folders.

Scan Tracks: Provides 10-second sampling of all tracks on the CD (all files in the current folder in MP3, WMA, or AAC).

Random/Repeat

Repeat Folder (MP3/WMA/AAC): Repeats all files in the current folder.

Repeat Track: Repeats the current track/file.

Random in Folder (MP3/WMA/AAC): Plays all files in the current folder in random order.

Random All Tracks: Plays all tracks/files in random order.

Playing an iPod

Connect the iPod using your USB connector to the USB port, then select the iPod mode.

 **USB Ports*** P. 211

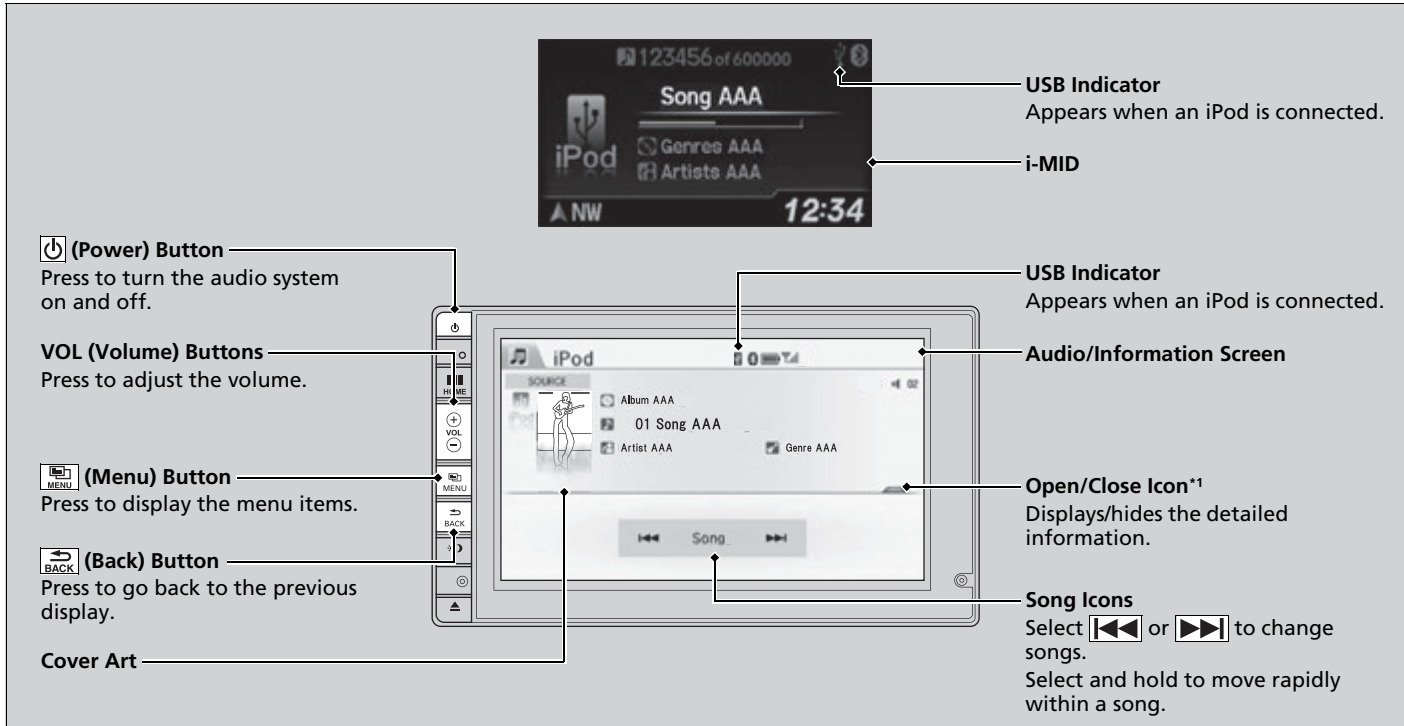

*1: Some or all of the lists may not be displayed.

* Not available on all models

■ How to Select a Song from the Music Search List

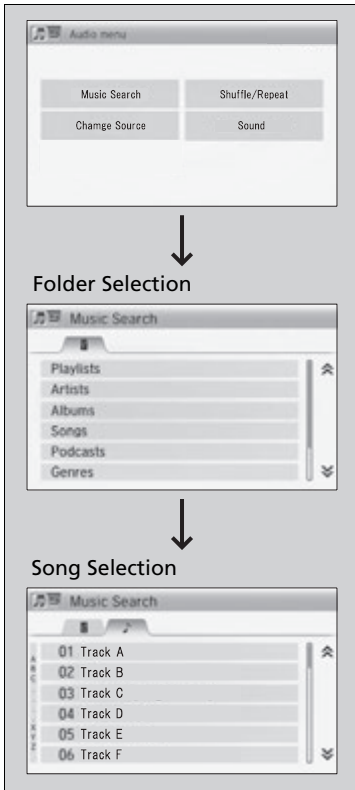

1. Press the  button and select **Music Search**.
2. Select the items on that menu.

▶▶ How to Select a Song from the Music Search List

Functions may vary by model or version. Some audio system functions may not be available.

If there is a problem, you may see an error message on the audio/information screen.

 **iPod/USB Flash Drive** P. 266

If you operate the music app on your iPhone/iPod while the phone is connected to the display audio system, you may no longer be able to operate the same app on the display audio. Reconnect the device if necessary.

iPod will only play through the USB cable, you cannot play the iPod through the HondaLink Cable.

How to Select a Play Mode

You can select repeat and shuffle modes when playing a file.



1. Press the  button.
2. Select **Shuffle/Repeat**.
3. Select a mode.

To turn off a play mode

1. Press the  button.
2. Select the mode you want to turn off.

How to Select a Play Mode

Play Mode Menu Items

Repeat Song: Repeats the current file.

Shuffle Albums: Plays all available albums in a selected list (playlists, artists, albums, songs, genres, or composers) in random order.

Shuffle All Songs: Plays all available files in a selected list (playlists, artists, albums, songs, genres, or composers) in random order.

U.S. models

Compatible phones only

Playing Internet Radio

Connect a compatible phone through *Bluetooth*®.

➔ **Phone Setup** P. 325

iPhone only

You can also connect the phone using your USB connector to the USB port. Select **Source** to select Pandora mode.

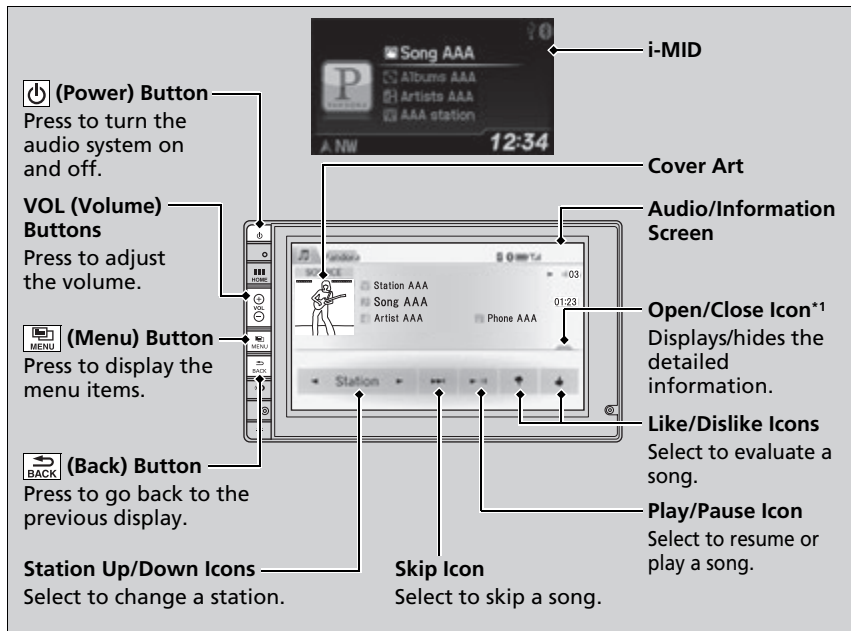

*1: Some or all of the lists may not be displayed.

▶▶ Playing Internet Radio

Pandora®, the Pandora logo, and the Pandora trade dress are trademarks or registered trademarks of Pandora Media, Inc., used with permission. Pandora is currently available exclusively in the United States.

To find out if your phone is compatible with this feature, visit www.handsfreelink.honda.com, or call 1-888-528-7876

To use this service in your vehicle, the Pandora® app must first be installed on your phone. Visit www.pandora.com for more information.

Pandora on the iPhone will only play through the USB cable or *Bluetooth*® Audio, you cannot play Pandora® through the HondaLink Cable.

■ Pandora® Menu

You can operate some of the Pandora® menu items from your vehicle's audio system. The available items are:

- **Bookmark**
- **Station List**
- **New Station**
- **Change Source**
- **Sound**

■ Operating a menu item

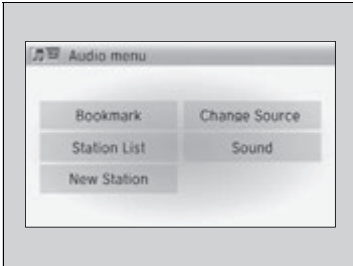

1. Press the  button.
2. Select an item.

▶▶ Playing Internet Radio

Pandora® is free, personalized radio that plays music and comedy you'll love. Just start with the name of one of your favorite artists, songs, comedians or composers and Pandora® will create a custom station that plays similar tracks. Pandora® also features hundreds of genre stations ranging from Dubstep to Smooth Jazz to Power Workout.

If you cannot operate Pandora® through the audio system, it may be streaming through *Bluetooth®* Audio. Make sure Pandora® mode on your audio system is selected.

▶▶ Changing Stations

To change stations, activate the Pandora® menu, select **Station List**, and then select a new station.

▶▶ Pandora® Menu

Available operating functions vary on software versions. Some functions may not be available on the vehicle's audio system.

If there is a problem, you may see an error message on the audio/information screen.

▶▶ **Pandora®** P. 268

Pandora® may limit the total number of skips allowed on the service. If you dislike a track after the skip limit has been reached, your feedback will be saved but the current track will continue to play.

Playing a USB Flash Drive

Your audio system reads and plays sound files on a USB flash drive in either MP3, WMA or AAC*1 format.

Connect your USB flash drive to the USB port, then select the USB mode.

➤ **USB Ports*** P. 211

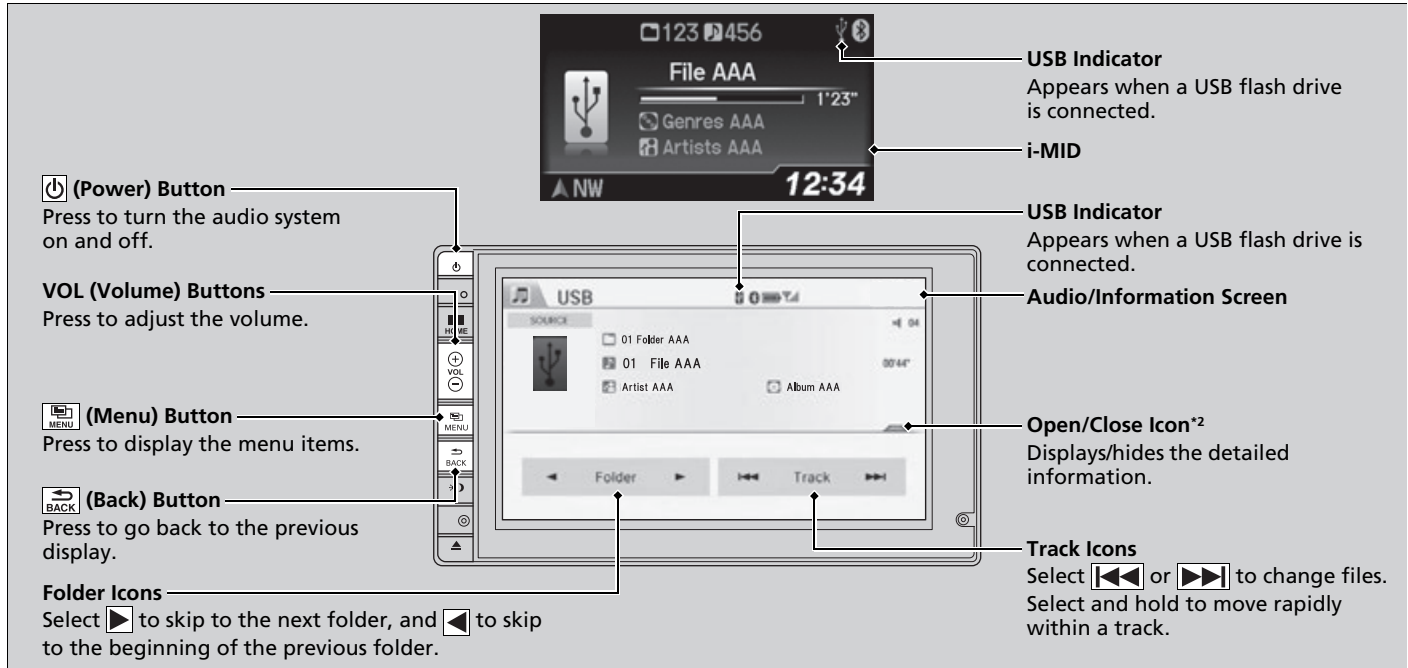

*1: Only AAC format files recorded with iTunes are playable on this unit.

*2: Some or all of the lists may not be displayed.

How to Select a File from the Music Research List

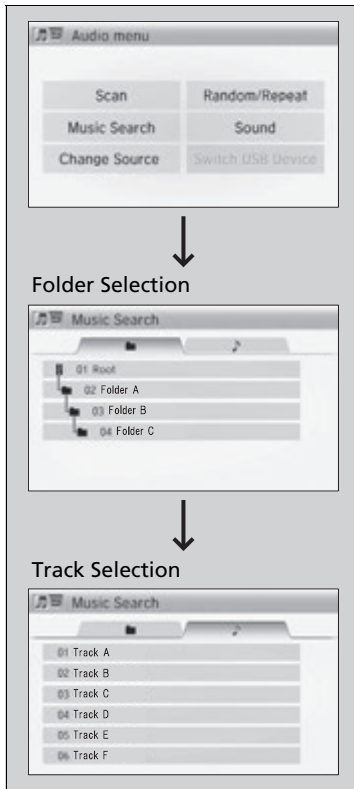

1. Press the  button and select **Music Search**.

2. Select a folder.

3. Select a track.

▶▶ Playing a USB Flash Drive

Use a recommended USB flash drives.

▶ **General Information on the Audio System**
P. 271

Files in WMA format protected by digital rights management (DRM) are not played.

The audio system displays **Unplayable File**, and then skips to the next file.

If there is a problem, you may see an error message on the audio/information screen.

▶ **iPod/USB Flash Drive** P. 266

■ How to Select a Play Mode

You can select scan, repeat, and random modes when playing a file.

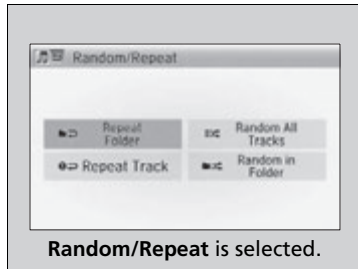

1. Press the  button.
2. Select **Scan** or **Random/Repeat**.
3. Select a mode.

■ To turn off a play mode

1. Press the  button.
2. Select the mode you want to turn off.

▶▶ How to Select a Play Mode

Play Mode Menu Items

Scan

Scan Folders: Provides 10-second sampling of the first file in each of the main folders.

Scan Tracks: Provides 10-second sampling of all files in the current folder.

Random/Repeat

Repeat Folder: Repeats all files in the current folder.

Repeat Track: Repeats the current file.

Random in Folder: Plays all files in the current folder in random order.

Random All Tracks: Plays all files in random order.

Playing *Bluetooth*® Audio

Your audio system allows you to listen to music from your *Bluetooth*-compatible phone.

This function is available when the phone is paired and connected to the vehicle's *Bluetooth*® HandsFreeLink® (HFL) system.

☞ **Phone Setup** P. 325

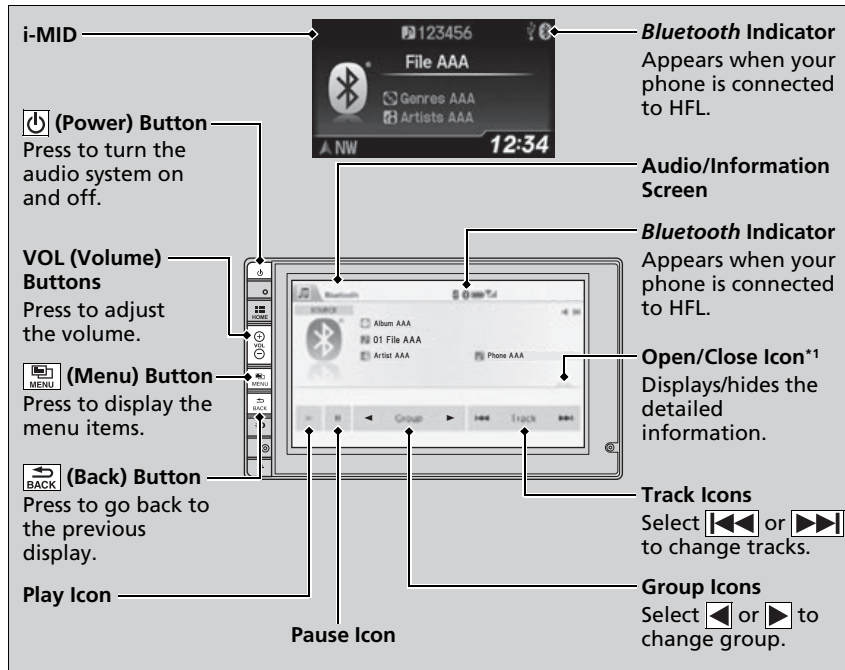

*1: Depending on the *Bluetooth* device you connect, some or all of the lists may not be displayed.

▶▶ Playing *Bluetooth*® Audio

Not all *Bluetooth*-enabled phones with streaming audio capabilities are compatible with the system. For a list of compatible phones:

- U.S.: Visit www.handsfreelink.honda.com, or call 1-888-528-7876.
- Canada: Visit www.handsfreelink.ca, or call 1-888-528-7876.

In some states, it may be illegal to operate devices that use data while driving.

Only one phone can be used with HFL at a time. When there are more than two paired phones in the vehicle, the first paired phone the system finds is automatically linked.

If more than one phone is paired to the HFL system, there may be a delay before the system begins to play.

In some cases, the name of the artist, album, or track may not appear correctly.

A **No Device Connected** message may be displayed if:

- The phone is not linked to HFL.
- The phone is not turned on.
- The phone is not in the vehicle.
- An incompatible phone is connected.

The following functions may not be available on some devices:

- Pause function
- Group selection

■ To Play *Bluetooth*® Audio Files

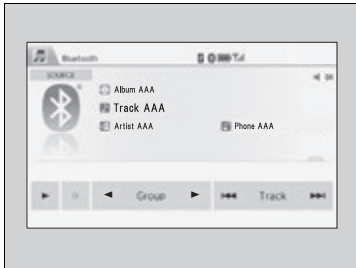

1. Make sure that your phone is paired and connected to HFL.
2. Press the *Bluetooth*® Audio mode.

If the phone is not recognized, another HFL-compatible phone, which is not compatible for *Bluetooth*® Audio, may already be connected.

■ To resume or pause a file

Select the play icon or pause icon, respectively.

■ Searching for Music

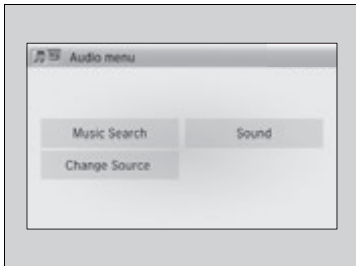

1. Press the  button.
2. Select **Music Search**.
3. Select a search category (e.g., Albums).
4. Select an item.
 - ▶ The selection begins playing.

▶▶ To Play *Bluetooth*® Audio Files

To play the audio files, you may need to operate your phone. If so, follow the phone maker's operating instructions.

Switching to another mode pauses the music playing from your phone.

▶▶ Searching for Music

Depending on the *Bluetooth* device you connect, some or all of the lists may not be displayed.

Playing a Video Using the HDMI®

Your audio system allows you to play videos from an HDMI®-compatible device. Connect the device, using an HDMI® cable, then select the HDMI® mode.

▶ **HDMI® Port*** P. 212

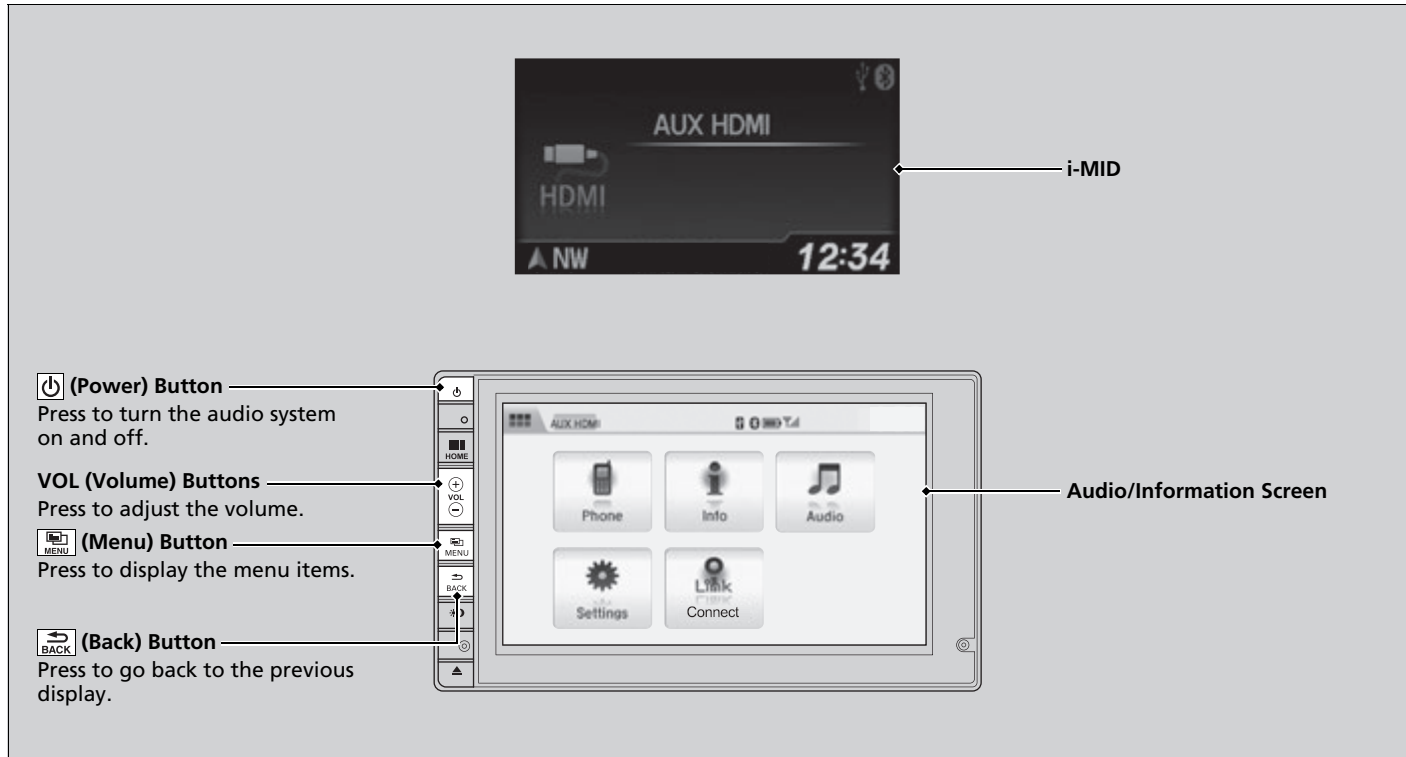

* Not available on all models

■ Changing the Screen Aspect

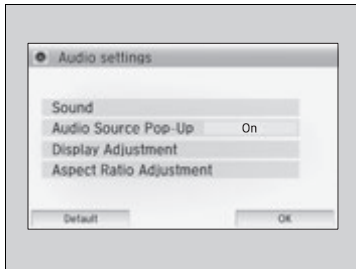

1. Press the  button.
2. Select **Settings** to go to the **Settings** screen.
3. Select **Audio**.
4. Select **Aspect Ratio Adjustment**.
5. Select the setting you want.
6. Select **OK**.

▶▶ Playing a Video Using the HDMI®

This feature is limited while driving. To play videos, stop your vehicle and apply the parking brake.

Smartphone Apps

You can connect a compatible smartphone to the system to enable integration between the smartphone's approved apps and the vehicle. This allows you to control the phone through the vehicle display. To check smart phone compatibility, download the HondaLink app, and view connection instructions, visit:

- U.S.: handsfreelink.honda.com.
- Canada: handsfreelink.ca.

For the latest apps and feature details, check the following website:

- U.S.: hondalink.com.
- Canada: honda.ca/hondalink.

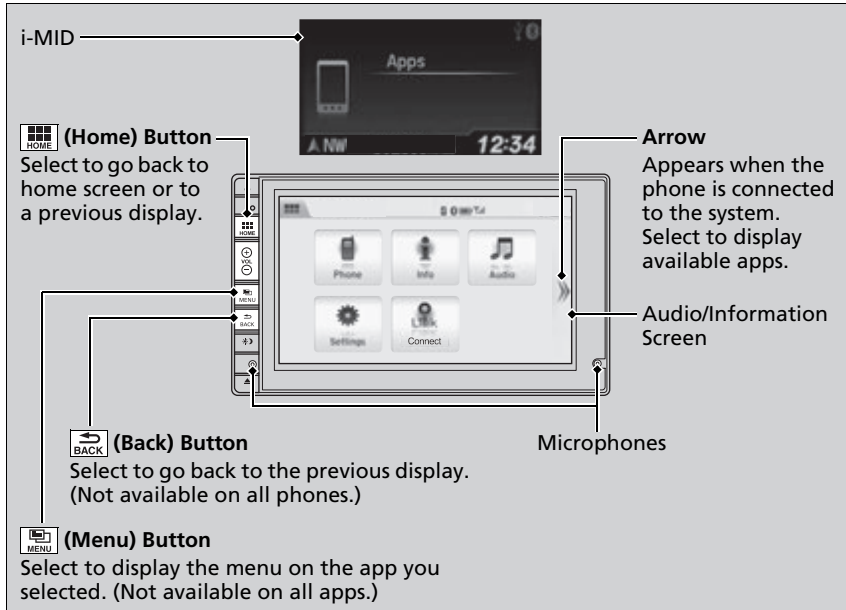

Smartphone Apps

Park in a safe place before connecting your phone and while operating the displayed apps.

Not all phones and apps are compatible with the system. The system does not display all the available apps on smartphone, and some apps need to be preinstalled. Ask a dealer for details.

You need to switch the *Bluetooth* connection to your smartphone if another electronic device is connected.

▶ Changing the currently paired phone P. 326

The following may vary by phone type:

- Connection methods.
- How to connect a smartphone to the system.
- Apps that can be operated on the screen.
- Display response time/update time.

We do not support every app operation on the display audio.

Ask the app provider for any questions on the app's features.

Siri Eyes Free

You can talk to Siri using the Talk button on the steering wheel when your iPhone is paired to *Bluetooth® HandsFreeLink®*.

➔ **Phone Setup** P. 325

☞ Siri Eyes Free

Siri is a trademark of Apple Inc.

Check Apple Inc. website for features available for Siri.

When operating the vehicle, only use Siri through the Talk button.

☞ Using Eyes Free





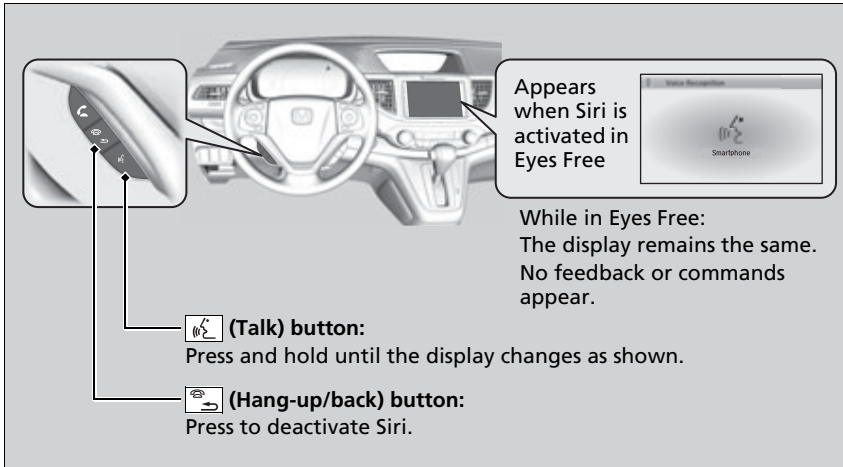

Some commands work only on specific phone features or apps.

■ Using Eyes Free



CD Player

If a disc error occurs, you may see the following error messages.

| Error Message | Cause | Solution |
|---|---------------------------------|---|
| Heat Error | High temperature | <ul style="list-style-type: none"> Turn the audio system off and allow the player to cool down until the error message is cleared. |
| Unsupported*¹ | Track/file format not supported | <ul style="list-style-type: none"> Current track/file will be skipped. The next supported track/file plays automatically. |
| Unplayable File*² | | |
| Bad Disc Please check owners manual. Push Eject*¹ | Mechanical error | <ul style="list-style-type: none"> Press the  (eject)*¹/ (eject/CLOSE)*² button and remove the disc, and check that the error message is cleared. Check that the disc is not damaged or deformed, and insert the disc again. <ul style="list-style-type: none">  Protecting CDs P. 272 If the error message reappears, press the  (eject)*¹/ (eject/CLOSE)*² button, and pull out the disc. Insert a different disc. If the new disc plays, there is a problem with the first disc. If the error message repeats, or the disc cannot be removed, contact a dealer. Do not try to force the disc out of the player. |
| Bad Disc Please check Owner's Manual Please push eject button*² | | |
| Mecha Error | | |
| Bad Disc Please check owners manual.*¹ | Servo error | <ul style="list-style-type: none"> Insert a different disc. If the new disc plays, there is a problem with the first disc. If the error message repeats, or the disc cannot be removed, contact a dealer. Do not try to force the disc out of the player. |
| Bad Disc Please Check Owners Manual*² | | |
| Check Disc | Disc error | <ul style="list-style-type: none"> Check that the disc is not damaged or deformed. <ul style="list-style-type: none">  Protecting CDs P. 272 |

*1:Models with one display

*2:Models with two displays

iPod/USB Flash Drive

If an error occurs while playing an iPod or USB flash drive, you may see the following error messages. If you cannot clear the error message, contact a dealer.

| Error Message | Solution |
|--|---|
| USB Error | Appears when there is a problem with the USB adapter unit. Check if the device is compatible with the USB adapter unit. |
| Bad USB Device Please Check Owners Manual.*¹ | Appears when an incompatible device is connected. Disconnect the device. Then turn the audio system off, and turn it on again. Do not reconnect the device that caused the error. |
| The connected USB device has a problem. See Owner's Manual*² | |
| No Song*¹ | Appears when the iPod is empty. Check that compatible files are stored on the device. |
| Unsupported Ver*¹ | Appears when an unsupported iPod is connected. If it appears when a supported iPod is connected, update the iPod software to the newer version. |
| Unsupported Version*² | |
| Retry Connection*¹ | Appears when the system does not acknowledge the iPod. Reconnect the iPod. |
| Connect Retry*² | |
| Unplayable File | Appears when the files in the USB flash drive are DRM or an unsupported format. This error message appears for about 3 seconds, then plays the next song. |

*1:Models with one display

*2:Models with two displays

| Error Message | Solution |
|--------------------|--|
| No Data | iPod*1 Appears when the iPod is empty. Check that compatible files are stored on the device. |
| | USB flash drive Appears when the USB flash drive is empty or there are no MP3, WMA, or AAC files in the USB flash drive. Check that compatible files are stored on the device. |
| Unsupported | Appears when an unsupported device is connected. If it appears when a supported device is connected, reconnect the device. |

*1: Models with two displays

U.S. models

Pandora®

If an error occurs while playing Pandora®, you may see the following error messages.
If you cannot clear the error message, contact a dealer.

Models with one display

| Error Message | Solution |
|---------------------------------|--|
| PANDORA No Station | Appears when there is no station list on the device. Use the device to create a station. |
| PANDORA Unsupported Ver. | Appears when Pandora version is not supported. Please update the device application. |
| PANDORA No Service | Appears when Pandora is performing system maintenance. Try again later. |
| PANDORA Check Device | Appears when Pandora is unable to play music. Check your device. |
| Pandora Loading | Appears when Pandora is loading. |

Models with two displays

| Error Message | Solution |
|--|---|
| The maximum number of stations that can be created is 100. To create more, please delete one or more previously created stations. | <ul style="list-style-type: none"> • Appears when the number of stations that can be created is exceeded. Follow the message. |
| Unable to create new station. Please try again. | |
| Unable to play Pandora. Please try again later. | <ul style="list-style-type: none"> • Appears when the commanded operation is failed. Try again later. |
| Unable to save bookmark. | |
| This Pandora station is currently not available. Please select another station. | <ul style="list-style-type: none"> • Appears when the station you selected is not available. Change a station, or try again later. |
| Unable to play Pandora. When stopped, log-in to Pandora. | <ul style="list-style-type: none"> • Appears when you have not logged into Pandora®. Follow the message. |
| Unable to connect to Pandora. When stopped, check your mobile phone. | |
| Unable to play Pandora. Please try again later. | <ul style="list-style-type: none"> • Appears when failed to connect. Check your device and try again. |
| Connect Retry | |

| Error Message | Solution |
|--|--|
| Unsupported | <ul style="list-style-type: none"> • Appears when the device is not supported. Use another device. |
| Unsupported Version | <ul style="list-style-type: none"> • Appears when Pandora® version is not supported. Update Pandora® to the latest version. |
| Pandora App version is not supported | <ul style="list-style-type: none"> • Appears when Pandora® is unable to play music. Check the Bluetooth status on your device. |
| Unable to connect to the phone. Please make sure the phone's Bluetooth setting is ON and try again. | <ul style="list-style-type: none"> • Appears when no data is available with Pandora® activated. Reboot the app and reconnect the device. |
| No Data | <ul style="list-style-type: none"> • Appears when an incompatible device is connected. Disconnect the device. Then turn the audio system off, and turn it again. Do not reconnect the device that caused the error. |
| The connected USB device has a problem. See Owner's Manual | <ul style="list-style-type: none"> • Appears when there is no station list on the device. Create one on your device. |
| No station list on device. Use device to create station. | <ul style="list-style-type: none"> • Appears when there is no station on app. Store some. |
| No Stations stored in Pandora App | <ul style="list-style-type: none"> • Appears when you try to skip a song or select Dislike over the predetermined number of times in an hour. |
| The maximum number of tracks that can be skipped per hour has been reached. | |

SiriusXM® Radio Service*

■ Subscribing to SiriusXM® Radio

1. You need your radio ID ready before registering for subscription. To see the ID in the display: Select **Channel List**.
2. Have your radio ID and credit card number ready, and either call or visit the SiriusXM® website to subscribe.

■ Receiving SiriusXM® Radio

Switch to the SiriusXM® mode by using the **SOURCE** button on the steering wheel, or through the audio/information screen, and stay in this mode for about 30 minutes until the service is activated. Make sure your vehicle is in an open area with good reception.

■ SiriusXM® Radio Display Messages

Loading:

SiriusXM® is loading the audio or program information.

Channel off air:

The channel is not currently broadcasting.

Channel unauthorized:

SiriusXM® radio is receiving information update from the network.

No Signal:

The signal is too weak in the current location.

Channel unavailable:

No such channel exists, the channel is not part of your subscription, or the artist or title information is unavailable.

Check antenna:

There is a problem with the SiriusXM® antenna. Contact a dealer.

* Not available on all models

☒ Subscribing to SiriusXM® Radio

Contact Information for SiriusXM® Radio:
US: SiriusXM® Radio at www.siriusxm.com or 1-800-852-9696
Canada: SiriusXM® Canada at www.xmradio.ca, or 1-877-209-0079

☒ Receiving SiriusXM® Radio

The SiriusXM® satellites are in orbit over the equator; therefore, objects south of the vehicle may cause satellite reception interruptions. Satellite signals are more likely to be blocked by tall buildings and mountains the farther north you travel from the equator.

You may experience reception problems under the following circumstances:

- In a location with an obstruction to the south of your vehicle.
- In tunnels
- On the lower level of a multi-tiered road
- Large items carried on the roof rack

Recommended CDs

- Use only high-quality CD-R or CD-RW discs labeled for audio use.
- Use only CD-R or CD-RW discs on which the recordings are closed.
- Play only standard round-shaped CDs.

The CD packages or jackets should have one of these marks.



CDs with MP3, WMA, or AAC* files

- Some software files may not allow for audio play or text data display.
- Some versions of MP3, WMA, or AAC* formats may be unsupported.

Protecting CDs

Follow these precautions when handling or storing CDs:

- Store a CD in its case when it is not being played.
- When wiping a CD, use a soft clean cloth from the center to the outside edge.
- Handle a CD by its edge. Never touch either surface.
- Never insert foreign objects into the CD player.
- Keep CDs out of direct sunlight and extreme heat.
- Do not place stabilizer rings or labels on the CD.
- Avoid fingerprints, liquids, and felt-tip pens on the CD.

Recommended CDs

A Dual-disc cannot play on this audio unit. If recorded under certain conditions, a CD-R or CD-RW may not play either.

Protecting CDs

NOTICE

Do not insert a damaged CD. It may be stuck inside and damage the audio unit.

Examples:

- Bubbled, wrinkled, labeled, and excessively thick CDs



Bubbled/
Wrinkled



With Label/
Sticker



Using
Printer Label
Kit

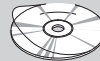

Sealed



With Plastic Ring

- Damaged CDs

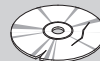

Chipped/
Cracked



Warped



Burrs

- Poor quality CDs

- Small CDs



3-inch
(8-cm)
CD

Compatible iPod, iPhone and USB Flash Drives

■ iPod and iPhone Model Compatibility

| Model |
|--|
| iPod (5th generation) |
| iPod classic 80/160 GB (launched in 2007) |
| iPod classic 120 GB (launched in 2008) |
| iPod classic 160 GB (launched in 2009) |
| iPod nano (1st to 6th generation) launch in 2011 |
| iPod nano (7th generation) launch in 2012* ¹ |
| iPod touch (1st to 4th generation) launch in 2011 |
| iPod touch (5th generation) launch in 2012* ¹ |
| iPhone 3G/iPhone 3GS/iPhone 4/iPhone 4s/iPhone5*/iPhone 5c*/iPhone 5s*/ iPhone 6*/iPhone 6 Plus* ¹ |

*1:Models with two displays

■ USB Flash Drives

- USB flash drives of 256 MB or higher are recommended.
- Some digital audio players may not be compatible.
- Some USB flash drives (e.g., a device with security lockout) may not work.
- Some software files may not allow for audio play or text data display.
- Some versions of MP3, WMA, or AAC formats may be unsupported.

☒ iPod and iPhone Model Compatibility

This system may not work with all software versions of these devices.

☒ USB Flash Drives

Files on the USB flash drive are played in their stored order. This order may be different from the order displayed on your PC or device.

Models with two displays

■ How to customize

While the vehicle is at a complete stop with the power mode in ON, select **Settings**, then select a setting item.

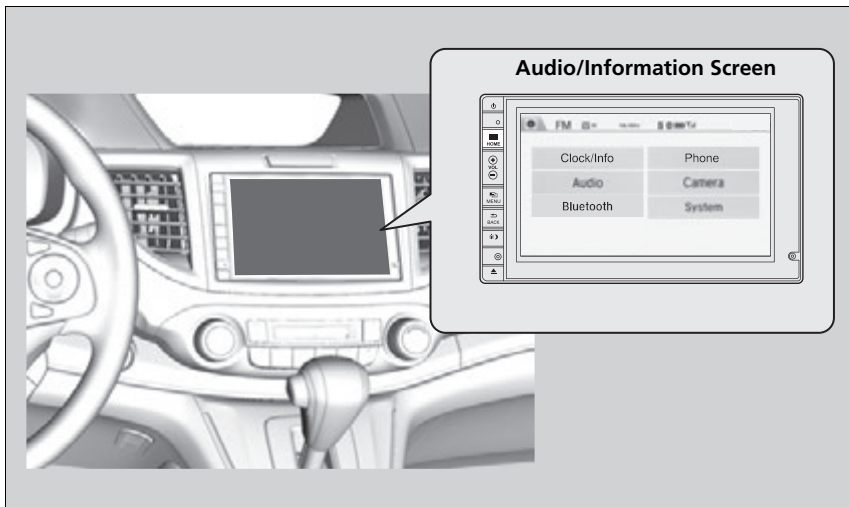

» Customized Features

Models with navigation system

See the Navigation System Manual for information of the customized features.

When you customize settings:

- Make sure that the vehicle is at a complete stop.
- Shift to **P**.

» How to customize

To customize other features, select **Settings**.

➤ **List of customizable options** P. 278

Models with two displays

■ Customization Flow

Press the  button.

Select **Settings**.

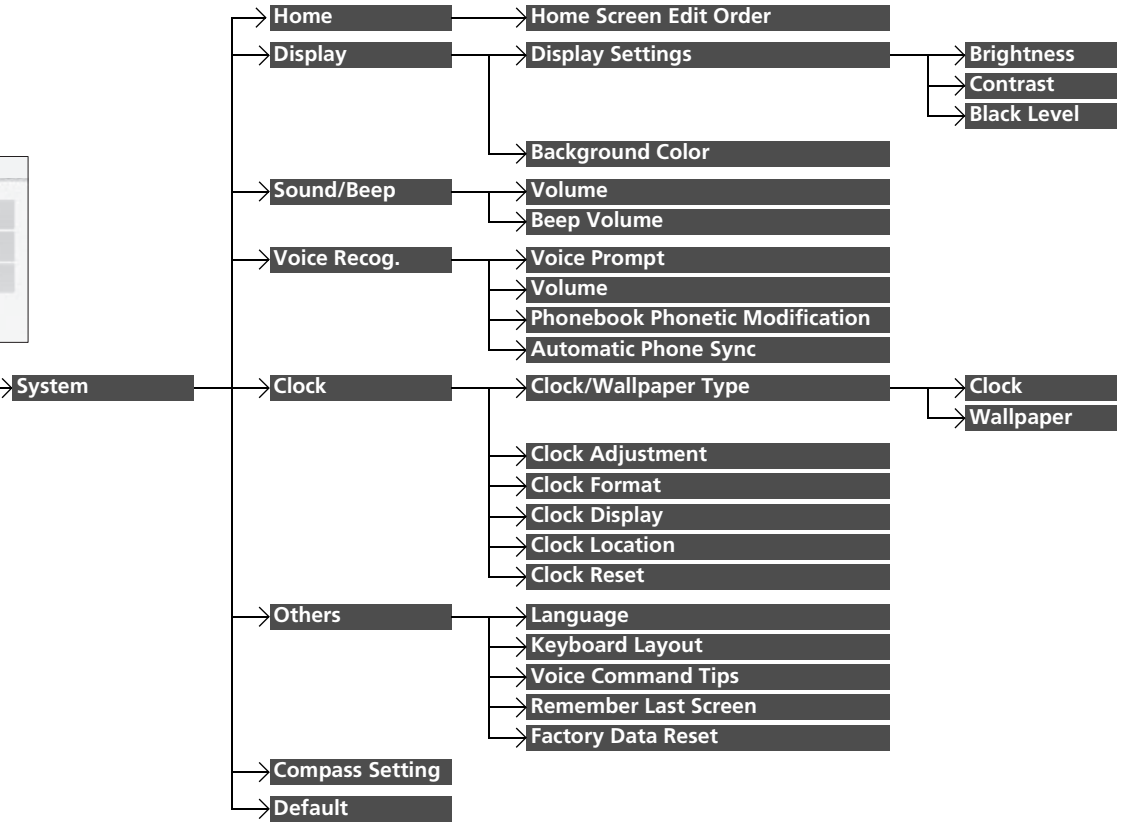
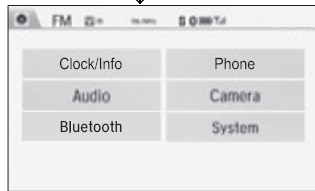

Features

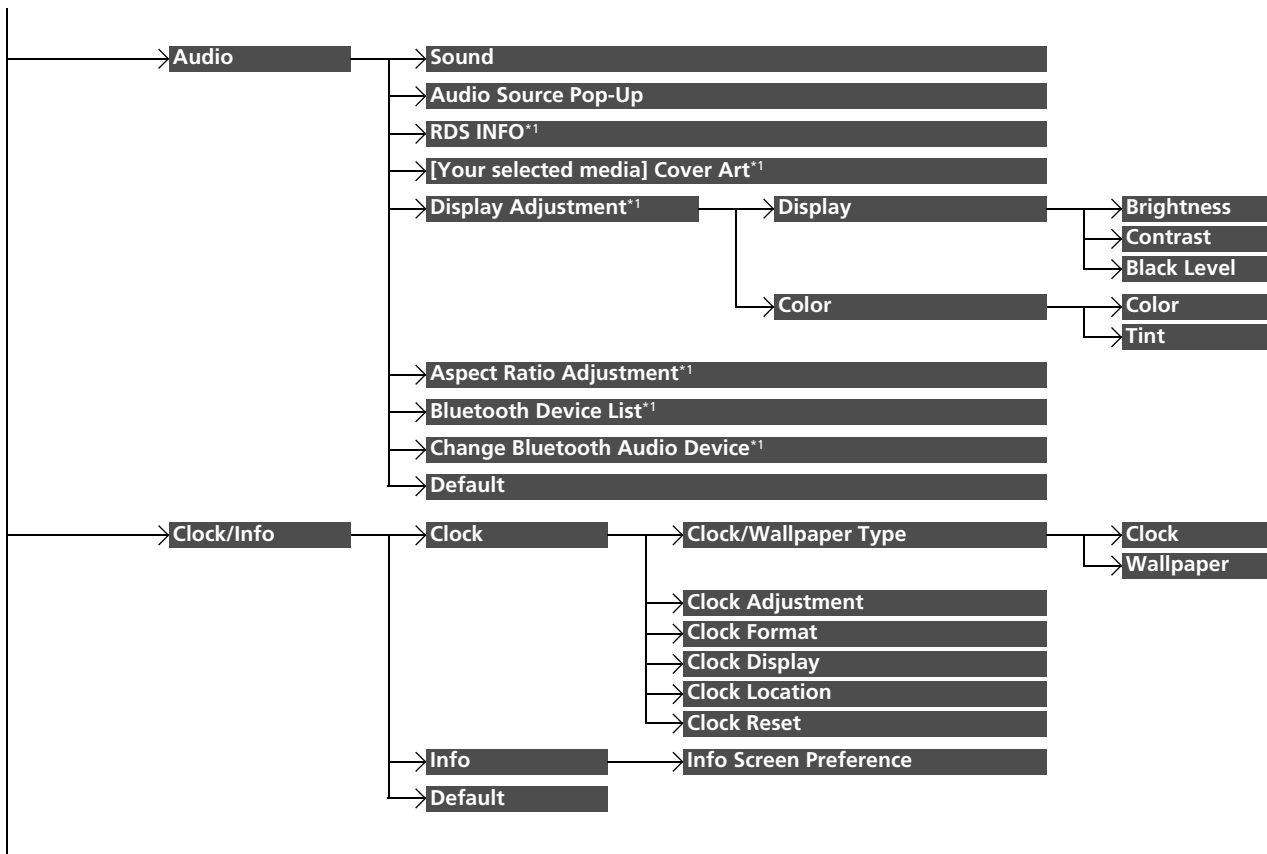

*1: May change depending on your currently selected source.

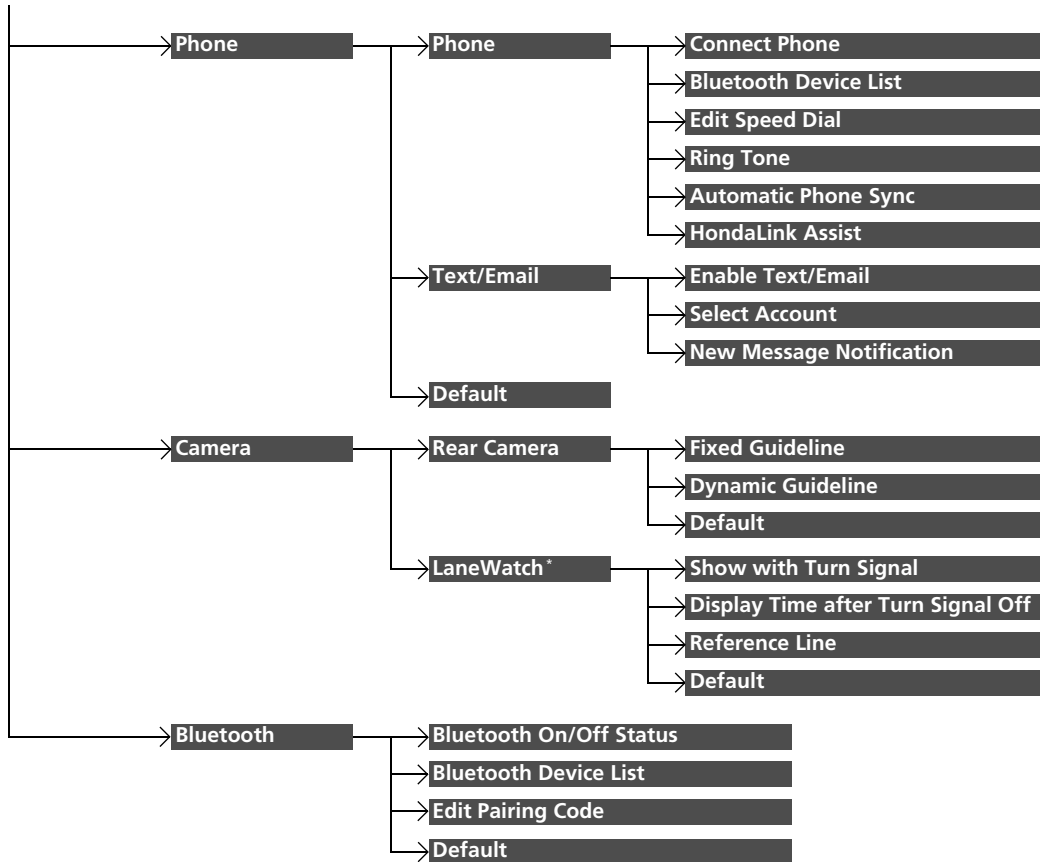

* Not available on all models

Models with two displays

■ List of customizable options

| Setup Group | Customizable Features | Description | Selectable Settings | |
|-------------|-----------------------|--|---|--------------------------------------|
| System | Home | Home Screen Edit Order  Changing the Home screen icon Layout P. 237 | — | |
| | Display | Brightness | Changes the brightness of the audio/information screen. | — |
| | | Contrast | Changes the contrast of the audio/information screen. | — |
| | | Black Level | Changes the black level of the audio/information screen. | — |
| | | Background Color | Changes the background color of the audio/information screen. | Blue* ¹ /Amber/Red/Violet |
| | Sound/Beep | Volume | Changes the sound volume. | 0-6* ¹ -11 |
| | | Beep Volume | Changes the beep volume. | Off/1/2* ¹ /3 |
| | Voice Recog. | Voice Prompt | Turns the voice prompt on and off. | On* ¹ /Off |
| | | Volume | Changes the volume of the voice prompt. | 0-6* ¹ -11 |
| | | Phonebook Phonetic Modification | Modifies a voice command for the phonebook. | — |
| | | Automatic Phone Sync | Sets a phonebook data to be automatically imported when a phone is paired to HFL. | On/Off |
| | | Default | Cancels/Resets all customized items in the Voice Recog. group as default. | Default/OK |

*1:Default Setting

| Setup Group | Customizable Features | | Description | Selectable Settings |
|-------------|-----------------------|--------------------------------------|---|--|
| System | Clock | Clock | Changes the clock display type. | Analog/Digital^{*1}/Small Digital/Off |
| | | Clock/ Wallpaper Type | <ul style="list-style-type: none"> Changes the wallpaper type. Imports an image file for a new wallpaper. Deletes an image file for a wallpaper. ▶ Wallpaper Setup P. 238 | Blank/Galaxy^{*1}/Metallic |
| | | Clock Adjustment | Adjusts Clock. ▶ Clock P. 130 | — |
| | | Clock Format | Selects the digital clock display from 12H to 24H. | 12H^{*1}/24H |
| | | Clock Display | Selects whether the clock display comes on. | On/Off^{*1} |
| | | Clock Location | Changes the clock display layout. | Upper Right^{*1}/Upper Left/ Lower Right/Lower Left/Off |
| | | Clock Reset | Cancels/Resets all customized items for clock display as default. | Yes/No |
| | Others | Language | Changes the display language. | English^{*1}/Français/Español |
| | | Keyboard Layout | Selects the on-screen keyboard type. | Alphabet/QWERTY^{*1} |
| | | Voice Command Tips | Alerts you when manual control of the system is disabled to prevent distraction while driving. Only voice commands are available. | On^{*1}/Off |
| | | Remember Last Screen | Selects whether the device remembers the last screen. | On/Off^{*1} |
| | | Factory Data Reset | Resets all the settings to their factory default. ▶ Defaulting All the Settings P. 284 | Yes/No |

*1:Default Setting

| Setup Group | Customizable Features | Description | Selectable Settings | |
|--------------------|--|--|---|---|
| System | Compass Setting | Calibrates the compass setting. ▶ Compass P. 347 | — | |
| | Default | Cancels/Resets all customized items in the System group as default. | Yes/No | |
| Audio | Sound | Adjusts the settings of the audio speaker's sound ▶ Adjusting the Sound P. 240 | -6 ~ 0*1 ~ +6 (BASS, TREBLE and Subwoofer), RR9~0*1~FR9 (FADER), L9~0*1~R9 (BALANCE), Off/Low/Mid*1/High (SVC) | |
| | Audio Source Pop-Up | Selects whether the list of selectable audio sources comes on or not when Audio is selected on the home screen. | On/Off*1 | |
| | RDS INFO <small>FM mode</small> | Turns on and off the RDS information. | On/Off*1 | |
| | Cover Art <small>FM, AM, iPod, Pandora*, USB or CD mode</small> [Your selected media] | Turns on and off the cover art display. | On*1/Off | |
| | Display Adjustment <small>HDMI® mode</small> | Display | Brightness | — |
| | | | Contrast | |
| Black Level | | | | |
| Color | Color | Changes the color of the audio/information screen. | — | |
| | Tint | Changes the tint of the audio/information screen. | — | |

*1:Default Setting

| Setup Group | Customizable Features | Description | Selectable Settings |
|-------------|--|---|---------------------------------|
| Audio | HDMI® mode Aspect Ratio Adjustment | Changes the aspect ratio and zoom settings of the audio/information screen. | Normal/Full*1/Zoom |
| | iPod, Pandora* or Bluetooth® Audio mode Bluetooth Device List | Pairs a new phone to HFL, edits or deletes a paired phone. ▶ Phone Setup P. 325 | — |
| | iPod, Pandora* or Bluetooth® Audio mode Change Bluetooth Audio Device | Connects, disconnects or pairs a <i>Bluetooth®</i> Audio device to HFL. | — |
| | Default | Cancels/Resets all customized items in the Audio group as default. | Yes/No |
| Clock/Info | Clock Clock/ Wallpaper type Clock Adjustment Clock Format Clock Display Clock Location Clock Reset | ▶ System P. 278 | |
| | Info Info Screen Preference | Changes the Info Screen type. | Info Top/Info Menu/Off*1 |
| | Default | Cancels/Resets all customized items in the Info group as default. | Yes/No |

*1:Default Setting

| Setup Group | Customizable Features | Description | Selectable Settings | |
|-------------|------------------------------|--|---|--------------------------------------|
| Phone | Connect Phone | Pairs a new phone to HFL, connects or disconnects a paired phone. ☑ Phone Setup P. 325 | — | |
| | Bluetooth Device List | Pairs a new phone to HFL, edits or deletes a paired phone. ☑ Phone Setup P. 325 | — | |
| | Edit Speed Dial | Edits, adds or deletes a speed dial entry. ☑ Speed Dial P. 333 | — | |
| | Ring Tone | Selects the ring tone. | Fixed/Mobile Phone ^{*1} | |
| | Automatic Phone Sync | Sets a phonebook data to be automatically imported when a phone is paired to HFL. | On/Off | |
| | HondaLink Assist | Turns HondaLink Assist on and off. | On/Off ^{*1} | |
| | Text/Email | Enable Text/Email | Turns the text/e-mail message function on and off. | On ^{*1} / Off |
| | | Select Account | Selects a mail or text message account. | — |
| | | New Message Notification | Selects whether a pop-up alert comes on the screen when HFL receives a new text/e-mail message. | On/Off ^{*1} |
| | Default | Cancels/Resets all customized items in the Phone and Text/Email group as default. | Yes/No | |

*1:Default Setting

| Setup Group | Customizable Features | Description | Selectable Settings | |
|-------------|--------------------------------|--|---|-----------------------------------|
| Camera | Rear Camera | Fixed Guideline | Selects whether the guidelines come on the rear camera monitor. | On ^{*1} /Off |
| | | Dynamic Guideline | Selects whether the guidelines adjust to the steering wheel angle. | On ^{*1} /Off |
| | | Default | Cancels/Resets all customized items in the Rear Camera group as default. | Yes/No |
| | LaneWatch [*] | Show with Turn Signal | Selects whether the LaneWatch display comes on when you move the turn signal lever to the passenger side. | On ^{*1} /Off |
| | | Display Time after Turn Signal Off | Changes the length of time the LaneWatch display stays on after you pull the turn signal lever back. | 0 second ^{*1} /2 seconds |
| | | Reference Lines | Selects whether the reference lines come on the LaneWatch monitor. | On ^{*1} /Off |
| | | Default | Cancels/Resets all customized items in the LaneWatch group as default. | Yes/No |
| Bluetooth | Bluetooth On/Off Status | Changes the <i>Bluetooth</i> [®] status. | On ^{*1} /Off | |
| | Bluetooth Device List | Pairs a new phone to HFL, edits or deletes a paired phone, or creates a security PIN. ➤ Phone Setup P. 325 | — | |
| | Edit Pairing Code | Edits the pairing code. ➤ To change the pairing code setting P. 327 | Random/Fixed ^{*1} | |
| | Default | Cancels/Resets all customized items in the Bluetooth group as default. | Yes/No | |

*1:Default Setting

* Not available on all models

Defaulting All the Settings

Models with two displays

Reset all the menu and customized settings as the factory defaults.

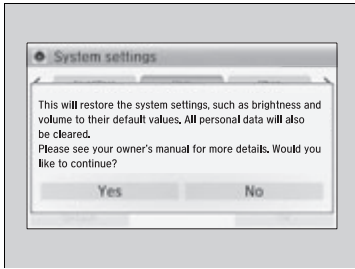

1. Press the  button.
2. Select **Settings**.
3. Select **System**.
 - Repeat the procedure to select **Others** tab, then **Factory Data Reset**.
 - The confirmation message will appear.
4. Select **Yes** to reset the settings.
5. Select **Yes** again to reset the settings.
 - The confirmation message will appear. Select **OK**.

►► Defaulting All the Settings

When you transfer the vehicle to a third party, reset all settings to default and delete all personal data.

The following settings will be reset:

- Audio preset settings
- Phonebook entries
- Other display and personal settings.

U.S. models only

The HomeLink® Universal Transceiver can be programmed to operate up to three remote controlled devices around your home, such as garage doors, lighting, or home security systems.

■ Important Safety Precautions

Refer to the safety information that came with your garage door opener to test that the safety features are functioning properly. If you do not have the safety information, contact the manufacturer.

Before programming HomeLink, make sure that people and objects are out of the way of the garage or gate to prevent potential injury or damage.

When programming a garage door opener, park just outside the garage door's path.

⌘ HomeLink® Universal Transceiver*

Before programming HomeLink to operate a garage door opener, confirm that the opener has an external entrapment protection system, such as an "electronic eye," or other safety and reverse stop features. If it does not, HomeLink may not be able to operate it.

* Not available on all models

Training HomeLink

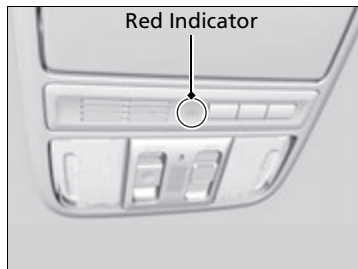

If it is necessary to erase a previously entered learned code:

- Press and hold the two outside buttons for about 20 seconds, until the red indicator blinks. Release the buttons, and proceed to step 1.
- If you are training the second or third button, go directly to step 1.

The instructions on the next page should work for most gate or garage openers, but may not work for all. For detailed instructions about your specific remote opener, visit <http://www.homelink.com> or call (800)355-3515.

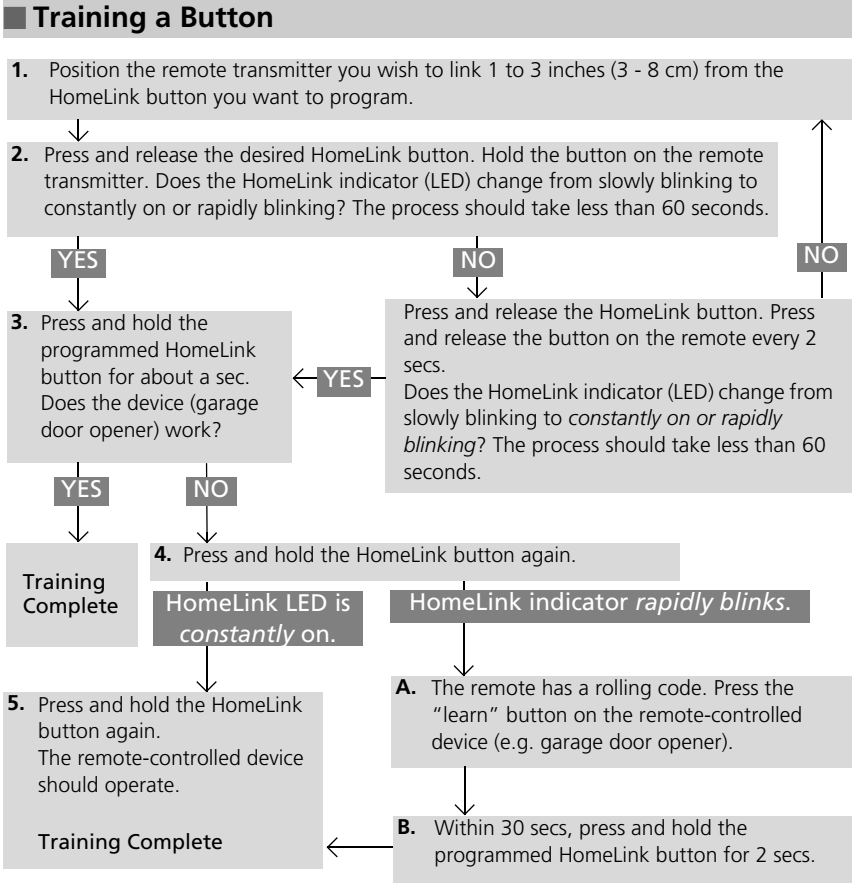

Training HomeLink

Retraining a Button

If you want to retrain a programmed button for a new device, you do not have to erase all button memory. You can replace the existing memory code using this procedure:

- Press and hold the desired HomeLink button until the HomeLink indicator begins to blink.
 - Standard transmitter**
Indicator remains on for about 25 secs.
 - Rolling code transmitter**
Indicator remains on for about 25 secs.
- Quickly release the HomeLink button and follow steps 1 - 3 under "Training a Button." You do not need to press and release the HomeLink button again in step 2.

Erasing Codes

To erase all the codes, press and hold the two outside buttons until the HomeLink indicator begins to blink (about 10 to 20 secs). You should erase all codes before selling the vehicle.

If you have any problems, see the device's instructions, visit www.homelink.com, or call HomeLink at (800) 355-3515.

HomeLink® is a registered trademark of Gentex Corporation.

Models with one display

Bluetooth® HandsFreeLink® (HFL) allows you to place and receive phone calls using your vehicle's audio system, without handling your cell phone.

Using HFL

HFL Buttons

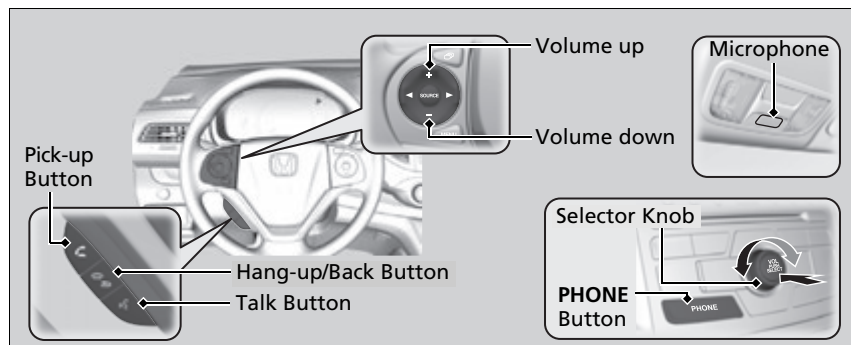



(Pick-up) button: Press to go directly to the **Phone** screen or to answer an incoming call.

(Hang-up/back) button: Press to end a call or to cancel a command.

(Talk) button: Press to call a number with a stored voice tag.

PHONE button: Press to go directly to the **Phone** screen.

Selector knob: Rotate  to select an item on the screen, then press .

Bluetooth® HandsFreeLink®

To use HFL, you need a *Bluetooth*-compatible cell phone. For a list of compatible phones, pairing procedures, and special feature capabilities:

- U.S.: Visit www.handsfreelink.honda.com, or call 1-888-528-7876.
- Canada: Visit www.handsfreelink.ca, or call 1-888-528-7876.

Voice control tips

- Aim the vents away from the ceiling and close the windows, as noise coming from them may interfere with the microphone.
- Press and release the  button when you want to call a number using a stored voice tag. Speak clearly and naturally after a beep.
- If the microphone picks up voices other than yours, the command may be misinterpreted.
- To change the volume level, use the audio system's volume knob or the remote audio controls on the steering wheel.

State or local laws may prohibit the operation of handheld electronic devices while operating a vehicle.

If you receive a call while using the audio system, the system resumes its operation after ending the call.

HFL Status Display

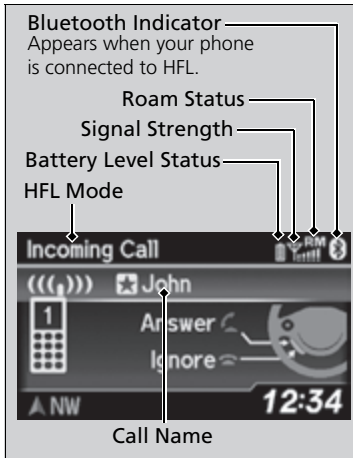

The i-MID notifies you when there is an incoming call.

Limitations for Manual Operation

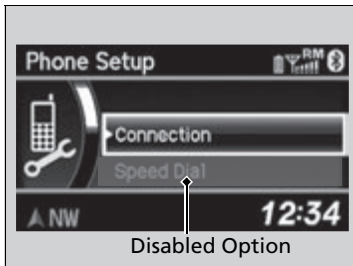

Certain manual functions are disabled or inoperable while the vehicle is in motion. You cannot select a grayed-out option until the vehicle is stopped.

Only previously stored speed dial entries can be called using voice commands while the vehicle is in motion.

▶ **Speed Dial** P. 305

Bluetooth® HandsFreeLink®

Bluetooth® Wireless Technology

The *Bluetooth*® word mark and logos are registered trademarks owned by *Bluetooth* SIG, Inc., and any use of such marks by Honda Motor Co., Ltd., is under license. Other trademarks and trade names are those of their respective owners.

HFL Limitations

An incoming call on HFL will interrupt the audio system when it is playing. It will resume when the call is ended.

HFL Status Display

The information that appears on the i-MID varies between phone models.

You can change the system language to English, French, or Spanish.

▶ **Customized Features** P. 116

HFL Menus

The ignition switch must be in ACCESSORY **I** or ON **II** to use HFL.

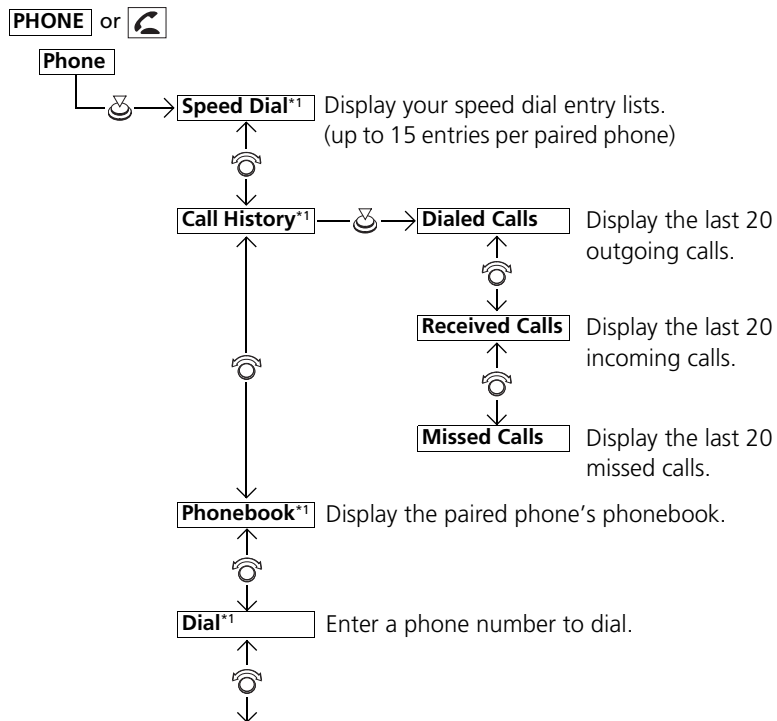

HFL Menus

To use HFL, you must first pair your *Bluetooth*-compatible cell phone to the system while the vehicle is parked.

Some functions are limited while driving. A message appears on the screen when the vehicle is moving and the operation is canceled.

*1:Appears only when a phone is connected to HFL.

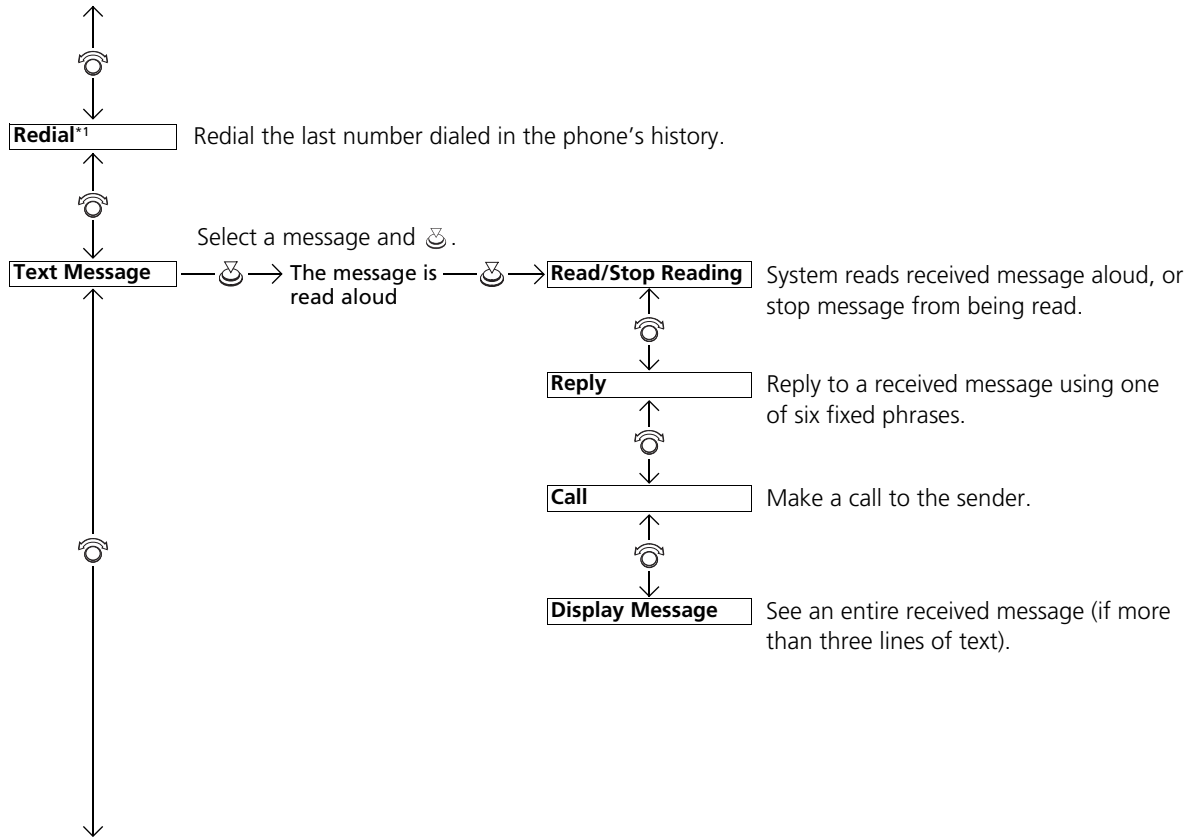

*1:Appears only when a phone is connected to HFL.

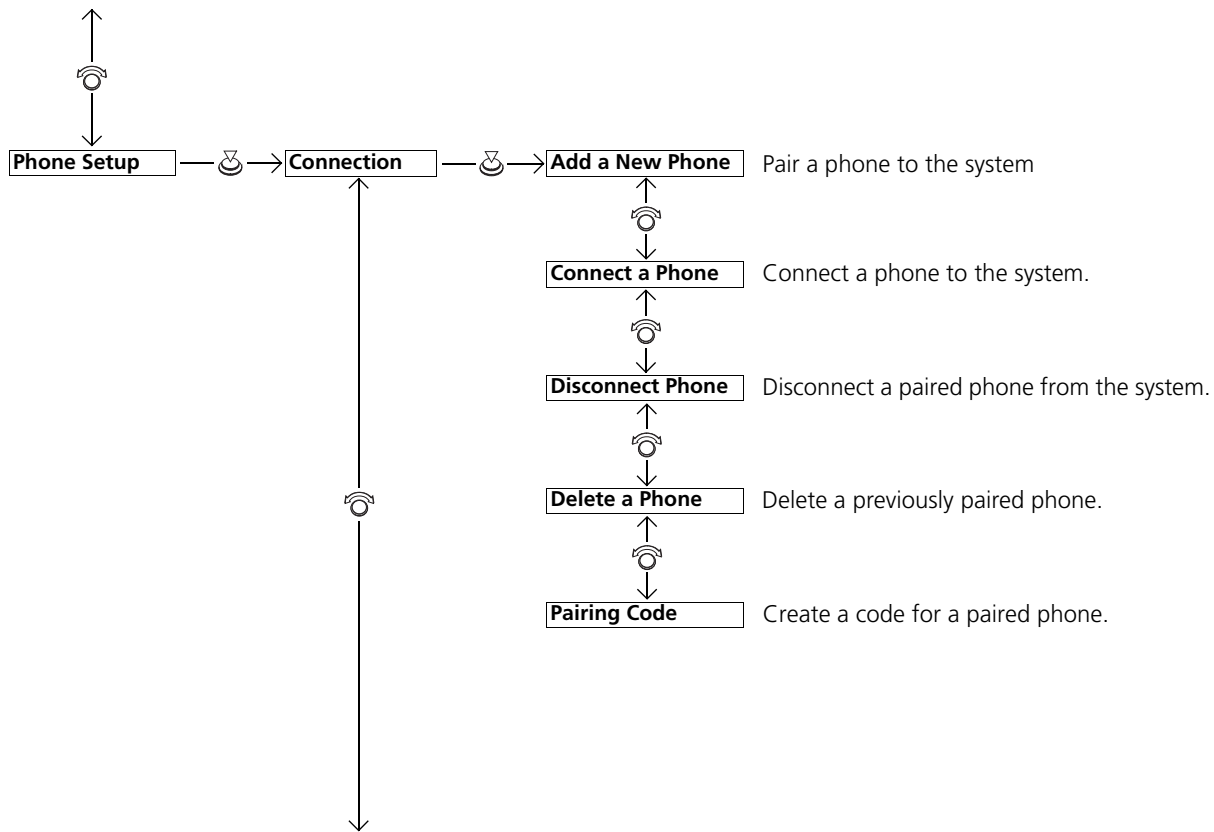

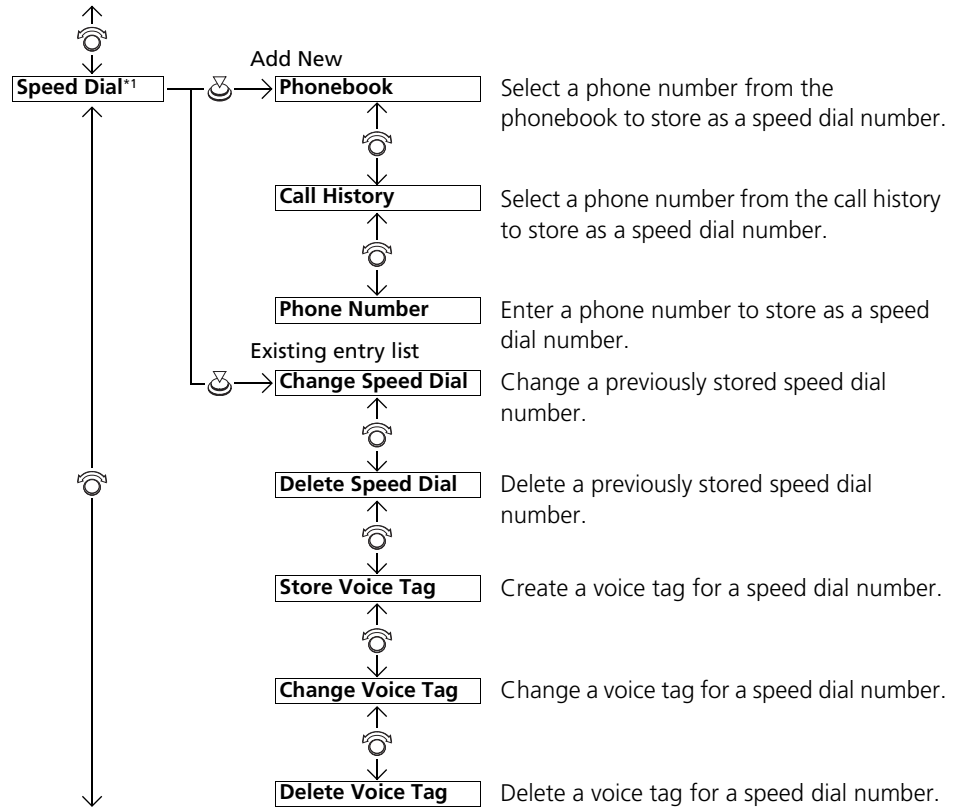

*1:Appears only when a phone is connected to HFL.

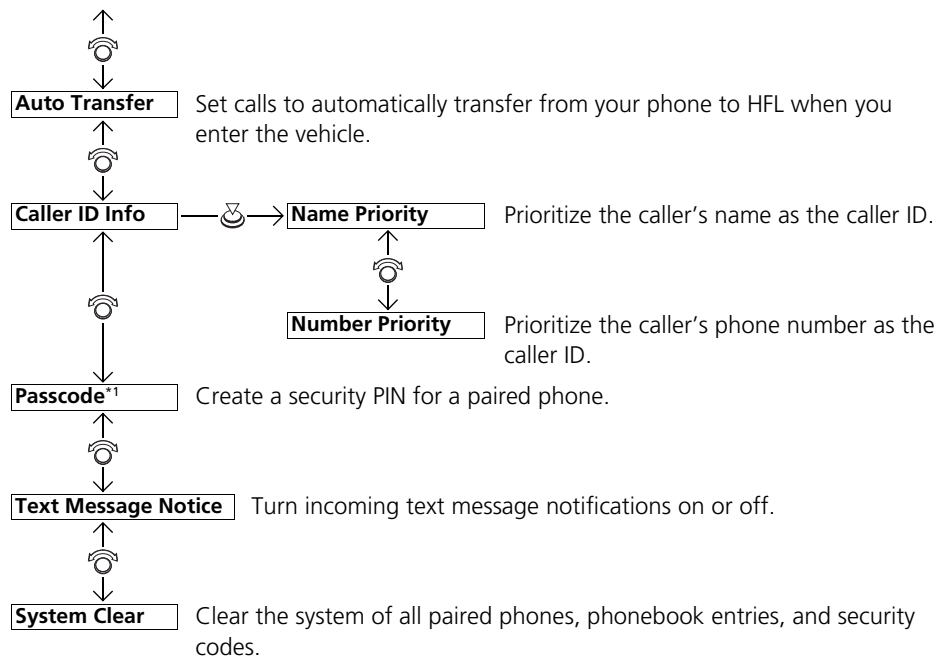

*1:Appears only when a phone is connected to HFL.

Phone Setup

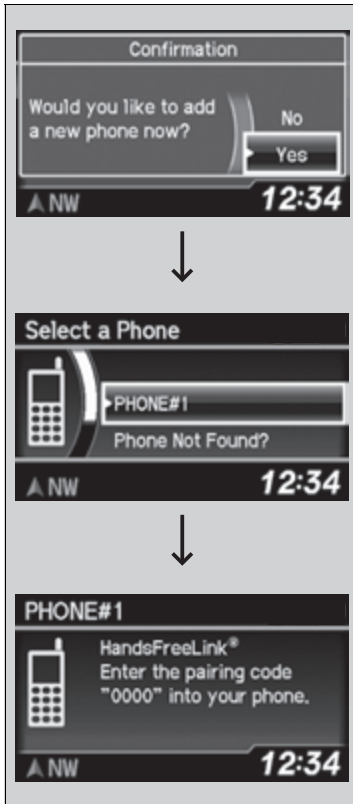

■ To pair a cell phone (No phone has been paired to the system)

1. Press the **PHONE** button or the button.
2. Rotate to select **Yes**, then press .
3. Make sure your phone is in search or discoverable mode, then press .
 - ▶ HFL automatically searches for a Bluetooth device.
4. When your phone appears on the list, select it by pressing .
 - ▶ If your phone doesn't appear, select **Phone Not Found?** and search for Bluetooth devices using your phone. From your phone, select **HandsFreeLink**.
5. HFL gives you a four-digit pairing code to input on your phone. When your phone prompts you, input the four-digit pairing code.
6. A notification appears on the screen if pairing is successful.

☒ Phone Setup

Your *Bluetooth*-compatible phone must be paired to HFL before you can make and receive hands-free calls.

Phone Pairing Tips:

- You cannot pair your phone while the vehicle is moving.
- Up to six phones can be paired.
- Your phone's battery may drain faster when it is connected to HFL.
- If your phone is not ready for pairing or not found by the system within three minutes, the system will time out and returns to idle.







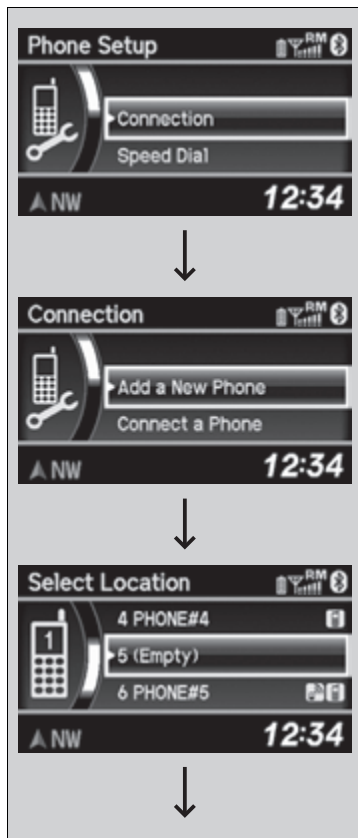

Once you have paired a phone, you can see it displayed on the screen with one or two icons on the right side.

These icons indicate the following:

- : The phone can be used with HFL.
- : The phone is compatible with *Bluetooth*® Audio.



■ **To pair a cell phone (when a phone has already been paired to the system)**

1. Press the **PHONE** button or the  button.
2. Rotate  to select **Phone Setup**, then press .
 - ▶ If a prompt appears asking to connect to a phone, select **No** and proceed with step 2.
3. Rotate  to select **Connection**, then press .
4. Rotate  to select **Add a New Phone**, then press .
 - ▶ The screen changes to **Select Location**.
5. Rotate  to select **Empty**, then press .

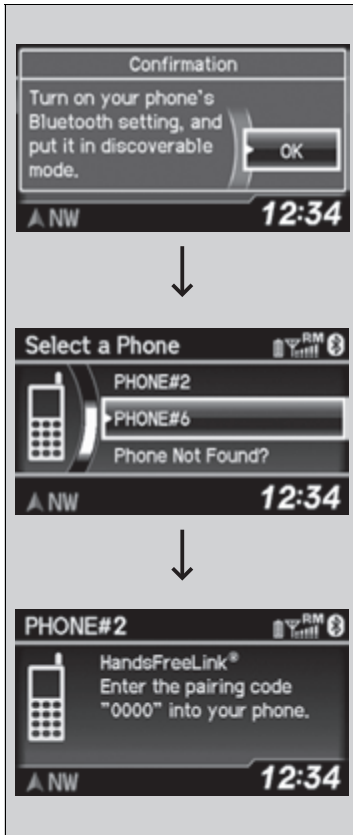

6. Make sure your phone is in search or discoverable mode, then press .
 - ▶ HFL automatically searches for a Bluetooth device.

7. When your phone appears on the list, select it by pressing .
 - ▶ If your phone doesn't appear, select **Phone Not Found?** and search for Bluetooth devices using your phone. From your phone, select **HandsFreeLink**.

8. HFL gives you a four-digit pairing code to input on your phone. When your phone prompts you, input the four-digit pairing code.
9. A notification appears on the screen if pairing is successful.

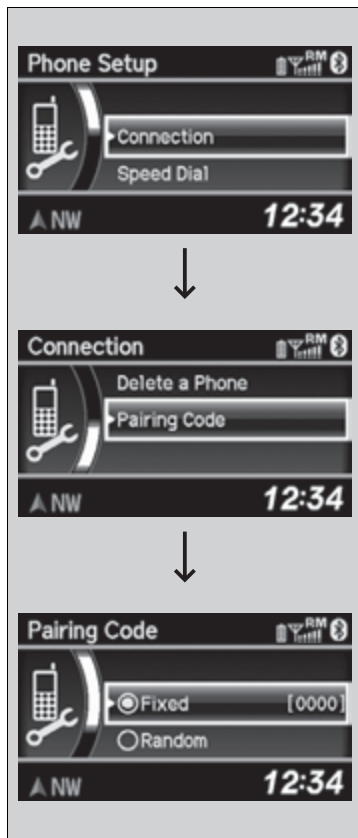

■ **To change the pairing code setting**

1. Press the **PHONE** button or the button.
2. Rotate to select **Phone Setup**, then press .

3. Rotate to select **Connection**, then press .
4. Rotate to select **Pairing Code**, then press .

5. Rotate to select **Fixed** or **Random**, then press .

▶▶ To change the pairing code setting

The default pairing code is "0000" until you change the setting.

To create your own, select **Fixed**, and delete the current code, then enter a new one.

For a randomly generated pairing code each time you pair a phone, select **Random**.

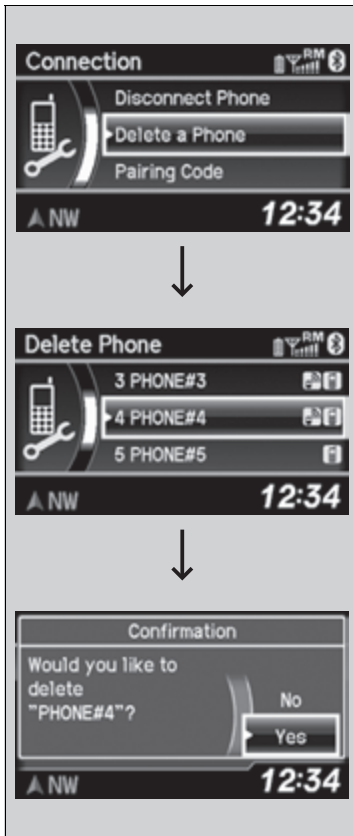

■ **To delete a paired phone**

1. Press the **PHONE** button or the button.
2. Rotate to select **Phone Setup**, then press .
 - ▶ Repeat the procedure to select **Connection**, then **Delete a Phone**.
3. Rotate to select a phone you want to delete, then press .
4. A confirmation message appears on the screen. Rotate to select **Yes**, then press .
 - ▶ A notification appears if the deletion is successful.

■ To Set Up a Text Message Notice Option

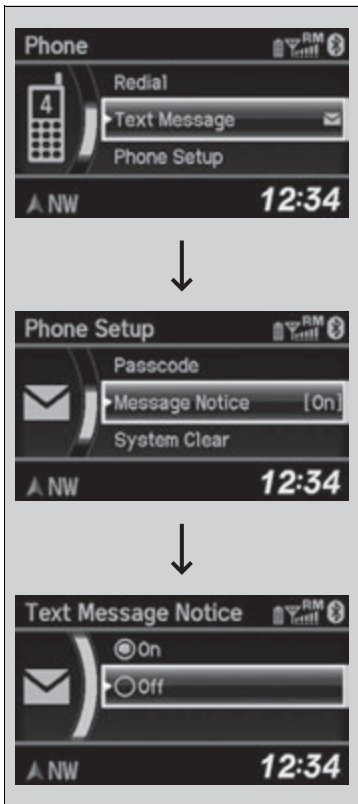

1. Press the **PHONE** button or the button.
2. Rotate to select **Phone Setup**, then press .
3. Rotate to select **Message Notice**, then press .
4. Rotate to select a mode you want, then press .









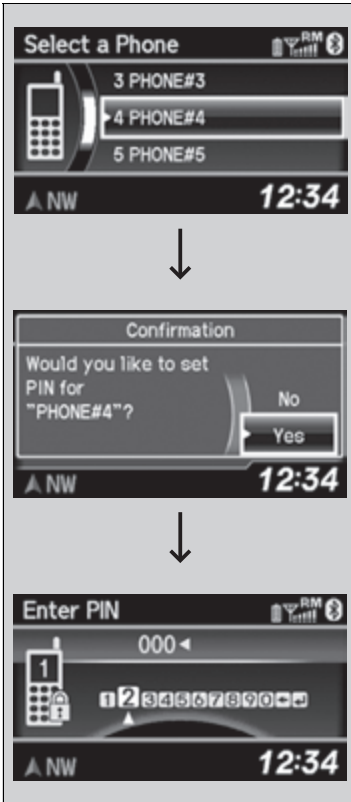

▶▶ To Set Up a Text Message Notice Option

ON: A pop-up notification comes on every time you receive a new text message.
OFF: The message you receive is stored in the system without notification.

■ To Create a Security PIN

You can protect each of the six cell phones with a security PIN.



1. Press the **PHONE** button or the  button.
2. Rotate  to select **Phone Setup**, then press .
 - ▶ Repeat the procedure to select **Passcode**.
3. Select a phone you want to add a security PIN to.
 - ▶ Rotate  to select a phone you want to add a security PIN to, then press .
4. A confirmation message appears on the screen.
 - ▶ Rotate  to select **Yes**, then press .
5. Enter a new four-digit number.
 - ▶ Rotate  to select, then press . Press  to delete. Press  to enter the security PIN.
6. Re-enter the four-digit number.
 - ▶ The screen returns to the screen in step 2.

☒ To Create a Security PIN

In the phone is already security PIN protected, you need to enter the current security PIN before clearing the PIN or creating a new one.

Continued

■ Automatic Transferring

If you get into the vehicle while you are on the phone, the call can be automatically transferred to HFL.

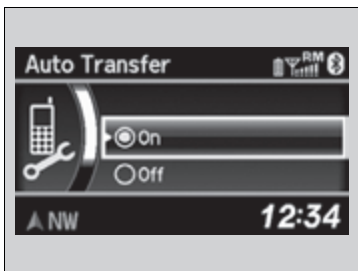

1. Press the **PHONE** button or the button.
2. Rotate to select **Phone Setup**, then press .
- ▶ Repeat the procedure to select **Auto Transfer**.
3. Rotate to select **On**, then press .
4. A notification appears on the screen if the change is successful.

■ Caller's ID Information

You can select a caller's information to be displayed when you have an incoming call.



1. Press the **PHONE** button or the button.
2. Rotate to select **Phone Setup**, then press .
- ▶ Repeat the procedure to select **Caller ID Info**.
3. Rotate to select a mode you want, then press .
4. A notification appears on the screen if the change is successful.

▶▶ Caller's ID Information







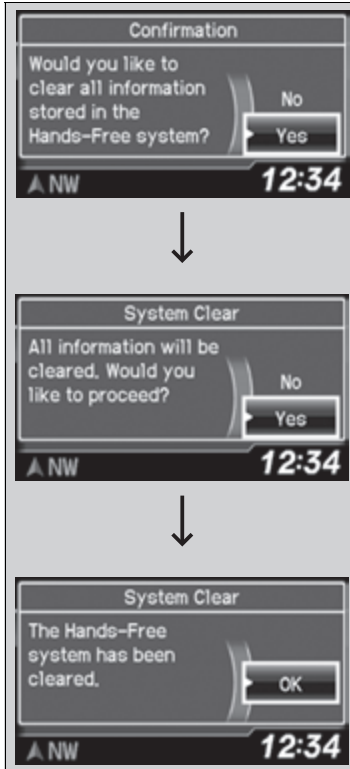

Name Priority mode: A caller's name is displayed if it is stored in the phonebook.

Number Priority mode: A caller's phone number is displayed.

To Clear the System

Security codes, paired phones, all stored voice tags, all speed dial entries, and all imported phonebook data are erased.



1. Press the **PHONE** button or the  button.
2. Rotate  to select **Phone Setup**, then press .
 - ▶ Repeat the procedure to select **System Clear**.
3. Rotate  to select **Yes**, then press .
4. A confirmation message appears on the screen. Rotate  to select **Yes**, then press .
5. A confirmation message appears on the screen. Rotate  to finish.

Continued

■ Automatic Import of Cellular Phonebook and Call History

When your phone is paired, the contents of its phonebook and call history are automatically imported to HFL.



☒ Automatic Import of Cellular Phonebook and Call History

When you select a person from the list in the cellular phonebook, you can see up to three category icons. The icons indicate what types of numbers are stored for that name.

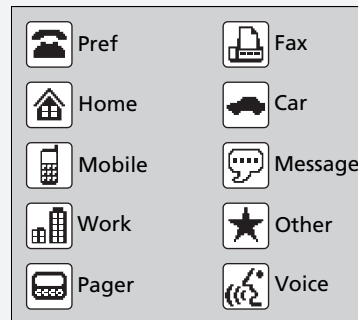

If a name has four or more numbers, ... appears instead of category icons.

On some phones, it may not be possible to import the category icons to HFL.

The phonebook is updated after every connection. Call history is updated after every connection or call.

Speed Dial

Up to 15 speed dial numbers can be stored per phone.

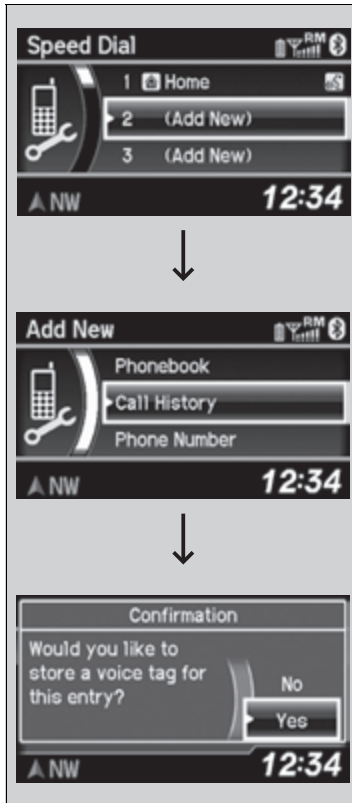

To store a speed dial number:

1. Press the **PHONE** button or the button.
2. Rotate to select **Phone Setup**, then press .
 - ▶ Repeat the procedure to select **Speed Dial**, then **Add New**.
3. Rotate to select a place to choose a number from, then press .
 - By **Phonebook**:
 - ▶ Select a number from the linked cell phone's imported phonebook.
 - By **Call History**:
 - ▶ Select a number from the call history.
 - By **Phone Number**:
 - ▶ Input the number manually.
4. When the speed dial is successfully stored, you are asked to create a voice tag for the number. Rotate to select **Yes** or **No**, then press .
5. Using the button, follow the prompts to say the name for the speed dial entry.

Speed Dial

You can use the audio preset buttons during a call to store a speed dial number:

1. Press and hold the desired audio preset button during a call.
2. The contact information for the active call will be stored for the corresponding speed dial.

When a voice tag is stored, you can press the button and call the number using voice commands.

Continued

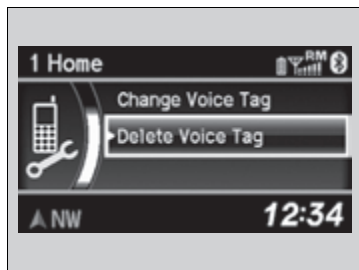

■ **To add a voice tag to a stored speed dial number**

1. Press the **PHONE** button or the button.
2. Rotate to select **Phone Setup**, then press .
 - ▶ Repeat the procedure to select **Speed Dial**.
3. Select an existing speed dial entry.
4. Rotate to select **Store Voice Tag**, then press .
5. Using the button, follow the prompts to complete the voice tag.

■ **To delete a voice tag**

1. Press the **PHONE** button or the button.
2. Rotate to select **Phone Setup**, then press .
 - ▶ Repeat the procedure to select **Speed Dial**.
3. Select an existing speed dial entry.
4. Rotate to select **Delete Voice Tag**, then press .
 - ▶ A confirmation message appears on the screen. Rotate to select **Yes**, then press .

☞ Speed Dial

Avoid using duplicate voice tags.
 Avoid using "home" as a voice tag.
 It is easier for HFL to recognize a longer name. For example, use "John Smith" instead of "John."

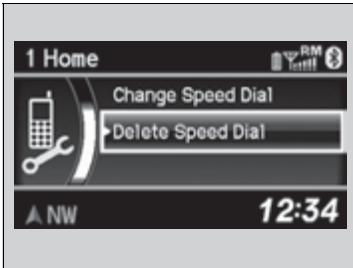

■ To delete a speed dial number

1. Press the **PHONE** button or the button.
2. Rotate to select **Phone Setup**, then press .
 - ▶ Repeat the procedure to select **Speed Dial**.
3. Select an existing speed dial entry.
4. Rotate to select **Delete Speed Dial**, then press .
 - ▶ A confirmation message appears on the screen. Rotate to select **Yes**, then press .

■ Making a Call

You can make calls by inputting any phone number, or by using the imported phonebook, call history, speed dial entries, or redial.

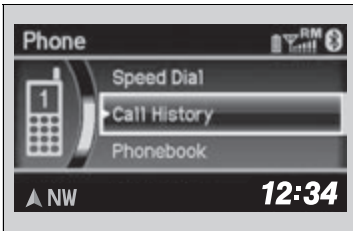

☒ Making a Call

Any voice-tagged speed dial entry can be dialed by voice from any screen.

Press the button and follow the prompts.

The maximum range between your phone and vehicles is 30 feet (10 meters).

Once a call is connected, you can hear the voice of the person you are calling through the audio speakers.

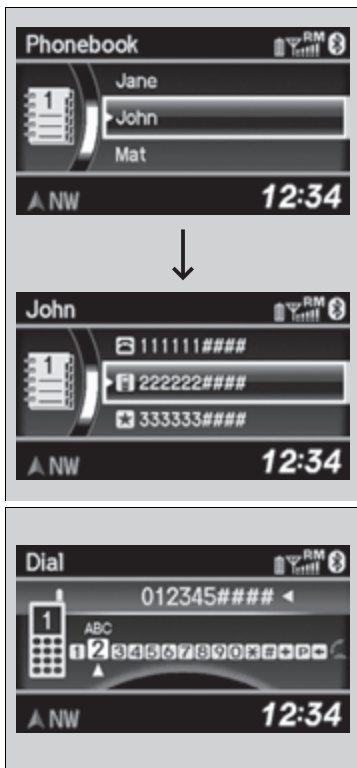

■ To make a call using the imported phonebook

When your phone is paired, the contents of its phonebook are automatically imported to HFL.

1. Press the **PHONE** button or the button.
 2. Rotate to select **Phonebook**, then press .
 3. The phonebook is stored alphabetically. Rotate to select the initial, then press .
 4. Rotate to select a name, then press .
 5. Rotate to select a number, then press .
- ▶ Dialing starts automatically.

■ To make a call using a phone number

1. Press the **PHONE** button or the button.
 2. Rotate to select **Dial**, then press .
 3. Rotate to select a number, then press .
 4. Rotate to select , then press .
- ▶ Dialing starts automatically.

▶▶ To make a call using the imported phonebook

This function is disabled while the vehicle is moving. However, you can call a stored voice-tagged speed dial number using voice commands.

- ▶ **Limitations for Manual Operation** P. 289
- ▶ **Speed Dial** P. 305

▶▶ To make a call using a phone number

This function is disabled while the vehicle is moving. However, you can call a stored voice-tagged speed dial number using voice commands.

- ▶ **Limitations for Manual Operation** P. 289
- ▶ **Speed Dial** P. 305



■ **To make a call using redial**

1. Press the **PHONE** button or the button.
2. Rotate to select **Redial**, then press .
- ▶ Dialing starts automatically.

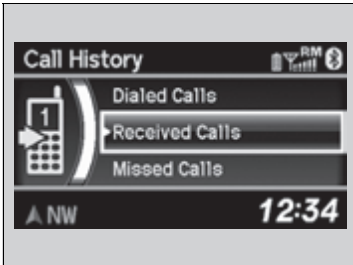

■ **To make a call using the call history**

Call history is stored by **Dialed Calls**, **Received Calls**, and **Missed Calls**.

1. Press the **PHONE** button or the button.
2. Rotate to select **Call History**, then press .
3. Rotate to select **Dialed Calls**, **Received Calls**, or **Missed Calls**, then press .
4. Rotate to select a number, then press .
- ▶ Dialing starts automatically.

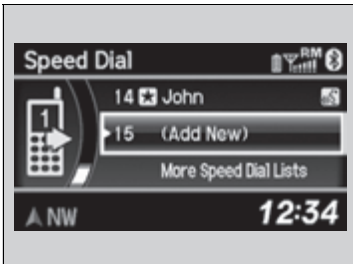

■ **To make a call using a speed dial entry**

1. Press the **PHONE** button or the button.
2. Rotate to select **Speed Dial**, then press .
3. Rotate to select a number, then press .
- ▶ Dialing starts automatically.

☒ To make a call using the call history

The call history appears only when a phone is connected to HFL, and displays the last 20 dialed, received, or missed calls.

☒ To make a call using a speed dial entry

On the **Phone** screen, the first six speed dials on the list can be directly selected by pressing the corresponding audio preset buttons (1-6).

Select **More Speed Dial Lists** to view another paired phone's speed dial list.

When a voice tag is stored, press the button and call the number using voice commands.

▶ **Speed Dial** P. 305

Any voice-tagged speed dial entry can be dialed by voice from any screen.

Press the button and follow the prompts.

Continued

Receiving a Call

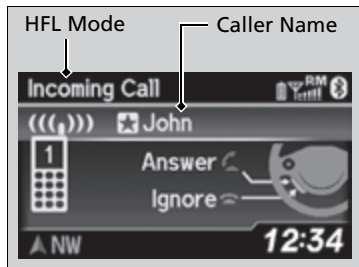

When there is an incoming call, an audible notification sounds (if activated) and the Incoming Call screen appears.

Press the  button to answer the call.

Press the  button to decline or end the call.

Receiving a Call

Call Waiting

Press the  button to put the current call on hold to answer the incoming call.

Press the  button again to return to the current call.

Ignore the incoming call if you do not want to answer it.

Press the  button if you want to hang up the current call.

Options During a Call

The following options are available during a call.



Mute: Mute your voice.

Transfer Call: Transfer a call from HFL to your phone.

Touch Tones: Send numbers during a call. This is useful when you call a menu-driven phone system.



1. To view the available options, press the **PHONE** button.

2. Rotate  to select the option, then press .
 - ▶ The check box is checked when **Mute** is selected. Select **Mute** again to turn it off.



Options During a Call

Touch Tones: Available on some phones.

■ Receiving a Text Message

HFL can display newly received text messages as well as 20 of the most recently received messages on a connected cell phone. Each received message can be read aloud and replied to using a fixed common phrase.



1. A pop-up appears and notifies you of a new text message.
2. Rotate  to select **Yes** to listen to the message, then press .
 - ▶ The text message is displayed. The system automatically starts reading out the message.
3. To discontinue the message read-out, press the  button.

▣ Receiving a Text Message

The system does not display any received messages while you are driving. You can only hear them read aloud.

With some phones, you may be able to display up to 20 most recent text messages.

Only the first three lines of the received message are displayed with this option.

▣ **Displaying an entire message** P. 316

Displaying Messages

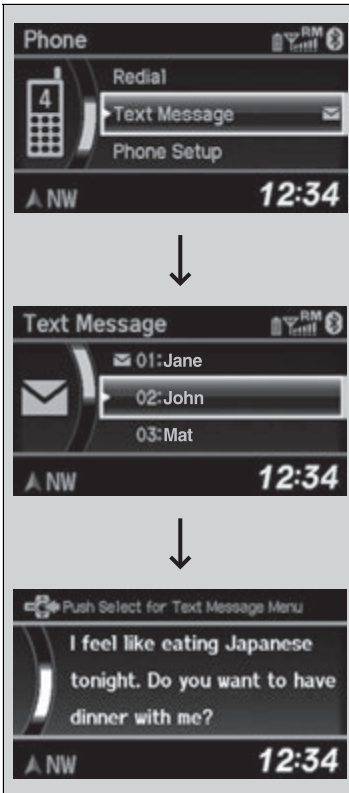

1. Press the **PHONE** button or the button.
2. Rotate to select **Text Message**, then press .

3. Rotate to select a message, then press .
 - ▶ The text message is displayed. The system automatically starts reading the message aloud.

Displaying Messages

The icon appears next to an unread message.

Only the first three lines of the received message are displayed with this option.

➤ **Displaying an entire message** P. 316

If you delete a message on the phone, the message disappears from the system. If you send a message from the system, the message goes to your phone.

Continued

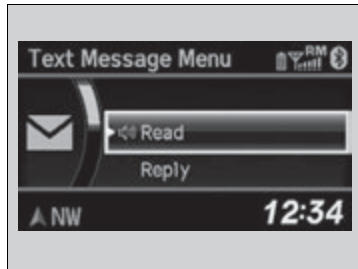

■ Using the stop reading or read option

1. Press the **PHONE** button or the button.
2. Rotate to select **Text Message**, then press .
3. Rotate to select a message, then press .
 - ▶ The text message is displayed. The system automatically starts reading the message aloud.
4. Press to enter **Text Message Menu**.
5. Rotate to select **Stop Reading** or **Read**, then press .

▣ Using the stop reading or read option

This option changes to:

- **Stop Reading** while the text message is read out. Select this option to discontinue the message read-out.
- **Read** when you go to the **Text Message** menu, or after you selected **Stop Reading**. Select this option to hear the system reading out the selected message.

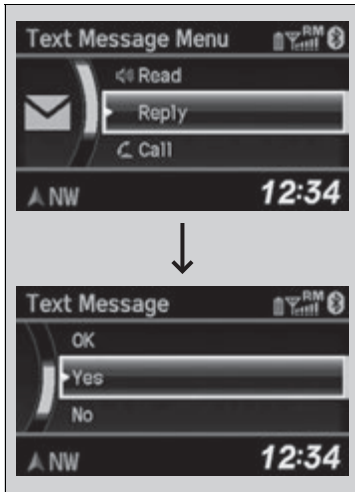

■ Reply to a message

You can reply to a message using one of the six common phrases available in the system.

1. Press the **PHONE** button or the button.
2. Rotate to select **Text Message**, then press .
3. Rotate to select a message, then press .
 - ▶ The text message is displayed. The system automatically starts reading out the message.
4. Press to enter the **Text Message Menu**.
5. Rotate to select **Reply**, then press .
6. Rotate to select the reply message, then press .
7. The reply message you selected is displayed. Select **Yes** to send the message.

▶▶ Reply to a message

The available fixed reply messages are as follows:

- **Talk to you later, I'm driving.**
- **I am on my way.**
- **I'm running late.**
- **OK**
- **Yes**
- **No**

You cannot add, edit, or delete reply messages.

After you reply, the following is displayed:

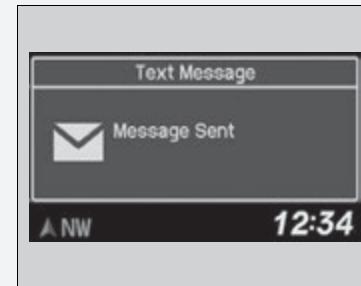

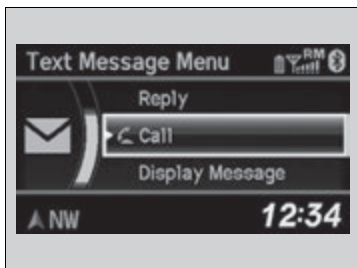

■ Making a call to a sender

You can call the text message sender.

1. Press the **PHONE** button or the button.
2. Rotate to select to **Text Message**, then press .
3. Rotate to select a message, then press .
 - ▶ The text message is displayed. The system automatically starts reading out the message.
4. Press to enter the **Text Message Menu**.
5. Rotate to select **Call**, then press .
 - ▶ HFL begins dialing.

■ Displaying an entire message

1. Press the **PHONE** button or the button.
2. Rotate to select to **Text Message**, then press .
3. Rotate to select a message, then press .
 - ▶ The text message is displayed. The system automatically starts reading out the message.
4. Press to enter the **Text Message Menu**.
5. Rotate to select **Display Message**, then press .
6. Rotate to scroll down and display the entire message.



Models with navigation system

See the Navigation System Manual for how to operate the *Bluetooth*® HandsFreeLink®.

Non-navi models with two displays

Bluetooth® HandsFreeLink® (HFL) allows you to place and receive phone calls using your vehicle's audio system, without handling your cell phone.

Using HFL

HFL Buttons

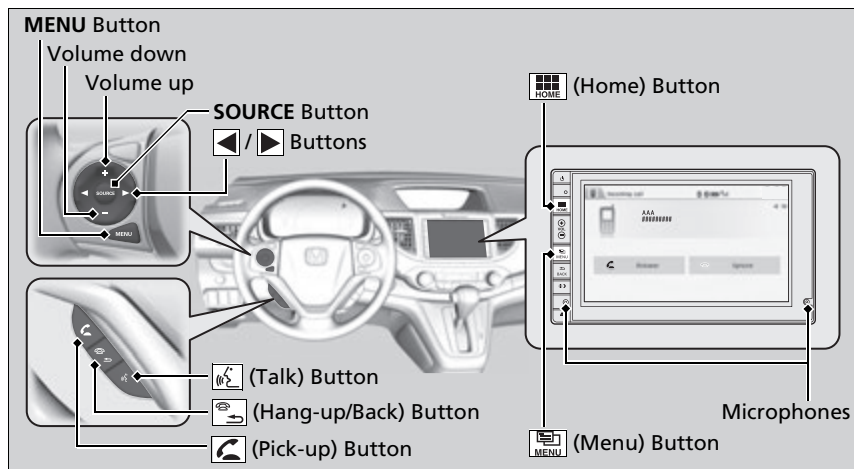

(Pick-up) button: Press to go directly to the **Phone** screen, or to answer an incoming call.

Bluetooth® HandsFreeLink®

To use HFL, you need a *Bluetooth*-compatible cell phone. For a list of compatible phones, pairing procedures, and special feature capabilities:

- U.S.: Visit www.handsfreelink.honda.com, or call 1-888-528-7876.
- Canada: Visit www.handsfreelink.ca, or call 1-888-528-7876.

To use HFL, the **Bluetooth On/Off Status** setting must be in **On**.

➤ **Customized Features** P. 274

Voice control tips

- Press the  button when you want to call a number using a stored voice tag, a phonebook, name or a number. Speak clearly and naturally after a beep.
- If the microphone picks up voices other than yours, the command may be misinterpreted.
- To change the volume level, use the audio system's **VOL** (Volume) or use the remote audio controls on the steering wheel.

State or local laws may prohibit the operation of handheld electronic devices while operating a vehicle.

Up to six speed dial entries can be displayed among a total of 20 that can be entered. If there is no entries in the system, Speed Dial is disabled.



➤ **Speed Dial** P. 305

Continued

 **(Hang-up/Back) button:** Press to end a call, go back to the previous command, or to cancel a command.



 **(Talk) button:** Press to call a number with a stored voice tag, a phonebook, name, or a number.

MENU button: Press and hold to display **Speed Dial**, **Call History**, or **Redial** on the **Phone** screen.

 /  **button:** Press to select an item displayed on the **Phone** screen.

SOURCE button: Press to call a number listed in the selected item on the **Phone** screen.

To go to the **Phone menu** screen:

1. Press the  button.
2. Select **Phone** to switch the display to the **Phone** screen.
3. Press the  button.

Using HFL

Bluetooth® Wireless Technology

The *Bluetooth®* word mark and logos are registered trademarks owned by Bluetooth SIG, Inc., and any use of such marks by Honda Motor Co., Ltd., is under license. Other trademarks and trade names are those of their respective owners.

HFL Limitations

An incoming call on HFL will interrupt the audio system when it is playing. It will resume when the call is ended.

HFL Status Display

The audio/information screen notifies you when there is an incoming call.

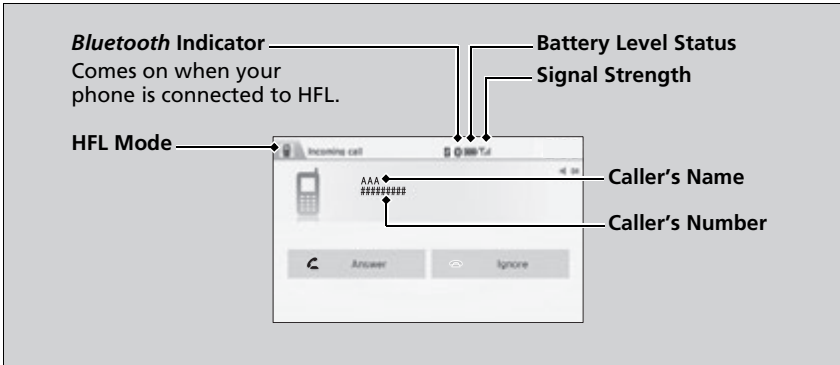

Limitations for Manual Operation

Certain manual functions are disabled or inoperable while the vehicle is in motion. You cannot select a grayed-out option until the vehicle is stopped.

Only previously stored speed dial entries with voice tags, phone book names, or numbers can be called using voice commands while the vehicle is in motion.

▶ **Speed Dial** P. 305

HFL Status Display

The information that appears on the audio/information screen varies between phone models.

You can change the system language to English, French, or Spanish.

▶ **Customized Features** P. 274

HFL Menu

The power mode must be in ACCESSORY or ON to use the system.

■ Phone settings screen

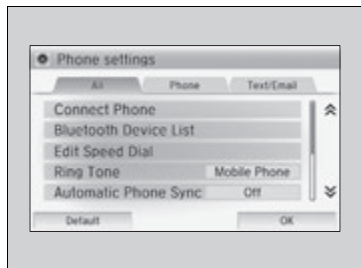

1. Press the button.
2. Select **Settings**.
3. Select **Phone**.

☒ HFL Menu

To use HFL, you must first pair your *Bluetooth*-compatible mobile phone to the system while the vehicle is parked.

Some functions are limited while driving. A message appears on the screen when the vehicle is moving and the operation is canceled.

Features

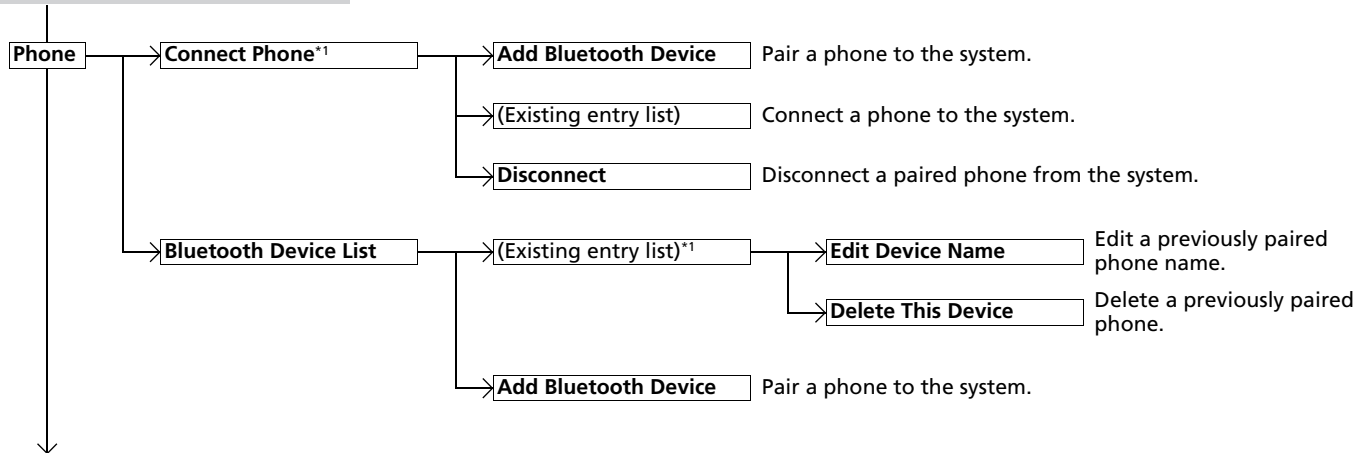

*1: Appears only when a phone is connected to HFL.

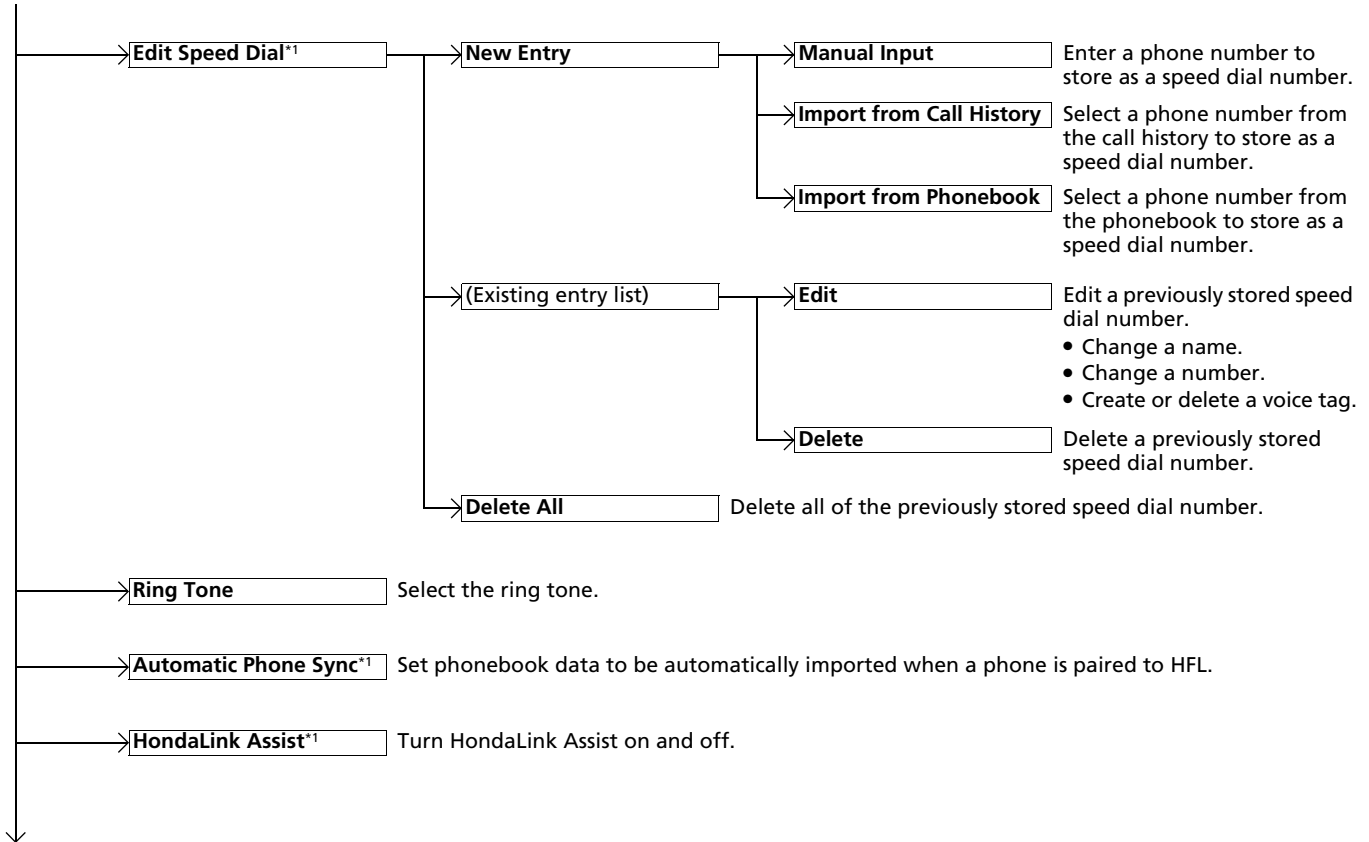

*1:Appears only when a phone is connected to HFL.

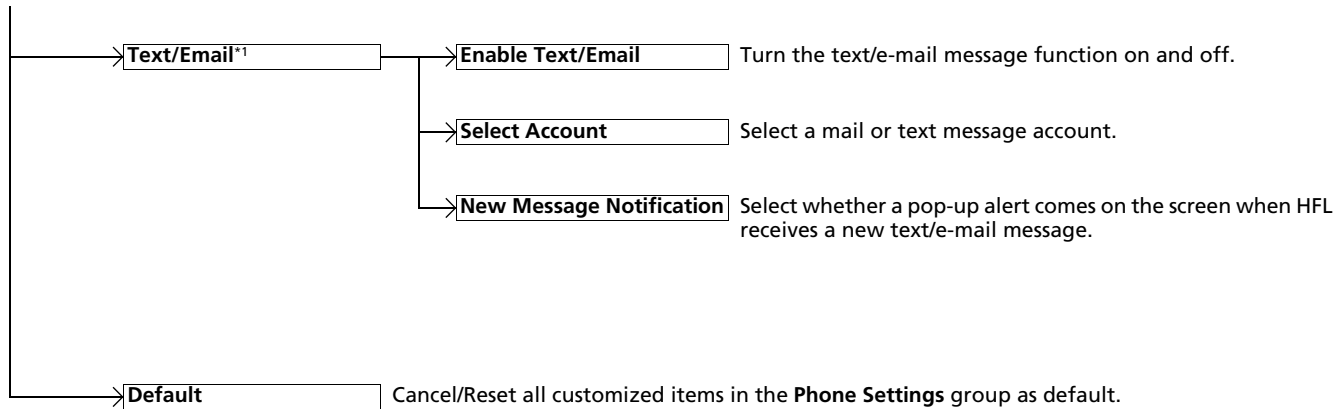

*1:Appears only when a phone is connected to HFL.

■ Phone menu screen

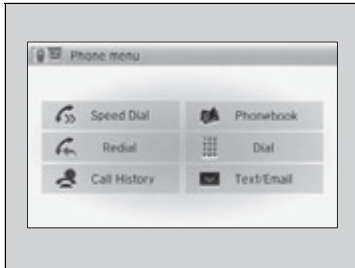

1. Press the  button.
2. Select **Phone**.
3. Press the  button.

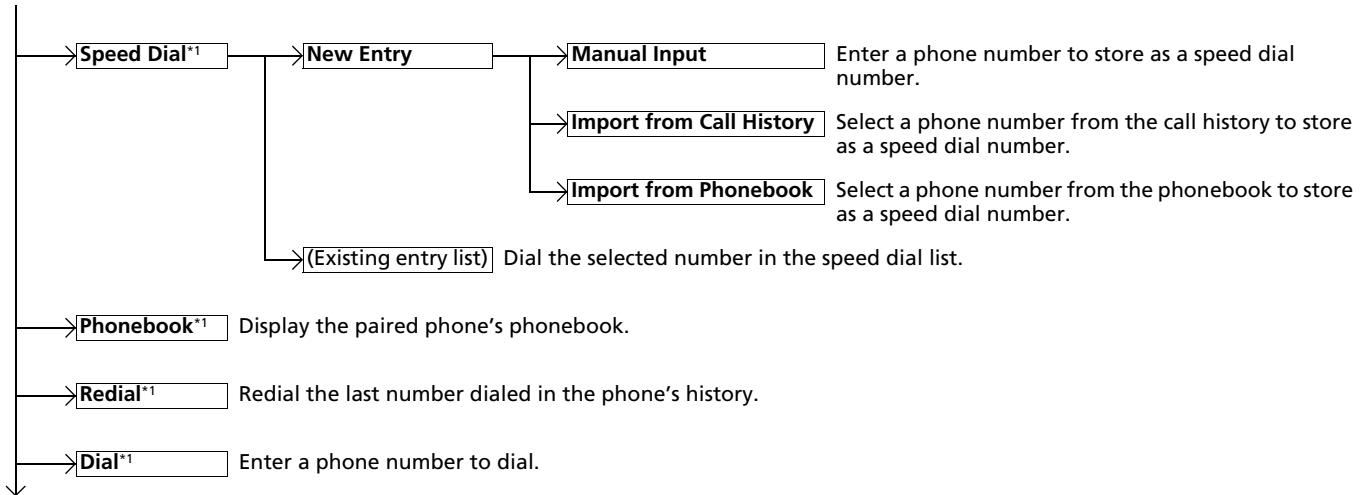

*1:Appears only when a phone is connected to HFL.

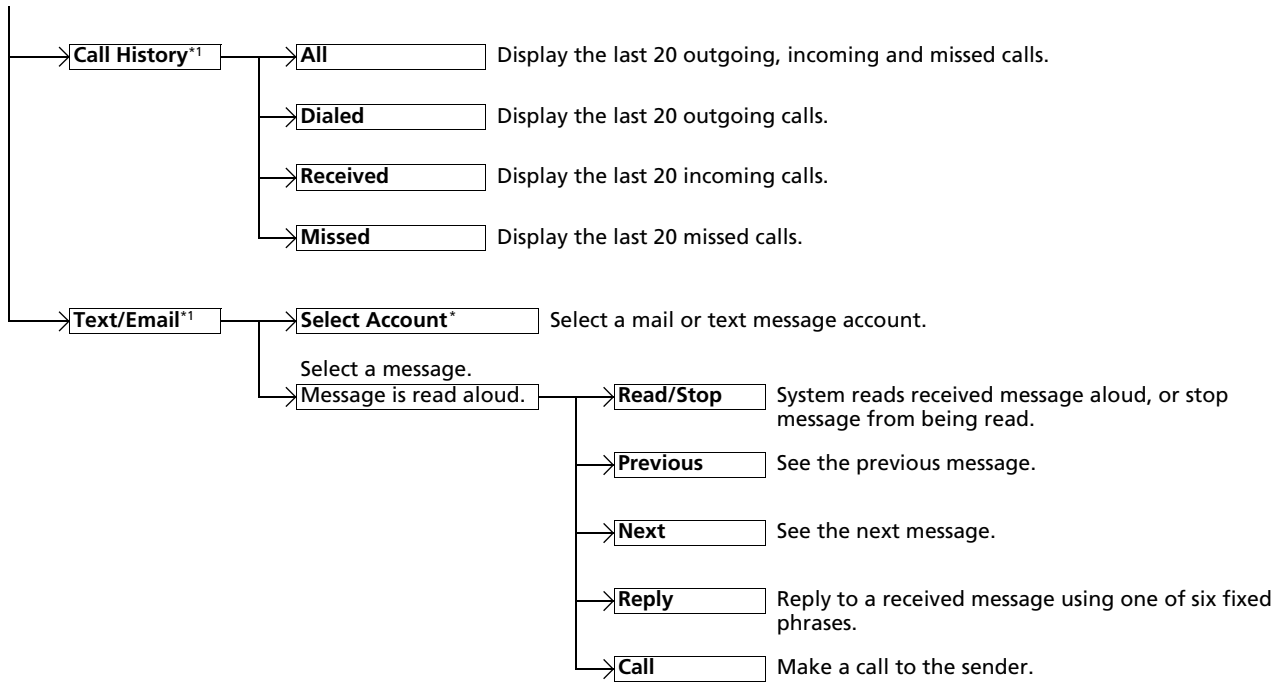

*1:Appears only when a phone is connected to HFL.

* Not available on all models

Phone Setup



■ To pair a mobile phone (when there is no phone paired to the system)

1. Select **Phone**.
2. Select **Yes**.
3. Make sure your phone is in search or discoverable mode, then select **Continue**.
 - ▶ HFL automatically searches for a *Bluetooth* device.
4. Select your phone when it appears on the list.
 - ▶ If your phone does not appear, you can select **Refresh** to search again.
 - ▶ If your phone still does not appear, select **Phone not Found** and search for *Bluetooth* devices using your phone. From your phone, select **HandsFreeLink**.
5. The system gives you a pairing code on the audio/information screen.
 - ▶ Confirm if the pairing code on the screen and your phone match. This may vary by phone.
6. A notification appears on the screen if pairing is successful.

☒ Phone Setup

Your *Bluetooth*-compatible phone must be paired to HFL before you can make and receive hands-free calls.

Phone Pairing Tips:

- You cannot pair your phone while the vehicle is moving.
- Up to six phones can be paired.
- Your phone's battery may drain faster when it is paired to HFL.
- If your phone is not ready for pairing or not found by the system, the system will return to the previous screen.

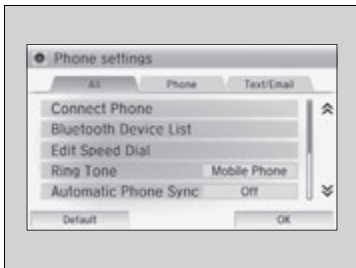

■ To pair a phone when a phone is already paired

1. Go to the **Phone** settings screen.
 - ▶ **Phone settings screen** P. 320
2. Select **Connect Phone**.
3. Select a phone to connect.
 - ▶ Pairing start.
4. A notification appears on the screen if pairing is successful.

■ Changing the currently paired phone

1. Go to the **Phone settings** screen.
 - ▶ **Phone settings screen** P. 320
2. Select **Connect Phone**.
3. Select a phone to connect.
 - ▶ HFL disconnects the current phone and starts searching for another paired phone.

⊗ Changing the currently paired phone

If no other phones are found or paired when trying to switch to another phone, HFL will inform you that the original phone is connected again.

To pair other phones, select **Add Bluetooth Device** from the **Connect Phone** screen.

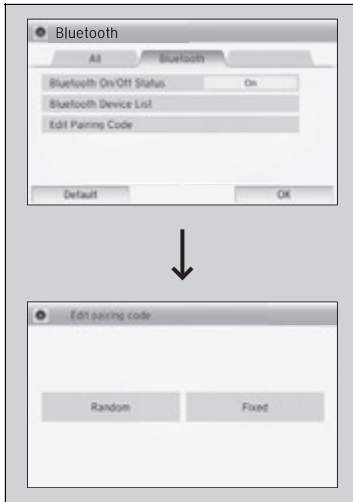

■ **To change the pairing code setting**

1. Press the  button.
2. Select **Settings**.
3. Select **Bluetooth**.
4. Select **Bluetooth** tab.
5. Select **Edit Pairing Code**.
6. Select **Fixed** or **Random**.

☒ To change the pairing code setting

The default pairing code is **0000** until you change the setting.

To create your own, select **Fixed**, and delete the current code, then enter a new one.

For a randomly generated pairing code each time you pair a phone, select **Random**.

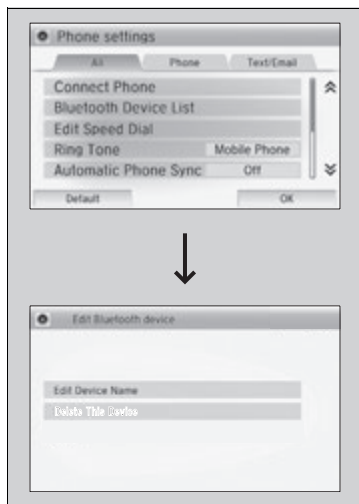

■ **To edit an already-paired phone name**

1. Go to the **Phone settings** screen.
 - ▶ **Phone settings screen** P. 320
2. Select **Phone** tab.
3. Select **Bluetooth Device List**.
4. Select a paired phone you want to edit.
5. Select **Edit Device Name**.
6. Edit the name and select **OK**.

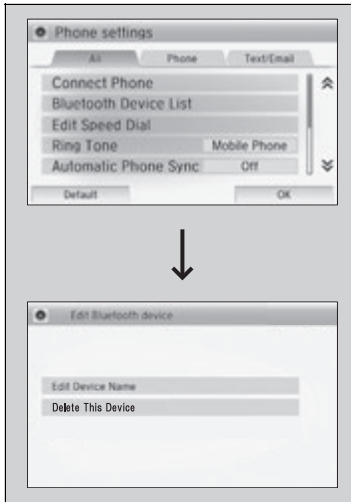

■ To delete a paired phone

1. Go to the **Phone settings** screen.
 - ▶ **Phone settings screen** P. 320
2. Select **Phone** tab.
3. Select **Bluetooth Device List**.
4. Select a phone you want to delete.
5. Select **Delete This Device**.
6. You will receive a confirmation message on the screen. Select **Yes**.
7. A notification appears if the deletion is successful.

■ To Set Up a Text/E-mail Message Options

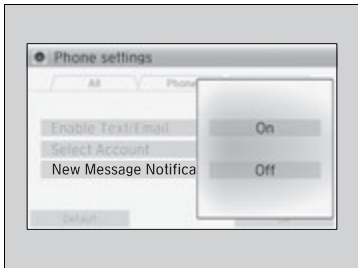
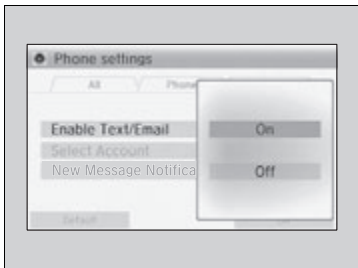

■ To turn on or off the text/e-mail message function

1. Go to the **Phone settings** screen.
 - ▶ **Phone settings screen** P. 320
2. Select **Text/Email** tab, then **Enable Text/Email**.
 - ▶ A pop-up menu appears on the screen.
3. Select **On** or **Off**.

■ To turn on or off the text/e-mail message notice

1. Go to the **Phone settings** screen.
 - ▶ **Phone settings screen** P. 320
2. Select **Text/Email** tab, then **New Message Notification**.
 - ▶ A pop-up menu appears on the screen.
3. Select **On** or **Off**.

▶▶ To turn on or off the text/e-mail message notice

- On:** A pop-up notification comes on every time you receive a new message.
- Off:** The message you receive is stored in the system without notification.

Ring Tone

You can change the ring tone setting.

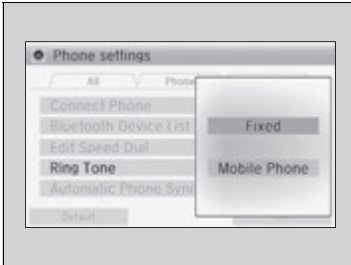

1. Go to the **Phone settings** screen.
 ▶ **Phone settings screen** P. 320
2. Select **Phone** tab, then **Ring Tone**.
3. Select **Fixed** or **Mobile Phone**.

Ring Tone

Fixed: The fixed ring tone sounds from the speaker.
Mobile Phone: The ring tone stored in the connected cell phone is heard through the vehicle speakers.

Continued

■ Automatic Import of Cellular Phonebook and Call History

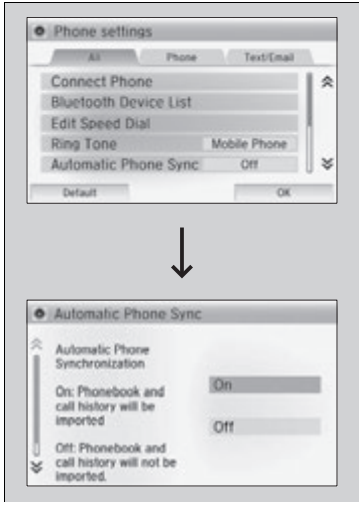

■ **When Automatic Phone Sync is set to On:**
 When your phone is paired, the contents of its phonebook and call history are automatically imported to the system.

- **Changing the Automatic Phone Sync setting**
1. Go to the **Phone settings** screen.
 ▶ **Phone settings screen** P. 320
 2. Select **Phone** tab, then **Automatic Phone Sync**.
 3. Select **On** or **Off**.

▶ Automatic Import of Cellular Phonebook and Call History

When you select a person from the list in the cellular phonebook, you can see up to three category icons. The icons indicate what types of numbers are stored for that name.

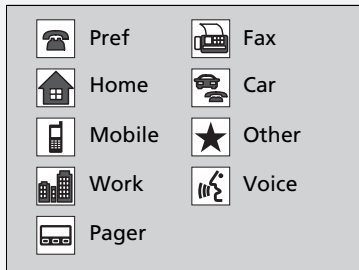

On some phones, it may not be possible to import the category icons to the system.

The phonebook is updated after every connection. Call history is updated after every connection or call.

Speed Dial

Up to 20 speed dial numbers can be stored per phone.

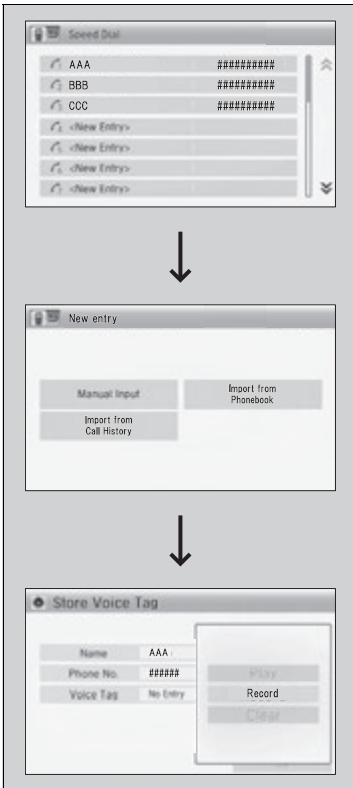

To store a speed dial number:

1. Go to the **Phone menu** screen.
 - ▶ **Phone menu screen** P. 323
2. Select **Speed Dial**.
 - ▶ Repeat the procedure to select **New Entry**.
3. Select a place to choose a number.
 - From **Import from Call History**:
 - ▶ Select a number from the call history.
 - From **Manual Input**:
 - ▶ Input the number manually.
 - From **Import from Phonebook**:
 - ▶ Select a number from the linked cell phone's imported phonebook.
4. When the speed dial is successfully stored from **Import from Call History** or **Import from Phonebook**, you are asked to create a voice tag for the number. Select **Yes** or **No**.
5. Select **Record** to store a voice tag for the speed dial entry.
 - ▶ Using the  button, follow the prompts to store a voice tag for the speed dial entry.

Continued

Speed Dial

When a voice tag is stored, press the  button to call the number using the voice tag. Say "Call" and the voice tag name.

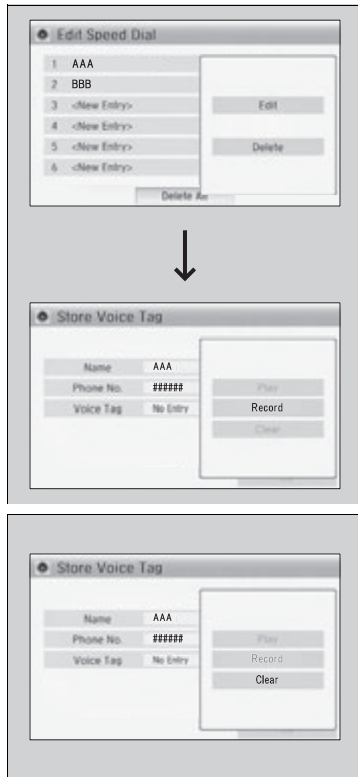

■ **To add a voice tag to a stored speed dial number**

1. Go to the **Phone settings** screen.
 - ▶ **Phone settings screen** P. 320
2. Select **Phone** tab, then **Edit Speed Dial**.
3. Select an existing speed dial entry.
 - ▶ From the pop-up menu, select **Edit**.
4. Select **Voice Tag**.
 - ▶ From the pop-up menu, select **Record**.
5. Select **Record** to store the voice tag.
6. Using the  button, follow the prompts to complete the voice tag.

■ **To delete a voice tag**

1. Go to the **Phone settings** screen.
 - ▶ **Phone settings screen** P. 320
2. Select **Phone** tab, then **Edit Speed Dial**.
3. Select an existing speed dial entry.
 - ▶ From the pop-up menu, select **Edit**.
4. Select **Voice Tag**.
 - ▶ From the pop-up menu, select **Clear**.
5. A confirmation message appears on the screen. Select **Yes**.

☞ Speed Dial

Avoid using duplicate voice tags.
 Avoid using "home" as a voice tag.
 It is easier for the system to recognize a longer name.
 For example, use "John Smith" instead of "John."

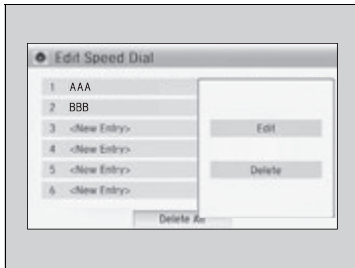

■ To delete a speed dial

1. Go to the **Phone settings** screen.
 ▶ **Phone settings screen** P. 320
2. Select **Phone** tab, then **Edit Speed Dial**.
3. Select an existing speed dial entry.
 ▶ From the pop-up menu, select **Delete**.
4. A confirmation message appears on the screen. Select **Yes**.

■ Making a Call

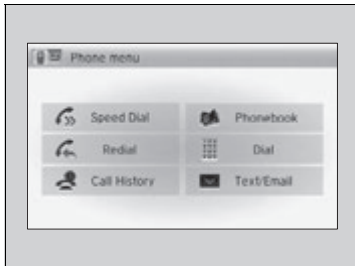

You can make calls by inputting any phone number, or by using the imported phonebook, call history, speed dial entries, or redial.

▶ Making a Call

Any voice-tagged speed dial entry, phonebook name, or number can be dialed by voice from most screens. Press the  button and say "Call" and the stored voice tag name.

The maximum range between your phone and vehicles is 30 feet (10 meters).

Once a call is connected, you can hear the voice of the person you are calling through the audio speakers.

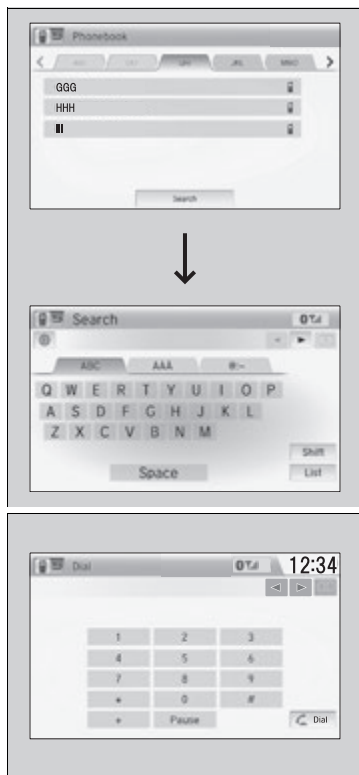

■ **To make a call using the imported phonebook**

1. Go to the **Phone menu** screen.
 - ▶ **Phone menu screen** P. 323
2. Select **Phonebook**.
3. Select a name.
 - ▶ You can also search by letter. Select **Search**.
 - ▶ Use the keyboard on the touch screen for entering letters.
4. Select a number.
 - ▶ Dialing starts automatically.

■ **To make a call using a phone number**

1. Go to the **Phone menu** screen.
 - ▶ **Phone menu screen** P. 323
2. Select **Dial**.
3. Select a number.
 - ▶ Use the keyboard on the touch screen for entering numbers.
4. Select .
 - ▶ Dialing starts automatically.

☒ **To make a call using the imported phonebook**

This function is disabled while the vehicle is moving. However, you can call a stored voice-tagged speed dial number using voice commands.

- ▶ **Limitations for Manual Operation** P. 319
- ▶ **Speed Dial** P. 333

☒ **To make a call using a phone number**

This function is disabled while the vehicle is moving. However, you can call a stored voice-tagged speed dial number using voice commands.

- ▶ **Limitations for Manual Operation** P. 319
- ▶ **Speed Dial** P. 333

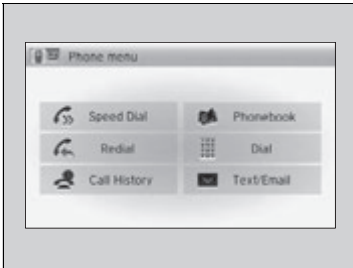

■ **To make a call using redial**

1. Go to the **Phone menu** screen.
 ▶ **Phone menu screen** P. 323
2. Select **Redial**.
 ▶ Dialing starts automatically.

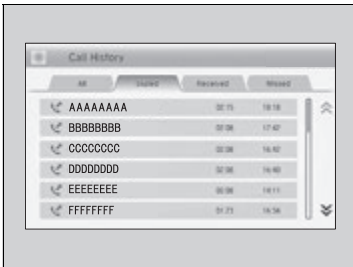

■ **To make a call using the call history**
 Call history is stored by **All, Dialed, Received, and Missed**.

1. Go to the **Phone menu** screen.
 ▶ **Phone menu screen** P. 323
2. Select **Call History**.
3. Select **All, Dialed, Received, or Missed**.
4. Select a number.
 ▶ Dialing starts automatically.

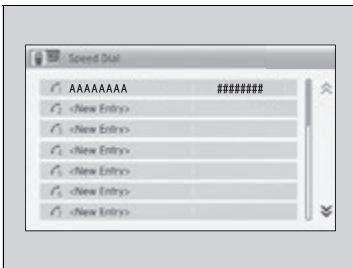

■ **To make a call using a speed dial entry**

1. Go to the **Phone menu** screen.
 ▶ **Phone menu screen** P. 323
2. Select **Speed Dial**.
3. Select a number.
 ▶ Dialing starts automatically.

☒ To make a call using redial

Press and hold the  button to redial the last number dialed in your phone's history.

☒ To make a call using the call history

The call history displays the last 20 dialed, received, or missed calls.
 (Appears only when a phone is connected to the system.)

☒ To make a call using a speed dial entry



When a voice tag is stored, press the  button to call the number using the voice tag.
 ▶ **Speed Dial** P. 333

Any voice-tagged speed dial entry can be dialed by voice from any screen.
 Press the  button and follow the prompts.

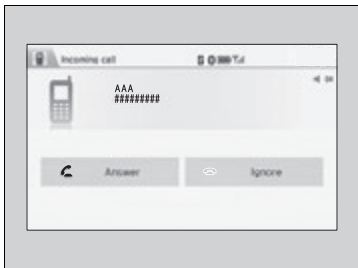
■ Receiving a Call



When there is an incoming call, an audible notification sounds and the **Incoming call** screen appears.

Press the  button to answer the call.
Press the  button to decline or end the call.

■ Options During a Call

The available options appear on the screen during a call.

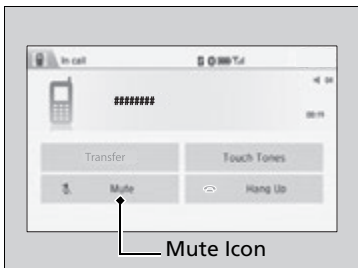

Mute: Mute your voice.

▶ The mute icon appears when **Mute** is selected. Select **Mute** again to turn it off.

Transfer: Transfer a call from the system to your phone.

Touch Tones: Send numbers during a call. This is useful when you call a menu-driven phone system.

☒ Receiving a Call



Call Waiting

Press the  button to put the current call on hold to answer the incoming call.

Press the  button again to return to the current call.

Select **Ignore** to ignore the incoming call if you do not want to answer it.

Press the  button if you want to hang up the current call.

You can select the icons on the touch screen instead of the  and  buttons.

☒ Options During a Call

Touch Tones: Available on some phones.

You can select the icons on the touch screen.

Receiving a Text/E-mail Message

HFL can display newly received text or e-mail messages as well as 20 of the most recently received messages on a linked cell phone. Each received message can be read aloud and replied to using a fixed common phrase.

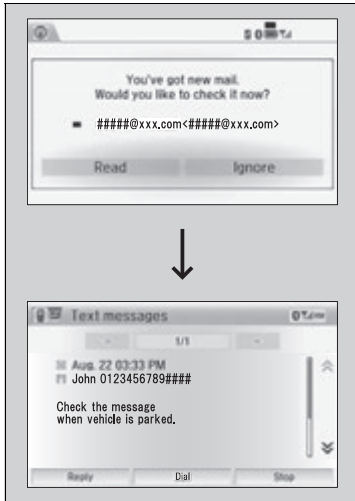

1. A pop-up appears and notifies you of a new text or e-mail message.
2. Select **Read** to listen to the message.
 - ▶ The text or e-mail message is displayed. The system automatically starts reading out the message.
3. To discontinue the message read-out, select **Stop**.

Receiving a Text/E-mail Message

The system does not display any received messages while you are driving. You can only hear them read aloud.

With some phones, you may be able to display up to 20 most recent text and e-mail messages.

State or local laws may limit your use of the HFL text/e-mail message feature. Only use the text/e-mail message feature when conditions allow you to do so safely.

When you receive a text or e-mail message for the first time since the phone is paired to HFL, you are asked to turn the **New Message Notification** setting to **On**.

▶ **To turn on or off the text/e-mail message notice** P. 330

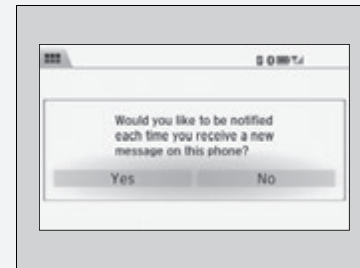

■ Selecting a E-mail Message Account

If a paired phone has text or e-mail message accounts, you can select one of them to be active and receive notifications.

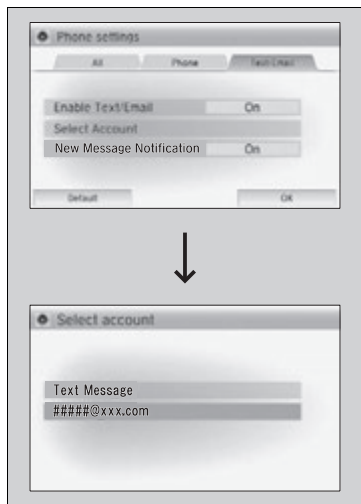

1. Go to the **Phone settings** screen.
 - ▶ **Phone settings screen** P. 320
2. Select **Text/Email** tab, then **Select Account**.
 - ▶ A pop-up menu appears on the screen.
3. Select **Text Message** or an e-mail message account you want.

▶▶ Selecting a E-mail Message Account

You can also select a mail account from the folder list screen or the message list screen.

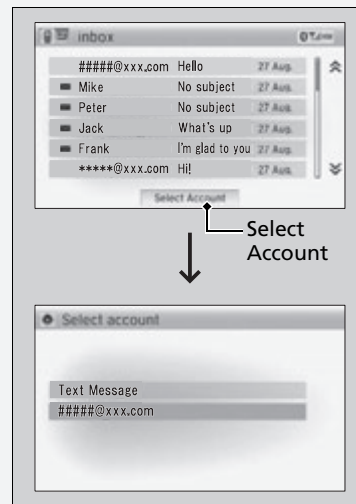

You can only receive notifications from one text message or mail account at a time.

Displaying Messages

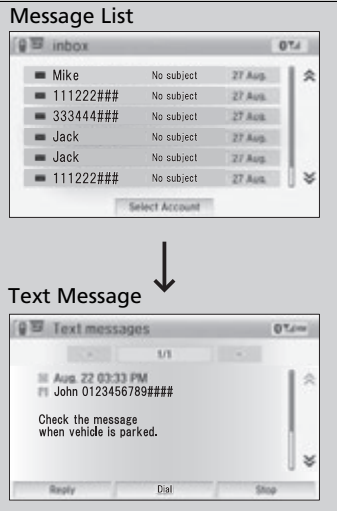

■ Displaying text messages

1. Go to the **Phone menu** screen.
 ▶ **Phone menu screen** P. 323
2. Select **Text/Email**.
 ▶ Select account if necessary.
3. Select a message.
 ▶ The text message is displayed. The system automatically starts reading the message aloud.

☒ Displaying Messages

The  icon appears next to an unread message.

If you delete a message on the phone, the message is also deleted in the system. If you send a message from the system, the message goes to your phone's outbox.

To see the previous or next message, select **Previous** or **Next** on the message screen.

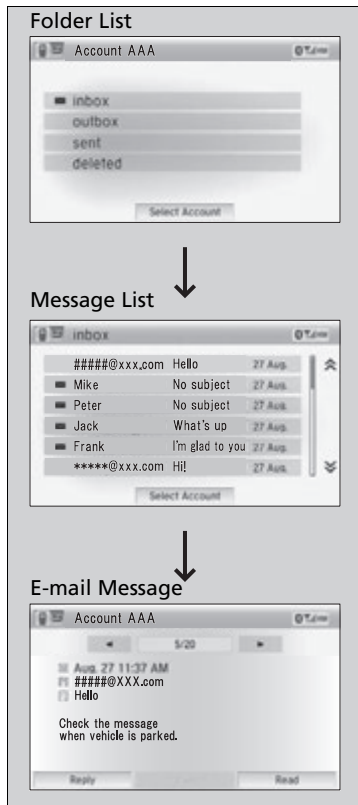

■ Displaying e-mail messages

1. Go to the **Phone menu** screen.
 - ▶ **Phone menu screen** P. 323
2. Select **Text/Email**.
 - ▶ Select **Select Account** if necessary.
3. Select a folder.
 - ▶ Select **Select Account** if necessary.
4. Select a message.
 - ▶ The e-mail message is displayed. The system automatically starts reading the message aloud.

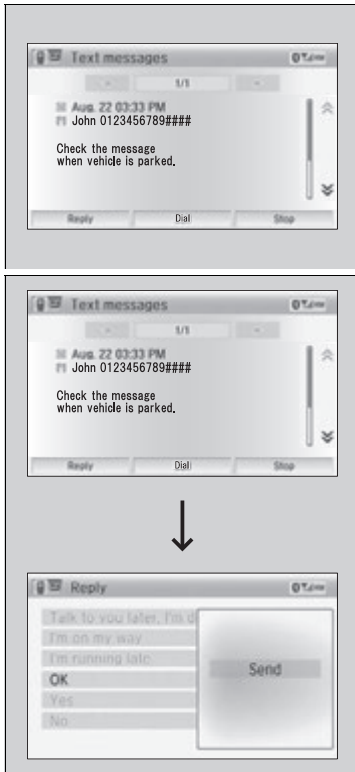

■ Read or Stop reading a message

1. Go to the text or e-mail message screen.
 - ▶ The system automatically starts reading the message aloud.
 - ☒ **Displaying Messages** P. 341
2. Select **Stop** to stop reading. Select **Read** again to start reading the message from the beginning.

■ Reply to a message

1. Go to the text or e-mail message screen.
 - ▶ The system automatically starts reading the message aloud.
 - ☒ **Displaying Messages** P. 341
2. Select **Reply**.
3. Select the reply message.
 - ▶ The pop-up menu appears on the screen.
4. Select **Send** to send the message.
 - ▶ **Complete** appears on the screen when the reply message was successfully sent.

☒ Reply to a message

The available fixed reply messages are as follows:

- **Talk to you later, I'm driving.**
- **I'm on my way.**
- **I'm running late.**
- **OK**
- **Yes**
- **No**

You cannot add, edit, or delete reply messages.

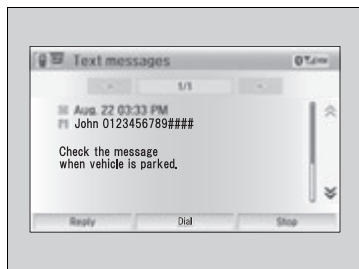

■ **Making a call to a sender**

1. Go to the text message screen.
2. Select **Dial**.

In Case of Emergency

Automatic collision notification

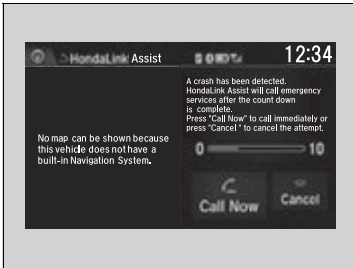

If your vehicle's airbags deploy or if the unit detects that the vehicle is severely impacted, your vehicle automatically will attempt to connect to the HondaLink operator. If connected, information about your vehicle, its location, and its condition will be sent to the operator; you also can speak to the operator when connected.

IMPORTANT: For vehicles equipped with HondaLink Assist, owner activation constitutes authorization for Honda to collect information from your vehicle needed to provide the service, and agreement to the Terms of Use at www.hondalink.com/termsandconditions. In a crash, HondaLink Assist will attempt to notify emergency services but NEITHER HONDA NOR ITS SERVICE PROVIDERS GUARANTEE THAT SUCH NOTIFICATION WILL OCCUR.

Honda reserves the right to terminate HondaLink Assist services at any time or for any reason, and in the future may not be able to provide services due to changes in, or obsolescence of, technology integral to the service or changes in governmental regulation.

In Case of Emergency

Your vehicle may not be able to connect to the operator if the battery level is low, the line is disconnected, or you do not have adequate cellular coverage.

You cannot use this emergency services when:

- You travel outside the HondaLink service coverage areas.
- There is a problem with the connecting devices, such as the microphones, speakers, or the unit itself.

You cannot operate other phone-related functions using the screen while talking to the operator. Select **Hang Up** to terminate the connection to your vehicle.

Automatic collision notification

If the unit fails to connect to the operator, it repeatedly tries until it succeeds.

■ To enable notification

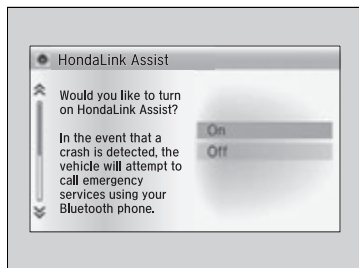

1. Go to the **Phone settings** screen.
 - ▶ **Phone settings screen** P. 320
2. Select **Phone** tab, then **HondaLink Assist**.
 - ▶ A pop-up menu appears on the screen.
3. Select **On** or **Off**.

☒ To enable notification

Setting options:

- **On:** Notification is available.
- **Off:** Disable the feature.





When you turn the ignition switch to ON ^{*1}, the compass self-calibrates, and the compass display appears.

Compass Calibration

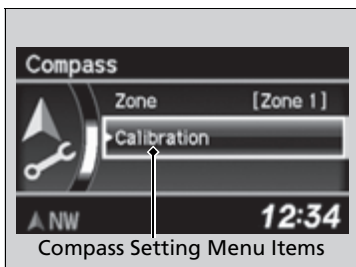
If the compass indicates the wrong direction, or the **CAL** indicator blinks, you need to manually calibrate the system.

Models with one display



1. Turn the ignition switch to ON .
2. Press and hold the **SETUP** button until the display shows the compass setting menu.
3. Rotate  to select **Calibration**, then press .
4. When the display changes to **Calibration Start**, press .
5. Drive the vehicle slowly in two circles.
 - ▶ The compass starts to show a direction after the calibration. The **CAL** indicator goes off.

*1: Models with the smart entry system have an **ENGINE START/STOP** button instead of an ignition switch.

Compass

Compass operation can be affected under the following conditions:

- Driving near power lines or stations
- Crossing a bridge
- Passing a large vehicle, or driving near a large object that can cause a magnetic disturbance
- When accessories such as antennas and roof racks are mounted by magnets

Compass Calibration

Calibrate the compass in an open area.

Models with one display

While setting the compass:

- The  button returns to the previous screen.
- The **SETUP** button cancels the setting mode.

Models with two displays

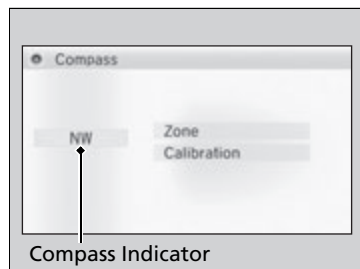

1. Press the  button.
2. Select **Settings**.
3. Select **System**.
4. Select **Compass**.
5. Select **Calibration**.
6. Drive the vehicle slowly in two circles.

▶▶ Compass Calibration

Models with navigation system





Models with navigation self-calibrate using GPS. The compass in the i-MID and the direction arrow on the map screen (when Heading-Up view selected) may not be in sync when first starting the vehicle, but should correct themselves as you drive.

If the compass in the i-MID continues to indicate an incorrect direction, please see your Honda dealer.

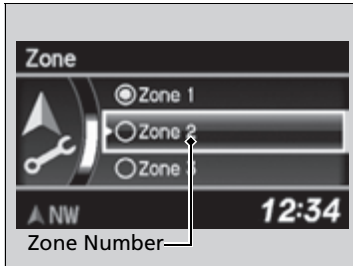
Compass Zone Selection

Models with one display



1. Turn the ignition switch to ON .
2. Press and hold the **SETUP** button until the display shows the compass setting menu.
3. Rotate  to select **Zone**, then press . The display shows the current zone number.
4. Rotate  to select the zone number of your area (See Zone Map), then press .

Models with two displays

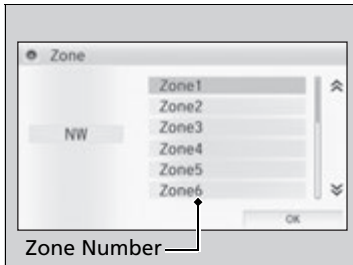

1. Press the  button.
2. Select **Settings**.
3. Select **System**.
4. Select **Compass**.
5. Select **Zone**.
6. Select the zone number of your area (See Zone Map), then select **OK**.

Compass Zone Selection

The zone selection is done to compensate the variation between magnetic north and true north.

If the calibration starts while the audio system is in use, the display returns to normal after the calibration is completed.

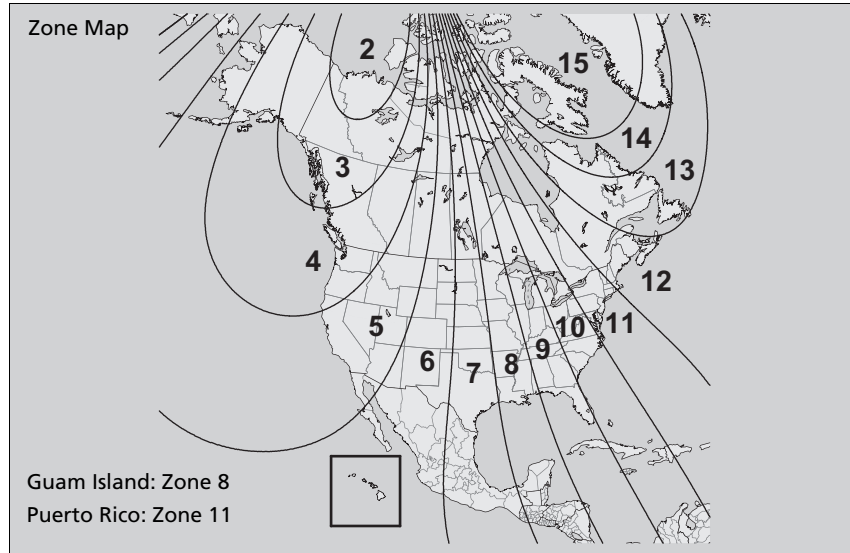

Driving



This chapter discusses driving, refueling, and information on items such as accessories.

| | |
|---------------------------------------|-----|
| Before Driving | 352 |
| Towing a Trailer | |
| Towing Preparation..... | 357 |
| Driving Safely with a Trailer..... | 360 |
| Towing Your Vehicle..... | 361 |
| Off-Highway Driving Guidelines | |
| General Information..... | 362 |
| Important Safety Precautions..... | 362 |
| Avoiding Trouble..... | 363 |
| When Driving | |
| Models without smart entry system | |
| Starting the Engine..... | 364 |
| Models with smart entry system | |
| Starting the Engine..... | 366 |
| Precautions While Driving..... | 370 |

| | |
|---|-----|
| Continuously Variable Transmission... | 371 |
| Shifting..... | 372 |
| ECON Button..... | 374 |
| Cruise Control*..... | 375 |
| Front Sensor Camera*..... | 378 |
| Adaptive Cruise Control (ACC)*..... | 380 |
| Lane Departure Warning (LDW)*..... | 391 |
| Lane Keeping Assist System (LKAS)*.. | 395 |
| Vehicle Stability Assist (VSA®), aka Electronic Stability Control (ESC), System..... | 403 |
| LaneWatch™*..... | 405 |
| Real Time AWD with Intelligent Control System™*..... | 407 |
| Tire Pressure Monitoring System (TPMS)... | 408 |

| | |
|---|-----|
| Tire Pressure Monitoring System (TPMS) - Required Federal Explanation..... | 410 |
| Braking | |
| Brake System..... | 412 |
| Anti-lock Brake System (ABS)..... | 414 |
| Brake Assist System..... | 415 |
| Collision Mitigation Braking System™ (CMBS™)*..... | 416 |
| Parking Your Vehicle | |
| When Stopped..... | 425 |
| Multi-View Rear Camera | 426 |
| Refueling | 429 |
| Fuel Economy | 432 |
| Accessories and Modifications | 433 |

* Not available on all models

Driving Preparation

Check the following items before you start driving.

Exterior Checks

- Make sure there are no obstructions on the windows, door mirrors, exterior lights, or other parts of the vehicle.
 - ▶ Remove any frost, snow, or ice.
 - ▶ Remove any snow on the roof, as this can slip down and obstruct your field of vision while driving. If frozen solid, remove ice once it has softened.
 - ▶ When removing ice from around the wheels, be sure not to damage the wheel or wheel components.
- Make sure the hood is securely closed.
 - ▶ If the hood opens while driving, your front view will be blocked.
- Make sure the tires are in good condition.
 - ▶ Check air pressures, and check for damage and excessive wear.
 - ✦ **Checking and Maintaining Tires** P. 475
- Make sure there are no people or objects behind or around the vehicle.
 - ▶ There are blind spots from the inside.

Exterior Checks

NOTICE

When doors are frozen shut, use warm water around the door edges to melt any ice. Do not try to force them open, as this can damage the rubber trim around the doors. When done, wipe dry to avoid further freezing.
Do not pour warm water into the key cylinder. You will be unable to insert the key if the water freezes in the hole.

Heat from the engine and exhaust can ignite flammable materials left under the hood, causing a fire. If you've parked your vehicle for an extended period, inspect and remove any debris that may have collected, such as dried grass and leaves that have fallen or have been carried in for use as a nest by a small animal. Also check under the hood for leftover flammable materials after you or someone else has performed maintenance on your vehicle.

Interior Checks

- Store or secure all items on board properly.
 - ▶ Carrying too much cargo, or improperly storing it, can affect your vehicle's handling, stability, stopping distance, and tires, and make it unsafe.
 - ✦ **Maximum Load Limit** P. 355
- Do not pile items higher than the seat height.
 - ▶ They can block your view and may be thrown forward in the event of sudden braking.
- Do not place anything in the front seat footwells. Make sure to secure the floor mat.
 - ▶ An object or unsecured floor mat can interfere with your brake and accelerator pedal operation while driving.
- If you have any animals on board, do not let them move around in the vehicle.
 - ▶ They may interfere with driving and a crash could occur.
- Securely close and lock all doors and the tailgate.
 - ✦ **Locking/Unlocking the Doors from the Inside** P. 139
- Adjust your seating position properly.
 - ▶ Adjust the head restraint, too.
 - ✦ **Adjusting the Seats** P. 177
 - ✦ **Adjusting the Head Restraints** P. 180
- Adjust the mirrors and steering wheel properly for your driving.
 - ▶ Adjust them while sitting in the proper driving position.
 - ✦ **Adjusting the Steering Wheel** P. 174
 - ✦ **Adjusting the Mirrors** P. 175

Interior Checks

The headlight aim is set by the factory, and does not need to be adjusted. However, if you regularly carry heavy items in the cargo area or tow a trailer, have the aiming readjusted at a dealer or by a qualified technician.

- Be sure items placed on the floor behind the front seats cannot roll under the seats.
 - ▶ They can interfere with the driver's ability to operate the pedals, the operation of the seats, or the operation of the sensors under the seats.
- Everyone in the vehicle must fasten their seat belt.
 - 📄 **Fastening a Seat Belt** P. 36
- Make sure that the indicators in the instrument panel come on when you start the vehicle, and go off soon after.
 - ▶ Always have a dealer check the vehicle if a problem is indicated.
 - 📄 **Indicators** P. 70

Maximum Load Limit

The maximum load for your vehicle is 850 lbs (385 kg). See the Tire and Loading Information label attached to the driver's doorjamb.

Label Example

| TIRE | SIZE | COLD TIRE PRESSURE | SEE OWNER'S MANUAL FOR ADDITIONAL INFORMATION |
|-------|---------------|--------------------|--|
| FRONT | XXXX/XXXX XXX | XXXKPA, XXPSI | |
| REAR | XXXX/XXXX XXX | XXXKPA, XXPSI | |
| SPARE | XXXX/XXXX XXX | XXXKPA, XXPSI | |

This figure includes the total weight of all occupants, cargo, and accessories, and the tongue load if you are towing a trailer.

Steps for Determining Correct Load Limit -

- (1)** Locate the statement "The combined weight of occupants and cargo should never exceed XXX kg or XXX lbs." on your vehicle's placard.
- (2)** Determine the combined weight of the driver and passengers that will be riding in your vehicle.
- (3)** Subtract the combined weight of the driver and passengers from XXX kg or XXX lbs.
- (4)** The resulting figure equals the available amount of cargo and luggage load capacity. For example, if the "XXX" amount equals 1,400 lbs. and there will be five 150 lb. passengers in your vehicle, the amount of available cargo and luggage load capacity is 650 lbs.
(1,400 - 750 (5 x 150) = 650 lbs.)

Continued

Maximum Load Limit

⚠ WARNING

Overloading or improper loading can affect handling and stability and cause a crash in which you can be hurt or killed.

Follow all load limits and other loading guidelines in this manual.

Gross Vehicle Weight Rating (GVWR):

The maximum allowable weight of the vehicle, all occupants, all accessories, all cargo, and the tongue load.

📖 **Specifications** P. 520

Gross Axle Weight Rating (GAWR):







The maximum allowable weight of the vehicle axle.

📖 **Specifications** P. 520

- (5) Determine the combined weight of luggage and cargo being loaded on the vehicle. That weight may not safely exceed the available cargo and luggage load capacity calculated in step 4.
- (6) If your vehicle will be towing a trailer, load from your trailer will be transferred to your vehicle. Consult this manual to determine how this reduces the available cargo and luggage load capacity of your vehicle.

In addition, the total weight of the vehicle, all occupants, accessories, cargo, and trailer tongue load must not exceed the Gross Vehicle Weight Rating (GVWR) or the Gross Axle Weight Rating (GAWR). Both are on a label on the driver's doorjamb.

Load Limits Example

| | | | | |
|--|--------|--|----------|--|
| <p>Example1</p>  <p>Max Load 850 lbs (385 kg)</p> | \geq |  <p>Passenger Weight 150 lbs x 2 = 300 lbs (68 kg x 2 = 136 kg)</p> | <p>+</p> |  <p>Cargo Weight 550 lbs (249 kg)</p> |
| <p>Example2</p>  <p>Max Load 850 lbs (385 kg)</p> | \geq |  <p>Passenger Weight 150 lbs x 5 = 750 lbs (68 kg x 5 = 340 kg)</p> | <p>+</p> |  <p>Cargo Weight 100 lbs (45 kg)</p> |

Towing Preparation

Towing Load Limits

Your vehicle can tow a trailer if you carefully observe the load limits, use the proper equipment, and follow the towing guidelines. Check the load limits before driving.

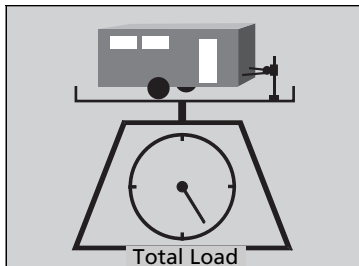

■ Total trailer weight

Maximum allowable weight of the trailer, cargo, and everything in or on it must not exceed 1,500 lbs (680 kg). Towing loads in excess of this can seriously affect vehicle handling and performance and can damage the engine and drivetrain.

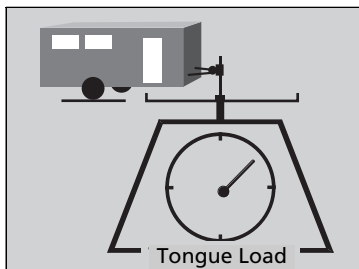

■ Tongue load

The weight of the tongue with a fully loaded trailer on the hitch should be approximately 10% of the total trailer weight.

- Excessive tongue load reduces front tire traction and steering control. Too little tongue load can make the trailer unstable and cause it to sway.
- To achieve a proper tongue load, start by loading 60% of the load toward the front of the trailer and 40% toward the rear. Readjust the load as needed.

⊠ Towing Load Limits

⚠ WARNING

Exceeding any load limit or improperly loading your vehicle and trailer can cause a crash in which you can be seriously hurt or killed.

Check the loading of your vehicle and trailer carefully before starting to drive.

Check if all loads are within limits at a public scale. If a public scale is not available, add the estimated weight of your cargo load to the weight of your trailer (as quoted by the manufacturer), and the tongue load.

Break-in Period

Avoid towing a trailer during your vehicle's first 600 miles (1,000 km).

Never exceed the gross weight ratings. Gross weight information

⊠ **Vehicle Specifications** P. 520

■ Towing Equipment and Accessories

Towing equipment varies by the size of your trailer, how much load you are towing, and where you are towing.

■ Hitches

The hitch must be of an approved type and properly bolted to the underbody.

■ Safety chains

Always use safety chains when you tow a trailer. Leave enough slack to allow the trailer to turn corners easily, but do not allow the chains to drag on the ground.

■ Trailer brakes

Recommended for any trailer with a total weight of 1,000 lbs (450 kg) or more: There are two common types of trailer brakes: surge and electric. Surge brakes are common for boat trailers, since the brakes will get wet. If you choose electric brakes, be sure they are electronically actuated. Do not attempt to attach trailer brakes to your vehicle's hydraulic system, as it will lower braking effectiveness and create a potential hazard.

■ Additional towing equipment

Many states and provinces/territories require special outside mirrors when towing a trailer. Even if mirrors are not required in your locale, you should install special mirrors if visibility is restricted in any way.

► Towing Equipment and Accessories

Make sure that all equipment is properly installed and maintained, and that it meets federal, state, province/territory, and local regulations.

Consult your trailer sales or rental agency if any other items are recommended or required for your towing situation.

The lighting and wiring of trailers can vary by type and brand. If a connector is required, it should only be installed by a qualified technician.

■ Trailer light

Trailer lights and equipment must comply with federal, state, province/territory, and local regulations. Check with your local trailer sales or rental agency for the requirements in the area where you plan to tow.

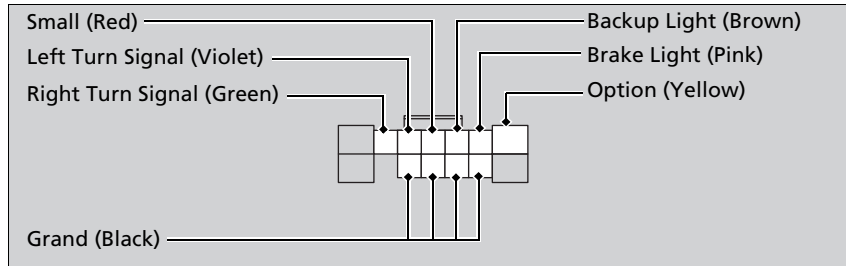

Your trailer lighting connector is located behind the left side panel in the cargo area. Each pin's purpose and wiring color code are shown in the image.

When using a non-Honda trailer lighting harness and converter, get the connector and pins for your vehicle from a dealer.

Driving Safely with a Trailer

■ Things You Need To Know Before Towing a Trailer

- Have the trailer properly serviced and keep it in good condition.
- Make sure that all the weights and load in the vehicle and trailer are within limits.
 - ✦ **Towing Load Limits** P. 357
- Securely attach the hitch, safety chains, and other necessary parts to the trailer.
- Securely store all the items in and on the trailer so that they do not shift while driving.
- Check if the lights and brakes on the trailer are working properly.
- Check the pressures of the trailer tires, including the spare.

■ Towing Speeds and Gears

- Drive slower than normal.
- Obey posted speed limits for vehicles with trailers.
- Use the  position when towing a trailer on level roads.

■ Turning and Braking

- Turn more slowly and with a wider turning arc than normal.
- Allow more time and distance for braking.
- Do not brake or turn suddenly.

■ Driving in Hilly Terrain

- Monitor your temperature gauge. If it nears the red (Hot) mark, turn off the heating and cooling system*/climate control system* and reduce speed. Pull to the side of the road safely to cool down the engine if necessary.

▶▶ Driving Safely with a Trailer

Operating speed when towing a trailer is restricted up to 65 mph (100 km/h).

Parking

In addition to the normal precautions, place wheel chocks at each of the trailer's tires.

Towing Your Vehicle

Your vehicle is not designed to be towed behind a motor home. If your vehicle needs to be towed in an emergency, refer to the emergency towing information.

📄 **Emergency Towing** P. 516

General Information

Your vehicle has been designed primarily for use on pavement, however, its higher ground clearance allows you to occasionally travel on unpaved roads. It is not designed for trail-blazing, or other challenging off-road activities.

If you decide to drive on unpaved roads, you will find that it requires somewhat different driving skills and that your vehicle will handle somewhat differently than it does on pavement. Pay attention to the precautions and tips in this section, and get acquainted with your vehicle before leaving the pavement.

Important Safety Precautions

To avoid loss of control or rollover, be sure to follow all precautions and recommendations:

- Be sure to store cargo properly and do not exceed your cargo load limits.
 - **Maximum Load Limit** P. 355
- Whenever you drive, make sure you and your passengers always wear seat belts.
- Keep your speed low, and never go faster than the conditions allow.
- It's up to you to continually assess the situation and drive within the limits.

Off-Highway Driving Guidelines

WARNING

Improperly operating this vehicle on or off pavement can cause a crash or rollover in which you and your passengers can be seriously injured or killed.

- Follow all instructions and guidelines in this owner's manual.
- Keep your speed low, and don't drive faster than conditions permit.

Failure to operate your vehicle correctly might result in a crash or a rollover.

- **Important Handling Information** P. 30
- **Precautions While Driving** P. 370

Avoiding Trouble

- **Check Out Your Vehicle** before you leave the pavement and make sure that all scheduled maintenance has been completed. Pay special attention to the condition of the tires, and check the tire pressures.
- **Remember** the route you choose presents limits (too steep or bumpy), you have limits (driving skill and comfort), and your vehicle has limits (traction, stability, and power). Failing to recognize these limits will likely put you and your passengers in a hazardous situation.
- **Accelerating and Braking** should be done slowly and gradually. Trying to start or stop too fast can cause a loss of traction and you could lose control.
- **Avoiding Obstacles and Debris** in the road reduces the likelihood of a rollover or damage to your suspension or other components.
- **Driving on Slopes** increases your risk of a rollover, particularly if you attempt to drive across a slope that is too steep. Going straight or down a slope is usually the safest. If you can't clearly see all conditions or obstacles on a slope, walk it before you drive it. If there is any doubt whether you can safely pass, don't try it. Find another route. If you get stuck when climbing, do not try to turn around. Back down slowly following the same route you took up the hill.
- **Crossing a Stream** - Avoid driving through deep water. If you encounter water in your route (a small stream or large puddle, for example), evaluate it carefully before going ahead. Make sure it is shallow, flowing slowly, and has firm ground underneath. If you are not sure of the depth or the ground, turn around and find another route. Driving through deep water can also damage your vehicle. The water can get into the transmission and differential, diluting the lubricant and causing an eventual failure. It can also wash the grease out of the wheel bearings.
- **If You Get Stuck**, carefully go in the direction that you think will get you unstuck. Do not spin the tires as this will only make things worse and could damage the transmission. If you are unable to free yourself, your vehicle will need to be towed. Front and rear tow hooks are provided for this purpose.

Models without smart entry system

Starting the Engine

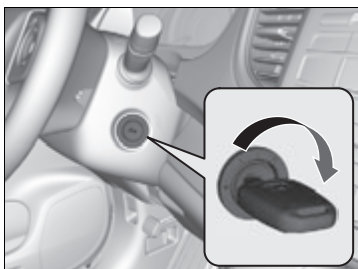
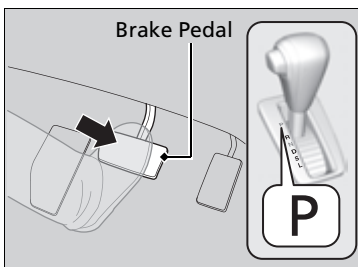
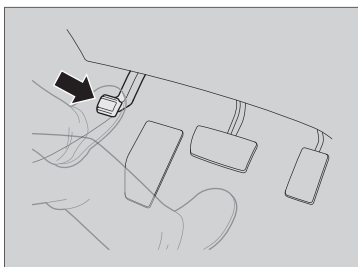

1. Make sure the parking brake is applied.

2. Check that the shift lever is in **P**, then depress the brake pedal.

▶ Although it is possible to start the vehicle in **N**, it is safer to start it in **P**.

3. Turn the ignition switch to START **III** without depressing the accelerator pedal.

Starting the Engine

Keep your foot firmly on the brake pedal when starting the engine.

The engine is harder to start in cold weather and in thinner air found at altitudes above 8,000 feet (2,400 meters).

When starting the engine in cold weather, turn off all electrical accessories such as the lights, heating and cooling system* / climate control system*, and rear defogger in order to reduce battery drain.

If you live in a region where winter is extremely cold, an engine block heater will improve starting and warming of the engine. If temperatures consistently below -22°F (-30°C) are expected, the coolant mixture should be changed to a higher concentration to prevent freezing. Consult a dealer for details.

If the exhaust system sounds abnormal or you can smell exhaust gas inside the vehicle, have your vehicle checked by a dealer. There may be a problem with the engine or exhaust system.

Starting to Drive

1. Keeping your right foot on the brake pedal, release the parking brake. Check that the parking brake indicator has gone off.

➤ **Parking Brake** P. 412

2. Put the shift lever in **[D]**. Select **[R]** when reversing.

3. Gradually release the brake pedal and gently depress the accelerator pedal to pull away.

Hill start assist system

Hill start assist keeps the brake engaged briefly to help prevent the vehicle from rolling on inclines as you move your foot from the brake pedal to the accelerator.

Move the shift lever to **[D]** or **[S]** when facing uphill, or **[R]** when facing downhill, then release the brake pedal.

Starting the Engine

Do not hold the key in START **[III]** for more than 10 seconds.

- If the engine does not start right away, wait for at least 30 seconds before trying again.
- If the engine starts, but then immediately stops, wait at least 30 seconds before repeating step 3 while gently depressing the accelerator pedal. Release the accelerator pedal once the engine starts.

The immobilizer system protects your vehicle from theft. If an improperly coded key (or other device) is used, the engine's fuel system is disabled.

➤ **Immobilizer System** P. 149

Hill start assist system

Hill start assist may not prevent the vehicle from rolling downhill on a very steep or slippery slope, and does not operate on small inclines.

Hill start assist is not a replacement for the parking brake.

Hill start assist will operate even when VSA® is switched off.

Models with smart entry system

Starting the Engine

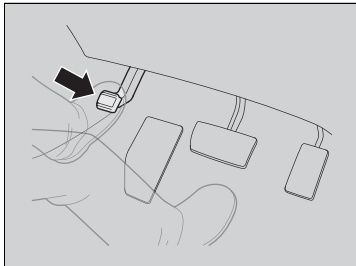

1. Make sure the parking brake is applied.

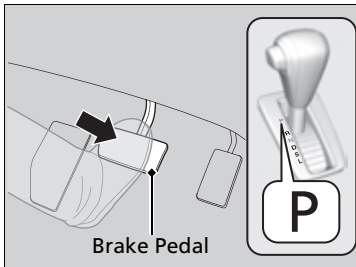

2. Check that the shift lever is in **P**, then depress the brake pedal.

▶ Although it is possible to start the vehicle in **N**, it is safer to start it in **P**.

Starting the Engine

Keep your foot firmly on the brake pedal when starting the engine.

The engine is harder to start in cold weather and in thinner air found at altitudes above 8,000 feet (2,400 meters).

When starting the engine in cold weather, turn off all electrical accessories such as the lights, climate control system, and rear defogger in order to reduce battery drain.

If you live in a region where winter is extremely cold, an engine block heater will improve starting and warming of the engine. If temperatures consistently below -22°F (-30°C) are expected, the coolant mixture should be changed to a higher concentration to prevent freezing. Consult a dealer for details.

If the exhaust system sounds abnormal or you can smell exhaust gas inside the vehicle, have your vehicle checked by a dealer. There may be a problem with the engine or exhaust system.

The immobilizer system protects your vehicle from theft.

If an improperly coded device is used, the engine's fuel system is disabled.

➤ **Immobilizer System** P. 149

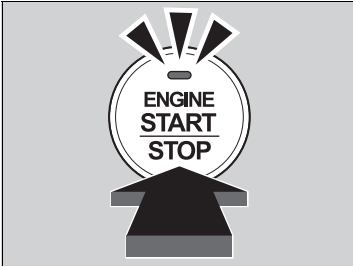

3. Press the **ENGINE START/STOP** button without depressing the accelerator pedal.

▶▶ Starting the Engine

Bring the smart entry remote close to the **ENGINE START/STOP** button if the battery in the smart entry remote is weak.

▶ **If the Smart Entry Remote Battery is Weak**
P. 502

The engine may not start if the smart entry remote is subjected to strong radio waves.

Do not hold the **ENGINE START/STOP** button to start the engine.

If the engine does not start, wait at least 30 seconds before trying again.

■ Stopping the Engine

You can turn the engine off when the vehicle is completely stopped.

1. Shift to **P**.
2. Press the **ENGINE START/STOP** button.

■ Starting to Drive

1. Keeping your right foot on the brake pedal, release the parking brake. Check that the parking brake indicator has gone off.
🔧 **Parking Brake** P. 412
2. Put the shift lever in **D**. Select **R** when reversing.
3. Gradually release the brake pedal and gently depress the accelerator pedal to pull away.

■ Hill start assist system

Hill start assist keeps the brake engaged briefly to help prevent the vehicle from rolling on inclines as you move your foot from the brake pedal to the accelerator.

Move the shift lever to **D**, **S**, or **L** when facing uphill, or **R** when facing downhill, then release the brake pedal.

ⓘ Hill start assist system

Hill start assist may not prevent the vehicle from rolling downhill on a very steep or slippery slope, and does not operate on small inclines.

Hill start assist is not a replacement for the parking brake.

Precautions While Driving

■ Driving Guidelines for Your Utility Vehicle

Utility vehicles have a significantly higher rollover rate than other types of vehicles. To prevent rollovers or loss of control:

- Take corners at slower speeds than you would with a passenger vehicle.
- Avoid sharp turns and abrupt maneuvers whenever possible.
- Do not modify your vehicle in any way that you would raise the center of gravity.
- Never carry more than 165 lbs (75 kg) of cargo on the roof rack (Honda accessory).

■ In Rain

Avoid driving in deep water and on flooded roads. This can damage the engine, driveline, or cause electrical component failure.

■ Other Precautions

If there is a strong impact with something under the vehicle, stop in a safe location. Check the underside of the vehicle for damage or any fluid leaks.

⚠ Precautions While Driving

NOTICE

Do not operate the shift lever while pressing the accelerator pedal. You could damage the transmission.

NOTICE

If you repeatedly turn the steering wheel at an extremely low speed, or hold the steering wheel on the full left or right position for a while, the system heats up. The system goes into a protective mode, and limits its performance. The steering wheel becomes harder and harder to operate. Once the system cools down, the EPS system is restored. Repeated operation under these conditions can eventually damage the system.

Continuously Variable Transmission

■ Creeping

The engine runs at a higher idle speed and creeping increases. Keep the brake pedal firmly depressed when stopped.

■ Kickdown

Quickly depressing the accelerator pedal while driving uphill may cause the transmission to drop to a lower gear, unexpectedly increasing vehicle speed. Depress the accelerator pedal carefully, especially on slippery roads and curves.

⌘ Precautions While Driving

If the ignition switch is turned to ACCESSORY [I] or LOCK [O]*1 while driving, the engine will shut down and all steering and brake power assist functions will stop, making it difficult to control the vehicle.

Do not put the shift lever in [N], as you will lose engine braking (and acceleration) performance.

During the first 600 miles (1,000 km) of operation, avoid sudden acceleration or full throttle operation so as to not damage the engine or powertrain.

Avoid hard braking for the first 200 miles (300 km). You should also follow this when the brake pads are replaced.

*1: Models with the smart entry system have an **ENGINE START/STOP** button instead of an ignition switch.

⌘ Driving Guidelines for Your Utility Vehicle

Failure to operate your vehicle correctly might result in a crash or a rollover.

➤ **Important Handling Information** P. 30

➤ **Precautions While Driving** P. 370

Shifting

Change the shift position in accordance with your driving needs.

■ Shift lever positions

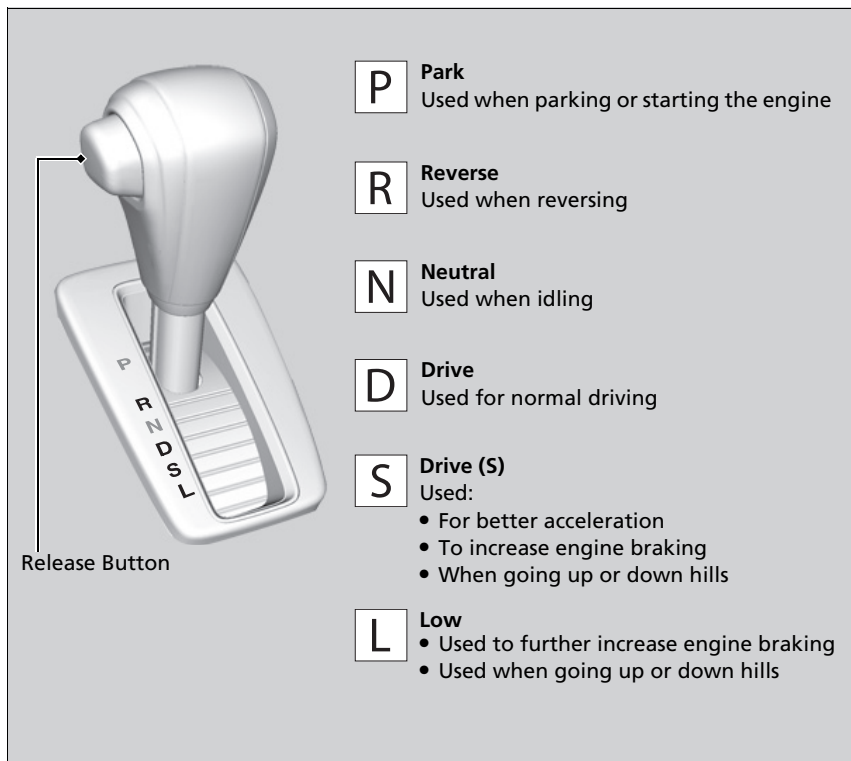

▶ Shifting

You cannot turn the ignition switch to LOCK **[0]***1 and remove the key unless the shift lever is in **[P]**.

The vehicle may move forward very slightly even in **[N]** while the engine is cold. Depress the brake pedal firmly and, when necessary, apply the parking brake.

*1: Models with the smart entry system have an **ENGINE START/STOP** button instead of an ignition switch.

Shift Lever Operation

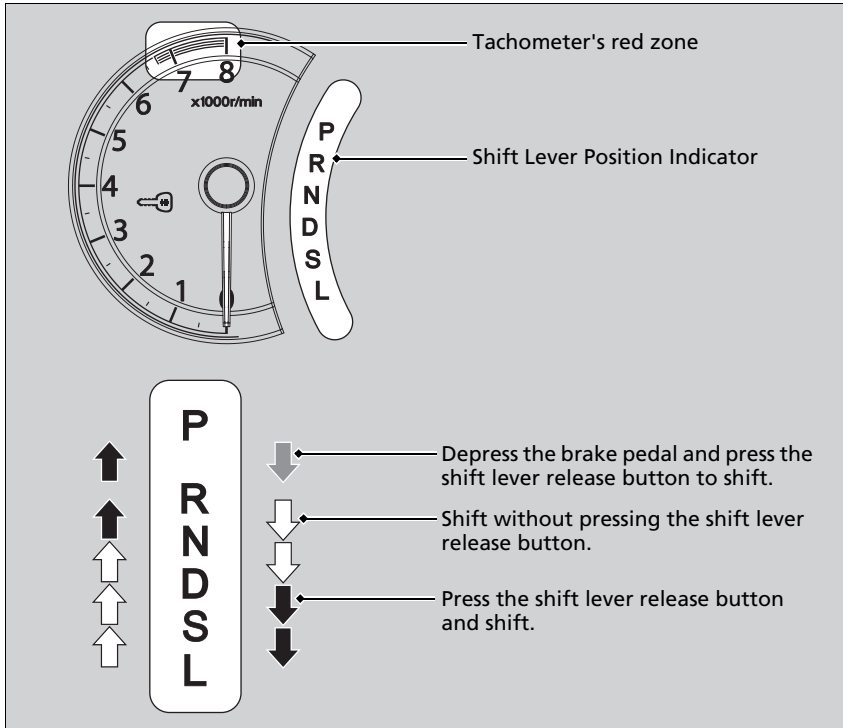

Shift Lever Operation

NOTICE

When you change the shift lever from **[D]** to **[R]** and vice versa, come to a complete stop and keep the brake pedal depressed.

Operating the shift lever before the vehicle has come to a complete standstill can damage the transmission.

Use the shift lever position indicator to check the lever position before pulling away.

If the transmission indicator **[D]** blinks when driving, in any shift position, there is a problem with the transmission.

Avoid sudden acceleration and have the transmission checked by a dealer as soon as possible.

The fuel supply may be cut off if you drive at engine speeds in or over the tachometer's red zone (engine speed limit). If this happens, you may experience a slight jolt.

It may not be possible to operate the shift lever if the brake pedal is applied while the shift lever release button is held down.

Depress the brake pedal first.

ECON Button

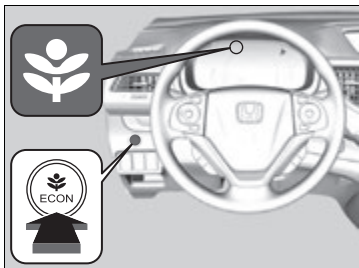

The **ECON** button turns the ECON mode on and off.

The ECON mode helps you improve your fuel economy by adjusting the performance of the engine, transmission, air conditioning system, and cruise control.

Cruise Control *

Maintains a constant vehicle speed without having to keep your foot on the accelerator pedal. Use cruise control on freeways or open roads where you can travel at a constant speed with little acceleration or deceleration.

⊠ Cruise Control *

⚠ WARNING

Improper use of the cruise control can lead to a crash.

Use the cruise control only when traveling on open highways in good weather.

It may not be possible to maintain a constant speed when driving uphill or downhill.

When not using cruise control: Turn off cruise control by pressing the **CRUISE*/MAIN*** button.

While in the ECON mode, it may take relatively more time to accelerate to maintain the set speed.

When to use

- Vehicle speed for cruise control: Desired speed in a range above roughly 25 mph (40 km/h) ~
- Shift positions for cruise control: In **D** or **S**

Always keep sufficient distance between you and the vehicle in front of you.



How to use

- Press the **CRUISE*/MAIN*** button on the steering wheel.

CRUISE MAIN is on in the instrument panel. Cruise control is ready to use.

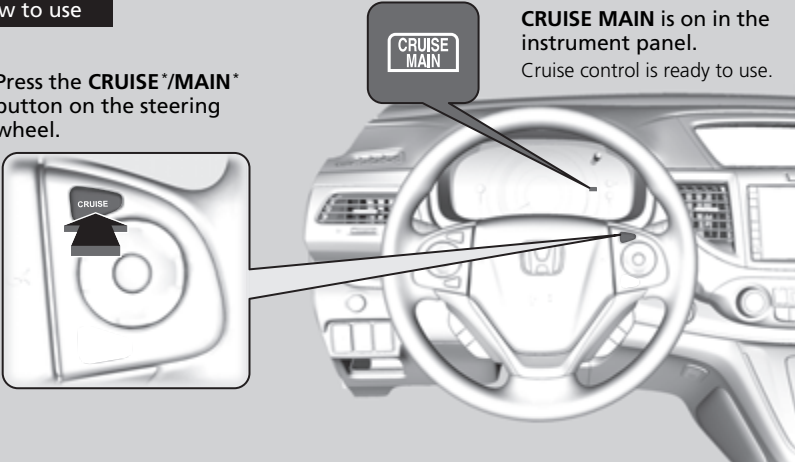

* Not available on all models

Continued

■ To Set the Vehicle Speed

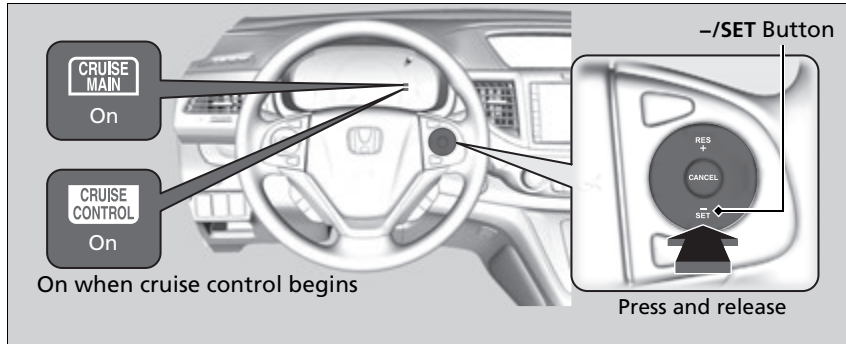

Take your foot off the pedal and press the **-/SET** button when you reach the desired speed.

The moment you release the **-/SET** button, the set speed is fixed, and cruise control begins. The **CRUISE CONTROL** indicator comes on.

■ To Adjust the Vehicle Speed

Increase or decrease the vehicle speed using the **RES/+** or **-/SET** buttons on the steering wheel.

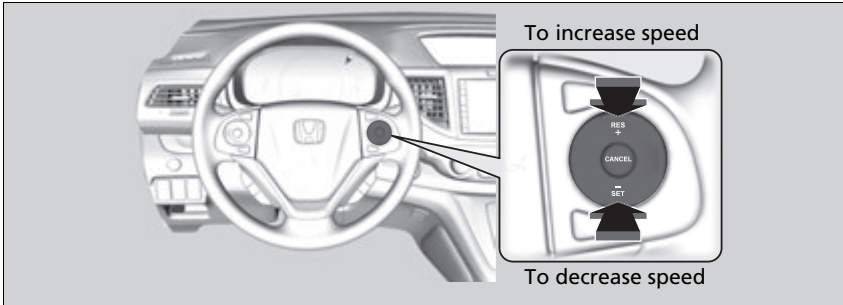

- Each time you press the button, the vehicle speed is increased or decreased by about 1 mph (1.6 km/h).
- If you keep the button pressed, the vehicle speed increases or decreases until you release it. This speed is then set.

■ To Cancel

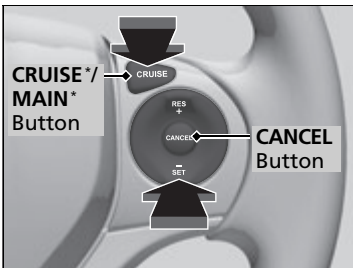

To cancel cruise control, do any of the following:

- Press the **CANCEL** button.
- Press the **CRUISE*/MAIN*** button.
- Depress the brake pedal.

The **CRUISE CONTROL** indicator goes off.

* Not available on all models

☒ To Adjust the Vehicle Speed

You can set the vehicle speed using the **-/SET** button on the steering wheel when adjusting the speed with the accelerator and brake pedals.

☒ To Cancel

Resuming the prior set speed:

After cruise control has been canceled, you can still resume the prior set speed by pressing the **RES/+** button while driving at a speed of at least 25 mph (40 km/h) or more.

You cannot set or resume in the following situations:

- When vehicle speed is less than 25 mph (40 km/h)
- When the **CRUISE*/MAIN*** button is turned off

At vehicle speeds of 22 mph (35 km/h) or less, cruise control is canceled automatically.

Front Sensor Camera*

The camera, used in systems; such as LDW, LKAS, ACC and CMBS™, is designed to detect an object that triggers any of the systems to operate their functions.

■ Camera Location and Handling Tips

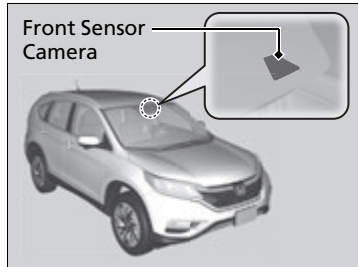

This camera is located behind the rearview mirror.

To help reduce the likelihood that high interior temperatures will cause the camera's sensing system to shut off, when parking, find a shady area or face the front of the vehicle away from the sun. If you use a reflective sun shade, do not allow it to cover the camera housing. Covering the camera can concentrate heat on it.

▣ Front Sensor Camera*

Never apply a film or attach any objects to windshield, the hood, or the front grill that could obstruct the camera's field of vision and cause the system to operate abnormally. Scratches, nicks, and other damage to the windshield within the camera's field of vision can cause the system to operate abnormally. If this occurs, we recommend that you replace the windshield with a genuine Honda replacement windshield. Making even minor repairs within the camera's field of vision or installing an aftermarket replacement windshield may also cause the system to operate abnormally. After replacing the windshield, have a dealer recalibrate the camera. Proper calibration of the camera is necessary for the system to operate properly.

Do not place an object on the top of the instrument panel. It may reflect onto the windshield and prevent the system from detecting lane lines properly.

⌘ Front Sensor Camera*

If the **SOME DRIVER ASSIST SYSTEMS CANNOT**

OPERATE:  message appears:

- Use the climate control system to cool down the interior and, if necessary, also use defroster mode with the air flow directed toward the camera.
- Start driving the vehicle to lower the windshield temperature, which cools down the area around the camera.

If the **SOME DRIVER ASSIST SYSTEMS CANNOT**

OPERATE:  message appears:

- Park your vehicle in a safe place, and clean the windshield. If the message does not disappear after you have cleaned the windshield and driven for a while, have your vehicle checked by a dealer.

Adaptive Cruise Control (ACC)*

Helps maintain a constant vehicle speed and a set following distance behind a vehicle detected ahead of yours, without you having to keep your foot on the brake or the accelerator.

When ACC slows your vehicle by applying the brakes, your vehicle's brake lights will illuminate.

When to use

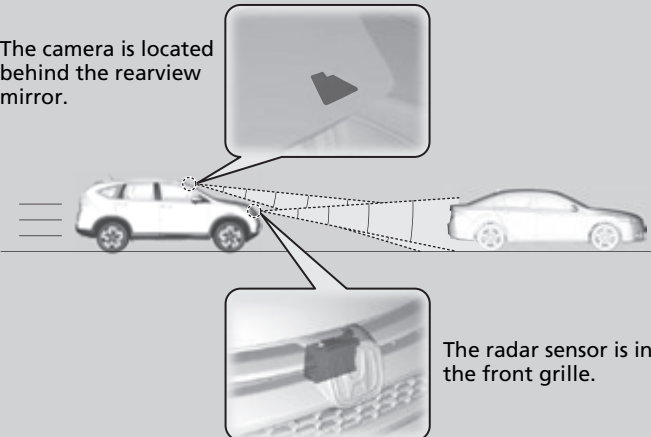

The camera is located behind the rearview mirror.

The radar sensor is inside the front grille.

- Vehicle speed for adaptive cruise control: Desired speed in a range above roughly 25 mph (40 km/h) ~
- Shift positions for adaptive cruise control: In **D** or **S**

Adaptive Cruise Control (ACC)*

⚠ WARNING

Improper use of ACC can lead to a crash.

Use ACC only when traveling on open highways in good weather.

⚠ WARNING

ACC has limited braking capability.

When your vehicle speed drops below 22 mph, ACC will automatically cancel and no longer will apply your vehicle's brakes.

Always be prepared to apply the brake pedal when conditions require.

Important Reminder

As with any system, there are limits to ACC. Use the brake pedal whenever necessary, and always keep a safe distance between your vehicle and other vehicles.

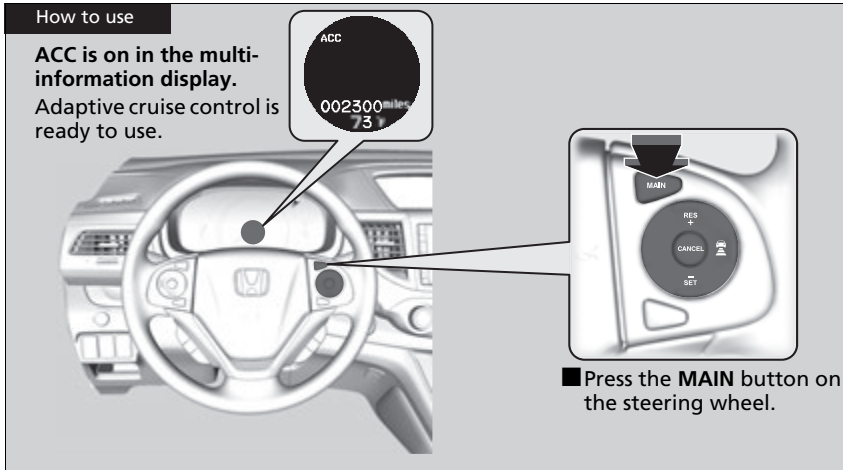

⊠ Adaptive Cruise Control (ACC)*

ACC may not work properly under certain conditions.

➤ **ACC Conditions and Limitations** P. 385

When not using adaptive cruise control: Turn off adaptive cruise by pressing the **MAIN** button. This also will turn off the Lane Keeping Assist System (LKAS).

Do not use the ACC under the following conditions.

- On roads with heavy traffic or while driving in continuous stop and go traffic.
- On roads with sharp turns.
- On roads with steep downhill sections, as the set vehicle speed can be exceeded by coasting. In such cases, the ACC will not apply the brakes to maintain the set speed.
- On roads with toll collection facilities or other objects between lanes of traffic, or in parking areas, or facilities with drive through access.

* Not available on all models

■ To Set the Vehicle Speed

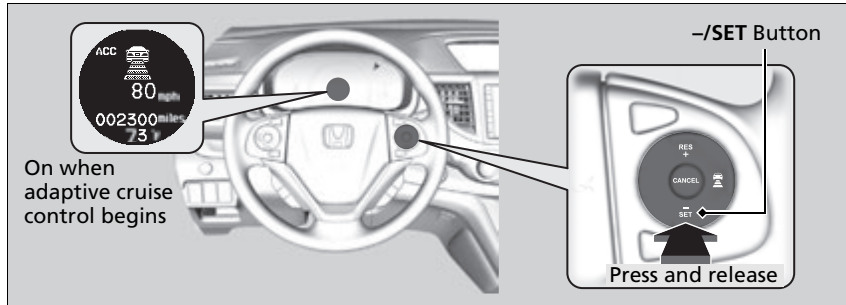

Take your foot off the pedal and press the **-/SET** button when you reach the desired speed.

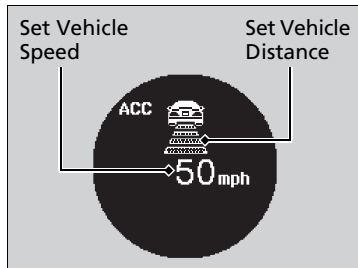

The moment you release the **-/SET** button, the set speed is fixed, and adaptive cruise control begins.

- ▶ A vehicle icon and distance bars appear on the multi-information display.

▶▶ To Set the Vehicle Speed

You can switch the displayed set speed measurements on the multi-information display between mph and km/h.

- ▶ **Customized Features** P. 102, 116

■ When in Operation

■ There is a vehicle ahead

ACC monitors if a vehicle ahead of you enters the ACC range. If a vehicle is detected doing so, the ACC system maintains or decelerates your vehicle's set speed in order to keep the vehicle's set following-distance from the vehicle ahead.

🔧 **To Change Vehicle Distance** P. 387

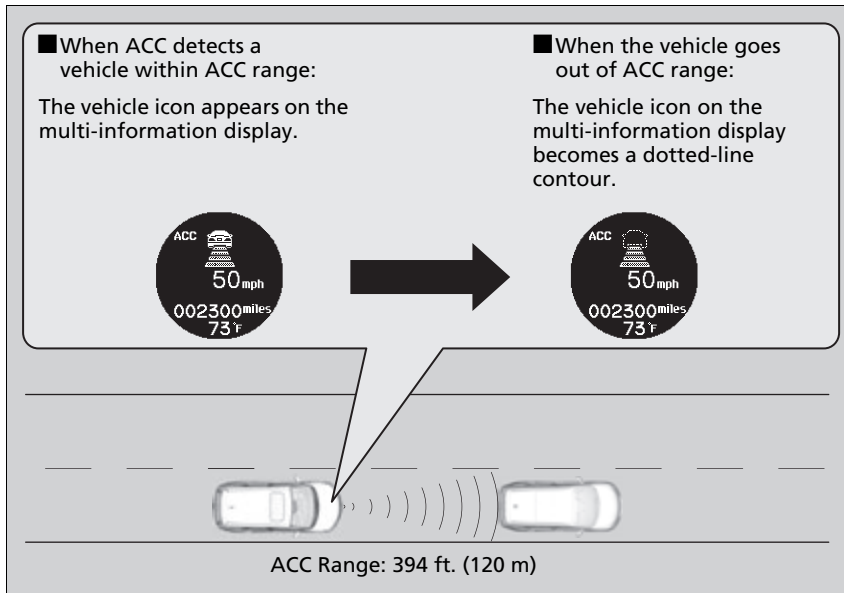

🔧 When in Operation

If the vehicle detected ahead of you slows down abruptly, or if another vehicle is detected cutting in front of you, the beeper sounds and a message appears on the multi-information display to alert you to brake.

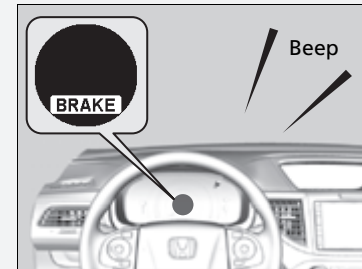

Depress the brake pedal, and keep an appropriate distance from the vehicle ahead.

Even if the distance between your vehicle and the vehicle detected ahead is short, ACC may start accelerating your vehicle under the following circumstances:

- The vehicle detected ahead of you is going at almost the same speed as, or faster than your vehicle.
- A vehicle that cuts in front of you is going faster than your vehicle, gradually distancing itself from you.

■ **There is no vehicle ahead**

Your vehicle cruises at the set speed.

■ **A vehicle ahead is within ACC range and going slower than the set speed**

Your vehicle slows down, and maintains the same speed as the speed of the vehicle ahead to maintain the set following distance.

■ **A vehicle ahead is within ACC range and going at a steady speed**

Your vehicle follows the vehicle ahead of it, keeping a constant distance, without going beyond the set speed.

■ **A vehicle ahead goes out of range**

ACC accelerates your vehicle to the set speed, and then maintains it.

■ **When you depress the accelerator pedal**

You can temporarily increase the vehicle speed. In this case, there is no audible or visual alerts even if a vehicle is in ACC range.

ACC stays on unless you cancel it. Once you release the accelerator pedal, the system resumes the set speed.

There are times when the vehicle speed will decrease when the accelerator pedal is lightly applied.

⌘ When in Operation

You can also set the system to beep when a vehicle detected in front of you comes in and goes out of the ACC detecting range. Change the ACC FORWARD VEHICLE DETECT BEEP* setting.

➤ **Customized Features** P. 102, 116

Limitations

You may need to use the brake to maintain a safe distance when using ACC. Additionally, ACC may not work properly under certain conditions.

➤ **ACC Conditions and Limitations** P. 385

ACC Conditions and Limitations

The system may automatically shut off and the **ACC** indicator will come on under certain conditions. Some examples of these conditions are listed below. Other conditions may reduce some of the ACC functions.

➤ **Front Sensor Camera*** P. 378

■ Environmental conditions

Driving in bad weather (rain, fog, snow, etc.).

■ Roadway conditions

Driving on a snowy or wet roadway (obscured lane marking, vehicle tracks, reflected lights, road spray, high contrast).

■ Vehicle conditions

- The outside of the windshield is blocked by dirt, mud, leaves, wet snow, etc.
- An abnormal tire or wheel condition (wrong sized, varied size or construction, improperly inflated, compact spare tire, etc.).
- The camera temperature gets too hot.
- The parking brake is applied.
- When the front grille is dirty.
- When the front of the vehicle tilts up due to heavy cargo in the cargo area or rear seats.
- When tire chains are installed.

* Not available on all models

Continued

ACC Conditions and Limitations

The radar sensor for ACC is shared with the Collision Mitigation Braking System™ (CMBS™).

➤ **Collision Mitigation Braking System™ (CMBS™)*** P. 416

You can read about handling information for the camera equipped with this system.

➤ **Front Sensor Camera*** P. 378

■ **Detection limitations**

- A vehicle or pedestrian suddenly crosses in front of you.
- The distance between your vehicle and the vehicle or pedestrian ahead of you is too short.
- A vehicle cuts in front of you at a slow speed, and it brakes suddenly.
- When you accelerate rapidly and approach the vehicle or pedestrian ahead of you at high speed.
- The vehicle ahead of you is a motorcycle, bicycle, mobility scooter, or other small vehicle.
- When there are animals in front of your vehicle.
- When you drive on a curved or winding or undulating road that makes it difficult for the sensor to properly detect a vehicle or a pedestrian in front of you.
- The speed difference between your vehicle and a vehicle in front of you is significantly large.
- An oncoming vehicle suddenly comes in front of you.
- Your vehicle abruptly crosses over in front of an oncoming vehicle.
- When driving through a narrow iron bridge.
- When the vehicle ahead of you brakes suddenly.
- When the vehicle ahead of you has a unique shape.
- When your vehicle or the vehicle ahead of you is driving on one edge of the lane.

■ To Adjust the Vehicle Speed

Increase or decrease the vehicle speed using the **RES/+** or **-/SET** buttons on the steering wheel.

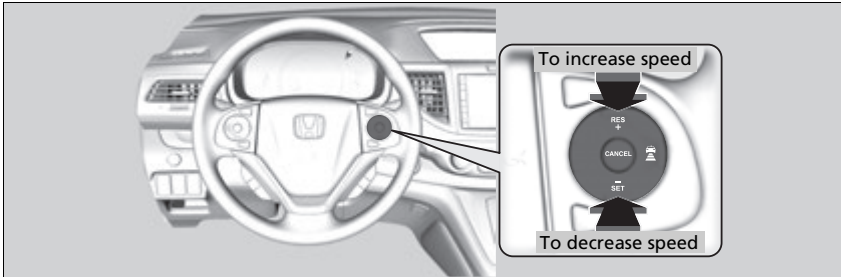

- Each time you press the button, the vehicle speed is increased or decreased by about 1 mph or 1 km/h accordingly.
- If you keep the button pressed, the vehicle speed increases or decreases by about 5 mph or 5 km/h accordingly.

■ To Change Vehicle Distance

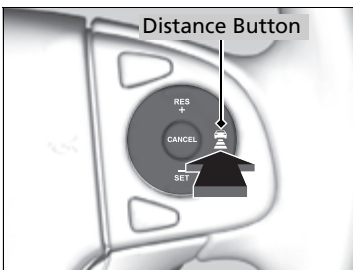

Press the  (distance) button to change ACC range.

Each time you press the button, the following distance (the distance behind a vehicle detected ahead of you) setting cycles through extra long, long, middle, and short following distances.

☒ To Adjust the Vehicle Speed

If a vehicle detected ahead is going at a speed slower than your increased set speed, ACC may not accelerate your vehicle. This is to maintain the set following distance between your vehicle and the vehicle ahead.

You can set the vehicle speed using the **-/SET** button on the steering wheel when adjusting the speed with the accelerator and brake pedals.

Determine the most appropriate following distance setting based on your specific driving conditions. Be sure to adhere to any following distance requirements set by local regulation.

The higher your vehicle's following-speed is, the greater the short, middle, long or extra long following distance becomes. See the following examples for your reference.

| Following-distance | | When the Set Speed is: | |
|--------------------|--|----------------------------------|----------------------------------|
| | | 50 mph (80 km/h) | 65 mph (104 km/h) |
| Short | | 84 feet 26 meters 1.1 sec | 102 feet 31 meters 1.1 sec |
| Middle | | 111 feet 34 meters 1.5 sec | 139 feet 43 meters 1.5 sec |
| Long | | 155 feet 48 meters 2.1 sec | 202 feet 62 meters 2.1 sec |
| Extra Long | | 215 feet 66 meters 3.0 sec | 285 feet 87 meters 3.0 sec |

To Cancel

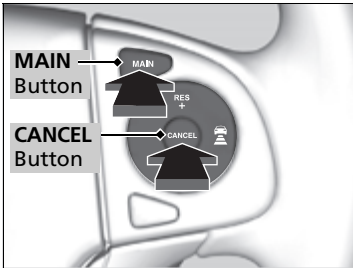

To cancel adaptive cruise control, do any of the following:

- Press the **CANCEL** button.
- Press the **MAIN** button.
- Depress the brake pedal.

Automatic cancellation

The beeper sounds and a message appears on the multi-information display when ACC is automatically canceled. Any of these conditions may cause the ACC cancellation:

- Your vehicle speed slows down to 22 mph (35 km/h) and below.
- Bad weather (rain, fog, snow, etc.).
- When the radar sensor inside the front grille gets dirty.
- The vehicle ahead of you cannot be detected.
- An abnormal tire condition is detected, or the tires are skidding.
- Driving on a mountainous road, or driving off road for extended periods.
- Abrupt steering wheel movement.
- When the ABS or VSA® is activated.
- When the ABS or VSA® system indicator comes on.
- When you manually apply the parking brake.
- When the detected vehicle within the ACC range is too close to your vehicle.
- The camera behind the rearview mirror, or the area around the camera, including the windshield, gets dirty.

To Cancel

Resuming the prior set speed: After you have canceled adaptive cruise control, you can resume the prior set speed while it is still displayed. Press the **RES/+** button when driving at a speed of at least 25 mph (40 km/h) or more.

You cannot set or resume when vehicle speed is less than 25 mph (40 km/h).

The set speed cannot be set or resumed when ACC has been turned off using the **MAIN** button. Press the **MAIN** button to activate the system, then set the desired speed.

Automatic cancellation

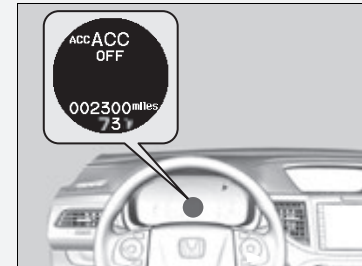

Even though adaptive cruise control has been automatically canceled, you can still resume the prior set speed. Wait until the condition that caused ACC to cancel improves, then press the **RES/+** button.

■ To Switch ACC to Cruise Control

Press and hold the  (distance) button for one second.

CRUISE MODE SELECTED appears on the multi-information display for two seconds, and then the mode switches to **Cruise**.

To switch back to **ACC**, press and hold the  button again for one second.

▶▶ To Switch ACC to Cruise Control

Always be aware which mode you are in. When you are driving in **Cruise Mode**, the system will not assist you to maintain a following distance from a vehicle ahead of you.

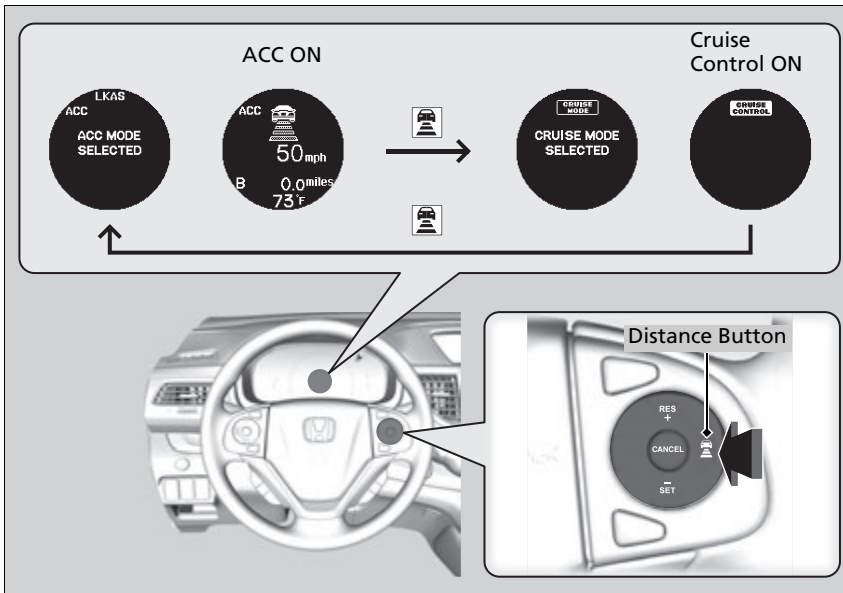

Lane Departure Warning (LDW)*

Alerts you when the system determines a possibility of your vehicle unintentionally crossing over detected lane markings.

How the System Works

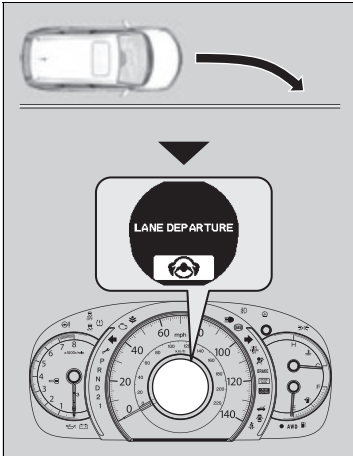

The front camera behind the rearview mirror monitors left and right lane marking.

If your vehicle is getting too close to detected left or right side lane markings without a turn signal activated, LDW will give audible and visual alerts.

The beeper sounds and the **LANE DEPARTURE** message appears on the multi-information display, letting you know that you need to take appropriate action.

☒ Lane Departure Warning (LDW)*

Important Safety Reminder

Like all assistance systems, LDW has limitations. Over-reliance on LDW may result in a collision. It is always your responsibility to keep the vehicle within your driving lane.

LDW only alerts you when lane drift is detected without a turn signal in use. LDW may not detect all lane markings or lane departures; accuracy will vary based on weather, speed and lane marker condition. It is always your responsibility to safely operate the vehicle and avoid collisions.

You can read about handling information for the camera equipped with this system.

☒ **Front Sensor Camera*** P. 378

The LDW may not work properly or may work improperly under the certain conditions:

☒ **LDW Limitations** P. 393

* Not available on all models

■ How the System Activates

The system begins to search for lane markings when all the following conditions are met:

- The vehicle is traveling between about 45 and 90 mph (72 and 145 km/h).
- The vehicle is on a straight or slightly curved road.
- The turn signals are off.
- The brake pedal is not depressed.
- The wipers are not in continuous operation.

■ LDW On and Off

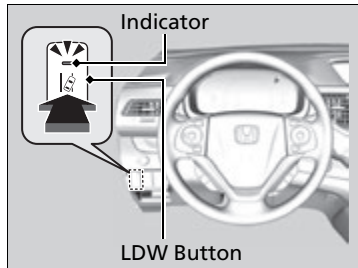

Press the LDW button to turn the system on and off.

- ▶ The indicator in the button comes on when the system is on.

▶▶ How the System Activates

LDW may automatically shut off and the LDW indicator comes and stays on.

▶▶ Indicators P. 87

LDW Limitations

LDW may not activate or may not recognize lanes, and may activate even when keeping in the middle of a lane, under certain conditions. Some examples of these conditions are listed below.

Environmental conditions

- Driving in bad weather (rain, fog, snow, etc.).
- Sudden changes between light and dark, such as an entrance or exit of a tunnel.
- There is little contrast between lane lines and the roadway surface.
- Driving into low sunlight (e.g., at dawn or dusk).
- Strong light is reflected onto the roadway.
- Driving in the shadows of trees, buildings, etc.
- Shadows of adjacent objects are parallel to lane markings.
- Roadway objects or structures are misinterpreted as lane markings.
- Reflections on the interior of the front windshield.

■ Roadway conditions

- Driving on a snowy or wet roadway (obscured lane marking, vehicle tracks, reflected lights, road spray, high contrast).
- Driving on a road with temporary lane markings.
- Faint, multiple, or varied lane markings are visible on the roadway due to road repairs or old lane markings.
- The roadway has merging, split, or crossing lines (e.g., such as at an intersection or crosswalk).
- The lane markings are extremely narrow, wide, or changing.
- The vehicle in front of you is driving near the lane lines.
- The road is hilly or the vehicle is approaching the crest of a hill.
- Driving on rough or unpaved roads, or over bumpy surfaces.
- When objects on the road (curb, guard rail, pylons, etc.) are recognized as white lines (or yellow lines).
- When driving on roads with double lines.

■ Vehicle conditions

- Headlight lenses are dirty or the headlights are not properly adjusted.
- The outside of the windshield is streaked or blocked by dirt, mud, leaves, wet snow, etc.
- The inside of the windshield is fogged.
- The camera temperature gets too hot.
- An abnormal tire or wheel condition (wrong sized, varied size or construction, improperly inflated, compact spare tire, etc.).
- The vehicle is tilted due to a heavy load or suspension modifications.

Lane Keeping Assist System (LKAS)*

Provides steering input to help keep the vehicle in the middle of a detected lane and provides audible and visual alerts if the vehicle is detected drifting out of its lane.

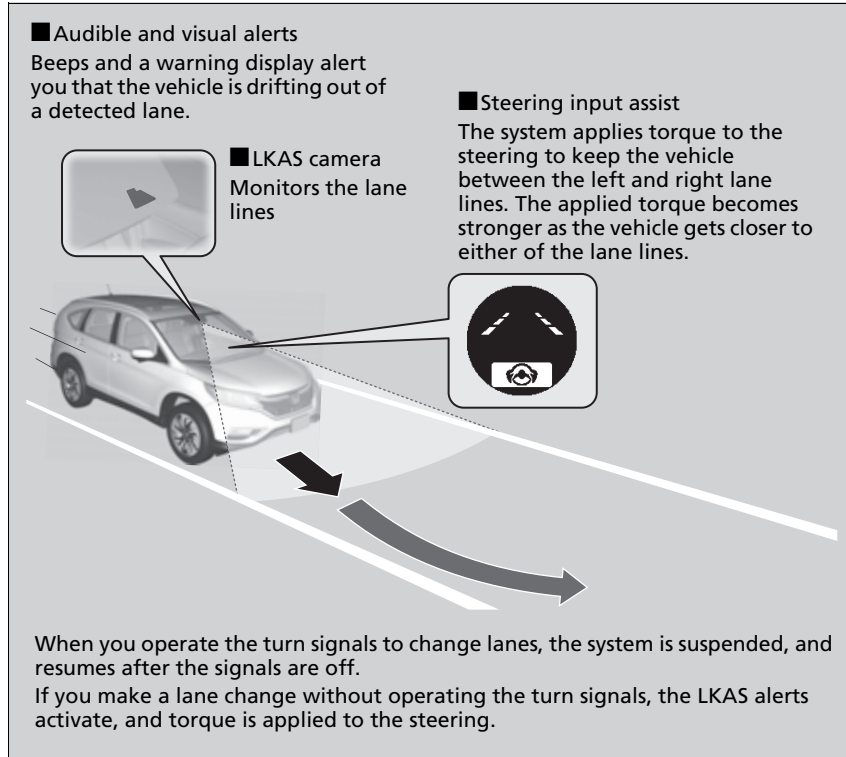

* Not available on all models

Continued

▶ Lane Keeping Assist System (LKAS)*

Important Safety Reminders

The LKAS is for your convenience only. It is not a substitute for your vehicle control. The system does not work if you take your hands off the steering wheel or fail to steer the vehicle.

▶ Display Warning and Information Messages* P. 88

Do not place objects on the instrument panel. Objects may reflect on the front windshield and prevent correct detection of the traffic lanes.

LKAS only alerts you when lane drift is detected without a turn signal in use. LKAS may not detect all lane markings or lane departures; accuracy will vary based on weather, speed, and lane marker condition. It is always your responsibility to safely operate the vehicle and avoid collisions.

The LKAS is convenient when it is used on freeways.

LKAS may not work properly under certain conditions.

▶ LKAS Limitations P. 401

LKAS may not function as designed on while driving in frequent stop and go traffic, or on roads with sharp curves.

You can read about handling information for the camera equipped with this system.

▶ Front Sensor Camera* P. 378

■ Lane Keep Support Function

Provides assistance to keep the vehicle in the center of the lane, when the vehicle nears a white or yellow line, steering force of the electric power steering will become stronger.

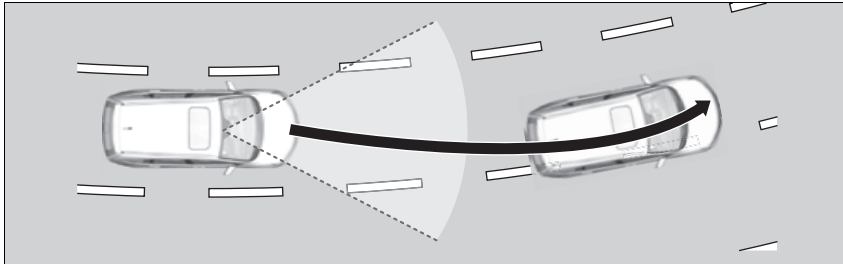

■ Lane Departure Warning Function

When the vehicle enters the warning area, a beep sounds and a warning displays.

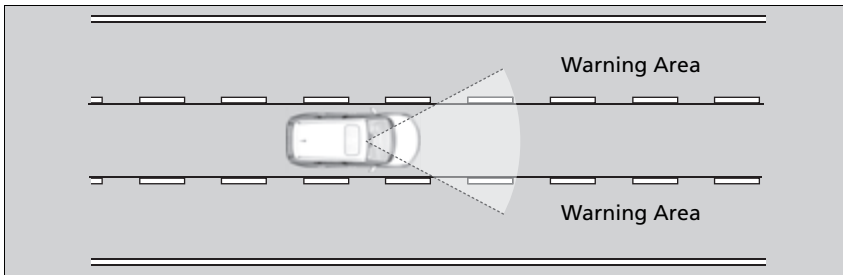

▶▶ Lane Keeping Assist System (LKAS)*

When it fails to detect lanes, the system will temporarily be canceled. When lane is detected, system will recover automatically.

■ When the System can be Used

The system can be used when the following conditions are met.

- The lane in which you are driving has detectable lane markers on both sides, and your vehicle is in the center of the lane.
- The vehicle speed is between about 45 and 90 mph (72 and 145 km/h).
- You are driving on a straight or slightly curved road.
- The turn signals are off.
- The brake pedal is not depressed.
- The wipers are not in continuous operation.

■ How to activate the system

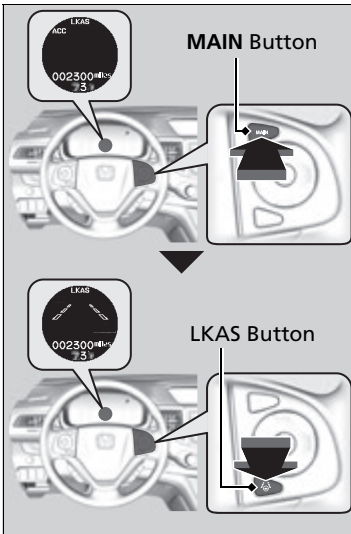

1. Press the **MAIN** button.
 - ▶ The LKAS is on in the multi-information display.
The system is ready to use.
2. Press the LKAS button.
 - ▶ Lane outlines appear on the multi-information display.
The system is activated.

* Not available on all models

Continued

▶ Lane Keeping Assist System (LKAS)*

You can read about handling information for the camera equipped with this system.

▶ **Front Sensor Camera*** P. 378

If the vehicle drifts toward either left or right lane line due to the system applying torque, turn off the LKAS and have your vehicle checked by a dealer.

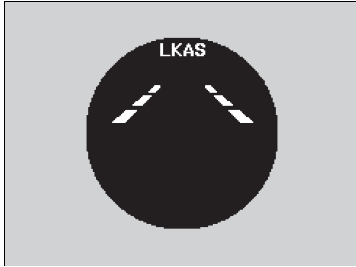

3. Keep your vehicle near the center of the lane while driving.
 - ▶ The dotted outer lines change to solid ones once the system starts operating after detecting the left and right lane markings.

■ To cancel

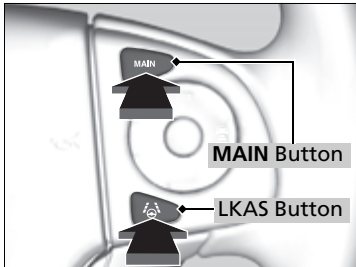

To cancel the LKAS:
Press the **MAIN** or LKAS button.

The LKAS is turned off every time you stop the engine, even if you turned it on the last time you drove the vehicle.

⌘ When the System can be Used

The LKAS temporarily deactivates when it fails to detect lane lines. When the system detects the lines again, it comes back on automatically.

⌘ To cancel

Pressing the **MAIN** button also turns ACC on and off.



When the LKAS is suspended, the lane lines on the multi-information display change to contour lines.

■ **The system operation is suspended if you:**

- Set the wipers to continuous operation.
 - ▶ Turning the wipers off resumes the LKAS.
- Decrease the vehicle speed to about 40 mph (64 km/h) or less.
 - ▶ Increasing the vehicle speed to about 45 mph (72 km/h) or more resumes the LKAS.
- Depress the brake pedal.
 - ▶ The LKAS resumes and starts detecting the lane lines again once you release the brake pedal.

Models with automatic intermittent wipers

- Set the wiper switch to **AUTO** and the wipers operate continuously.
 - ▶ The LKAS resumes when the wipers stop or operate intermittently.

■ **The LKAS may automatically be suspended when:**

- The system fails to detect lane lines.
- The steering wheel is quickly turned.
- You fail to steer the vehicle.
- The vehicle runs on a curved road over the speed limit.
- When driving through a sharp curve.
- When driving at a speed in excess of approximately 90 mph (145 km/h).

Once these conditions no longer exist, the LKAS automatically resumes.

■ **The LKAS may automatically be canceled when:**

- The camera temperature gets too high.
- The camera behind the rearview mirror, or the area around the camera, including the windshield, gets dirty.
- When the ABS or VSA® systems engage.

A beeper will sound if the LKAS is automatically canceled.

■ LKAS Limitations

The system may not detect lane markings and therefore may not keep the vehicle in the middle of a lane under certain conditions, including the following:

■ Environmental conditions

- Driving in bad weather (rain, fog, snow, etc.).
- Sudden changes between light and dark, such as an entrance or exit of a tunnel.
- There is little contrast between lane lines and the roadway surface.
- Driving into low sunlight (e.g., at dawn or dusk).
- Strong light is reflected onto the roadway.
- Driving in the shadows of trees, buildings, etc.
- Shadows of adjacent objects are parallel to lane markings.
- Roadway objects or structures are misinterpreted as lane markings.
- Reflections on the interior of the front windshield.

■ **Roadway conditions**

- Driving on a snowy or wet roadway (obscured lane marking, vehicle tracks, reflected lights, road spray, high contrast).
- Driving on a road with temporary lane markings.
- Faint, multiple, or varied lane markings are visible on the roadway due to road repairs or old lane markings.
- The roadway has merging, split, or crossing lines (e.g., such as at an intersection or crosswalk).
- The lane markings are extremely narrow, wide, or changing.
- The vehicle in front of you is driving near the lane lines.
- The road is hilly or the vehicle is approaching the crest of a hill.
- Driving on rough or unpaved roads, or over bumpy surfaces.
- When objects on the road (curb, guard rail, pylons, etc.) are recognized as white lines (or yellow lines).
- When driving on roads with double lines.

■ **Vehicle conditions**

- Headlight lenses are dirty or the headlights are not properly adjusted.
- The outside of the windshield is streaked or blocked by dirt, mud, leaves, wet snow, etc.
- The inside of the windshield is fogged.
- The camera temperature gets too hot.
- An abnormal tire or wheel condition (wrong sized, varied size or construction, improperly inflated, compact spare tire, etc.).
- The vehicle is tilted due to a heavy load or suspension modifications.

Vehicle Stability Assist (VSA®), aka Electronic Stability Control (ESC), System

Helps stabilize the vehicle during cornering if the vehicle turns more or less than what was intended. It also assists in maintaining traction on slippery surfaces. It does so by regulating engine output and selectively applying the brakes.

VSA® Operation

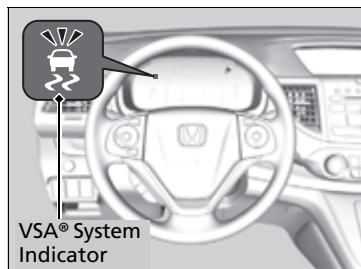

When VSA® activates, you may notice that the engine does not respond to the accelerator. You may also notice some noise from the hydraulic system. You will also see the indicator blink.

Vehicle Stability Assist (VSA®), aka Electronic Stability Control (ESC), System

The VSA® may not function properly if tire types and size are mixed. Make sure to use the same size and types of tire, and the air pressures as specified.

When the VSA® indicator comes on and stays on while driving, there may be a problem with the system. While this may not interfere with normal driving, have your vehicle checked by a dealer immediately.

VSA® cannot enhance stability in all driving situations and does not control the entire braking system. You still need to drive and corner at speeds appropriate for the conditions and always leave a sufficient margin of safety.

The main function of the VSA® system is generally known as Electronic Stability Control (ESC). The system also includes a traction control function.

■ VSA® On and Off

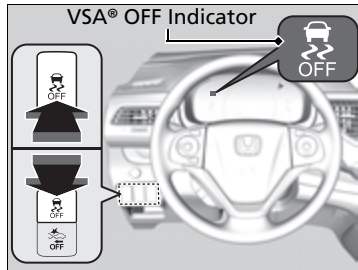

This button is on the driver side control panel. To partially turn the VSA® features on and off, press and hold it until you hear a beep.

The traction control stops fully functioning, allows the wheels to spin more freely at low speed. The VSA® OFF indicator will also come on.

To turn it on again, press the  (VSA® OFF) button until you hear a beep.

VSA® is turned on every time you start the engine, even if you turned it off the last time you drove the vehicle.

▶▶ Vehicle Stability Assist (VSA®), aka Electronic Stability Control (ESC), System

With the  button pressed, your vehicle will have normal braking and cornering ability, but VSA® traction and stability enhancement becomes less effective.

In certain unusual conditions when your vehicle gets stuck in shallow mud or fresh snow, it may be easier to free it with VSA® temporarily switched off.

When the  button is pressed, the traction control function becomes less effective. This allows for the wheels to spin more freely at low speed. You should only attempt to free your vehicle with the VSA® off if you are not able to free it when the VSA® is on.

Immediately after freeing your vehicle, be sure to switch VSA® on again. We do not recommend driving your vehicle with the VSA® system switched off.

You may hear a motor sound coming from the engine compartment while system checks are being performed immediately after starting the engine or while driving. This is normal.

LaneWatch™*

LaneWatch is an assistance system that allows you to check the passenger side rear areas displayed on the audio/information screen when the turn signal is activated to the passenger's side. A camera in the passenger side door mirror monitors these areas and allows you to check for vehicle, in addition to your visual check and use of the passenger door mirror. You can also keep the system on for your convenience while driving.

1 The system activates when you:

Move the turn signal lever to the passenger side. Press the LaneWatch button.



The system deactivates when you:

Pull the turn signal lever back. Press the LaneWatch button again.

2 The passenger side view display appears on the audio/information screen.



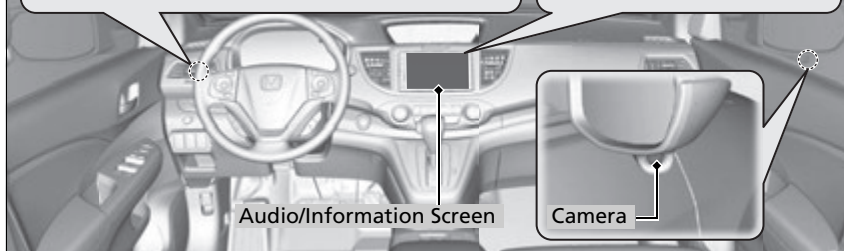

Audio/Information Screen

Camera

▶ LaneWatch™*

⚠ WARNING

Failure to visually confirm that it is safe to change lanes before doing so may result in a crash and serious injury or death.

Do not rely only on LaneWatch while driving.

Always look in your mirrors, to either side of your vehicle, and behind you for other vehicles before changing lanes.

Important Safety Reminder

Like all assistance systems, LaneWatch has limitations. Over reliance on LaneWatch may result in a collision.

The LaneWatch function can be affected by weather, lighting (including headlights and low sun angle), ambient darkness, camera condition, and loading.

The LaneWatch may not provide the intended display of traffic to the side and rear under the following conditions:

- Your vehicle's suspension has been altered, changing the height of the vehicle.
- Your tires are over or under inflated.
- Your tires or wheels are of varied size or construction.

* Not available on all models

Continued

■ Customizing the LaneWatch settings

You can customize the following items using the audio/information screen.

- **Show with Turn Signal:** Selects whether LaneWatch monitor comes on when you operate the turn signal light lever.
- **Display Time after Turn Off:** Changes the remaining Lane Watch display time after you pull the turn signal lever back.
- **Reference Lines:** Selects whether the reference lines appear on the LaneWatch monitor.
- **Next Maneuver Pop up*:** Selects whether a turn direction screen of the navigation system interrupts the LaneWatch display.
- **Display:** Adjusts display settings.
 ➤ **Customized Features** P. 274

■ Reference Lines

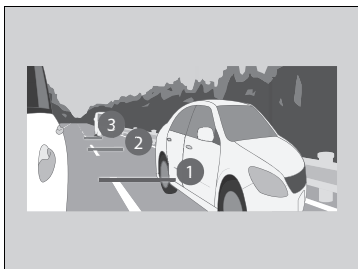

Three lines that appear on the screen can give an idea of how far the vehicles or objects on the screen are from your vehicle, respectively. If an object is near line 1 (in red), it indicates that it is close to your vehicle whereas an object near line 3 farther away.

☒ LaneWatch™*

The LaneWatch camera view is restricted. Its unique lens makes objects on the screen look slightly different from what they are.

LaneWatch display does not come on when the shift lever is in **R**.

For proper LaneWatch operation:

- The camera is located in the passenger side door mirror. Always keep this area clean. If the camera lens is covered with dirt or moisture, use a soft, moist cloth to keep the lens clean and free of debris.
- Do not cover the camera lens with labels or stickers of any kind.
- Do not touch the camera lens.

☒ Reference Lines

The area around the reference line 1 (red) is very close to your vehicle. As always, make sure to visually confirm the safety of a lane change before changing lanes.

The distance between your vehicle and lines 1, 2 and 3 on the screen vary depending on road conditions and vehicle loading. For example, the reference lines on the screen may seem to appear closer than the actual distances when the rear of your vehicle is more heavily loaded.

Consult a dealer if:

- The passenger side door mirror, or area around it is severely impacted, resulting in changing the camera angle.
- The LaneWatch display does not come on at all.

Real Time AWD with Intelligent Control System™*

When the system senses a loss of front wheel traction, it automatically transfers some power to the rear wheels. This allows you to utilize all available traction and may increase mobility.

You still need to exercise the same care when accelerating, steering, and braking that you would in a two wheel drive vehicle.

If you excessively spin all four wheels and overheat the AWD system, only the front wheels receive power. Stop until the system cools down.

▶▶ Real Time AWD with Intelligent Control System™*

NOTICE

Do not continuously spin the front tires of your vehicle. Continuously spinning the front tires can cause transmission or rear differential damage.

The AWD system may not function properly if tire type and size are mixed. Make sure to use the same size and type of tire, and the air pressures as specified.

▶ **Tire and Wheel Replacement** P. 481

* Not available on all models

Tire Pressure Monitoring System (TPMS)

Instead of directly measuring the pressure in each tire, the TPMS on this vehicle monitors and compares the rolling radius and rotational characteristics of each wheel and tire while you are driving to determine if one or more tires are significantly under-inflated. This will cause the low tire pressure/TPMS indicator to come on and a message to appear on the multi-information display*.

TPMS Calibration

You must start TPMS calibration every time you:

- Adjust the pressure in one or more tires.
- Rotate the tires.
- Replace one or more tires.

Before calibrating the TPMS:

- Set the cold tire pressure in all four tires.

Make sure:

- The vehicle is at a complete stop.
- The shift lever is in **P**.
- The ignition switch is in ON **II***1.

*1: Models with the smart entry system have an **ENGINE START/STOP** button instead of an ignition switch.

* Not available on all models

⚠ Tire Pressure Monitoring System (TPMS)

The system does not monitor the tires when driving at low speed.

Conditions such as low ambient temperature and altitude change directly affect tire pressure and can trigger the low tire pressure/TPMS indicator to come on.

Tire pressure checked and inflated in:

- Warm weather can become under-inflated in colder weather.
- Cold weather can become over-inflated in warmer weather.

The low tire pressure indicator will not come on as a result of over inflation.

The TPMS may not function properly if tire type and size are mixed. Make sure to use the same size and type of tire.

📖 **Checking and Maintaining Tires** P. 475

The low tire pressure/TPMS indicator may come on with a delay or may not come on at all when:

- You rapidly accelerate, decelerate, or turn the steering wheel.
- You drive on snowy or slippery roads.
- Snow chains are used.

The low tire pressure/TPMS indicator may come on under the following conditions:

- A compact spare tire is used.
- There is a heavier and uneven load on the tires, such as when towing a trailer, than the condition at calibration.
- Snow chains are used.

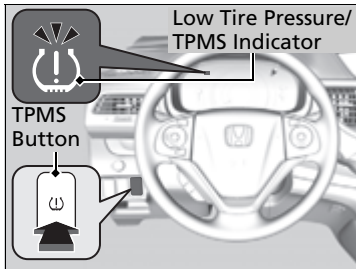

Models with information display

Press and hold the TPMS button.

- ▶ The low tire pressure/TPMS indicator blinks a few times.

If the indicator does not blink a few times, the calibration is not successful. Press and hold the TPMS button again.

Models with multi-information display

You can calibrate the system from the customized features on the multi-information display.

1. Press the /▼ button to select **TPMS CALIBRATION**, then press the **SEL/RESET** button.
2. Press the **SEL/RESET** button.
 - ▶ The display switches to the customization setup screen, where you can select **Cancel** or **Calibrate**.
3. Press the /▼ button and select **Calibrate**, then press the **SEL/RESET** button.
 - ▶ **Calibration Started** screen appears, then the display returns to the customization menu screen.

If the **Calibration Failed to Start** message appears, repeat steps 2-3.

TPMS Calibration

- TPMS cannot be calibrated if a compact spare tire is installed.
- The calibration process requires approximately 30 minutes of cumulative driving at speeds between 30-60 mph (48-97 km/h).
- During this period, if the ignition is turned on*1 and the vehicle is not moved within 45 seconds, you may notice the low tire pressure indicator comes on briefly. This is normal and indicates that the calibration process is not yet complete.

If the snow chains are installed, remove them before calibrating the TPMS.

If the low tire pressure/TPMS indicator comes on even when the properly inflated specified regular tires are installed, have the vehicle checked by a dealer.

We recommend that the tires be replaced with the same brand, model, and size as the originals. Ask a dealer for details.

*1: Models with the smart entry system have an **ENGINE START/STOP** button instead of an ignition switch.

U.S. models

Tire Pressure Monitoring System (TPMS) - Required Federal Explanation

Each tire, including the spare (if provided), should be checked monthly when cold and inflated to the inflation pressure recommended by the vehicle manufacturer on the vehicle placard or tire inflation pressure label.

(If your vehicle has tires of a different size than the size indicated on the vehicle placard or tire inflation pressure label, you should determine the proper tire inflation pressure for those tires.)

As an added safety feature, your vehicle has been equipped with a tire pressure monitoring system (TPMS) that illuminates a low tire pressure telltale



when one or more of your tires is significantly under-inflated.

Accordingly, when the low tire pressure telltale illuminates, you should stop and check your tires as soon as possible, and inflate them to the proper pressure.

Driving on a significantly under-inflated tire causes the tire to overheat and can lead to tire failure. Under-inflation also reduces fuel efficiency and tire tread life, and may affect the vehicle's handling and stopping ability.

Please note that the TPMS is not a substitute for proper tire maintenance, and it is the driver's responsibility to maintain correct tire pressure, even if under-inflation has not reached the level to trigger illumination of the TPMS low tire pressure telltale.

Your vehicle has also been equipped with a TPMS malfunction indicator to indicate when the system is not operating properly. The TPMS malfunction indicator is combined with the low tire pressure telltale. When the system detects a malfunction, the telltale will flash for approximately one minute and then remain continuously illuminated. This sequence will continue upon subsequent vehicle start-ups as long as the malfunction exists.

When the malfunction indicator is illuminated, the system may not be able to detect or signal low tire pressure as intended.

TPMS malfunctions may occur for a variety of reasons, including the installation of replacement or alternate tires or wheels on the vehicle that prevent the TPMS from functioning properly.

Always check the TPMS malfunction telltale after replacing one or more tires or wheels on your vehicle to ensure that the replacement or alternate tires and wheels allow the TPMS to continue to function properly.

Brake System

■ Parking Brake

Use the parking brake to keep the vehicle stationary when parking.

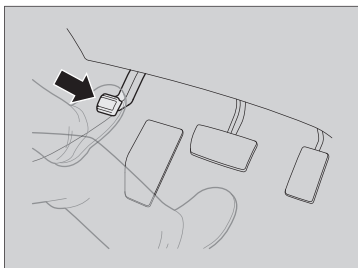

To apply:

Depress the parking brake pedal down with your foot.

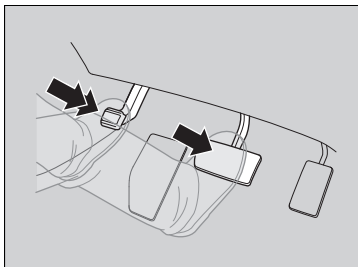

To release:

1. Depress the brake pedal.
2. Depress the parking brake.

» Parking Brake

NOTICE

Release the parking brake fully before driving. The rear brakes and axle can be damaged if you drive with the parking brake applied.

If you start driving without fully releasing the parking brake, a buzzer sounds as a warning.

Always apply the parking brake when parking.

Foot Brake

Your vehicle is equipped with disc brakes at all four wheels. A vacuum power assist helps reduce the effort needed on the brake pedal. The brake assist system increases the stopping force when you depress the brake pedal hard in an emergency situation. The anti-lock brake system (ABS) helps you retain steering control when braking very hard.

➤ **Brake Assist System** P. 415

➤ **Anti-lock Brake System (ABS)** P. 414

Foot Brake

Check the brakes after driving through deep water, or if there is a buildup of road surface water. If necessary, dry the brakes by lightly depressing the pedal several times.

If you hear a continuous metallic friction sound when applying the brakes, this is caused by the brake wear indicator rubbing on the brake rotor and indicates that the brake pads need to be replaced. Have the vehicle checked by a dealer. If you hear only an occasional squeak or squeal when you initially apply the brake pedal, this may be normal and caused by high frequency vibration of the brake pads against the rotating brake disc.

Constantly using the brake pedal while going down a long hill builds up heat, which reduces the brake effectiveness. Apply engine braking by taking your foot off the accelerator pedal and downshifting to a lower gear.

Do not rest your foot on the brake pedal while driving, as it will lightly apply the brakes and cause them to lose effectiveness over time and reduce pad life. It will also confuse drivers behind you.

Anti-lock Brake System (ABS)

Helps prevent the wheels from locking up, and helps you retain steering control by pumping the brakes rapidly, much faster than you.

The electronic brake distribution (EBD) system, which is part of the ABS, also balances the front-to-rear braking distribution according to vehicle loading.

You should never pump the brake pedal. Let the ABS work for you by always keeping firm, steady pressure on the brake pedal. This is sometimes referred to as “stomp and steer.”

■ ABS operation

The brake pedal may pulsate slightly when the ABS is working. Keep holding the pedal firmly down. On dry pavement, you need to press on the brake pedal very hard before the ABS activates. However, you may feel the ABS activate immediately if you are trying to stop on snow or ice.

When the vehicle speed goes under 6 mph (10 km/h), the ABS stops.

ⓘ Anti-lock Brake System (ABS)

NOTICE

The ABS may not function correctly if you use an incorrect tire type and size.

When the **ABS** indicator comes on while driving, there may be a problem with the system.

While normal braking is not affected, there is a possibility of the ABS not operating. Have the vehicle checked by a dealer immediately.

The ABS does not reduce the time or distance it takes to stop the vehicle. It only helps with steering control during hard braking.

In the following cases, your vehicle may need more stopping distance than a vehicle without the ABS:

- When driving on rough road surfaces, including when driving on uneven surfaces, such as gravel or snow.
- When tire chains are installed.

You may hear a motor sound coming from the engine compartment while system checks are being performed immediately after starting the engine or while driving. This is normal.

Brake Assist System

Designed to assist the driver by generating greater braking force when you depress the brake pedal hard during emergency braking.

■ Brake assist system operation

Depress the brake pedal firmly for more powerful braking.

When brake assist operates, the pedal may wiggle slightly and an operating noise may be heard. This is normal. Keep holding the brake pedal firmly down.

Collision Mitigation Braking System™ (CMBS™)*

Can assist you when there is a possibility of your vehicle colliding with a vehicle or a pedestrian detected in front of yours. The CMBS™ is designed to alert you when a potential collision is determined, as well as to reduce your vehicle speed when a collision is deemed unavoidable to help minimize collision severity.

■ How the system works

When to use

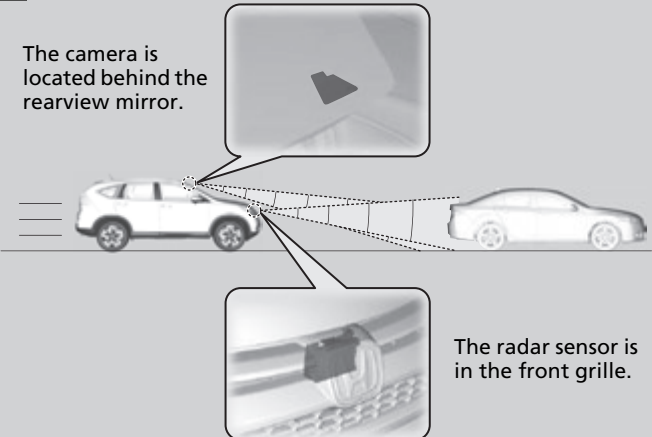

The camera is located behind the rearview mirror.

The radar sensor is in the front grille.

The system starts monitoring the roadway ahead when your vehicle speed is about 3 mph (5 km/h) and there is a vehicle in front of you.

The CMBS™ activates when:

- The speed difference between your vehicle and a vehicle or pedestrian detected in front of you becomes about 3 mph (5 km/h) and over with a chance of a collision.
- Your vehicle speed is about 62 mph (100 km/h) or less and there is a chance of a collision with an oncoming detected vehicle or a pedestrian in front of you.

⊗ Collision Mitigation Braking System™ (CMBS™)*

Important Safety Reminder

The CMBS™ is designed to reduce the severity of an unavoidable collision. It does not prevent collision nor stop the vehicle automatically. It is still your responsibility to operate the brake pedal and steering wheel appropriately according to the driving conditions.

The CMBS™ may not activate or may not detect a vehicle in front of your vehicle under certain conditions:

➤ **CMBS™ Conditions and Limitations** P. 421

You can read about handling information for the camera equipped with this system.

➤ **Front Sensor Camera*** P. 378

The camera in the CMBS™ is also designed to detect pedestrians.

However, this pedestrian detection feature may not activate or may not detect a pedestrian in front of your vehicle under certain conditions.

Refer to the ones indicating the pedestrian detection limitations from the list.

➤ **CMBS™ Conditions and Limitations** P. 421

■ **When the system activates**

The system provides visual and audible alerts of a possible collision, and stops if the collision is avoided.

- ▶ Take appropriate action to prevent a collision (apply the brakes, change lanes, etc.)

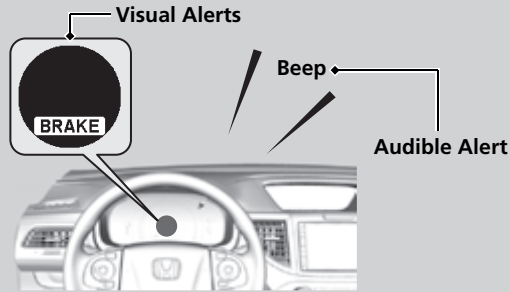

At system's earliest collision alert stage, you can change the distance (**LONG/NORMAL/SHORT**) between vehicles at which alerts will come on through multi-information display setting options.

- 📖 **List of customizable options** P. 106, 120

■ Collision Alert Stages

The system has three alert stages for a possible collision. However, depending on circumstances, the CMBS™ may not go through all of the stages before initiating the last stage.

| Distance between vehicles | | CMBS™ | | |
|---------------------------|--|--|--|--------------------|
| | | The sensors detect a vehicle | Audible & Visual WARNINGS | Braking |
| Stage one | | There is a risk of a collision with the vehicle ahead of you. | When in LONG , visual and audible alerts come on at a longer distance from a vehicle ahead than in NORMAL setting, and in SHORT , at a shorter distance than in NORMAL . | — |
| Stage two | | The risk of a collision has increased, time to respond is reduced. | Visual and audible alerts. | Lightly applied |
| Stage three | | The CMBS™ determines that a collision is unavoidable. | | Forcefully applied |

■ CMBS™ On and Off

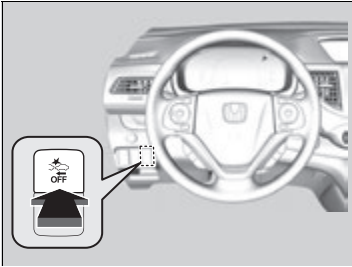

Press this button until the beeper sounds to switch the system on or off.

When the CMBS™ is off:

- The CMBS™ indicator in the instrument panel comes on.
- A message on the multi-information display reminds you that the system is off.

The CMBS™ is in the previously selected ON or OFF setting each time you start the engine.

▣ Collision Mitigation Braking System™ (CMBS™)*

The CMBS™ may automatically shut off, and the CMBS™ indicator will come and stay on under certain conditions.

▣ **CMBS™ Conditions and Limitations** P. 421

* Not available on all models

■ With Little Chance of a Collision

The CMBS™ may activate even when you are aware of a vehicle ahead of you, or when there is no vehicle ahead. Some examples of this are:

■ When Passing

Your vehicle approaches another vehicle ahead of you and you change lanes to pass.

■ At an intersection

Your vehicle approaches or passes another vehicle that is making a left or right turn.

■ On a curve

When driving through curves, your vehicle comes to a point where an oncoming vehicle is right in front of you.

■ Through a low bridge at high speed

You drive under a low or narrow bridge at high speed.

■ Speed bumps, road work sites, train tracks, roadside objects, etc.

You drive over speed bumps, steel road plates, etc., or your vehicle approaches train tracks or roadside objects [such as a traffic sign and guard rail] on a curve or, when parking, stationary vehicles and walls.

⚠ Collision Mitigation Braking System™ (CMBS™)*

For the CMBS™ to work properly:

Always keep the radar sensor cover clean.

Never use chemical solvents or polishing powder for cleaning the sensor cover. Clean it with water or a mild detergent.

Do not put a sticker on the emblem or replace the emblem.

If you need the radar sensor to be repaired, or removed, or the radar sensor cover is strongly impacted, turn off the system by pressing the CMBS™ off button and take your vehicle to a dealer.

■ CMBS™ Conditions and Limitations

The system may automatically shut off and the CMBS™ indicator will come on under certain conditions. Some examples of these conditions are listed below. Other conditions may reduce some of the CMBS™ functions.

📷 **Front Sensor Camera*** P. 378

■ Environmental conditions

- Driving in bad weather (rain, fog, snow, etc.).
- Sudden changes between light and dark, such as an entrance or exit of a tunnel.
- There is little contrast between objects and the background.
- Driving into low sunlight (e.g., at dawn or dusk).
- Strong light is reflected onto the roadway.
- Driving in the shadows of trees, buildings, etc.
- Roadway objects or structures are misinterpreted as vehicles and pedestrians.
- Reflections on the interior of the front windshield.

■ Roadway conditions

- Driving on a snowy or wet roadway (obscured lane marking, vehicle tracks, reflected lights, road spray, high contrast).
- The road is hilly or the vehicle is approaching the crest of a hill.
- Driving on curvy, winding, or undulating roads.

■ **Vehicle conditions**

- Headlight lenses are dirty or the headlights are not properly adjusted.
- The outside of the windshield is blocked by dirt, mud, leaves, wet snow, etc.
- The inside of the windshield is fogged.
- An abnormal tire or wheel condition (wrong sized, varied size or construction, improperly inflated, compact spare tire, etc.).
- When tire chains are installed.
- The vehicle is tilted due to a heavy load or suspension modifications.
- The camera temperature gets too hot.
- Driving with the parking brake applied.
- When the radar sensor in the front grille gets dirty.

■ Detection limitations

- A vehicle or pedestrian suddenly crosses in front of you.
- The distance between your vehicle and the vehicle or pedestrian ahead of you is too short.
- When you accelerate rapidly and approach the vehicle or pedestrian ahead of you at high speed.
- The speed difference between your vehicle and a vehicle or pedestrian in front of you is significantly large.
- A vehicle cuts in front of you at a slow speed, and it brakes suddenly.
- The vehicle ahead of you is a motorcycle, bicycle, mobility scooter or other small vehicle.
- When there are animals in front of your vehicle.
- When you drive on a curved, winding or undulating road that makes it difficult for the sensor to properly detect a vehicle in front of you.
- An oncoming vehicle suddenly comes in front of you.
- Another vehicle suddenly comes in front of you at an intersection, etc.
- Your vehicle abruptly crosses over in front of an oncoming vehicle.
- When driving through a narrow iron bridge.
- When the lead vehicle suddenly slows down.

■ Limitations pedestrians only

- When there is a group of people in front of your vehicle walking together side by side.
- Surrounding conditions or belongings of the pedestrian alter the pedestrian's shape, preventing the system from recognizing that the person is a pedestrian.
- When the pedestrian is slouching or squatting.
- When the pedestrian is shorter than about 3 feet (1 meter) or taller than about 7 feet (2 meter) in height.
- When a pedestrian blends in with the background.
- When a pedestrian is bent over or squatting, or when their hands or raised or they are running.
- When several pedestrians are walking ahead in a group.
- When the camera cannot correctly identify that a pedestrian is present due to an unusual shape (holding luggage, body position, size).

■ Automatic shutoff

CMBS™ may automatically shut itself off and the CMBS™ indicator comes and stays on when:

- The temperature inside the system is high.
- You drive off-road or on a mountain road, or curved and winding road for an extended period.
- An abnormal tire condition is detected (wrong tire size, flat tire, etc.).
- The camera behind the rearview mirror, or the area around the camera, including the windshield, gets dirty.

Once the conditions that caused CMBS™ to shut off improve or are addressed (e.g., cleaning), the system comes back on.

When Stopped

1. Depress the brake pedal firmly with the shift lever in **D**.
2. Firmly apply the parking brake.
3. Move the shift lever from **D** to **P**.
4. Turn off the engine.

Always set the parking brake firmly, in particular if you are parked on an incline.

▣ Parking Your Vehicle

Do not park your vehicle near flammable objects, such as dry grass, oil, or timber. Heat from the exhaust can cause a fire.

▣ When Stopped

NOTICE

The following can damage the transmission:

- Depressing the accelerator and brake pedals simultaneously.
- Holding the vehicle in place when facing uphill by depressing the accelerator pedal.
- Moving the shift lever into **P** before the vehicle stops completely.

About Your Multi-View Rear Camera

Models with one display

The intelligent multi-information display (i-MID) can display your vehicle's rear view. The display automatically changes to the rear view when the shift lever is moved to **R**.

Models with two displays/Models with navigation system

See the Navigation System Manual.

Models with two displays/Models without navigation system

The audio/information screen can display your vehicle's rear view. The display automatically changes to the rear view when the shift lever is moved to **R**.

» About Your Multi-View Rear Camera

The rear camera view is restricted. You cannot see the corner ends of the bumper or what is underneath the bumper. Its unique lens also makes objects appear closer or farther than they actually are.

Visually confirm that it is safe to drive before backing up. Certain conditions, such as weather, lighting, and high temperatures, may also restrict the rear view. Do not rely on the rearview display which does not give you all information about conditions at the back of your vehicle.

If the camera lens is covered with dirt or moisture, use a soft, moist cloth to keep the lens clean and free of debris.

Multi-View Rear Camera Display Area

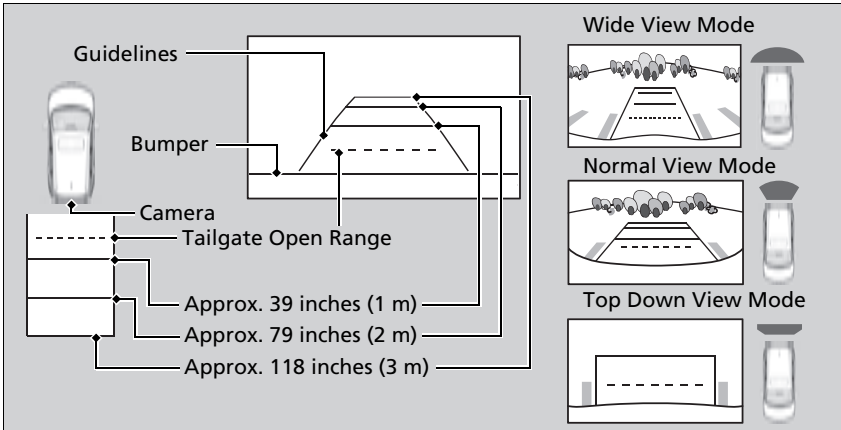

About Your Multi-View Rear Camera

You can change the **Fixed Guideline** and **Dynamic Guideline** settings.

➤ **Customized Features** P. 274

Models with two displays/Models without navigation system

Fixed Guideline

On: Guidelines appear when you shift into **R**.

Off: Guidelines do not appear.

Dynamic Guideline

On: Guidelines move according to the steering wheel direction.

Off: Guidelines do not move.

You can view three different camera angles on the rearview display.

Models with one display

Press the selector knob to switch the angle.

Models with two displays/Models without navigation system

Touch the appropriate icon to switch the angle.

: Wide view

: Normal view

: Top down view

All models

If the last used viewing mode is Wide or Normal, the same mode is selected the next time you shift into **[R]**. If Top View is last used before you turned off the engine, Wide mode is selected next time you turn the ignition switch to ON **[II]***1 and shift to **[R]**.

*1: Models with the smart entry system have an **ENGINE START/STOP** button instead of an ignition switch.

Fuel Information

■ Fuel recommendation

Unleaded gasoline, pump octane number 87 or higher

Use of lower octane gasoline can cause a persistent, heavy metallic knocking noise that can lead to engine damage.

■ Top tier detergent gasoline

Because the level of detergency and additives in gasoline vary in the market, Honda endorses the use of “TOP TIER Detergent Gasoline” where available to help maintain the performance and reliability of your vehicle. TOP TIER Detergent Gasoline meets a new gasoline standard jointly established by leading automotive manufacturers to meet the needs of today’s advanced engines.

Qualifying gasoline retailers will, in most cases, identify their gasoline as having met “TOP TIER Detergent Gasoline” standards at the retail location. This fuel is guaranteed to contain the proper level of detergent additives and be free of metallic additives. The proper level of detergent additives, and absence of harmful metallic additives in gasoline, help avoid build-up of deposits in your engine and emission control system.

For further important fuel-related information for your vehicle, or on information on gasoline that does not contain MMT, visit www.hondacars.com. In Canada, visit www.honda.ca for additional information on gasoline. For more information on top tier gasoline, visit www.toptiergas.com.

⌘ Fuel Information

NOTICE

We recommend quality gasoline containing detergent additives that help prevent fuel system and engine deposits. In addition, in order to maintain good performance, fuel economy, and emissions control, we strongly recommend the use of gasoline that does NOT contain harmful manganese-based fuel additives such as MMT, if such gasoline is available.

Use of gasoline with these additives may adversely affect performance, and cause the malfunction indicator lamp on your instrument panel to come on. If this happens, contact a dealer for service.

Some gasoline today is blended with oxygenates such as ethanol. Your vehicle is designed to operate on oxygenated gasoline containing up to 15% ethanol by volume. Do not use gasoline containing methanol. If you notice any undesirable operating symptoms, try another service station or switch to another brand of gasoline.

■ Fuel tank capacity: 15.3 US gal (58 liters)

How to Refuel

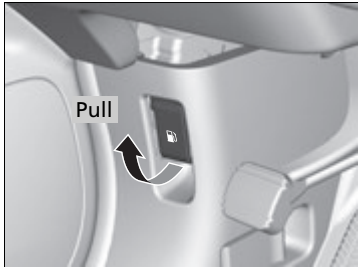

1. Stop your vehicle with the service station pump on the left side of the vehicle in the rear.
2. Turn off the engine.
3. Pull on the fuel fill door release handle under the lower left corner of the dashboard.
 - ▶ The fuel fill door opens.

How to Refuel

⚠ WARNING

Gasoline is highly flammable and explosive. You can be burned or seriously injured when handling fuel.

- Stop the engine, and keep heat, sparks, and flame away.
- Handle fuel only outdoors.
- Wipe up spills immediately.

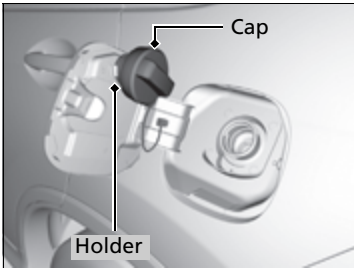
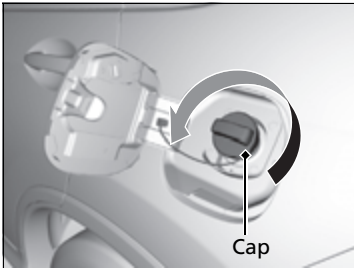

4. Remove the fuel fill cap slowly. If you hear a release of air, wait until this stops, then turn the knob slowly to open the fuel fill cap.

5. Place the fuel fill cap in the holder.

6. Insert the fuel filler nozzle fully.

▶ When the tank is full, the filler nozzle will click off automatically. This leaves space in the fuel tank in case the fuel expands with a change in the temperature.

7. After filling, replace the fuel fill cap, tightening it until you hear it click at least once.

▶ Shut the fuel fill door by hand.

How to Refuel

The filler nozzle automatically stops to leave space in the fuel tank so that fuel does not overflow as a result of changes in air temperature.

If the filler nozzle keeps turning off when the tank is not full, there may be a problem with the pump's fuel vapor recovery system. Try filling at another pump. If this does not fix the problem, consult a dealer.

Do not continue to add fuel after the filler nozzle has automatically stopped. Additional fuel can exceed the full tank capacity.

Improving Fuel Economy

Fuel economy depends on several conditions, including driving conditions, your driving habits, the condition of your vehicle, and loading. Depending on these and other conditions, you may or may not achieve the rated fuel economy of this vehicle.

Maintenance and Fuel Economy

You can optimize your fuel economy with proper maintenance of your vehicle. Always maintain your vehicle in accordance with the messages displayed on the information display*/multi-information display*/intelligent multi-information display (i-MID).

- Use the recommended viscosity engine oil, displaying the API Certification Seal.
- Maintain the specified tire pressure.
- Do not load the vehicle with excess cargo.
- Keep your vehicle clean. A buildup of snow or mud on your vehicle's underside adds weight and increases wind resistance.

Improving Fuel Economy

Direct calculation is the recommended method to determine actual fuel consumed while driving.

$$\begin{array}{ccccccc} \boxed{\text{Miles driven}} & \div & \boxed{\text{Gallons of fuel}} & = & \boxed{\text{Miles per Gallon}} \\ \boxed{100} & \times & \boxed{\text{Liter}} & \div & \boxed{\text{Kilometers}} & = & \boxed{\text{L per 100 km}} \end{array}$$

In Canada, posted fuel economy numbers are established following a simulated test. For more information on how this test is performed, please visit <http://oee.nrcan.gc.ca/>

Accessories

When installing accessories, check the following:

- Do not install accessories on the windshield. They can obstruct your view and delay your reaction to driving conditions.
- Do not install any accessories over areas marked SRS Airbag, on the sides or backs of the front seats, on front or side pillars, or near the side windows. Accessories installed in these areas may interfere with proper operation of the vehicle's airbags or may be propelled into you or another occupant if the airbags deploy.
- Be sure electronic accessories do not overload electrical circuits or interfere with proper operation of your vehicle.
 - **Fuses** P. 513
- Before installing any electronic accessory, have the installer contact a dealer for assistance. If possible, have a dealer inspect the final installation.

Modifications

Do not modify your vehicle or use non-Honda components that can affect its handling, stability, and reliability.

Overall vehicle performance can be affected. Always make sure all equipment is properly installed and maintained, and that it meets federal, state, province, territory, and local regulations.

Accessories and Modifications

⚠ WARNING

Improper accessories or modifications can affect your vehicle's handling, stability, and performance, and cause a crash in which you can be seriously hurt or killed.

Follow all instructions in this owner's manual regarding accessories and modifications.

Honda Genuine accessories are recommended to ensure proper operation on your vehicle.

Maintenance

This chapter discusses basic maintenance.



- Before Performing Maintenance**
- Inspection and Maintenance 436
- Safety When Performing Maintenance...437
- Parts and Fluids Used in Maintenance Service 438
- Maintenance Minder™** 439
- Maintenance Under the Hood**
- Maintenance Items Under the Hood.. 450
- Opening the Hood 451
- Recommended Engine Oil 452
- Oil Check 453
- Adding Engine Oil 454
- Changing the Engine Oil and Oil Filter ...455

- Engine Coolant 457
- Transmission Fluid 459
- Brake Fluid 460
- Refilling Window Washer Fluid..... 461
- Replacing Light Bulbs** 462
- Checking and Maintaining Wiper Blades**... 471
- Checking and Maintaining Tires**
- Checking Tires 475
- Tire and Loading Information Label 476
- Tire Labeling 476
- DOT Tire Quality Grading (U.S. Vehicles).. 478
- Wear Indicators..... 480
- Tire Service Life 480

- Tire and Wheel Replacement 481
- Tire Rotation 482
- Winter Tires 483
- Battery**..... 484
- Remote Transmitter Care**
- Replacing the Button Battery 485
- Heating and Cooling System*/Climate Control System* Maintenance**..... 487
- Cleaning**
- Interior Care 488
- Exterior Care..... 490

* Not available on all models

Inspection and Maintenance

For your safety, perform all listed inspections and maintenance to keep your vehicle in good condition. If you become aware of any abnormality (noise, smell, insufficient brake fluid, oil residue on the ground, etc.), have your vehicle inspected by a dealer. (Note, however, that service at a dealer is not mandatory to keep your warranties in effect.)

Types of Inspection and Maintenance

■ Daily inspections

Perform inspections before long distance trips, when washing the vehicle, or when refueling.

■ Periodic inspections

- Check the brake fluid level monthly.
 - **Checking the Brake Fluid** P. 460
- Check the tire pressure monthly. Examine the tread for wear and foreign objects.
 - **Checking and Maintaining Tires** P. 475
- Check the operation of the exterior lights monthly.
 - **Replacing Light Bulbs** P. 462
- Check the condition of the wiper blades at least every six months.
 - **Checking and Maintaining Wiper Blades** P. 471

Inspection and Maintenance

U.S. models

Maintenance, replacement, or repair of emissions control devices and systems may be done by any automotive repair establishment or individuals using parts that are “certified” to EPA standards.

According to state and federal regulations, failure to perform maintenance on the maintenance main items marked with # will not void your emissions warranties. However, all maintenance services should be performed in accordance with the intervals indicated by the information display*/multi-information display*/intelligent multi-information display (i-MID).

➤ **Maintenance Service Items** P. 444

If you want to perform complex maintenance tasks that require more skills and tools, you can purchase a subscription to the Service Express website at www.techno.honda.com.

➤ **Authorized Manuals** P. 529

If you want to perform maintenance yourself, make sure that you have the necessary tools and skills first. After performing maintenance, update the records in the separate maintenance booklet.

Safety When Performing Maintenance

Some of the most important safety precautions are given here. However, we cannot warn you of every conceivable hazard that can arise in performing maintenance. Only you can decide whether or not you should perform a given task.

Maintenance Safety

- To reduce the possibility of fire or explosion, keep cigarettes, sparks, and flames away from the battery and all fuel related parts.
- Never leave rags, towels, or other flammable objects under the hood.
 - ▶ Heat from the engine and exhaust can ignite them causing a fire.
- To clean parts, use a commercially available degreaser or parts cleaner, not gasoline.
- Wear eye protection and protective clothing when working with the battery or compressed air.
- Engine exhaust contains carbon monoxide, which is poisonous and can kill you.
 - ▶ Operate the engine only when there is sufficient ventilation.

Vehicle Safety

- The vehicle must be in a stationary condition.
 - ▶ Make sure your vehicle is parked on level ground, the parking brake is set, and the engine is off.
- Be aware that hot parts can burn you.
 - ▶ Make sure to let the engine and exhaust system cool thoroughly before touching vehicle parts.
- Be aware that moving parts can injure you.
 - ▶ Do not start the engine unless instructed, and keep your hands and limbs away from moving parts.

⚠ Safety When Performing Maintenance

⚠ WARNING

Improperly maintaining this vehicle or failing to correct a problem before driving can cause a crash in which you can be seriously hurt or killed.

Always follow the inspection and maintenance recommendations according to the schedules in this owner's manual.

⚠ WARNING

Failure to properly follow maintenance instructions and precautions can cause you to be seriously hurt or killed.

Always follow the procedures and precautions in this owner's manual.

Parts and Fluids Used in Maintenance Service

The use of Honda genuine parts and fluids is recommended when maintaining and servicing your vehicle. Honda genuine parts are manufactured according to the same high quality standards used in Honda vehicles.

If the engine oil life is less than 15%, you will see the Maintenance Minder messages appear on the information display*/multi-information display* and the i-MID every time you turn the ignition switch to ON [II]*1. The messages notify you when to change the engine oil, or when to bring your vehicle to a dealer for indicated maintenance services.

To Use Maintenance Minder™

■ Displaying the Engine Oil Life on the Information Display*

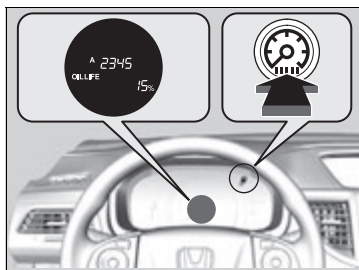

1. Turn the ignition switch to ON [II]*1.
2. Press the [RECALL] (Select/Reset) knob repeatedly until the engine oil life appears on the information display.

The Maintenance Minder indicator () stays on in the instrument panel after the engine oil life becomes 0%. Have the indicated maintenance done by a dealer immediately.

*1: Models with the smart entry system have an **ENGINE START/STOP** button instead of an ignition switch.

* Not available on all models

▣ To Use Maintenance Minder™

Based on the engine operating conditions, the remaining engine oil life is calculated and displayed as a percentage.

| Displayed Engine Oil Life (%) | Calculated Engine Oil Life (%) |
|-------------------------------|--------------------------------|
| 100 | 100 to 91 |
| 90 | 90 to 81 |
| 80 | 80 to 71 |
| 70 | 70 to 61 |
| 60 | 60 to 51 |
| 50 | 50 to 41 |
| 40 | 40 to 31 |
| 30 | 30 to 21 |
| 20 | 20 to 16 |
| 15 | 15 to 11 |
| 10 | 10 to 6 |
| 5 | 5 to 1 |
| 0 | 0 |

There is a list of maintenance main and sub items you can view on the i-MID.

▣ **Maintenance Service Items** P. 444

■ Displaying the Engine Oil Life on the Multi-Information Display*

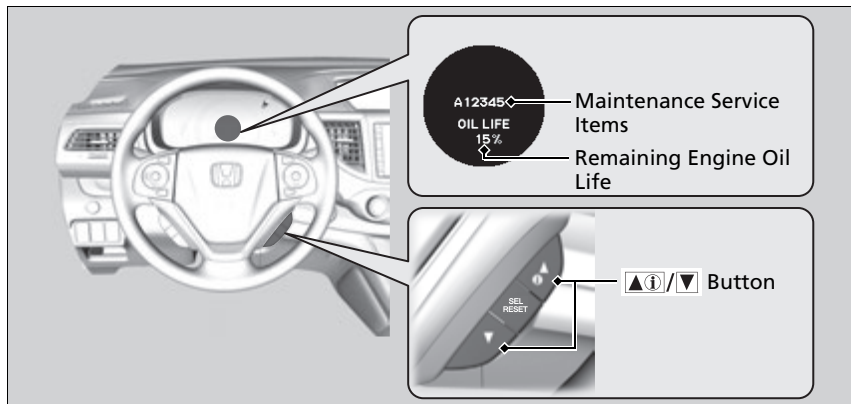

1. Set the power mode to ON.
2. Press the  button repeatedly until the engine oil life appears on the multi-information display.

■ Displaying the Engine Oil Life and Maintenance Items on the i-MID

Maintenance items, which should be serviced at the same time that you replace the engine oil, appear on the i-MID.

You can view them on the **Maintenance info** screen at any time.



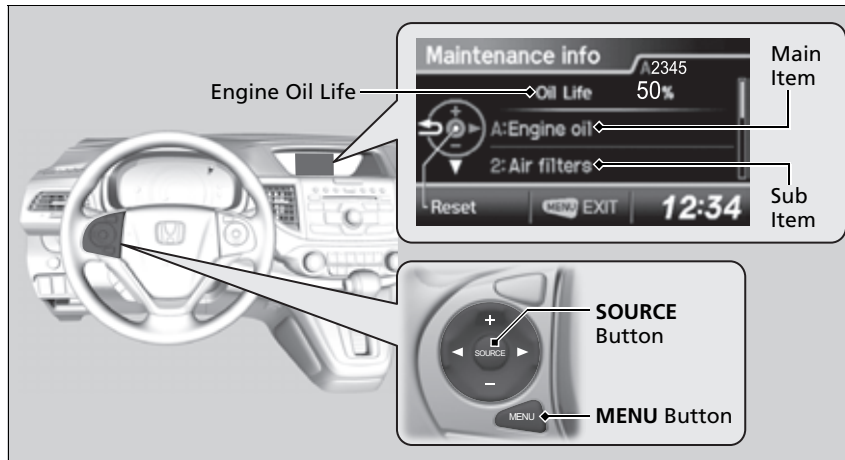

1. Turn the ignition switch to ON *1.
2. Press the **MENU** button to go to the **Vehicle Menu** screen.
3. Select **Vehicle Information**, then press the **SOURCE** button.
4. Press the **SOURCE** button again to go to the **Maintenance info** screen. The engine oil life appears on the i-MID.



*1: Models with the smart entry system have an **ENGINE START/STOP** button instead of an ignition switch.

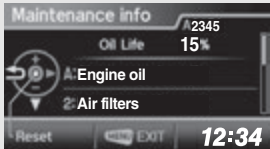

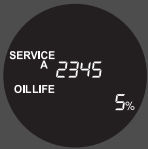
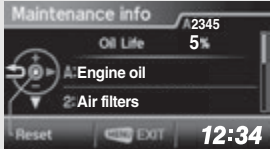





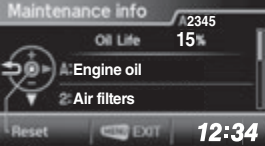

Continued

■ Maintenance Minder Messages on the i-MID and Information Display*

| Oil Life Display on the Information Display | Oil Life Display | Explanation | Information | Maintenance Minder Indicator |
|---|--|--|---|--|
|  | <p>15%</p>  | <p>The engine oil life indicator starts to appear along with other due soon maintenance item codes when the remaining oil life becomes 15 percent.</p> | <p>The engine oil is approaching the end of its service life.</p> |  |
|  | <p>5%</p>  | <p>The SERVICE message also starts to appear along with the engine oil life indicator and the maintenance item codes.</p> | <p>The engine oil has almost reached the end of its service life, and the maintenance items should be inspected and serviced as soon as possible.</p> | <p>Starts to come on when the remaining engine oil life becomes 15 percent. It goes off when the display is switched.</p> |
|  | <p>—</p> | <p>The remaining engine oil life has passed its service life, and a negative distance appears after driving over 10 miles (U.S. models) or 10 km (Canadian models). The negative distance on the display blinks.</p> | <p>The engine oil life has passed. The maintenance items must be inspected and serviced immediately.</p> |  <p>Stays on as a reminder even when the display is switched.</p> |

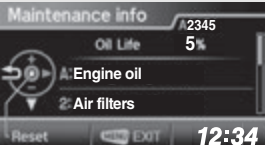
Maintenance

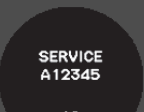
Maintenance Minder Messages on the i-MID and Multi-Information Display*

| Maintenance Message | Oil Life Display on the Multi-Information Display | Oil Life Display | Explanation | Information |
|--|---|--|--|---|
| <p>SERVICE DUE SOON</p>  |  | <p>15%</p>  | <p>The remaining engine oil life is 15 to 6 percent. Once you switch the display by pressing the /▼ button, this message will go off.</p> | <p>The engine oil is approaching the end of its service life, and the maintenance items should be inspected and serviced soon.</p> |
| <p>SERVICE DUE NOW</p>  |  | <p>5%</p>  | <p>The remaining engine oil life is 5 to 1 percent. Press the /▼ button to switch to another display.</p> | <p>The engine oil has almost reached the end of its service life, and the maintenance items should be inspected and serviced as soon as possible.</p> |
| <p>SERVICE PAST DUE</p>  |  | <p>—</p> | <p>The remaining engine oil life has passed its service life, and a negative distance appears after driving over 10 miles (U.S. models) or 10 km (Canadian models). Press the /▼ button to switch to another display.</p> | <p>The engine oil life has passed. The maintenance items must be inspected and serviced immediately.</p> |

The system message indicator () comes on along with the Maintenance Minder message.

* Not available on all models

Maintenance Service Items

Models with information display

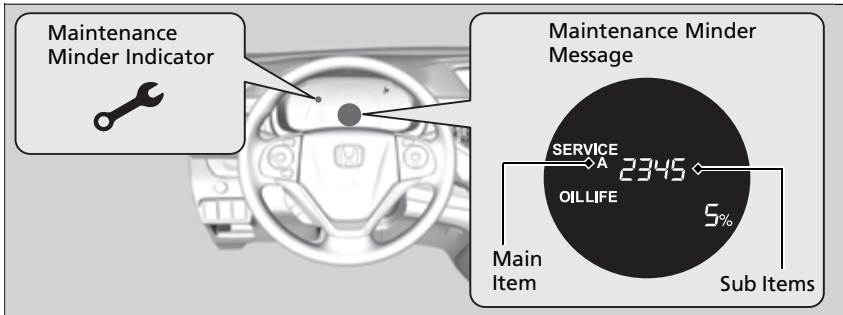

Models with multi-information display

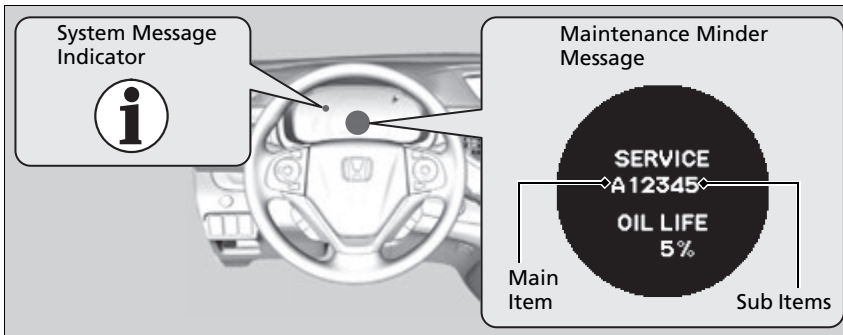

Maintenance Service Items

- Independent of the Maintenance Minder information, replace the brake fluid every 3 years.
- Inspect idle speed every 160,000 miles (256,000 km).
- Adjust the valves during services A, B, 1, 2, or 3 if they are noisy.

| CODE | Maintenance Main Items |
|------|--|
| A | <ul style="list-style-type: none"> • Replace engine oil*¹ |
| B | <ul style="list-style-type: none"> • Replace engine oil*¹ and oil filter • Inspect front and rear brakes • Check parking brake adjustment • Inspect tie rod ends, steering gearbox, and boots • Inspect suspension components • Inspect driveshaft boots • Inspect brake hoses and lines (Including ABS/VSA) • Inspect all fluid levels and condition of fluids • Inspect exhaust system[#] • Inspect fuel lines and connections[#] |

*1: If a message **SERVICE** does not appear more than 12 months after the display is reset, change the engine oil every year.

#: See information on maintenance and emissions warranty.

| CODE | Maintenance Sub Items |
|------|---|
| 1 | <ul style="list-style-type: none"> • Rotate tires |
| 2 | <ul style="list-style-type: none"> • Replace air cleaner element*² • Replace dust and pollen filter*³ • Inspect drive belt |
| 3 | <ul style="list-style-type: none"> • Replace transmission fluid*⁴ |
| 4 | <ul style="list-style-type: none"> • Replace spark plugs • Inspect valve clearance |
| 5 | <ul style="list-style-type: none"> • Replace engine coolant |
| 6 | <ul style="list-style-type: none"> • Replace rear differential fluid* |

*2: If you drive in dusty conditions, replace the air cleaner element every 15,000 miles (24,000 km).

*3: If you drive primarily in urban areas that have high concentrations of soot in the air from industry and from diesel-powered vehicles, replace the dust and pollen filter every 15,000 miles (24,000 km).



*4: Driving in mountainous areas at very low vehicle speeds or trailer towing results in higher transmission temperatures. This requires transmission fluid changes more frequently than recommended by the Maintenance Minder. If you regularly drive your vehicle under these conditions, have the transmission fluid changed every 25,000 miles (40,000 km).

Resetting the Display

Reset the engine oil life display if you have performed the maintenance service.

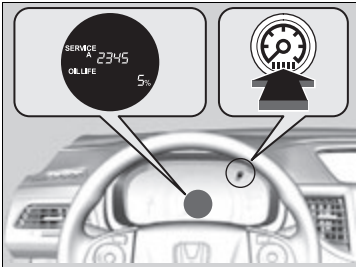
Models with information display



1. Turn the ignition switch to ON **II***1.
2. Display the engine oil life by repeatedly pressing the  (Select/Reset) knob.
3. Press and hold the  knob for 10 seconds or more.
 - The engine oil life indicator and the maintenance item codes blink.
4. Press the  knob for five seconds or more.
 - The displayed maintenance items disappear, and the engine oil life display returns to 100%.

Resetting the Display

NOTICE

Failure to reset the engine oil life after a maintenance service results in the system showing incorrect maintenance intervals, which can lead to serious mechanical problems.

The dealer will reset the engine oil life display after completing the required maintenance service. If someone other than a dealer performs maintenance service, reset the engine oil life display yourself.

Models with multi-information display

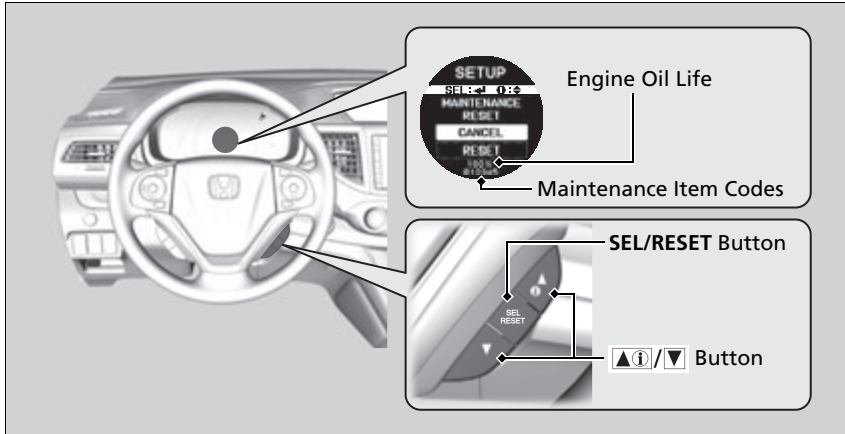

1. Set the power mode to ON.
 2. Select **VEHICLE SETTINGS** using the ▲①/▼ button, then press the **SEL/RESET** button.
 3. Select **MAINTENANCE RESET** using the ▲①/▼ button, then press the **SEL/RESET** button.
 4. Select **RESET** using the ▲①/▼ button, then press the **SEL/RESET** button.
 - ▶ The service code will disappear and the engine oil life display will return to 100%.
- To cancel the oil life reset mode, select **CANCEL**, then press the **SEL/RESET** button.

All models

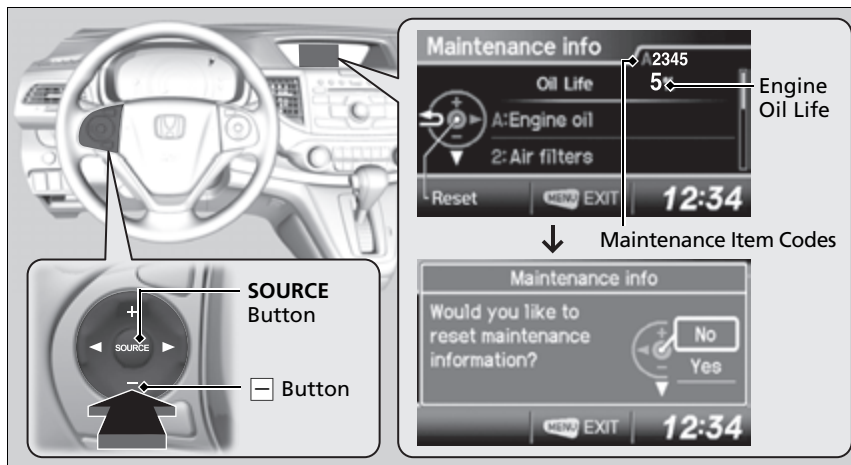

1. Turn the ignition switch to ON *1.
2. Go to the **Maintenance info** screen.
 - ▶ **Displaying the Engine Oil Life and Maintenance Items on the i-MID** P. 441
3. Press the **SOURCE** button.
 - ▶ The oil life reset mode is displayed on the i-MID.

*1: Models with the smart entry system have an **ENGINE START/STOP** button instead of an ignition switch.

4. Select **Yes** with the button, then press the **SOURCE** button.

- ▶ The displayed maintenance items disappear, and the engine oil life display returns to 100%.
- ▶ Any maintenance items that are necessary for your vehicle at the next maintenance service will appear.

To cancel the oil life reset mode, select **No**, then press the **SOURCE** button.

Maintenance Items Under the Hood

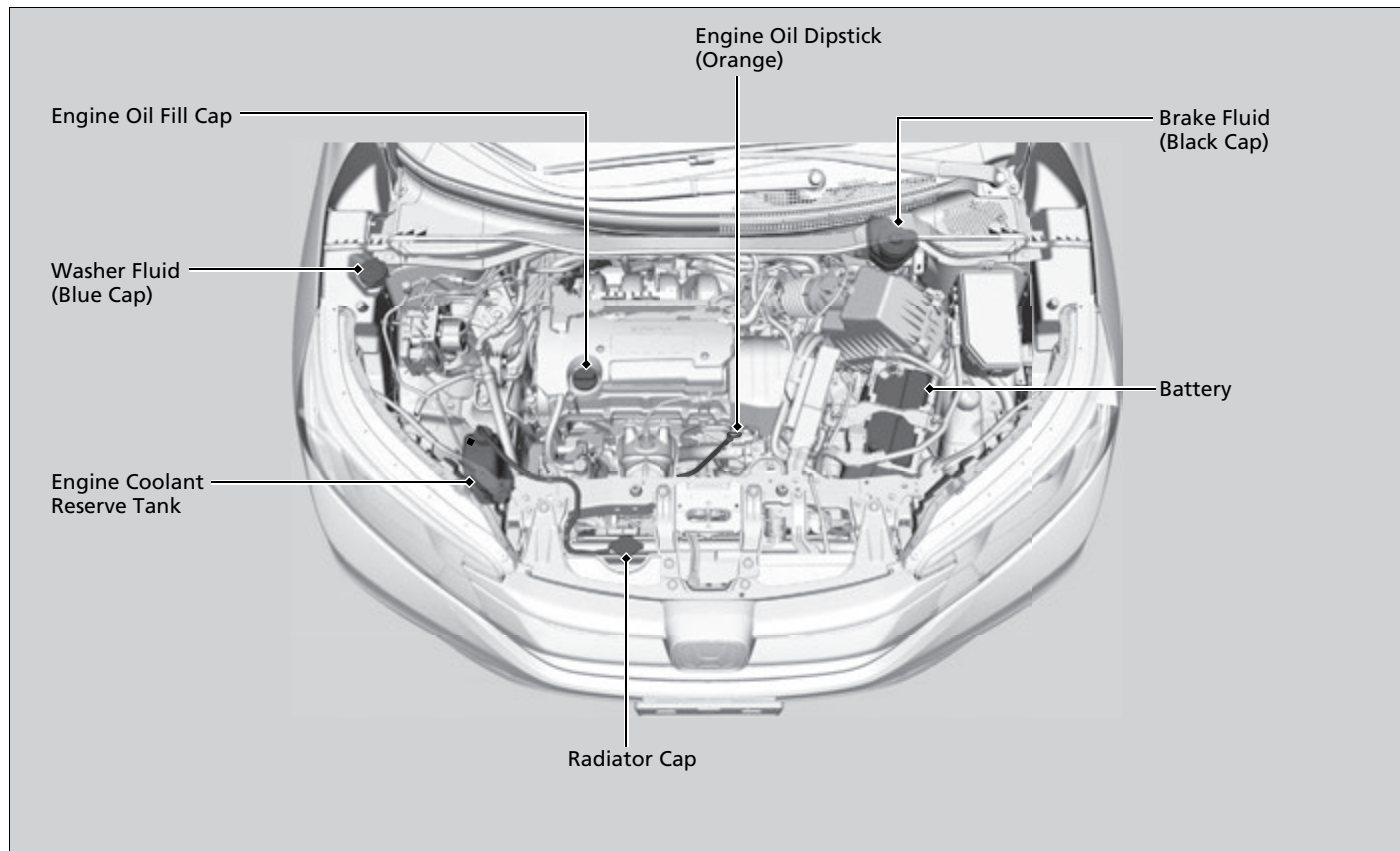

Opening the Hood

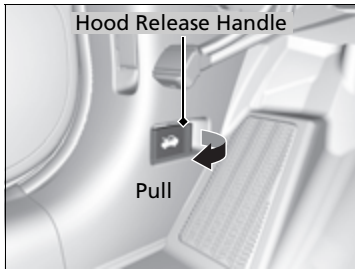

1. Park the vehicle on level ground, and set the parking brake.
2. Pull the hood release handle under the lower left corner of the dashboard.
 - The hood will pop up slightly.

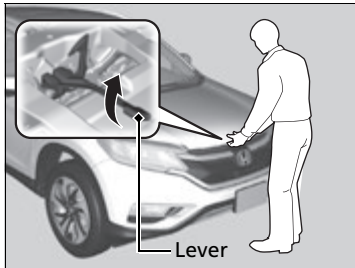

3. Pull the hood latch lever in the center of the hood back to release the lock mechanism, and open the hood.

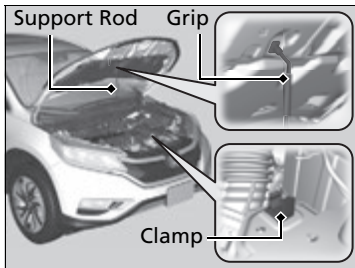

4. Remove the support rod from the clamp using the grip. Mount the support rod in the hood.

When closing, remove the support rod, and stow it in the clamp, then gently lower the hood. Remove your hand at a height of approximately 12 inches (30 cm) and let the hood close.

Opening the Hood

NOTICE

Do not open the hood when the wiper arms are raised. The hood will strike the wipers, and may damage either the hood or the wipers.

When closing the hood, check that the hood is securely latched.

If the hood latch lever moves stiffly, or if you can open the hood without lifting the lever, the latch mechanism should be cleaned and lubricated.

Recommended Engine Oil

- **Genuine Honda Motor Oil**
- **Premium-grade 0W-20 detergent oil with an API Certification Seal on the container.**



Oil is a major contributor to your engine's performance and longevity. If you drive the vehicle with insufficient or deteriorated oil, the engine may fail or be damaged.

This seal indicates the oil is energy conserving and that it meets the American Petroleum Institute's latest requirements.

Use a Genuine Honda Motor Oil or another commercial engine oil of suitable viscosity for the ambient temperature as shown here.

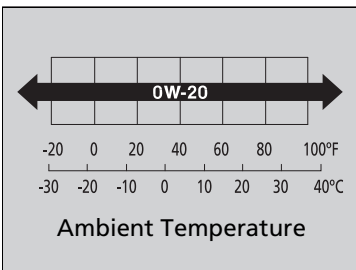

■ Synthetic oil

You may also use synthetic motor oil if it is labeled with the API Certification Seal and is the specified viscosity grade.

►► Recommended Engine Oil

Engine Oil Additives

Your vehicle does not require oil additives. In fact, they may adversely affect the engine performance and durability.

Oil Check

We recommend that you check the engine oil level every time you refuel.

Park the vehicle on level ground.

Wait approximately three minutes after turning the engine off before you check the oil.

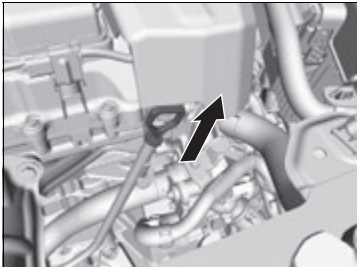

- 1. Remove the dipstick (orange handle).
- 2. Wipe the dipstick with a clean cloth or paper towel.
- 3. Insert the dipstick back all the way into its hole.

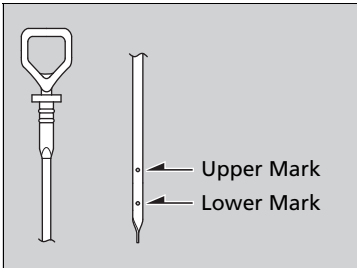

- 4. Remove the dipstick again, and check the level. It should be between the upper and lower marks. Add oil if necessary.

Oil Check

If the oil level is near or below the lower mark, slowly add oil being careful not to overfill.

Adding Engine Oil

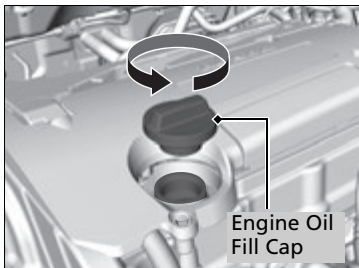

1. Unscrew and remove the engine oil fill cap.
2. Add oil slowly.
3. Reinstall the engine oil fill cap, and tighten it securely.
4. Wait for three minutes and recheck the engine oil dipstick.

► Adding Engine Oil

If any oil spills, wipe it away immediately. Spilled oil may damage the engine compartment components.

NOTICE

Do not fill the engine oil above the upper mark. Overfilling the engine oil can result in leaks and engine damage.

Changing the Engine Oil and Oil Filter

You must change the engine oil and oil filter regularly in order to maintain the engine's lubrication. The engine may be damaged if they are not changed regularly.

Change the oil and filter in accordance with the maintenance message on the information display*/multi-information display*/i-MID.

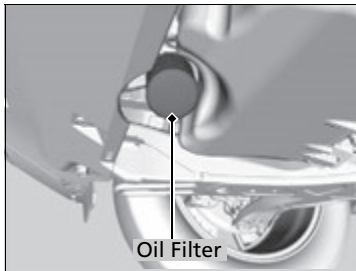
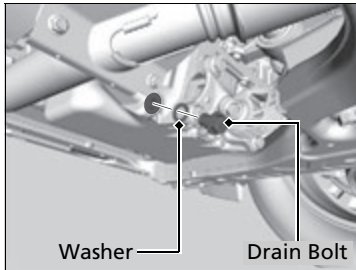

1. Run the engine until it reaches normal operating temperature, and then turn the engine off.
2. Open the hood and remove the engine oil fill cap.
3. Remove the drain bolt and washer from the bottom of the engine, and drain the oil into a suitable container.

Changing the Engine Oil and Oil Filter

NOTICE

You may damage the environment if you do not dispose of the oil in a suitable way. If you are changing the oil by yourself, appropriately dispose of the used oil. Put the oil in a sealed container and take it to a recycling center. Do not throw the oil away into a garbage can or onto the ground.

* Not available on all models

Continued

4. Remove the oil filter and dispose of the remaining oil.
5. Check that the filter gasket is not stuck to the engine contact surface.
 - If it is stuck, you must detach it.
6. Wipe away dirt and dust adhering to the contact surface of the engine block, and install a new oil filter.
 - Apply a light coat of new engine oil to the oil filter gasket.
7. Put a new washer on the drain bolt, then reinstall the drain bolt.
 - Tightening torque:
30 lbf·ft (40 N·m, 4.0 kgf·m)
8. Pour the recommended engine oil into the engine.
 - Engine oil change capacity (including filter):
4.6 US qt (4.4 L)
9. Reinstall the engine oil fill cap securely and start the engine.
10. Run the engine for a few minutes, and then check that there is no leak from the drain bolt or oil filter.
11. Stop the engine, wait for three minutes, and then check the oil level on the dipstick.
 - If necessary, add more engine oil.

✎ Changing the Engine Oil and Oil Filter

You will need a special wrench to replace the oil filter. You can buy this wrench from a dealer.

When installing the new oil filter, follow the instructions supplied with the oil filter.

Reinstall the engine oil fill cap. Start the engine. The low oil pressure indicator should go off within five seconds. If it does not, turn off the engine, and check your work.

Be sure to verify that the oil filter is designed for your vehicle. A genuine Honda oil filter is recommended for optimum lubrication flow and filtration properties to assure the reliability of the engine.

Engine Coolant

Specified coolant: Honda Long Life Antifreeze/Coolant Type 2

This coolant is premixed with 50% antifreeze and 50% water. Do not add any straight antifreeze or water.

We recommend you check the engine coolant level every time you refuel. Check the reserve tank first. If it is completely empty, also check the coolant level in the radiator. Add the engine coolant accordingly.

Reserve Tank

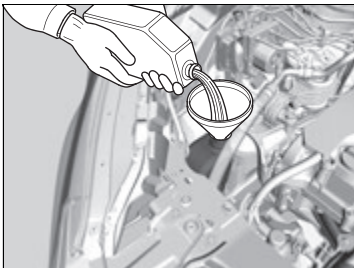
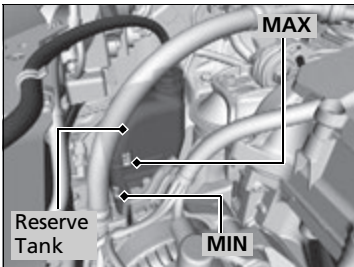

1. Check the amount of coolant in the reserve tank.

2. If the coolant level is below the **MIN** mark, add the specified coolant until it reaches the **MAX** mark.

3. Inspect the cooling system for leaks.

Engine Coolant

If Honda antifreeze/coolant is not available, you may use another major brand non-silicate coolant as a temporary replacement. Check that it is a high quality coolant recommended for aluminum engines.

Continued use of any non-Honda coolant can result in corrosion, causing the cooling system to malfunction or fail. Have the cooling system flushed and refilled with Honda antifreeze/coolant as soon as possible.

Do not add rust inhibitors or other additives to your vehicle's cooling system. They may not be compatible with the coolant or with the engine components.

Continued

Radiator

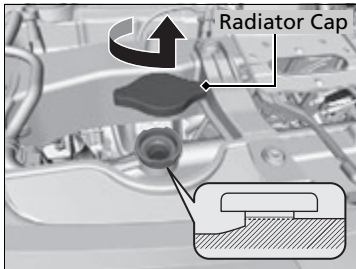

1. Make sure the engine and radiator are cool.
2. Turn the radiator cap counterclockwise to relieve any pressure in the cooling system. Do not push the cap down when turning.
3. Push down and turn the radiator cap counterclockwise to remove it.
4. The coolant level should be up to the base of the filler neck. Add coolant if it is low.
5. Put the radiator cap back on, and tighten it fully.
6. Pour coolant into the reserve tank until it reaches the **MAX** mark. Put the cap back on the reserve tank.

Radiator

WARNING

Removing the radiator cap while the engine is hot can cause the coolant to spray out, seriously scalding you.

Always let the engine and radiator cool down before removing the radiator cap.

NOTICE

Pour the fluid slowly and carefully so you do not spill any. Clean up any spills immediately; they can damage components in the engine compartment.

Transmission Fluid

■ Continuously Variable Transmission Fluid

Specified fluid: Honda HCF-2 Transmission Fluid

Have a dealer check the fluid level and replace if necessary.

⌘ Continuously Variable Transmission Fluid

NOTICE

Do not mix HCF-2 with other transmission fluids.

Using a transmission fluid other than HCF-2 may adversely affect the operation and durability of your vehicle's transmission, and damage the transmission. Any damage caused by using a transmission fluid that is not equivalent to HCF-2 is not covered by Honda's new vehicle warranty.

Brake Fluid

Specified fluid: Honda Heavy Duty Brake Fluid DOT 3

■ Checking the Brake Fluid

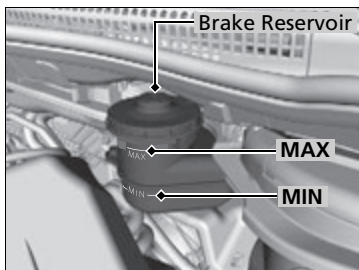

The fluid level should be between the **MIN** and **MAX** marks on the side of the reservoir.

►► Brake Fluid

NOTICE

Brake fluid marked DOT 5 is not compatible with your vehicle's braking system and can cause extensive damage.

If the specified brake fluid is not available, you should use only DOT 3 or DOT 4 fluid from a sealed container as a temporary replacement.

Using any non-Honda brake fluid can cause corrosion and decrease the longevity of the system. Have the brake system flushed and refilled with Honda Heavy Duty Brake Fluid DOT 3 as soon as possible.

If the brake fluid level is at or below the **MIN** mark, have a dealer inspect the vehicle for leaks or worn brake pad as soon as possible.

Refilling Window Washer Fluid

Check the amount of window washer fluid by looking at the reservoir.

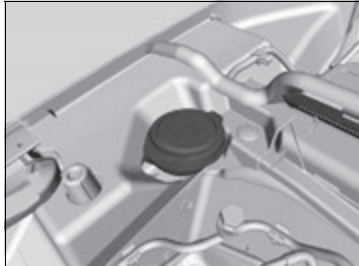

If the level is low, fill the washer reservoir.

Canadian models with information display

If the washer fluid is low, the washer level indicator comes on.

Canadian models with multi-information display

If the washer fluid is low, a message appears on the multi-information display.

Pour the washer fluid carefully. Do not overflow the reservoir.

⌘ Refilling Window Washer Fluid

NOTICE

Do not use engine antifreeze or a vinegar/water solution in the windshield washer reservoir. Antifreeze can damage your vehicle's paint. A vinegar/water solution can damage the windshield washer pump.

Headlight Bulbs

When replacing, use the following bulbs.

High beam headlight: 60 W (HB3)

Low beam headlight: 55 W (H11 for halogen bulb type)

High Beam Headlight

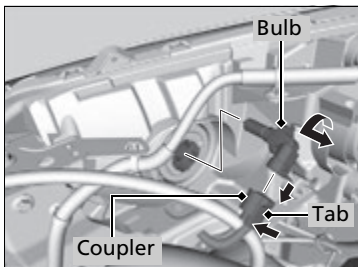

1. Push the tab to remove the coupler.
2. Rotate the old bulb to the left to remove.
3. Insert a new bulb into the headlight assembly and turn it to the right.
4. Insert the coupler into the connector of the bulb.

Headlight Bulbs

NOTICE

Halogen bulbs get very hot when lit. Oil, perspiration, or a scratch on the glass can cause the bulb to overheat and shatter.

The headlight aim is set by the factory, and does not need to be adjusted. However, if you regularly carry heavy items in the cargo area or tow a trailer, have the aiming readjusted at a dealer or by a qualified technician.

When replacing a halogen bulb, handle it by its base, and protect the glass from contact with your skin or hard objects. If you touch the glass, clean it with denatured alcohol and a clean cloth.

Low Beam Headlights

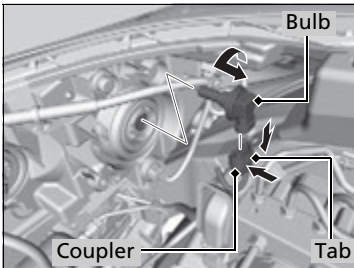

1. Push the tab to remove the coupler.
2. Rotate the old bulb to the left to remove.
3. Insert a new bulb into the headlight assembly and turn it to the right.
4. Insert the coupler into the connector of the bulb.

Fog Light Bulbs*

When replacing, use the following bulbs.

Fog Light: 35 W (H8 for halogen bulb type)

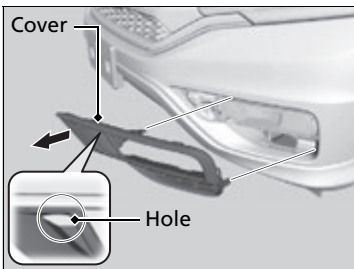

1. Pull the hole of the cover with your finger, then remove it.

⌘ Fog Light Bulbs*

NOTICE

Halogen bulbs get very hot when lit. Oil, perspiration, or a scratch on the glass can cause the bulb to overheat and shatter.

When replacing a halogen bulb, handle it by its plastic case, and protect the glass from contact with your skin or hard objects. If you touch the glass, clean it with denatured alcohol and a clean cloth.

* Not available on all models

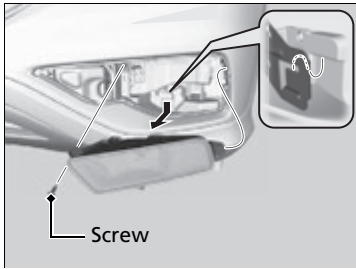

2. Remove the screw using a Phillips-head screwdriver and carefully pull the fog light assembly out of the bumper.

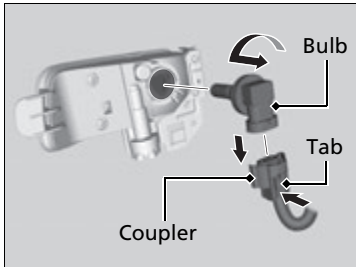

3. Push the tab to remove the coupler.
4. Rotate the old bulb to the left to remove.
5. Insert new bulb.

Models without smart entry system

Front Turn Signal/Side Marker Light/Parking Light Bulbs

When replacing, use the following bulbs.

Front Turn Signal/Side Marker Light/Parking Light: 28/8 W (Amber)

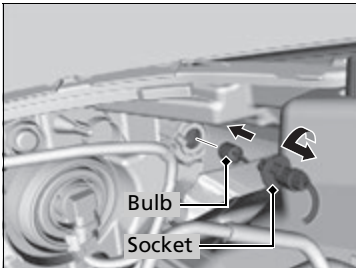

1. Turn the socket to the left and remove it, then remove the old bulb.
2. Insert a new bulb.

Models with smart entry system

Front Turn Signal/Side Marker Light Bulbs

When replacing, use the following bulbs.

Front Turn Signal/Side Marker Light: 28/8 W (Amber)

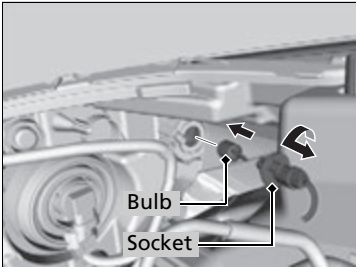

1. Turn the socket to the left and remove it, then remove the old bulb.
2. Insert a new bulb.

Models with smart entry system

Parking Lights

Parking lights are LED type. Have an authorized Honda dealer inspect and replace the light assembly.

Side Turn Signal/Emergency Indicator Lights*

Side turn signal lights are LED type. Have an authorized Honda dealer inspect and replace the light assembly.

Brake Light, Taillight, Back-Up Light, Rear Turn Signal Light and Lower Rear Side Marker Light Bulbs

When replacing, use the following bulbs.

Lower Rear Side Marker/Brake/Taillight: 21/5 W
Back-Up Light: 21 W
Rear Turn Signal Light: 21 W (Amber)

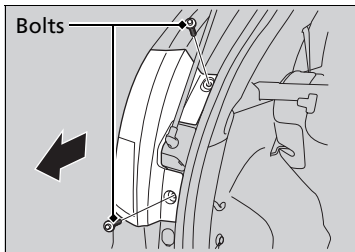

1. Use a Phillip-head screwdriver to remove the bolts.
2. Pull the light assembly out of the rear pillar.

☒ Brake Light, Taillight, Back-Up Light, Rear Turn Signal Light and Lower Rear Side Marker Light Bulbs

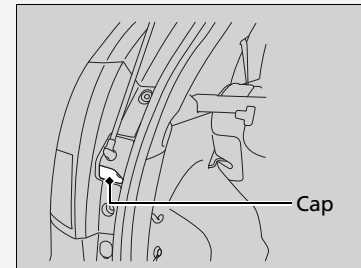

If it is difficult to remove the light assembly, remove the cap.

* Not available on all models

Continued

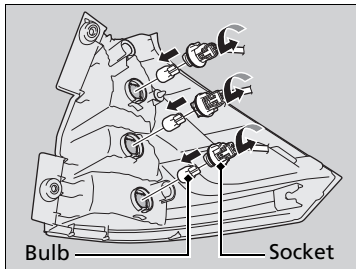

3. Turn the socket to the left and remove it.
Remove the old bulb.
4. Insert a new bulb.

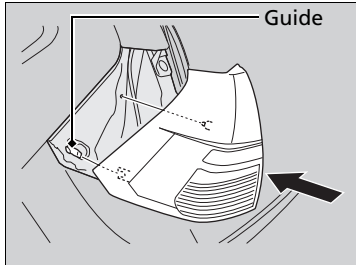

5. Reinstall the light assembly by sliding it on to the guide on the body.

Upper Rear Side Marker/Taillight Bulbs

When replacing, use the following bulbs.

Upper Rear Side Marker/Taillight: 3 CP

1. Remove the lower taillight assembly.

➤ **Brake Light, Taillight, Back-Up Light, Rear Turn Signal Light and Lower Rear Side Marker Light Bulbs** P. 467

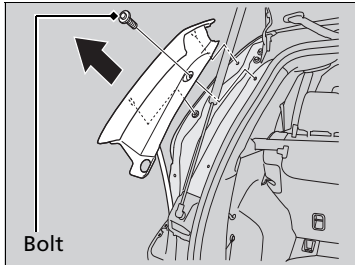

2. Use a Phillip-head screwdriver to remove the bolt.
3. Pull the light assembly out of the rear pillar.

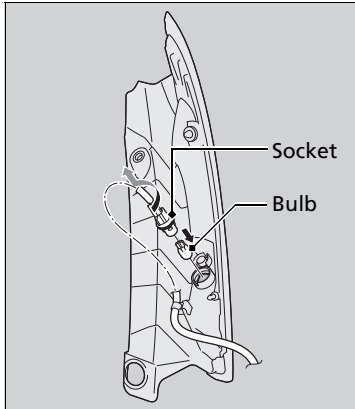

4. Turn the socket to the left and remove it. Remove the old bulb.
5. Insert a new bulb.

Rear License Plate Light Bulb

When replacing, use the following bulb.

Rear License Plate Light: 3 CP

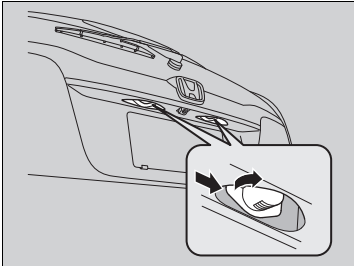

1. Push the left edge of the lens to the right and pull out the license light assembly.

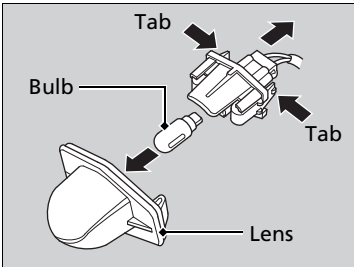

2. Push the tabs to remove the lens.
3. Remove the old bulb.
4. Insert a new bulb.

High-Mount Brake Light

High-mount brake light is LED type. Have an authorized Honda dealer inspect and replace the light assembly.

Checking Wiper Blades

If the wiper blade rubber has deteriorated, it will leave streaks and the hard surfaces of the blade may scratch the window glass.

Changing the Front Wiper Blade Rubber

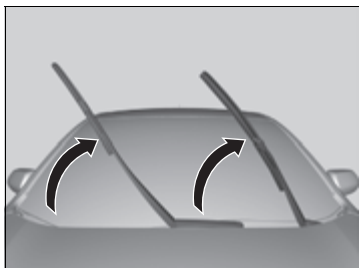

1. Lift the driver side wiper arm first, then the passenger side.

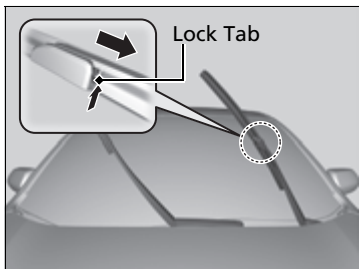

2. Push the lock tab up.
3. Slide the blade holder from the wiper arm.

Changing the Front Wiper Blade Rubber

NOTICE

Avoid dropping the wiper arm; it may damage the windshield.

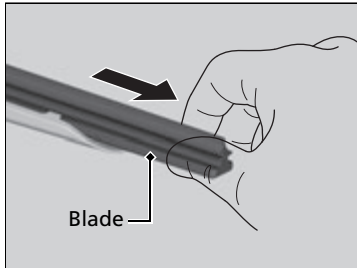

4. Slide the wiper blade out from its holder by pulling the tabbed end out.

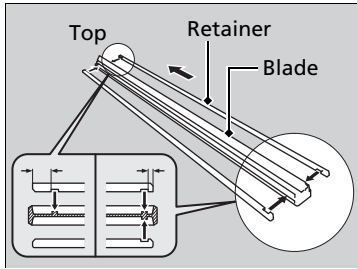

5. Remove the retainers from the rubber blade that has been removed, and mount to a new rubber blade.
 - ▶ Correctly align the rubber protrusion and the retainer grooves.

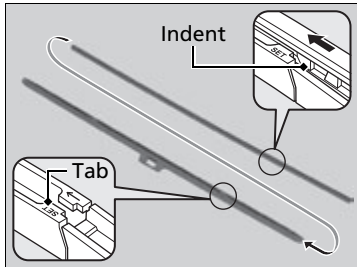

6. Slide the new wiper blade onto the holder from the bottom end.
 - ▶ The tab on the holder should fit in the indent of the wiper blade.
7. Attach the wiper holder to the wiper arm until the lock tab clicks into place.
8. Lower the passenger side wiper arm first, then the driver side.

Changing the Rear Wiper Blade Rubber



1. Raise the rear wiper arm up and away from the rear window.

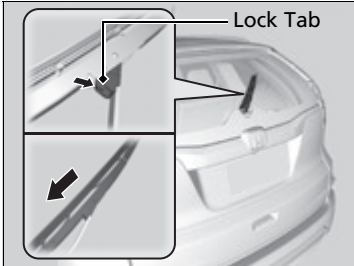

2. Pull up the lock tab and slide the blade holder from the wiper arm.

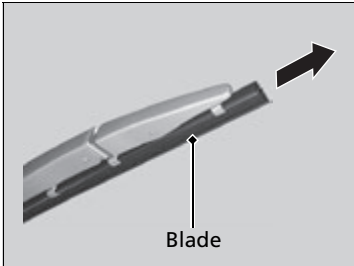

3. Slide the wiper blade out from the open end.

Changing the Rear Wiper Blade Rubber

NOTICE

Avoid dropping the wiper arm; it may damage the rear window.

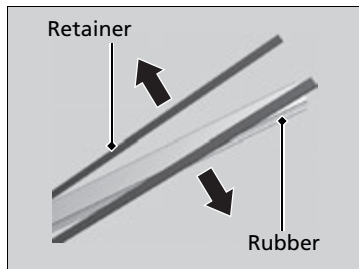

4. Remove the retainers from wiper blade and mount to a new rubber blade.



5. Slide the wiper blade onto the holder.
▶ Make sure it is engaged correctly, then install the wiper blade assembly onto the wiper arm.

Checking Tires

To safely operate your vehicle, your tires must be of the proper type and size, in good condition with adequate tread, and properly inflated.

■ Inflation guidelines

Properly inflated tires provide the best combination of handling, tread life, and comfort. Refer to the driver's doorjamb label or specification's page for the specified pressure.

Underinflated tires wear unevenly, adversely affect handling and fuel economy, and are more likely to fail from overheating.

Overinflated tires make your vehicle ride harshly, are more prone to road hazards, and wear unevenly.

Every day before you drive, look at each of the tires. If one looks lower than the others, check the pressure with a tire gauge.

At least once a month or before long trips, use a gauge to measure the pressure in all tires, including the spare. Even tires in good condition can lose 1 to 2 psi (10 to 20 kPa, 0.1 to 0.2 kgf/cm²) per month.

■ Inspection guidelines

Every time you check inflation, also examine the tires and valve stems. Look for:

- Bumps or bulges on the side or in the tread. Replace the tire if you find any cuts, splits, or cracks in the side of the tire. Replace it if you see fabric or cord.
- Remove any foreign objects and inspect for air leaks.
- Uneven tread wear. Have a dealer check the wheel alignment.
- Excessive tread wear.

➤ **Wear Indicators** P. 480

- Cracks or other damage around valve stem.

☒ Checking Tires

⚠ WARNING

Using tires that are excessively worn or improperly inflated can cause a crash in which you can be seriously hurt or killed.

Follow all instructions in this owner's manual regarding tire inflation and maintenance.

Measure the air pressure when tires are cold. This means the vehicle has been parked for at least three hours, or driven less than 1 mile (1.6 km). If necessary, add or release air until the specified pressure is reached.

If checked when hot, tire pressure can be as much as 4–6 psi (30–40 kPa, 0.3–0.4 kgf/cm²) higher than if checked when cold.

Have a dealer check the tires if you feel a consistent vibration while driving. New tires and any that have been removed and reinstalled should be properly balanced.

Tire and Loading Information Label

The label attached to the driver’s doorjamb provides necessary tire and loading information.

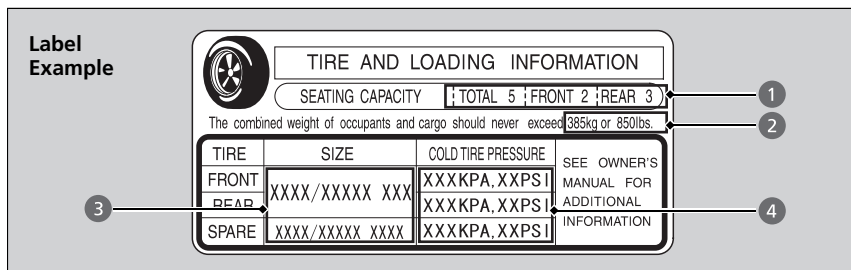

▶▶ Tire and Loading Information Label

The tire and loading information label attached to the driver’s doorjamb contains:

- 1 The number of people your vehicle can carry.
- 2 The total weight your vehicle can carry. Do not exceed this weight.
- 3 The original tire sizes for front, rear, and spare.
- 4 The proper cold tire pressure for front, rear, and spare.

Tire Labeling

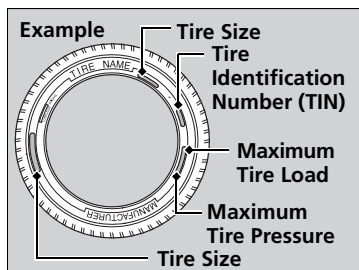

The tires that came on your vehicle have a number of markings. Those you should be aware of are described below.

▶▶ Tire Sizes

Following is an example of tire size with an explanation of what each component means.

215/70R16 100S

215: Tire width in millimeters.

70: Aspect ratio (the tire’s section height as a percentage of its width).

R: Tire construction code (R indicates radial).

16: Rim diameter in inches.

100: Load index (a numerical code associated with the maximum load the tire can carry).

S: Speed symbol (an alphabetical code indicating the maximum speed rating).

Tire Sizes

Whenever tires are replaced, they should be replaced with tires of the same size.

■ Tire Identification Number (TIN)

The tire identification number (TIN) is a group of numbers and letters that look like the example in the side column. TIN is located on the sidewall of the tire.

■ Glossary of Tire Terminology

Cold Tire Pressure – The tire air pressure when the vehicle has been parked for at least three hours or driven less than 1 mile (1.6 km).

Load Rating – Means the maximum load that a tire is rated to carry for a given inflation pressure.

Maximum Inflation Pressure – The maximum tire air pressure that the tire can hold.

Maximum Load Rating – Means the load rating for a tire at the maximum permissible inflation pressure for that tire.

Recommended Inflation Pressure – The cold tire inflation pressure recommended by the manufacturer.

Treadwear Indicators (TWI) – Means the projections within the principal grooves designed to give a visual indication of the degrees of wear of the tread.

☒ Tire Identification Number (TIN)

DOT B97R FW6X 2209

DOT: This indicates that the tire meets all requirements of the U.S. Department of Transportation.

B97R: Manufacturer's identification mark.

FW6X: Tire type code.

22 09: Date of manufacture.

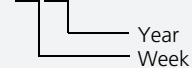

DOT Tire Quality Grading (U.S. Vehicles)

The tires on your vehicle meet all U.S. Federal Safety Requirements. All tires are also graded for treadwear, traction, and temperature performance according to Department of Transportation (DOT) standards. The following explains these gradings.

■ Uniform Tire Quality Grading

Quality grades can be found where applicable on the tire sidewall between tread shoulder and maximum section width.

■ Treadwear

The treadwear grade is a comparative rating based on the wear rate of the tire when tested under controlled conditions on a specified government test course. For example, a tire graded 150 would wear one and one-half (1 1/2) times as well on the government course as a tire graded 100. The relative performance of tires depends upon the actual conditions of their use, however, and may depart significantly from the norm due to variations in driving habits, service practices and differences in road characteristics and climate.

▣ Uniform Tire Quality Grading

For example:

Treadwear 200
Traction AA
Temperature A

All passenger car tires must conform to Federal Safety Requirements in addition to these grades.

■ Traction

The traction grades, from highest to lowest, are AA, A, B, and C. Those grades represent the tire's ability to stop on wet pavement as measured under controlled conditions on specified government test surfaces of asphalt and concrete. A tire marked C may have poor traction performance.

■ Temperature

The temperature grades are A (the highest), B, and C, representing the tire's resistance to the generation of heat and its ability to dissipate heat when tested under controlled conditions on a specified indoor laboratory test wheel. Sustained high temperature can cause the material of the tire to degenerate and reduce tire life, and excessive temperature can lead to sudden tire failure. The grade C corresponds to a level of performance which all passenger car tires must meet under the Federal Motor Vehicle Safety Standard No. 109. Grades B and A represent higher levels of performance on the laboratory test wheel than the minimum required by law.

⌘ Traction

Warning: The traction grade assigned to this tire is based on straight-ahead braking traction tests, and does not include acceleration, cornering, hydroplaning, or peak traction characteristics.

⌘ Temperature

Warning: The temperature grade for this tire is established for a tire that is properly inflated and not overloaded. Excessive speed, underinflation, or excessive loading, either separately or in combination, can cause heat buildup and possible tire failure.

Wear Indicators

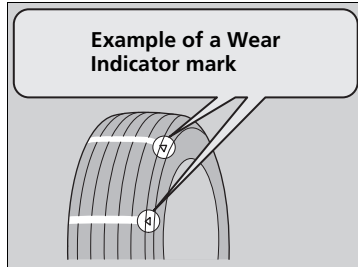

The groove where the wear indicator is located is 1/16 inch (1.6 mm) shallower than elsewhere on the tire. If the tread has worn so that the indicator is exposed, replace the tire.

Worn out tires have poor traction on wet roads.

Tire Service Life

The life of your tires is dependent on many factors, including driving habits, road conditions, vehicle loading, inflation pressure, maintenance history, speed, and environmental conditions (even when the tires are not in use).

In addition to regular inspections and inflation pressure maintenance, it is recommended that you have annual inspections performed once the tires reach five years old. All tires, including the spare, should be removed from service after 10 years from the date of manufacture, regardless of their condition or state of wear.

Tire and Wheel Replacement

Replace your tires with radials of the same size, load range, speed rating, and maximum cold tire pressure rating (as shown on the tire's sidewall). Using tires of a different size or construction can cause the ABS, vehicle stability assist (VSA®), hill start assist, and the AWD* system to work incorrectly.

It is best to replace all four tires at the same time. If that isn't possible, replace the front or rear tires in pairs.

Make sure that the wheel's specifications match those of the original wheels.

⚠ Tire and Wheel Replacement

⚠ WARNING

Installing improper tires on your vehicle can affect handling and stability. This can cause a crash in which you can be seriously hurt or killed.

Always use the size and type of tires recommended in this owner's manual.

* Not available on all models

Tire Rotation

Rotating tires according to the maintenance messages on the information display*/multi-information display*/intelligent multi-information display (i-MID) helps to distribute wear more evenly and increase tire life.

■ Tires without rotation marks

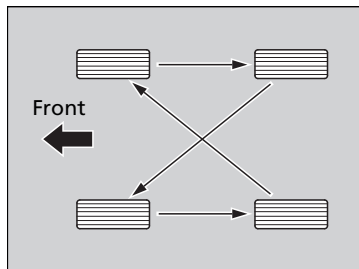

Rotate the tires as shown here.

■ Tires with rotation marks

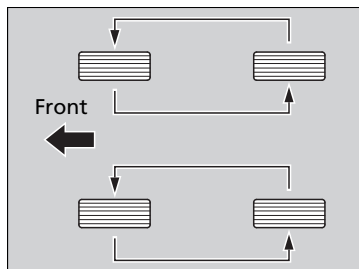

Rotate the tires as shown here.

▶▶ Tire Rotation

Tires with directional tread patterns should only be rotated front to back (not from one side to the other). Directional tires should be mounted with the rotation indication mark facing forward, as shown below.

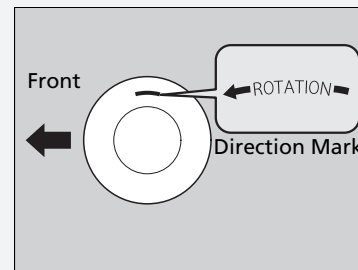

Winter Tires

If driving on snowy or frozen roads, mount all season marked “M+S” tires, snow tires, or tire chains; reduce speed; and maintain sufficient distance between vehicles when driving.

Be particularly careful when operating the steering wheel or brakes to prevent skidding.

Use tire chains, snow tires, or all season tires when necessary or according to the law.

When mounting, refer to the following points.

For winter tires:

- Select the size and load ranges that are the same as the original tires.
- Mount the tires to all four wheels.

For tire chains:

- Install them on the front tires only.
- Because your vehicle has limited tire clearance, we strongly recommend using the chains listed below:

Models with 215/70R16 tires

Cable-type: SCC Radial Chain SC1042

Models with 225/65R17 or P225/60R18 99H tires

Cable-type: SCC Radial Chain TC2111MM

- Follow the chain manufacturer's instruction when installing. Mount them as tightly as you can.
- Check that the chains do not touch the brake lines or suspension.
- Drive slowly.

Winter Tires

⚠ WARNING

Using the wrong chains, or not properly installing chains, can damage the brake lines and cause a crash in which you can be seriously injured or killed.

Follow all instructions in this owner's manual regarding the selection and use of tire chains.

NOTICE

Traction devices that are the wrong size or improperly installed can damage your vehicle's brake lines, suspension, body, and wheels. Stop driving if they are hitting any part of the vehicle.

When tire chains are mounted, follow the chain manufacturer's instructions regarding vehicle operational limits.

If your vehicle is equipped with summer tires, be aware that these tires are not designed for winter driving conditions. For more information, contact a dealer.

Checking the Battery

Check the battery condition monthly and check the terminals for corrosion.

If your vehicle's battery is disconnected or goes dead:

- The audio system is disabled.
 - **Reactivating the audio system** P. 213
- The clock resets.
 - **Clock** P. 130
- The navigation system* is disabled.
 - **Refer to the navigation system manual**

Charging the Battery

Disconnect both battery cables to prevent damaging your vehicle's electrical system. Always disconnect the negative (-) cable first, and reconnect it last.

ⓘ Battery

WARNING

The battery gives off explosive hydrogen gas during normal operation.

A spark or flame can cause the battery to explode with enough force to kill or seriously hurt you.

When conducting any battery maintenance, wear protective clothing and a face shield, or have a skilled technician do it.

WARNING: Battery post, terminals, and related accessories contain lead and lead compounds.

Wash your hands after handling.

When you find corrosion, clean the battery terminals by applying a baking powder and water solution. Clean the terminals with a damp towel. Cloth/towel dry the battery. Coat the terminals with grease to help prevent future corrosion.

When replacing the battery, the replacement must be of the same specifications.

Please consult a dealer for more information.

Replacing the Button Battery

If the indicator does not come on when the button is pressed, replace the battery.

Master Keys with Remote Transmitter*

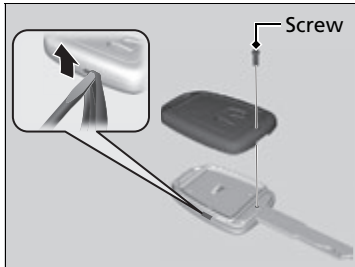

Battery type: CR1620

1. Unscrew the cover with a small Phillips-head screwdriver.
2. Open the remote transmitter.
 - ▶ Wrap the small flat-tip screwdriver with a cloth to prevent scratching the transmitter.
3. Remove the button battery with the small flat-tip screwdriver.
4. Make sure to replace the battery with the correct polarity.

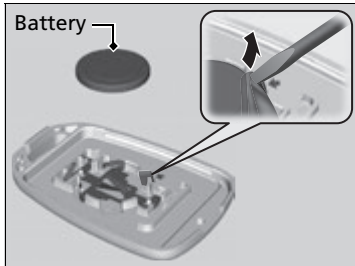

Replacing the Button Battery

NOTICE

An improperly disposed of battery can damage the environment. Always confirm local regulations for battery disposal.

Replacement batteries are commercially available or at a dealer.

* Not available on all models

■ Smart Entry Remote *



Battery type: CR2032

1. Remove the built-in key.

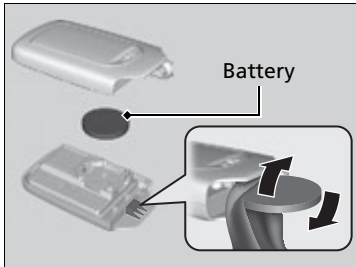

2. Remove the upper half of the cover by carefully prying on the edge with a coin.

▶ Remove carefully to avoid losing the buttons.

▶ Wrap a coin with a cloth to prevent scratching the smart entry remote.

3. Make sure to replace the battery with the correct polarity.

Dust and Pollen Filter

The heating and cooling system*/climate control system* is equipped with a dust and pollen filter that collects pollen, dust, and other debris in the air. The Maintenance Minder™ messages will let you know when to replace the filter.

We recommend that you replace the dust and pollen filter sooner when using your vehicle in areas with high concentrations of dust.

☒ Dust and Pollen Filter

If the airflow from the heating and cooling system*/climate control system* deteriorates noticeably, and the windows fog up easily, the filter may need to be replaced. Please contact a dealer for replacement.

* Not available on all models

Interior Care

Use a damp cloth with a mixture of mild detergent and warm water to remove dirt. Use a clean cloth to remove detergent residue.

■ Cleaning Seat Belts

Use a soft brush with a mixture of mild soap and warm water to clean the seat belts. Let the belts air dry. Wipe the openings of the seat belt anchors using a clean cloth.

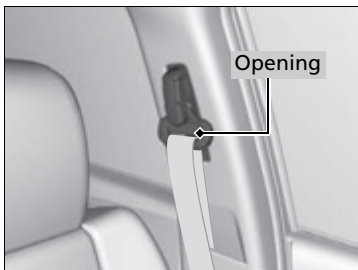

■ Cleaning the Window

Wipe using a glass cleaner.

» Interior Care

Do not spill liquids inside the vehicle. Electrical devices and systems may malfunction if liquids are splashed on them.

Do not use silicone based sprays on electrical devices such as audio devices and switches. Doing so may cause the items to malfunction or a fire inside the vehicle. If a silicone based spray is inadvertently used on electrical devices, consult a dealer.

Depending on their composition, chemicals and liquid aromatics may cause discoloration, wrinkles, and cracking to resin-based parts and textiles. Do not use alkali solvents or organic solvents such as benzene or gasoline.

After using chemicals, make sure to gently wipe them away using a dry cloth. Do not place used cloths on top of resin based parts or textiles for long periods of time without washing.

» Cleaning the Window

Wires are mounted to the inside of the rear window. Wipe along the same direction as the wires with a soft cloth so as not to damage them.

■ Floor Mats

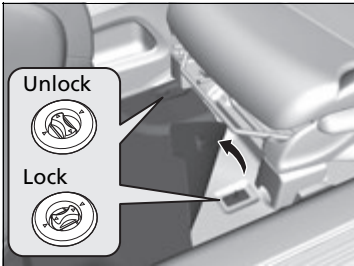

The driver's floor mat hooks over the floor anchors, which keep the mat from sliding forward. To remove a mat for cleaning, turn the anchor knobs to the unlock position. When reinstalling the mat after cleaning, turn the knobs to the lock position.

Do not put additional floor mats on top of the anchored mat.

■ Maintaining Genuine Leather*

Vacuum dirt and dust from the leather frequently. Pay close attention to the pleats and seams. Clean the leather with a soft cloth dampened with a 90% water and 10% neutral soap solution. Then buff it with a clean, dry cloth. Remove any dust or dirt on leather surfaces immediately.

▣ Floor Mats

If you use any floor mats that were not originally provided with your vehicle, make sure they are designed for your specific vehicle, fit correctly, and are securely anchored by the floor anchors. Position the rear seat floor mats properly. If they are not properly positioned, the floor mats can interfere with the front seat functions.

* Not available on all models

Exterior Care

Dust off the vehicle body after you drive.

Regularly inspect your vehicle for scratches on painted surfaces. A scratch on a painted surface can result in body rust. If you find a scratch, promptly repair it.

■ Washing the Vehicle

Wash the vehicle regularly. Wash more frequently when driving in the following conditions:

- If driving on roads with road salt.
- If driving in coastal areas.
- If tar, soot, bird droppings, insects, or tree sap are stuck to painted surfaces.

■ Using an Automated Car Wash

- Remove the audio antenna.
 - ▣ **Audio Antenna** P. 212
- Fold in the door mirrors.
- Turn off the automatic intermittent wipers*.

Make sure to follow the instructions indicated on the automated car wash.

■ Using High Pressure Cleaners

- Keep sufficient distance between the cleaning nozzle and the vehicle body.
- Take particular care around the windows. Standing too close may cause water to enter the vehicle interior.
- Do not spray high pressure water directly into the engine compartment. Instead, use low pressure water and a mild detergent.

▣ Washing the Vehicle

Do not spray water into the air intake vents. It can cause a malfunction.

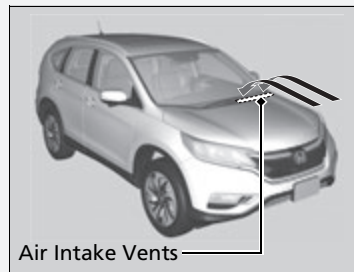

■ Applying Wax

A good coat of automotive body wax helps protect your vehicle's paint from the elements. Wax will wear off over time and expose your vehicle's paint to the elements, so reapply as necessary.

■ Maintaining the Bumpers and Other Resin Coated Parts

If you get gasoline, oil, engine coolant, or battery fluid on resin coated parts, they may be stained or the coating may peel. Promptly wipe it away using a soft cloth and clean water.

■ Cleaning the Window

Wipe using a glass cleaner.

■ Maintaining Aluminum Wheels*

Aluminum is susceptible to deterioration caused by salt and other road contaminants. Use a sponge and mild detergent to wipe away promptly. Be careful not to use harsh chemicals (including some commercial wheel cleaners) or a stiff brush. They can damage the clear coat of the aluminum alloy wheels that helps keep the aluminum from corroding and tarnishing.

* Not available on all models

Continued

☒ Applying Wax

NOTICE

Chemical solvents and strong cleaners can damage the paint, metal, and plastic on your vehicle. Wipe away spills immediately.

☒ Maintaining the Bumpers and Other Resin Coated Parts

Ask a dealer about the correct coating material when you want to repair the painted surface of the parts made of resin.

■ Fogged Exterior Light Lenses

The inside lenses of exterior lights (headlights, brake lights, etc.) may fog temporarily if you have driven in the rain, or after the vehicle has been run through a car wash. Dew condensation also may build up inside the lenses when there is a significant enough difference between the ambient and inside lens temperatures (similar to vehicle windows fogging up in rainy conditions). These conditions are natural processes, not structural design problems in the exterior lights.

Lens design characteristics may result in moisture developing on the light lens frame surfaces. This also is not a malfunction.

However, if you see large amounts water accumulation, or large water drops building up inside the lenses, have your vehicle inspected by a dealer.

Handling the Unexpected

This chapter explains how to handle unexpected troubles.

Tools

Types of Tools..... 494

If a Tire Goes Flat

Changing a Flat Tire..... 495

Engine Does Not Start

Checking the Engine..... 501

If the Smart Entry Remote Battery is

Weak..... 502

Emergency Engine Stop..... 503

Jump Starting..... 504

Shift Lever Does Not Move..... 506

Overheating

How to Handle Overheating..... 507

Indicator, Coming On/Blinking

If the Low Oil Pressure Indicator Comes

On..... 509

If the Charging System Indicator Comes

On..... 509

If the Malfunction Indicator Lamp Comes

On or Blinks..... 510

If the Brake System Indicator (Red) Comes

On..... 511

If the Electric Power Steering (EPS) System

Indicator Comes On..... 511

If the Low Tire Pressure/TPMS Indicator

Comes On or Blinks..... 512

Fuses

Fuse Locations..... 513

Inspecting and Changing Fuses..... 515

Emergency Towing..... 516

When You Cannot Open the Tailgate..517

Types of Tools

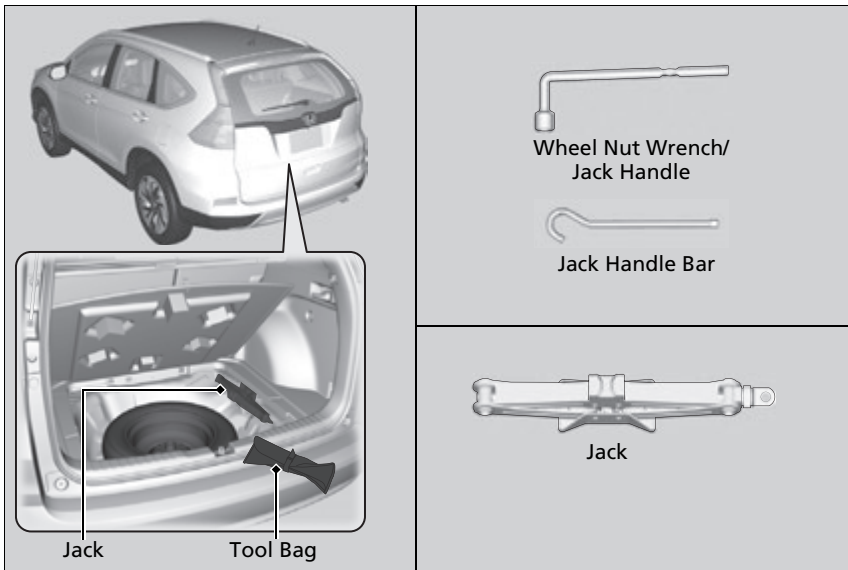

Types of Tools

The tools are stored in the cargo area.

Changing a Flat Tire

If a tire goes flat while driving, grasp the steering wheel firmly, and brake gradually to reduce speed. Then, stop in a safe place. Replace the flat tire with a compact spare tire. Go to a dealer as soon as possible to have the full-size tire repaired or replaced.

1. Park the vehicle on firm, level, and non-slippery and apply the parking brake.
2. Move the shift lever to **P**.
3. Turn on the hazard warning lights and turn the ignition switch to LOCK **0***1.

*1: Models with the smart entry system have an **ENGINE START/STOP** button instead of an ignition switch.

Changing a Flat Tire

Periodically check the tire pressure of the compact spare. It should be set to the specified pressure.
Specified Pressure: 60 psi (420 kPa, 4.2 kgf/cm²)

When driving with the compact spare tire, keep the vehicle speed under 50 mph (80 km/h). Replace with a full-size tire as soon as possible.

The compact spare tire and wheel in your vehicle are specifically for this model. Do not use them with another vehicle. Do not use another type of compact spare tire or wheel with your vehicle.

Do not mount tire chains on a compact spare tire. If a chain-mounted front tire goes flat, remove one of the full-size rear tires and replace it with the compact spare tire. Remove the flat front tire and replace it with the full-size tire that was removed from the rear. Mount the tire chains on the front tire.

Continued

■ Getting Ready to Replace the Flat Tire

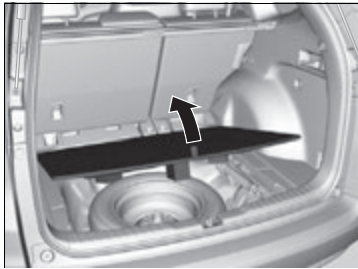

1. Open the cargo area floor lid.

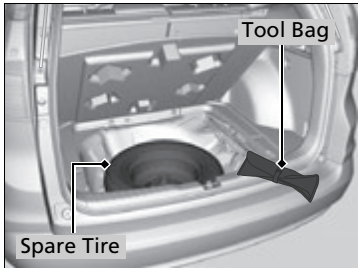

2. Take the tool bag out of the cargo area.
Take the wheel nut wrench and jack handle bar out of the tool bag.

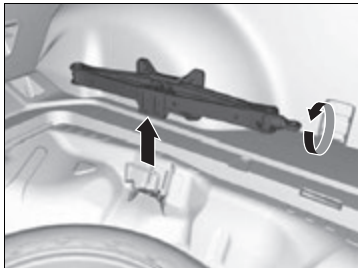

3. Take the jack out of the spare tire area.
4. Unscrew the wing bolt, and remove the spacer cone. Then, remove the spare tire.

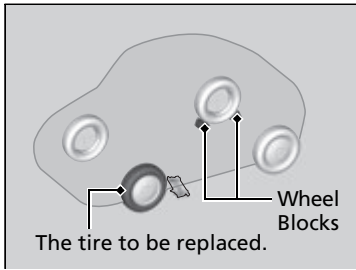

5. Place a wheel block or rock in front and rear of the wheel diagonal to the flat tire.

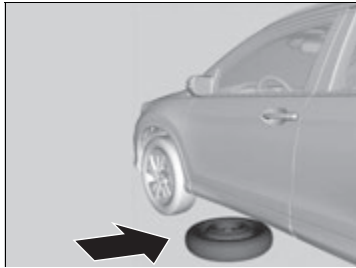

6. Place the compact spare tire wheel side up under the vehicle body, near the tire that needs to be replaced.



7. Loosen each wheel nut about one turn using the wheel nut wrench.

■ How to Set Up the Jack

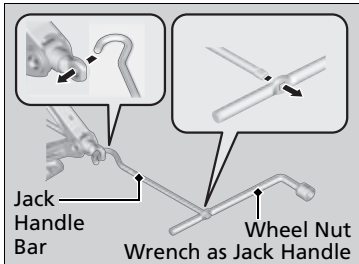
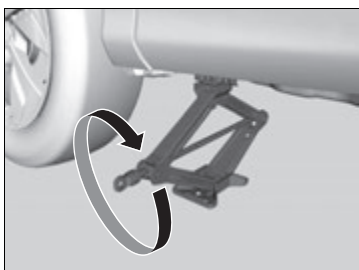
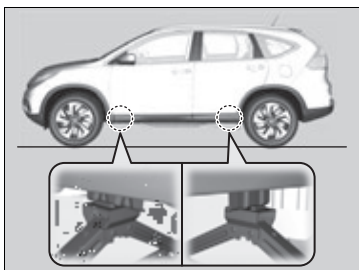

1. Place the jack under the jacking point closest to the tire to be changed.
2. Turn the end bracket clockwise as shown in the image until the top of the jack contacts the jacking point.
▶ Make sure that the jacking point tab is resting in the jack notch.
3. Raise the vehicle, using the jack handle bar and the jack handle, until the tire is off the ground.

🔧 How to Set Up the Jack

⚠️ WARNING

The vehicle can easily roll off the jack, seriously injuring anyone underneath.

Follow the directions for changing a tire exactly, and never get under the vehicle when it is supported only by the jack.

- Do not use the jack with people or luggage in the vehicle.
- Use the jack provided in your vehicle. Other jacks may not support the weight ("load") or may not fit the jacking point.
- The following instructions must be followed to use the jack safely:
- Do not use while the engine is running.
 - Use only where the ground is firm and level.
 - Use only at the jacking points.
 - Do not get in the vehicle while using the jack.
 - Do not put anything on top of or underneath the jack.

Replacing the Flat Tire

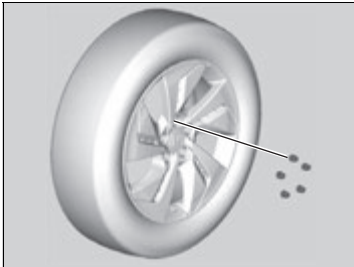

1. Remove the wheel nuts and flat tire.

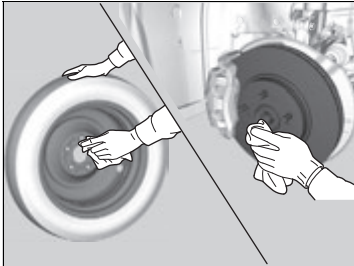

2. Wipe the mounting surfaces of the wheel with a clean cloth.

3. Mount the compact spare tire.

4. Screw the wheel nuts until they touch the lips around the mounting holes, then stop rotating.

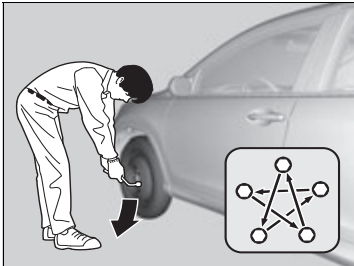

5. Lower the vehicle and remove the jack. Tighten the wheel nuts in the order indicated in the image. Go around, tightening the nuts, two to three times in this order.

Wheel nut torque:

80 lbf·ft (108 N·m, 11 kgf·m)

Replacing the Flat Tire

Do not over tighten the wheel nuts by applying extra torque using your foot or a pipe.

■ Storing the Flat Tire

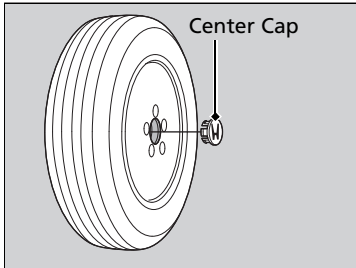

1. Remove the center cap.

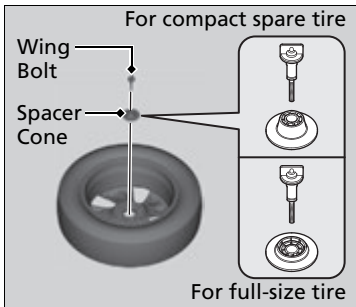

2. Place the flat tire face down in the spare tire well.
3. Remove the spacer cone from the wing bolt, flip it over, and insert it back on the bolt. Secure the flat tire with the wing bolt.
4. Securely store the wheel nut wrench and jack handle bar back in the tool bag. Store the bag in the cargo area.
5. Store the jack in its holder. Turn the jack's end bracket to lock it in place.

■ TPMS and the Spare Tire

If you replace a flat tire with the spare tire, the  comes on while you are driving. After driving for a few miles (kilometers), the indicator will start blinking for a short time and then stay on, but this is normal.

Calibrate the TPMS when you replace the tire with a specified regular tire.

▶ **TPMS Calibration** P. 408

▶▶ Storing the Flat Tire

WARNING

Loose items can fly around the interior in a crash and can seriously injure the occupants.
Store the wheel, jack, and tools securely before driving.

Checking the Engine

If the engine does not start, check the starter.

☒ Checking the Engine

If you must start the vehicle immediately, use an assisting vehicle to jump start it.

☒ **Jump Starting** P. 504

| Starter condition | Checklist |
|---|---|
| Starter doesn't turn or turns over slowly. The battery may be dead. Check each of the items on the right and respond accordingly. | Check for a message on the intelligent multi-information display (i-MID). <ul style="list-style-type: none">• If the TO START, HOLD REMOTE NEAR START BUTTON message appears<ul style="list-style-type: none">☒ If the Smart Entry Remote Battery is Weak P. 502▶ Make sure the smart entry remote is in its operating range.<ul style="list-style-type: none">☒ ENGINE START/STOP Button Operating Range P. 156 Check the brightness of the interior lights. <p>Turn on the interior lights and check the brightness.</p> <ul style="list-style-type: none">• If the interior lights are dim or do not come on at all<ul style="list-style-type: none">☒ Battery P. 484• If the interior lights come on normally ☒ Inspecting and Changing Fuses P. 515 |
| The starter turns over normally but the engine doesn't start. There may be a problem with the fuse. Check each of the items on the right and respond accordingly. | Review the engine start procedure. <p>Follow its instructions, and try to start the engine again. ☒ Starting the Engine P. 364</p> Check the immobilizer system indicator. <p>When the immobilizer system indicator is blinking, the engine cannot be started. ☒ Immobilizer System P. 149</p> Check the fuel level. <p>There should be enough fuel in the tank. ☒ Fuel Gauge P. 94</p> Check the fuse. <p>Check all fuses, or have the vehicle checked by a dealer. ☒ Inspecting and Changing Fuses P. 515</p> If the problem continues: <ul style="list-style-type: none">☒ Emergency Towing P. 516 |

If the Smart Entry Remote Battery is Weak

Models with smart entry system

If the beeper sounds, the indicator on the **ENGINE START/STOP** button flashes, and the engine won't start.

Models with intelligent multi-information display

The **TO START, HOLD REMOTE NEAR START BUTTON** message appears on the intelligent multi-information display (i-MID).

Start the engine as follows.

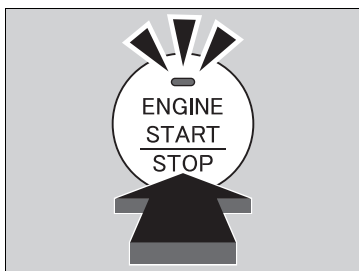
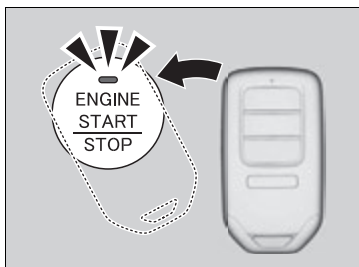

1. Touch the center of the **ENGINE START/STOP** button with the **H** logo on the smart entry remote while the indicator on the **ENGINE START/STOP** button is flashing. The buttons on the smart entry remote should be facing you.
 - ▶ The indicator flashes for about 30 seconds.
2. Depress the brake pedal and press the **ENGINE START/STOP** button within 10 seconds after the beeper sounds and the indicator changes from flashing to on.
 - ▶ If you don't depress the pedal, the mode will change to ACCESSORY.

Emergency Engine Stop

Models with smart entry system

The **ENGINE START/STOP** button may be used to stop the engine due to an emergency situation even while driving. If you must stop the engine, do either of the following operations:

- Press and hold the **ENGINE START/STOP** button for about two seconds.
- Firmly press the **ENGINE START/STOP** button twice.

The steering wheel will not lock. However, because turning off the engine disables the power assist the engine provides to the steering and braking systems, it will require significantly more physical effort and time to steer and slow the vehicle. Use both feet on the brake pedal to slow down the vehicle and stop immediately in a safe place.

The power mode is in ACCESSORY when the engine is stopped.

To change the mode to VEHICLE OFF, change the gear position to **P** after the vehicle comes to a complete stop.

Emergency Engine Stop

Do not press the button while driving unless it is absolutely necessary for the engine to be switched off.

Jump Starting Procedure

Turn off the power to electric devices, such as audio and lights. Turn off the engine, then open the hood.

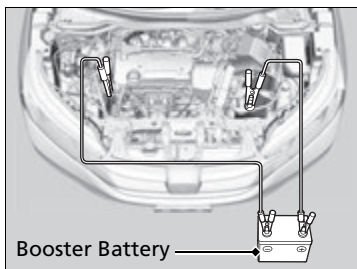

1. Connect the first jumper cable to your vehicle's \oplus terminal.
2. Connect the other end of the first jumper cable to the booster battery \oplus terminal.
 - ▶ Use a 12-volt booster battery only.
 - ▶ When using an automotive battery charger to boost your 12-volt battery, select a lower charging voltage than 15 volts. Check the charger manual for the proper setting.
3. Connect the second jumper cable to the booster battery \ominus terminal.
4. Connect the other end of the second jumper cable to the engine mounting bolt as shown. Do not connect this jumper cable to any other part.
5. If your vehicle is connected to another vehicle, start the assisting vehicle's engine and increase its rpm slightly.
6. Attempt to start your vehicle's engine. If it turns over slowly, check that the jumper cables have good metal-to-metal contact.

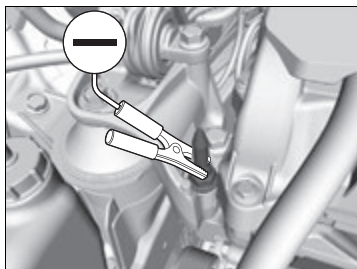

Jump Starting

WARNING

A battery can explode if you do not follow the correct procedure, seriously injuring anyone nearby.

Keep all sparks, open flames, and smoking materials away from the battery.

Securely attach the jumper cables clips so that they do not come off when the engine vibrates. Also be careful not to tangle the jumper cables or allow the cable ends to touch each other while attaching or detaching the jumper cables.

Battery performance degrades in cold conditions and may prevent the engine from starting.

■ What to Do After the Engine Starts

Once your vehicle's engine has started, remove the jumper cables in the following order.

1. Disconnect the jumper cable from your vehicle's ground.
2. Disconnect the other end of the jumper cable from the booster \ominus terminal.
3. Disconnect the jumper cable from your vehicle's \oplus terminal.
4. Disconnect the other end of the jumper cable from the booster \oplus terminal.

Have your vehicle inspected by a nearby service station or a dealer.

Shift Lever Does Not Move

Follow the procedure below if you cannot move the shift lever out of the **P** position.

Releasing the Lock

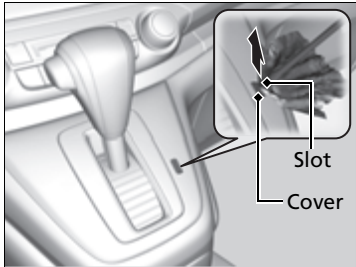

1. Set the parking brake.

Models without smart entry system

2. Remove the key from the ignition switch.

Models with smart entry system

2. Remove the built-in key from the smart entry remote.

All models

3. Wrap a cloth around the tip of a small flat-tip screwdriver. Put it into the shift lock release slot as shown in the image, and remove the cover.
4. Insert the key into the shift lock release slot.
5. While pushing the key down, press the shift lever release button and place the shift lever into **N**.
 - ▶ The lock is now released. Have the shift lever checked by a dealer as soon as possible.

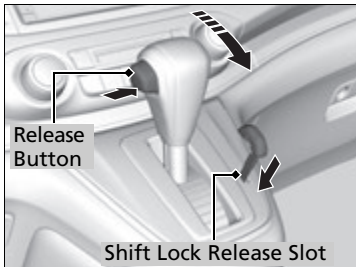

How to Handle Overheating

Overheating symptoms are as follows:

- The temperature gauge needle is at the **H** mark or the engine suddenly loses power.
- Steam or spray comes out of the engine compartment.

■ First thing to do

1. Immediately park the vehicle in a safe place.
2. Turn off all accessories and turn on the hazard warning lights.
 - ▶ **No steam or spray present:** Keep the engine running and open the hood.
 - ▶ **Steam or spray is present:** Turn off the engine and wait until it subsides. Then open the hood.

☒ How to Handle Overheating

⚠ WARNING

Steam and spray from an overheated engine can seriously scald you.

Do not open the hood if steam is coming out.

NOTICE

Continuing to drive with the temperature gauge needle at the **H** mark may damage the engine.

■ Next thing to do

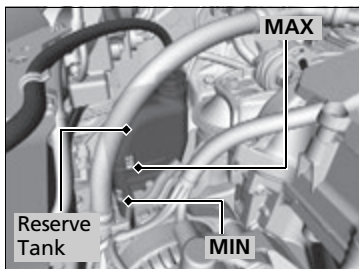

1. Check that the cooling fan is operating and stop the engine once the temperature gauge needle goes down.
 - If the cooling fan is not operating, immediately stop the engine.
2. Once the engine has cooled down, inspect the coolant level and check the cooling system components for leaks.
 - If the coolant level in the reserve tank is low, add coolant until it reaches the **MAX** mark.
 - If there is no coolant in the reserve tank, check that the radiator is cool. Cover the radiator cap with a heavy cloth and open the cap. If necessary, add coolant up to the base of the filler neck, and put the cap back on.

■ Last thing to do

Once the engine has cooled sufficiently, restart it and check the temperature gauge. If the temperature needle has gone down, resume driving. If it has not gone down, contact a dealer for repairs.

► How to Handle Overheating

⚠ WARNING

Removing the radiator cap while the engine is hot can cause the coolant to spray out, seriously scalding you.

Always let the engine and radiator cool down before removing the radiator cap.

If the coolant is leaking, contact a dealer for repairs.

Use water as an emergency/temporary measure only. Have a dealer flush the system with proper antifreeze as soon as possible.

If the Low Oil Pressure Indicator Comes On



■ Reasons for the indicator to come on

Comes on when the engine oil pressure is low.

■ What to do as soon as the indicator comes on

1. Immediately park the vehicle on level ground in a safe place.
2. If necessary, turn the hazard warning lights on.

■ What to do after parking the vehicle

1. Stop the engine and let it sit for about three minutes.
2. Open the hood and check the oil level.
 - ▶ **Oil Check** P. 453
3. Start the engine and check the low oil pressure indicator.
 - ▶ The indicator goes off: Start driving again.
 - ▶ The indicator does not go off within 10 seconds: Stop the engine and contact a dealer for repairs immediately.

If the Charging System Indicator Comes On



■ Reasons for the indicator to come on

Comes on when the battery is not being charged.

■ What to do when the indicator comes on

Turn off the heating and cooling system*/climate control system*, rear defogger, and other electrical systems, and immediately contact a dealer for repairs.

☒ If the Low Oil Pressure Indicator Comes On

NOTICE

Running the engine with low oil pressure can cause serious mechanical damage almost immediately.

☒ If the Charging System Indicator Comes On

If you need to stop temporarily, do not turn off the engine. Restarting the engine may rapidly discharge the battery.

* Not available on all models

If the Malfunction Indicator Lamp Comes On or Blinks



■ Reasons for the indicator lamp to come on or blink

- Comes on if there is a problem with the engine emissions control system, or the fuel fill cap is missing, or loose.
- Blinks when engine misfiring is detected.

■ What to do when the indicator lamp comes on

Avoid high speeds and immediately get your vehicle inspected at a dealer.

■ What to do when the indicator lamp blinks

Park the vehicle in a safe place with no flammable items and wait at least 10 minutes or more with the engine stopped until it cools.

■ Check/Tighten Fuel Cap Message

■ The message appears on when:

An evaporative system leak is detected. This may be caused by the fuel fill cap being loose or not being installed.

■ What to do when the message appears:

1. Stop the engine.
2. Check if the fuel fill cap is fully installed.
 - ▶ If not, loosen the cap, and then retighten it until it clicks at least once.
3. Drive for several days of normal driving.
 - ▶ The message should go off.

■ When the malfunction indicator lamp comes on

The malfunction indicator lamp comes on if the system continues to detect a leak of gasoline vapor. If this happens, check the fuel fill cap using the procedures described above.



⚠ If the Malfunction Indicator Lamp Comes On or Blinks

NOTICE

If you drive with the malfunction indicator lamp on, the emissions control system and the engine could be damaged.

If the malfunction indicator lamp blinks again when restarting the engine, drive to the nearest dealer at 31 mph (50 km/h) or less. Have your vehicle inspected.

If the Brake System Indicator (Red) Comes On

- U.S.  **Reasons for the indicator to come on**
- The brake fluid is low.
 - There is a malfunction in the brake system.
- Canada  **What to do when the indicator comes on while driving**
- Press the brake pedal lightly to check pedal pressure.
- If normal, check the brake fluid level the next time you stop.
 - If abnormal, take immediate action. If necessary, downshift the transmission to slow the vehicle using engine braking.

If the Electric Power Steering (EPS) System Indicator Comes On

-  **Reasons for the indicator to come on**
- Comes on if there is a problem with the EPS system.
 - If you depress the accelerator pedal repeatedly to increase the engine speed while the engine is idling, the indicator comes on, and sometimes the steering wheel becomes harder to operate.
- What to do when the indicator comes on**
- Stop the vehicle in a safe place and restart the engine.
- If the indicator comes on and stays on, immediately have your vehicle inspected by a dealer.

If the Brake System Indicator (Red) Comes On

Have your vehicle repaired immediately. It is dangerous to drive with low brake fluid. If there is no resistance from the brake pedal, stop immediately in a safe place. If necessary downshift the gears.

If the brake system indicator and **ABS** indicator come on simultaneously, the electronic brake distribution system is not working. This can result in vehicle instability under sudden braking. Have your vehicle inspected by a dealer immediately.

If the Low Tire Pressure/TPMS Indicator Comes On or Blinks



■ Reasons for the indicator to come on or blink

A tire pressure is significantly low, or the TPMS has not been calibrated. If there is a problem with the TPMS or the compact spare tire is installed, the indicator blinks for about one minute, and then stays on.

■ What to do when the indicator comes on

Drive carefully and avoid abrupt cornering and hard braking. Stop your vehicle in a safe place. Check the tire pressure and adjust the pressure to the specified level. The specified tire pressure is on a label on the driver side doorjamb.

- ▶ Calibrate the TPMS after the tire pressure is adjusted.

➤ **TPMS Calibration** P. 408

■ What to do when the indicator blinks, then remains on

Have the tire inspected by a dealer as soon as possible. If the compact spare tire causes the indicator to blink, change the tire to a full-size tire. The indicator goes off after driving for a few miles (kilometers).

- ▶ Calibrate the TPMS after a full-size tire is reinstalled.

➤ **TPMS Calibration** P. 408

▶▶ If the Low Tire Pressure/TPMS Indicator Comes On or Blinks

NOTICE

Driving on an extremely underinflated tire can cause it to overheat. An overheated tire can fail. Always inflate your tires to the prescribed level.

Fuse Locations

If any electrical devices are not working, turn the ignition switch to LOCK [0]*¹ and check to see if any applicable fuse is blown.

Fuse locations are shown on the fuse box cover. Locate the fuse in question by the fuse number and box cover number.

Engine Compartment Fuse Box

Located near the brake fluid reservoir. Push the tabs to open the box.

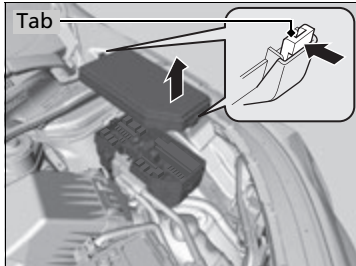

■ Circuit protected and fuse rating

| | Circuit Protected | Amps |
|---|--------------------------|--------|
| 1 | EPS | 70 A |
| | Power Tailgate | (40 A) |
| | ABS/VSA FSR | 20 A |
| | ABS/VSA Motor | 40 A |
| | E-DPS* | (30 A) |
| | Main Fuse | 120 A |
| | Main | 50 A |
| 2 | Fuse Box Main | 60 A |
| | Fuse Box Main 2 | 60 A |
| | Headlight High Beam Main | 30 A |
| | ST Magnetic Switch | (30 A) |
| | Rear Defogger | 30 A |
| | – | (30 A) |
| | Heater Motor | 40 A |
| | Front Wiper Main | 30 A |
| | Sub Fan Motor | 20 A |
| | Main Fan Motor | 20 A |
| 3 | DC/DC1 | (30 A) |
| | DC/DC2 | (30 A) |
| | IG MAIN | (30 A) |
| | IG MAIN2 | (30 A) |
| 4 | – | – |
| 5 | – | – |
| 6 | – | – |
| 7 | – | – |

| | Circuit Protected | Amps |
|----|----------------------------------|---------|
| 8 | Sub Fan Rly CL | 7.5 A |
| 9 | VSA ECU | 7.5 A |
| 10 | Heated Door Mirror* | (7.5 A) |
| 11 | STRLD | 7.5 A |
| 12 | Injector | 20 A |
| 13 | Premium Amp* | (20 A) |
| 14 | Horn | 10 A |
| 15 | Hazard | 10 A |
| 16 | Stop | 10 A |
| 17 | IG Coil | 15 A |
| 18 | IGP2 | 15 A |
| 19 | Daytime Running Lights | (10 A) |
| 20 | Passenger's Power Seat Reclining | (20 A) |
| 21 | Deicer | (15 A) |
| 22 | DBW | 15 A |
| 23 | IGP | 15 A |
| 24 | Left Headlight Low Beam | 10 A |
| 25 | Right Headlight Low Beam | 10 A |
| 26 | SMALL | 20 A |
| 27 | MG Clutch | 7.5 A |
| 28 | Interior Lights | 7.5 A |
| 29 | Backup | 10 A |

*1: Models with the smart entry system have an **ENGINE START/STOP** button instead of an ignition switch.

* Not available on all models

Interior Fuse Box

Located under the dashboard.

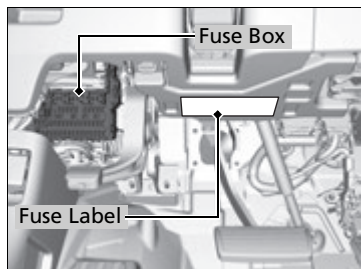

Fuse locations are shown on the label on the cover.

Locate the fuse in question by the fuse number and label number.

■ Circuit protected and fuse rating

| | Circuit Protected | Amps |
|---|---|-------|
| 1 | – | – |
| 2 | ACG | 10 A |
| 3 | SRS | 10 A |
| 4 | Fuel Pump | 15 A |
| 5 | Meter | 10 A |
| 6 | Power Window | 7.5 A |
| 7 | VB SOL | 7.5 A |
| 8 | Passenger's Side Door Lock Motor 2 (Unlock) | 15 A |

| | Circuit Protected | Amps |
|----|--|---------|
| 9 | Driver's Side Door Lock Motor 1 (Unlock) | 15 A |
| 10 | Trailer* | (7.5 A) |
| 11 | Moonroof* | (20 A) |
| 12 | Accessory Power Socket (Center Console) | 20 A |
| 13 | Washer Main* | (15 A) |
| 14 | Seat Heaters* | (20 A) |
| 15 | Driver's Door Lock Motor (Unlock) | 10 A |
| 16 | Driver's Power Seat Sliding* | (20 A) |
| 17 | Driver's Power Seat Reclining* | (20 A) |
| 18 | Front Passenger's Seat Sliding* | (20 A) |
| 19 | ACC | 7.5 A |
| 20 | ACC Key Lock | 7.5 A |
| 21 | Daytime Running Lights | 7.5 A |
| 22 | A/C | 7.5 A |
| 23 | Wiper | 10 A |
| 24 | ABS/VSA | 7.5 A |
| 25 | Audio | 10 A |
| 26 | Power Tailgate* | (20 A) |
| 27 | Accessory Power Socket (Front) | 20 A |
| 28 | Washer* | 15 A |
| 29 | OPDS | 7.5 A |

| | Circuit Protected | Amps |
|----|---|--------|
| 30 | Driver's Door Lock Motor (Lock) | 10 A |
| 31 | Smart* | (10 A) |
| 32 | Passenger's Side Door Lock Motor 2 (Lock) | 15 A |
| 33 | Driver's Side Door Lock Motor 1 (Lock) | 15 A |
| 34 | Small Lights | 10 A |
| 35 | Illumination | 7.5 A |
| 36 | Rear Wiper Main* | (10 A) |
| 37 | Front Fog Lights* | (20 A) |
| 38 | Left Headlight High Beam | 10 A |
| 39 | Right Headlight High Beam | 10 A |
| 40 | – | – |
| 41 | Door Lock | 20 A |
| 42 | Driver's Side Power Window | 20 A |
| 43 | Rear Passenger's Side Power Window | 20 A |
| 44 | Front Passenger's Side Power Window | 20 A |
| 45 | Rear Driver's Side Power Window | 20 A |
| 46 | – | – |

Inspecting and Changing Fuses

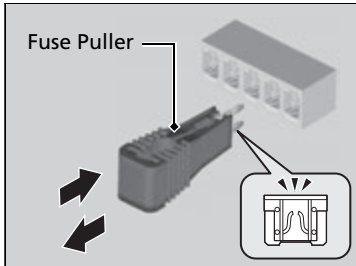
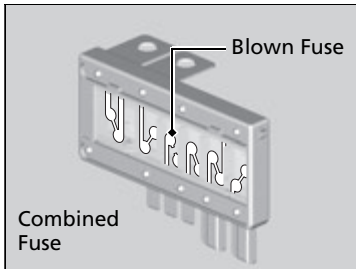

1. Turn the ignition switch to LOCK **0***1. Turn headlights and all accessories off.
2. Remove the fuse box cover.
3. Check the large fuse in the engine compartment.
 - If the fuse is blown, use a Phillips-head screwdriver to remove the screw and replace it with a new one.
4. Inspect the small fuses in the engine compartment and the vehicle interior.
 - If there is a burned out fuse, remove it with the fuse puller and replace it with a new one.

Inspecting and Changing Fuses

NOTICE

Replacing a fuse with one that has a higher rating greatly increases the chances of damaging the electrical system.

Replace fuse with a spare fuse of the same specified amperage.

Confirm the specified amperage using the charts on P. 513 to 514.

Use the charts to locate the fuse in question and conform the specific amperage on the fuse label.

► **Fuse Locations** P. 513

There is a fuse puller on the back of the engine compartment fuse box cover.

*1: Models with the smart entry system have an **ENGINE START/STOP** button instead of an ignition switch.

Call a professional towing service if you need to tow your vehicle.

All models

■ Flat bed equipment

The operator loads your vehicle on the back of a truck.

This is the best way to transport your vehicle.

2WD models

■ Wheel lift equipment

The tow truck uses two pivoting arms that go under the front tires and lift them off the ground. The rear tires remain on the ground. **This is an acceptable way to**

tow your vehicle.

» Emergency Towing

NOTICE

Trying to lift or tow your vehicle by the bumpers will cause serious damage. The bumpers are not designed to support the vehicle's weight.

NOTICE

Improper towing such as towing behind a motorhome or other motor vehicle can damage the transmission.

Never tow your vehicle with just a rope or chain. It is very dangerous since ropes or chains may shift from side to side or break.

When You Cannot Open the Tailgate

What to Do When Unable to Open the Tailgate

If you cannot open the tailgate, use the following procedure.

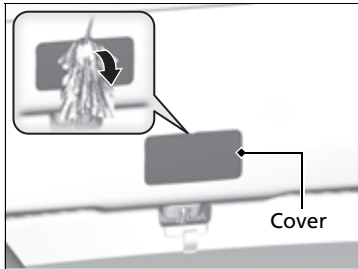

1. Use a flat-tip screwdriver and remove the cover on the inside of the tailgate.
 - ▶ Wrap the flat-tip screwdriver with a cloth to prevent scratches.

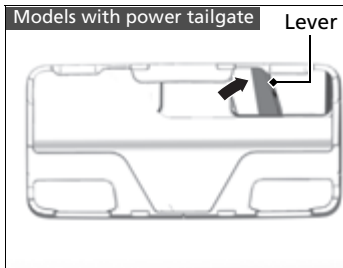

2. **Models with power tailgate**
To open the tailgate, push the tailgate while pushing the lever to the right.

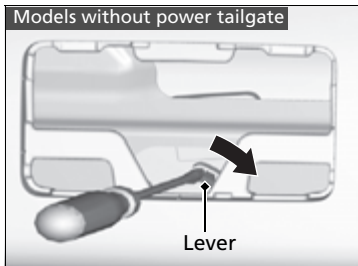

2. **Models without power tailgate**
To open the tailgate, push the tailgate while sliding the lever using a flat-tip screw driver.

When You Cannot Open the Tailgate

What to do following up

After taking these steps, contact a dealer to have the vehicle checked.

When you open the tailgate from inside, make sure there is enough space around the tailgate, and it does not hit anyone or any object.

Information

This chapter includes your vehicle's specifications, locations of identification numbers, and other information required by regulation.

| | |
|--|-----|
| Specifications | 520 |
| Identification Numbers | |
| Vehicle Identification Number (VIN), Engine Number and Transmission Number | 522 |
| Devices that Emit Radio Waves | 523 |
| Reporting Safety Defects | 524 |
| Emissions Testing | |
| Testing of Readiness Codes | 525 |
| Warranty Coverages | 527 |
| Authorized Manuals | 529 |
| Customer Service Information | 530 |

■ Vehicle Specifications

| | | |
|----------------------------------|------------|--|
| Model | Honda CR-V | |
| No. of Passengers: | | |
| Front | 2 | |
| Rear | 3 | |
| Total | 5 | |
| Weights: | | |
| Gross Vehicle Weight Rating | U.S.: | 4,464 lbs (2,025 kg) ^{*1} 4,519 lbs (2,050 kg) ^{*2, *3} 4,564 lbs (2,070 kg) ^{*4} 4,630 lbs (2,100 kg) ^{*5} |
| | Canada: | 2,025 kg ^{*6} 2,050 kg ^{*3} 2,070 kg ^{*4} 2,100 kg ^{*5} |
| Gross Axle Weight Rating (Front) | U.S.: | 2,271 lbs (1,030 kg) ^{*1} 2,326 lbs (1,055 kg) ^{*2, *3, *4} 2,348 lbs (1,065 kg) ^{*5} |
| | Canada: | 1,030 kg ^{*6} 1,055 kg ^{*3, *4} 1,065 kg ^{*5} |
| Gross Axle Weight Rating (Rear) | U.S.: | 2,238 lbs (1,015 kg) ^{*1, *2, *3} 2,282 lbs (1,035 kg) ^{*4} 2,326 lbs (1,055 kg) ^{*5} |
| | Canada: | 1,015 kg ^{*3, *6} 1,035 kg ^{*4} 1,055 kg ^{*5} |

*1: LX, EX and SE models with 2WD

*2: EXL and TOURING models with 2WD

*3: LX models with AWD

*4: EX and SE models with AWD

*5: EXL and TOURING models with AWD

*6: LX models with 2WD

■ Vehicle Specifications

| | | |
|-------------------|------------------------------|--|
| Air Conditioning: | | |
| Refrigerant Type | HFC-134a (R-134a) | |
| Charge Quantity | 13.6 – 15.4 oz (385 – 435 g) | |
| Lubricant Type | SP-10 | |

■ Engine Specifications

| | | |
|--------------|------------------------------------|------------------------------|
| Displacement | 144 cu-in (2,356 cm ³) | |
| Spark Plugs | NGK | DILKAR7H11GS DILKAR7G11GS |
| | DENSO | DXE22HQR-D11S |

■ Fuel

| | | |
|--------------------|---|--|
| Type | Unleaded gasoline, Pump octane number of 87 or higher | |
| Fuel Tank Capacity | 15.3 US gal (58 ℓ) | |

■ Washer Fluid

| | | |
|---------------|--|--|
| Tank Capacity | U.S.: 2.6 US qt (2.5 ℓ) Canada: 4.8 US qt (4.5 ℓ) | |
|---------------|--|--|

■ Light Bulbs

| | |
|--|----------------|
| Headlights (Low Beam) | 55 W (H11) |
| Headlights (High Beam) | 60 W (HB3) |
| Fog Lights ^{*1} | 35 W (H8) |
| Front Turn Signal/ Side Marker Lights ^{*1} | 28/8 W (Amber) |
| Front Turn Signal/Side Marker/ Parking Lights ^{*2} | 28/8 W (Amber) |
| Side Turn Signal Lights (on Door Mirrors) ^{*3, *4} | LED |
| Parking Lights ^{*1} | LED |
| Upper Rear Side Marker/Taillights | 3 CP |
| Lower Rear Side Marker/Brake/ Taillights | 21/5 W |
| Back-Up Lights | 21 W |
| Rear Turn Signal Lights | 21 W (Amber) |
| High-Mount Brake Light | LED |
| Rear License Plate Light | 3 CP |
| Interior Lights | |
| Map Lights | 8 W |
| Ceiling Light | 8 W |
| Cargo Area Light | 8 W |
| Vanity Mirror Lights ^{*5} | 1.4 W |

*1: Models with smart entry system

*2: Models without smart entry system

*3: Except Canadian models

*4: Vehicle with 18 inch wheel

*5: Models with moonroof

■ Brake Fluid

| | | |
|-----------|------------------------------------|--|
| Specified | Honda Heavy Duty Brake Fluid DOT 3 | |
|-----------|------------------------------------|--|

■ Continuously Variable Transmission Fluid

| | | |
|-----------|--------------------------------|---------------------------------|
| Specified | Honda HCF-2 Transmission Fluid | |
| Capacity | Change | 3.9 US qt (3.7 ℓ) ^{*1} |
| | | 4.5 US qt (4.3 ℓ) ^{*2} |

*1: 2WD models

*2: AWD models

■ Rear Differential Fluid*

| | | |
|-----------|--------------------------|----------------------|
| Specified | Honda Dual Pump Fluid II | |
| Capacity | Change | 1.32 US qt (1.247 ℓ) |
| | Total | 1.57 US qt (1.488 ℓ) |

■ Engine Oil

| | | |
|-------------|--|-------------------|
| Recommended | -Genuine Honda Motor Oil 0W-20 | |
| | -API Premium-grade 0W-20 detergent oil | |
| Capacity | Change | 4.4 US qt (4.2 ℓ) |
| | Change including filter | 4.6 US qt (4.4 ℓ) |

■ Engine Coolant

| | | |
|-----------|---|--|
| Specified | Honda Long Life Antifreeze/Coolant Type2 | |
| Ratio | 50/50 with distilled water | |
| Capacity | 1.66 US gal (6.30 ℓ) | |
| | (change including the remaining 0.16 US gal (0.62 ℓ) in the reserve tank) | |

■ Tire

| | | | |
|--------------------|--|-------------------------|----------------|
| Regular | Size ^{*1} | 215/70R16 100S | |
| | Pressure ^{*1} psi (kPa [kgf/cm ²]) | Front | 32 (220 [2.2]) |
| | | Rear | 32 (220 [2.2]) |
| | Size ^{*2} | 225/65R17 102T | |
| | Pressure ^{*2} psi (kPa [kgf/cm ²]) | Front | 33 (230 [2.3]) |
| | | Rear | 33 (230 [2.3]) |
| Size ^{*3} | P225/60R18 99H | | |
| Compact Spare | Pressure ^{*3} psi (kPa [kgf/cm ²]) | Front | 32 (220 [2.2]) |
| | | Rear | 30 (210 [2.1]) |
| Compact Spare | Size | T155/90D17 101M | |
| | Pressure psi (kPa [kgf/cm ²]) | 60 (420 [4.2]) | |
| Wheel Size | Regular | 16 x 6.5J ^{*1} | |
| | | 17 x 7J ^{*2} | |
| | Compact Spare | 17 x 4T | |

*1: Vehicle with 16 inch wheel

*2: Vehicle with 17 inch wheel

*3: Vehicle with 18 inch wheel

* Not available on all models

Vehicle Identification Number (VIN), Engine Number and Transmission Number

Your vehicle has a 17-digit vehicle identification number (VIN) used to register your vehicle for warranty purposes, and for licensing and insuring your vehicle. The locations of your vehicle's VIN, engine number and transmission number are shown as follows.

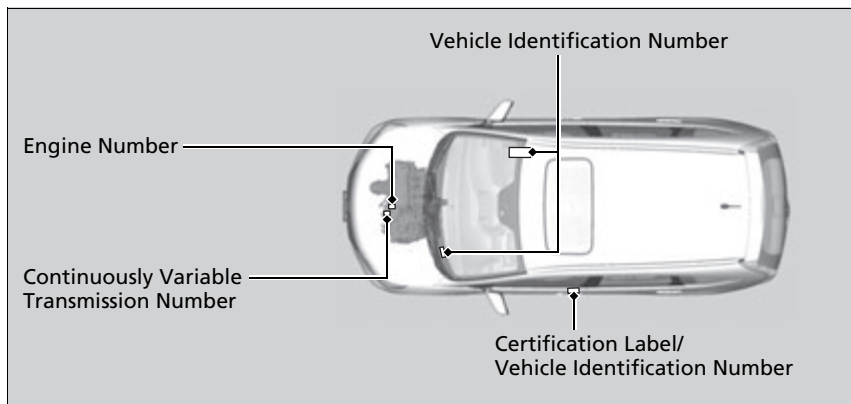

Vehicle Identification Number (VIN), Engine Number and Transmission Number

The interior vehicle identification number (VIN) is located under the cover.

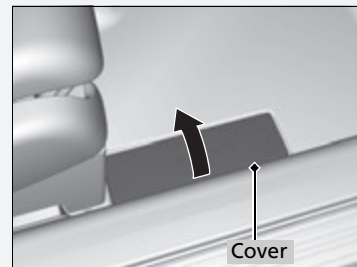

Devices that Emit Radio Waves

The following products and systems on your vehicle emit radio waves when in operation.

Audio System

Bluetooth® Audio

Bluetooth® HandsFreeLink®

HomeLink® Universal Transceiver*

Immobilizer System

Remote Transmitter

Smart Entry System*

Collision Mitigation Braking System™*

Each of the above complies with the appropriate requirements or the required standards of FCC (Federal Communications Commission) and Industry Canada Standard, described below:

As required by the FCC:

This device complies with Part 15 of the FCC rules. Operation is subject to the following two conditions: (1) This device may not cause harmful interference, and (2) this device must accept any interference received, including interference that may cause undesired operation.

Changes or modifications not expressly approved by the party responsible for compliance could void the user's authority to operate the equipment.

This device complies with industry Canada licence-exempt RSS standard(s).

Operation is subject to the following two conditions: (1) this device may not cause interference, and (2) this device must accept any interference, including interference that may cause undesired operation of the device.

* Not available on all models

In the U.S.

If you believe that your vehicle has a defect which could cause a crash or could cause injury or death, you should immediately inform the National Highway Traffic Safety Administration (NHTSA) in addition to notifying American Honda Motor Co., Inc.

If NHTSA receives similar complaints, it may open an investigation, and if it finds that a safety defect exists in a group of vehicles, it may order a recall and remedy campaign. However, NHTSA cannot become involved in individual problems between you, your dealer, or American Honda Motor Co., Inc.

To contact NHTSA, you may call the Vehicle Safety Hotline toll-free at 1-888-327-4236 (TTY: 1-800-424-9153); go to <http://www.safercar.gov>; or write to: Administrator, NHTSA, 1200 New Jersey Avenue, SE., Washington, DC 20590. You can also obtain other information about motor vehicle safety from <http://www.safercar.gov>.

In Canada

If you believe that your vehicle has a defect which could cause a crash or could cause injury or death, you should immediately inform Honda Canada Inc. and you may also inform Transport Canada.

If Transport Canada receives similar complaints, it may open an investigation, and if it finds that a safety defect exists in a group of vehicles, it may lead to a recall and remedy campaign. However, Transport Canada cannot become involved in individual problems between you, your dealer, or Honda Canada Inc.

To contact Transport Canada's Defect Investigations and Recalls Division, you may call 1-800-333-0510. For more information on reporting safety defects or about motor vehicle safety, go to <http://www.tc.gc.ca/roadsafety>.

Testing of Readiness Codes

Your vehicle has "Readiness Codes," as part of the onboard self diagnostic system. Some States use these codes as a test to see if your vehicle's emissions components are working properly. The codes may not be read properly if testing is performed just after the battery has gone dead or been disconnected.

To check if they are set, turn the ignition switch to ON **II***1, without starting the engine. The malfunction indicator lamp will come on for several seconds. If it then goes off, the readiness codes are set. If it blinks five times, the readiness codes are not set.

If you are required to have your vehicle tested before the readiness codes are ready, prepare the vehicle for retesting by doing the following:

1. Fill the fuel tank to approximately 3/4 full.
2. Park the vehicle and leave the engine off for six hours or more.
3. Make sure the ambient temperature is between 40°F and 95°F (4°C and 35°C).
4. Start the engine without touching the accelerator pedal, and let it idle for 20 seconds.
5. Keep the vehicle in **P**. Increase the engine speed to 2,000 rpm, and hold it there for about three minutes.
6. Let the engine idle with your foot off the accelerator for 20 seconds.

*1: Models with the smart entry system have an **ENGINE START/STOP** button instead of an ignition switch.

Testing of Readiness Codes

The readiness codes are erased when the battery is disconnected, and set again only after several days of driving under a variety of conditions.

If a testing facility determines that the readiness codes are not set, you may be requested to return at a later date to complete the test.

If the testing facility determines the readiness codes are still not set, see a dealer.

7. Select a nearby, lightly traveled major highway where you can maintain a speed of 50 to 60 mph (80 to 97 km/h) for at least 20 minutes. Drive on the highway in **D**. Do not use cruise control. When traffic allows, drive for 90 seconds without moving the accelerator pedal. (Vehicle speed may vary slightly; this is okay.) If you cannot do this for a continuous 90 seconds because of traffic conditions, drive for at least 30 seconds, then repeat it two more times (for a total of 90 seconds).
8. Drive in city/suburban traffic for at least 10 minutes. When traffic conditions allow, let the vehicle coast for several seconds without using the accelerator pedal or the brake pedal.
9. Park the vehicle and leave the engine off for 30 minutes.

■ U.S. Owners

Your new vehicle is covered by these warranties:

New Vehicle Limited Warranty – covers your new vehicle, except for the emissions control systems and accessories, against defects in materials and workmanship.

Emissions Control Systems Defects Warranty and Emissions Performance Warranty – these two warranties cover your vehicle's emissions control systems. Time, mileage, and coverage are conditional. Please read your warranty booklet for exact information.

Seat Belt Limited Warranty – a seat belt that fails to function properly is covered by a limited warranty. Please read your warranty booklet for details.

Rust Perforation Limited Warranty – all exterior body panels are covered for rust-through from the inside for the specified time period with no mileage limit.

Accessory Limited Warranty – Honda accessories are covered under this warranty. Time and mileage limits depend on the type of accessory and other factors. Please read your warranty booklet for details.

Replacement Parts Limited Warranty – covers all Honda replacement parts against defects in materials and workmanship.

Replacement Battery Limited Warranty – provides prorated coverage for a replacement battery purchased from a dealer.

Replacement Muffler Lifetime Limited Warranty – provides coverage for as long as the purchaser of the muffler owns the vehicle.

Restrictions and exclusions apply to all these warranties. Please read the Honda warranty information booklet that came with your vehicle for precise information on warranty coverages. Your vehicle's original tires are covered by their manufacturer. Tire warranty information is in a separate booklet.

■ **Canadian Owners**

Please refer to the warranty manual that came with your vehicle.

■ Service Express

For electronic copies of service publications, you can purchase a subscription to Service Express. Visit www.techinfo.honda.com for pricing and options.

■ For U.S. Owners:

Manuals can be purchased from Helm Incorporated. You can order a manual by phone at 1-800-782-4356 (credit card orders only), or online at www.helminc.com.

■ For Canadian Owners:

Please contact a dealer to order any manuals that you may require.

Honda dealership personnel are trained professionals.

They should be able to answer all your questions. If you encounter a problem that your dealership does not solve to your satisfaction, please discuss it with the dealership's service manager or general manager. If you are dissatisfied with the decision made by the dealership's management, contact Honda Customer Services.

U.S. Owners:

American Honda Motor Co., Inc.
Honda Automobile Customer Services
Mail Stop 500-2N-7A
1919 Torrance Blvd.
Torrance, CA 90501-2746
Tel: (800) 999-1009

Canadian Owners:

Honda Canada Inc.
Customer Relations
180 Honda Boulevard
Markham, ON
L6C 0H9
Tel: 1-888-9-HONDA-9
Fax: 1-877-939-0909
E-mail: Honda_cr@ch.honda.com

In Puerto Rico and the U.S. Virgin Islands:

Bella International
P.O. Box 190816
San Juan, PR 00919-0816
Tel: (787) 620-7546

Customer Service Information

When you call or write, please give us the following information:

- Vehicle Identification Number
 - **Vehicle Identification Number (VIN), Engine Number and Transmission Number** P. 522
- Date of purchase
- Odometer reading of your vehicle
- Your name, address, and telephone number
- A detailed description of the problem
- Name of the dealer who sold the vehicle to you

Disclaimer of Pandora®*

Requirements to access Pandora®

- Latest version of the Pandora application installed on your mobile device. (Visit the Apple iTunes® store or Google Play Marketplace to download the latest version.)
- Registered Pandora account (you can create a free account at www.pandora.com <<http://www.pandora.com>> or on your smartphone)
- Connection to the internet via WiFi or cellular data network.
- Android devices must be connected to the vehicle via *Bluetooth*, iPhone® devices may be connected via *Bluetooth* or USB.

Limitations

- Access to Pandora requires an active internet connection
- Ability to access Pandora through this system is subject to change without notice
- Certain functionality of Pandora service is not available when accessing the service through this system including, but not limited to, creating new stations, deleting stations, emailing current stations, buying songs, viewing additional text information, logging in to Pandora, and adjusting Cell Network Audio Quality. Pandora internet radio is a music service not affiliated with HONDA. More information is available at <http://www.pandora.com> <<http://www.pandora.com>>. Pandora, the Pandora logo, and the Pandora trade dress are trademarks or registered trademarks of Pandora Media, Inc., used with permission.
- Mobile access requires a smartphone with an active data plan. Standard data rates may apply.
- Pandora is only available in the United States.

* Not available on all models

Numbers

4WD 407

A

ABS (Anti-lock Brake System) 414

Accessories and Modifications 433

Accessory Power Sockets 192

Adaptive Cruise Control (ACC) 380

Indicator 82

Additives

Coolant 457

Engine Oil 452

Washer 461

Additives, Engine Oil 452

Adjusting

Armrest 186

Front Seats 177

Head Restraints 180

Mirrors 175

Rear Seat Back 185

Rear Seats 184

Steering Wheel 174

Adjusting the Sound 240

Air Conditioning System (Climate Control System) 203

Changing the Mode 203

Defrosting the Windshield and

Windows 204

Dust and Pollen Filter 487

Recirculation/Fresh Air Mode 203

Sensors 206

Synchronized Mode 205

Using Automatic Climate Control 203

Air Conditioning System (Heating and Cooling System) 200

Cooling 202

Defrosting the Windshield and

Windows 202

Dust and Pollen Filter 487

Heating 201

Air Pressure 476, 521

Airbags 41

Advanced Airbags 47

Airbag Care 53

Event Data Recorder 0

Front Airbags (SRS) 44

Indicator 51, 73

Passenger Airbag Off Indicator 52

Sensors 41

Side Airbags 48

Side Curtain Airbags 50

All-Wheel Drive (AWD) 407

AM/FM Radio 218

Anti-lock Brake System (ABS) 414

Indicator 73

Armrest 186

Audio Antenna 212

Audio System 208

Adjusting the Sound 217

Auxiliary Input Jack 209

Error Messages 265

General Information 271

Internet Radio 227

iPhone 273

iPod 224

MP3/WMA/AAC 221, 229, 256

Pandora® 227

Reactivating 213

Recommended CDs 272

Recommended Devices 273

Security Code 213

Theft Protection 213

USB Adapter Cable 210

USB Flash Drives 273

USB Port(s) 211

Audio/Information Screen 236

Authorized Manuals 529

Auto Door Locking/Unlocking 141

Customize 124

Automatic Intermittent Wipers 167

Automatic Lighting 162

Auxiliary Input Jack 209

Average Fuel Economy 96, 114

Average Speed 114

AWD (All-Wheel Drive) 407

B

Battery 484

Charging System Indicator 71, 509

Jump Starting 504

Maintenance (Checking the Battery) 484

| | |
|--|----------|
| Maintenance (Replacing)..... | 485 |
| Belts (Seat) | 33 |
| Beverage Holders | 190 |
| Bluetooth® Audio | 232 |
| Bluetooth® HandsFreeLink® | 288, 317 |
| Booster Seats (For Children) | 66 |
| Brake System | 412 |
| Anti-lock Brake System (ABS)..... | 414 |
| Brake Assist System..... | 415 |
| Fluid..... | 460 |
| Foot Brake..... | 413 |
| Indicator..... | 70, 511 |
| Parking Brake..... | 412 |
| Brightness Control (Instrument Panel) ... | 169 |
| Bulb Replacement | 462 |
| Brake Light, Taillight, Back-Up Light, Rear Turn Signal Light and Lower Rear Side Marker Lights..... | 467 |
| Fog Lights..... | 463 |
| Front Turn Signal/Side Marker Light/ Parking Lights..... | 465 |
| Front Turn Signal/Side Marker Lights..... | 466 |
| Headlights..... | 462 |
| High-Mount Brake Light..... | 470 |
| Parking Lights..... | 466 |
| Rear License Plate Lights..... | 470 |
| Side Turn Signal/Emergency Indicator Lights..... | 467 |
| Upper Rear Side Marker/Taillights..... | 469 |
| Bulb Specifications | 520 |

C

| | |
|---|----------|
| Carbon Monoxide Gas | 67 |
| Cargo Hook | 195 |
| Cargo Side Net | 194 |
| Carrying Cargo | 353, 355 |
| CD Player | 221 |
| Certification Label | 522 |
| Changing Bulbs | 462 |
| Charging System Indicator | 71, 509 |
| Child Safety | 54 |
| Childproof Door Locks..... | 140 |
| Child Seat | 54 |
| Booster Seats..... | 66 |
| Child Seat for Infants..... | 56 |
| Child Seat for Small Children..... | 57 |
| Installing a Child Seat with a Lap/Shoulder Seat Belt..... | 62 |
| Larger Children..... | 65 |
| Rear-facing Child Seat..... | 56 |
| Selecting a Child Seat..... | 58 |
| Childproof Door Locks | 140 |
| Cleaning the Exterior | 490 |
| Cleaning the Interior | 488 |
| Climate Control System | 203 |
| Changing the Mode..... | 203 |
| Defrosting the Windshield and Windows..... | 204 |
| Dust and Pollen Filter..... | 487 |
| Recirculation/Fresh Air Mode..... | 203 |
| Sensors..... | 206 |
| Synchronized Mode..... | 205 |

| | |
|--|---------------|
| Using Automatic Climate Control..... | 203 |
| Clock | 130 |
| CMBS™ (Collision Mitigation Braking System™) | 416 |
| Coat Hook | 194 |
| Collision Mitigation Braking System™ (CMBS™) | 416 |
| Indicator..... | 85, 86 |
| Compact Spare Tire | 495, 521 |
| Compass | 347 |
| Console Compartment | 189 |
| Continuously Variable Transmission | 371 |
| Creeping..... | 371 |
| Fluid..... | 459 |
| Kickdown..... | 371 |
| Operating the Shift Lever..... | 19, 373 |
| Shift Lever Does Not Move..... | 506 |
| Shifting..... | 372 |
| Controls | 129 |
| Coolant (Engine) | 457 |
| Adding to the Radiator..... | 458 |
| Adding to the Reserve Tank..... | 457 |
| Overheating..... | 507 |
| Creeping (Continuously Variable Transmission) | 371 |
| Cruise Control | 375 |
| Indicator..... | 79 |
| Cup Holders | 190 |
| Customer Service Information | 530 |
| Customized Features | 102, 116, 274 |

- D**
- Daytime Running Lights 165
 - Dead Battery 504
 - Defrosting the Windshield and Windows 202, 204
 - Detachable Anchor 38
 - Devices that Emit Radio Waves 523
 - Dimming
 - Headlights 161
 - Rearview Mirror 175
 - Dipstick (Engine Oil) 453
 - Directional Signals (Turn Signals) 160
 - Display Button 113
 - Display Setup 241
 - Door Mirrors 176
 - Doors 132
 - Auto Door Locking 141
 - Auto Door Unlocking 141
 - Door Open Indicator 32
 - Keys 132
 - Locking/Unlocking the Doors from the Inside 139
 - Locking/Unlocking the Doors from the Outside 135
 - Lockout Prevention System 138
 - DOT Tire Quality Grading 478
 - Driver's Seat Lumbar Support 177
 - Driving 351
 - Adaptive Cruise Control (ACC) 380
 - Braking 412
 - Continuously Variable Transmission 371
 - Cruise Control 375
 - Off-Highway Driving Guidelines 362
 - Shifting Gear 372
 - Starting the Engine 364, 366
 - Driving Position Memory System 172
 - Dust and Pollen Filter 487
- E**
- Eco Assist System 9
 - ECON Button 374
 - Elapsed Time 114
 - Electric Power Steering (EPS) System
 - Indicator 76, 511
 - Electronic Stability Control (ESC) 403
 - Emergency 516
 - Emissions Testing (Readiness Codes) 525
 - Engine 522
 - Coolant 457
 - Jump Starting 504
 - Oil 452
 - Starting 364, 366
 - Switch Buzzer 155, 158
 - Engine Coolant 457
 - Adding to the Radiator 458
 - Adding to the Reserve Tank 457
 - Overheating 507
 - Temperature Gauge 94
 - Engine Oil 452
 - Adding 454
 - Checking 453
 - Displaying Oil Life 439
 - Low Oil Pressure Indicator 70, 509
 - Recommended Engine Oil 452
 - ENGINE START/STOP Button** 156
 - EPS (Electric Power Steering) System** 76, 511
 - Exhaust Gas Hazard (Carbon Monoxide) 67
 - Exterior Care (Cleaning) 490
 - Exterior Mirrors 176
- F**
- Features 207
 - Filters
 - Dust and Pollen 487
 - Oil 455
 - Flat Tire 495
 - Floor Mats 489
 - Fluids
 - Brake 460
 - Continuously Variable Transmission 459
 - Engine Coolant 457
 - Windshield Washer 461
 - Fog Light Indicator 77
 - Folding Down the Rear Seats 184
 - Foot Brake 413
 - Front Airbags (SRS) 44
 - Front Seats 177
 - Adjusting 177
 - Front Sensor Camera 378

| | |
|-------------------------------|----------|
| Fuel | 21, 429 |
| Economy..... | 432 |
| Gauge | 94 |
| Low Fuel Indicator..... | 72 |
| Range | 96, 114 |
| Recommendation..... | 429 |
| Refueling | 429 |
| Fuel Economy | 432 |
| Fuel Fill Cap | 431 |
| Message | 510 |
| Fuel Fill Door | 430 |
| Fuses | 513 |
| Inspecting and Changing | 515 |
| Locations | 513, 514 |

G

| | |
|--|----------|
| Gasoline (Fuel) | |
| Economy..... | 432 |
| Gauge | 94 |
| Information..... | 429 |
| Low Fuel Indicator..... | 72 |
| Refueling | 429 |
| Gauges | 94 |
| Gear Shift Lever Positions | |
| Continuously Variable Transmission | 372 |
| Glass (care) | 488, 491 |
| Glove Box | 189 |

H

| | |
|---|-------------------------|
| Handling the Unexpected | 493 |
| HandsFreeLink® (HFL) | 288, 317 |
| Automatic Import of Cellular Phonebook and Call History..... | 304, 332 |
| Automatic Transferring | 302 |
| Caller's ID Information | 302 |
| HFL Buttons | 288, 317 |
| HFL Menus | 290, 320 |
| HFL Status Display | 289, 319 |
| Limitations for Manual Operation | 289, 319 |
| Mail Account..... | 340 |
| Making a Call | 307, 335 |
| Options During a Call | 311, 338 |
| Phone Setup | 295, 325 |
| Receiving a Call | 310, 338 |
| Ring Tone | 331 |
| Speed Dial | 305, 333 |
| Text Message | 300, 312, 330, 339, 341 |
| To Clear the System..... | 303 |
| To Create a Security PIN | 301 |
| Hazard Warning Button | 4 |
| HDMI® Port | 212 |
| Head Restraints | 180 |
| Headlights | 161 |
| Aiming | 462 |
| Automatic Operation | 162 |
| Dimming | 161, 165 |
| Operating | 161 |
| Heated Door Mirror Button | 170 |
| Heated Windshield Button | 171 |

| | |
|---|----------|
| Heaters (Seat) | 197 |
| Heating and Cooling System | 200 |
| Cooling..... | 202 |
| Defrosting the Windshield and Windows..... | 202 |
| Dust and Pollen Filter..... | 487 |
| Heating..... | 201 |
| HFL (HandsFreeLink®) | 288, 317 |
| High Beam Indicator | 77 |
| Hill Start Assist System | 365, 369 |
| HomeLink® Universal Transceiver | 285 |
| HondaLink | 345 |

I

| | |
|--|-----|
| Identification Numbers | 522 |
| Engine and Transmission | 522 |
| Vehicle Identification | 522 |
| Ignition Switch | 155 |
| Illumination Control | 169 |
| Knob..... | 169 |
| i-MID (intelligent Multi-Information Display) | 113 |
| Immobilizer System | 149 |
| Indicator..... | 78 |

| | | | | | |
|---|---------|--|----------|---|----------|
| Indicators | 70 | System Message Indicator | 81 | Keys | 132 |
| Adaptive Cruise Control (ACC) | 82 | Tailgate Open..... | 75 | Lockout Prevention | 138 |
| All-Wheel Drive (AWD) System..... | 73 | Transmission | 72 | Master Keys..... | 132 |
| Anti-lock Brake System (ABS)..... | 73 | Turn Signal..... | 77 | Number Tag..... | 134 |
| Brake System | 81 | Vehicle Stability Assist (VSA®) | | Rear Door Won't Open | 140 |
| Charging System | 71, 509 | System | 74, 403 | Remote Transmitter | 137 |
| Collision Mitigation Braking System™ | | VSA® OFF..... | 74, 404 | Types and Functions..... | 132 |
| (CMBS™)..... | 85, 86 | Washer Level..... | 79 | Valet Key | 133 |
| CRUISE CONTROL..... | 79, 376 | Information | 519 | Won't Turn | 24 |
| CRUISE MAIN | 79, 375 | Information Button | 98 | Kickdown (Continuously Variable | |
| Door Open | 32, 75 | Information Display | 95 | Transmission) | 371 |
| ECON Mode | 78, 374 | Instant Fuel Economy Gauge | 100 | L | |
| Electric Power Steering (EPS) System .. | 76, 511 | Instrument Panel | 69 | Lane Departure Warning (LDW)..... | 391 |
| Fog Light | 77 | Brightness Control..... | 169 | Lane Keeping Assist System (LKAS) | 395 |
| High Beam..... | 77 | intelligent Multi-Information Display | | Indicator | 84 |
| Immobilizer System..... | 78 | (i-MID) | 113 | LaneWatch™..... | 405 |
| Lane Departure Warning (LDW) | 87 | Interior Lights | 187 | Language (HFL) | 289 |
| Lane Keeping Assist System (LKAS)..... | 84 | Interior Rearview Mirror | 175 | LATCH (Child Seats) | 59, 63 |
| Lights On | 77 | Internet Radio | 254, 255 | LDW (Lane Departure Warning) | 391 |
| Low Fuel..... | 72 | iPod | 224 | Lights | 161, 462 |
| Low Oil Pressure | 70, 509 | J | | Automatic..... | 162 |
| Low Tire Pressure/TPMS | 76, 410 | Jack (Wheel Nut Wrench) | 498 | Bulb Replacement | 462 |
| Maintenance Minder | 79, 439 | Jump Starting | 504 | Daytime Running Lights | 165 |
| Malfunction Indicator Lamp..... | 71, 510 | K | | Fog Lights | 164 |
| Parking Brake and Brake System | 70, 511 | Key Number Tag | 134 | High Beam Indicator | 77 |
| Seat Belt Reminder | 34, 72 | Keyless Lockout Prevention | 138 | Interior..... | 187 |
| Security System Alarm | 78 | | | Light Switches..... | 161 |
| Shift Lever Position | 71 | | | Lights On Indicator..... | 77 |
| Smart Entry System..... | 80 | | | Turn Signals..... | 160 |
| Starter System | 80 | | | | |
| Supplemental Restraint System | 51, 73 | | | | |

| | |
|---|---------|
| Load Limits | 355 |
| Locking/Unlocking | 132 |
| Auto Door Locking/Unlocking | 141 |
| Childproof Door Locks | 140 |
| From Inside | 139 |
| From Outside | 135 |
| Keys..... | 132 |
| Using a Key..... | 138 |
| Lockout Prevention System | 138 |
| Low Battery Charge | 509 |
| Low Fuel Indicator | 72 |
| Low Oil Pressure Indicator | 70, 509 |
| Low Smart Entry Remote Signal Strength | 134 |
| Lower Anchors | 59, 63 |
| Luggage (Maximum Load Limit) | 355 |

M

| | |
|----------------------------------|-----|
| Maintenance | 435 |
| Battery..... | 484 |
| Brake Fluid..... | 460 |
| Cleaning..... | 488 |
| Climate Control System | 487 |
| Coolant | 457 |
| Heating and Cooling System | 487 |
| Maintenance Minder™..... | 439 |
| Oil | 453 |
| Precautions..... | 436 |
| Radiator..... | 458 |
| Remote Transmitter | 485 |

| | |
|----------------------------|-----|
| Replacing Light Bulbs..... | 462 |
| Safety..... | 437 |
| Service Items | 444 |
| Tires | 475 |
| Transmission Fluid | 459 |
| Under the Hood | 450 |

| | |
|--|---------------|
| Malfunction Indicator Lamp | 71, 510 |
| Map Lights | 188 |
| Maximum Load Limit | 355 |
| Meters, Gauges | 94 |
| Mirrors | 175 |
| Adjusting..... | 175 |
| Door..... | 176 |
| Exterior..... | 176 |
| Interior Rearview | 175 |
| Modifications (and Accessories) | 433 |
| Moonroof | 154 |
| MP3 | 221, 229, 256 |
| Multi-Information Display | 98 |
| Multi-View Rear Camera | 426 |

N

| | |
|---------------------------------------|-----|
| Numbers (Identification) | 522 |
|---------------------------------------|-----|

O

| | |
|---|--------|
| Odometer | 95, 99 |
| Off-Highway Driving Guidelines | 362 |
| Oil (Engine) | 452 |
| Adding | 454 |

| | |
|----------------------------------|---------|
| Checking..... | 453 |
| Displaying Oil Life..... | 439 |
| Low Oil Pressure Indicator | 70, 509 |
| Recommended Engine Oil | 452 |
| Viscosity..... | 452 |

Opening/Closing

| | |
|----------------------------------|---------|
| Hood..... | 451 |
| Moonroof | 154 |
| Power Windows | 152 |
| Tailgate..... | 142 |
| Outside Temperature | 97, 100 |
| Adjusting | 97, 100 |
| Overheating | 507 |

P

| | |
|---|----------|
| Pandora® | 227, 255 |
| Panic Mode | 151 |
| Parking | 425 |
| Parking Brake | 412 |
| Parking Brake and Brake System Indicator | 70, 511 |
| Passenger Airbag Off Indicator | 52 |
| Passing Indicators | 161 |
| Playing Bluetooth® Audio | 259 |
| Power Tailgate | 145 |
| Power Windows | 152 |
| Precautions While Driving | 370 |
| Driving Guidelines for Your Utility Vehicle | 370 |
| Rain | 370 |

| | |
|-----------------------|-----|
| Pregnant Women | 39 |
| Puncture (Tire) | 495 |

R

| | |
|---|---------------|
| Radiator..... | 458 |
| Radio (AM/FM)..... | 218 |
| Radio (XM®)..... | 245 |
| Radio Data System (RDS)..... | 220, 243 |
| Range | 96, 114 |
| RDS (Radio Data System)..... | 220, 243 |
| Readiness Codes (Emissions Testing) | 525 |
| Real Time AWD with Intelligent Control System™..... | 407 |
| Rear Defogger/Heated Door Mirror Button..... | 170 |
| Rear Seat Back | 185 |
| Rear Seats (Folding Down)..... | 184 |
| Rearview Mirror..... | 175 |
| Refueling..... | 429 |
| Fuel Gauge..... | 94 |
| Gasoline..... | 429, 520 |
| Low Fuel Indicator | 72 |
| Regulations | 410, 478, 523 |
| Remote Transmitter..... | 137 |
| Replacement | |
| Battery..... | 485 |
| Bulbs | 462 |
| Front Wiper Blade Rubber..... | 471 |
| Fuses | 513, 514 |
| Rear Wiper Blade Rubber..... | 473 |

| | |
|-------------------------------|-----|
| Tires..... | 481 |
| Reporting Safety Defects..... | 524 |
| Resetting a Trip Meter..... | 96 |

S

| | |
|--|--------|
| Safe Driving | 27 |
| Safety Check | 32 |
| Safety Labels..... | 68 |
| Safety Message..... | 1 |
| Seat Belts | 33 |
| Adjusting the Shoulder Anchor..... | 37 |
| Automatic Seat Belt Tensioners | 35 |
| Checking..... | 40 |
| Detachable Anchor..... | 38 |
| Fastening | 36 |
| Installing a Child Seat with a Lap/Shoulder Seat Belt..... | 62 |
| Pregnant Women | 39 |
| Reminder | 34 |
| Warning Indicator | 34, 72 |
| Seat Heaters..... | 197 |
| Seats..... | 177 |
| Adjusting | 177 |
| Driver's Seat Lumbar Support | 177 |
| Front Seats..... | 177 |
| Rear Seats | 184 |
| Seat Heaters..... | 197 |
| Security System..... | 149 |
| Immobilizer System Indicator | 78 |
| Security System Alarm Indicator..... | 78 |

| | |
|--------------------------------------|----------|
| SEL/RESET Button | 98 |
| Select Lever | 19, 372 |
| Operation | 19, 373 |
| Releasing | 506 |
| Won't Move | 506 |
| Select/Reset Knob | 95 |
| Selecting a Child Seat | 58 |
| Selector Knob (Audio) | 216 |
| Setting the Clock..... | 130 |
| Shift Lever | 19, 372 |
| Shift Lever Position Indicator | 71, 373 |
| Shifting (Transmission) | 372 |
| Shoulder Anchor | 37 |
| Side Airbags | 48 |
| Side Curtain Airbags | 50 |
| Siri Eyes Free..... | 264 |
| Smart Entry System | 135 |
| SMS Text Message..... | 300, 312 |
| Snow Tires | 483 |
| Spare Tire | 495, 521 |
| Spark Plugs | 520 |
| Specifications | 520 |
| Specified Fuel | 429, 520 |
| Speedometer..... | 94 |
| SRS Airbags (Airbags) | 44 |
| Starting the Engine..... | 364, 366 |
| Does Not Start | 501 |
| Engine Switch Buzzer..... | 155, 158 |
| Jump Starting | 504 |
| Steering Wheel | 174 |
| Adjusting..... | 174 |

| | |
|--|-----------|
| Stopping | 425 |
| Summer Tires | 483 |
| Sunglasses Holder | 196 |
| Supplemental Restraint System (SRS) | 44 |
| Switches (Around the Steering Wheel) | 4, 5, 155 |
| Synchronized Mode | 205 |

T

| | |
|--|----------|
| Tachometer | 94 |
| Tailgate | 142 |
| Remote Transmitter | 144 |
| Unable to Open | 517 |
| Temperature Gauge | 94 |
| Temperature Sensor | 206 |
| Text Message | 300, 312 |
| Time (Setting) | 130 |
| Tire Pressure Monitoring System (TPMS) | 408 |
| Button | 408 |
| Indicator | 76 |
| Tires | 475 |
| Air Pressure | 476, 521 |
| Checking and Maintaining | 475 |
| Inspection | 475 |
| Labeling | 476 |
| Puncture (Flat Tire) | 495 |
| Regulations | 478 |
| Rotation | 482 |
| Spare Tire | 495, 521 |

| | |
|--|----------|
| Summer | 483 |
| Tire Chains | 483 |
| Wear Indicators | 480 |
| Winter | 483 |
| Tonneau Cover | 198 |
| Tools | 494 |
| Towing a Trailer | 357 |
| Equipment and Accessories | 358 |
| Load Limits | 357 |
| Towing Your Vehicle | 361 |
| Behind a Motorhome | 361 |
| Emergency | 516 |
| TPMS (Tire Pressure Monitoring System) | 408 |
| Button | 408 |
| Indicator | 76 |
| Transmission | 372 |
| Continuously Variable | 372 |
| Fluid | 459 |
| Number | 522 |
| Shift Lever Position Indicator | 71, 373 |
| Trip Meter | 96, 99 |
| Troubleshooting | 493 |
| Blown Fuse | 513, 514 |
| Brake Pedal Vibrates | 25 |
| Buzzer Sounds When Opening Door | 25 |
| Emergency Towing | 516 |
| Engine Won't Start | 501 |
| Noise When Braking | 26 |
| Overheating | 507 |
| Puncture/Flat Tire | 495 |

| | |
|-------------------------------------|---------|
| Rear Door Won't Open | 25, 140 |
| Select Lever Won't Move | 506 |
| Warning Indicators | 70 |
| Turn Signals | 160 |
| Indicators (Instrument Panel) | 77 |

U

| | |
|---|----------|
| Unlocking the Doors | 135 |
| Unlocking the Front Doors from the Inside | 14 |
| USB Adapter Cable | 208, 210 |
| USB Flash Drives | 273 |
| USB Port(s) | 208, 211 |

V

| | |
|---------------------------------------|----------|
| Valet Key | 133 |
| Vanity Mirrors | 7 |
| Vehicle Identification Number | 522 |
| Vehicle Stability Assist (VSA®) | 403 |
| Off Button | 404 |
| Off Indicator | 74 |
| System Indicator | 74 |
| Viscosity (Oil) | 452, 521 |
| VSA® (Vehicle Stability Assist) | 403 |

W

| | |
|--|----------|
| Wallpaper | 125, 238 |
| Warning and Information Messages | 88 |
| Warning Indicator On/Blinking | 509 |

| | |
|---|---------------|
| Warning Labels | 68 |
| Warranties (Warranty Manual provided separately)..... | 527 |
| Watts | 520 |
| Wear Indicators (Tire)..... | 480 |
| Wheel Nut Wrench (Jack Handle)..... | 498 |
| Window Washers..... | 166 |
| Adding/Refilling Fluid..... | 461 |
| Switch | 166 |
| Windows (Opening and Closing)..... | 152 |
| Windshield | 166 |
| Cleaning..... | 488, 491 |
| Defrosting/Defogging | 202, 204 |
| Washer Fluid..... | 461 |
| Wiper Blades | 471 |
| Wipers and Washers..... | 166 |
| Winter Tires..... | 483 |
| Snow Tires..... | 483 |
| Tire Chains | 483 |
| Wipers and Washers | 166 |
| Automatic Intermittent Wipers..... | 167 |
| Checking and Replacing Wiper Blades | 471 |
| Front | 166 |
| Rear..... | 168 |
| WMA | 221, 229, 256 |
| Worn Tires..... | 475 |

X

| | |
|----------------|-----|
| XM® Radio..... | 245 |
|----------------|-----|