

2013 CR-V

Online Reference Owner's Manual

This owner's manual should be considered a permanent part of the vehicle and should remain with the vehicle when it is sold.

This owner's manual covers all models of your vehicle. You may find descriptions of equipment and features that are not on your particular model.

Images throughout this owner's manual (including the front cover) represent features and equipment that are available on some, but not all, models. Your particular model may not have some of these features.

This owner's manual is for vehicles sold in the United States and Canada.

The information and specifications included in this publication were in effect at the time of approval for printing. Honda Motor Co., Ltd. reserves the right, however, to discontinue or change specifications or design at any time without notice and without incurring any obligation.

Navigation Key	
ORG	Quick Reference Guide
TOC	Chapter Table of Contents
Index	Index
Home	Book Table of Contents

➤ Safe Driving P. 23

For Safe Driving P. 24

Seat Belts P. 29

Airbags P. 37

➤ Instrument Panel P. 67

Indicators P. 68

Gauges and Displays P. 77

➤ Controls P. 95

Lock P. 96

Locking and Unlocking the Doors P. 97

Opening and Closing the Moonroof* P. 110

Adjusting the Seats P. 122

Climate Control System* P. 145

➤ Features P. 149

Audio System P. 150

Audio System Basic Operation P. 153

General Information on the Audio System P. 190

➤ Driving P. 225

Before Driving P. 226

Towing a Trailer P. 231

Parking Your Vehicle P. 258

Multi-View Rear Camera P. 259

➤ Maintenance P. 265

Before Performing Maintenance P. 266

Maintenance Minder™ P. 269

Checking and Maintaining Wiper Blades P. 294

Remote Control and Wireless Headphone Care* P. 309

➤ Handling the Unexpected P. 317

Tools P. 318

If a Tire Goes Flat P. 319

Overheating P. 329

Indicator, Coming On/Blinking P. 331

➤ Information P. 341

Specifications P. 342

Identification Numbers P. 344

Emissions Testing P. 347

Warranty Coverages P. 349

* Not available on all models

Contents

2013 CR-V

Child Safety [P. 52](#)

Exhaust Gas Hazard [P. 65](#)

Safety Labels [P. 66](#)

Opening and Closing the Tailgate [P. 104](#) Security System [P. 106](#)
Operating the Switches Around the Steering Wheel [P. 111](#)
Interior Lights/Interior Convenience Items [P. 132](#)

Opening and Closing the Windows [P. 108](#)
Adjusting the Mirrors [P. 120](#)
Heating and Cooling System* [P. 142](#)

Rear Entertainment System* [P. 174](#)
Bluetooth® HandsFreeLink® [P. 194](#)

Audio Error Messages [P. 186](#)
Compass [P. 223](#)

Off-Highway Driving Guidelines [P. 237](#)
Refueling [P. 260](#)

When Driving [P. 239](#)
Fuel Economy [P. 263](#)

Braking [P. 254](#)
Accessories and Modifications [P. 264](#)

Maintenance Under the Hood [P. 275](#) Replacing Light Bulbs [P. 287](#)
Checking and Maintaining Tires [P. 298](#) Battery [P. 307](#)
Heating and Cooling System*/Climate Control System* Maintenance [P. 311](#)

Remote Transmitter Care [P. 308](#)
Cleaning [P. 312](#)

Engine Does Not Start [P. 325](#)
Fuses [P. 335](#)

Jump Starting [P. 326](#)
Emergency Towing [P. 338](#)

Shift Lever Does Not Move [P. 328](#)
When You Cannot Open the Tailgate [P. 339](#)

Devices that Emit Radio Waves [P. 345](#)
Authorized Manuals [P. 351](#)

Reporting Safety Defects [P. 346](#)
Customer Service Information [P. 352](#)

* Not available on all models

Quick Reference Guide [P. 2](#)

Safe Driving [P. 23](#)

Instrument Panel [P. 67](#)

Controls [P. 95](#)

Features [P. 149](#)

Driving [P. 225](#)

Maintenance [P. 265](#)

Handling the Unexpected [P. 317](#)

Information [P. 341](#)

Index [P. 353](#)

Navigation Key

[QRG](#) Quick Reference Guide

[Index](#)

[TOC](#) Chapter Table of Contents

[Home](#)

Visual Index

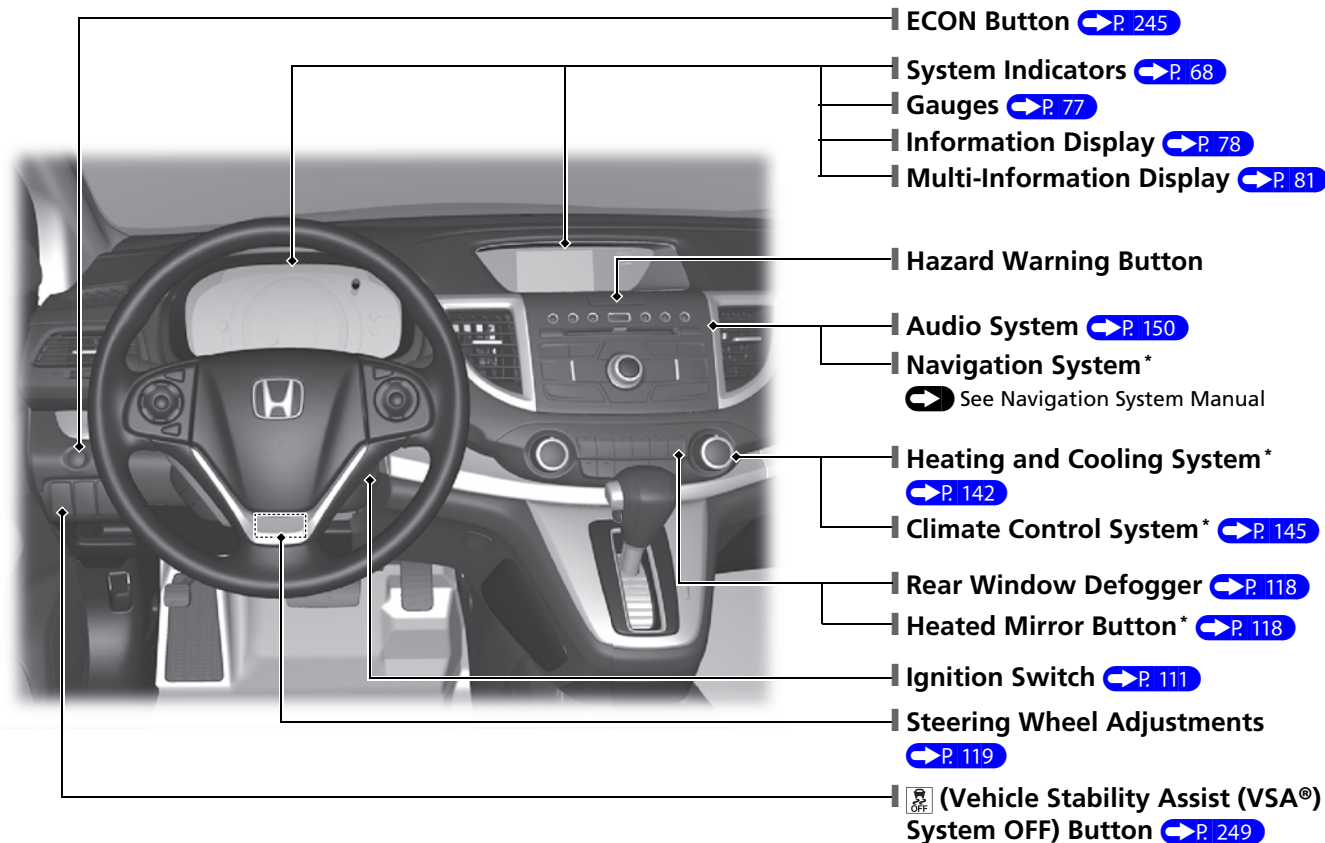

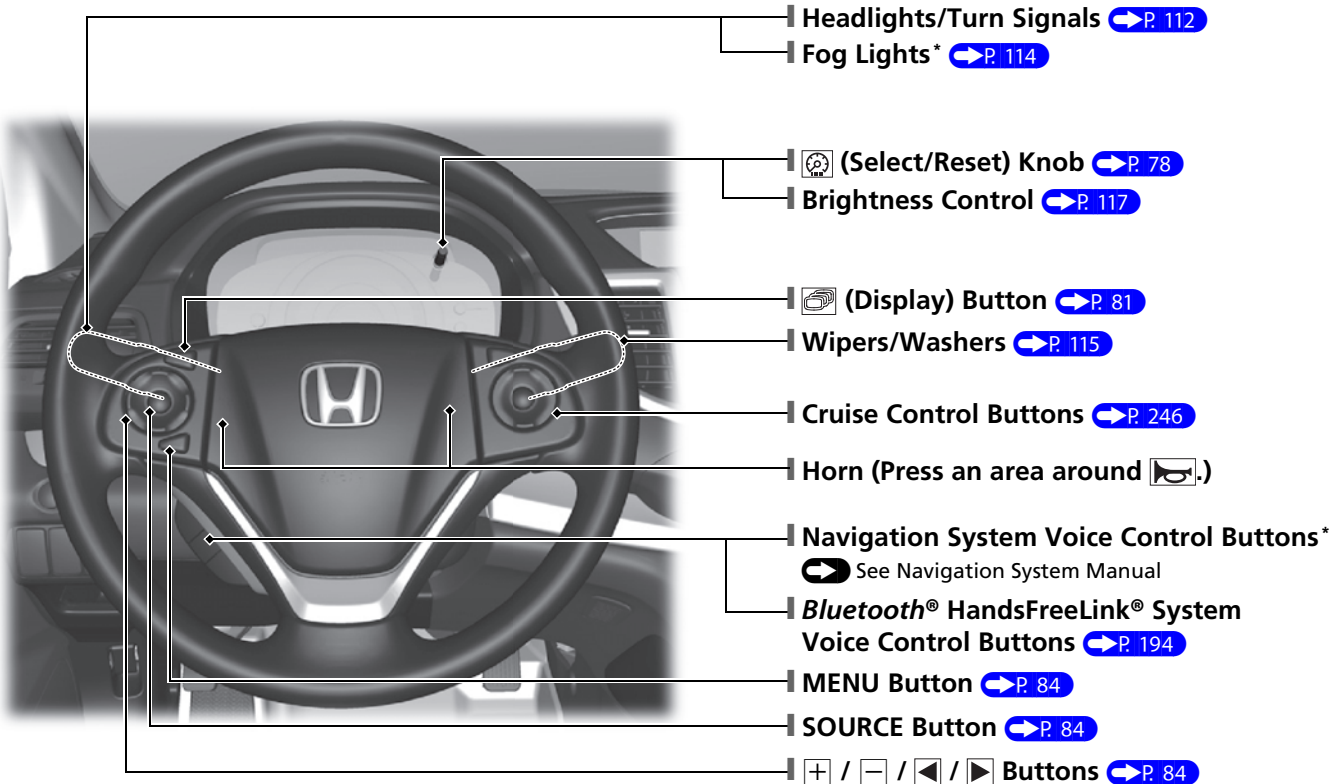

Visual Index

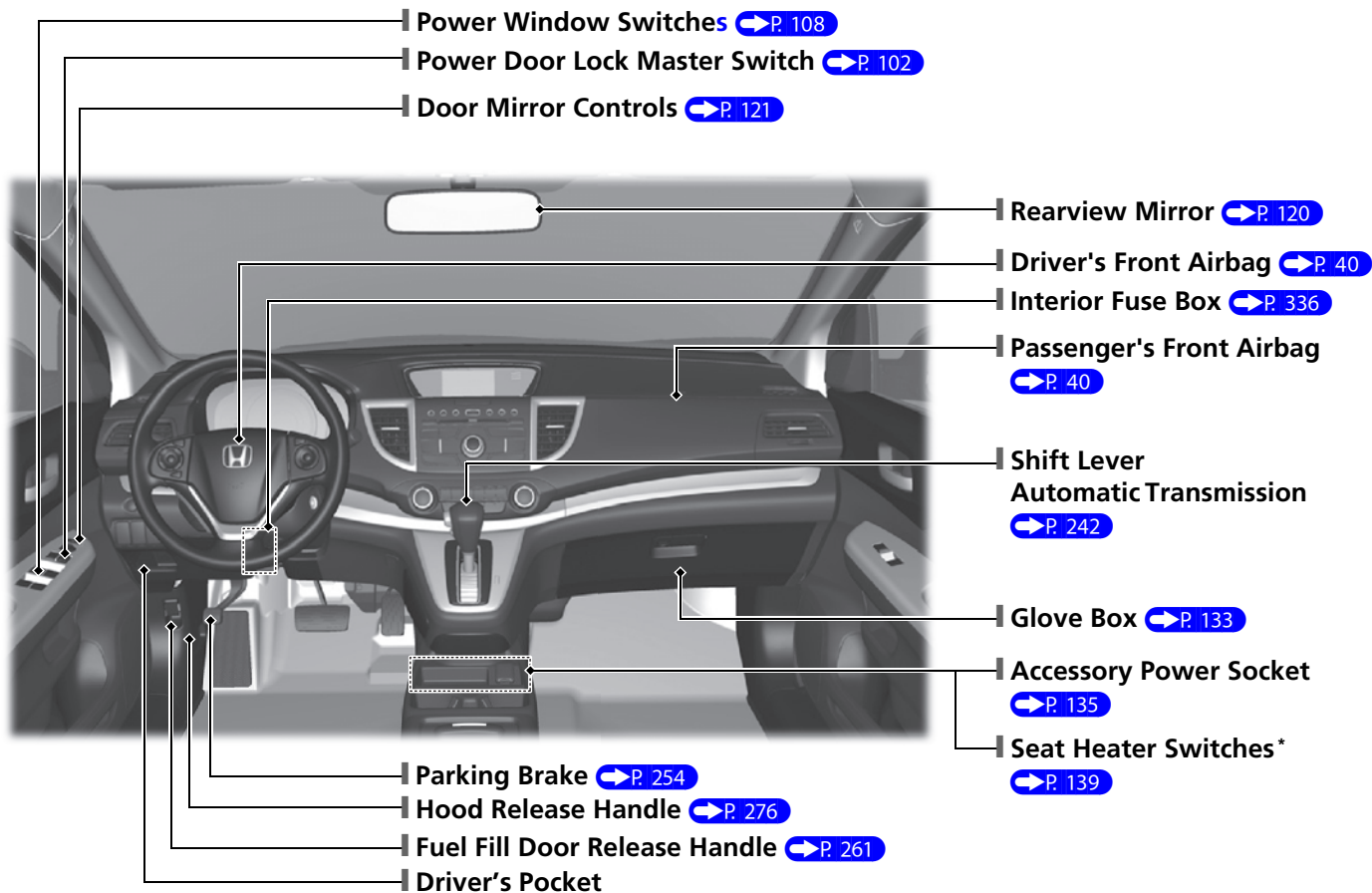

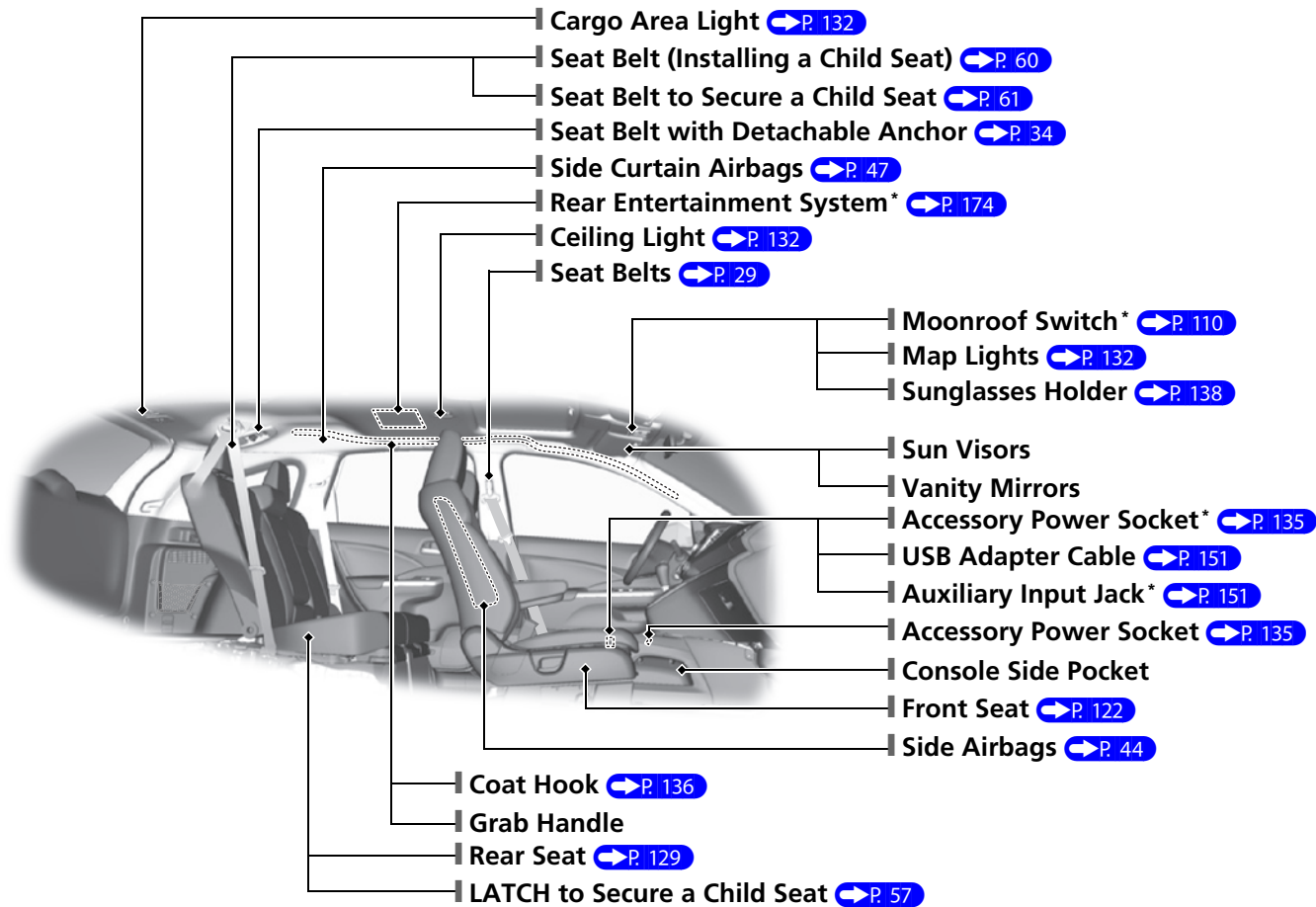

Visual Index

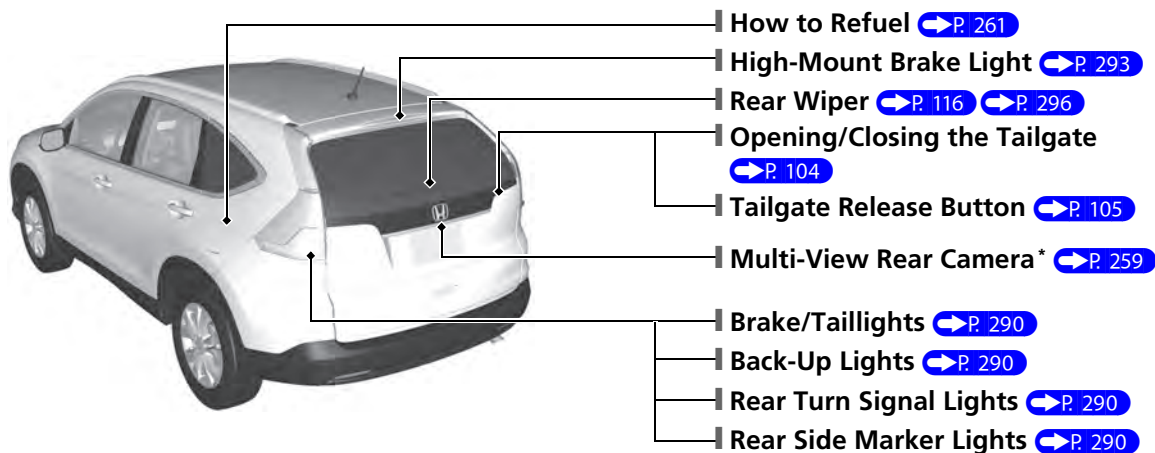
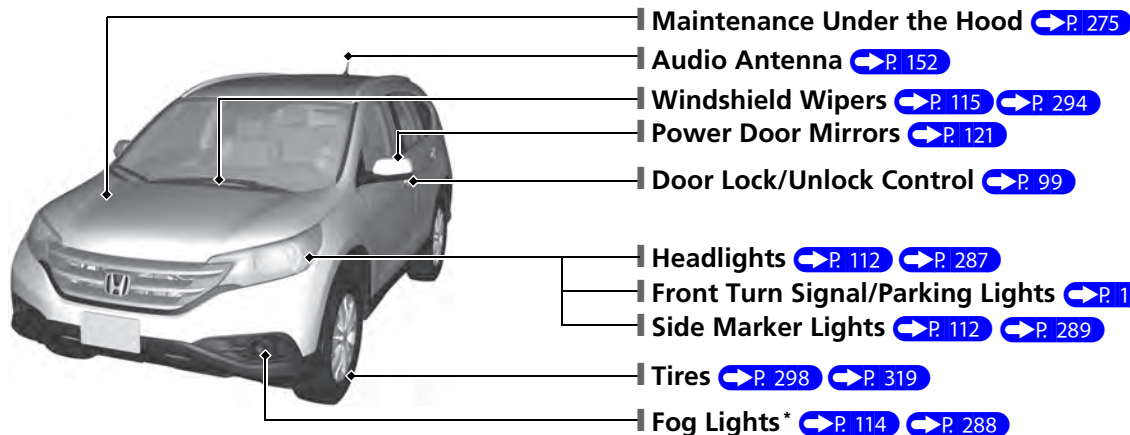

Eco Assist System [P. 245](#)

Ambient Meter

- Changes color to reflect your driving style.
 - Green: Fuel efficient driving
 - Yellow: Moderate acceleration/ deceleration
 - White: Aggressive acceleration/ deceleration
- The ambient meter color changes in accordance with your brake or accelerator pedal operation.

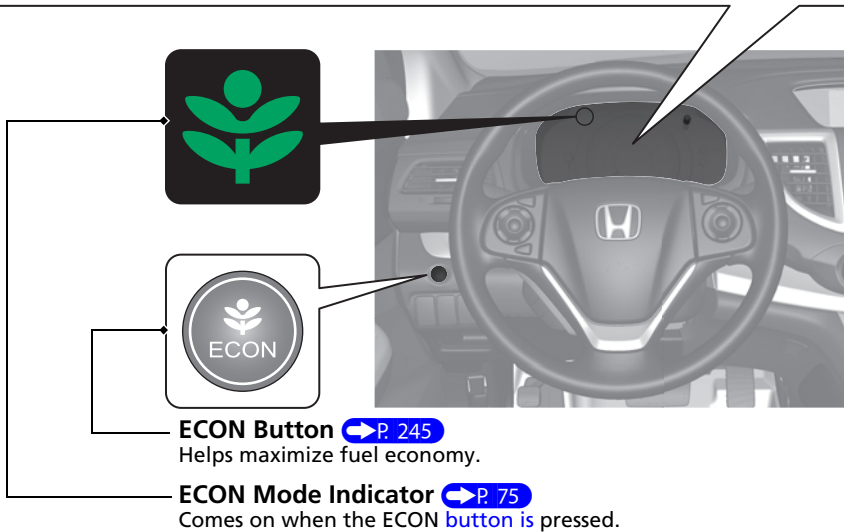
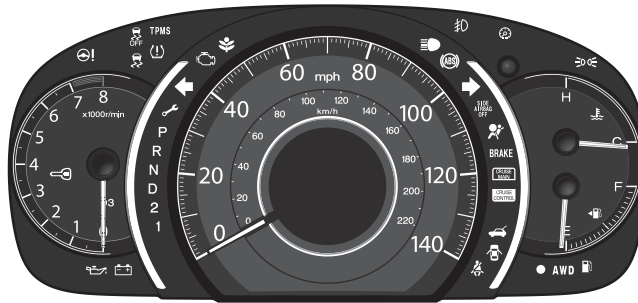

Safe Driving [↔ P. 23](#)

Airbags [↔ P. 37](#)

- Your vehicle is fitted with airbags to help protect you and your passengers during a moderate-to-severe collision.

Child Safety [↔ P. 52](#)

- All children 12 and younger should be seated in the rear seat.
- Smaller children should be properly restrained in a forward-facing child seat.
- Infants must be properly restrained in a rear-facing child seat.

Exhaust Gas Hazard [↔ P. 65](#)

- Your vehicle emits dangerous exhaust gases that contain carbon monoxide. Do not run the engine in confined spaces where carbon monoxide gas can accumulate.

Seat Belts [↔ P. 29](#)

- Fasten your seat belt and sit upright well back in the seat.
- Check that your passengers are wearing their seat belts correctly.

Before Driving Checklist [↔ P. 28](#)

- Before driving, check that the front seats, head restraints, steering wheel, and mirrors have been properly adjusted.

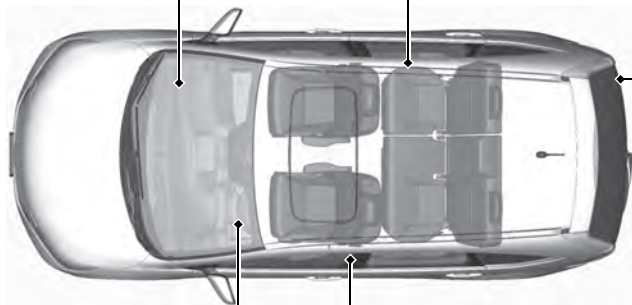











Fasten your lap belt as low as possible.

Instrument Panel ↔ P. 67

Gauges ↔ P. 77 / Information Display ↔ P. 78 /

Multi-Information Display ↔ P. 81 / System Indicators ↔ P. 68

System Indicators

-  Malfunction Indicator Lamp
-  Low Oil Pressure Indicator
-  Charging System Indicator
-  Anti-lock Brake System (ABS) Indicator
-  Vehicle Stability Assist (VSA®) System Indicator
-  VSA® OFF Indicator
-  Door Open Indicator
-  Tailgate Open Indicator
-  ECON Mode Indicator
-  Immobilizer System Indicator

-  **BRAKE**
U.S. Parking Brake and Brake System Indicator
-  **Canada**

Shift Lever Position Indicator

Temperature Gauge

Ambient Meter

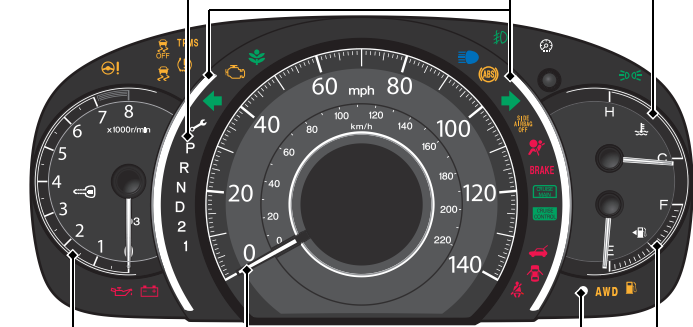

Tachometer

Speedometer



Security System Alarm Indicator

Fuel Gauge













System Indicators

-  **TPMS** TPMS Indicator
-  Low Tire Pressure Indicator

Lights Reminders

-  Lights On Indicator
-  High Beam Indicator
-  Fog Light Indicator*

System Indicators

-  **AWD** AWD System Indicator*
-  Turn Signal and Hazard Warning Indicators
-  Electric Power Steering (EPS) Indicator
-  Low Fuel Indicator
-  Seat Belt Reminder Indicator
-  Supplemental Restraint System Indicator
-  **SIDE AIRBAG OFF U.S.**
-  **Canada**
-  **CRUISE MAIN**
-  **CRUISE CONTROL**
-  Maintenance Minder Indicator
-  Washer Level Indicator*

* Not available on all models

Controls ➔ P.95

Turn Signals ➔ P.112

Turn Signal Control Lever

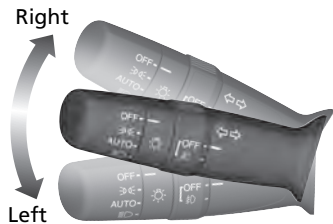

Lights ➔ P.112

Light Control Switches

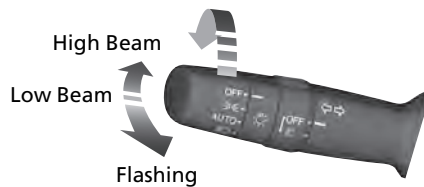

Wipers and Washers ➔ P.115

Wiper/Washer Control Lever

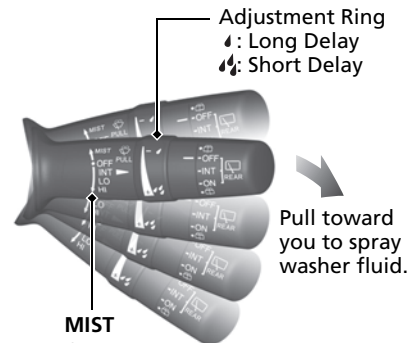

Steering Wheel P.119

- To adjust, pull the adjustment lever towards you, adjust to the desired position, then lock the lever back in place.

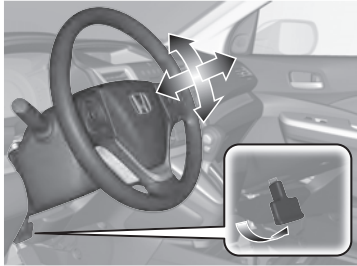

Unlocking the Front Doors from the Inside

 P.101

- Pull either front door inner handle to unlock and open it at the same time.

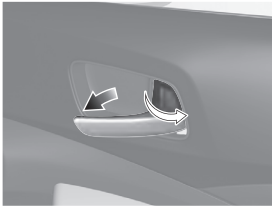

Tailgate P.104



- With all the doors unlocked, push the tailgate release button on the tailgate to open it.

Power Door Mirrors

 P.121

- With the ignition switch in ON , move the selector switch to L or R.
- Push the appropriate edge of the adjustment switch to adjust the mirror.

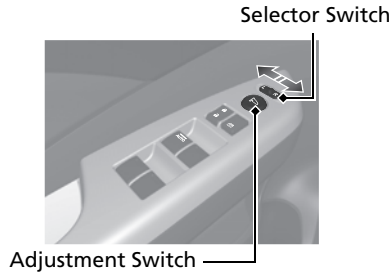

Power Windows P.108



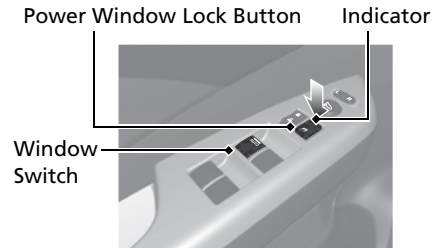

- With the ignition switch in ON , open and close the power windows.
- If the power window lock button is in the off position, each passenger's window can be opened and closed with its own switch.
- If the power window lock button is in the on position (indicator is on), each passenger's window switch is disabled.



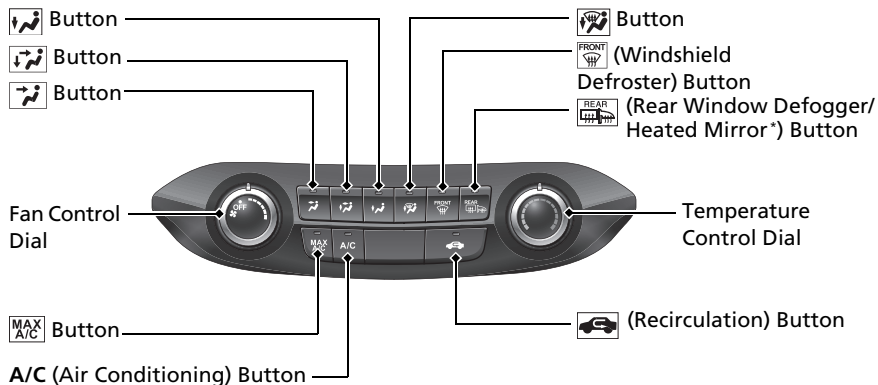

Heating and Cooling System* ➔ P. 142

- Rotate the fan control dial to adjust the fan speed.
- Press the Mode buttons (↔↘ / ↘↘ / ↘↘ / ↘↘) to select the vents air flows from.
- Rotate the temperature control dial to adjust the temperature.
- Use the MAX
A/C button for maximum cool setting.
- Rotate the fan control dial to **OFF** to turn the system off.
- Press the FRONT
SH button to defrost the windshield.



-  Air flows from dashboard vents.
-  Air flows from floor and dashboard vents.
-  Air flows from floor vents.
-  Air flows from floor and windshield defroster vents.





Climate Control System* ➔ P. 145

- Press the **AUTO** button to activate the climate control system.
- Press the  button to turn the system on or off.
- Press the  button to defrost the windshield.

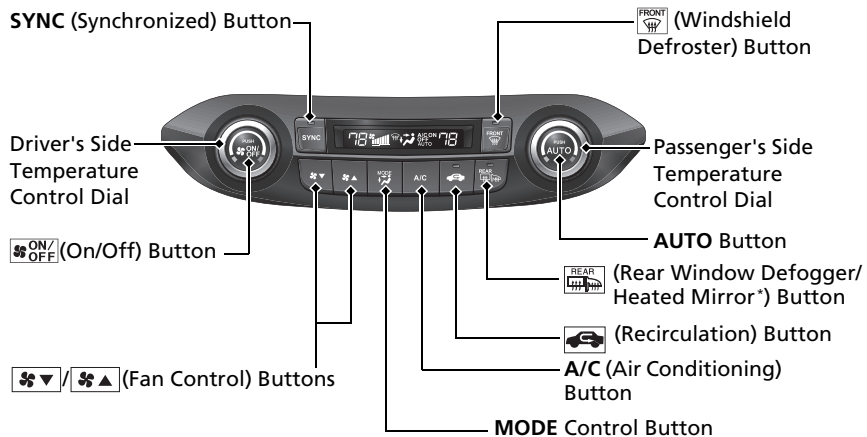
Models with navigation system

The climate control system is voice operable. See the navigation system manual for complete details.



-  Air flows from dashboard vents.
-  Air flows from floor and dashboard vents.
-  Air flows from floor vents.
-  Air flows from floor and windshield defroster vents.

Clock ➔ P. 96

Models without navigation system

- 1** Press the **CLOCK (AUX)** button until the displayed time begins flashing.
- 2** Press Preset **[4]** (Hour) or **[5]** (Minute) to set the time. Press Preset **[6]** (Reset) to set the time to the nearest hour.
- 3** Press the **CLOCK** button again to set the time.

To set the time to the nearest hour: Press and hold the **CLOCK** button until the clock display begins to blink, then press the **[6]** (Reset) button.

Depending on the displayed time, the clock sets forward or backward.

Example:

1:06 will reset to 1:00

1:53 will reset to 2:00

Models with navigation system

The navigation system receives signals from GPS satellites, updating the clock automatically.

Features [P. 149](#)

Audio System [P. 150](#)

For navigation system operation [See Navigation System Manual](#)

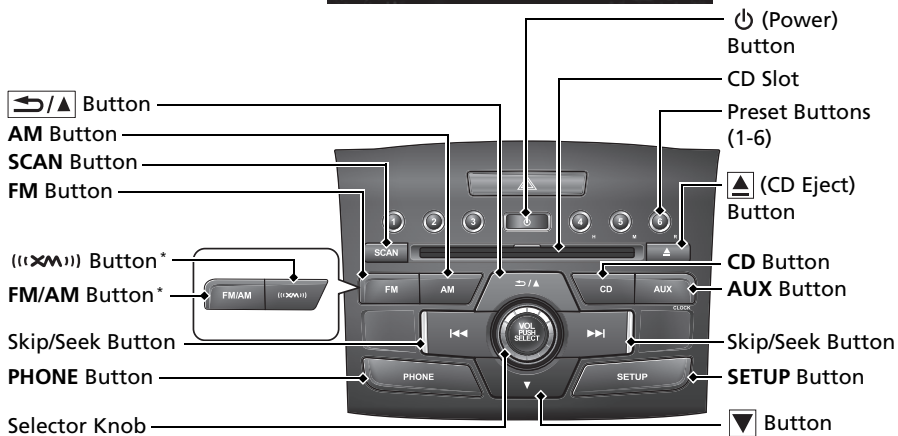

● Audio Remote Controls [P. 154](#)

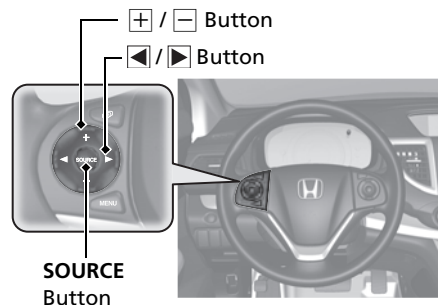

- (+ / -) Button
Press and release to adjust the volume up/down.
- SOURCE Button
Press and release to change the audio mode: FM1/FM2/AM/CD/XM1*/XM2*/AUX.
- (Left Arrow) / (Right Arrow) Button
Radio: Press and release to change the preset station.
Press and hold to select the next or previous strong station.
CD/USB device:
Press and release to skip to the beginning of the next song or return to the beginning of the current song.
Press and hold to change a folder.

Driving ➔ P. 225

Automatic Transmission ➔ P. 243

- Shift to **P** and depress the brake pedal when starting the engine.

● Shifting

P **Park**
Turn off or start the engine.
Transmission is locked.

R **Reverse**

N **Neutral**
Transmission is not locked.

D **Drive**
Normal driving.

2 **Second**
Used to increase engine braking
(the transmission is locked in 2nd gear)

1 **First**
Used to further increase engine braking
(the transmission is locked in 1st gear)

D3 **Drive (D3)**
Press the **D3** button while the shift lever is in **D**.
Used when:
• Going up or down hills
• Towing a trailer in hilly terrain

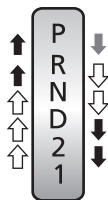
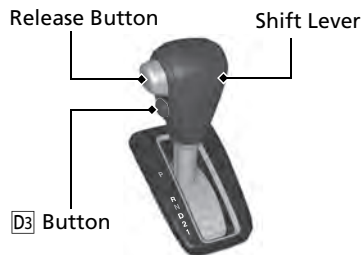

- ↓ Depress the brake pedal and press the release button to move out of **P**.
- ↓ ↑ Press the release button to move the shift lever.
- ↓ ↑ Move the shift lever without pressing the release button.

VSA® OFF Button P. 250

- The vehicle stability assist (VSA®) system helps stabilize the vehicle during cornering, and helps maintain traction while accelerating on loose or slippery road surfaces.
- VSA® comes on automatically every time you start the engine.
- To turn VSA® on or off, press and hold the button until you hear a beep.

Cruise Control P. 246

- Cruise control allows you to maintain a set speed without keeping your foot on the accelerator pedal.
- To use cruise control, press the **CRUISE** button, then press **-/SET** once you have achieved the desired speed (above 25 mph or 40 km/h).

Tire Pressure Monitoring System (TPMS) P. 251

- TPMS monitors tire pressure.
- TPMS is turned on automatically every time you start the engine.

Refueling P. 260

Fuel recommendation: Unleaded gasoline with a pump octane number 87 or higher required

Fuel tank capacity: 15.3 US gal (58 L)

- 1** Pull the fuel fill door release handle.



- 2** Turn the fuel fill cap slowly to remove the cap.

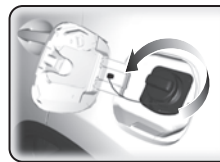

- 3** Place the cap in the holder on the fuel fill door.



- 4** After refueling, screw the cap back on until it clicks at least once.

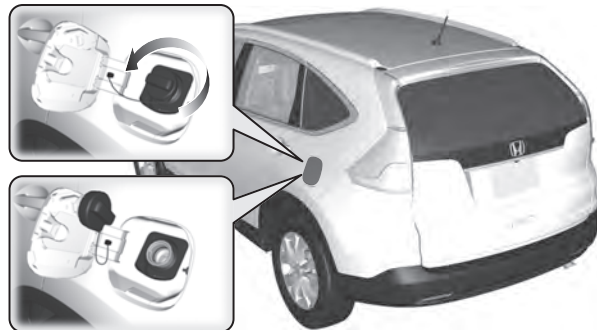

Maintenance [➔ P. 265](#)

Under the Hood [➔ P. 275](#)

- Check engine oil, engine coolant, and windshield washer fluid. Add when necessary.
- Check brake fluid.
- Check the battery condition monthly.

- 1** Pull the hood release handle under the corner of the dashboard.

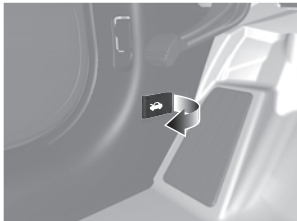

- 2** Locate the hood latch lever, pull the lever up, and lift up the hood.

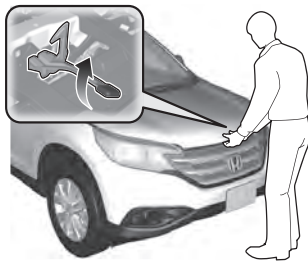

- 3** When finished, close the hood and make sure it is firmly locked in place.

Wiper Blades [➔ P. 294](#)

- Replace blades if they leave streaks across the windshield.



Tires [➔ P. 298](#)

- Inspect tires and wheels regularly.
- Check tire pressures regularly.
- Install snow tires for winter driving.

Lights [➔ P. 287](#)

- Inspect all lights regularly.

Handling the Unexpected [↔ P.317](#)

Flat Tire [↔ P.319](#)

- Park in a safe location and replace the flat tire with the compact spare tire in the cargo area.



Engine Won't Start [↔ P.325](#)

- If the battery is dead, jump start using a booster battery.



Overheating [↔ P.329](#)

- Park in a safe location. If you do not see steam under the hood, open the hood, and let the engine cool down.



Indicators Come On

[↔ P.331](#)

- Identify the indicator and consult the owner's manual.



Blown Fuse [↔ P.335](#)

- Check for a blown fuse if an electrical device does not operate.

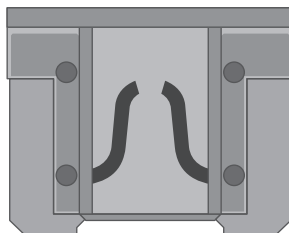

Emergency Towing [↔ P.338](#)

- Call a professional towing service if you need to tow your vehicle.



What to Do If

Q The ignition switch does not turn from **0** to **I**. Why?

A

- The steering wheel may be locked.
- Try to turn the steering wheel left and right while turning the ignition key.



Q The ignition switch does not turn from **I** to **0** and I cannot remove the key. Why?

A The shift lever should be moved to **P**.



Q Why does the brake pedal pulsate slightly when applying the brakes?

A This can occur when the ABS activates, and does not indicate a problem. Apply firm, steady pressure on the brake pedal. Never pump the brake pedal.

Q The rear door cannot be opened from inside the vehicle. Why?

A Check if the childproof lock is in the lock position. If so, open the rear door with the outside door handle. To cancel this function, push the lever to the unlock position.



Q Why do the doors lock after I unlocked the doors using a remote transmitter?

A If you do not open the doors within 30 seconds, the doors are relocked automatically for security.

Q Why does the beeper sound when I open the driver's door?

A The beeper sounds when:

- The key is left in the ignition switch.
- The exterior lights are left on.

Q Why does the beeper sound when I start driving?

A The beeper sounds when:

- Driver and/or front passenger are not wearing their seat belts.
- The parking brake lever is not fully released.

Q Why do I hear a screeching sound when I apply the brake pedal?

A The brake pads may need to be replaced. Have your vehicle inspected by a dealer.

California Proposition 65 Warning

WARNING: This product contains or emits chemicals known to the state of California to cause cancer and birth defects or other reproductive harm.

Event Data Recorders

This vehicle is equipped with an event data recorder (EDR).

The main purpose of an EDR is to record, in certain crash or near crash-like situations, such as an air bag deployment or hitting a road obstacle, data that will assist in understanding how a vehicle's systems performed. **The EDR is designed to record data related to vehicle dynamics and safety systems for a short period of time, typically 30 seconds or less. The EDR in this vehicle is designed to record such data as:**

- **How various systems in your vehicle were operating;**
- **Whether or not the driver and passenger safety belts were buckled/fastened;**
- **How far (if at all) the driver was depressing the accelerator and/or brake pedal; and,**
- **How fast the vehicle was traveling.**

These data can help provide a better understanding of the circumstances in which crashes and injuries occur. NOTE: EDR data are recorded by your vehicle only if a non-trivial crash situation occurs; no data are recorded by the EDR under normal driving conditions and no personal data (e.g., name, gender, age, and crash location) are recorded. However, other parties, such as law enforcement, could combine the EDR data with the type of personally identifying data routinely acquired during a crash investigation.

To read data recorded by an EDR, special equipment is required, and access to the vehicle or the EDR is needed. In addition to the vehicle manufacturer, other parties, such as law enforcement, that have the special equipment, can read the information if they have access to the vehicle or the EDR.

The data belongs to the vehicle owner and may not be accessed by anyone else except as legally required or with the permission of the vehicle owner.

Service Diagnostic Recorders

This vehicle is equipped with service-related devices that record information about powertrain performance. The data can be used to verify emissions law requirements and/or help technicians diagnose and solve service problems. It may also be combined with data from other sources for research purposes, but it remains confidential.

California Perchlorate Contamination Prevention Act

The airbags, seat belt tensioners, and CR type batteries in this vehicle may contain perchlorate materials - special handling may apply. See www.dtsc.ca.gov/hazardouswaste/perchlorate/

As you read this manual, you will find information that is preceded by a **NOTICE** symbol. This information is intended to help you avoid damage to your vehicle, other property, or the environment.

A Few Words About Safety

Your safety, and the safety of others, is very important. And operating this vehicle safely is an important responsibility.

To help you make informed decisions about safety, we have provided operating procedures and other information on labels and in this manual. This information alerts you to potential hazards that could hurt you or others.

Of course, it is not practical or possible to warn you about all the hazards associated with operating or maintaining your vehicle. You must use your own good judgement.

You will find this important safety information in a variety of forms, including:

- **Safety Labels** - on the vehicle.
- **Safety Messages** - preceded by a safety alert symbol  and one of three signal words: **DANGER**, **WARNING**, or **CAUTION**.

These signal words mean:

 **DANGER**

You **WILL** be **KILLED** or **SERIOUSLY HURT** if you don't follow instructions.

 **WARNING**

You **CAN** be **KILLED** or **SERIOUSLY HURT** if you don't follow instructions.

 **CAUTION**

You **CAN** be **HURT** if you don't follow instructions.

- **Safety Headings** - such as Important Safety Precautions.
- **Safety Section** - such as Safe Driving.
- **Instructions** - how to use this vehicle correctly and safely.

This entire book is filled with important safety information - please read it carefully.

Safe Driving

You can find many safety recommendations throughout this chapter, and throughout this manual.

For Safe Driving

Important Safety Precautions	24
Important Handling Information.....	26
Your Vehicle's Safety Features.....	27

Seat Belts

About Your Seat Belts.....	29
Fastening a Seat Belt.....	32
Seat Belt Inspection.....	36

Airbags

Airbag System Components.....	37
Types of Airbags	40
Front Airbags (SRS)	40

Side Airbags	44
Side Curtain Airbags	47
Airbag System Indicators.....	48
Airbag Care	51

Child Safety

Protecting Child Passengers	52
Safety of Infants and Small Children	54
Safety of Larger Children	63

Exhaust Gas Hazard

Carbon Monoxide Gas.....	65
--------------------------	----

Safety Labels

Label Locations	66
-----------------------	----

The following pages explain your vehicle's safety features and how to use them properly. The safety precautions below are ones that we consider to be among the most important.

Important Safety Precautions

■ Always wear your seat belt

A seat belt is your best protection in all types of collisions. Airbags are designed to supplement seat belts, not replace them. So even though your vehicle is equipped with airbags, make sure you and your passengers always wear your seat belts, and wear them properly.

■ Restrain all children

Children ages 12 and under should ride properly restrained in a back seat, not the front seat. Infants and small children should be restrained in a child seat. Larger children should use a booster seat and a lap/shoulder seat belt until they can use the belt properly without a booster seat.

■ Be aware of airbag hazards

While airbags can save lives, they can cause serious or fatal injuries to occupants who sit too close to them, or are not properly restrained. Infants, young children, and short adults are at the greatest risk. Be sure to follow all instructions and warnings in this manual.

■ Don't drink and drive

Alcohol and driving don't mix. Even one drink can reduce your ability to respond to changing conditions, and your reaction time gets worse with every additional drink. So don't drink and drive, and don't let your friends drink and drive, either.

▣ Important Safety Precautions

Some states, provinces and territories prohibit the use of cell phones other than hands-free devices by the driver while driving.

■ Pay appropriate attention to the task of driving safely

Engaging in cell phone conversation or other activities that keep you from paying close attention to the road, other vehicles, and pedestrians could lead to a crash. Remember, situations can change quickly, and only you can decide when it is safe to divert some attention away from driving.

■ Control your speed

Excessive speed is a major factor in crash injuries and deaths. Generally, the higher the speed, the greater the risk, but serious injuries can also occur at lower speeds. Never drive faster than is safe for current conditions, regardless of the maximum speed posted.

■ Keep your vehicle in safe condition

Having a tire blowout or a mechanical failure can be extremely hazardous. To reduce the possibility of such problems, check your tire pressures and condition frequently, and perform all regularly scheduled maintenance.

Important Handling Information

Your vehicle has higher ground clearance than a passenger vehicle designed for use only on pavement. Higher ground clearance has many advantages for off-highway driving. It allows you to travel over bumps, obstacles, and rough terrain. It also provides good visibility so you can anticipate problems earlier.

These advantages come at some cost. Because your vehicle is taller and rides higher off the ground, it has a higher center gravity making it more susceptible to tripping or roll over if you make abrupt turns. Utility vehicles have a significantly higher rollover rate than other types of vehicles. In a rollover crash, an unbelted person is significantly more likely to die than a person wearing a seat belt. As a reminder, make sure you and your passengers always wear seat belts.

Important Handling Information

Failure to operate your vehicle correctly might result in a crash or a rollover.

► [Precautions While Driving P. 241](#)

► [Off-Highway Driving Guidelines P. 237](#)

Your Vehicle's Safety Features

ORG

TOC

Safe Driving

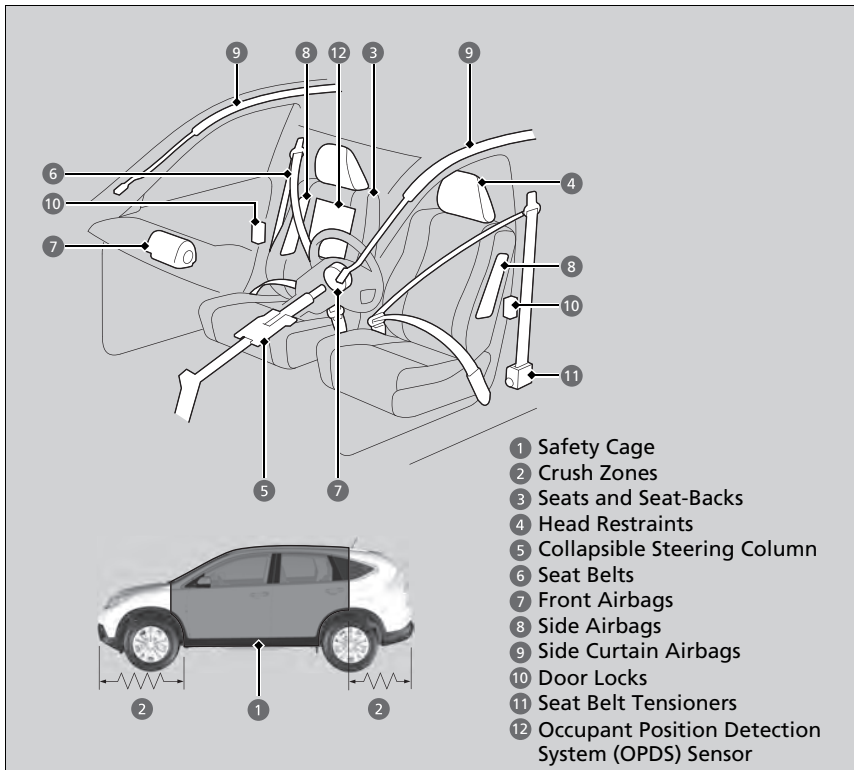

Your Vehicle's Safety Features

Your vehicle is equipped with many features that work together to help protect you and your passengers during a crash.

Some features do not require any action on your part. These include a strong steel framework that forms a safety cage around the passenger compartment, front and rear crush zones, a collapsible steering column, and tensioners that tighten the front seat belts in a sufficient crash.

However, you and your passengers cannot take full advantage of these features unless you remain seated in the correct position and always wear your seat belts. In fact, some safety features can contribute to injuries if they are not used properly.

Index

The following checklist will help you take an active role in protecting yourself and your passengers.

Home

■ Safety Checklist

For the safety of you and your passengers, make a habit of checking these items each time before you drive.

- After everyone has entered the vehicle, be sure all doors and the tailgate are closed and locked. Locking the doors and the tailgate helps prevent an occupant from being ejected and an outsider from unexpectedly opening a door or the tailgate.
 - [Locking/Unlocking the Doors from the Inside P. 101](#)
- Adjust your seat to a position suitable for driving. Be sure the front seats are adjusted as far to the rear as possible while allowing the driver to control the vehicle. Sitting too close to a front airbag can result in serious or fatal injury in a crash.
 - [Adjusting the Seats P. 122](#)
- Adjust head restraints to the proper position. Head restraints are most effective when the center of the head restraint aligns with the center of your head. Taller persons should adjust their head restraint to the highest position.
 - [Adjusting the Head Restraints P. 125](#)
- Always wear your seat belt, and make sure you wear it properly. Confirm that any passengers are properly belted as well.
 - [Fastening a Seat Belt P. 32](#)
- Protect children by using seat belts or child seats according to a child's age, height and weight.
 - [Child Safety P. 52](#)

☒ Safety Checklist

If the door and/or the tailgate open indicator is on, a door and/or the tailgate is not completely closed. Close all doors and the tailgate tightly until the indicator goes off.

- [Door Open Indicator P. 72](#)
- [Tailgate Open Indicator P. 72](#)

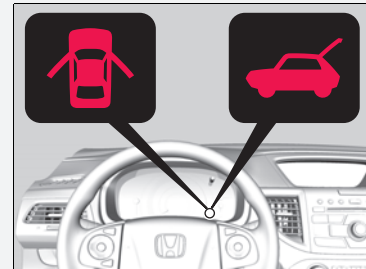

About Your Seat Belts

Seat belts are the single most effective safety device because they keep you connected to the vehicle so that you can take advantage of many built-in safety features. They also help keep you from being thrown against the inside of the vehicle, against other passengers, or out of the vehicle. When worn properly, seat belts also keep your body properly positioned in a crash so that you can take full advantage of the additional protection provided by the airbags.

In addition, seat belts help protect you in almost every type of crash, including:

- frontal impacts
- side impacts
- rear impacts
- rollovers

■ Lap/shoulder seat belts

All five seating positions are equipped with lap/shoulder seat belts with emergency locking retractors. In normal driving the retractor lets you move freely while keeping some tension on the belt. During a collision or sudden stop the retractor locks to restrain your body. The rear seat belts also have a lockable retractor for use with child seats.

[▶ Installing a Child Seat with a Lap/Shoulder Seat Belt P. 60](#)

⌘ About Your Seat Belts

⚠ WARNING

Not wearing a seat belt properly increases the chance of serious injury or death in a crash, even though your vehicle has airbags.

Be sure you and your passengers always wear seat belts and wear them properly.

Seat belts cannot completely protect you in every crash. But in most cases, seat belts can reduce your risk of serious injury.

Most states and all Canadian provinces and territories require you to wear seat belts.

■ Proper use of seat belts

Follow these guidelines for proper use:

- All occupants should sit upright, well back in the seat, and remain in that position for the duration of the trip. Slouching and leaning reduce the effectiveness of the belt and can increase the chance of serious injury in a crash.
- Never place the shoulder part of a lap/shoulder seat belt under your arm or behind your back. This could cause very serious injuries in a crash.
- Two people should never use the same seat belt. If they do, they could be very seriously injured in a crash.
- Do not put any accessories on the seat belts. Devices intended to improve comfort or reposition the shoulder part of a seat belt can reduce the protective capability and increase the chance of serious injury in a crash.

■ Seat Belt Reminder



Your vehicle monitors front seat belt use. If the ignition switch is turned to ON **II** before the driver's seat belt is fastened, the beeper will sound and the indicator will blink. If the driver does not fasten the belt before the beeper stops, the indicator will remain on.

The beeper will also periodically sound and the indicator will blink while driving until the driver's and front passenger's seat belts are fastened.

▶▶ About Your Seat Belts

If a rear seat passenger moves around and extends the seat belt, the lockable retractor may activate. If this happens, release the retractor by unfastening the seat belt and allow the belt to retract completely. Then refasten the belt.

▶▶ Seat Belt Reminder

The indicator will also come on if a front passenger does not fasten their seat belt within six seconds after the ignition switch is turned to ON **II**.

When no one is sitting in the front passenger's seat, or a child or small adult is riding there, the indicator will not come on.

This is because the weight sensors in the seat cannot detect their presence.

Automatic Seat Belt Tensioners

The front seats are equipped with automatic seat belt tensioners to enhance safety.

The tensioners automatically tighten the front seat belts during a moderate-to-severe frontal collision, sometimes even if the collision is not severe enough to inflate the front airbags.

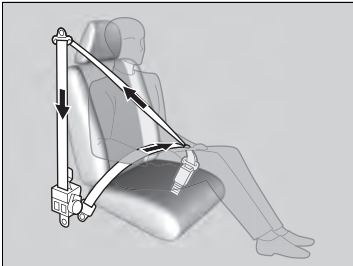

Automatic Seat Belt Tensioners

The seat belt tensioners can only operate once. If a tensioner is activated, the SRS indicator will come on. Have a dealer replace the tensioner and thoroughly inspect the seat belt system as it may not offer protection in a subsequent crash.

During a moderate-to-severe side impact, the tensioner on that side of the vehicle also activates.

Fastening a Seat Belt

After adjusting a front seat to the proper position, and while sitting upright and well back in the seat:

▶ [Adjusting the Seats](#) P. 122

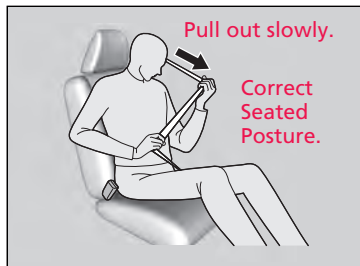

1. Pull the seat belt out slowly.

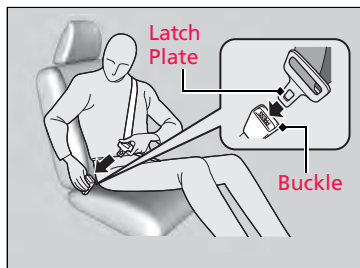

2. Insert the latch plate into the buckle, then tug on the belt to make sure the buckle is secure.

▶ Make sure that the belt is not twisted or caught on anything.

Fastening a Seat Belt

No one should sit in a seat with an inoperative seat belt or one that does not appear to be working correctly. Using a seat belt that is not working properly may not protect the occupant in a crash. Have a dealer check the belt as soon as possible.

Never insert any foreign objects into the buckle or retractor mechanism.

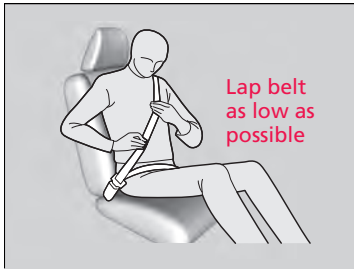

3. Position the lap part of the belt as low as possible across your hips, then pull up on the shoulder part of the belt so the lap part fits snugly. This lets your strong pelvic bones take the force of a crash and reduces the chance of internal injuries.
4. If necessary, pull up on the belt again to remove any slack, then check that the belt rests across the center of your chest and over your shoulder. This spreads the forces of a crash over the strongest bones in your upper body.

■ Adjusting the Shoulder Anchor

The front seats have adjustable shoulder anchors to accommodate taller and shorter occupants.

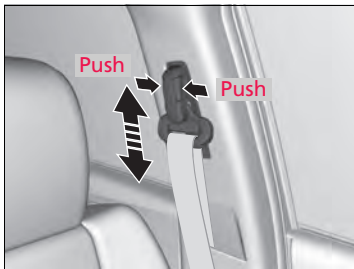

1. Move the anchor up and down while holding the release buttons.
2. Position the anchor so that the belt rests across the center of your chest and over your shoulder.

☒ Fastening a Seat Belt

⚠ WARNING

Improperly positioning the seat belts can cause serious injury or death in a crash.

Make sure all seat belts are properly positioned before driving.

To release the belt, push the red **PRESS** button then guide the belt by hand until it has retracted completely.

When exiting the vehicle, be sure the belt is out of the way and will not get caught by closing the door.

☒ Adjusting the Shoulder Anchor

The shoulder anchor height can be adjusted to four levels. If the belt contacts your neck, lower the height one level at a time.

After an adjustment, make sure that the shoulder anchor position is secure.

Seat Belt with Detachable Anchor

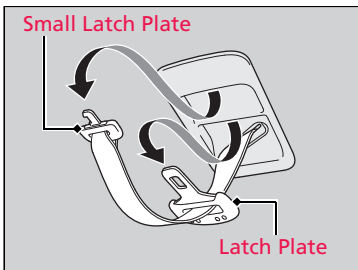

1. Pull out the seat belt's small latch plate and the latch plate from each holding slot in the ceiling.

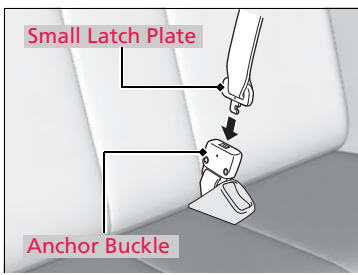

2. Line up the triangle marks on the small latch plate and anchor buckle. Make sure the seat belt is not twisted. Attach the belt to the anchor buckle.

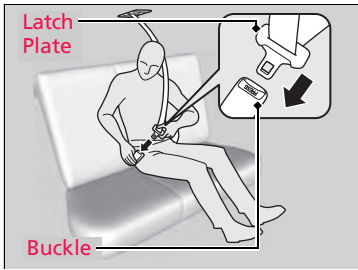

3. Insert the latch plate into the buckle. Properly fasten the seat belt the same way you fasten the lap/shoulder seat belt.

Seat Belt with Detachable Anchor

WARNING

Using the seat belt with the detachable anchor unlatched increases the chance of serious injury or death in a crash.

Before using the seat belt, make sure the detachable anchor is correctly latched.

To unlatch the detachable anchor, insert the latch plate into the slot on the side of the anchor buckle.

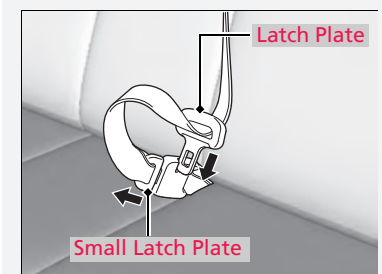

Advice for Pregnant Women

If you are pregnant, the best way to protect yourself and your unborn child when driving or riding in a vehicle is to always wear a seat belt and keep the lap part of the belt as low as possible across the hips.

Wear the shoulder belt across the chest avoiding the abdomen.



Wear the lap part of the belt as low as possible across the hips.

Advice for Pregnant Women

Each time you have a checkup, ask your doctor if it is okay for you to drive.

To reduce the risk of injuries to both you and your unborn child that can be caused by an inflating front airbag:

- When driving, sit upright and adjust the seat as far back as possible while allowing full control of the vehicle.
- When sitting in the front passenger's seat, adjust the seat as far back as possible.

Seat Belt Inspection

Regularly check the condition of your seat belts as follows:

- Pull each belt out fully, and look for frays, cuts, burns, and wear.
- Check that the latches work smoothly and the belts retract easily.
 - ▶ If a belt does not retract easily, cleaning the belt may correct the problem. Only use a mild soap and warm water. Do not use bleach or cleaning solvents. Make sure the belt is completely dry before allowing it to retract.

Any belt that is not in good condition or working properly will not provide proper protection and should be replaced as soon as possible.

A belt that has been worn during a crash may not provide the same level of protection in a subsequent crash. Have your seat belts inspected by a dealer after any collision.

▶▶ Seat Belt Inspection

WARNING

Not checking or maintaining seat belts can result in serious injury or death if the seat belts do not work properly when needed.

Check your seat belts regularly and have any problem corrected as soon as possible.

Airbag System Components

ORG

TOC

Safe Driving

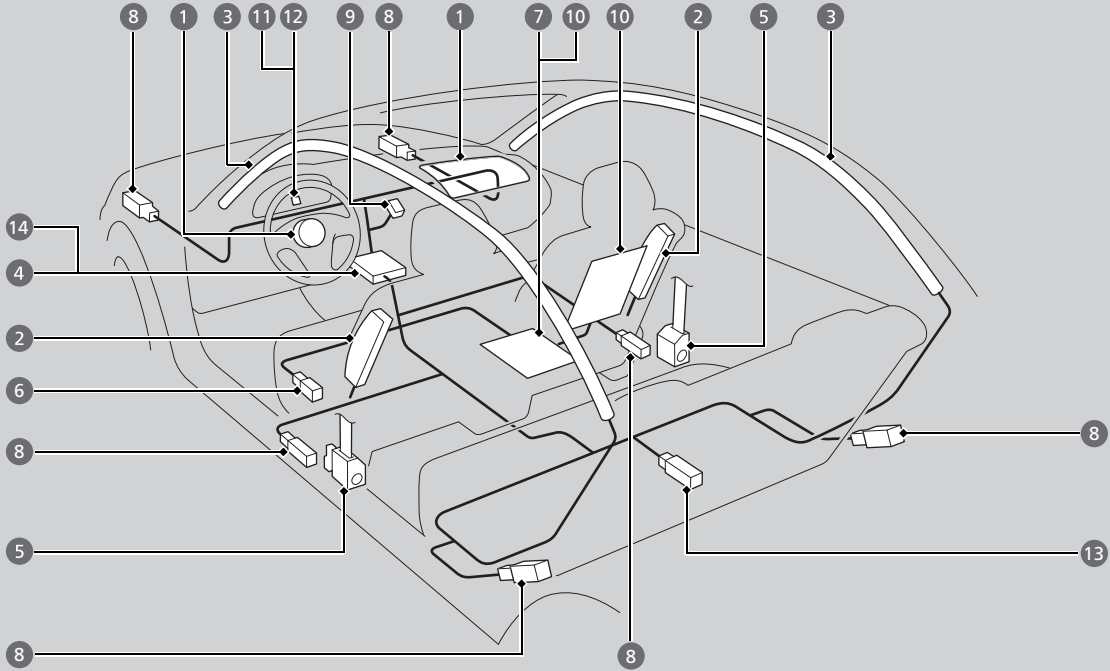

Index

Home

Continued

The front, front side, and side curtain airbags are deployed according to the direction and severity of impact. Both side curtain airbags are deployed in a rollover. The airbag system includes:

- 1 Two SRS (Supplemental Restraint System) front airbags. The driver's airbag is stored in the center of the steering wheel; the front passenger's airbag is stored in the dashboard. Both are marked **SRS AIRBAG**.
- 2 Two side airbags, one for the driver and one for a front passenger. The airbags are stored in the outer edges of the seat-backs. Both are marked **SIDE AIRBAG**.
- 3 Two side curtain airbags, one for each side of the vehicle. The airbags are stored in the ceiling, above the side windows. The front and rear pillars are marked **SIDE CURTAIN AIRBAG**.
- 4 An electronic control unit that continually monitors and records information about the sensors, the airbag activators, the seat belt tensioners, and driver and front passenger seat belt use when the ignition switch is in ON **II**.
- 5 Automatic front seat belt tensioners. The driver's and front passenger's seat belts incorporate sensors that detect whether or not they are fastened.
- 6 A driver's seat position sensor. If the seat is too far forward, the airbag will inflate with less force.
- 7 Weight sensors in the front passenger's seat. The front passenger's airbag will be turned off if the weight on the seat is 65 lbs (29 kg) or less (the weight of an infant or small child).
- 8 Impact sensors that can detect a moderate to severe front or side collision.
- 9 An indicator on the dashboard that alerts you that the front passenger's front airbag has been turned off.
- 10 Sensors that can detect if a child or small statured adult is in the deployment path of the front passenger's side airbag.
- 11 An indicator on the instrument panel that alerts you to a possible problem with your airbag system or seat belt tensioners.
- 12 An indicator on the instrument panel that alerts you that the front passenger's side airbag has been turned off.
- 13 Safing Sensor
- 14 A rollover sensor that detects whether the vehicle is about to roll over.

Important Facts About Your Airbags

Airbags can pose serious hazards. To do their job, airbags must inflate with tremendous force. So, while airbags help save lives, they can cause burns, bruises, and other minor injuries, and sometimes even fatal ones if occupants are not wearing their seat belts properly and sitting correctly.

What you should do: Always wear your seat belt properly, and sit upright and as far back from the steering wheel as possible while allowing full control of the vehicle. A front passenger should move their seat as far back from the dashboard as possible.

Remember, however, that no safety system can prevent all injuries or deaths that can occur in a severe crash, even when seat belts are properly worn and the airbags deploy.

Do not place hard or sharp objects between yourself and a front airbag.

Carrying hard or sharp objects on your lap, or driving with a pipe or other sharp object in your mouth, can result in injuries if your front airbag inflates.

Do not attach or place objects on the front airbag covers. Objects on the covers marked **SRS AIRBAG** could interfere with the proper operation of the airbags or be propelled inside the vehicle and hurt someone if the airbags inflate.

Important Facts About Your Airbags

Do not attempt to deactivate your airbags. Together, airbags and seat belts provide the best protection.

When driving, keep hands and arms out of the deployment path of the front airbag by holding each side of the steering wheel. Do not cross an arm over the airbag cover.

Types of Airbags

Your vehicle is equipped with three types of airbags:

- **Front airbags:** Airbags in front of the driver's and front passenger's seats.
- **Side airbags:** Airbags in the driver's and front passenger's seat-backs.
- **Side curtain airbags:** Airbags above the side windows.

Each is discussed in the following pages.

Front Airbags (SRS)

The front SRS airbags inflate in a moderate to severe frontal collision to help protect the head and chest of the driver and/or front passenger.

SRS (Supplemental Restraint System) indicates that the airbags are designed to supplement seat belts, not replace them. Seat belts are the occupant's primary restraint system.

Housing Locations

The front airbags are housed in the center of the steering wheel for the driver, and in the dashboard for the front passenger. Both airbags are marked **SRS AIRBAG**.

Types of Airbags

The airbags can inflate whenever the ignition switch is in ON **III**.

Front Airbags (SRS)

Dual-Stage, Multiple-Threshold Front Airbags (SRS)

Your vehicle is equipped with dual-stage, multiple-threshold front airbags (SRS).

During a frontal crash severe enough to cause one or both front airbags to deploy, the airbags can inflate at different rates, depending on the severity of the crash, whether or not the seat belts are latched, and/or other factors. Frontal airbags are designed to supplement the seat belts to help reduce the likelihood of head and chest injuries in frontal crashes.

Operation

Front airbags are designed to inflate during moderate-to-severe frontal collisions. When the vehicle decelerates suddenly, the sensors send information to the control unit which signals one or both front airbags to inflate.

A frontal collision can be either head-on or angled between two vehicles, or when a vehicle crashes into a stationary object, such as a concrete wall.

How the Front Airbags Work

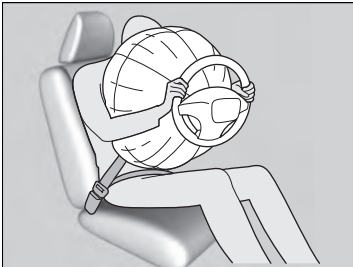

While your seat belt restrains your torso, the front airbag provides supplemental protection for your head and chest.

The front airbags deflate immediately so that they won't interfere with the driver's visibility or the ability to steer or operate other controls.

The total time for inflation and deflation is so fast that most occupants are not aware that the airbags deployed until they see them lying in front of them.

How the Front Airbags Work

After a front airbag inflates in a crash, you may see what looks like smoke. This is actually powder from the airbag's surface. Although the powder is not harmful, people with respiratory problems may experience some temporary discomfort. If this occurs, get out of the vehicle as soon as it is safe to do so.

Although the driver's and front passenger's airbags normally inflate within a split second of each other, it is possible for only one airbag to deploy. This can happen if the severity of a collision is at the margin, or threshold that determines whether or not the airbags will deploy. In such cases, the seat belt will provide sufficient protection, and the supplemental protection offered by the airbag would be minimal.

■ When front airbags should not deploy

Minor frontal crashes: Front airbags were designed to supplement seat belts and help save lives, not to prevent minor scrapes, or even broken bones that might occur during a less than moderate-to-severe frontal crash.

Side impacts: Front airbags can provide protection when a sudden deceleration causes a driver or front passenger to move toward the front of the vehicle. Side airbags and side curtain airbags have been specifically designed to help reduce the severity of injuries that can occur during a moderate-to-severe side impact which can cause the driver or passenger to move toward the side of the vehicle.

Rear impacts: Head restraints and seat belts are your best protection during a rear impact. Front airbags cannot provide any significant protection and are not designed to deploy in such collisions.

Rollovers: Seat belts and, in vehicles equipped with a rollover sensor, side airbags and side curtain airbags offer the best protection in a rollover. Because front airbags could provide little if any protection, they are not designed to deploy during a rollover.

■ When front airbags deploy with little or no visible damage

Because the airbag system senses sudden deceleration, a strong impact to the vehicle framework or suspension might cause one or more of the airbags to deploy. Examples include running into a curb, the edge of a hole, or other low fixed object that causes a sudden deceleration in the vehicle chassis. Since the impact is underneath the vehicle, damage may not be readily apparent.

■ When front airbags may not deploy, even though exterior damage appears severe

Since crushable body parts absorb crash energy during an impact, the amount of visible damage does not always indicate proper airbag operation. In fact, some collisions can result in severe damage but no airbag deployment because the airbags would not have been needed or would not have provided protection even if they had deployed.

Advanced Airbags

Your front airbags have advanced features to help reduce the likelihood of airbag related injuries to smaller occupants.

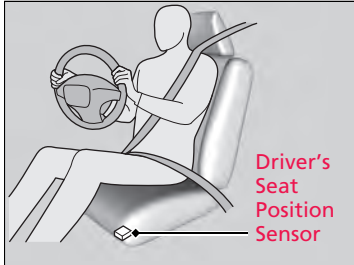

The driver's advanced front airbag system includes a seat position sensor.

If the seat is too far forward, the airbag inflates with less force, regardless of the severity of the impact.

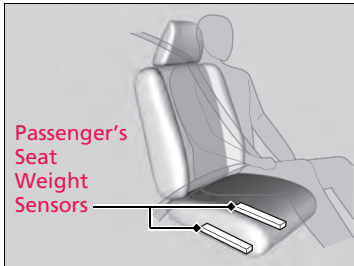

The passenger's advanced front airbag system has weight sensors.

Although we recommend against carrying an infant or small child in front, if the sensors detect the weight of a child (up to about 65 lbs or 29 kg), the system will automatically turn off the passenger's front airbag.

Advanced Airbags

If there is a problem with the driver's seat position sensor, the SRS indicator will come on and the airbag will inflate with full (normal) force, regardless of the driver's seating position.

For both advanced front airbags to work properly:

- Do not spill any liquid on or under the seats.
- Do not put any object under the passenger's seat.
- Make sure any objects are positioned properly on the floor. Improperly positioned objects can interfere with the advanced airbag sensors.
- All occupants should sit upright and wear their seat belts properly.
- Do not place any cover over the passenger side dashboard.

Side Airbags

The side airbags help protect the upper torso of the driver or a front passenger during a moderate to severe side impact.

Side Airbags

Do not attach accessories on or near the side airbags. They can interfere with the proper operation of the airbags, or hurt someone if an airbag inflates.

If the impact is on the passenger's side, the airbag may not deploy when there is no passenger in the front passenger seat.

Do not cover or replace the front seat-back covers without consulting a dealer. Improperly replacing or covering front seat-back covers can prevent your side airbags from properly deploying during a side impact.

Housing Locations



The side airbags are housed in the outside edge of the driver's and passenger's seat-backs.

Both are marked **SIDE AIRBAG**.

Operation

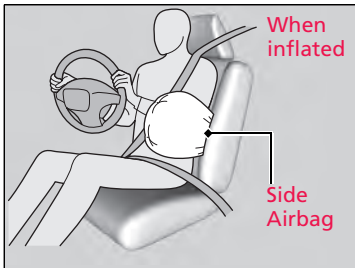

When the sensors detect a moderate-to-severe side impact, the control unit signals the side airbag on the impact side to immediately inflate.

■ When a side airbag deploys with little or no visible damage

Because the airbag system senses sudden acceleration, a strong impact to the side of the vehicle's framework can cause a side airbag to deploy. In such cases, there may be little or no damage, but the side impact sensors detected a severe enough impact to deploy the airbag.

■ When a side airbag may not deploy, even though visible damage appears severe

It is possible for a side airbag to not deploy during an impact that results in apparently severe damage. This can occur when the point of impact was toward the far front or rear of the vehicle, or when the vehicle's crushable body parts absorbed most of the crash energy. In either case, the side airbag would not have been needed nor provided protection even if it had deployed.

Side Airbag Cutoff System

To reduce the likelihood that a front passenger may be injured by an inflating side airbag, the passenger side airbag is automatically turned off when:

- The height sensors detect a child or short-statured adult is seated in the front passenger seat.
- The position sensor detects that the front passenger is leaning into the deployment path of the side airbag.

When the side airbag cutoff system is activated, the side airbag off indicator comes on.

➤ [Side Airbag Off Indicator P. 50](#)

Side Airbag Off Indicator

If the side airbag off indicator comes on, have the passenger sit upright. A few seconds after the passenger is sitting properly, the side airbag will automatically be turned on, and the indicator will go off.

If the front passenger is a child, stop when it is safe to do so, and have the child sit properly restrained in a rear seat.

Side Airbag Cutoff System

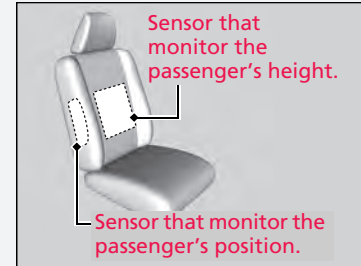

The sensors that monitor the front passenger's height and body position may not work if:

- The seat-back is wet
- The passenger is touching a metal or other electrical conductive object
- A seat cushion is on the seat
- The passenger is wearing excessively thick clothing

Side Curtain Airbags

Side curtain airbags help protect the heads of the driver and passengers in outer seating positions during a moderate-to-severe side impact. The side curtain airbags equipped in this vehicle are also designed to help reduce the likelihood of partial and complete ejection of vehicle occupants through side windows in crashes, particularly rollover crashes.

Housing Locations

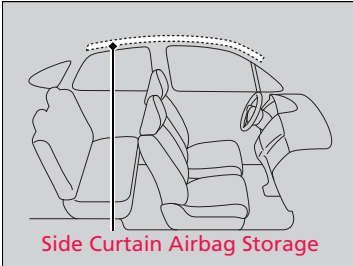

The side curtain airbags are located in the ceiling above the side windows on both sides of the vehicle.

Operation

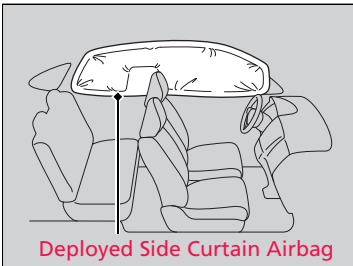

The side curtain airbag is designed to deploy in a rollover or a moderate-to-severe side impact.

Side Curtain Airbags

If the SRS control unit senses that your vehicle is about to rollover, it immediately deploys both side curtain airbags and activates both front seat belt tensioners.

The airbag on the passenger's side will deploy, and the seat belt tensioner will activate, even if there are no passengers on that side of the vehicle.

To get the best protection from the side curtain airbags, occupants should wear their seat belts properly and sit upright and well back in their seats.

Do not attach any objects to the side windows or roof pillars as they can interfere with the proper operation of the side curtain airbags.

■ **When side curtain airbags deploy in a frontal collision**

One or both side curtain airbags may inflate in a moderate to severe angled frontal collision.

In this case, the side curtain airbags will deploy slightly after the front airbags.

Airbag System Indicators

If a problem occurs in the airbag system, the SRS indicator will come on.

SRS (Supplemental Restraint System) Indicator



■ **When the ignition switch is turned to ON **

The indicator comes on for a few seconds, then goes off. This tells you the system is working properly.

If the indicator comes on at any other time, or does not come on at all, have the system checked by a dealer as soon as possible. If you don't, your airbags and seat belt tensioners may not work properly when they are needed.

 SRS (Supplemental Restraint System) Indicator

WARNING

Ignoring the SRS indicator can result in serious injury or death if the airbag systems or tensioners do not work properly.

Have your vehicle checked by a dealer as soon as possible if the SRS indicator alerts you to a possible problem.

Passenger Airbag Off Indicator

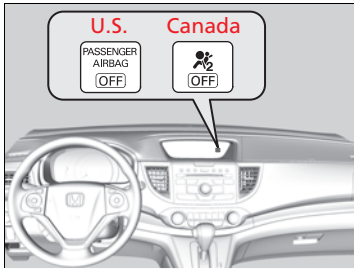

■ When the passenger airbag off indicator comes on

The indicator comes on to alert you that the passenger's front airbag has been turned off. This occurs when the front passenger's weight sensors detect 65 lbs (29 kg) or less, the weight of an infant or small child, on the seat.

Infants and small children should always ride properly restrained in a back seat.

➤ **Child Safety P. 52**

Objects placed on the seat can also cause the indicator to come on.

If the front passenger seat is empty, the passenger's front airbag will not deploy and the indicator will not come on.

⊠ Passenger Airbag Off Indicator

If the indicator comes on with no front passenger and no objects on the passenger's seat, or with an adult riding there, something may be interfering with the weight sensors. Such as:

- An object hanging on the seat or in the seat-back pocket.
- A child seat or other object pressing against the rear of the seat-back.
- A rear passenger pushing or pulling on the back of the front passenger's seat.
- The front seat or seat-back is forced back against an object on the seat or floor behind it.
- An object placed under the front passenger's seat.

If none of these conditions exist, have your vehicle checked by a dealer as soon as possible.

The passenger airbag off indicator may come on and goes off repeatedly if the total weight on the seat is near the airbag cutoff threshold.

Side Airbag Off Indicator

When the side airbag off indicator comes on



This indicator comes on if the passenger's side airbag has been turned off because the passenger is too small to be sitting in the front seat, is slouching or not sitting upright, or has leaned into the airbag's deployment path.

Unless the passenger is a smaller statured adult or a child, the indicator should go off when the passenger returns to a proper upright sitting position.

Side Airbag Off Indicator

When you turn the ignition switch to ON (II), the indicator should come on for a few seconds and then go out. If it doesn't come on, stays on, or comes on while driving without a passenger in the front seat, have the system checked by a dealer as soon as possible.

Airbag Care

You do not need to, and should not, perform any maintenance on or replace any airbag system components yourself. However, you should have your vehicle inspected by a dealer in the following situations:

■ When the airbags have deployed

If an airbag has inflated, the control unit and other related parts must be replaced. Similarly, once an automatic seat belt tensioner has been activated, it must be replaced.

■ When the vehicle has been in a moderate-to-severe collision

Even if the airbags did not inflate, have your dealer inspect the following: the driver's seat position sensor, weight sensors in the passenger's seat, front seat belt tensioners, and each seat belt that was worn during the crash.

■ Do not remove or modify a front seat without consulting a dealer

This would likely disable the driver's seat position sensor or the weight sensors in the passenger's seat. If it is necessary to remove or modify a front seat to accommodate a person with disabilities, contact a Honda dealer, or for U.S. vehicles, American Honda Automobile Customer Service at 800-999-1009 and for Canadian vehicles, Honda Canada Customer Relations at 888-9-HONDA-9.

✕ Airbag Care

We recommend against the use of salvaged airbag system components, including the airbag, tensioners, sensors, and control unit.

Protecting Child Passengers

Each year, many children are injured or killed in vehicle crashes because they are either unrestrained or not properly restrained. In fact, vehicle accidents are the number one cause of death of children ages 12 and under.

To reduce the number of child deaths and injuries, every state, Canadian province and territory requires that infants and children be properly restrained when they ride in a vehicle.

Children should sit properly restrained in a rear seat. This is because:

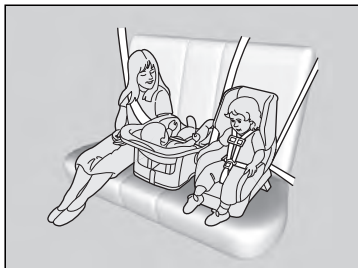

- An inflating front or side airbag can injure or kill a child sitting in the front seat.
- A child in the front seat is more likely to interfere with the driver's ability to safely control the vehicle.
- Statistics show that children of all sizes and ages are safer when they are properly restrained in a rear seat.

Protecting Child Passengers

WARNING

Children who are unrestrained or improperly restrained can be seriously injured or killed in a crash.

Any child too small for a seat belt should be properly restrained in a child seat. A larger child should be properly restrained with a seat belt, using a booster seat if necessary.

The National Highway Traffic Safety Administration and Transport Canada recommend that all children ages 12 and under be properly restrained in a rear seat. Some states or provinces/territories have laws restricting where children may ride.

- Any child who is too small to wear a seat belt correctly must be restrained in an approved child seat that is properly secured to the vehicle using either the lap belt portion of the lap/shoulder belt or the lower anchors of the LATCH system.
- Never hold a child on your lap because it is impossible to protect them in the event of a collision.
- Never put a seat belt over yourself and a child. During a crash, the belt would likely press deep into the child and cause serious or fatal injuries.
- Never let two children use the same seat belt. Both children could be very seriously injured in a crash.
- Do not allow children to operate the doors, windows or seat adjustments.
- Do not leave children in the vehicle unattended, especially in hot weather when the inside of the vehicle can get hot enough to kill them. They could also activate vehicle controls causing it to move unexpectedly.

Protecting Child Passengers

⚠ WARNING

Allowing a child to play with a seat belt or wrap one around their neck can result in serious injury or death.

Instruct children not to play with any seat belt and make sure any unused seat belt a child can reach is buckled, fully retracted, and locked.

To deactivate a lockable retractor, release the buckle and allow the seat belt to wind up all the way.

To remind you of the passenger's front airbag hazards and child safety, your vehicle warning came with a label on the dashboard (U.S. models) and has labels on the front visors. Please read and follow the instructions on these labels.

[▶ Safety Labels P. 66](#)

Safety of Infants and Small Children

■ Protecting Infants

An infant must be properly restrained in a rear-facing, reclining child seat until the infant reaches the seat maker's weight or height limit for the seat, and the infant is at least one year old.

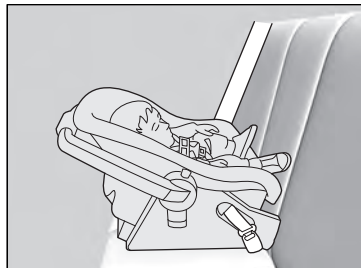

■ **Positioning a rear-facing child seat**
Child seats must be placed and secured in a rear seating position.

When properly installed, a rear-facing child seat may prevent the driver or a front passenger from moving their seat all the way back, or from locking their seat-back in the desired position.

It can also interfere with proper operation of the passenger's advanced front airbag system.

➤ [Airbags P. 37](#)

If this occurs, we recommend that you install the child seat directly behind the front passenger's seat, move the seat as far forward as needed, and leave it unoccupied. Or, you may wish to get a smaller rear-facing child seat.

⌘ Protecting Infants

⚠ WARNING

Placing a rear-facing child seat in the front seat can result in serious injury or death during a crash.

Always place a rear-facing child seat in the rear seat, not the front.

Rear-facing child seats should never be installed in a forward facing position.

Always refer to the child seat manufacturer's instructions before installation.

Protecting Smaller Children

If a child is at least one year old and within the weight range indicated by the child seat manufacturer, the child should be properly restrained in a firmly secured forward-facing child seat.



■ Forward-facing child seat placement

We strongly recommend placing a forward-facing child seat in a rear seating position.

Placing a forward-facing child seat in the front seat can be hazardous, even with advanced front airbags that automatically turn the passenger's front airbag off. A rear seat is the safest place for a child.

☒ Protecting Smaller Children

⚠ WARNING

Placing a forward-facing child seat in the front seat can result in serious injury or death if the front airbag inflates.

If you must place a forward-facing child seat in front, move the vehicle seat as far back as possible, and properly restrain the child.

Educate yourself about the laws and regulations regarding child seat use where you are driving, and follow the child seat manufacturer's instructions.

Many experts recommend use of a rear-facing seat for a child up to two years old if the child's height and weight are appropriate for a rear-facing seat.

■ Selecting a Child Seat

Most child seats are LATCH-compatible (Lower Anchors and Tethers for CHildren). Some have a rigid-type connector while others have a flexible-type connector. Both are equally easy to use. Some existing and previously owned child seats can only be installed using the seat belt. Whichever type you choose, follow the child seat manufacturer's use and care instructions as well as the instructions in this manual. Proper installation is key to maximizing your child's safety.

In seating positions and vehicles not equipped with LATCH, a LATCH-compatible child seat can be installed using the seat belt and a top tether for added security. This is because all child seats are required to be designed so that they can be secured with a lap belt or the lap part of a lap/shoulder belt. In addition, the child seat manufacturer may advise that a seat belt be used to attach a LATCH-compatible seat once a child reaches a specified weight. Please read the child seat owner's manual for proper installation instructions.

■ Important consideration when selecting a child seat

Make sure the child seat meets the following three requirements:

- The child seat is the correct type and size for the child.
- The child seat is the correct type for the seating position.
- The child seat is compliant with Federal Motor Vehicle Safety Standard 213 or Canadian Motor Vehicle Safety Standard 213.

▶▶ Selecting a Child Seat

Installation of a LATCH-compatible child seat is simple.

LATCH-compatible child seats have been developed to simplify the installation process and reduce the likelihood of injuries caused by incorrect installation.

Installing a LATCH-Compatible Child Seat

A LATCH-compatible child seat can be installed in rear seats. A child seat is attached to the lower anchors with either the rigid or flexible type of connectors.



1. Locate the lower anchors under the marks.

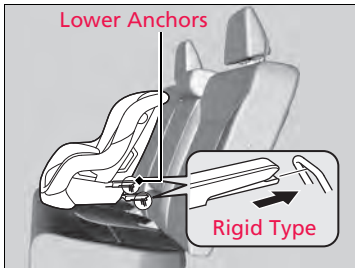

2. Place the child seat on the vehicle seat then attach the child seat to the lower anchors according to the instructions that came with the child seat.

▶ When installing the child seat, make sure that the lower anchors are not obstructed by the seat belt or any other object.

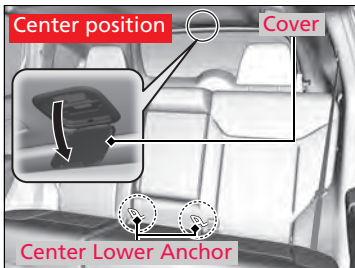
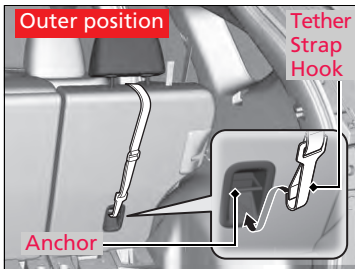
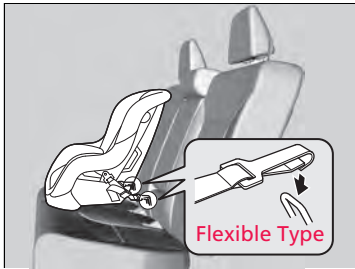

▶▶ Installing a LATCH-Compatible Child Seat

For your child's safety, when using a child seat installed using the LATCH system, make sure that the child seat is properly secured to the vehicle. A child seat that is not properly secured will not adequately protect a child in a crash and may cause injury to the child or other vehicle occupants.

Outer position

3. Put the head restraint to its upper-most position, then route the tether strap between the head restraint legs, and secure the tether strap hook onto the anchor.
4. Go to step 7.

Center position

3. Lower the head restraint to its lowest position.
4. Open the anchor cover.

QRG

TOC

Safe Driving

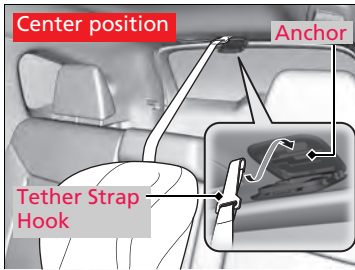

5. Route the tether strap over the head restraint. Make sure the strap is not twisted.
6. Secure the tether strap hook onto the anchor.

All models

7. Tighten the tether strap as instructed by the child seat manufacturer.
8. Make sure the child seat is firmly secured by rocking it forward and back and side to side; little movement should be felt.
9. Make sure any unused seat belt that a child can reach is buckled, the lockable retractor is activated, and the belt is fully retracted and locked.

Index

Home

■ Installing a Child Seat with a Lap/Shoulder Seat Belt

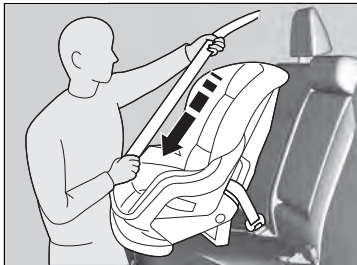
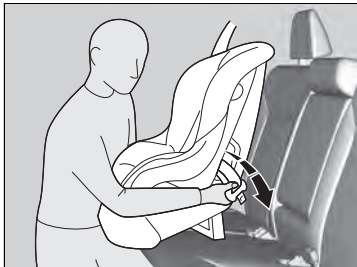

1. Place the child seat on the vehicle seat.
2. Route the seat belt through the child seat according to the seat maker's instructions, and insert the latch plate into the buckle.
 - ▶ Insert the latch plate fully until it clicks.
3. Slowly pull the shoulder part of the belt all the way out until it stops. This activates the lockable retractor.
4. Let the seat belt completely wind up into the retractor, then try to pull it out to make sure the retractor is locked.
 - ▶ If you are able to pull the shoulder belt out, the lockable retractor is not activated. Pull the seat belt all the way out, and repeat steps 3 – 4.
5. Grab the shoulder part of the seat belt near the buckle, and pull up to remove any slack from the lap part of the belt.
 - ▶ When doing this, place your weight on the child seat and push it into the vehicle seat.

▶▶ Installing a Child Seat with a Lap/Shoulder Seat Belt

A child seat that is not properly secured will not adequately protect a child in a crash and may cause injury to the child or other vehicle occupants.

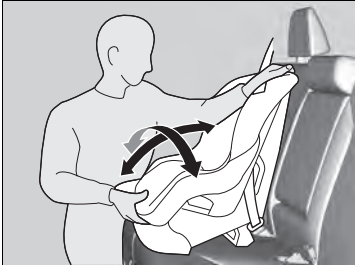

6. Make sure the child seat is firmly secured by rocking it forward and back and side to side; little movement should be felt.
7. Make sure any unused seat belt that a child can reach is buckled, the lockable retractor is activated, and the belt is fully retracted and locked.

■ Adding Security with a Tether

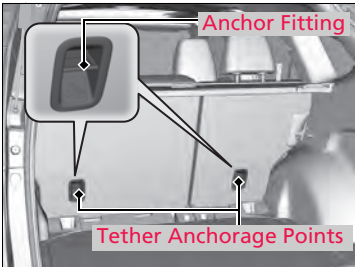

Two tether anchorage points are provided behind the rear outer seating positions and one in the ceiling for the rear center. A child seat that is installed with a seat belt and comes with a tether can use the tether for additional security.

☒ Installing a Child Seat with a Lap/Shoulder Seat Belt

To deactivate a lockable retractor, release the buckle and allow the seat belt to wind up all the way.

☒ Adding Security with a Tether

Since a tether can provide additional security to the lap/shoulder seat belt installation, we recommend using a tether whenever one is available.

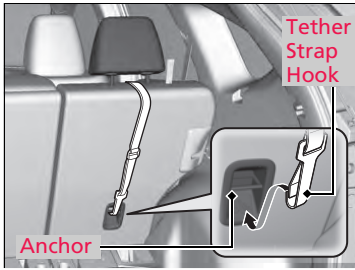

■ Using an outer anchor

1. Put the head restraint to its upper-most position, then route the tether strap through the head restraint legs. Make sure the strap is not twisted.
2. Secure the tether strap hook onto the anchor.
3. Tighten the tether strap as instructed by the child seat manufacturer.

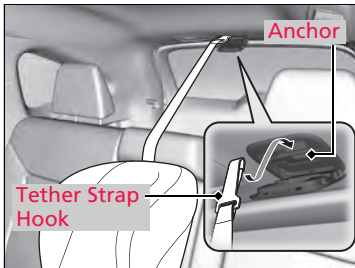

■ Using the center anchor

1. Lower the head restraint to its lowest position.
2. Open the anchor cover.
3. Route the tether strap over the head restraint. Make sure the strap is not twisted.
4. Secure the tether strap hook onto the anchor.
5. Tighten the tether strap as instructed by the child seat manufacturer.

Safety of Larger Children

Protecting Larger Children

The following pages give instructions on how to check proper seat belt fit, what kind of booster seat to use if one is needed, and important precautions for a child who must sit in front.

Checking Seat Belt Fit

When a child is too big for a child seat, secure the child in a rear seat using the lap/shoulder seat belt. Have the child sit upright and all the way back, then answer the following questions.



Checklist

- Do the child's knees bend comfortably over the edge of the seat?
- Does the shoulder belt cross between the child's neck and arm?
- Is the lap part of the seat belt as low as possible, touching the child's thighs?
- Will the child be able to stay seated like this for the whole trip?

If you answer yes to all these questions, the child is ready to wear the lap/shoulder seat belt correctly. If you answer no to any question, the child needs to ride on a booster seat until the seat belt fits properly without a booster seat.

▶ Safety of Larger Children

⚠ WARNING

Allowing a child age 12 or under to sit in front can result in injury or death if the passenger's front airbag inflates.

If a larger child must ride in front, move the vehicle seat as far to the rear as possible, have the child sit up properly and wear the seat belt properly, using a booster seat if needed.

Booster Seats

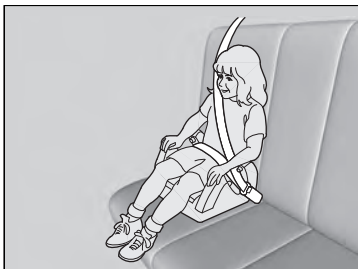

If a lap/shoulder seat belt cannot be used properly, position the child in a booster seat in a rear seating position. For the child's safety, check that the child meets the booster seat manufacturer's recommendations.

Protecting Larger Children-Final Checks

Your vehicle has a rear seat where children can be properly restrained. If you ever have to carry a group of children, and a child must ride in front:

- Make sure you read and fully understand the instructions and safety information in this manual.
- Move the front passenger seat as far back as possible.
- Have the child sit upright and well back in the seat.
- Check that the seat belt is properly positioned so that the child is secure in the seat.

Monitoring child passengers

We strongly recommend that you keep an eye on child passengers. Even older, more mature children sometimes need to be reminded to fasten their seat belts and sit up properly.

Booster Seats

When installing a booster seat, make sure to read the instructions that came with it, and install the seat accordingly.

There are high- and low-type booster seats. Choose a booster seat that allows the child to wear the seat belt correctly.

Some U.S. states, and Canadian provinces and territories require children to use a booster seat until they reach a given age or weight (e.g. six years or 60 lbs). Be sure to check current laws in the state or province, or territory where you intend to drive.

Carbon Monoxide Gas

The engine exhaust from this vehicle contains carbon monoxide, a colorless, odorless, and highly toxic gas. As long as you properly maintain your vehicle, carbon monoxide gas will not get into the interior.

■ Have the exhaust system inspected for leaks whenever

- The exhaust system is making an unusual noise.
- The exhaust system may have been damaged.
- The vehicle is raised for an oil change.

When you operate a vehicle with the tailgate open, airflow can pull exhaust gas into the interior and create a hazardous condition. If you must drive with the tailgate open, open all the windows and set the heating and cooling system*/climate control system* as shown below.

1. Select the fresh air mode.
2. Select the  mode.
3. Set the fan speed to high.
4. Set the temperature control to a comfortable setting.

Adjust the heating and cooling system*/climate control system* in the same manner if you sit in your parked vehicle with the engine running.

Carbon Monoxide Gas

⚠ WARNING

Carbon monoxide gas is toxic. Breathing it can cause unconsciousness and even kill you.

Avoid any enclosed areas or activities that expose you to carbon monoxide.

An enclosed area such as a garage can quickly fill up with carbon monoxide gas. Do not run the engine with the garage door closed. Even when the garage door is open, drive out of the garage immediately after starting the engine.

* Not available on all models

Label Locations

These labels are in the locations shown. They warn you of potential hazards that can cause serious injury or death. Read these labels carefully.

If a label comes off or becomes hard to read (except for the U.S. dashboard label which may be removed by the owner), contact a dealer for a replacement.

TOC
Safe Driving

Sun Visor
U.S. models

WARNING
EVEN WITH ADVANCED AIR BAGS

- Do not lean or sit back or recline against the air bag.
- The back seat is the safest place for children.
- Never put a rear-facing child seat in the front.
- Always use seat belts and child restraints.
- See owner's manual for more information about air bags.

Canadian models

CAUTION
TO AVOID SERIOUS INJURY:
• FOR MAXIMUM SAFETY PROTECTION IN ALL TYPES OF CRASHES YOU MUST ALWAYS WEAR YOUR SAFETY BELT.
• DO NOT INSTALL REARWARD-FACING CHILD SEATS IN ANY FRONT PASSENGER SEAT POSITION.
• DO NOT SIT OR LEAN UNNECESSARILY CLOSE TO THE AIR BAG.
• DO NOT PLACE ANY OBJECTS OVER THE AIR BAG OR BETWEEN THE AIR BAG AND YOURSELF.
• SEE THE OWNER'S MANUAL FOR FURTHER INFORMATION AND EXPLANATIONS.

PRECAUTIONS:
POUR EVITER DES BLESSURES GRAVES:
• POUR PROFITER D'UNE PROTECTION MAXIMALE LORS D'UNE COLLISION BOUCLEZ TOUJOURS VOTRE CEINTURE DE SECURITE.
• N'INSTALLEZ JAMAIS UN SIEGE POUR ENFANTS FAISANT FACE A L'ARRIERE SUR LE SIEGE DU PASSENGER AVANT.
• NE VOUS APPUYEZ PAS ET NE VOUS ASSOYEZ PAS PRES DU COUSSIN GONFLABLE.
• NE DEPOSEZ AUCUN OBJET SUR LE COUSSIN GONFLABLE OU ENTRE LE COUSSIN GONFLABLE ET VOUS.
• LISEZ LE GUIDE UTILISATEUR POUR DE PLUS AMPLES RENSEIGNEMENTS.

Sun Visor
U.S. models only

WARNING: HIGHER ROLLOVER RISK

Avoid Abrupt Maneuvers and Excessive Speed. Always Buckle Up. See Owner's Manual For Further Information.

Dashboard
U.S. models only

This Vehicle is Equipped with Advanced Air Bags

Even with Advanced Air Bags
Obtenir un maximum de protection en cas de collision, il est important de toujours porter votre ceinture de sécurité. Ne placez jamais d'objets sur le siège passager avant. Ne vous appuyez pas et ne vous assoyez pas près du coussin gonflable. Consultez le manuel de l'utilisateur pour plus de renseignements.

Radiator Cap

DANGER WARNING
危険 危険
NEVER OPEN WHEN HOT
Hot coolant will scald you.
NE VOUS RENDREZ PAS QUAND CHAUD.
N'OUVREZ PAS QUAND CHAUD.
N'ouvrez pas quand chaud.
危険 危険
1.1

Doorjamb

U.S. models

SIDE AIRBAG

- This car is equipped with side airbags in the front seats and side curtain airbags.
- Do not lean against the door.
- See owner's manual for more information.

Canadian models

SIDE AIRBAG

- This car is equipped with side airbags in the front seats and side curtain airbags.
- Do not lean against the door.
- See owner's manual for more information.

COUSSIN GONFLABLE LATÉRAL

- Cette automobile est équipée de coussins gonflables latéraux dans les sièges avant ainsi que de coussins gonflables latéraux de type rideau.
- Ne vous appuyez pas sur la porte.
- Consultez le Manuel du propriétaire pour en savoir plus.

ORG

Index



Home

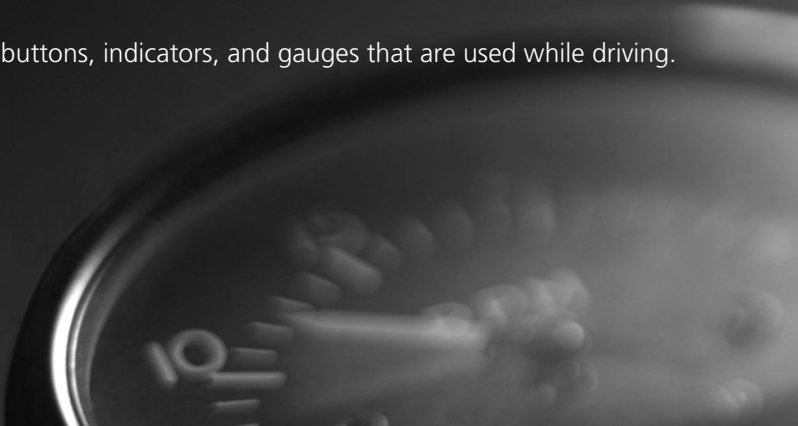

Instrument Panel

This chapter describes the buttons, indicators, and gauges that are used while driving.

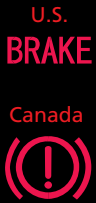







- Indicators** 68
- Gauges and Displays**
 - Gauges..... 77
 - Information Display..... 78
 - Multi-Information Display 81

Indicator	Name	On/Blinking	Explanation
 <p>U.S. BRAKE Canada</p>	<p>Parking Brake and Brake System Indicator</p>	<ul style="list-style-type: none"> • Comes on for a few seconds when you turn the ignition switch to ON II, then goes off. • Comes on when the parking brake is applied, and goes off when it is released. • Comes on when the brake fluid level is low. • Comes on if there is a problem with the brake system. • The beeper sounds and the indicator comes on if you drive with the parking brake not fully released. 	<ul style="list-style-type: none"> • Comes on while driving - Make sure the parking brake is released. Check the brake fluid level. ➤ What to do when the indicator comes on while driving P. 333 • Comes on along with the ABS indicator - Have the vehicle checked by a dealer. ➤ If the Brake System Indicator Comes On (Red) P. 333
	<p>Low Oil Pressure Indicator</p>	<ul style="list-style-type: none"> • Comes on when you turn the ignition switch to ON II, and goes off when the engine starts. • Comes on when the engine oil pressure is low. 	<ul style="list-style-type: none"> • Comes on while driving - Immediately stop in a safe place. ➤ If the Low Oil Pressure Indicator Comes On P. 331

Indicator	Name	On/Blinking	Explanation
	Malfunction Indicator Lamp	<ul style="list-style-type: none"> • Comes on when you turn the ignition switch to ON [II], and goes off when the engine starts, or after several seconds if the engine did not start. If “readiness codes” have not been set, it blinks five times before it goes off. • Comes on if there is a problem with the emissions control systems. • Blinks when a misfire in the engine's cylinders is detected. 	<ul style="list-style-type: none"> • Readiness codes are part of the on board diagnostics for the emissions control systems. <ul style="list-style-type: none"> ► Testing of Readiness Codes P. 347 • Comes on while driving - Have the vehicle checked by a dealer. • Blinks while driving - Stop in a safe place where there are no flammable objects. Stop the engine for 10 minutes or more, and wait for it to cool down. Then, take the vehicle to a dealer. <ul style="list-style-type: none"> ► If the Malfunction Indicator Lamp Comes On or Blinks P. 332
	Charging System Indicator	<ul style="list-style-type: none"> • Comes on when you turn the ignition switch to ON [II], and goes off when the engine starts. • Comes on when the battery is not charging. 	<ul style="list-style-type: none"> • Comes on while driving - Turn off the heating and cooling system*/climate control system* and rear defogger to reduce electricity consumption. <ul style="list-style-type: none"> ► If the Charging System Indicator Comes On P. 331
P R N D3 D 2 1	Shift Lever Position Indicator	<ul style="list-style-type: none"> • Indicates current shift lever position. [D3] indicator: • Comes on for a few seconds when you turn the ignition switch to ON [II], then goes off. • Comes on when you press the [D3] button while the shift lever is in [D]. 	<ul style="list-style-type: none"> ► Shifting P. 243

* Not available on all models

Indicator	Name	On/Blinking	Explanation
	Transmission Indicator	<ul style="list-style-type: none"> Comes on for a few seconds when you turn the ignition switch to ON [II], then goes off. Blinks if the transmission system has a problem. 	<ul style="list-style-type: none"> Blinks while driving - Avoid sudden starts and acceleration and have the vehicle checked by a dealer immediately.
	Seat Belt Reminder Indicator	<ul style="list-style-type: none"> Comes on and the beeper sounds if you are not wearing a seat belt when you turn the ignition switch to ON [II]. If the front passenger is not wearing a seat belt, the indicator comes on a few seconds later. Blinks while driving if either you or the front passenger has not fastened a seat belt. The beeper sounds and the indicator blinks at regular intervals. 	<ul style="list-style-type: none"> The beeper stops and the indicator goes off when you and the front passenger fasten their seat belts. Stays on after you or the front passenger has fastened the seat belt - A detection error may have occurred in the sensor. Have the vehicle checked by a dealer. ▶ Seat Belt Reminder P. 30
	Low Fuel Indicator	<ul style="list-style-type: none"> Comes on when the fuel reserve is running low (approximately 2.3 U.S. gal./8.6 Liter left). Blinks if there is a problem with the fuel gauge. 	<ul style="list-style-type: none"> Comes on - Refuel your vehicle as soon as possible. Blinks - Have the vehicle checked by a dealer.





Indicator	Name	On/Blinking	Explanation
	ABS (Anti-lock Brake System) Indicator	<ul style="list-style-type: none"> Comes on for a few seconds when you turn the ignition switch to ON [II], then goes off. If it comes on at any other time, there is a problem with the ABS. 	<ul style="list-style-type: none"> Stays on constantly - Have the vehicle checked by a dealer. With this indicator on, your vehicle still has normal braking ability but no anti-lock function. <ul style="list-style-type: none"> ➤ ABS (Anti-lock Brake System) P. 256
	Supplemental Restraint System Indicator	<ul style="list-style-type: none"> Comes on for a few seconds when you turn the ignition switch to ON [II], then goes off. Comes on if a problem with any of the following is detected: <ul style="list-style-type: none"> - Supplemental restraint system - Side airbag system - Side curtain airbag system - Seat belt tensioner 	<ul style="list-style-type: none"> Stays on constantly or does not come on at all - Have the vehicle checked by a dealer.
	AWD System Indicator*	<ul style="list-style-type: none"> Comes on for a few seconds when you turn the ignition switch to ON [II], then goes off. Comes on if there is a problem with the AWD. Blinks when the AWD system is overheated. The system is inactive. 	<ul style="list-style-type: none"> Stays on constantly - the engine drives the front wheels only in this state. Have the vehicle checked by a dealer. Blinks while driving - the engine drives the front wheels only in this state. Stop in a safe place, shift to [P], and idle the engine until the indicator goes off. If the indicator does not stop blinking, take your vehicle to a dealer. <ul style="list-style-type: none"> ➤ Real Time AWD with Intelligent Control System™* P. 251

* Not available on all models

ORG



TOC





Instrument Panel

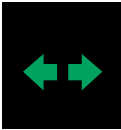

Indicator	Name	On/Blinking	Explanation
	VSA® (Vehicle Stability Assist) System Indicator	<ul style="list-style-type: none"> • Comes on for a few seconds when you turn the ignition switch to ON [II], then goes off. • Blinks when VSA® is active. • Comes on if there is a problem with the VSA® system. • Comes on if there is a problem with the hill start assist system. 	<ul style="list-style-type: none"> • Stays on constantly - Have the vehicle checked by a dealer. <ul style="list-style-type: none"> ➤ VSA® (Vehicle Stability Assist), aka ESC (Electronic Stability Control), System P. 249
	VSA® (Vehicle Stability Assist) OFF Indicator	<ul style="list-style-type: none"> • Comes on for a few seconds when you turn the ignition switch to ON [II], then goes off. • Comes on when you deactivate VSA®. 	<ul style="list-style-type: none"> ➤ VSA® On and Off P. 250
	Door Open Indicator	<ul style="list-style-type: none"> • Comes on for a few seconds if you turn the ignition switch to ON [II], then goes off. • Comes on if any door is not completely closed. • The beeper sounds and the indicator comes on if any door is opened while driving. 	<ul style="list-style-type: none"> • Goes off when all doors are closed.
	Tailgate Open Indicator	<ul style="list-style-type: none"> • Comes on for a few seconds if you turn the ignition switch to ON [II], then goes off. • Comes on if the tailgate is not completely closed. 	<ul style="list-style-type: none"> • Goes off when the tailgate is closed.

Index





Home

Indicator	Name	On/Blinking	Explanation
	EPS (Electric Power Steering) System Indicator	<ul style="list-style-type: none"> Comes on when you turn the ignition switch to ON [II], and goes off when the engine starts. Comes on if there is a problem with the EPS system. 	<ul style="list-style-type: none"> Stays on constantly or does not come on at all - Have the vehicle checked by a dealer. <ul style="list-style-type: none"> ► If the EPS System Indicator Comes On P. 333
	TPMS Indicator	<ul style="list-style-type: none"> Comes on for a few seconds when you turn the ignition switch to ON [II], then goes off. Comes on if there is a problem with the TPMS, or when a compact spare tire is temporarily installed. 	<ul style="list-style-type: none"> Stays on constantly or does not come on at all - Have the vehicle checked by a dealer. If the vehicle is fitted with a compact spare, get your regular tire repaired or replaced and put back on your vehicle as soon as you can.
	Low Tire Pressure Indicator	<ul style="list-style-type: none"> Comes on for a few seconds when you turn the ignition switch to ON [II], then goes off. Comes on if the tire pressure of any of the tires becomes significantly low. Comes on for a while and then goes off when a compact spare tire is temporarily installed. 	<ul style="list-style-type: none"> Comes on while driving - Stop in a safe place, check tire pressures, and inflate the tire(s) if necessary.

Indicator	Name	On/Blinking	Explanation
	Turn Signal Indicators	<ul style="list-style-type: none"> Blinks when you operate the turn signal lever. Blinks along with all turn signals if you press the hazard warning button. 	<ul style="list-style-type: none"> Does not blink or blinks rapidly - A turn signal light bulb has blown. Change the bulb immediately. ▶ Replacing Light Bulbs P. 290
	High Beam Indicator	<ul style="list-style-type: none"> Comes on when the high beam headlights are on. 	—
	Lights On Indicator	<ul style="list-style-type: none"> Comes on whenever the light switch is on, or in AUTO* when the exterior lights are on. 	<ul style="list-style-type: none"> If you remove the key from the ignition switch while the lights are on, a chime sounds when the driver's door is opened.
	Fog Light Indicator*	<ul style="list-style-type: none"> Comes on when the fog lights are on. 	—
	Side Airbag Off Indicator	<ul style="list-style-type: none"> Comes on for a few seconds when you turn the ignition switch to ON (II), then goes off. Comes on when the passenger side airbag system is automatically shut off. 	<ul style="list-style-type: none"> It does not mean there is a problem with your side airbags. Comes on when nobody is sitting in the passenger seat - Have the vehicle checked by a dealer. Comes on when someone is sitting in the seat - Have the passenger sit properly.

Indicator	Name	On/Blinking	Explanation
	Immobilizer System Indicator	<ul style="list-style-type: none"> • Comes on briefly when you turn the ignition switch to ON [II], then goes off. • Comes on if the immobilizer system cannot recognize the key information. 	<ul style="list-style-type: none"> • Blinks - You cannot start the engine. Turn the ignition switch to LOCK [O], pull the key out, and then insert the key and turn it to ON [II] again. • Repeatedly blinks - The system may be malfunctioning. Have the vehicle checked by a dealer. • Do not attempt to alter this system or add other devices to it. Electrical problems can occur.
	Security System Alarm Indicator*	<ul style="list-style-type: none"> • Blinks when the security system alarm has been set. 	<p>▶ Security System Alarm* P. 106</p>
	ECON Mode Indicator	<ul style="list-style-type: none"> • Comes on when you turn the ignition switch to ON [II], then goes off. • Comes on when the ECON mode is on. 	<p>▶ ECON Button P. 245</p>

* Not available on all models

Indicator	Name	On/Blinking	Explanation
	CRUISE MAIN Indicator	<ul style="list-style-type: none"> Comes on when you press the CRUISE button. 	<p>➤ Cruise Control P. 246</p>
	CRUISE CONTROL Indicator	<ul style="list-style-type: none"> Comes on when you have set a speed for cruise control. 	<p>➤ Cruise Control P. 246</p>
	Washer Level Indicator*	<ul style="list-style-type: none"> Comes on when the washer fluid is low. 	<ul style="list-style-type: none"> Refill washer fluid. ➤ Refilling Window Washer Fluid P. 286
	Maintenance Minder Indicator	<ul style="list-style-type: none"> Comes on when you turn the ignition switch to ON [II], then goes off. Comes on when the scheduled maintenance is due soon. 	<p>➤ Maintenance Minder™ P. 269</p>

Gauges

Gauges include the speedometer, tachometer, fuel gauge, and related indicators. They are displayed when the ignition switch is in ON **[II]**.

Speedometer

Displays your driving speed in mph (U.S.) or km/h (Canada).

Tachometer

Shows the number of engine revolutions per minute.

Fuel Gauge

Displays the amount of fuel left in the fuel tank.

Temperature Gauge

Displays the temperature of the engine coolant.

» Fuel Gauge

NOTICE

You should refuel when the reading approaches **[E]**. Running out of fuel can cause the engine to misfire, damaging the catalytic converter.

The actual amount of remaining fuel may differ from the fuel gauge reading.

» Temperature Gauge

NOTICE

Driving with the temperature gauge pointer in the upper zone can cause serious engine damage. Pull safely to the side of the road and allow engine temperature to return to normal.

[» Overheating P. 329](#)

Information Display

The information display shows the odometer, trip meter, engine oil life and maintenance service item codes, and other gauges.

Switching the Display

Press the  (Select/Reset) knob to change the display.

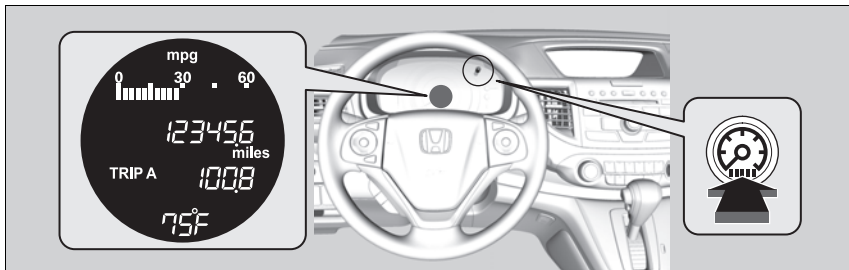

Odometer

Shows the total number of miles or kilometers that your vehicle has accumulated.

Switching the Display

Each time you press the  knob, the information display changes as follows:

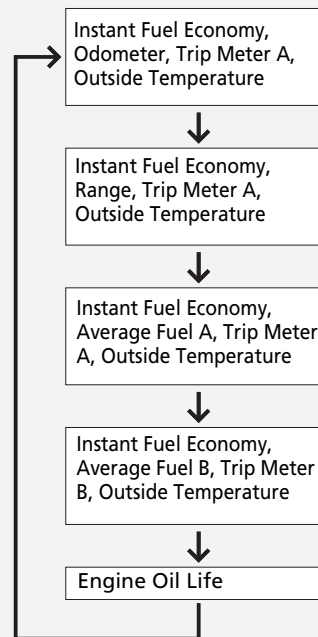

Some of the items on the information display also appear on the multi-information display. They also change along with the information display changes while the fuel consumption is shown.

■ Trip Meter

Shows the total number of miles or kilometers driven since the last reset. Meters A and B can be used to measure two separate trips.

■ Resetting a trip meter

To reset a trip meter, display it, then press and hold the  knob. The trip meter is reset to **0.0**.

■ Average Fuel Economy

Shows the estimated average fuel economy of each trip meter in mpg (U.S.) or l/100 km (Canada). The display is updated at set intervals. When a trip meter is reset, the average fuel economy is also reset.

■ Engine Oil Life

Shows the remaining oil life and Maintenance Minder™.

 [Maintenance Minder™ P. 269](#)

■ Range

Shows the estimated distance you can travel on the remaining fuel. This distance is estimated from the fuel economy of your trips in the past.

■ Check Fuel Cap

Appears when the fuel fill cap is loose or is not installed.

 [Check/Tighten Fuel Cap Message P. 332](#)

☒ Trip Meter

Switch between trip meter A and trip meter B by pressing the  knob.

■ Outside Temperature

Shows the outside temperature in Fahrenheit (U.S.) or Celsius (Canada).

■ Adjusting the outside temperature display

Adjust the temperature reading up to $\pm 5^{\circ}\text{F}$ or $\pm 3^{\circ}\text{C}$ if the temperature reading seems incorrect.

» Outside Temperature

The temperature sensor is in the front bumper. Road heat and exhaust from another vehicle can affect the temperature reading when your vehicle speed is less than 19 mph (30 km/h).

It may take several minutes for the display to be updated after the temperature reading has stabilized.

Use the multi-information display's customized features to correct the temperature.

[▶ Customized Features P. 84](#)

Multi-Information Display

Shows useful information, such as audio status. It also displays the compass direction and clock.

Switching the Display

Press the  (display) button to change the display.

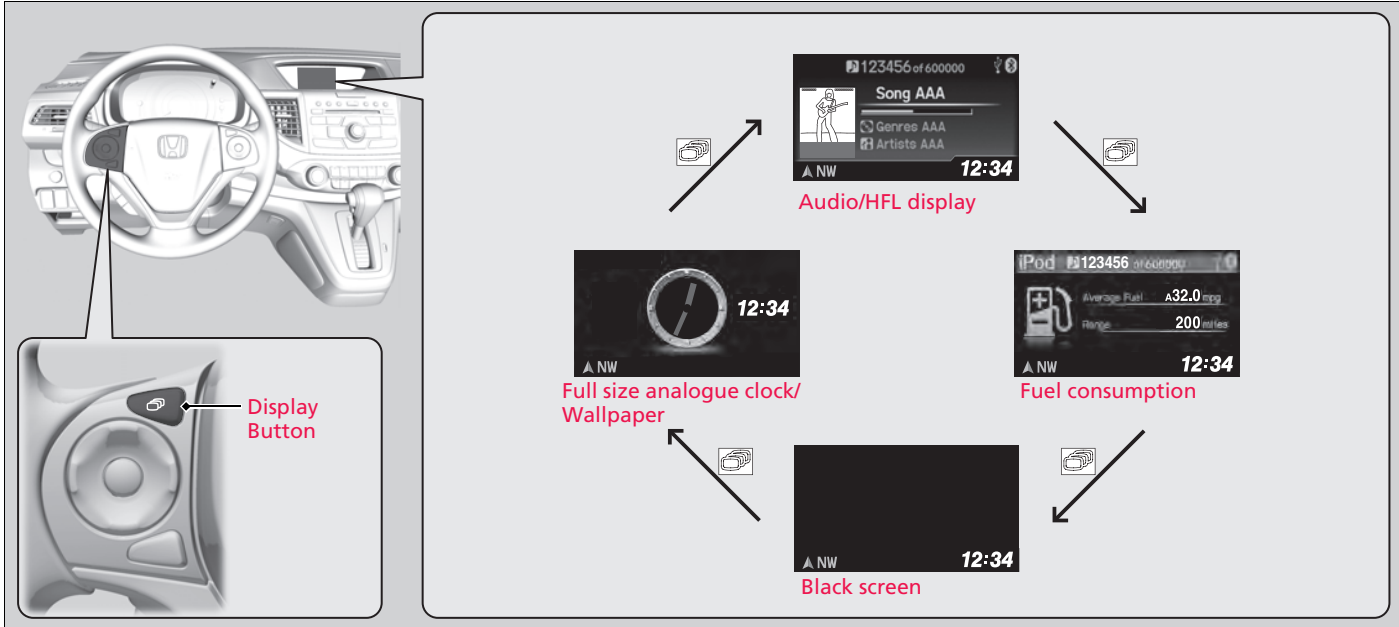

■ Average Fuel Economy

Shows the estimated average fuel economy of each trip meter in mpg (U.S.) or l/100 km (Canada). The display is updated at set intervals. When a trip meter is reset, the average fuel economy is also reset.

■ Range

Shows the estimated distance you can travel on the remaining fuel. This distance is estimated from the fuel economy of your trips in the past.

■ Elapsed Time

Shows the time elapsed since the last time Trip A or Trip B was reset.

■ Average Speed

Shows the average speed in mph or km/h since the last time Trip A or Trip B was reset.

▶▶ Average Fuel Economy

You can choose an item to be displayed in the fuel consumption screen. Range, elapsed time, or average speed can be selected.

▶ [Customized Features P. 84](#)

You can change the average fuel economy reset criteria

▶ [Customized Features P. 84](#)

▶▶ Elapsed Time

You can change the elapsed time reset criteria.

▶ [Customized Features P. 84](#)

▶▶ Average Speed

You can change the average speed reset criteria.

▶ [Customized Features P. 84](#)

ORG

■ Engine Oil Life and Maintenance Items

Shows the remaining oil life and Maintenance Minder™.

➤ [Maintenance Minder™ P. 269](#)

TOC

Instrument Panel

■ Compass Direction

Shows the vehicle's traveling direction.

➤ [Compass P. 223](#)

■ Turn-by-Turn Directions*

Shows you turn-by-turn driving directions to your destination linked with the navigation system.

➤ [See the Navigation System Manual](#)

☒ Turn-by-Turn Directions*

You can select whether the turn-by-turn display comes on or not during the route guidance.

➤ [Customized Features P. 84](#)

Index

Home

* Not available on all models

Continued

■ Customized Features



Use the multi-information display to customize certain features.

■ How to customize

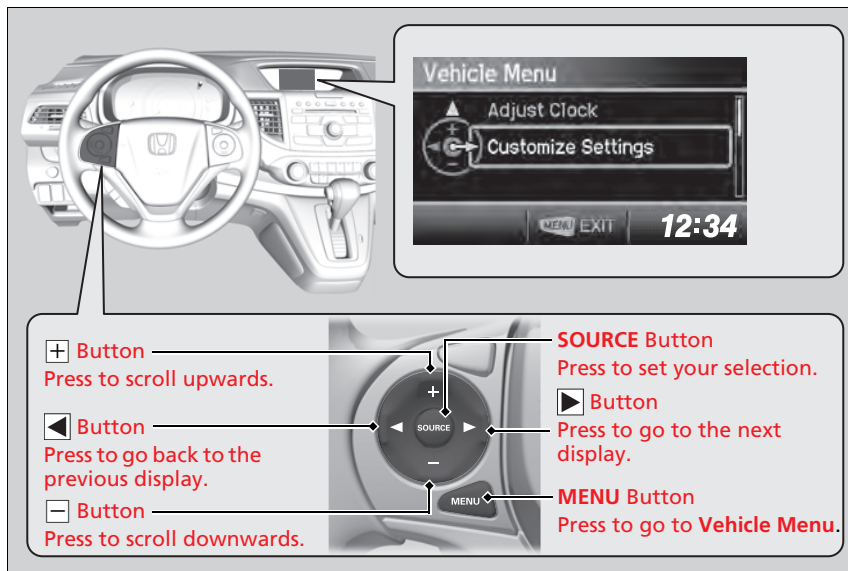
Select the **Vehicle Menu** screen by pressing the **MENU** button while the ignition switch is in ON , and the vehicle is at a complete stop. Select **Customize Settings**, then press the **SOURCE** button.



▶ Customized Features

To customize other features, press the  /  button.

- ▶ [List of customizable options P. 87](#)
- ▶ [Example of customizing wallpapers P. 90](#)

When you customize settings, shift to .

■ Customization flow

Press the **MENU** button.

⊞ Customized Features

You can exit the customizing screen at any time by pressing the **MENU** button.

Vehicle Menu

Vehicle Information

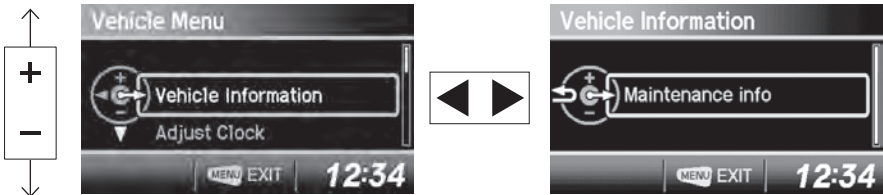

Adjust Clock*

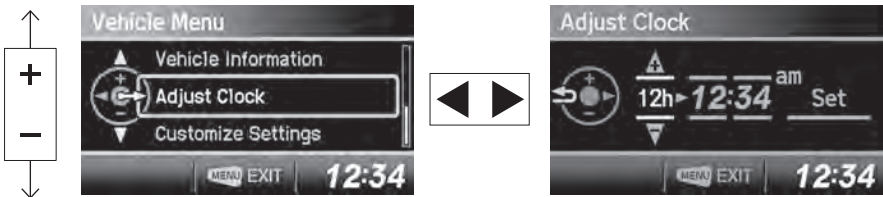

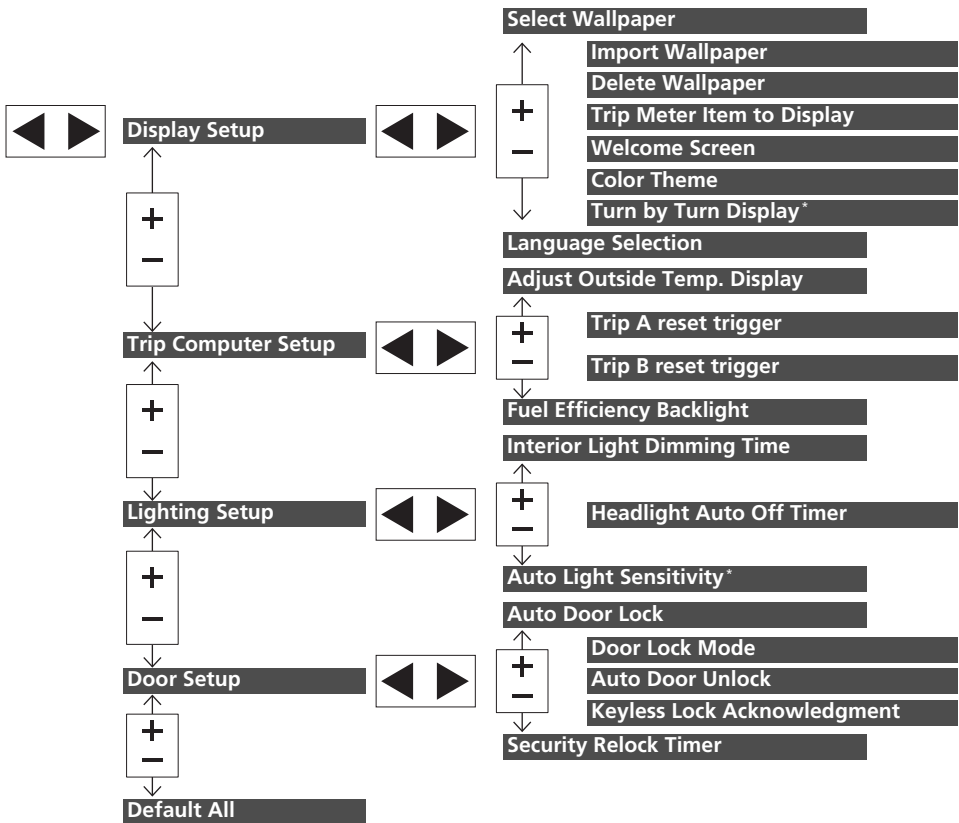

* Not available on all models

Customize Settings



■ List of customizable options

Setup Group	Customizable Features	Description	Selectable settings	
Vehicle Information	Maintenance info	Reset the Maintenance Minder™.	No/Yes	
Adjust Clock*		Selects the 12 hour or 24 hour clock display, and adjusts the time.	12 h^{*1}/24 h	
Customize Settings	Display Setup	Select Wallpaper	Selects the full-size analogue clock or the wallpaper.	Clock^{*1}/Image 1/Image 2/Image 3
		Import Wallpaper	Imports an image file for a new wallpaper.	Three images can be stored.  Importing wallpapers from USB P. 90
		Delete Wallpaper	Deletes an image file for a wallpaper.	Image 1/Image 2/Image 3
		Trip Meter Item to Display	Selects an item to be displayed along with average fuel economy.	Range^{*1}/Elapsed time/Average speed
		Welcome Screen	Selects whether the welcome screen comes on or not when you turn the ignition switch to ON  .	On^{*1}/Off
		Color Theme	Changes the color of the screen.	Blue^{*1}/Red/Amber/Gray
		Turn by Turn Display^{*, *2}	Select whether the turn-by-turn display comes on or not during the route guidance.	On^{*1}/Off
		Language Selection	Changes the displayed language.	English^{*1}/Francais/Español

*1: Default Setting

*2: See the Navigation System Manual

* Not available on all models

Setup Group	Customizable Features	Description	Selectable settings	
Customize Settings	Adjust Outside Temp. Display	Adjusts the temperature reading by a few degrees.	-5°F ~ ±0°F*1 ~ +5°F (U.S.) -3°C ~ ±0°C*1 ~ +3°C (Canada)	
	Trip Computer Setup	Trip A reset trigger	Changes the setting of how to reset trip meter A, average fuel economy A, average speed A, and elapsed time A.	With refuel/Manual only*1/IGN Off
		Trip B reset trigger	Changes the setting of how to reset trip meter B, average fuel economy B, average speed B, and elapsed time B.	With refuel/Manual only*1/IGN Off
		Fuel Efficiency Backlight	Turns the ambient meter feature on and off.	On*1/Off
	Lighting Setup	Interior Light Dimming Time	Changes the length of time the interior lights stay on after you close the doors.	60sec/30sec*1/15sec
		Headlight Auto Off Timer	Changes the length of time the exterior lights stay on after you close the driver's door.	60sec/30sec/15sec*1/0sec
		Auto Light Sensitivity*	Changes the timing for the headlights to come on.	Max/High/Mid*1/Low/Min

*1: Default Setting

Setup Group	Customizable Features	Description	Selectable settings
Customize Settings	Auto Door Lock	Changes the setting for the automatic locking feature.	Off/With Vehicle Speed^{*1}/Shift from P
	Door Lock Mode	Sets up either the driver's door or all doors to unlock on the first operation of the remote or ignition key.	Driver Door^{*1}/All Doors
	Auto Door Unlock	Changes the setting for when the doors unlock automatically.	Off/Driver Door with Shift to P^{*1}/All Doors with Shift to P/Driver Door with IGN Off/All Doors with IGN Off
	Keyless Lock Acknowledgment	Turns on or off the keyless lock acknowledgment of: LOCK/UNLOCK- The exterior lights flash. LOCK (2nd push)- The beeper sounds.	On^{*1}/Off
	Security Relock Timer	Changes the time it takes for the doors to relock and the security system to set after you unlock the vehicle without opening any door.	90sec/60sec/30sec^{*1}
	Default All	Cancels/Resets all the customized settings as default.	Cancel Reset All Defaults

*1:Default Setting

■ Example of customizing wallpapers

You can customize the display from clock to wallpaper.



Importing wallpapers from USB

You can import up to three images, one at a time for wallpaper from a USB flash drive.

Select **Import Wallpaper** from **Customize Settings** and properly connect a USB flash drive to store an image.

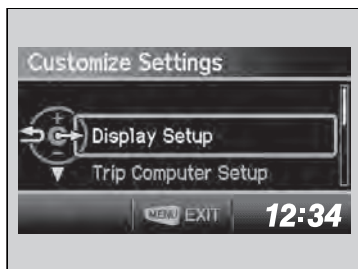

1. Connect the USB flash drive to the adapter cable.

➡ [USB Adapter Cable P. 151](#)

2. Press the **MENU** button.

3. Select **Customize Settings** with the $\boxed{+}$ / $\boxed{-}$ button, then press the **SOURCE** button.

4. Select **Display Setup** with the $\boxed{+}$ / $\boxed{-}$ button, then press the **SOURCE** button.

Customized Features

- When importing wallpaper files, the image must be in the USB flash drive's root directory. Images in a folder cannot be imported.
- The file format of the image that can be imported is BMP (bmp) or JPEG (jpg).
- The individual file size limit is 2 MB.
- The maximum image size is 1,680 x 936 pixels. If the image size was less than 420 x 234 pixels, the image is displayed in the middle of the screen with the extra area appearing in black.
- The number of files that can be selected is up to 255.
- Up to 64 characters can be displayed in the file name.

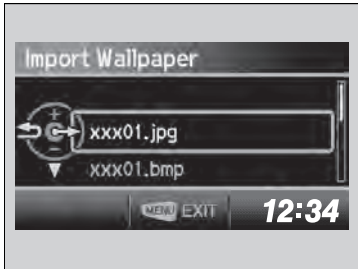

5. Select **Import Wallpaper** with the $\boxed{+}$ / $\boxed{-}$ button, then press the **SOURCE** button.
 - ▶ The file names are displayed on the screen.

6. Press the $\boxed{-}$ button until the file name you want to store appears on the center of the display, then press the **SOURCE** button.

7. The preview of the imported data is displayed. Press the **SOURCE** button if it is OK.

8. Press the **SOURCE** button to save the image file.



9. Select the location you want to store the image file in with the \oplus / \ominus button, then press the **SOURCE** button.

10. Press the **MENU** button to exit the customizing screen.

Selecting a wallpaper



1. Press the **MENU** button.
2. Select **Customize Settings** with the $\boxed{+}$ / $\boxed{-}$ button, then press the **SOURCE** button.
3. Select **Display Setup** with the $\boxed{+}$ / $\boxed{-}$ button, then press the **SOURCE** button.
4. Select **Select Wallpaper** with the $\boxed{+}$ / $\boxed{-}$ button, then press the **SOURCE** button.
5. Select the image file you want with the $\boxed{+}$ / $\boxed{-}$ button, then press the **SOURCE** button.
 - ▶ When the scroll is stopped, the thumbnail is displayed.
6. Press the **MENU** button to exit the customizing screen.

Controls

This chapter explains how to operate the various controls necessary for driving.



- Clock** 96
- Locking and Unlocking the Doors**
- Key Types and Functions 97
- Locking/Unlocking the Doors from the Outside 99
- Locking/Unlocking the Doors from the Inside 101
- Childproof Door Locks 102
- Auto Door Locking/Unlocking 103
- Opening and Closing the Tailgate**... 104
- Security System** 106
- Immobilizer System 106
- Security System Alarm* 106
- Opening and Closing the Windows**..... 108

- Opening and Closing the Moonroof*** .. 110
- Operating the Switches Around the Steering Wheel**
- Ignition Switch..... 111
- Turn Signals 112
- Light Switches..... 112
- Fog Lights* 114
- Daytime Running Lights 114
- Wipers and Washers 115
- Brightness Control 117
- Rear Defogger/Heated Door Mirror* Button 118
- Adjusting the Steering Wheel..... 119



- Adjusting the Mirrors**..... 120
- Interior Rearview Mirror 120
- Power Door Mirrors 121
- Adjusting the Seats** 122
- Adjusting the Seat Positions 122
- Interior Lights/Interior Convenience Items** 132
- Interior Lights 132
- Interior Convenience Items 133
- Heating and Cooling System*** 142
- Using Vents, Heating and A/C 142
- Climate Control System*** 145
- Using Automatic Climate Control ... 145
- Automatic Climate Control Sensors... 148

* Not available on all models



Adjusting the Clock



You can adjust the time in the clock display with the ignition switch in ON .



■ Using the MENU button

1. Press the **MENU** button.
2. Select **Adjust Clock** with the  /  button, then press the **SOURCE** button.



3. Press the  /  button to change the setting between **12 h** and **24 h**.









4. Select hour or minute with the  /  button.

5. Press the  /  button to adjust the numbers up or down.

6. Select **Set** with the  /  button, then press the **SOURCE** button to enter your selection.

▶ The display will return to the **Adjust Clock** display.

■ Using the SETUP button

1. Press the **SETUP** button.
2. Rotate  to select **Adjust Clock**, then press .
3. Rotate  to select the item you want to change (12/24 hour mode, hour, minute). Then press .
4. Rotate  to make the adjustment.
5. Press  to enter your selection. The display returns to **Adjust Clock**. Repeat steps 4 to 6 to adjust other items.
6. To enter the selection, Rotate  and select **Set**, then press .
7. Press the **SETUP** button to go back to the normal display.

▶▶ Adjusting the Clock

These indications are used to show how to operate the selector knob.

Rotate  to select.

Press  to enter.

To set the time to the nearest hour:

Press and hold the **CLOCK** button until the clock display begins to blink, then press the  (Reset) button.

Depending on the displayed time, the clock sets forward or backward.

Example:

1:06 will reset to 1:00

1:53 will reset to 2:00

Models with navigation system

The clock is automatically updated through the navigation system, so the time does not need to be adjusted.

Key Types and Functions

This vehicle comes with the following key:

Master Keys



Use the key to start and stop the engine, and to lock and unlock the doors and tailgate. You can also use the remote transmitter to lock and unlock the doors and tailgate.

Key Types and Functions

All the keys have an immobilizer system. The immobilizer system helps to protect against vehicle theft.

[Immobilizer System P. 106](#)

The keys contain precision electronics. Adhere to the following advice to prevent damage to the electronics:

- Do not leave the keys in direct sunlight, or in locations with high temperature or high humidity.
- Do not drop the keys or set heavy objects on them.
- Keep the keys away from liquids.
- Do not take the keys apart except for replacing the battery.

If the circuits in the keys are damaged, the engine may not start, and the remote transmitter may not work.

If the keys do not work properly, have them inspected by a dealer.

■ Valet Key



Can be used to start and stop the engine, and lock and unlock driver's door.

■ Key Number Tag

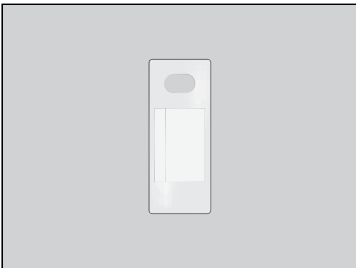

Contains a number that you will need if you purchase a replacement key.

▶▶ Valet Key

When you need to leave a key with a third party, leave the valet key.

▶▶ Key Number Tag

Keep the key number tag separate from the key in a safe place outside of your vehicle. If you wish to purchase an additional key, contact a dealer.

If you lose your key and you cannot start the engine, contact a dealer.

Locking/Unlocking the Doors from the Outside

Using the Remote Transmitter

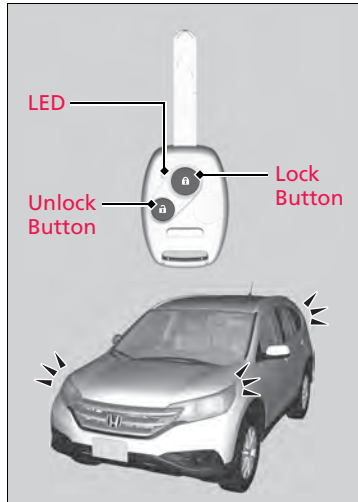

■ Locking the doors

Press the lock button.

Once:

- ▶ Some exterior lights flash, all the doors and tailgate lock, and the security system sets.

Twice (within five seconds after the first push):

- ▶ The beeper sounds and verifies the security system is set.

■ Unlocking the doors

Press the unlock button.

Once:

- ▶ Some exterior lights flash twice, and the driver's door unlocks.

Twice:

- ▶ The remaining doors and tailgate unlock.

☒ Using the Remote Transmitter

If you do not open a door within 30 seconds of unlocking the vehicle with the remote transmitter, the doors will automatically relock.

You can change the relock timer setting.

➤ [Customized Features P. 84](#)

If the interior light switch is in the door activated position, the interior lights come on when you press the unlock button.

No doors opened: The lights fade out after 30 seconds.

Doors relocked with the remote: The lights go off immediately.

➤ [Interior Lights P. 132](#)

The remote transmitter uses low-power signals, so the operating range may vary depending on the surroundings.

The remote will not lock the vehicle when a door or the tailgate is open.

If the distance at which the remote transmitter works varies, the battery is probably low.

If the LED does not come on when you press a button, the battery is dead.

➤ [Replacing the Button Battery P. 308](#)

You can customize the door unlock mode setting.

➤ [Customized Features P. 84](#)

■ Locking/Unlocking the Doors Using a Key

▶▶ Locking/Unlocking the Doors Using a Key

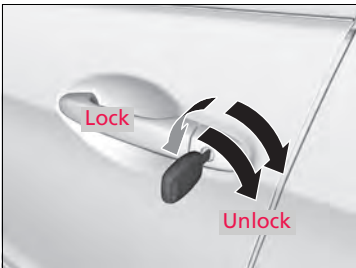

Fully insert the key and turn it.

■ Locking a Door Without Using a Key

▶▶ Locking a Door Without Using a Key

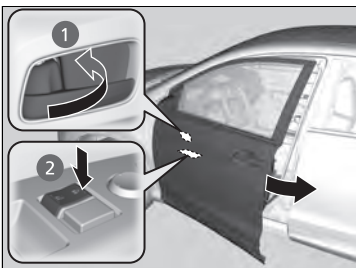

■ Locking the driver's door

Push the lock tab forward ① or push the master door lock switch in the lock direction ②, and close the door.

■ Locking the passenger's doors

Push the lock tab forward and close the door.

■ Lockout prevention system

The doors and tailgate cannot be locked when the key is in the ignition switch, and any door or the tailgate is open.

When you lock the driver's door with a key, all the other doors and tailgate lock at the same time. When unlocking, the driver's door unlocks first. Turn the key a second time within a few seconds to unlock the remaining doors and the tailgate.

You can customize the door unlock mode setting.

[▶▶ Customized Features P. 84](#)

When you lock the driver's door, all the other doors and tailgate lock at the same time. Make sure you have the key in your hand before locking the door to prevent it from being locked in the vehicle.

Locking/Unlocking the Doors from the Inside

Using the Lock Tab

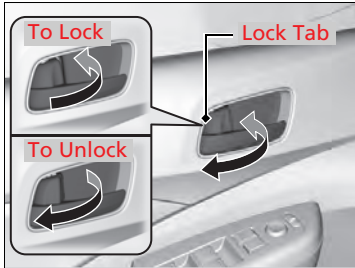

■ **Locking a door**
Push the lock tab forward.

■ **Unlocking a door**
Pull the lock tab rearward.

Unlocking Using the Front Door Inner Handle

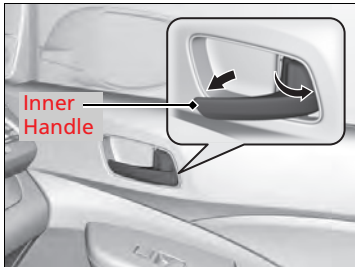

Pull the front door inner handle.

▶ The door unlocks and opens in one motion.

Using the Lock Tab

When you lock the door using the lock tab on the driver's door, all the other doors and tailgate lock at the same time.

When you unlock the door using the lock tab on the driver's door, only the driver's door will unlock.

Unlocking Using the Front Door Inner Handle

The front door inner handles are designed to allow front seat occupants to open the door in one motion. However, this feature requires that front seat occupants never pull a front door inner handle while the vehicle is in motion.

Children should always ride in a rear seat where childproof door locks are provided.

▶ [Childproof Door Locks P. 102](#)

■ Using the Master Door Lock Switch

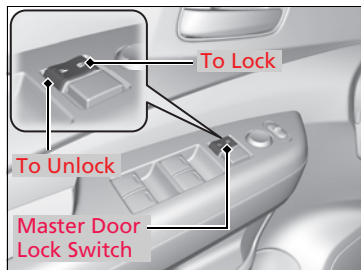

Press the master door lock switch in as shown to lock or unlock all doors and the tailgate.

☒ Using the Master Door Lock Switch

When you lock/unlock the driver's door using the master door lock switch, all the other doors and the tailgate lock/unlock at the same time.

The front passenger's door also has the master door lock switch.

Childproof Door Locks

The childproof door locks prevent the rear doors from being opened from the inside regardless of the position of the lock tab.

☒ Childproof Door Locks

To open the door from the inside when the childproof door lock is on, put the lock tab in the unlock position, lower the rear window, put your hand out of the window, and pull the outside door handle.

■ Setting the Childproof Door Locks

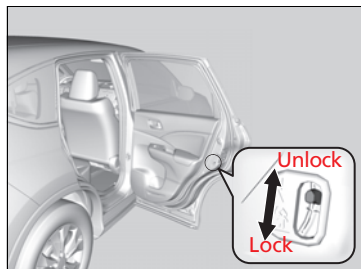

Slide the lever in the rear door to the lock position, and close the door.

■ When opening the door

Open the door using the outside door handle.

Auto Door Locking/Unlocking

Your vehicle locks all doors and unlocks the driver's door automatically when a certain condition is met.

■ Auto Door Locking

■ Drive lock mode

All doors and tailgate lock when the vehicle's speed reaches about 10 mph (15 km/h).

■ Auto Door Unlocking

■ Park unlock mode

The driver's door unlocks when the shift lever is moved into **P** with the brake pedal depressed.

☒ Auto Door Locking/Unlocking

You can turn off or change to another auto door locking/unlocking setting using the multi-information display.

▶ [Customized Features P. 84](#)

Precautions for Opening/Closing the Tailgate

Always make sure individuals and objects are clear of the tailgate before opening or closing it.

■ Opening the tailgate

- Open the tailgate all the way.
 - ▶ If it is not fully opened, the tailgate may begin to close under its own weight.
- Be careful when it is windy. The wind may cause the tailgate to close.

■ Closing the tailgate

Keep the tailgate closed while driving to:

- ▶ Avoid possible damage.
- ▶ Prevent exhaust gas from leaking into the vehicle.

➤ [Carbon Monoxide Gas P. 65](#)

ⓘ Precautions for Opening/Closing the Tailgate

Be careful not to hit your head on the tailgate or to put your hands between the tailgate and the cargo area when closing the tailgate.

When you are storing or picking up luggage from the cargo area while the engine is idling, do not stand in front of the exhaust pipe. You may get burned.

Do not allow any passenger in the cargo space. They may get hurt during hard braking, a sudden acceleration, or a crash.

ORG

Using the Tailgate Release Button

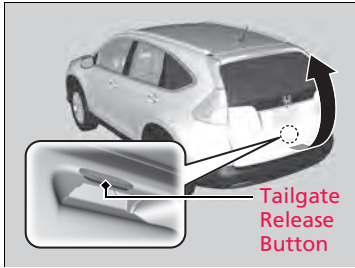

When all the doors are unlocked, the tailgate is unlocked. Press the tailgate release button and lift open the tailgate.

TOC

Controls



To close the tailgate, grab the inner handle, pull the tailgate down, and push it closed from outside.

Index

Home

Immobilizer System

The immobilizer system prevents a key that has not been pre-registered from starting the engine. Each key contains electronic transmitters that use electronic signals to verify the key.

Pay attention to the following when inserting the key into the ignition switch:

- Do not allow objects that emit strong radio waves near the ignition switch.
- Make sure the key is not covered by or touching a metal object.
- Do not bring a key from another vehicle's immobilizer system near the ignition switch.

Security System Alarm *

The security system alarm activates when the tailgate, hood, or doors are opened without the key, or remote transmitter.

■ When the security system alarm activates

The horn sounds intermittently and all the exterior lights flash.

■ To deactivate the security system alarm

Unlock the vehicle using the key or remote transmitter, or turning the ignition switch to ON **II**. The system, along with the horn and flashing lights, is deactivated.

☞ Immobilizer System

NOTICE

Leaving the ignition key in the vehicle can result in theft or accidental movement of the vehicle. Always take the ignition key with you whenever you leave the vehicle unattended.

Do not alter the system or add other devices to it. Doing so may damage the system and make your vehicle inoperable.

☞ Security System Alarm *

The security alarm continues for a maximum of two minutes until the security system deactivates.

■ Setting the security system alarm

The security system alarm automatically sets when the following conditions have been met:

- The ignition switch is in LOCK [0], and the key has been removed from the ignition switch.
- The hood and tailgate are closed.
- All doors and tailgate are locked with the key or the remote transmitter.

■ When the security system alarm sets

The security system alarm indicator in the instrument panel blinks. When the blinking interval changes after about 15 seconds, the security system alarm is set.

■ To cancel the security system alarm

The security system alarm is canceled when the vehicle is unlocked using the key or remote transmitter, or the ignition switch is turned to ON [II]. The security system alarm indicator goes off at the same time.

■ Panic Mode



■ The PANIC button on the remote transmitter

If you press the **PANIC** button for approximately one second, the following will occur for about 30 seconds:

- The horn sounds.
- Some exterior lights flash.

■ Canceling panic mode

Press any button on the remote transmitter, or turn the ignition switch to ON [II].

* Not available on all models

☒ Security System Alarm*

Do not set the security system alarm when someone is in the vehicle or a window is open. The system can accidentally activate when unlocking the door with the lock tab.

If the battery goes dead after you have set the security system alarm, the security alarm may go off once the battery is recharged or replaced. If this occurs, deactivate the security system alarm by unlocking a door using the key or remote transmitter.

Do not attempt to alter this system or add another device to it.

Opening/Closing the Power Windows

The power windows can be opened and closed when the ignition switch is in ON **II**, using the switches on the doors. The driver side switches can be used to open and close all the windows.

The power window lock button on the driver side must be switched off (not pushed in, indicator off) to open and close the windows from anywhere other than the driver's seat.

When the power window lock button is switched on (pushed in, indicator on), you can only operate the driver's window. Turn the power window lock button on if a child is in the vehicle.

Opening/Closing Windows with Auto-Open/Close Function

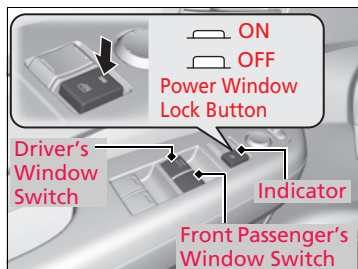

Automatic operation

To open: Push the switch down firmly.

To close: Pull the switch up firmly.

The window opens or closes completely. To stop the window at any time, push or pull the switch briefly.

Manual operation

To open: Push the switch down lightly.

To close: Pull the switch up lightly.

Release the switch when the window reaches the desired position.

Opening/Closing the Power Windows

WARNING

Closing a power window on someone's hands or fingers can cause serious injury.

Make sure your passengers are away from the windows before closing them.

The power windows can be operated for up to 10 minutes after you turn the ignition switch off. Opening either front door cancels this function.

Auto Reverse

If a power window senses resistance when closing automatically, it stops closing and reverse direction.

The driver's window auto reverse function is disabled when you continuously pull up the switch.

The auto reverse function stops sensing when the window is almost closed to ensure that it fully closes.

■ Opening/Closing Windows without Auto-Open/Close Function

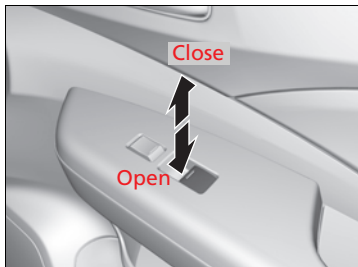

To open: Push the switch down.

To close: Pull the switch up.

Release the switch when the window reaches the desired position.

Opening/Closing the Moonroof

You can only operate the moonroof when the ignition switch is in ON (II). Use the switch in the front of the ceiling to open and close the moonroof.

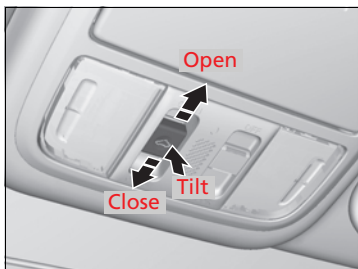

Automatic operation

To open: Pull the switch back firmly, then release.

To close: Push the switch forward firmly, then release.

The moonroof automatically opens or closes all the way. To stop the moonroof midway, touch the switch briefly.

Manual operation

To open: Pull the switch back, and hold it until the desired position is reached.

To close: Push the switch forward, and hold it until the desired position is reached.

Tilting the moonroof up

To tilt: Push on the center of the moonroof switch.

To close: Push the switch forward firmly, then release.

Opening/Closing the Moonroof

WARNING

Opening or closing the moonroof on someone's hands or fingers can cause serious injury.

Make sure all hands and fingers are clear of the moonroof before opening or closing it.

NOTICE

Opening the moonroof in below freezing temperature or when it is covered with snow or ice can damage the moonroof panel or motor.

The power moonroof can be operated for up to 10 minutes after you turn the ignition switch off. Opening either front door cancels this function.

When resistance is detected, the auto reverse function causes the moonroof to change directions, then stop. Auto reverse stops sensing when the moonroof is almost closed to ensure that it fully closes. Make sure that all objects, including fingers, are clear of the moonroof.

Ignition Switch

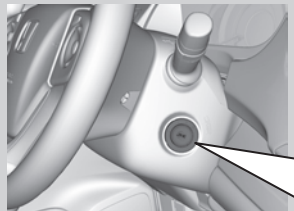

- 0 LOCK:** Insert and remove the key in this position.
- I ACCESSORY:** Operate the audio system and other accessories in this position.
- II ON:** This is the position when driving.
- III START:** This position is for starting the engine. The switch returns to ON **II** when you let go of the key.

Ignition Switch

You cannot take the key out unless the shift lever is in **P**.

If you open the driver's door when the key is in LOCK **0** or ACCESSORY **I**, a warning buzzer will sound to remind you to take the key out.

If the key won't turn from LOCK **0** to ACCESSORY **I**, turn the key while moving the steering wheel left and right. The steering wheel will unlock, allowing the key to turn.

Turn Signals

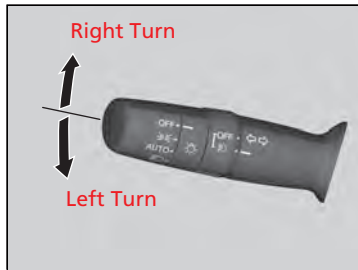

The turn signals can be used when the ignition switch is in ON .

Light Switches

Manual Operation

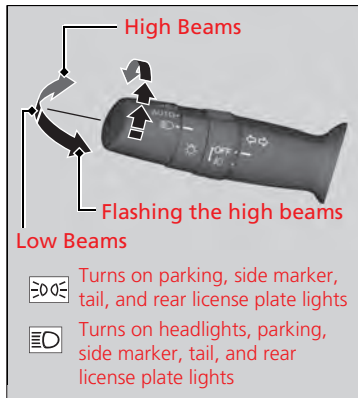

Rotating the light switch turns the lights on and off, regardless of the position of the ignition switch.

- **High beams**
Push the lever forward until you hear a click.
- **Low beams**
When in high beams, pull the lever back to return to low beams.
- **Flashing the high beams**
Pull the lever back, and release it.

Light Switches

If you remove the key from the ignition switch while the lights are on, a chime sounds when the driver's door is opened.

Do not leave the lights on when the engine is off because it will cause the battery to discharge.

Automatic Lighting Control *

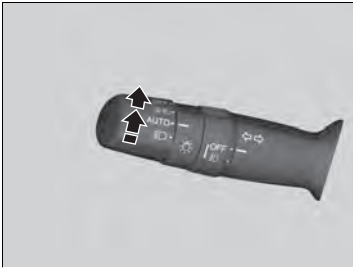

Automatic lighting control can be used when the ignition switch is in ON **II**.

When you turn the light switch to **AUTO**, the headlights and other exterior lights will switch on and off automatically depending on the ambient brightness.

- ▶ You can change the auto light sensitivity setting.
- ▶ [Customized Features P. 84](#)

Automatic Lighting Off Feature

The headlights, all other exterior lights, and the instrument panel lights turn off within 15 seconds after you remove the key and close the driver's door.

- ▶ You can change the headlight auto off timer setting.

▶ [Customized Features P. 84](#)

If you turn the ignition switch to LOCK **0** with the headlight switch on, but do not open the door, the lights turn off after 10 minutes (three minutes, if the switch is in the **AUTO** position).

The lights turn on again when you unlock or open the driver's door. If you unlock the door, but do not open it within 15 seconds, the lights go off. If you open the driver's door, you will hear a lights on reminder chime.

Automatic Lighting Control *

We recommend that you turn on the lights manually when driving at night, in a dense fog, or in dark areas such as long tunnels or parking facilities.

The light sensor is in the location shown below. Do not cover this light sensor with anything; otherwise, the automatic lighting system may not work properly.

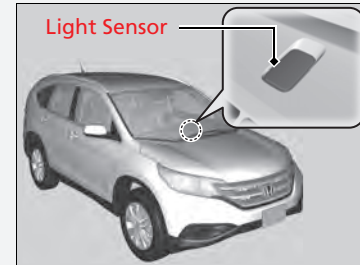

Adjust the auto light sensitivity as follows:

Setting	The exterior lights come on when the ambient light is at	
Max		Bright
High		
Mid		
Low		
Min		

* Not available on all models

Fog Lights*

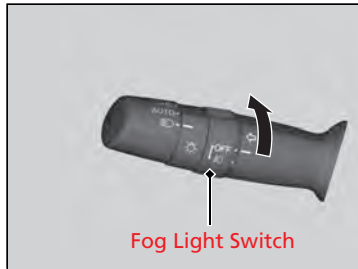

Can be used when the low beam headlights are on.

Rotate the switch up from the **OFF** position to the  position.



Fog Lights*

When the fog lights are on, the indicator in the instrument panel will be on.

The fog lights go off when the headlights turn off, or when the daytime running lights are on.

Daytime Running Lights

The high beam headlights come on slightly dimmer than normal when the following conditions have been met:

- The ignition switch is in ON .
- The headlight switch is off, or in .
- The parking brake is released.

The lights remain on even if you set the parking brake. Turning off the ignition switch will turn off the daytime running lights.

The high beam headlights return to the original brightness once the headlight switch is turned on.

Wipers and Washers

ORG

Windshield Wipers/Washers

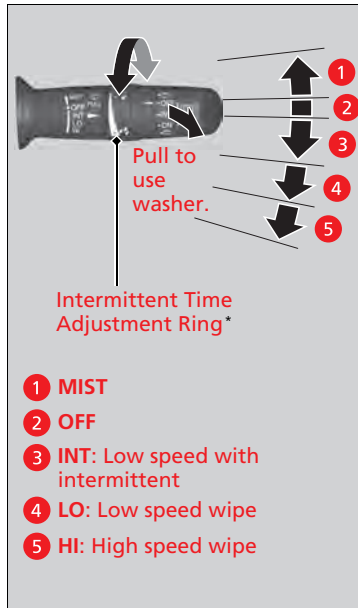

The windshield wipers and washers can be used when the ignition switch is in ON .

■ MIST

The wipers run at high speed until you release the lever.

■ Wiper switch (OFF, INT, LO, HI)

Change the wiper switch setting according to the amount of rain.

■ Adjusting the delay*

Turn the adjustment ring to adjust the wiper delay.



■ Washer

Sprays while you pull the lever toward you. When you release the lever, the wipers make two or three more sweeps before stopping.

Wipers and Washers

NOTICE

Do not use the wipers when the windshield is dry. The windshield will get scratched, or the rubber blades will get damaged.

NOTICE

In cold weather, the blades may freeze to the windshield, becoming stuck.

Operating the wipers in this condition may damage the wipers. Use the defroster to warm the windshield, then turn the wipers on.

Turn the washers off if no washer fluid comes out. The pump may get damaged.

Models with intermittent time adjustment ring

If the vehicle speeds up while the wipers are operating intermittently, the length of the wipe interval shortens. When the vehicle starts moving, the wipers make a single sweep.

When the vehicle speeds up, the wiper operation's shortest delay setting  and the **LO** setting become the same.

TOC

Controls

Index

Home

* Not available on all models

Continued

■ Rear Wiper/Washer



The rear wiper and washer can be used when the ignition switch is in ON .

■ Wiper switch (OFF, INT, ON)

Change the wiper switch setting according to the amount of rain.

■ Washer

Sprays while you rotate the switch to this position.



Hold it to activate the wiper and to spray the washer. Once released, it stops operating after a few more sweeps.

■ Operating in reverse

When you shift the transmission to  with the windshield wipers activated, the rear wiper operates automatically as follows even if its switch is off.

Front Wiper Position	Rear Wiper Operation
INT (Intermittent)	Intermittent
LO (Low speed wipe) HI (High speed wipe)	Continuous

▶▶ Wipers and Washers

If the wiper stops operating due to any obstacle such as the build-up of snow, park the vehicle in a safe place. Rotate the wiper switch to **OFF**, and turn the ignition switch to ACCESSORY  or LOCK , then remove the obstacle.

The wiper motor is equipped with a breaker that may stop motor operation temporarily to prevent an overload. Wiper operation resumes within a few minutes, once the circuit has returned to normal.

Brightness Control



When the parking lights are turned on and the ignition switch is in ON , you can use the brightness control knob to adjust instrument panel brightness.

Brighten: Turn the knob to the right.

Dim: Turn the knob to the left.

You will hear a beep when the brightness reaches minimum or maximum. The information display will return to its original state several seconds after you adjust the brightness.

■ Brightness level indicator

The brightness level is shown on the information display while you are adjusting it.

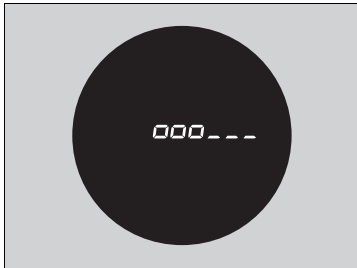

☒ Brightness Control

Instrument panel brightness differs between when the exterior lights are on and when they are off. The instrument panel dims to reduce glare when the lights are on.

Pressing the  (Select/Reset) knob switches the display.

If you turn the knob to the right until the brightness display is up to max, the beeper sounds. This cancels the reduced instrument panel brightness when the exterior lights are on.

Rear Defogger/Heated Door Mirror* Button

Press the rear defogger and heated door mirror button to defog the rear window and mirrors when the ignition switch is on **II**.

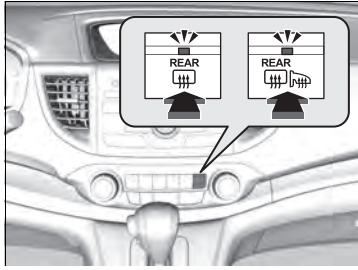

Models with heating and cooling system

The rear defogger and heated door mirrors automatically switch off after 20 minutes. However, if the outside temperature is 18°F (−8°C) or below, they do not automatically switch off.

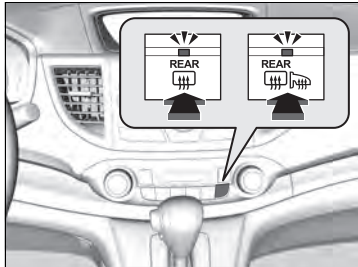

Models with climate control system

The rear defogger and heated door mirrors automatically switch off after 10-30 minutes depending on the outside temperature. However, if the outside temperature is 32°F (0°C) or below, they do not automatically switch off.

▶▶ Rear Defogger/Heated Door Mirror* Button

NOTICE

When cleaning the inside of the rear window, be careful not to damage the heating wires. It is critical to wipe the window from side to side along the defogger heating wires.

This system consumes a lot of power, and may weaken the battery, making it difficult to start the engine. Turn it off when the window has been defogged.

Also, do not use the system for a long period even if the engine is idling.

Adjusting the Steering Wheel

The steering wheel height and distance from your body can be adjusted so that you can comfortably grip the steering wheel in an appropriate driving posture.

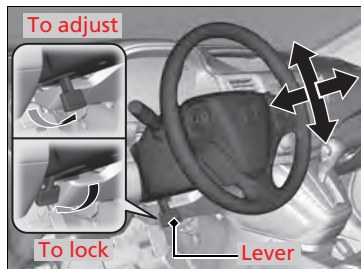

1. Pull the steering wheel adjustment lever up.
 - ▶ The steering wheel adjustment lever is under the steering column.
2. Move the steering wheel up or down, and in or out.
 - ▶ Make sure you can see the instrument panel gauges and indicators.
3. Push the steering wheel adjustment lever down to lock the steering wheel in position.
 - ▶ After adjusting the position, make sure you have securely locked the steering wheel in place by trying to move it up, down, in, and out.

Adjusting the Steering Wheel

⚠ WARNING

Adjusting the steering wheel position while driving may cause you to lose control of the vehicle and be seriously injured in a crash.

Adjust the steering wheel only when the vehicle is stopped.

Make any steering wheel adjustments before you start driving.

Interior Rearview Mirror

Adjust the angle of the rearview mirror when you are sitting in the correct driving position.

Rearview Mirror with Day and Night Positions*

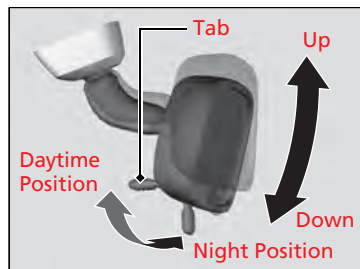

Flip the tab to switch the position. The night position will help to reduce the glare from headlights behind you when driving after dark.

Automatic Dimming Rearview Mirror*

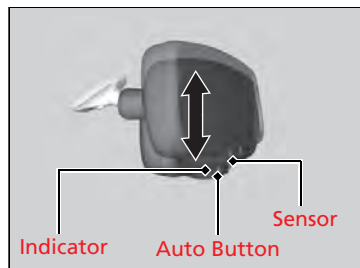

Reduces the glare from headlights behind you when driving after dark. Press the auto button to turn this function on and off. When activated, the auto indicator comes on.

Adjusting the Mirrors

Keep the inside and outside mirrors clean and adjusted for best visibility.

Adjust the mirrors before you start driving.

[Adjusting the Seat Positions P. 122](#)

Automatic Dimming Rearview Mirror*

The auto dimming function cancels when the shift position is in **R**.

Power Door Mirrors

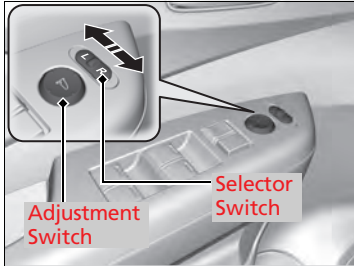

You can adjust the door mirrors when the ignition switch is in ON .

■ Mirror position adjustment

L/R selector switch: Select the left or right mirror. After adjusting the mirror, return the switch to the center position.

Mirror position adjustment switch: Press the switch left, right, up, or down to move the mirror.

■ Expanded View Driver's Mirror

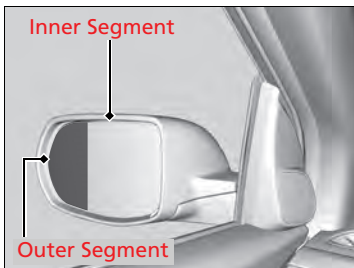

The driver side door mirror has outer and inner segments.

The outer segment is slightly curved to provide a wider angle view than a standard flat mirror. This wider view may help you check areas that are not visible using a standard door mirror.

▣ Expanded View Driver's Mirror

Objects visible in the outer segment of the driver side door mirror appear smaller than objects in the rest of the mirror. But in fact, they are closer than they appear.

Do not rely on your mirrors. Always look to the side and behind your vehicle before changing lanes.

Adjusting the Seat Positions

ORG

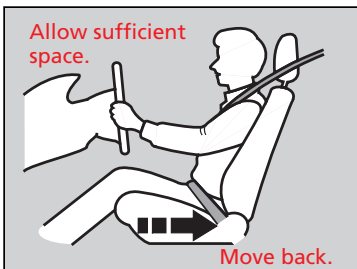

Adjust the driver's seat as far back as possible while allowing you to maintain full control of the vehicle. You should be able to sit upright, well back in the seat and be able to adequately press the pedals without leaning forward, and grip the steering wheel comfortably. The passenger's seat should be adjusted in a similar manner, so that it is as far back from the front airbag in the dashboard as possible.

Adjusting the Seats

WARNING

Sitting too close to a front airbag can result in serious injury or death if the front airbags inflate.

Always sit as far back from the front airbags as possible while maintaining control of the vehicle.

The National Highway Traffic Safety Administration and Transport Canada recommend that drivers allow at least 10 inches (25 cm) between the center of the steering wheel and the chest.

Always make seat adjustments before driving.

Adjusting the driver's power seat*

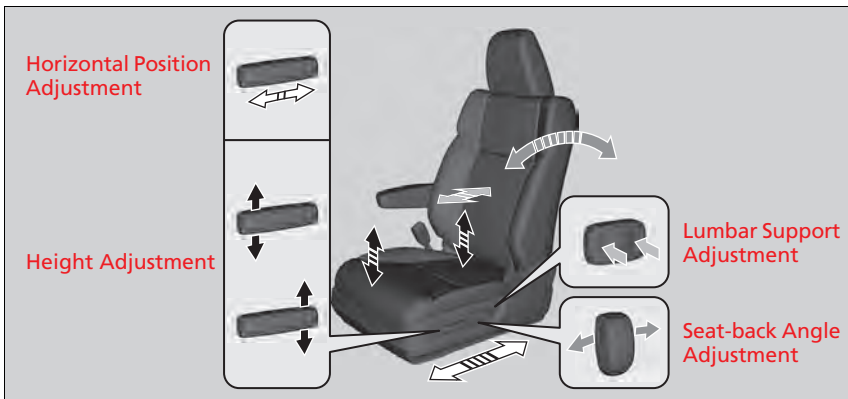

TOC

Controls

Index

Home

■ Adjusting the front manual seat(s)

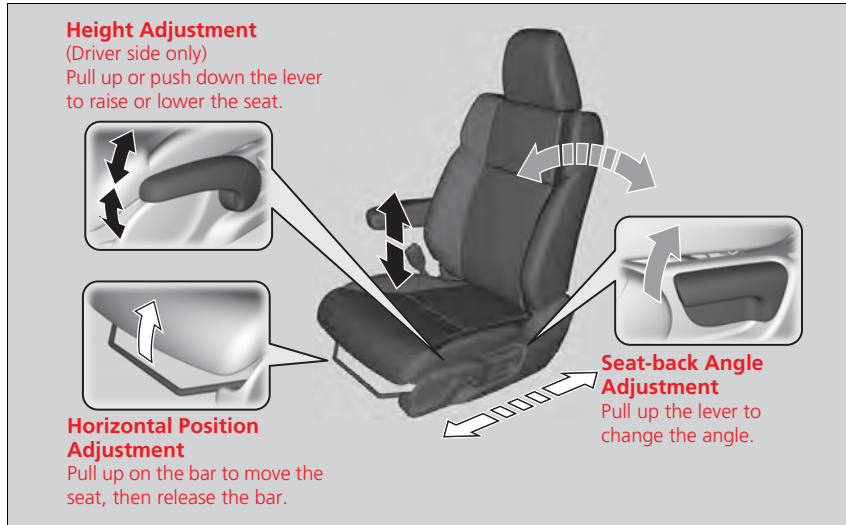

⊠ Adjusting the front manual seat(s)

Once a seat is adjusted correctly, rock it back and forth to make sure it is locked in position.

■ Adjusting the Seat-Backs

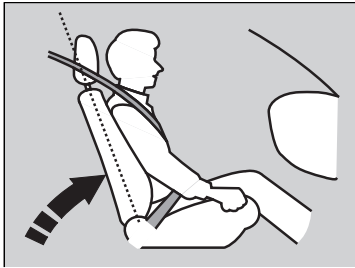

Adjust the driver's seat-back to a comfortable, upright position, leaving ample space between your chest and the airbag cover in the center of the steering wheel.

The front seat passenger should also adjust their seat-back to a comfortable, upright position.

Reclining a seat-back so that the shoulder part of the belt no longer rests against the occupant's chest reduces the protective capability of the belt. It also increases the chance of sliding under the belt in a crash and being seriously injured. The farther a seat-back is reclined, the greater the risk of injury.

►► Adjusting the Seat-Backs

⚠ WARNING

Reclining the seat-back too far can result in serious injury or death in a crash.

Adjust the seat-back to an upright position, and sit well back in the seat.

Do not put a cushion, or other object, between the seat-back and your back.

Doing so may interfere with proper seat belt or airbag operation.

If you cannot get far enough away from the steering wheel and still reach the controls, we recommend that you investigate whether some type of adaptive equipment may help.

■ Adjusting the Head Restraints

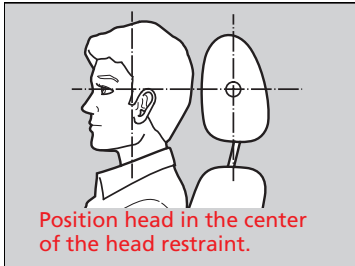

Your vehicle is equipped with head restraints in all seating positions.

Head restraints are most effective for protection against whiplash and other rear-impact crash injuries when the center of the back of the occupant's head rests against the center of the restraint. The tops of the occupant's ears should be level with the center height of the restraint.

■ Adjusting the front head restraint positions

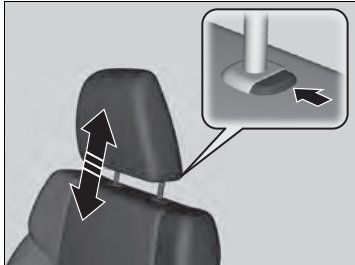

To raise the head restraint: Pull it upward.

To lower the head restraint: Push it down while pressing the release button.

ⓘ Adjusting the Head Restraints

⚠ WARNING

Improperly positioning head restraints reduces their effectiveness and increases the likelihood of serious injury in a crash.

Make sure head restraints are in place and positioned properly before driving.

In order for the head restraint system to work properly:

- Do not hang any items on the head restraints, or from the restraint legs.
- Do not place any objects between an occupant and the seat-back.
- Install each restraint in its proper location.

■ Changing the Rear Center Seat Head Restraint Position

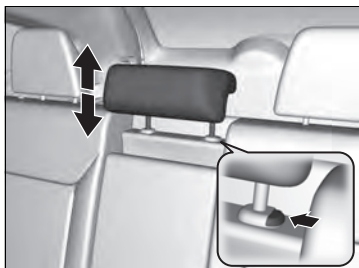

A passenger sitting in the center back seating position should adjust the height of their head restraint to an appropriate position before the vehicle begins moving.

To raise the head restraint:

Pull it upward.

To lower the head restraint:

Push it down while pressing the release button.

■ Removing and Reinstalling the Head Restraints

Front and rear center head restraints

Head restraints can be removed for cleaning or repair.

To remove the head restraint:

Pull the restraint up as far as it will go. Then push the release button, and pull the restraint up and out.

To reinstall the head restraint:

Insert the legs back in place, then adjust the head restraint to an appropriate height while pressing the release button. Pull up on the restraint to make sure it is locked in position.

▶▶ Removing and Reinstalling the Head Restraints

⚠ WARNING

Failure to reinstall, or correctly reinstall, the head restraints can result in severe injury during a crash.

Always replace the head restraints before driving.

Folding Down the Rear Outer Head Restraint

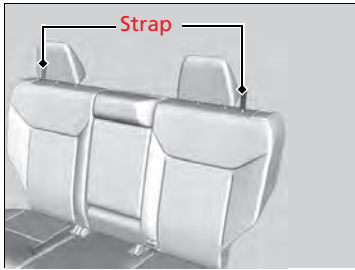

A passenger in an outer back seating position should put the head restraint in the upright position before the vehicle begins moving.

To fold down the head restraint:

Pull the strap.

To put the head restraint back in the upright position:

Pull up the head restraint and push rearward until it latches.

■ Maintain a Proper Sitting Position

After all occupants have adjusted their seats and head restraints, and put on their seat belts, it is very important that they continue to sit upright, well back in their seats, with their feet on the floor until the vehicle is safely parked and the engine is off.

Sitting improperly can increase the chance of injury during a crash. For example, if an occupant slouches, lies down, turns sideways, sits forward, leans forward or sideways, or puts one or both feet up, the chance of injury during a crash is greatly increased.

In addition, an occupant who is out of position in the front seat can be seriously or fatally injured in a crash by striking interior parts of the vehicle or being struck by an inflating front airbag.

» Maintain a Proper Sitting Position

WARNING

Sitting improperly or out of position can result in serious injury or death in a crash.

Always sit upright, well back in the seat, with your feet on the floor.

Rear Seats

Folding Down the Rear Seats

The rear seats can be folded down separately to allow for additional storage space.

To fold down the seat

1. Store the center seat belt first. Insert the latch plate into the slot on the side of the anchor buckle.
2. Retract the seat belt into the holder on the ceiling.
 - ▶ [Seat Belt with Detachable Anchor P. 34](#)
3. Lower the center head restraint to its lowest position. Put the armrest back into the seat-back.



From the rear door side

4. Pull the release strap.
 - ▶ The seat cushion flips forward, the head restraints tilt downward, and the seat-back then folds flat.

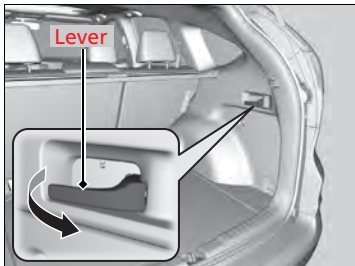

From the cargo area side

4. Pull the release lever.
 - ▶ The seat cushion flips forward, the head restraints tilt downward, and the seat-back then folds flat.

Folding Down the Rear Seats

Make sure all items in the cargo area or items extending to the rear seats are properly secured. Loose items can fly forward if you have to brake hard.

Remove any items from the rear seat cushion and floor before you fold down the rear seat.

Make sure the seat-back completely lowers (a click sounds). Otherwise it will not re-latch when returned to the upright position.

The front seat(s) must be far enough forward so they do not interfere with the rear seats as they fold down.

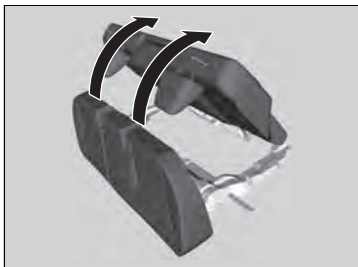

■ **To return the seat to the original position**

1. Pull the seat-back up and push back into place until a click is heard.

2. Push the head restraint up to its original position.

3. Pull the seat cushion up and push it down into its original position.

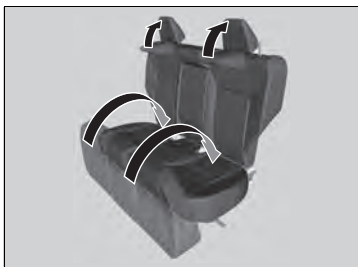

►► To return the seat to the original position

Make sure the seat-back, head restraints and seat cushion are securely latched back into place before driving.

■ **Rear Seat-back Adjusting**



Pull the lever on the right to change the angle of the right half of the seat-back, and left for the left half.

Armrest

■ Using the Front Seat Armrest*



Pull down the armrest.

■ Using the Rear Seat Armrest

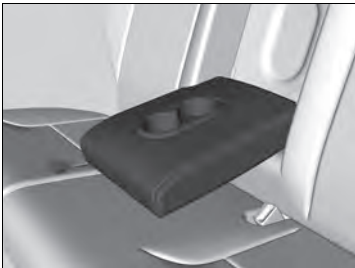

Pull down the armrest in the center seat-back.

* Not available on all models

Interior Lights

Interior Light Switches



■ ON

The interior lights come on regardless of whether the doors are open or closed.

■ Door activated

The interior lights come on in the following situations:

- When any of the doors are opened.
- You unlock the driver's door.
- You remove the key from the ignition switch.

Only the cargo area light comes on when the tailgate is opened.

■ OFF

The interior lights remain off regardless of whether the doors are open or closed.

☞ Interior Light Switches

In the door activated position, the interior lights fade out and go off about 30 seconds after the doors are closed.

The lights go off after 30 seconds in the following situations:

- When you unlock the driver's door but do not open it.
- When you remove the key from the ignition switch but do not open a door.

You can change the interior lights dimming time.

[☞ Customized Features P. 84](#)

The interior lights go off immediately in the following situations:

- When you lock the driver's door.
- When you close the driver's door with the key in the ignition switch.
- When you turn the ignition switch to ON **(II)**.

If you leave any of the doors open without the key in the ignition switch, the interior lights go off after about 15 minutes.

☞ Map Lights

When the interior light switch is in the door activated position and any door is open, pressing the lens does not turn off the map light.

Map Lights

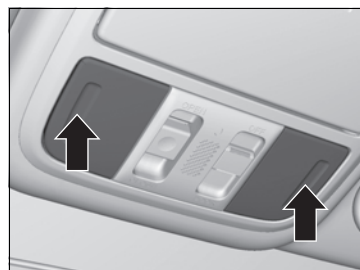

The map lights can be turned on and off by pressing the lenses.

Interior Convenience Items

Glove Box

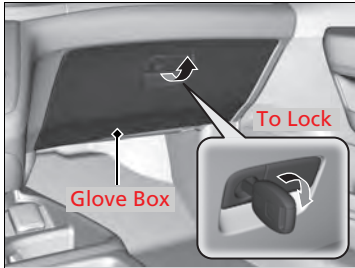

Pull the handle to open the glove box. You can lock the glove box with the master key.

Console Compartment

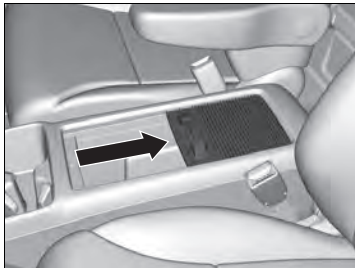

Slide the lid using the release knob to open or close the console compartment.

Glove Box

⚠ WARNING

An open glove box can cause serious injury to your passenger in a crash, even if the passenger is wearing the seat belt.

Always keep the glove box closed while driving.

Beverage Holders



■ Front seat beverage holders

Are located in the console between the front seats.

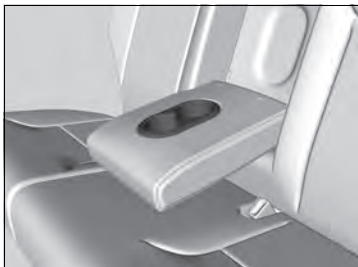

■ Rear seat beverage holders

Fold the armrest down to use the rear seat beverage holders.

» Beverage Holders

NOTICE

Spilled liquids can damage the upholstery, carpeting, and electrical components in the interior.

Be careful when you are using the beverage holders. Hot liquid can scald you.

■ Accessory Power Sockets

The accessory power sockets can be used when the ignition switch is in ACCESSORY **I** or ON **II**.



■ Accessory power socket on the console panel

Open the cover to use it.

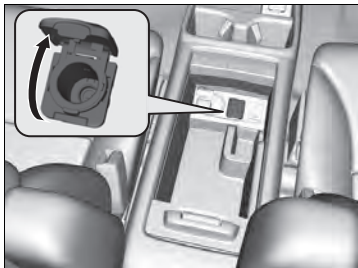

■ Accessory power socket in the console compartment *

Open the console lid and the cover to use it.

▣ Accessory Power Sockets

NOTICE

Do not insert an automotive type cigarette lighter element.

This can overheat the power socket.

The accessory power socket is designed to supply power for 12 volt DC accessories that are rated 180 watts or less (15 amps).

To prevent battery drain, only use the power socket with the engine running.

When both sockets are being used, the combined power rating of the accessories should not exceed 180 watts (15 amps).

* Not available on all models

■ Coat Hook

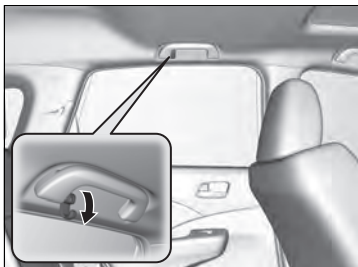

There is a coat hook on the rear left grab handle. Pull it down to use it.

■ Cargo Side Net



Use the cargo side net to secure items to the side.

» Coat Hook

The coat hook is not designed for large or heavy items.

Tie-down Anchors

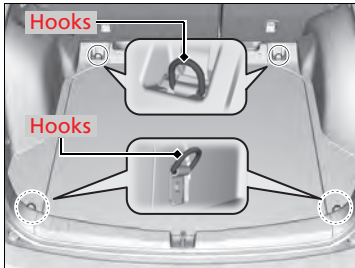

The tie-down anchors on the cargo area floor can be used to install a net for securing items.

Cargo Hooks

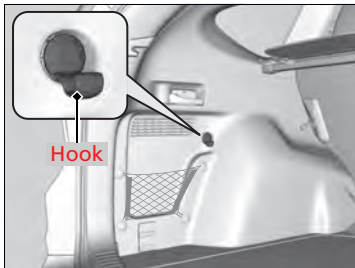

The cargo hooks on both sides of the cargo area can be used to hang a light items.

☒ Tie-down Anchors

Do not let anyone access items in the cargo area while driving. Loose items can cause injury if you have to brake hard.

☒ Cargo Hooks

NOTICE
Do not hang a large object or an object that weighs more than 6lbs (3kg) on the side cargo hooks. Hanging heavy or large objects may damage the hooks.

■ Sunglasses Holder



To open the sunglasses holder, press and release the indent. To close, press it again until it latches.

You can store eyeglasses and other small items in this holder.



■ Conversation mirror

The sunglasses holder comes with a mirror. Open the sunglasses holder fully, then push it back to the first detent.

You can use the mirror to view the rear seats.

☞ Sunglasses Holder

Keep the holder closed while driving except when accessing stored items.

Seat Heaters*



The ignition switch must be in ON **II** to use the seat heaters. The **HI** setting heats the seats faster than the **LO** setting.

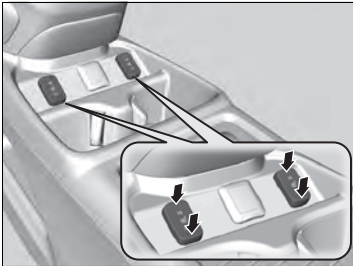

The indicator for your setting comes on while the seat heater is in use. Press the button on the opposite side to turn the heater off. The indicator goes off.

While in **HI**, the heater cycles on and off. When a comfortable temperature is reached, select **LO** to keep the seat warm.

Seat Heaters*

WARNING

Heat induced burns are possible when using seat heaters.

Persons with a diminished ability to sense temperature (e.g., persons with diabetes, lower-limb nerve damage, or paralysis) or with sensitive skin should not use seat heaters.

Do not use the seat heaters even in **LO** when the engine is off. Under such conditions, the battery may be weakened, making the engine difficult to start.

In the **LO** setting, the heater runs continuously and does not automatically turn off.

* Not available on all models

■ Tonneau Cover*

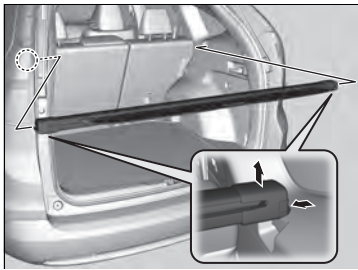
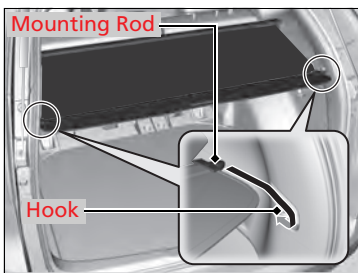
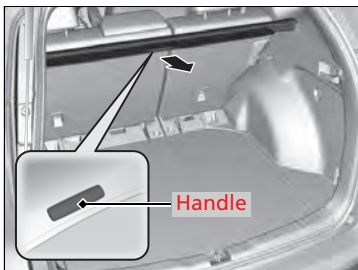

The tonneau cover can be used to conceal items in the cargo area and protect them from direct sunlight.

■ To extend:
Pull the handle on the center edge, then clip the mounting rods in the hooks on both sides of the tailgate opening.

■ To retract:
Slip the rods out of the hooks, then slowly roll it back until it is completely retracted.

■ To remove:
Push either end of the housing inward, then lift it out of its position.

►► Tonneau Cover*

Do not let anyone access items in the cargo area while driving. Loose items can cause injury if you have to brake hard.

Do not stack objects higher than the top of the seat in the cargo area. They could block your view and be thrown about the vehicle during a sudden stop.

- To prevent tonneau cover damage:
- Do not place items on the tonneau cover.
 - Do not put weight on the tonneau cover.

ORG

**■ To store:**

The housing unit can be stored on the cargo area floor to make more space available.

Push one end of the unit into the hole on one side panel, then insert the other end into the hole on the other side.

After storing the unit, rock it up and down to make sure it is securely placed.

TOC

Controls

Index

Home

Using Vents, Heating and A/C

ORG

TOC

Controls

Mode Buttons

Change airflow.

Floor and defroster vents

Floor vents

Dashboard and floor vents

Dashboard vents

Windshield Defroster Button

Turns on the A/C, selects airflow from the defroster vents at the base of the windshield, and switches the mode to fresh air.

Fan Control Dial

Adjusts the fan speed. Rotate the dial all the way to OFF to turn everything off.

MAX A/C Button

Turns on the A/C, selects airflow from the dashboard vents, and switches the mode to recirculation.

A/C Button

Press to cool the interior or dehumidify while heating.

Temperature Control Dial

Adjusts the interior temperature.

(Recirculation) Button

Press the  button and switch the mode depending on environmental conditions.

Recirculation mode (indicator on):
Recirculates air from the vehicle's interior through the system.

Fresh air mode (indicator off):
Maintains outside ventilation. Keep the system in fresh air mode in normal situations.

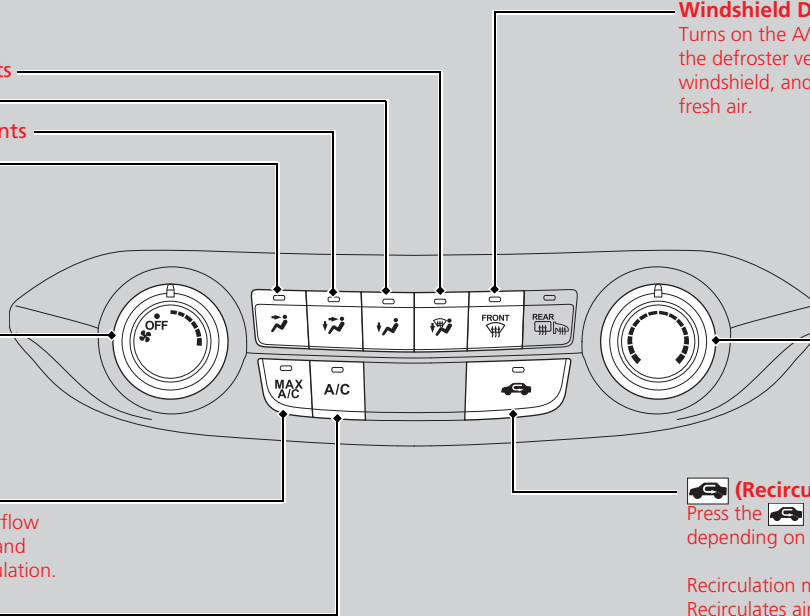



Index

Home

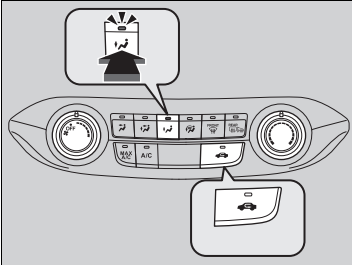

Heating



The heater uses heat from the engine coolant to warm the air.

1. Adjust the fan speed using the fan control dial.
2. Select .
3. Adjust the temperature using the temperature control dial.
4. Press the  button (indicator off).

■ To rapidly warm up the interior

1. Set the fan to the maximum speed.
2. Select .
3. Set the temperature to maximum high.
4. Press the  button (indicator on).

■ To dehumidify the interior

When used in combination with the heater, the air conditioning system makes the interior warm and dry and can prevent the windows from fogging up.

1. Adjust the fan speed using the fan control dial.
2. Press the **A/C** button to turn on the air conditioning system.
3. Select .
4. Adjust the temperature using the temperature control dial.

☒ Heating

When you select , the mode automatically switches to fresh air.

☒ To rapidly warm up the interior

Change to fresh air mode as soon as the interior gets warm enough. The windows may fog up if kept in recirculation mode.

■ Cooling

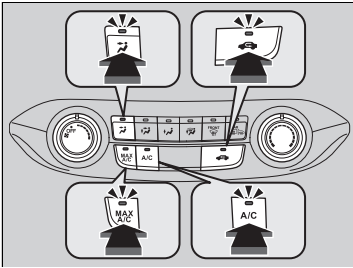



1. Adjust the fan speed using the fan control dial.
2. Select .
3. Adjust the temperature using the temperature control dial.
4. Press the **A/C** button (indicator on).

■ To rapidly cool down the interior

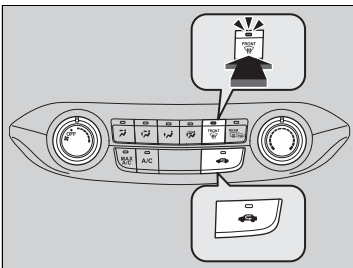

1. Set the fan to the maximum speed.
2. Set the temperature to maximum low.
3. Press the  button (indicator on).

■ Defrosting the Windshield and Windows



Pressing the  button turns the air conditioning system on and automatically switches the system to fresh air mode.

■ To rapidly defrost the windows

1. Set the fan to the maximum speed.
2. Press the  button.
3. Press the  button.
4. Set the temperature to maximum high.

▶▶ To rapidly cool down the interior

If the interior is very warm, you can cool it down more rapidly by partially opening the windows.

While in the ECON mode, the system has greater temperature fluctuations.

Pressing the  button bypasses the ECON mode control, and cools down the interior more rapidly.

▶▶ Defrosting the Windshield and Windows

For your safety, make sure you have a clear view through all the windows before driving.

Do not set the temperature near the upper or lower limit.

When cold air hits the windshield, the outside of the windshield may fog up.

If the side windows fog up, adjust the vents so that the air hits the side windows.

▶▶ To rapidly defrost the windows

After defrosting the windows, switch over to fresh air mode.

If you keep the system in recirculation mode, the windows may fog up from humidity. This impedes visibility.

Using Automatic Climate Control

The automatic climate control system maintains the interior temperature you select. The system also selects the proper mix of heated or cooled air that raises or lowers the interior temperature to your preference as quickly as possible.

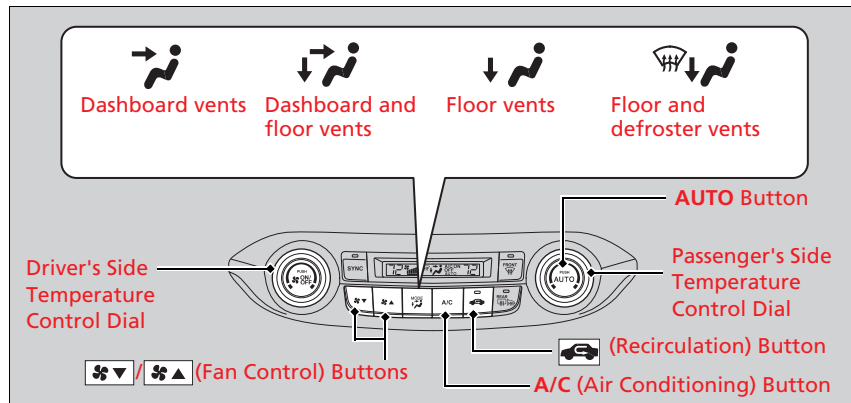

Use the system when the engine is running.

1. Press the **AUTO** button.
2. Adjust the interior temperature using the driver's side or passenger's side control dial.
3. Press the  button to cancel.

Switching between the recirculation and fresh air modes

Press the  button and switch the mode depending on environmental conditions. Recirculation mode (indicator on): Recirculates air from the vehicle's interior through the system.

Fresh air mode (indicator off): Maintains outside ventilation. Keep the system in fresh air mode in normal situations.

* Not available on all models

Using Automatic Climate Control

If any button is pressed while in **AUTO**, the function of that button takes priority. The **AUTO** indicator goes off, but functions of other buttons pressed are still in auto mode.

To prevent cold air from blowing in from outside, the fan may not start immediately when the **AUTO** button is pressed.

If the interior is very warm, you can cool it down more rapidly by partially opening the windows, turning the system on **AUTO**, and setting the temperature to low. Change the fresh air mode to recirculation mode until the temperature cools down.

When you set the temperature to the lower or upper limit, **Lo** or **Hi** is displayed.

Pressing the  button switches the climate control system between on and off. When turned on, the system returns to your last selection.

While in ECON mode, the system has greater temperature fluctuations.

Continued

■ Defrosting the Windshield and Windows

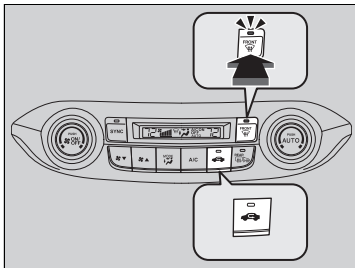

Pressing the  button turns the air conditioning system on and automatically switches the system to fresh air mode.

Pressing the  button again to turn off, the system returns to the previous settings.

■ To rapidly defrost the windows

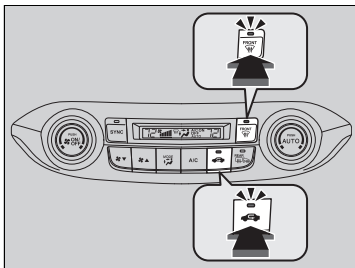

1. Press the  button.
2. Press the  button.

▶▶ Defrosting the Windshield and Windows

For your safety, make sure you have a clear view through all the windows before driving.

Do not set the temperature near the upper or lower limit.

When cold air hits the windshield, the outside of the windshield may fog up.

If the side windows fog up, adjust the vents so that the air hits the side windows.

▶▶ To rapidly defrost the windows

After defrosting the windows, switch over to fresh air mode. If you keep the system in recirculation mode, the windows may fog up from humidity. This impedes visibility.

Synchronized Mode

ORG

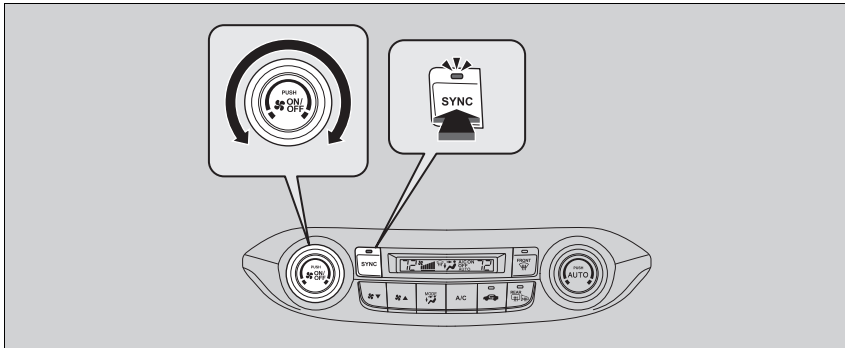

You can set the temperature synchronously for the driver side and the passenger side in synchronized mode.

1. Press the **SYNC** button.
 - The system switches to synchronized mode.
2. Adjust the temperature using driver's side temperature control dial.

Press the **SYNC** button to return to dual mode.

☒ Synchronized Mode

When you press the **FRONT SYNC** button, the system changes to synchronized mode.

When the system is in dual mode, the driver side temperature and the passenger side temperature can be set separately.

Models with navigation system

In AUTO mode, the system adjusts each temperature based on the information of the sunlight sensor and the sun position updated by the navigation system's GPS.

TOC

Controls

Index

Home

Automatic Climate Control Sensors

ORG

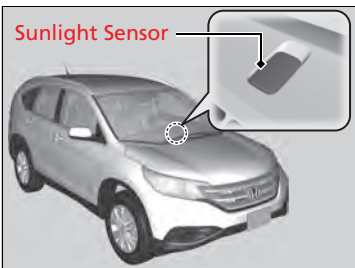

The automatic climate control system is equipped with a sunlight sensor, an interior temperature and humidity sensor. Do not cover or spill any liquid on them.

TOC

Controls

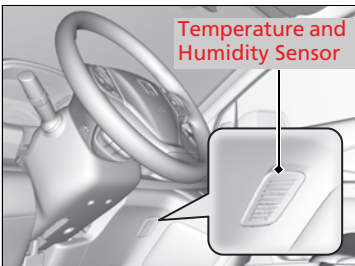

Index

Home

Features

This chapter describes how to operate technology features.



- Audio System**
 - About Your Audio System..... 150
 - USB Adapter Cable 151
 - Auxiliary Input Jack* 151
 - Audio Antenna 152
 - Audio System Theft Protection 152
- Audio System Basic Operation** 153
 - Audio Remote Controls..... 154
 - Adjusting the Sound 155
 - Playing AM/FM Radio..... 156
 - Playing XM® Radio* 159
 - Playing a CD 161
 - Playing an iPod®..... 164
 - Playing Internet Radio 167
 - Playing a USB Flash Drive 169
 - Playing *Bluetooth*® Audio 172
- Rear Entertainment System*** 174
- Audio Error Messages**..... 186
- General Information on the Audio System**..... 190
 - Bluetooth*® HandsFreeLink®**
 - Using HFL 194
 - HFL Menus 196
- Compass** 223

* Not available on all models

About Your Audio System

On models with navigation system, see the Navigation System Manual for operation of the audio system, *Bluetooth*® HandsFreeLink®, and voice commands for these features.

The audio system features AM/FM radio and the XM® Radio* service. It can also play audio CDs, WMA/MP3/AAC files, USB flash drives, iPod®, iPhone® and *Bluetooth*® devices.

You can operate the audio system from the buttons and switches on the panel, or the remote controls on the steering wheel.

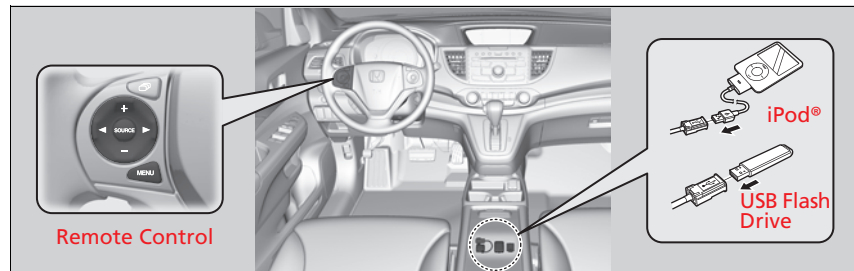

About Your Audio System

XM® Radio is available on a subscription basis only. For more information on XM® Radio, contact a dealer.

[General Information on the Audio System](#)
P. 190

XM® Radio is available in the United States and Canada, except Hawaii, Alaska, and Puerto Rico.

XM® is a registered trademark of Sirius XM Radio, Inc.

Video CDs, DVDs, and 3-inch (8-cm) mini CDs are not supported.

iPod® and iPhone® are registered trademark owned by Apple Inc.

State or local laws may prohibit the operation of handheld electronic devices while operating a vehicle.

USB Adapter Cable

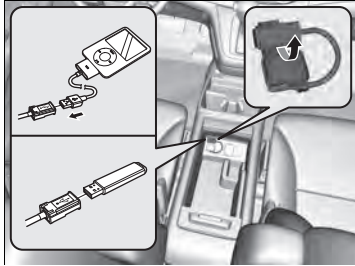

1. Unclip the USB connector and loosen the adapter cable.
2. Install the iPod® dock connector or the USB flash drive to the USB connector.

▣ USB Adapter Cable

- Do not leave the iPod® or USB flash drive in the vehicle. Direct sunlight and high temperatures may damage it.
- Do not use an extension cable with the USB adapter cable.
- Do not connect the iPod® or USB flash drive using a hub.
- Do not use a device such as a card reader or hard disk drive, as the device or your files may be damaged.
- We recommend keeping your data backed up before using the device in your vehicle.
- Displayed messages may vary depending on the device model and software version.

If the audio system does not recognize the iPod®, try reconnecting it a few times or reboot the device. To reboot, follow the manufacturer's instructions provided with the iPod® or visit www.apple.com/ipod

▣ Auxiliary Input Jack*

To switch the mode, press any of the audio mode buttons. You can return to the AUX mode by pressing the **AUX** button.

You cannot use the auxiliary input jack if you replace the audio system.

Auxiliary Input Jack*

Use the jack to connect a standard audio device.



1. Open the AUX cover.
2. Connect a standard audio device to the input jack using a 1/8 inch (3.5 mm) stereo miniplug.
 - ▶ The audio system automatically switches to the AUX mode.

* Not available on all models

Audio Antenna

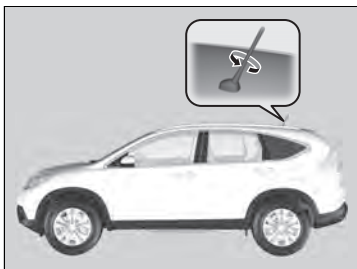

Your vehicle is equipped with a removable antenna at the rear of the roof.

▶▶ Audio Antenna

NOTICE

Before using a “drive-through” car wash, remove the antenna by unscrewing it by hand. This prevents the antenna from being damaged by the car wash brushes.

Audio System Theft Protection

The audio system is disabled when it is disconnected from the power source, such as when the battery is disconnected or goes dead.

■ Reactivating the audio system

1. Turn the ignition switch to ON **(II)**, and turn on the audio system.
 - ▶ If you turn the ignition switch to ACCESSORY **(I)**, you will be requested to enter the audio security code. See step 3.
2. Press and hold the power button again for more than two seconds.
 - ▶ The audio system is reactivated when the system’s control unit recognizes that the system is in your vehicle.
If the control unit fails to recognize, **ENTER CODE** appears on the multi-information display.
3. Enter the audio security code using the preset buttons. If you enter an incorrect digit, continue to the last digit, then try again. If you do not enter the code correctly after 10 tries, leave the system for one hour before trying again, or visit a dealer to have the system reset.

▶▶ Audio System Theft Protection

Find the audio system's security code and serial number label in your owner's manual kit.

We recommend that you write down the serial number in this owner's manual.

Do not store the label in your vehicle. If you lose the label, you must first retrieve the serial number, and then obtain the code.

You can find out about your serial number and security code from a dealer.

U.S. models

You can register the security code at Owner Link (owners.honda.com), and find information on how to retrieve the serial number and obtain the code at radio-navicode.honda.com.

To use the audio system, the ignition switch must be in ACCESSORY **I** or ON **II**.

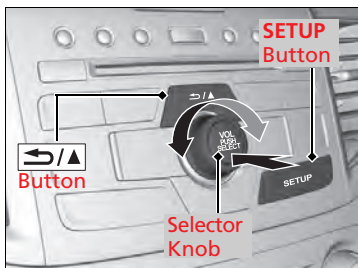

Use the selector knob or **SETUP** button to access some audio functions.

Press  to switch between the normal and extended display for some functions.

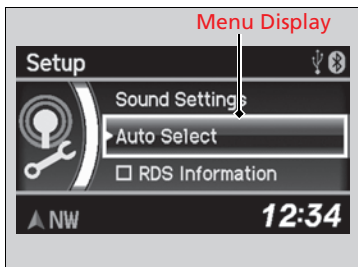

Selector knob: Rotate left or right to scroll through the available choices. Press  to set your selection.

SETUP button: Press to select any mode such as the **Auto Select**, **RDS Information**, **Sound Settings**, **Play Mode**, **Resume/Pause**, or **Adjust Clock**.

 **button:** Press to go back to the previous display.

Audio System Basic Operation

These indications are used to show how to operate the selector knob.

Rotate  to select.

Press  to enter.

Press the **SOURCE**, **+**, **-**, **◀** or **▶** button on the steering wheel to change any audio setting.

[▶ Audio Remote Controls P. 154](#)

Setup menu items

[▶ Auto Select P. 157](#)

[▶ RDS information P. 158](#)

[▶ Sound Settings P. 155](#)

[▶ Play Mode P. 163](#)

[▶ Resume/Pause P. 173](#)

[▶ Adjust Clock P. 96](#)

Audio Remote Controls

Allows you to operate the audio system while driving.

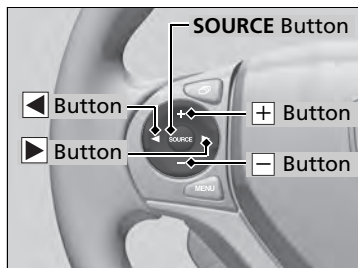

SOURCE Button

Cycles through the audio modes as follows:
FM1→FM2→AM→XM1*→XM2*→CD→AUX

+ - (Volume) Buttons

Press : To increase the volume.

Press : To decrease the volume.

◀ ▶ Buttons

- When listening to the radio
 - Press** : To select the next preset radio station.
 - Press** : To select the previous preset radio station.
- When listening to a CD, iPod®, USB flash drive, or *Bluetooth*® Audio
 - Press** : To skip to the next song.
 - Press** : To go back to the beginning of the current or previous song.
- When listening to Pandora®*
 - Press** : To skip to the next song.
 - Press and hold** : To select the previous station.
 - Press and hold** : To select the next station.

▶▶ Audio Remote Controls

The CD mode appears only when a CD is loaded.

When in the AUX mode, the following are operable from the remote controls:

- iPod®/USB flash drive connected to the USB adapter cable
- *Bluetooth*® Audio (with some phones only)

Adjusting the Sound

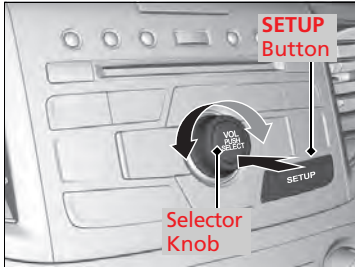

Press the **SETUP** button, and rotate to select **Sound Settings**, then press . Rotate to scroll through the following choices:

Adjusting the Sound

The SVC has four modes: **Off, Low, Mid, and High**. SVC adjusts the volume level based on the vehicle speed. As you go faster, audio volume increases. As you slow down, audio volume decreases.

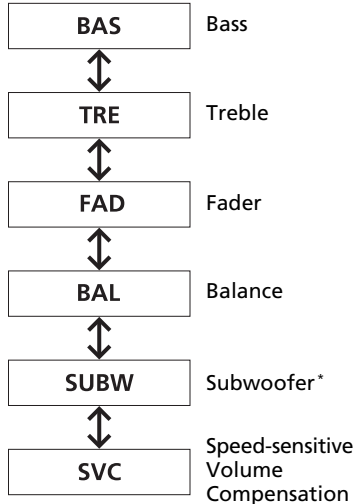
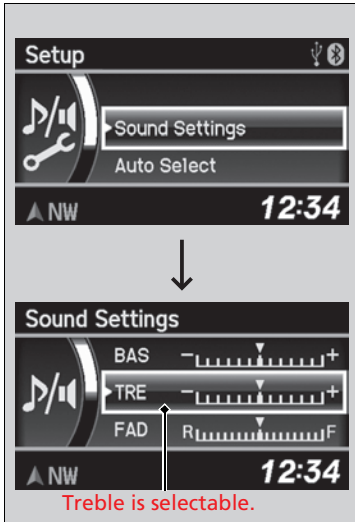

* Not available on all models

Playing AM/FM Radio

ORG

TOC

Features

Index

Home

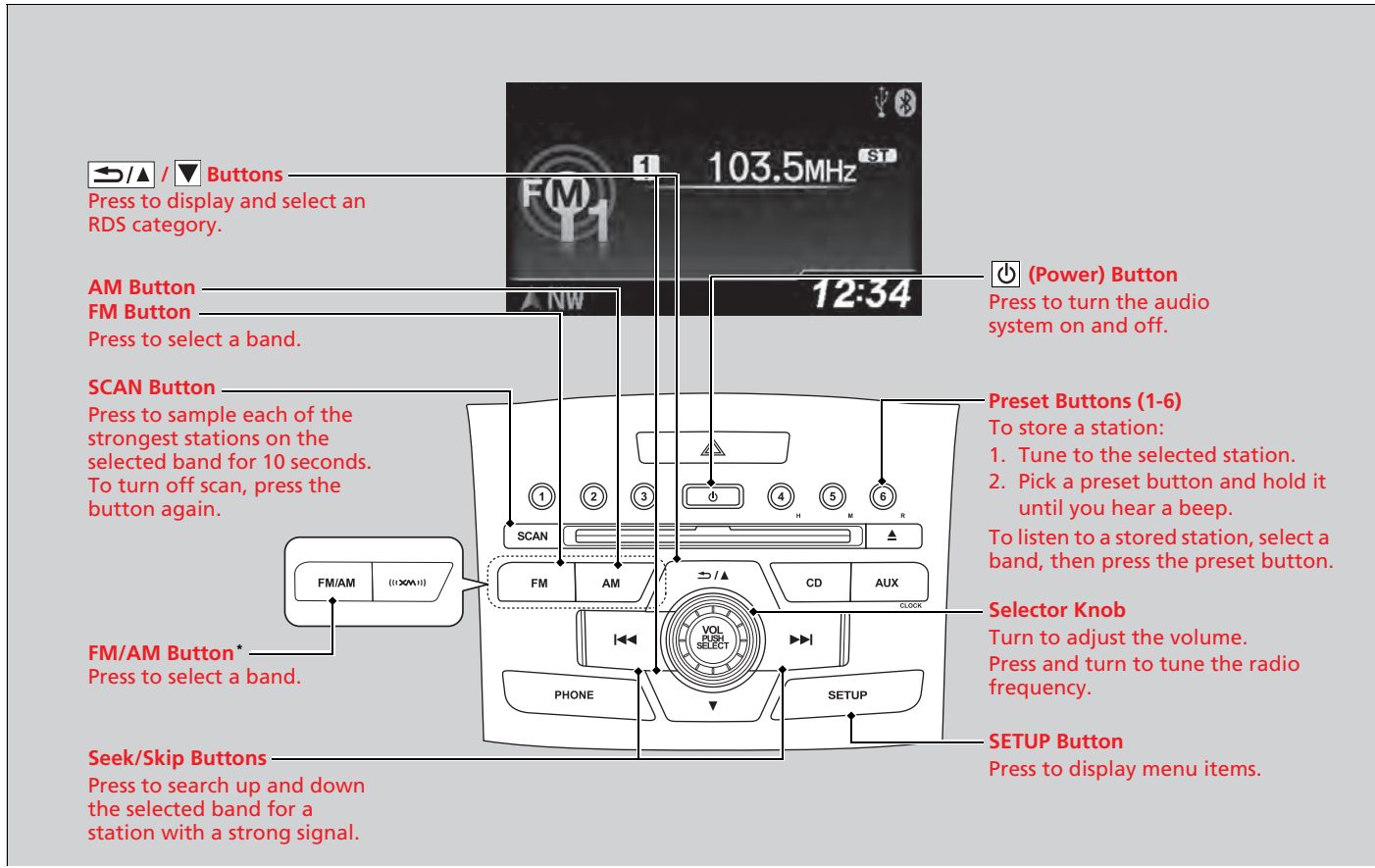

Buttons
Press to display and select an RDS category.

AM Button
FM Button
Press to select a band.

SCAN Button
Press to sample each of the strongest stations on the selected band for 10 seconds. To turn off scan, press the button again.

FM/AM Button*
Press to select a band.

Seek/Skip Buttons
Press to search up and down the selected band for a station with a strong signal.

(Power) Button
Press to turn the audio system on and off.

Preset Buttons (1-6)
To store a station:
1. Tune to the selected station.
2. Pick a preset button and hold it until you hear a beep.
To listen to a stored station, select a band, then press the preset button.

Selector Knob
Turn to adjust the volume. Press and turn to tune the radio frequency.



SETUP Button
Press to display menu items.

* Not available on all models

Auto Select

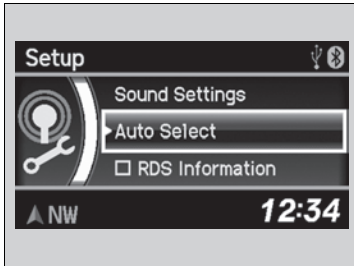
Use the auto select feature to scan both bands and store the strongest station in each preset.



1. Press the **SETUP** button.
2. Rotate  to select **Auto Select**, then press .

To turn off auto select, press  again. This restores the presets you originally set.

▶▶ Playing AM/FM Radio

The ST indicator appears on the display indicating stereo FM broadcasts.

Stereo reproduction in AM is not available.

To switch the audio mode, press the **SOURCE** button on the steering wheel.

[▶▶ Audio Remote Controls P. 154](#)

You can store 6 AM stations and 12 FM stations into the preset button memory. FM1 and FM2 let you store 6 stations each.

Auto Select function scans and stores up to 6 AM stations and 12 FM stations with a strong signal into the preset button memory.

If you do not like the stations auto select has stored, you can manually store your preferred frequencies.

Radio Data System (RDS)

Provides text data information related to your selected RDS-capable FM station.

RDS information

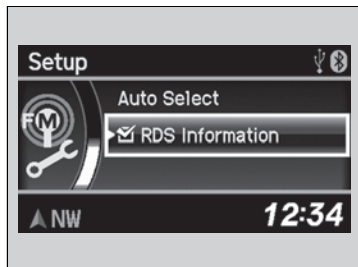

1. Press the **SETUP** button and rotate to select **RDS Information**.
2. Each time you press , the RDS Information switches between on and off.

To find an RDS station from your selected program category

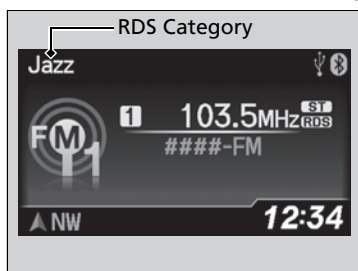



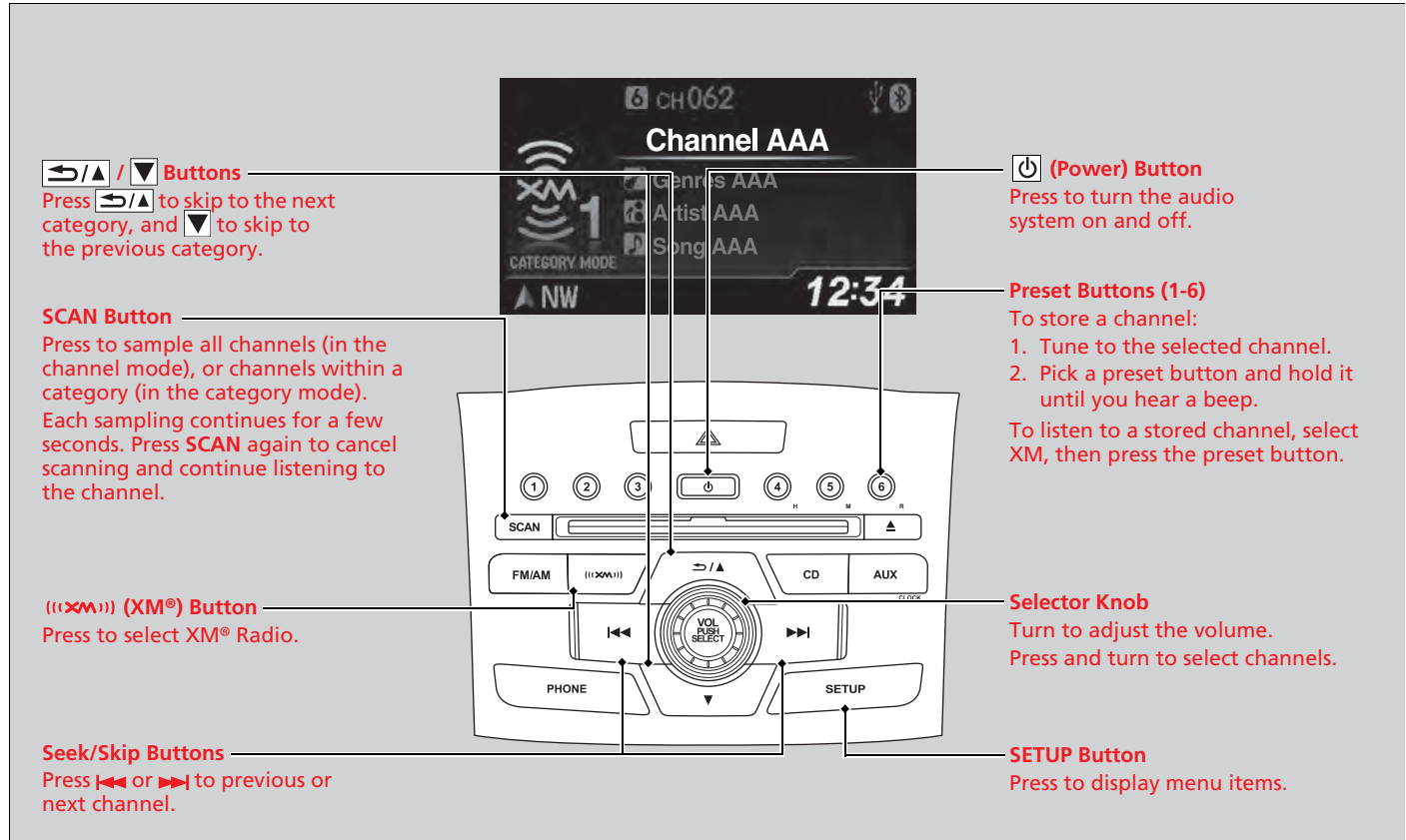

1. Press the / / button to display and select an RDS category.
2. Use Seek/Skip or **SCAN** to select an RDS station.

Playing XM® Radio*





■ To Play the XM® Radio

1. Press the ((XM)) button to select the XM® radio band (XM1 or XM2).
2. Press the **SETUP** button, rotate  to select **MODE/CATEGORY** or **MODE CHANNEL**. Each time you press , the mode switches between them. Press the ((XM)) button to enter the setting.
3. Select a channel using , or the Seek/Skip, , **SCAN**, or preset button.

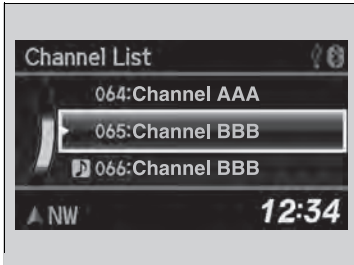
■ To Select a Channel from a List



1. Press  to display a channel list.
2. Rotate  to select a channel, then press .

▶▶ Playing XM® Radio*

In the channel mode, you can select all available channels. In the category mode, you can select a channel within a category (Jazz, Rock, Classical, etc.).

You can store 12 XM® stations in the preset buttons. XM1 and XM2 let you store 6 stations each.

There may be instances when XM® Radio does not broadcast all the data fields (artist name, title). This does not indicate a problem with your audio system.

Playing a CD

Your audio system supports audio CDs, CD-Rs and CD-RWs in either MP3 or WMA format. With the CD loaded, press the **CD** button.

SCAN Button

You will get a 10-second sampling of each song.

- Press to sample all tracks on the CD (all files in the current folder in MP3 or WMA).
- Press twice to sample the first file in each of the main folders (MP3 or WMA).
- To turn off scan, press and hold the button.

Buttons

Press **↔/▲** to skip to the next folder, and **▼** to skip to the beginning of the previous folder in MP3 or WMA.

Seek/Skip Buttons

Press **◀◀** or **▶▶** to change tracks (files in MP3 or WMA).

(Power) Button

Press to turn the audio system on and off.

CD Slot

Insert a CD about halfway into the CD slot.

CD Button

Press to play a CD.

(CD Eject) Button

Press to eject a CD.

Selector Knob

Turn to adjust the volume. Press and turn to select an item, then press to set your selection.

SETUP Button

Press to display menu items.

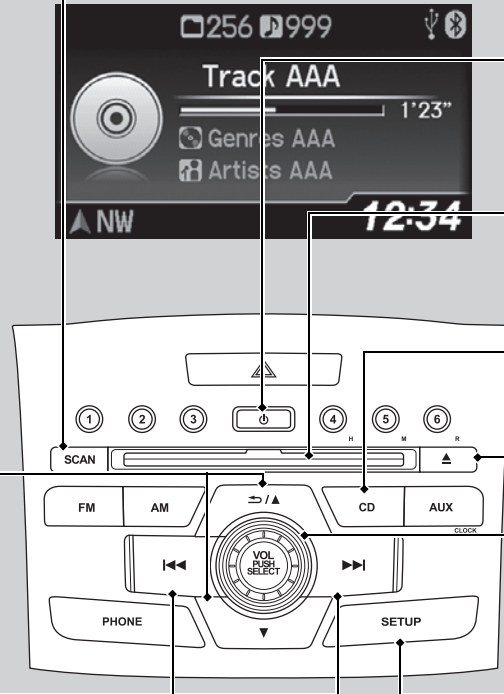

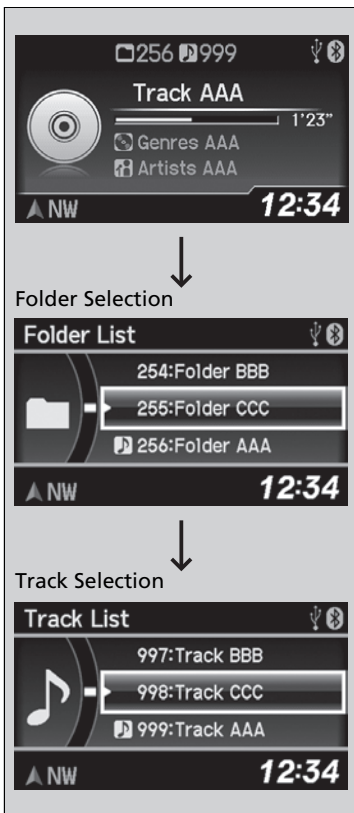

How to Select a File from a Folder with the Selector Knob (MP3/WMA)



1. Press  to switch the display to a folder list.

2. Rotate  to select a folder.

3. Press  to change the display to a list of files in that folder.

4. Rotate  to select a file, then press .

▶▶ Playing a CD

NOTICE

Do not use CDs with adhesive labels. The label can cause the CD to jam in the unit.

WMA files protected by digital rights management (DRM) cannot be played.

The audio system displays **Unsupported**, then skips to the next file.

Text data appears on the display under the following circumstances:

- When you select a new folder, file, or track.
- When you change the audio mode to CD.
- When you insert a CD.

If you eject the CD but do not remove it from the slot, the system reloads the CD automatically after several seconds.

How to Select a Play Mode

You can select repeat and random modes when playing a track or file.



1. Press the **SETUP** button.

2. Rotate to select **Play Mode**, then press .

3. Rotate to select a mode, then press .

■ To turn off a play mode

1. Press the **SETUP** button.

2. Rotate to select **Play Mode**, then press .

3. Rotate to select **Normal Play**, then press .

☒ How to Select a Play Mode

Play mode menu items

Normal Play

Repeat One Track: Repeats the current track/file(s).

Repeat One Folder (MP3/WMA): Repeats all files in the current folder.

Random in Folder (MP3/WMA): Plays all files in the current folder in random order.

Random All: Plays all tracks/files in random order.

Playing an iPod®

Connect the iPod® using your dock connector to the USB adapter cable, then press the **AUX** button.

▶ [USB Adapter Cable](#) P. 151

Album Art

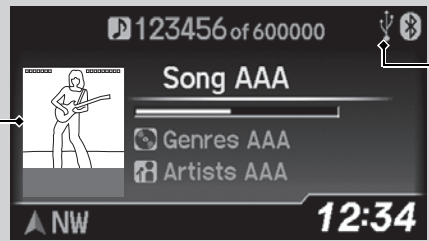

USB Indicator
Comes on when an iPod® is connected.

Buttons
Press / to go back to the previous display.
Press to set your selection.

(Power) Button
Press to turn the audio system on and off.

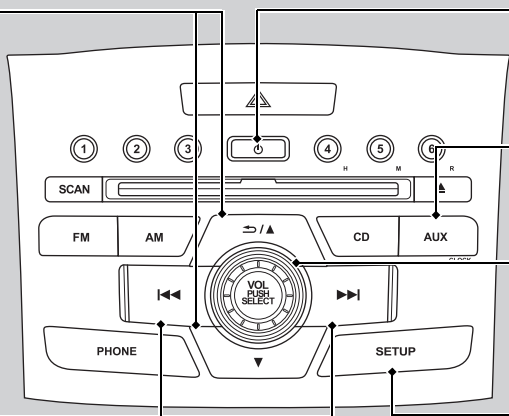

AUX Button
Press to select iPod® (if connected).

Selector Knob
Turn to adjust the volume.
Press and turn to select an item, then press to set your selection.

Seek/Skip Buttons
Press or to change songs.

SETUP Button
Press to display menu items.

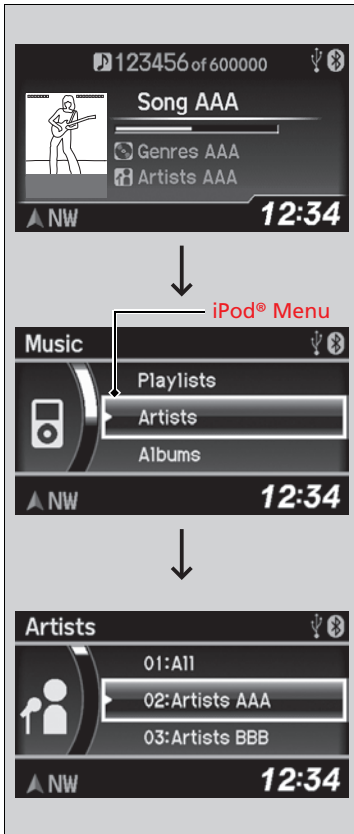

How to Select a File from the iPod® Menu



1. Press  to display the iPod® menu.

2. Rotate  to select a menu.

3. Press  to display the items on that menu.

4. Rotate  to select an item, then press .

▶▶ Playing an iPod®

Available operating functions vary on models or versions. Some functions may not be available on the vehicle's audio system.

If there is a problem, you may see an error message on the multi-information display.



[▶ iPod®/USB Flash Drive P. 187](#)

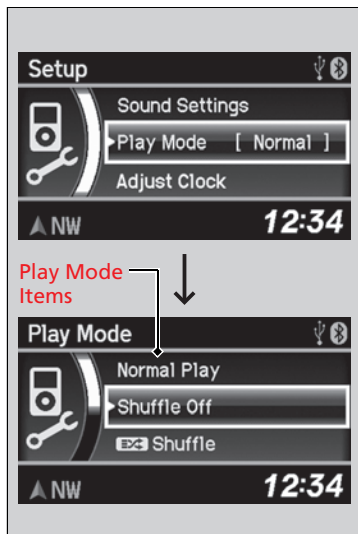

How to Select a Play Mode

You can select repeat and shuffle modes when playing a track.



1. Press the **SETUP** button.

2. Rotate  to select **Play Mode**, then press .

3. Rotate  to select a mode, then press .

To turn off a play mode

1. Press the **SETUP** button.

2. Rotate  to select **Play Mode**, then press .

3. Rotate  to select **Normal Play**, then press .

How to Select a Play Mode

Play mode menu items

Normal Play

Shuffle Off: Turns off the shuffle mode.

Shuffle: Plays all available tracks in a selected list (playlists, artists, albums, songs, genres, or composers) in random order.

Shuffle Albums: Plays all available albums in a selected list (playlists, artists, albums, songs, genres, or composers) in random order.

Repeat Off: Turns off the repeat mode.

Repeat One Track: Repeats the current track.

U.S. models

iPhone® use only

Playing Internet Radio

Activate Pandora®, and connect the iPhone® using your dock connector to the USB adapter cable, then press the **AUX** button.

▶ [USB Adapter Cable](#) P. 151

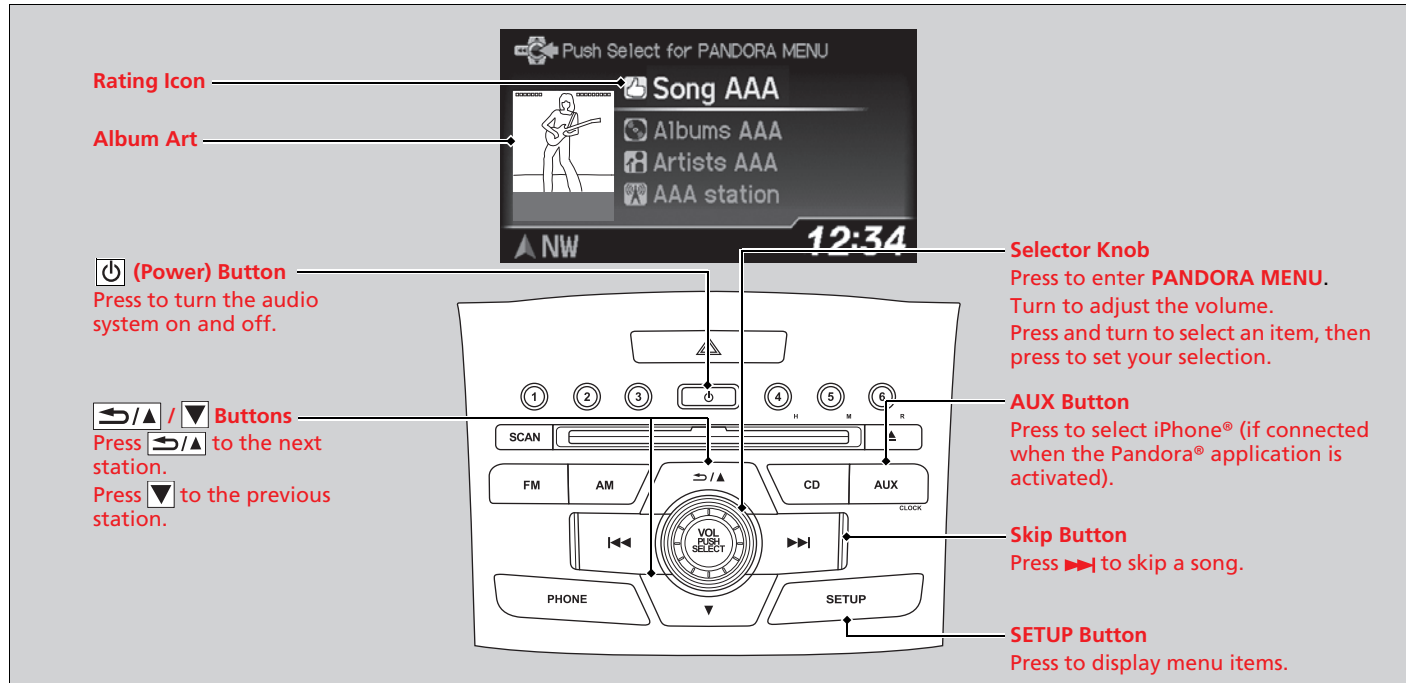





■ Pandora® Menu

You can operate some of the Pandora menu items from your vehicle's audio system. The available items are:

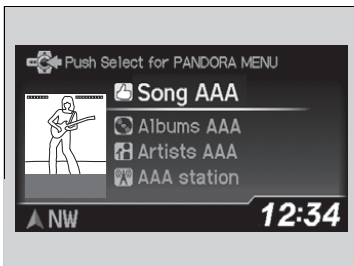
- **Station List** (**QuickMix** is also available)
- **Like**
- **Dislike**
- **Resume/Pause**
- **SKIP**
- **Bookmark this song**
- **Bookmark this artist**

■ Operating a menu item



1. Press  to display the **PANDORA MENU**
2. Rotate  to select a menu.
3. Press  to display the items on that menu.

▶▶ Playing Internet Radio

Pandora® is a personalized Internet radio service that selects music based on an artist, song, or genre a user enters, and streams what is likely to be of interest.

To use this service in your vehicle, the Pandora® app must first be installed on your iPhone®. Visit www.pandora.com for more information.

If you cannot operate Pandora® through the audio system, it may be streaming through *Bluetooth®* Audio. Make sure Pandora® mode on your audio system is selected.

▶▶ Pandora® Menu

Available operating functions vary on software versions. Some functions may not be available on the vehicle's audio system.

If there is a problem, you may see an error message on the multi-information display.

 [Pandora® P. 188](#)

There are restrictions on the number of songs you can skip or dislike in a given hour.

Playing a USB Flash Drive

Your audio system reads and plays sound files on a USB flash drive in either MP3, WMA or AAC**1 format.

Connect your USB flash drive to the USB adapter cable, then press the **AUX** button.

▶ [USB Adapter Cable](#) P. 151

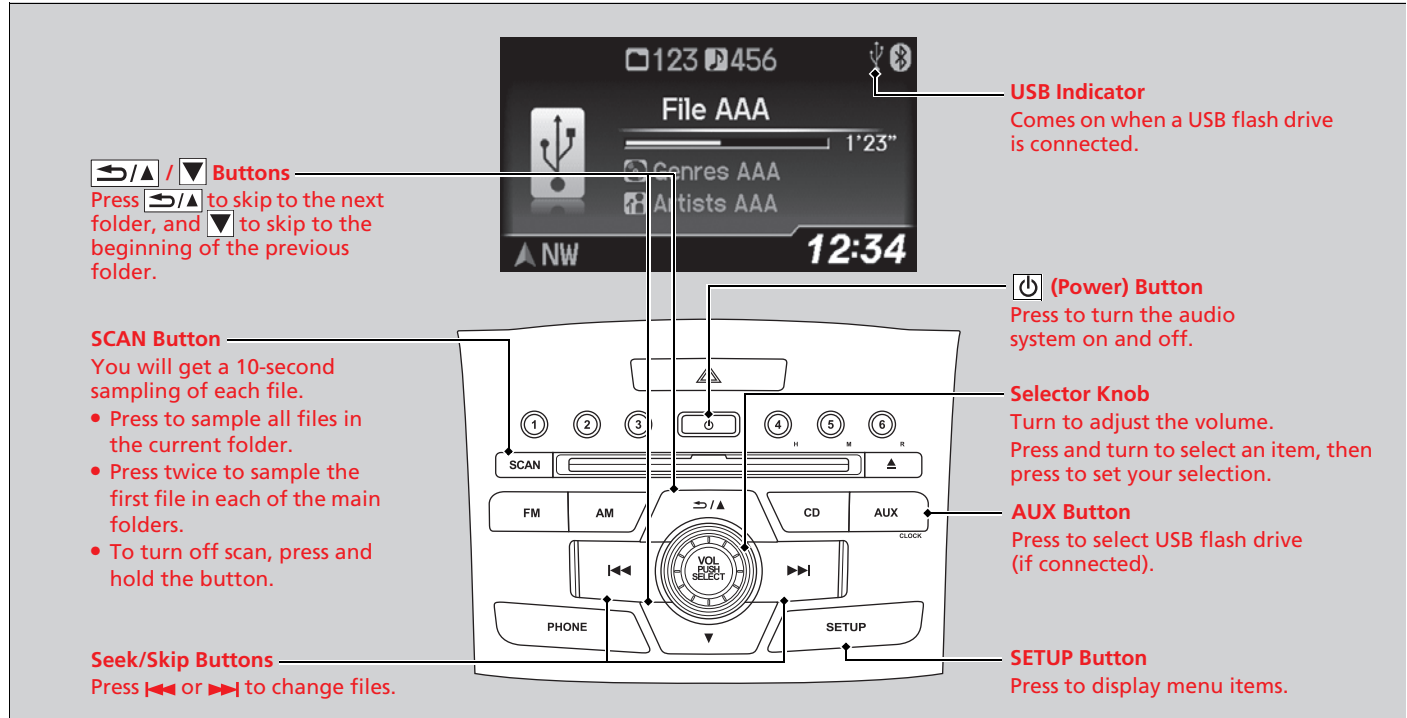

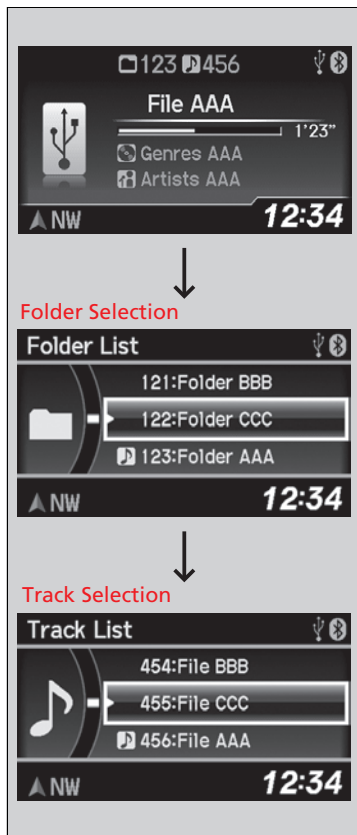

*1: Only AAC format files recorded with iTunes® are playable on this unit.

How to Select a File from a Folder with the Selector Knob



1. Press  to switch the display to a folder list.

2. Rotate  to select a folder.

3. Press  to change the display to a list of files in that folder.

4. Rotate  to select a file, then press .

▶▶ Playing a USB Flash Drive

Use the recommended USB flash drives.

 [General Information on the Audio System](#)
P. 190

Files in WMA format protected by digital rights management (DRM) are not played.

The audio system displays **Unplayable File**, and then skips to the next file.

If there is a problem, you may see an error message on the multi-information display.

 [iPod®/USB Flash Drive](#) P. 187

How to Select a Play Mode

You can select repeat and random modes when playing a file.



1. Press the **SETUP** button.

2. Rotate to select **Play Mode**, then press .

3. Rotate to select a mode, then press .

■ To turn off a play mode

1. Press the **SETUP** button.

2. Rotate to select **Play Mode**, then press .

3. Rotate to select **Normal Play**, then press .

☒ How to Select a Play Mode

Play mode menu items

Normal Play

Repeat One Track: Repeats the current file.

Repeat One Folder: Repeats all files in the current folder.

Random in Folder: Plays all files in the current folder in random order.

Random All: Plays all files in random order.

Playing *Bluetooth*® Audio

Your audio system allows you to listen to music from your *Bluetooth*®-compatible phone.

This function is available when the phone is paired and linked to the vehicle's *Bluetooth*® HandsFreeLink® (HFL) system.

➤ **Phone Setup** P. 201

▶▶ Playing *Bluetooth*® Audio

Not all *Bluetooth*-enabled phones with streaming audio capabilities are compatible with the system. For a list of compatible phones:

- **U.S.:** Visit www.acura.com/handsfreelink, or call 1-888-528-7876.
- **Canada:** Visit www.handsfreelink.ca, or call 1-888-528-7876.

In some states, it may be illegal to perform some data device functions while driving.

If more than one phone is paired to the HFL system, there will be a delay before the system begins to play.

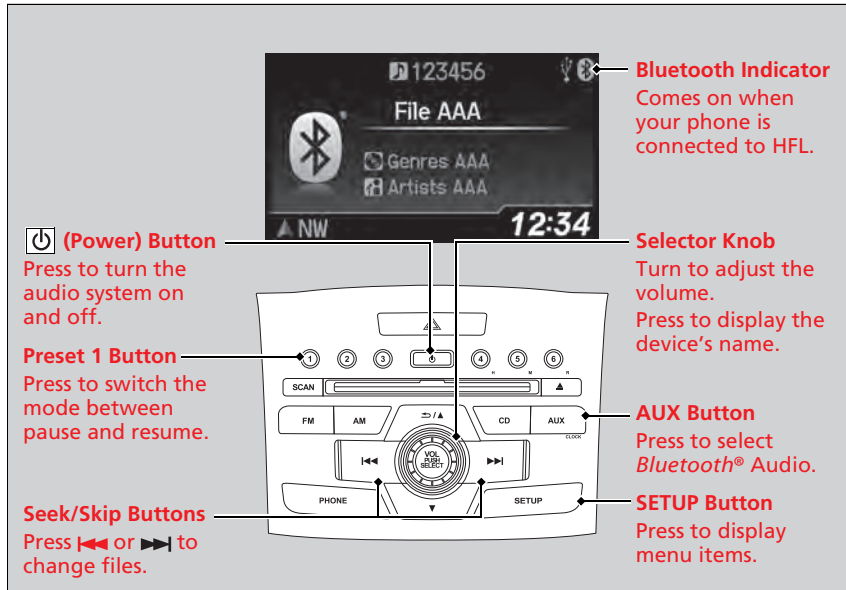

To Play *Bluetooth*® Audio Files

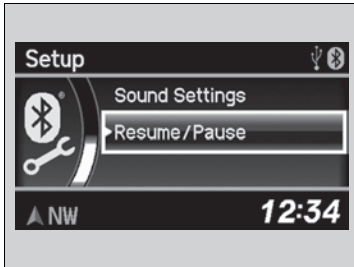

1. Make sure that your phone is paired and connected to HFL.
2. Press the **AUX** button.

If the phone is not recognized, another HFL-compatible phone, which is not compatible for *Bluetooth*® Audio, may already be connected.

▶▶ To Play *Bluetooth*® Audio Files



To play the audio files, you may need to operate your phone. If so, follow the phone maker's operating instructions.

The pause function may not be available on some phones.

If any audio device is connected to the auxiliary input jack, you may need to press the **AUX** button repeatedly to select the *Bluetooth*® Audio system.

Switching to another mode pauses the music playing from your phone.

■ To pause or resume a file

1. Press the **SETUP** button.
2. Rotate  to select **Resume/Pause**, then press .

Each time you press , the setting switches between pause and resume.

Switching to HFL

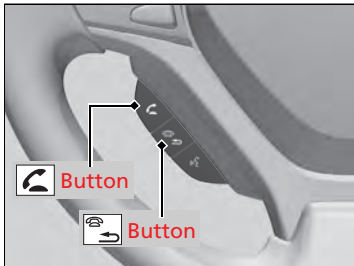

Press the  (pick-up) button on the steering wheel to receive a call when *Bluetooth*® Audio is playing.

 [Bluetooth® HandsFreeLink® P. 194](#)

Press the  (hang-up/back) button to end the call and return to *Bluetooth*® Audio.

▶▶ Switching to HFL

If you receive a call while *Bluetooth*® Audio is in the pause mode, it resumes play after ending the call.

Optional for U.S.

Allows the rear seat passengers to enjoy a different entertainment source, such as a DVD or CD, than the front passengers.

Wireless Headphones

The rear seat passenger can listen to audio from the rear entertainment system with a set of wireless headphones that comes with your vehicle.

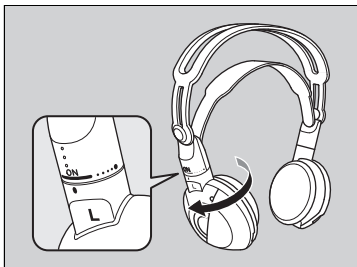

To turn on the headphones: Pivot the left earpiece outward.

To adjust the volume: Turn the dial at the bottom of the right earpiece.

If you want to listen to audio from the rear entertainment system on the speakers, press the **AUX** button until AUX mode is displayed.

Rear Entertainment System*

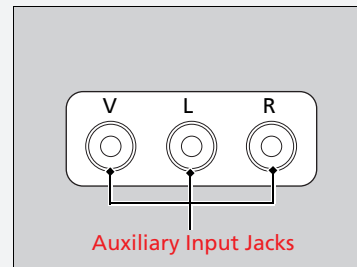

The system also allows for auxiliary inputs from standard video game consoles. The jacks are in the console compartment.

V = Video jack

L = Left audio jack

R = Right audio jack

Wireless Headphones

Wear the headphones correctly with the **L** earpiece on your left ear and the **R** earpiece on your right ear. Wearing the headphones backward may affect the audio reception.

Overhead Screen

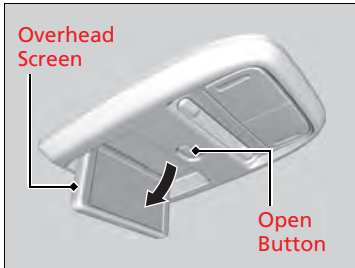

Pull down the screen to the first or second detent until it latches.

Operating the System

To operate the system, turn the ignition switch to ACCESSORY **I** or ON **II**. Press the **REAR POWER** button to turn on the system (indicator on).

Overhead Screen

NOTICE

This vehicle's overhead mounted video display, if so equipped, includes mercury-containing components. Upon removal, please reuse, recycle, or dispose of as hazardous waste.

Control Panel in the Console Compartment

Play/Pause Button

Press to pause the CD/DVD.
Press again to resume.

REAR POWER Button

Press to turn the rear entertainment system on and off.

(CD/DVD Eject) Button

Press to eject a CD/DVD.

CD/DVD Slot

REAR CTRL OFF Button

Press to cancel the operation from the rear seat.

SOURCE Button

Press to change the source DVD or AUX. The indicator comes on for the selected source.

AUX VIDEO Jack

You can connect other audio or videos.

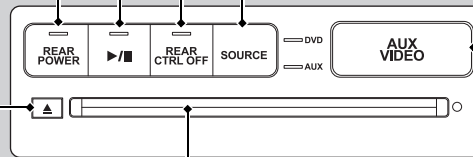

System Controls and Menus for DVD

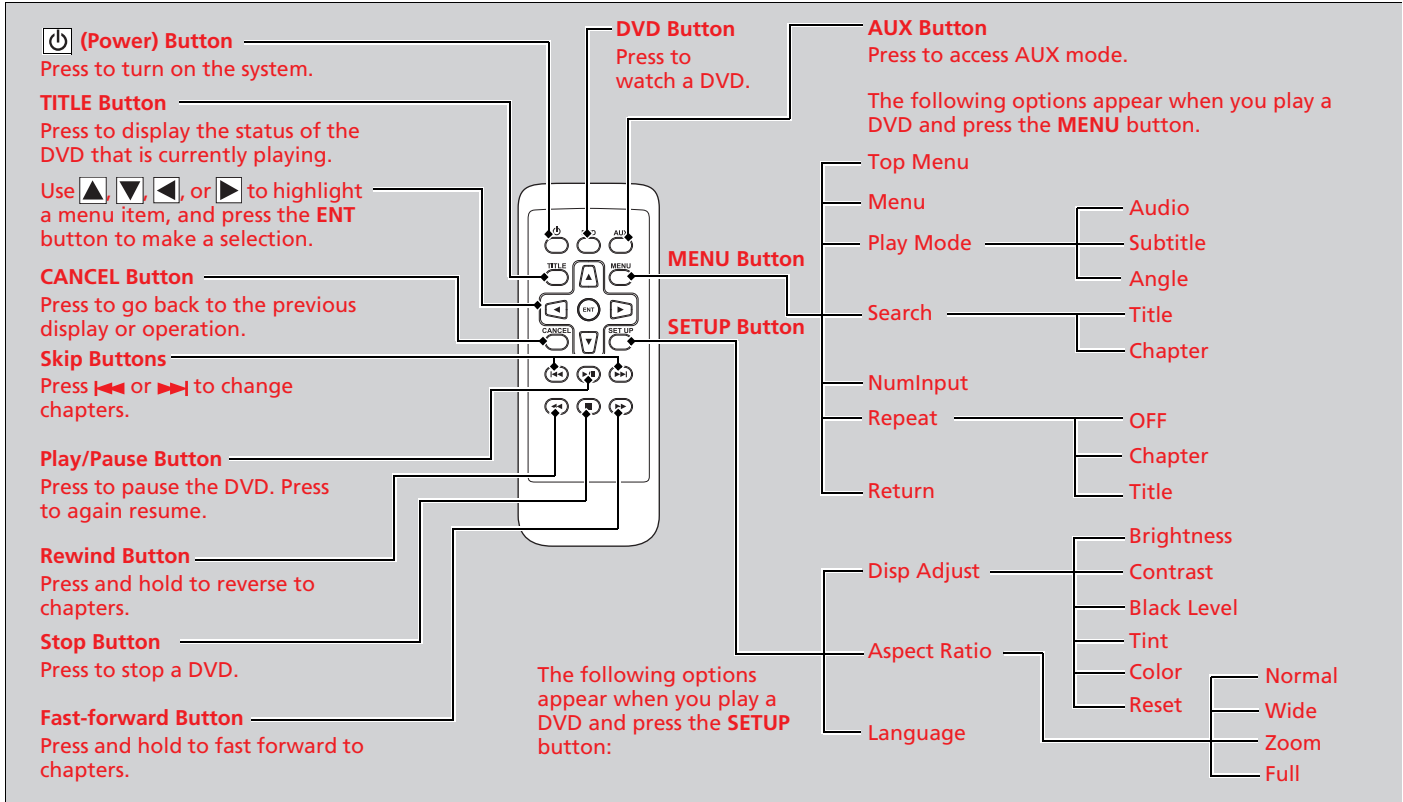

■ Playing a DVD

- Insert a DVD into the slot in the console compartment.
 - ▶ The system automatically starts the DVD.
- To fast forward, press and hold the fast-forward button. To rewind, press and hold the rewind button on the remote.
- To go to the next chapter, press the ▶▶ (skip) button. To go to the beginning of the current chapter, press the ◀◀ button on the remote. Quickly press the ◀◀ button twice to go to the previous chapter.

■ TITLE button on the remote

Press the **TITLE** button while the DVD is playing to see the current status of the title, chapter, elapsed time, angle, subtitle, audio, and sound characteristics.

■ MENU button on the remote



Press the **MENU** button while the DVD is playing to see the available options. Use the ◀ and ▶ buttons to highlight the option and then press the **ENT** button.

▶▶ Playing a DVD

DVD is available for the rear seat passengers only.

▶▶ TITLE button on the remote

Press the **TITLE** button again to return.

Top Menu:

The top page of the DVD's title menu appears. The title menu also appears when you press the **MENU** button while the DVD is in the slot not playing. Press the **CANCEL** or **MENU** button to return.

Menu:

The DVD's title menu appears.

Play Mode:

You can change the following three settings:

Audio - Select a language for audio that is available on the DVD. The sound characteristics (Dolby Digital, LPCM, MPEG Audio, etc) of that audio is also displayed.

Subtitle - Select a subtitle that is available on the DVD.

Angle - Select a view angle that is available on the DVD. If the DVD currently playing does not carry multiple angles, only one option **Angle 1** comes on. Press the **CANCEL** or **MENU** button to return.

Search:





You can search for a DVD segment from the following methods.

Title Search - Find the title you want to play.

Chapter Search - Find the chapter you want to play.

NumInput:

Enter a two-digit number, if issued to the DVD, to find the segment you want to start to play.

1. Select **NumInput** to go to the number input screen.
2. Use the , , , and  buttons to input numbers.
▶ If you want to delete a number, select **DEL**.
3. The cursor automatically goes to **ENT** after you input two digits. Press the **ENT** button to enter.

Repeat:

Highlight this option and press the **ENT** button to change the repeat mode from chapter repeat and title repeat, to repeat off.

■ SETUP button on the remote

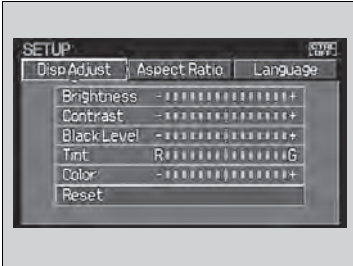

Press the **SETUP** button while the DVD is playing to see the available options. Use the ◀ and ▶ buttons to highlight the option and then press **ENT**.

☒ SETUP button on the remote

Not all DVD formats allow for all the available setting adjustments.

Disp Adjust:

You can adjust the overhead screen's **Brightness**, **Contrast**, **Black Level**, **Color**, and **Tint**. To return to the default display setting, select **Reset**.

After you make all the adjustments, the screen goes back to the top **SETUP** screen, or press the **CANCEL** button to return.

Aspect Ratio:

You can select the screen mode with a different aspect ratio from **Normal**, **Wide**, **Zoom**, and **Full**. After you select the mode, it takes about one second to return to the play mode with the selected ratio.

Language:

You can select the display language from **English**, **French**, and **Spanish**.

When the DVD is not playing**Initial Settings -**

Press the **SETUP** button to configure the initial Language, Dynamic Range, and Angle Mark settings before playing a DVD.

Language Settings:

Select the language for the DVD's displayed menus (Menu Language), the DVD's audio (Audio Language), and the DVD's subtitle (Subtitle Language).

1. Select the language setting.
2. Select the language from **English, French, Spanish, Arabic, German, Italian, Dutch, Chinese, Korean, Thai, Japanese,** and **other**.
3. If you select **other**, you need to enter the four digit language code to configure the language that is not listed. Select Yes to go to the number input screen.
 - ▶ To return to the Language Settings screen, select No.
4. Press the **ENT** button each time you input a digit.
 - ▶ If you want to delete a number, select **DEL**.
5. The cursor automatically goes to **ENT** after you input four digits. Press the **ENT** button to command.

Dynamic Range:

This feature reduces the difference between the loud and quiet sound levels. Select **ON** or **OFF**.

Angle Mark:

You can select whether to display the angle mark appearing in the upper right corner of the screen when you change the view angle while the DVD is playing. Select **ON** or **OFF**.

▶▶ SETUP button on the remote

Initial Settings:

The prior language varies by disc. You may not be able to configure your selected language setting.

System Controls and Menus for CD

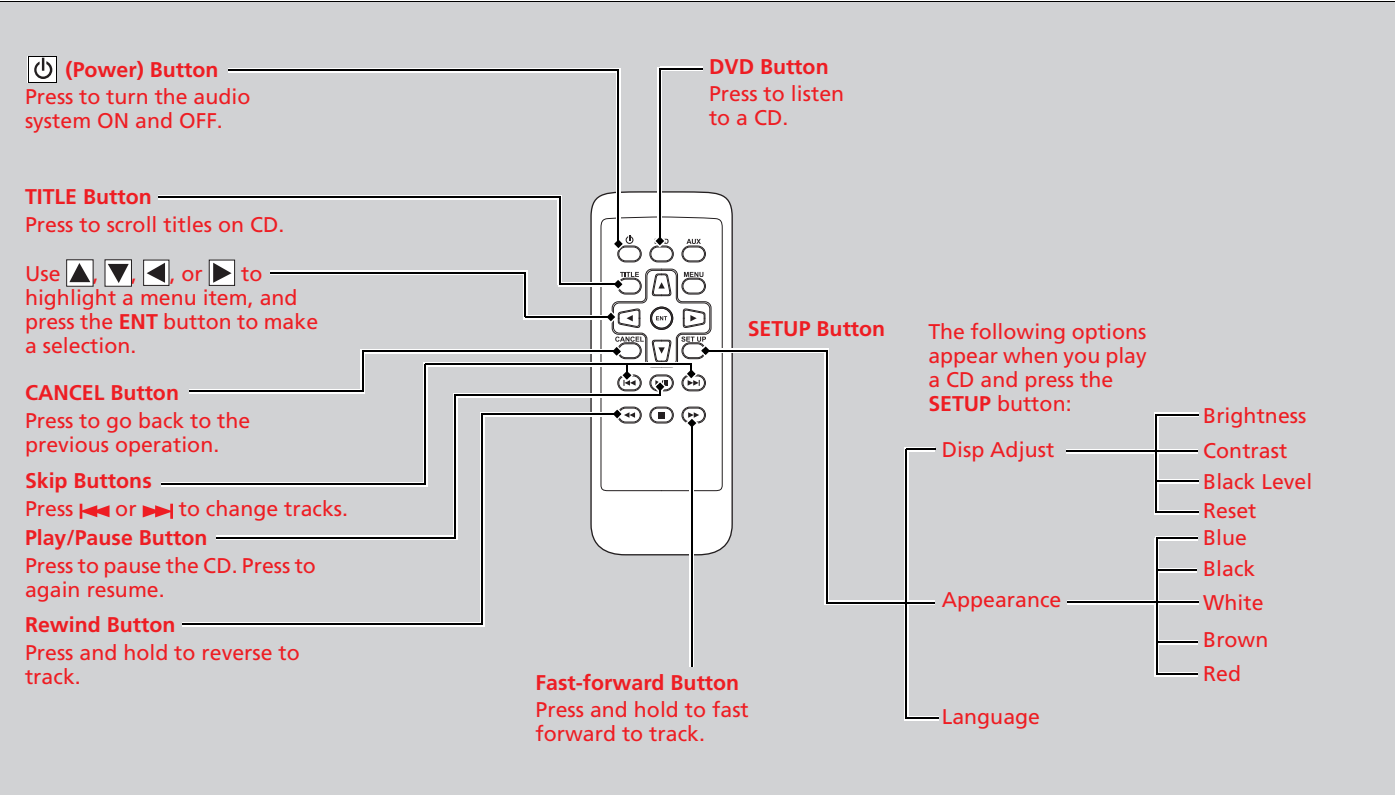

■ Playing a CD

Press the **DVD** button.

The available options that appear on the overhead screen are Repeat, Random, and Scan. The fast-forward, rewind, ◀, and ▶ buttons work similarly to operation a DVD.

▶ [Playing a DVD P. 178](#)

To scroll the audio data title, press the **TITLE** button for five seconds.

■ SETUP button on the remote

Press the **SETUP** button while the CD is playing to see the available options. Use the ◀ and ▶ buttons to highlight the option, then press **ENT**.

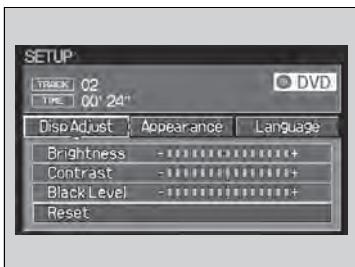

Disp Adjust:

You can adjust the overhead screen's **Brightness**, **Contrast**, and **Black Level**. To return to the default display setting, select **Reset**.

After you make adjustments, the screen goes back to the top **SETUP** screen, or press the **CANCEL** button to return.

Appearance:

You can select the screen color from blue, black, white, brown, and red.

Language:

You can select the display language from **English**, **French**, and **Spanish**.

▶▶ System Controls and Menus for CD

You can insert an audio CD compatible with the system, or recorded in MP3/WMA/AAC formats into the slot and play.

▶ [Playable Discs P. 185](#)

Playable Discs



The discs that come with these labels can be played in your vehicle's rear entertainment system.

Also look for the region code of 1 or ALL on the package or jacket on the disc.

DVD-ROMs are not playable in this unit. However, the audio data, such as MP3, WMA and AAC music files, on a DVD-ROMs can be played.

▶▶ Playable Discs



This product incorporates copyright protection technology that is protected by U.S. patents and other intellectual property rights.

Use of this copyright protection technology must be authorized by Macrovision, and is intended for home and other limited viewing uses only unless otherwise authorized by Macrovision.

Manufactured under license from Dolby Laboratories. Dolby and the double-D symbol are trademarks of Dolby Laboratories.

CD Player

If a disc error occurs, you may see the following error messages.

Error Message	Cause	Solution
HEAT ERROR	High temperature	<ul style="list-style-type: none"> • Turn the audio system off and allow the player to cool down until the error message is cleared.
UNPLAYABLE/Unsupported	Track/file format not supported	<ul style="list-style-type: none"> • Current track/file will be skipped. The next supported track/file plays automatically.
BAD DISC PLEASE CHECK OWNERS MANUAL PUSH EJECT	Mechanical error	<ul style="list-style-type: none"> • Press the  (eject) button and remove the disc, and check that the error message is cleared. • Check that the disc is not damaged or deformed, and insert the disc again. <p>▶ Protecting CDs P. 192</p>
MECH ERROR		<ul style="list-style-type: none"> • If the error message reappears, press the  button, and pull out the disc. • Insert a different disc. <p>If the new disc plays, there is a problem with the first disc.</p> <ul style="list-style-type: none"> • If the error message repeats, or the disc cannot be removed, contact a dealer. <p>Do not try to force the disc out of the player.</p>
BAD DISC PLEASE CHECK OWNERS MANUAL	Servo error	<ul style="list-style-type: none"> • If the error message repeats, or the disc cannot be removed, contact a dealer. <p>Do not try to force the disc out of the player.</p>
CHECK DISC	Disc error	<ul style="list-style-type: none"> • Check that the disc is not damaged or deformed. <p>▶ Protecting CDs P. 192</p>

iPod®/USB Flash Drive

If an error occurs while playing an iPod® or USB flash drive, you may see the following error messages.

If you cannot clear the error message, contact a dealer.

Error Message	Solution
USB Error	Appears when there is a problem with the USB adapter unit. Check if the device is compatible with the USB adapter unit.
Bad USB Device Please Check Owners Manual.	Appears when an incompatible device is connected. Disconnect the device. Then turn the audio system off, and turn it on again. Do not reconnect the device that caused the error.
No Song	Appears when the iPod® is empty. Check that compatible files are stored on the device.
Unsupported Ver	Appears when an unsupported iPod® is connected. If it appears when a supported iPod® is connected, update the iPod® software to the newer version.
Retry Connection	Appears when the system does not acknowledge the iPod®. Reconnect the iPod®.
Unplayable File	Appears when the files in the USB flash drive are DRM or an unsupported format. This error message appears for about 3 seconds, then plays the next song.
No Data	Appears when the USB flash drive is empty or there are no MP3, WMA, or AAC files in the USB flash drive. Check that compatible files are stored on the device.
Unsupported	Appears when an unsupported device is connected. If it appears when a supported device is connected, reconnect the device.

U.S. models

Pandora®

If an error occurs while playing Pandora®, you may see the following error messages.

If you cannot clear the error message, contact a dealer.

Error Message	Solution
PANDORA No Station	Appears when there is no station list on the device. Use the device to create a station.
PANDORA Unsupported Ver.	Appears when Pandora version is not supported. Please update the device application.
PANDORA No Service	Appears when Pandora is performing system maintenance. Try again later.
PANDORA Check Device	Appears when Pandora is unable to play music. Check your device.
Pandora Loading	Appears when Pandora is loading.

Models with rear entertainment system

QRG

DVD Player Error Messages

Error Message	Cause	Solution
Disc Error	FOCUS Error	Press the disc eject button, and remove the disc. Check for an error indication. Insert the disc again. If the code does not disappear or the disc cannot be removed, consult a dealer.
MECH Error	Mechanical Error	
Region Error	Invalid region code	The disc is not playable in this unit. Eject the disc, and insert a disc compatible with this system.
Heat Error	High temperature	Turn the system off and allow the player to cool down until the error message is cleared.
Format Error	Track/file format not supported	Current track/file will be skipped. The next supported track/file plays automatically.

TOC

Features

Index

Home

XM® Radio Service *

■ Subscribing to XM® Radio

1. You need your radio ID ready before registering for subscription. To see the ID in the display: Turn the selector knob until **0** appears.
2. Have your radio ID and credit card number ready, and either call or visit the XM® website to subscribe.

■ Receiving XM® Radio

Press the ((XM)) (XM®) button and stay in this mode for about 30 minutes until the service is activated. Make sure your vehicle is in an open area with good reception.

■ XM® Radio Display Messages

LOADING:

XM® is loading the audio or program information.

OFF AIR:

The channel is not currently broadcasting.

UPDATING:

The encryption code is being updated. Channels 0 and 1 still work normally.

NO SIGNAL:

The signal is too weak in the current location.

-----:

No such channel exists, the channel is not part of your subscription, or the artist or title information is unavailable.

ANTENNA:

There is a problem with the XM® antenna. Contact a dealer.

☒ Subscribing to XM® Radio

Contact Information for XM® Radio:

US: XM® Radio at www.siriusxm.com or 1-800-852-9696

Canada: XM® Canada at www.xmradio.ca, or 1-877-209-0079

☒ Receiving XM® Radio

The XM® satellites are in orbit over the equator; therefore, objects south of the vehicle may cause satellite reception interruptions. Satellite signals are more likely to be blocked by tall buildings and mountains the farther north you travel from the equator.

You may experience reception problems under the following circumstances:

- In a location with an obstruction to the south of your vehicle.
- In tunnels
- On the lower level of a multi-tiered road
- Large items carried on the roof rack

Recommended CDs

- Use only high-quality CD-R or CD-RW discs labeled for audio use.
- Use only CD-R or CD-RW discs on which the recordings are closed.
- Play only standard round-shaped CDs.

The CD packages or jackets should have one of these marks.



CDs with MP3 or WMA files

- Some software files may not allow for audio play or text data display.
- Some versions of MP3 or WMA formats may be unsupported.

Recommended CDs

A Dual-disc cannot play on this audio unit. If recorded under certain conditions, a CD-R or CD-RW may not play either.

■ Protecting CDs

Follow these precautions when handling or storing CDs:

- Store a CD in its case when it is not being played.
- When wiping a CD, use a soft clean cloth from the center to the outside edge.
- Handle a CD by its edge. Never touch either surface.
- Never insert foreign objects into the CD player.
- Keep CDs out of direct sunlight and extreme heat.
- Do not place stabilizer rings or labels on the CD.
- Avoid fingerprints, liquids, and felt-tip pens on the CD.

▶▶ Protecting CDs

NOTICE

Do not insert a damaged CD. It may be stuck inside and damage the audio unit.

Examples:

- **Bubbled, wrinkled, labeled, and excessively thick CDs**



Bubbled/
Wrinkled

With Label/
Sticker

Using
Printer Label
Kit



Sealed

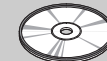

With Plastic Ring

- **Damaged CDs**
- **Poor quality CDs**



Chipped/
Cracked

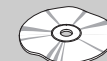

Warped



Burrs

- **Small CDs**



3-inch
(8-cm)
CD

Compatible iPod®, iPhone® and USB Flash Drives

iPod® and iPhone® Model Compatibility

Model
iPod (5th generation)
iPod classic 80/160 GB (launched in 2007)
iPod classic 120 GB (launched in 2008)
iPod classic 160 GB (launched in 2009)
iPod nano (launched in 2011)
iPod touch (launched in 2011)
iPhone 3G/iPhone 3GS/iPhone 4/iPhone 4S

USB Flash Drives

- Use a recommended USB flash drive of 256 MB or higher.
- Some digital audio players may not be compatible.
- Some USB flash drives (e.g., a device with security lockout) may not work.
- Some software files may not allow for audio play or text data display.
- Some versions of MP3, WMA, or AAC formats may be unsupported.

▶▶ iPod® and iPhone® Model Compatibility

This system may not work with all software versions of these devices.

▶▶ USB Flash Drives

Files on the USB flash drive are played in their stored order. This order may be different from the order displayed on your PC or device.

Models with navigation system

For models with the navigation system, see the Navigation System Manual for how to operate the *Bluetooth*® HandsFreeLink®.

Models without navigation system

Bluetooth® HandsFreeLink® (HFL) allows you to place and receive phone calls using your vehicle's audio system, without handling your cell phone.

Using HFL

HFL Buttons

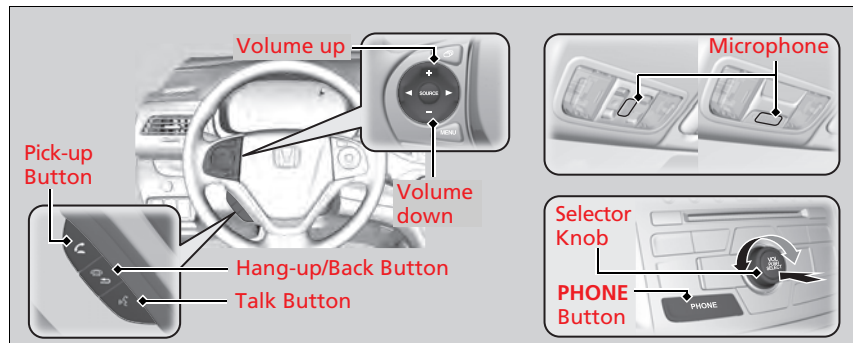

(Pick-up) button: Press to go directly to the **Phone** screen or to answer an incoming call.

(Hang-up/back) button: Press to end a call or to cancel a command.

(Talk) button: Press to call a number with a stored voice tag.

PHONE button: Press to go directly to the **Phone** screen.

Selector knob: Rotate to select an item on the screen, then press .

Bluetooth® HandsFreeLink®

To use HFL, you need a *Bluetooth*-compatible cell phone. For a list of compatible phones, pairing procedures, and special feature capabilities:

- **U.S.:** Visit www.handsfreelink.honda.com, or call 1-888-528-7876.
- **Canada:** Visit www.handsfreelink.ca, or call 1-888-528-7876.

Voice control tips

- Aim the vents away from the ceiling and close the windows, as noise coming from them may interfere with the microphone.
- Press and release the button when you want to call a number using a stored voice tag. Speak clearly and naturally after a beep.
- If the microphone picks up voices other than yours, the command may be misinterpreted.
- To change the volume level, use the audio system's volume knob or the remote audio controls on the steering wheel.

State or local laws may prohibit the operation of handheld electronic devices while operating a vehicle.

HFL Status Display

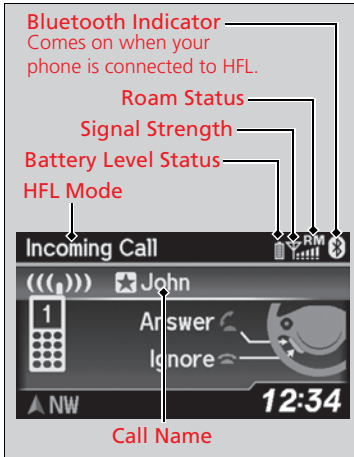

The multi-information display notifies you when there is an incoming call.

Bluetooth® HandsFreeLink®

Bluetooth® Wireless Technology

The *Bluetooth*® word mark and logos are registered trademarks owned by *Bluetooth* SIG, Inc., and any use of such marks by Honda Motors Co., Ltd., is under license. Other trademarks and trade names are those of their respective owners.

HFL Limitations

An incoming call on HFL will interrupt the audio system when it is playing. It will resume when the call is ended.

HFL Status Display

The information that appears on the multi-information display varies between phone models.

You can change the system language to English, French, or Spanish.

➤ [Customized Features P. 84](#)

Limitations for Manual Operation

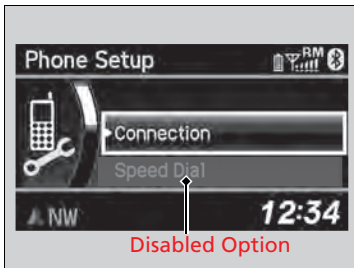

Certain manual functions are disabled or inoperable while the vehicle is in motion. You cannot select a grayed-out option until the vehicle is stopped.

Only previously stored speed dial entries can be called using voice commands while the vehicle is in motion.

➤ [Speed Dial P. 211](#)

HFL Menus

The ignition switch must be in ACCESSORY **I** or ON **II** to use HFL.

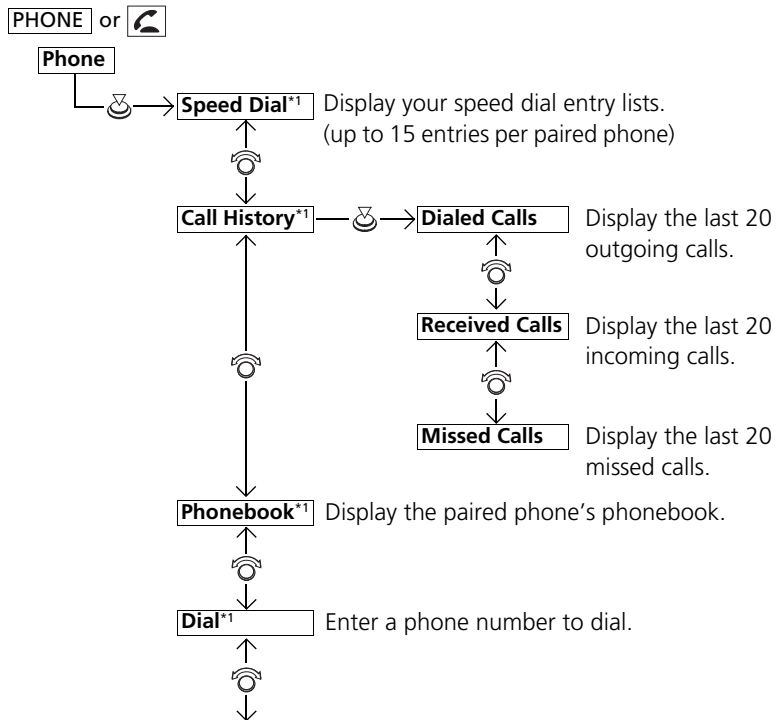

HFL Menus

To use HFL, you must first pair your *Bluetooth*-compatible cell phone to the system while the vehicle is parked.

Some functions are limited while driving. A message appears on the screen when the vehicle is moving and the operation is canceled.

*1: Appears only when a phone is connected to HFL.

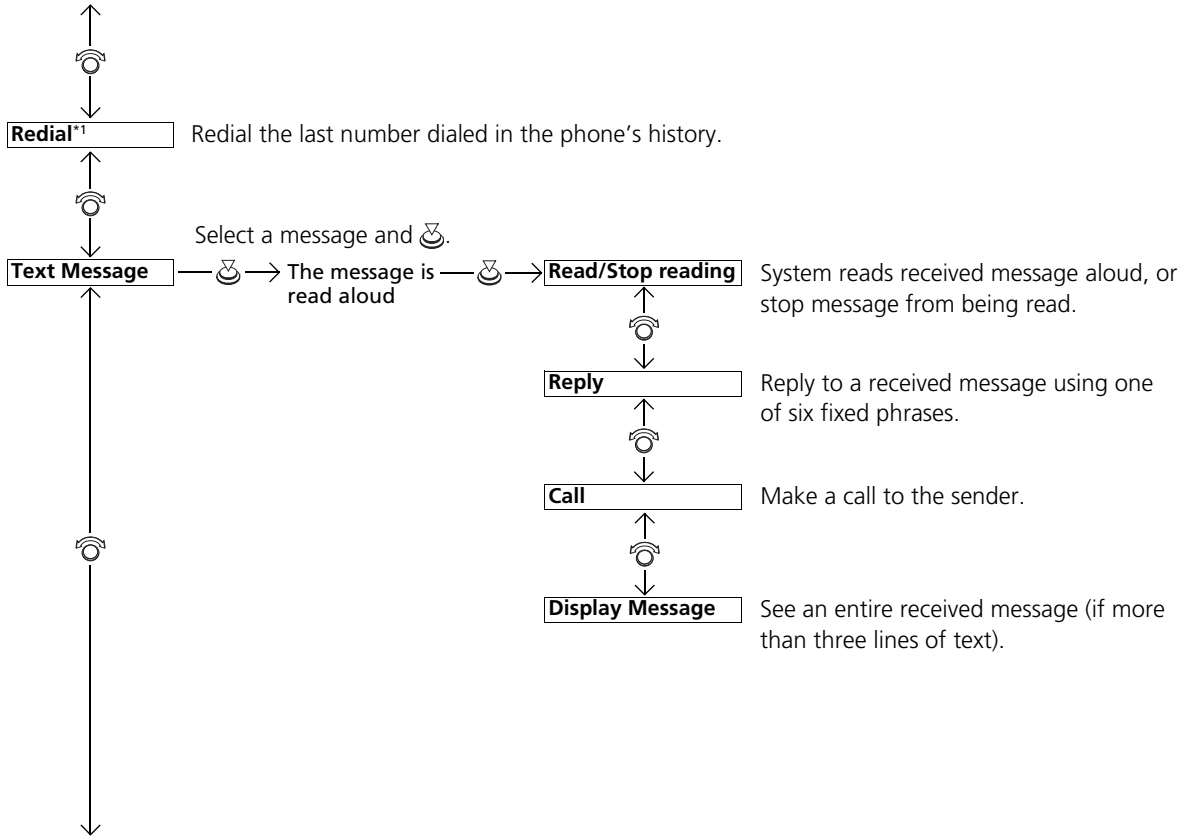

*1: Appears only when a phone is connected to HFL.

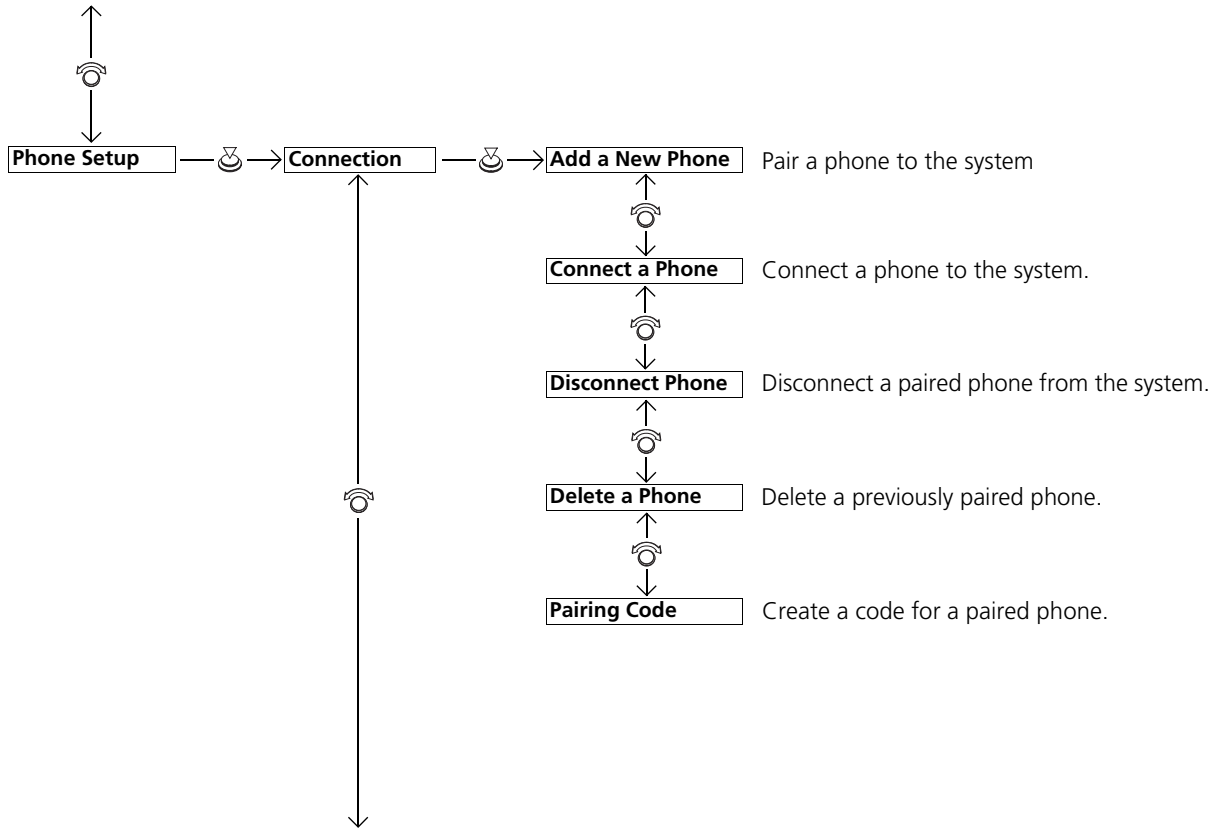

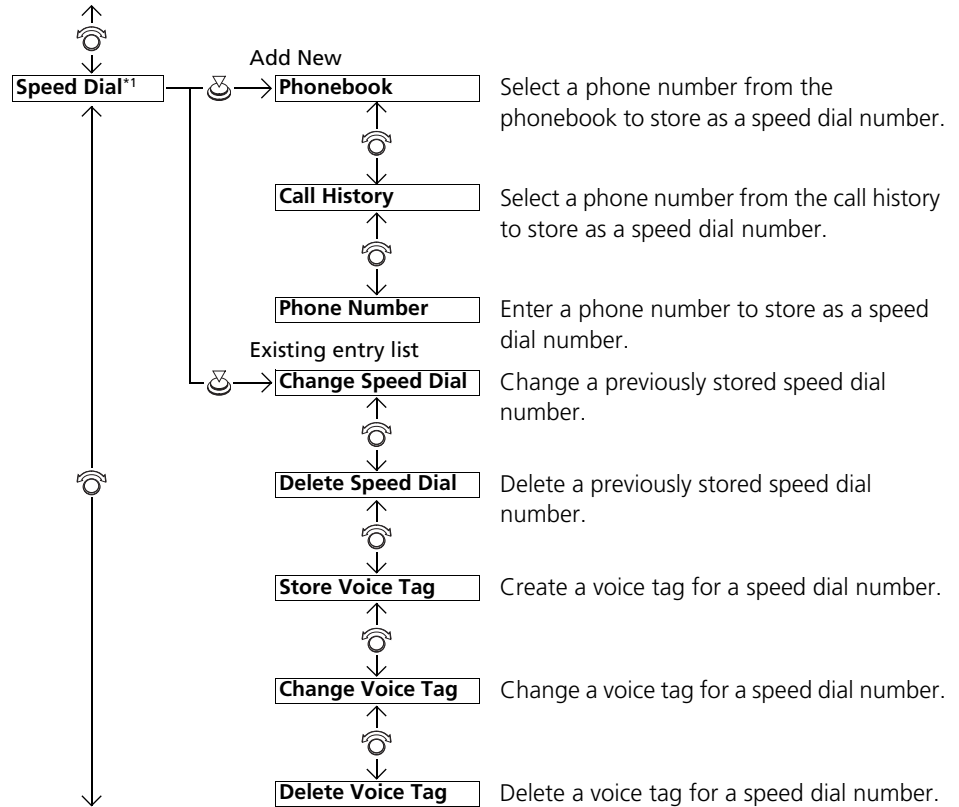

*1:Appears only when a phone is connected to HFL.

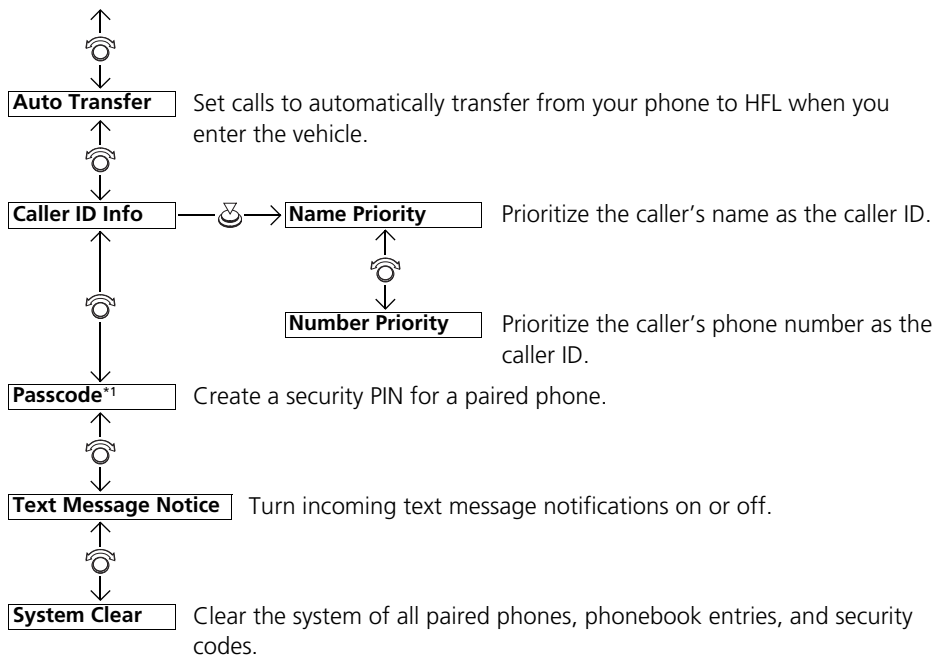



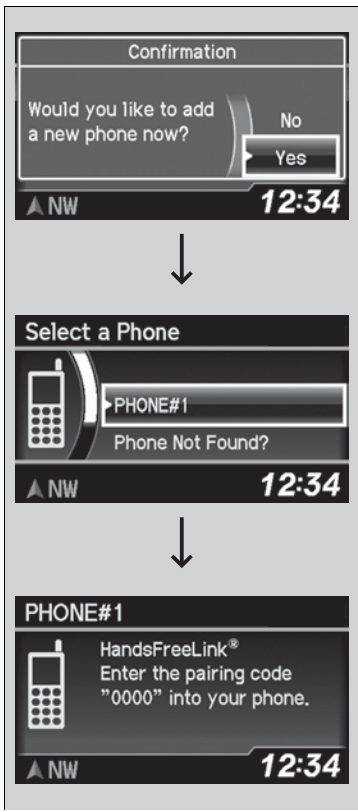

*1:Appears only when a phone is connected to HFL.

Phone Setup



■ To pair a cell phone (No phone has been paired to the system)

1. Press the **PHONE** button or the  button.
2. Rotate  to select **Yes**, then press .
3. Make sure your phone is in search or discoverable mode, then press .
 - ▶ HFL automatically searches for a Bluetooth device.
4. When your phone appears on the list, select it by pressing .
 - ▶ If your phone doesn't appear, select **Phone Not Found?** and search for Bluetooth devices using your phone. From your phone, select **HandsFreeLink**.
5. HFL gives you a four-digit pairing code to input on your phone. When your phone prompts you, input the four-digit pairing code.
6. A notification appears on the screen if pairing is successful.

☒ Phone Setup



Your *Bluetooth*-compatible phone must be paired to HFL before you can make and receive hands-free calls.

Phone Pairing Tips:

- You cannot pair your phone while the vehicle is moving.
- Up to six phones can be paired.
- Your phone's battery may drain faster when it is connected to HFL.
- If your phone is not ready for pairing or not found by the system within three minutes, the system will time out and returns to idle.







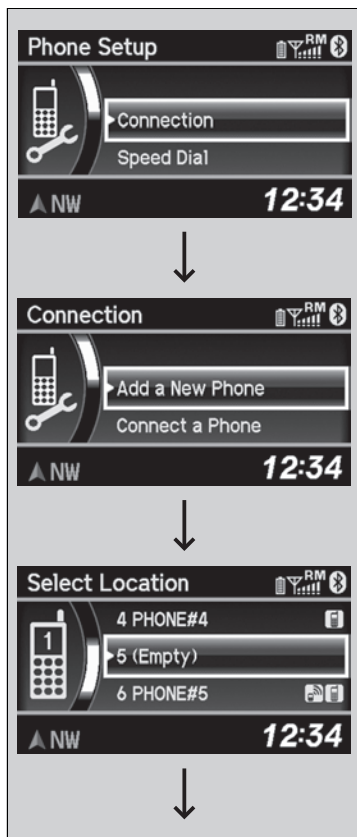

Once you have paired a phone, you can see it displayed on the screen with one or two icons on the right side.

These icons indicate the following:

- : The phone can be used with HFL.
- : The phone is compatible with *Bluetooth*® Audio.



■ **To pair a cell phone (when a phone has already been paired to the system)**

1. Press the **PHONE** button or the  button.
2. Rotate  to select **Phone Setup**, then press .
 - ▶ If a prompt appears asking to connect to a phone, select **No** and proceed with step 2.
3. Rotate  to select **Connection**, then press .
4. Rotate  to select **Add a New Phone**, then press .
 - ▶ The screen changes to **Select Location**.
5. Rotate  to select **Empty**, then press .

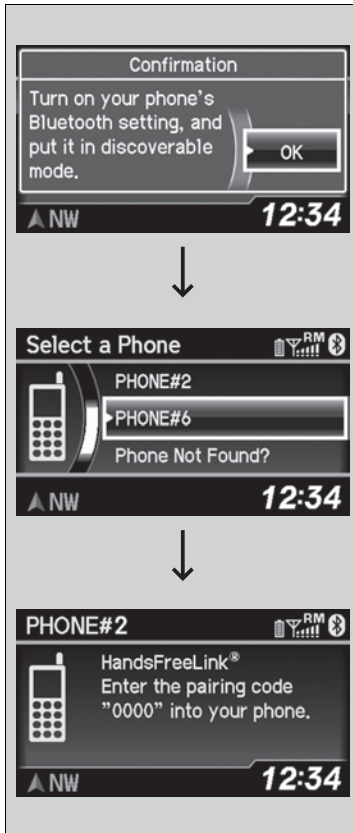

6. Make sure your phone is in search or discoverable mode, then press .
 - ▶ HFL automatically searches for a Bluetooth device.

7. When your phone appears on the list, select it by pressing .
 - ▶ If your phone doesn't appear, select **Phone Not Found?** and search for Bluetooth devices using your phone. From your phone, select **HandsFreeLink**.

8. HFL gives you a four-digit pairing code to input on your phone. When your phone prompts you, input the four-digit pairing code.
9. A notification appears on the screen if pairing is successful.

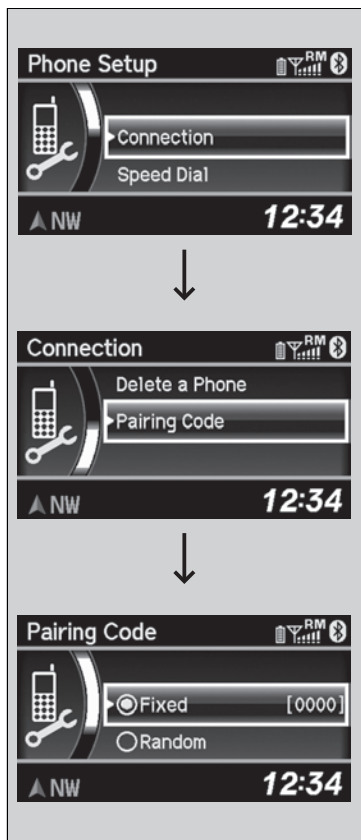

■ To change the pairing code setting

1. Press the **PHONE** button or the button.
2. Rotate to select **Phone Setup**, then press .
3. Rotate to select **Connection**, then press .
4. Rotate to select **Pairing Code**, then press .
5. Rotate to select **Fixed** or **Random**, then press .

▶▶ To change the pairing code setting





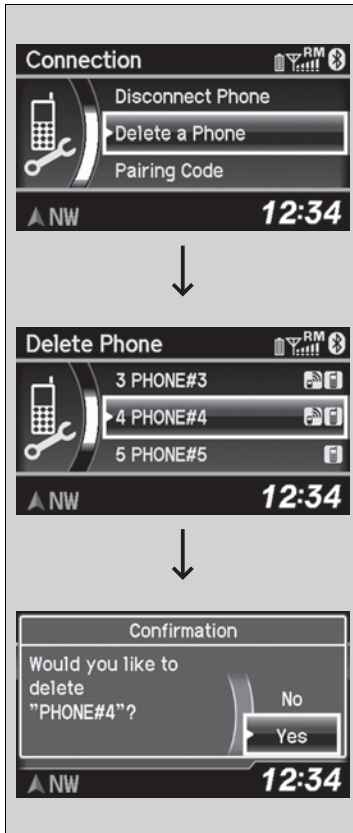

The default pairing code is "0000" until you change the setting.

To create your own, select **Fixed**, and delete the current code, then enter a new one.

For a randomly generated pairing code each time you pair a phone, select **Random**.



■ To delete a paired phone

1. Press the **PHONE** button or the  button.
2. Rotate  to select **Phone Setup**, then press .
 - ▶ Repeat the procedure to select **Connection**, then **Delete a Phone**.
3. Rotate  to select a phone you want to delete, then press .
4. A confirmation message appears on the screen. Rotate  to select **Yes**, then press .
 - ▶ A notification appears if the deletion is successful.

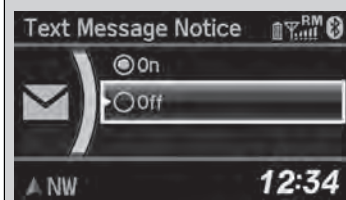
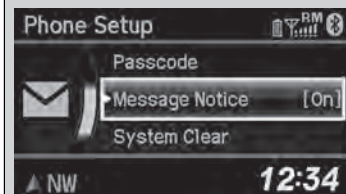

To Set Up a Text Message Notice Option



1. Press the **PHONE** button or the  button.

2. Rotate  to select **Phone Setup**, then press .

3. Rotate  to select **Message Notice**, then press .

4. Rotate  to select a mode you want, then press .

To Set Up a Text Message Notice Option









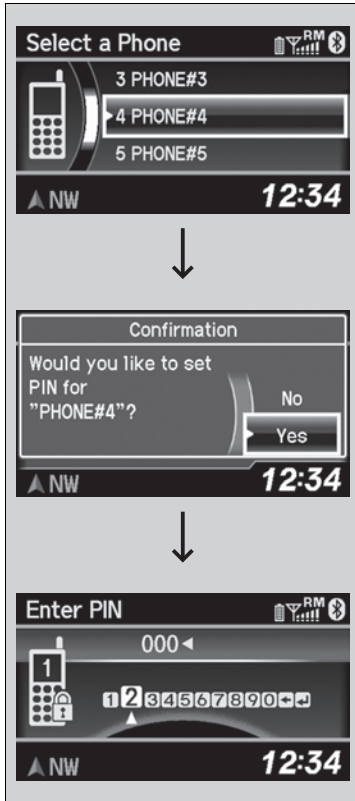

ON: A pop-up notification comes on every time you receive a new text message.

OFF: The message you receive is stored in the system without notification.

To Create a Security PIN

You can protect each of the six cell phones with a security PIN.



1. Press the **PHONE** button or the  button.
2. Rotate  to select **Phone Setup**, then press .
 - ▶ Repeat the procedure to select **Passcode**.
3. Select a phone you want to add a security PIN to.
 - ▶ Rotate  to select a phone you want to add a security PIN to, then press .
4. A confirmation message appears on the screen.
 - ▶ Rotate  to select **Yes**, then press .
5. Enter a new four-digit number.
 - ▶ Rotate  to select, then press . Press  to delete. Press  to enter the security PIN.
6. Re-enter the four-digit number.
 - ▶ The screen returns to the screen in step 2.

To Create a Security PIN





If the phone is already security PIN protected, you need to enter the current security PIN before clearing the PIN or creating a new one.

Continued

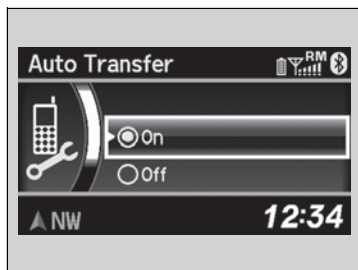
Automatic Transferring

If you get into the vehicle while you are on the phone, the call can be automatically transferred to HFL.





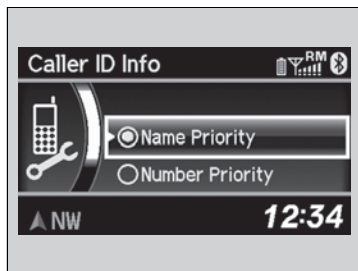

1. Press the **PHONE** button or the  button.
2. Rotate  to select **Phone Setup**, then press .
 - ▶ Repeat the procedure to select **Auto Transfer**.
3. Rotate  to select **On**, then press .
4. A notification appears on the screen if the change is successful.

Caller's ID Information

You can select a caller's information to be displayed when you have an incoming call.



1. Press the **PHONE** button or the  button.
2. Rotate  to select **Phone Setup**, then press .
 - ▶ Repeat the procedure to select **Caller ID Info**.
3. Rotate  to select a mode you want, then press .
4. A notification appears on the screen if the change is successful.

☒ Caller's ID Information

Name Priority mode: A caller's name is displayed if it is stored in the phonebook.

Number Priority mode: A caller's phone number is displayed.

To Clear the System

Security codes, paired phones, all stored voice tags, all speed dial entries, and all imported phonebook data are erased.

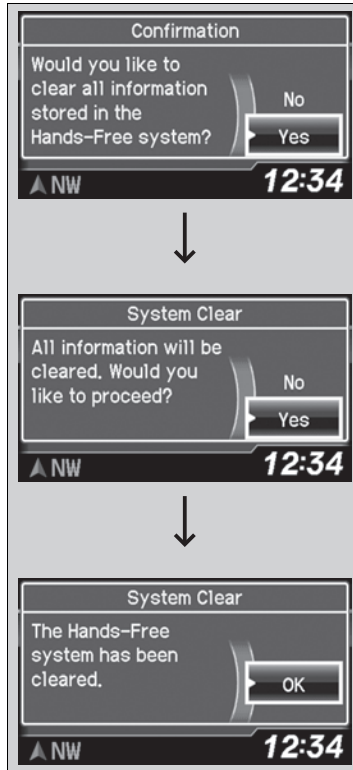

1. Press the **PHONE** button or the button.
2. Rotate to select **Phone Setup**, then press .
▶ Repeat the procedure to select **System Clear**.
3. Rotate to select **Yes**, then press .
4. A confirmation message appears on the screen. Rotate to select **Yes**, then press .
5. A confirmation message appears on the screen. Rotate to finish.

■ Automatic Import of Cellular Phonebook and Call History

When your phone is paired, the contents of its phonebook and call history are automatically imported to HFL.



▶ Automatic Import of Cellular Phonebook and Call History

When you select a person from the list in the cellular phonebook, you can see up to three category icons. The icons indicate what types of numbers are stored for that name.



If a name has four or more numbers, ... appears instead of category icons.

On some phones, it may not be possible to import the category icons to HFL.

The phonebook is updated after every connection. Call history is updated after every connection or call.

Speed Dial

Up to 15 speed dial numbers can be stored per phone.

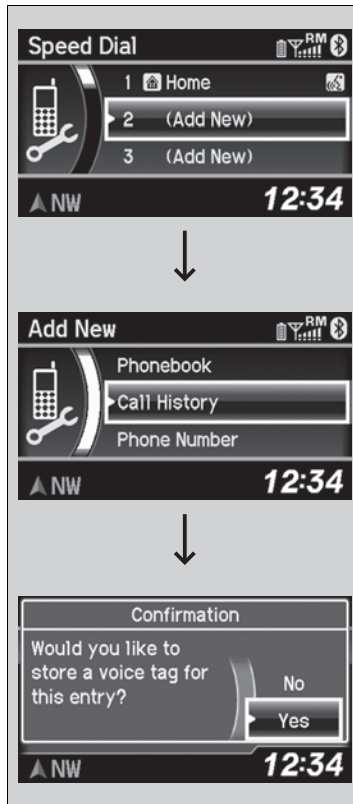

To store a speed dial number:

1. Press the **PHONE** button or the button.
2. Rotate to select **Phone Setup**, then press .
 - ▶ Repeat the procedure to select **Speed Dial**, then **Add New**.
3. Rotate to select a place to choose a number from, then press .
 - By **Phonebook**:
 - ▶ Select a number from the linked cell phone's imported phonebook.
 - By **Call History**:
 - ▶ Select a number from the call history.
 - By **Phone Number**:
 - ▶ Input the number manually.
4. When the speed dial is successfully stored, you are asked to create a voice tag for the number. Rotate to select **Yes** or **No**, then press .
5. Using the button, follow the prompts to say the name for the speed dial entry.

Speed Dial

You can use the audio preset buttons during a call to store a speed dial number:

1. Press and hold the desired audio preset button during a call.
2. The contact information for the active call will be stored for the corresponding speed dial.

When a voice tag is stored, you can press the button and call the number using voice commands.

Continued



■ To add a voice tag to a stored speed dial number

1. Press the **PHONE** button or the button.
2. Rotate to select **Phone Setup**, then press .
 - ▶ Repeat the procedure to select **Speed Dial**.
3. Select an existing speed dial entry.
4. Rotate to select **Store Voice Tag**, then press .
5. Using the button, follow the prompts to complete the voice tag.

■ To delete a voice tag

1. Press the **PHONE** button or the button.
2. Rotate to select **Phone Setup**, then press .
 - ▶ Repeat the procedure to select **Speed Dial**.
3. Select an existing speed dial entry.
4. Rotate to select **Delete Voice Tag**, then press .
 - ▶ A confirmation message appears on the screen. Rotate to select **Yes**, then press .

» Speed Dial

Avoid using duplicate voice tags.

Avoid using "home" as a voice tag. It is easier for HFL to recognize a longer name. For example, use "John Smith" instead of "John."

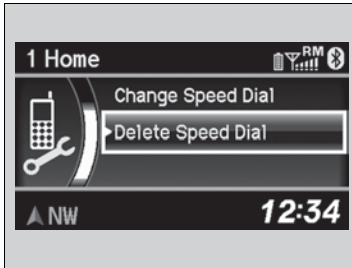

■ To delete a speed dial number

1. Press the **PHONE** button or the button.
2. Rotate to select **Phone Setup**, then press .
 - ▶ Repeat the procedure to select **Speed Dial**.
3. Select an existing speed dial entry.
4. Rotate to select **Delete Speed Dial**, then press .
 - ▶ A confirmation message appears on the screen. Rotate to select **Yes**, then press .

■ Making a Call

You can make calls by inputting any phone number, or by using the imported phonebook, call history, speed dial entries, or redial.

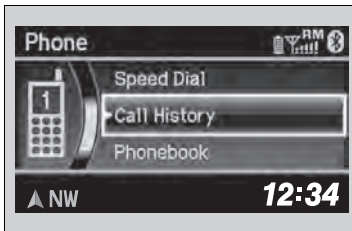

▣ Making a Call

Any voice-tagged speed dial entry can be dialed by voice from any screen.

Press the button and follow the prompts.

The maximum range between your phone and vehicles is 30 feet (10 meters).

Once a call is connected, you can hear the voice of the person you are calling through the audio speakers.

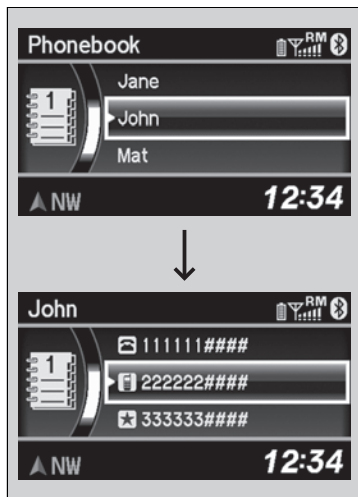

■ **To make a call using the imported phonebook**

When your phone is paired, the contents of its phonebook are automatically imported to HFL.

1. Press the **PHONE** button or the button.
2. Rotate to select **Phonebook**, then press .
3. The phonebook is stored alphabetically. Rotate to select the initial, then press .
4. Rotate to select a name, then press .
5. Rotate to select a number, then press .
 - ▶ Dialing starts automatically.

■ **To make a call using a phone number**

1. Press the **PHONE** button or the button.
2. Rotate to select **Dial**, then press .
3. Rotate to select a number, then press .
4. Rotate to select , then press .
 - ▶ Dialing starts automatically.

▶▶ To make a call using the imported phonebook

This function is disabled while the vehicle is moving. However, you can call a stored voice-tagged speed dial number using voice commands.

- ▶ [Limitations for Manual Operation P. 195](#)
- ▶ [Speed Dial P. 211](#)

▶▶ To make a call using a phone number

This function is disabled while the vehicle is moving. However, you can call a stored voice-tagged speed dial number using voice commands.

- ▶ [Limitations for Manual Operation P. 195](#)
- ▶ [Speed Dial P. 211](#)



■ **To make a call using redial**

1. Press the **PHONE** button or the button.
2. Rotate to select **Redial**, then press .
 - ▶ Dialing starts automatically.

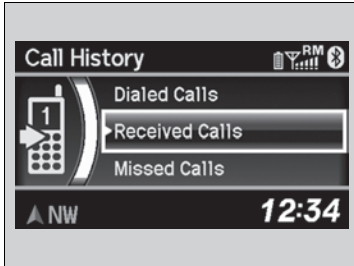

■ **To make a call using the call history**
Call history is stored by **Dialed Calls**, **Received Calls**, and **Missed Calls**.

1. Press the **PHONE** button or the button.
2. Rotate to select **Call History**, then press .
3. Rotate to select **Dialed Calls**, **Received Calls**, or **Missed Calls**, then press .
4. Rotate to select a number, then press .
 - ▶ Dialing starts automatically.

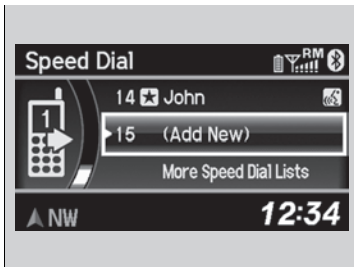

■ **To make a call using a speed dial entry**

1. Press the **PHONE** button or the button.
2. Rotate to select **Speed Dial**, then press .
3. Rotate to select a number, then press .
 - ▶ Dialing starts automatically.

Continued

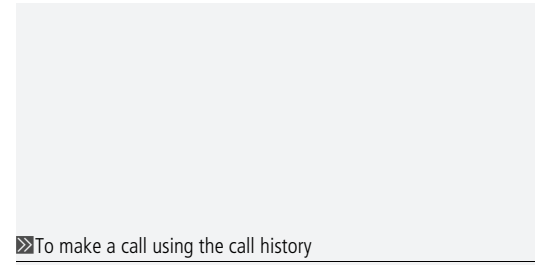

☒ To make a call using the call history

The call history appears only when a phone is connected to HFL, and displays the last 20 dialed, received, or missed calls.

☒ To make a call using a speed dial entry

On the **Phone** screen, the first six speed dials on the list can be directly selected by pressing the corresponding audio preset buttons (1-6).

Select **More Speed Dial Lists** to view another paired phone's speed dial list.

When a voice tag is stored, press the button and call the number using voice commands.

[▶ Speed Dial P. 211](#)

Any voice-tagged speed dial entry can be dialed by voice from any screen.

Press the button and follow the prompts.

Receiving a Call

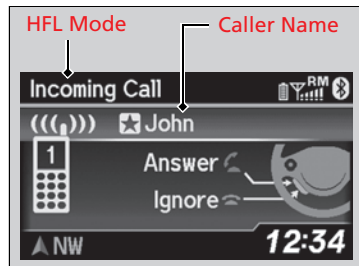

When there is an incoming call, an audible notification sounds (if activated) and the Incoming Call screen appears.

Press the  button to answer the call.

Press the  button to decline or end the call.

Receiving a Call

Call Waiting

Press the  button to put the current call on hold to answer the incoming call.

Press the  button again to return to the current call.

Ignore the incoming call if you do not want to answer it.

Press the  button if you want to hang up the current call.

Options During a Call

The following options are available during a call.



Mute: Mute your voice.

Transfer Call: Transfer a call from HFL to your phone.

Touch Tones: Send numbers during a call. This is useful when you call a menu-driven phone system.



1. To view the available options, press the **PHONE** button.

2. Rotate  to select the option, then press .
 - ▶ The check box is checked when **Mute** is selected. Select **Mute** again to turn it off.



Options During a Call

Touch Tones: Available on some phones.

Receiving a Text Message

HFL can display newly received text messages as well as 20 of the most recently received messages on a connected cell phone. Each received message can be read aloud and replied to using a fixed common phrase.



1. A pop-up appears and notifies you of a new text message.
2. Rotate  to select **Yes** to listen to the message, then press .
 - ▶ The text message is displayed. The system automatically starts reading out the message.
3. To discontinue the message read-out, press the  button.

Receiving a Text Message

The system does not display any received messages while you are driving. You can only hear them read aloud.

With some phones, you may be able to display up to 20 most recent text messages.

Only the first three lines of the received message are displayed with this option.

▶ [Displaying an entire message P. 222](#)

Displaying Messages

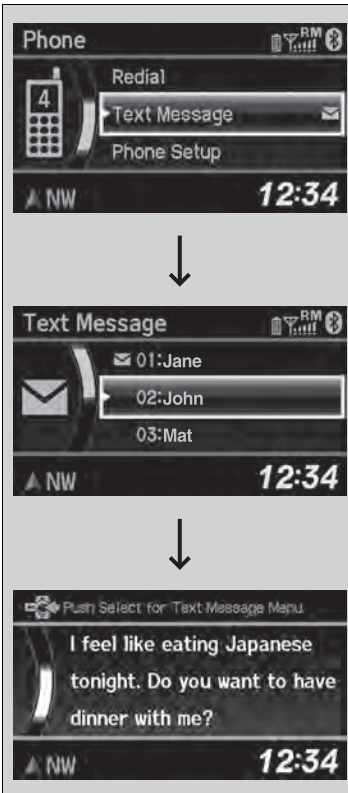

1. Press the **PHONE** button or the button.
2. Rotate to select **Text Message**, then press .
3. Rotate to select a message, then press .
 - ▶ The text message is displayed. The system automatically starts reading the message aloud.

Displaying Messages

The icon appears next to an unread message.

Only the first three lines of the received message are displayed with this option.

➤ [Displaying an entire message P. 222](#)

If you delete a message on the phone, the message disappears from the system. If you send a message from the system, the message goes to your phone.

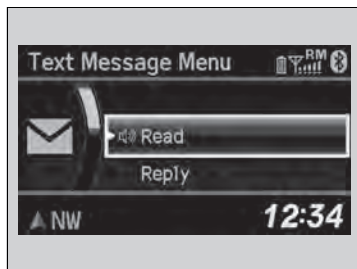

■ Using the stop reading or read option

1. Press the **PHONE** button or the button.
2. Rotate to select **Text Message**, then press .
3. Rotate to select a message, then press .
 - ▶ The text message is displayed. The system automatically starts reading the message aloud.
4. Press to enter **Text Message Menu**.
5. Rotate to select **Stop Reading** or **Read**, then press .

▶▶ Using the stop reading or read option

This option changes to:

- **Stop Reading** while the text message is read out. Select this option to discontinue the message read-out.
- **Read** when you go to the **Text Message** menu, or after you selected **Stop Reading**. Select this option to hear the system reading out the selected message.



■ Reply to a message

You can reply to a message using one of the six common phrases available in the system.

1. Press the **PHONE** button or the button.
2. Rotate to select **Text Message**, then press .
3. Rotate to select a message, then press .
 - ▶ The text message is displayed. The system automatically starts reading out the message.
4. Press to enter the **Text Message Menu**.
5. Rotate to select **Reply**, then press .
6. Rotate to select the reply message, then press .
7. The reply message you selected is displayed. Select **Yes** to send the message.

☒ Reply to a message

The available fixed reply messages are as follows:

- **Talk to you later, I'm driving.**
- **I am on my way.**
- **I'm running late.**
- **OK**
- **Yes**
- **No**

You cannot add, edit, or delete reply messages.



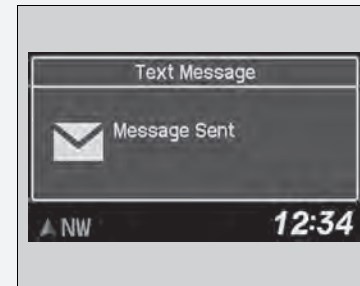

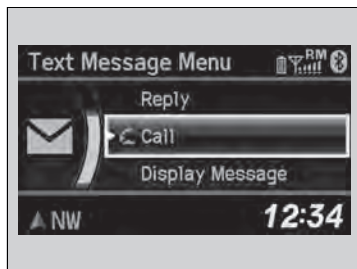



After you reply, the following is displayed:













■ Making a call to a sender

You can call the text message sender.

1. Press the **PHONE** button or the  button.
2. Rotate  to select to **Text Message**, then press .
3. Rotate  to select a message, then press .
 - ▶ The text message is displayed. The system automatically starts reading out the message.
4. Press  to enter the **Text Message Menu**.
5. Rotate  to select **Call**, then press .
 - ▶ HFL begins dialing.

■ Displaying an entire message

1. Press the **PHONE** button or the  button.
2. Rotate  to select to **Text Message**, then press .
3. Rotate  to select a message, then press .
 - ▶ The text message is displayed. The system automatically starts reading out the message.
4. Press  to enter the **Text Message Menu**.
5. Rotate  to select **Display Message**, then press .
6. Rotate  to scroll down and display the entire message.





When you turn the ignition switch to ON , the compass self-calibrates, and the compass display appears.

Compass Calibration

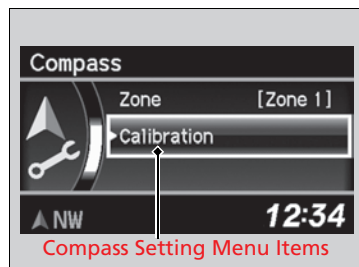
If the compass indicates the wrong direction, or the **CAL** indicator blinks, you need to manually calibrate the system.



1. Turn the ignition switch to ON .
2. Press and hold the **SETUP** button until the display shows the compass setting menu.
3. Rotate  to select **Calibration**, then press .

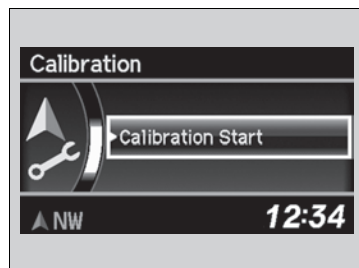

4. When the display changes to **Calibration Start**, press .
5. Drive the vehicle slowly in two circles.
 - ▶ The compass starts to show a direction after the calibration. The **CAL** indicator goes off.

Compass

Compass operation can be affected under the following conditions:

- Driving near power lines or stations
- Crossing a bridge
- Passing a large vehicle, or driving near a large object that can cause a magnetic disturbance
- When accessories such as antennas and roof racks are mounted by magnets

Compass Calibration

Calibrate the compass in an open area.





While setting the compass:

- The  button returns to the previous screen.
- The **SETUP** button cancels the setting mode.

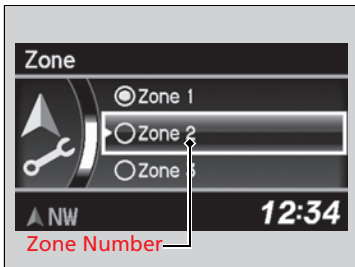
Compass Zone Selection

▶▶ Compass Zone Selection



1. Turn the ignition switch to ON .
2. Press and hold the **SETUP** button until the display shows the compass setting menu.
3. Rotate  to select **Zone**, then press . The display shows the current zone number.
4. Rotate  to select the zone number of your area (See Zone Map), then press .

The zone selection is done to compensate the variation between magnetic north and true north.

If the calibration starts while the audio system is in use, the display returns to normal after the calibration is completed.

TOC

Features

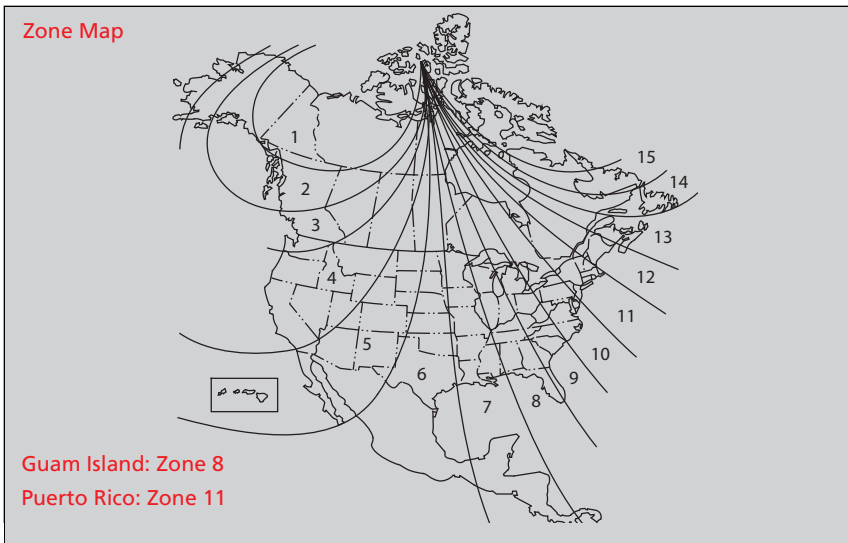

Index

Home

Driving

This chapter discusses driving, refueling, and information on items such as accessories.

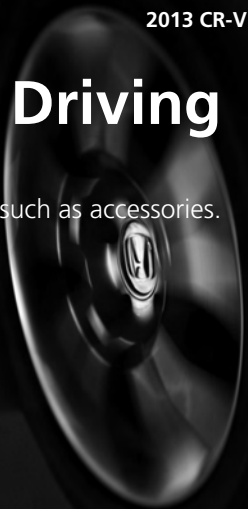

Before Driving

- Driving Preparation 226
- Maximum Load Limit..... 229

Towing a Trailer

- Towing Preparation..... 231
- Driving Safely with a Trailer..... 234
- Towing Your Vehicle..... 235

Off-Highway Driving Guidelines

- General Information..... 237
- Important Safety Precautions..... 237
- Avoiding Trouble 238

When Driving

- Starting the Engine 239
- Precautions While Driving..... 241

- Automatic Transmission 242
- Shifting..... 243
- ECON Button 245
- Cruise Control 246
- VSA® (Vehicle Stability Assist), aka ESC (Electronic Stability Control), System 249
- Real Time AWD with Intelligent Control System™* 251
- TPMS (Tire Pressure Monitoring System)... 251
- Tire Pressure Monitoring System (TPMS) - Required Federal Explanation 252

Braking

- Brake System 254

- ABS (Anti-lock Brake System) 256
- Brake Assist System 257

Parking Your Vehicle

- When Stopped 258

Multi-View Rear Camera..... 259

Refueling

- Fuel Information 260
- How to Refuel 261

Fuel Economy..... 263

- Improving Fuel Economy..... 263

Accessories and Modifications

- Accessories 264
- Modifications..... 264

* Not available on all models

Driving Preparation

Check the following items before you start driving.

Exterior Checks

- Make sure there are no obstructions on the windows, door mirrors, exterior lights, or other parts of the vehicle.
 - ▶ Remove any frost, snow, or ice.
 - ▶ Remove any snow on the roof, as this can slip down and obstruct your field of vision while driving. If frozen solid, remove ice once it has softened.
 - ▶ When removing ice from around the wheels, be sure not to damage the wheel or wheel components.
- Make sure the hood is securely closed.
 - ▶ If the hood opens while driving, your front view will be blocked.
- Make sure the tires are in good condition.
 - ▶ Check air pressures, and check for damage and excessive wear.
 - ▶ [Checking and Maintaining Tires P. 298](#)
- Make sure there are no people or objects behind or around the vehicle.
 - ▶ There are blind spots from the inside.

Exterior Checks

NOTICE

When doors are frozen shut, use warm water around the door edges to melt any ice. Do not try to force them open, as this can damage the rubber trim around the doors. When done, wipe dry to avoid further freezing.

Do not pour warm water into the key cylinder. You will be unable to insert key if the water freezes in the hole.

Heat from the engine and exhaust can ignite flammable materials left under the hood, causing a fire. If you've parked your vehicle for an extended period, inspect and remove any debris that may have collected, such as dried grass and leaves that have fallen or have been carried in for use as a nest by a small animal. Also check under the hood for leftover flammable materials after you or someone else has performed maintenance on your vehicle.

Interior Checks

- Store or secure all items on board properly.
 - ▶ Carrying too much cargo, or improperly storing it, can affect your vehicle's handling, stability, stopping distance, and tires, and make it unsafe.
 - [Maximum Load Limit P. 229](#)
- Do not pile items higher than the seat height.
 - ▶ They can block your view and may be thrown forward in the event of sudden braking.
- Do not place anything in the front seat footwells. Make sure to secure the floor mat.
 - ▶ An object or unsecured floor mat can interfere with your brake and accelerator pedal operation while driving.
- If you have any animals on board, do not let them move around in the vehicle.
 - ▶ They may interfere with driving and a crash could occur.
- Securely close and lock all doors and the tailgate.
 - [Locking/Unlocking the Doors from the Inside P. 101](#)
- Adjust your seating position properly.
 - ▶ Adjust the head restraint, too.
 - [Adjusting the Seats P. 122](#)
 - [Adjusting the Head Restraints P. 125](#)
- Adjust the mirrors and steering wheel properly for your driving.
 - ▶ Adjust them while sitting in the proper driving position.
 - [Adjusting the Steering Wheel P. 119](#)
 - [Adjusting the Mirrors P. 120](#)

Interior Checks

The headlight aim is set by the factory, and does not need to be adjusted. However, if you regularly carry heavy items in the cargo area or tow a trailer, have the aiming readjusted at a dealer or by a qualified technician.

- Be sure items placed on the floor behind the front seats cannot roll under the seats.
 - ▶ They can interfere with the driver's ability to operate the pedals, the operation of the seats, or the operation of the sensors under the seats.
- Everyone in the vehicle must fasten their seat belt.
 - ▶ [Fastening a Seat Belt P. 32](#)
- Make sure that the indicators in the instrument panel come on when you start the vehicle, and go off soon after.
 - ▶ Always have a dealer check the vehicle if a problem is indicated.
 - ▶ [Indicators P. 68](#)

Maximum Load Limit

The maximum load for your vehicle is 850 lbs (385 kg).
See Tire and Loading Information label attached to the driver's doorjamb.

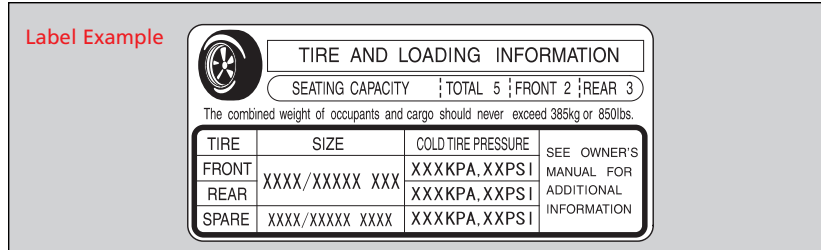

This figure includes the total weight of all occupants, cargo, and accessories, and the tongue load if you are towing a trailer.

Steps for Determining Correct Load Limit -

- (1) Locate the statement "The combined weight of occupants and cargo should never exceed XXX kg or XXX lbs." on your vehicle's placard.
- (2) Determine the combined weight of the driver and passengers that will be riding in your vehicle.
- (3) Subtract the combined weight of the driver and passengers from XXX kg or XXX lbs.
- (4) The resulting figure equals the available amount of cargo and luggage load capacity. For example, if the "XXX" amount equals 1,400 lbs. and there will be five 150 lb. passengers in your vehicle, the amount of available cargo and luggage load capacity is 650 lbs.
(1,400 - 750 (5 x 150) = 650 lbs.)

Maximum Load Limit

⚠ WARNING

Overloading or improper loading can affect handling and stability and cause a crash in which you can be hurt or killed.

Follow all load limits and other loading guidelines in this manual.

Gross Vehicle Weight Rating (GVWR):

The maximum allowable weight of the vehicle, all occupants, all accessories, all cargo, and the tongue load.

➤ [Specifications P. 342](#)

Gross Axle Weight Rating (GAWR):







The maximum allowable weight of the vehicle axle.

➤ [Specifications P. 342](#)

- (5) Determine the combined weight of luggage and cargo being loaded on the vehicle. That weight may not safely exceed the available cargo and luggage load capacity calculated in step 4.
- (6) If your vehicle will be towing a trailer, load from your trailer will be transferred to your vehicle. Consult this manual to determine how this reduces the available cargo and luggage load capacity of your vehicle.

In addition, the total weight of the vehicle, all occupants, accessories, cargo, and trailer tongue load must not exceed the Gross Vehicle Weight Rating (GVWR) or the Gross Axle Weight Rating (GAWR). Both are on a label on the driver's doorjamb.

Load Limits Example

<p>Example 1</p>  <p>Max Load 850 lbs (385 kg)</p>	<p>≧</p>	 <p>Passenger Weight 150 lbs x 2 = 300 lbs (68 kg x 2 = 136 kg)</p>	<p>+</p>	 <p>Cargo Weight 550 lbs (249 kg)</p>
<p>Example 2</p>  <p>Max Load 850 lbs (385 kg)</p>	<p>≧</p>	 <p>Passenger Weight 150 lbs x 5 = 750 lbs (68 kg x 5 = 340 kg)</p>	<p>+</p>	 <p>Cargo Weight 100 lbs (45 kg)</p>

Towing Preparation

Towing Load Limits

Your vehicle can tow a trailer if you carefully observe the load limits, use the proper equipment, and follow the towing guidelines. Check the load limits before driving.

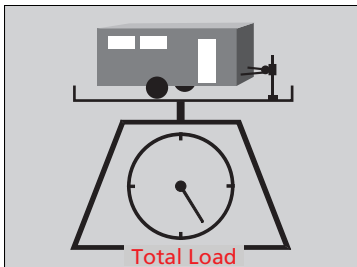

■ Total trailer weight

Maximum allowable weight of the trailer, cargo, and everything in or on it must not exceed 1,500 lbs (680 kg). Towing loads in excess of this can seriously affect vehicle handling and performance and can damage the engine and drivetrain.

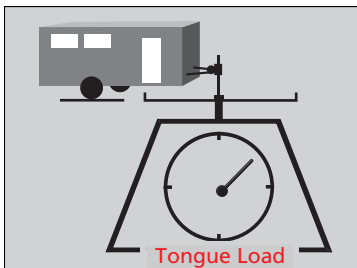

■ Tongue load

The weight of the tongue with a fully loaded trailer on the hitch should be approximately 10% of the total trailer weight.

- Excessive tongue load reduces front tire traction and steering control. Too little tongue load can make the trailer unstable and cause it to sway.
- To achieve a proper tongue load, start by loading 60% of the load toward the front of the trailer and 40% toward the rear. Readjust the load as needed.

Towing Load Limits

⚠ WARNING

Exceeding any load limit or improperly loading your vehicle and trailer can cause a crash in which you can be seriously hurt or killed.

Check the loading of your vehicle and trailer carefully before starting to drive.

Check if all loads are within limits at a public scale. If a public scale is not available, add the estimated weight of your cargo load to the weight of your trailer (as quoted by the manufacturer), and the tongue load.

Break-in Period

Avoid towing a trailer during your vehicle's first 600 miles (1,000 km).

Never exceed the gross weight ratings.

Gross weight information

[▶ Vehicle Specifications P. 342](#)

■ Towing Equipment and Accessories

Towing equipment varies by the size of your trailer, how much load you are towing, and where you are towing.

■ Hitches

The hitch must be of an approved type and properly bolted to the underbody.

■ Safety chains

Always use safety chains when you tow a trailer. Leave enough slack to allow the trailer to turn corners easily, but do not allow the chains to drag on the ground.

■ Trailer brakes

Recommended for any trailer with a total weight of 1,000 lbs (450 kg) or more:

There are two common types of trailer brakes: surge and electric. Surge brakes are common for boat trailers, since the brakes will get wet. If you choose electric brakes, be sure they are electronically actuated. Do not attempt to attach trailer brakes to your vehicle's hydraulic system, as it will lower braking effectiveness and create a potential hazard.

■ Additional towing equipment

Many states and provinces/territories require special outside mirrors when towing a trailer. Even if mirrors are not required in your locale, you should install special mirrors if visibility is restricted in any way.

▶▶ Towing Equipment and Accessories

Make sure that all equipment is properly installed and maintained, and that it meets federal, state, province/territory, and local regulations.

Consult your trailer sales or rental agency if any other items are recommended or required for your towing situation.

The lighting and wiring of trailers can vary by type and brand. If a connector is required, it should only be installed by a qualified technician.

■ **Trailer light**

Trailer lights and equipment must comply with federal, state, province/territory, and local regulations. Check with your local trailer sales or rental agency for the requirements in the area where you plan to tow.

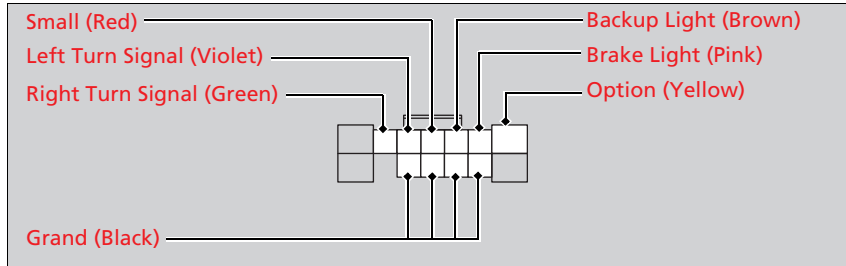

Your trailer lighting connector is located behind the left side panel in the cargo area. Each pin's purpose and wiring color code are shown in the image.

When using a non-Honda trailer lighting harness and converter, get the connector and pins for your vehicle from a dealer.

Driving Safely with a Trailer

■ Things You Need To Know Before Towing a Trailer

- Have the trailer properly serviced and keep it in good condition.
- Make sure that all the weights and load in the vehicle and trailer are within limits.
▶ [Towing Load Limits P. 231](#)
- Securely attach the hitch, safety chains, and other necessary parts to the trailer.
- Securely store all the items in and on the trailer so that they do not shift while driving.
- Check if the lights and brakes on the trailer are working properly.
- Check the pressures of the trailer tires, including the spare.

■ Towing Speeds and Gears

- Drive slower than normal.
- Obey posted speed limits for vehicles with trailers.
- Use the **D** position when towing a trailer on level roads.

■ Turning and Braking

- Turn more slowly and with a wider turning arc than normal.
- Allow more time and distance for braking.
- Do not brake or turn suddenly.

■ Driving in Hilly Terrain

- Monitor your temperature gauge. If it nears the red (Hot) mark, turn off the heating and cooling system*/climate control system* and reduce speed. Pull to the side of the road safely to cool down the engine if necessary.
- Shift to the **D3** position if the transmission shifts frequently.

* Not available on all models

▶▶ Driving Safely with a Trailer

Parking

In addition to the normal precautions, place wheel chocks at each of the trailer's tires.

Towing Your Vehicle

Your vehicle can be towed behind a motorhome.

When Your Vehicle is Towed Behind a Motorhome

Perform the following procedure before towing your vehicle.

1. Check the transmission fluid level.
 - ▶ Make sure the fluid level is between the upper and lower marks.
2. Start the engine.
3. Depress the brake pedal. Move the shift lever through all its positions.
4. Shift to **[D]** and hold for five seconds, then to **[N]**. Let the engine run for three minutes, then turn it off.
5. Release the parking brake.
6. Leave the ignition switch in ACCESSORY **[I]**.
 - ▶ Make sure the steering wheel does not lock.
7. Turn off all the electric devices. Do not use any accessory power sockets.
 - ▶ This can prevent the battery from running down.

» Towing Your Vehicle

NOTICE

Failure to follow the recommended instructions exactly will result in severe automatic transmission damage. If you cannot shift the transmission or start the engine, your vehicle must be transported on a flat-bed truck or trailer.

Do not exceed 65 mph (100 km/h).

AWD models

To avoid damage to the AWD system, your vehicle must be towed with all four wheels on the ground.

Consult your towing parts sales or rental agency if any other items are recommended or required for your towing situation.

If you tow your vehicle behind a motorhome, the transmission fluid must be changed every 2 years or 30,000 miles (48,000 km), whichever comes first.

» When Your Vehicle is Towed Behind a Motorhome

NOTICE

Severe transmission damage will occur if the vehicle is shifted from **[R]** to **[N]** and then towed with the drive wheels on the ground.

QRG

■ **Extended towing**

If you tow more than eight hours in one day, you should repeat the “before towing your vehicle procedure” at least every eight hours. You also need to perform the following procedure to prevent the battery from running down.

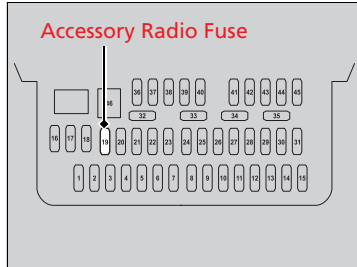

1. Remove the 7.5 A accessory radio fuse. This fuse is located in the interior fuse box.
▶ [Interior Fuse Box P. 336](#)
2. Store the fuse in a safe place so you do not lose it.
▶ Make sure to reinstall the fuse before you start driving your vehicle.

TOC

Driving

Index

Home

General Information

Your vehicle has been designed primarily for use on pavement, however, its higher ground clearance allows you to occasionally travel on unpaved roads. It is not designed for trail-blazing, or other challenging off-road activities.

If you decide to drive on unpaved roads, you will find that it requires somewhat different driving skills and that your vehicle will handle somewhat differently than it does on pavement. Pay attention to the precautions and tips in this section, and get acquainted with your vehicle before leaving the pavement.

Important Safety Precautions

To avoid loss of control or rollover, be sure to follow all precautions and recommendations:

- Be sure to store cargo properly and do not exceed your cargo load limits.
➤ [Maximum Load Limit P. 229](#)
- Whenever you drive, make sure you and your passengers always wear seat belts.
- Keep your speed low, and never go faster than the conditions allow.
- It's up to you to continually assess the situation and drive within the limits.

Off-Highway Driving Guidelines

WARNING

Improperly operating this vehicle on or off pavement can cause a crash or rollover in which you and your passengers can be seriously injured or killed.

- Follow all instructions and guidelines in this owner's manual.
- Keep your speed low, and don't drive faster than conditions permit.

Failure to operate your vehicle correctly might result in a crash or a rollover.

- [Important Handling Information P. 26](#)
- [Precautions While Driving P. 241](#)

Avoiding Trouble

- **Check Out Your Vehicle** before you leave the pavement and make sure that all scheduled maintenance has been completed. Pay special attention to the condition of the tires, and check the tire pressures.
- **Remember** the route you choose presents limits (too steep or bumpy), you have limits (driving skill and comfort), and your vehicle has limits (traction, stability, and power). Failing to recognize these limits will likely put you and your passengers in a hazardous situation.
- **Accelerating and Braking** should be done slowly and gradually. Trying to start or stop too fast can cause a loss of traction and you could lose control.
- **Avoiding Obstacles and Debris** in the road reduces the likelihood of a rollover or damage to your suspension or other components.
- **Driving on Slopes** increases your risk of a rollover, particularly if you attempt to drive across a slope that is too steep. Going straight or down a slope is usually the safest. If you can't clearly see all conditions or obstacles on a slope, walk it before you drive it. If there is any doubt whether you can safely pass, don't try it. Find another route. If you get stuck when climbing, do not try to turn around. Back down slowly following the same route you took up the hill.
- **Crossing a Stream** - Avoid driving through deep water. If you encounter water in your route (a small stream or large puddle, for example), evaluate it carefully before going ahead. Make sure it is shallow, flowing slowly, and has firm ground underneath. If you are not sure of the depth or the ground, turn around and find another route. Driving through deep water can also damage your vehicle. The water can get into the transmission and differential, diluting the lubricant and causing an eventual failure. It can also wash the grease out of the wheel bearings.
- **If You Get Stuck**, carefully go in the direction that you think will get you unstuck. Do not spin the tires as this will only make things worse and could damage the transmission. If you are unable to free yourself, your vehicle will need to be towed. Front and rear tow hooks are provided for this purpose.

Starting the Engine

ORG

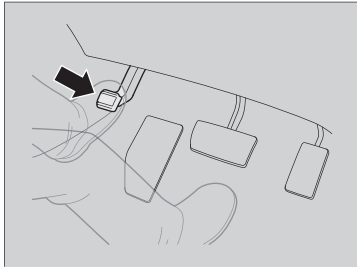

1. Make sure the parking brake is applied.

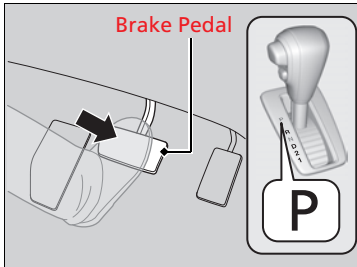

2. Check that the shift lever is in **P**, then depress the brake pedal.

▶ Although it is possible to start the vehicle in **N**, it is safer to start it in **P**.

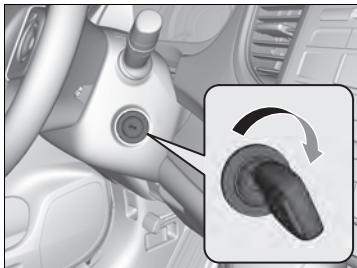

3. Turn the ignition switch to START **III** without depressing the accelerator pedal.

Starting the Engine

Keep your foot firmly on the brake pedal when starting the engine.

The engine is harder to start in cold weather and in thinner air found at altitudes above 8,000 feet (2,400 meters).

When starting the engine in cold weather, turn off all electrical accessories such as the lights, heating and cooling system*/climate control system*, and rear defogger in order to reduce battery drain.

If you live in a region where winter is extremely cold, an engine block heater will improve starting and warming of the engine. If temperatures consistently below -22°F (-30°C) are expected, the coolant mixture should be changed to a higher concentration to prevent freezing. Consult a dealer for details.

If the exhaust system sounds abnormal or you can smell exhaust gas inside the vehicle, have your vehicle checked by a dealer. There may be a problem with the engine or exhaust system.

TOC

Driving

Index

Home

* Not available on all models

Continued

Starting to Drive

1. Keeping your right foot on the brake pedal, release the parking brake. Check that the parking brake indicator has gone off.
[▶ Parking Brake P. 254](#)
2. Put the shift lever in **D**. Select **R** when reversing.
3. Gradually release the brake pedal and gently depress the accelerator pedal to pull away.

Hill start assist system

Hill start assist keeps the brake engaged briefly to help prevent the vehicle from rolling on inclines as you move your foot from the brake pedal to the accelerator.

Move the shift lever to **D** or **D3** when facing uphill, or **R** when facing downhill, then release the brake pedal.

Starting the Engine

Do not hold the key in START **III** for more than 15 seconds.

- If the engine does not start right away, wait for at least 10 seconds before trying again.
- If the engine starts, but then immediately stops, wait at least 10 seconds before repeating step 3 while gently depressing the accelerator pedal. Release the accelerator pedal once the engine starts.

The immobilizer system protects your vehicle from theft. If an improperly coded key (or other device) is used, the engine's fuel system is disabled.

[▶ Immobilizer System P. 106](#)

Hill start assist system

Hill start assist may not prevent the vehicle from rolling downhill on a very steep or slippery slope, and does not operate on small inclines.

Hill start assist is not a replacement for the parking brake.

Hill start assist will operate even when VSA® is switched off.

Precautions While Driving

Driving Guidelines for Your Utility Vehicle

Utility vehicles have a significantly higher rollover rate than other types of vehicles. To prevent rollovers or loss of control:

- Take corners at slower speeds than you would with a passenger vehicle.
- Avoid sharp turns and abrupt maneuvers whenever possible.
- Do not modify your vehicle in any way that you would raise the center of gravity.
- Do not carry heavy cargo on the roof.

In Rain

Avoid driving in deep water and on flooded roads. This can damage the engine, driveline, or cause electrical component failure.

Other Precautions

If there is a strong impact with something under the vehicle, stop in a safe location. Check the underside of the vehicle for damage or any fluid leaks.

Precautions While Driving

NOTICE

Do not operate the shift lever while pressing the accelerator pedal. You could damage the transmission.

If the ignition switch is turned to ACCESSORY [I] or LOCK [O] while driving, the engine will shut down and all steering and brake power assist functions will stop, making it difficult to control the vehicle.

Do not put the shift lever in [N], as you will lose engine braking (and acceleration) performance.

During the first 600 miles (1,000 km) of operation, avoid sudden acceleration or full throttle operation so as to not damage the engine or powertrain.

Avoid hard braking for the first 200 miles (300 km). You should also follow this when the brake pads are replaced.

Driving Guidelines for Your Utility Vehicle

Failure to operate your vehicle correctly might result in a crash or a rollover.

- [Important Handling Information P. 26](#)
- [Precautions While Driving P. 241](#)

Automatic Transmission

■ Creeping

The engine runs at a higher idle speed and creeping increases. Keep the brake pedal firmly depressed when stopped.

■ Kickdown

Quickly depressing the accelerator pedal while driving uphill may cause the transmission to drop to a lower gear, unexpectedly increasing vehicle speed. Depress the accelerator pedal carefully, especially on slippery roads and curves.

Shifting

Change the shift position in accordance with your driving needs.

■ Shift lever positions

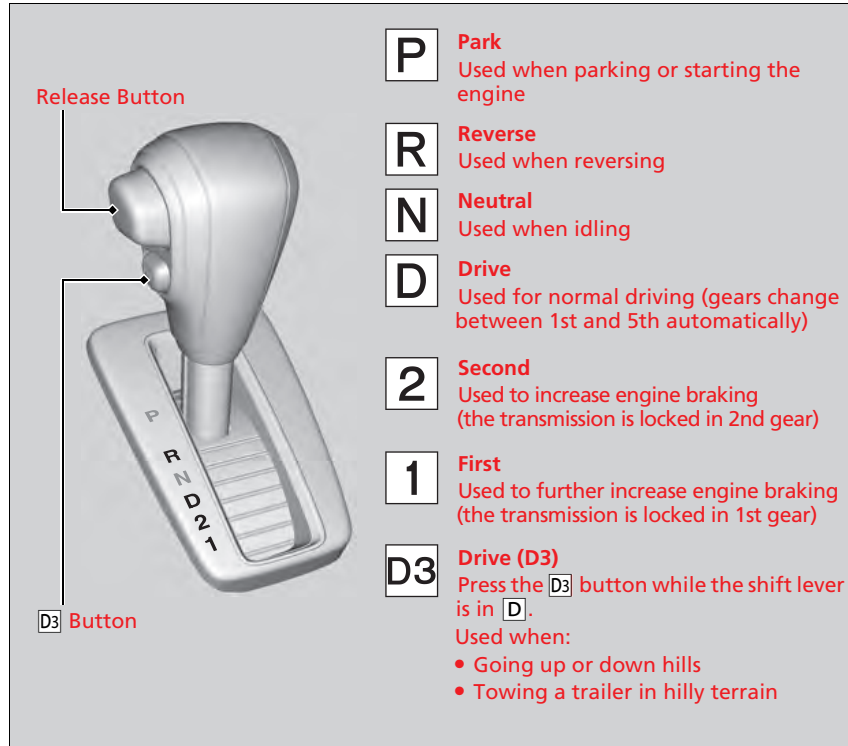

▶ Shifting

You cannot turn the ignition switch to LOCK **[0]** and remove the key unless the shift lever is in **[P]**.

The vehicle may move forward very slightly even in **[N]** while the engine is cold. Depress the brake pedal firmly and, when necessary, apply the parking brake.

Shift Lever Operation

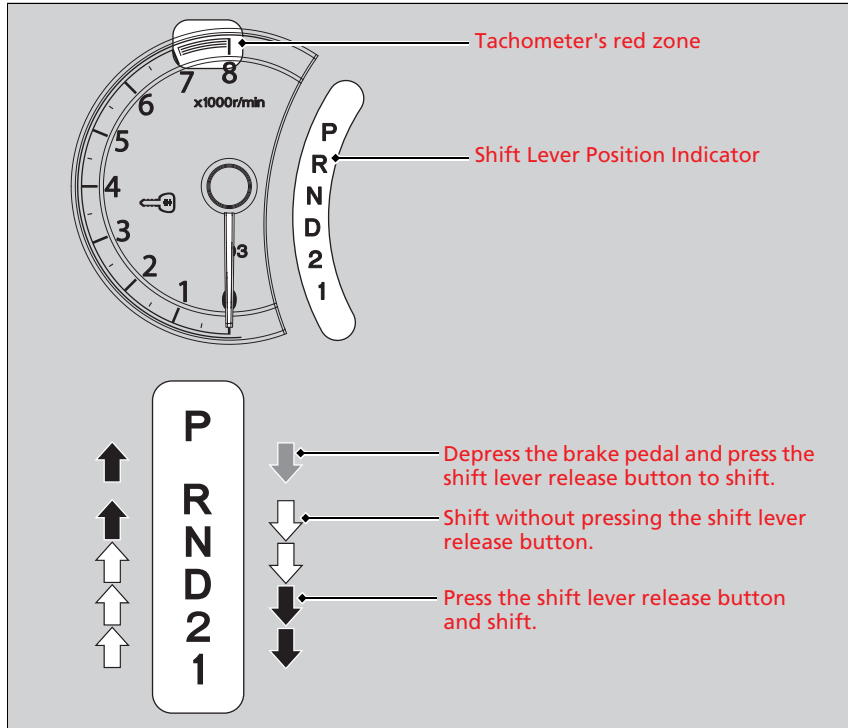

Shift Lever Operation

NOTICE

When you change the shift lever from **D** to **R** and vice versa, come to a complete stop and keep the brake pedal depressed.

Operating the shift lever before the vehicle has come to a complete standstill can damage the transmission.

Use the shift lever position indicator to check the lever position before pulling away.

If the transmission indicator **D** blinks when driving, in any shift position, there is a problem with the transmission.

Avoid sudden acceleration and have the transmission checked by a dealer as soon as possible.

The fuel supply may be cut off if you drive at engine speeds in or over the tachometer's red zone (engine speed limit). If this happens, you may experience a slight jolt.

It may not be possible to operate the shift lever if the brake pedal is depressed while the shift lever release button is pressed.

Depress the brake pedal first.

ECON Button



The **ECON** button turns the ECON mode on and off.

The ECON mode helps you improve your fuel economy by adjusting the performance of the engine, transmission, air conditioning system, and cruise control.

Cruise Control

Maintains a constant vehicle speed without having to keep your foot on the accelerator pedal. Use cruise control on freeways or open roads where you can travel at a constant speed with little acceleration or deceleration.

When to use

- Vehicle speed for cruise control: Desired speed in a range above roughly 25 mph (40 km/h) ~

Always keep sufficient distance between you and the vehicle in front of you.

- Shift positions for cruise control: In **D** or **D3**



How to use

- Press the **CRUISE** button on the steering wheel.

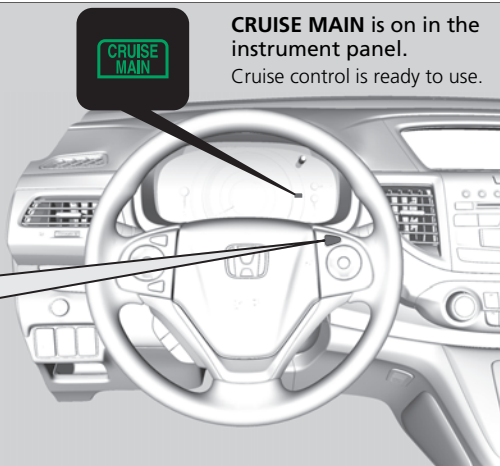

CRUISE MAIN is on in the instrument panel.
Cruise control is ready to use.

⌘ Cruise Control

⚠ WARNING

Improper use of the cruise control can lead to a crash.

Use the cruise control only when traveling on open highways in good weather.

It may not be possible to maintain a constant speed when driving uphill or downhill.

When not using cruise control: Turn off cruise control by pressing the **CRUISE** button.

While in the ECON mode, it may take relatively more time to accelerate to maintain the set speed.

To Set the Vehicle Speed

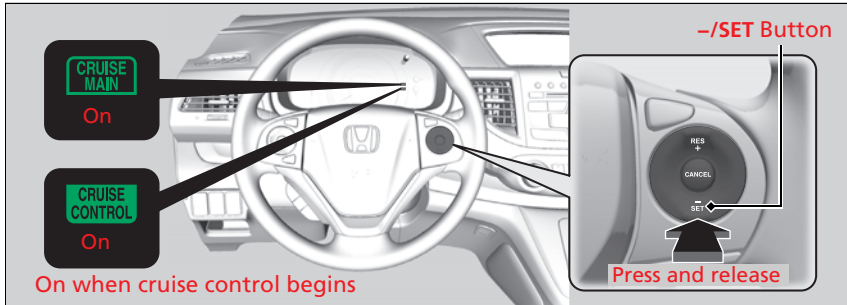

Take your foot off the pedal and press the **-/SET** button when you reach the desired speed.

The moment you release the **-/SET** button, the set speed is fixed, and cruise control begins. The **CRUISE CONTROL** indicator comes on.

■ To Adjust the Vehicle Speed

Increase or decrease the vehicle speed using the **RES/+** or **-/SET** buttons on the steering wheel.

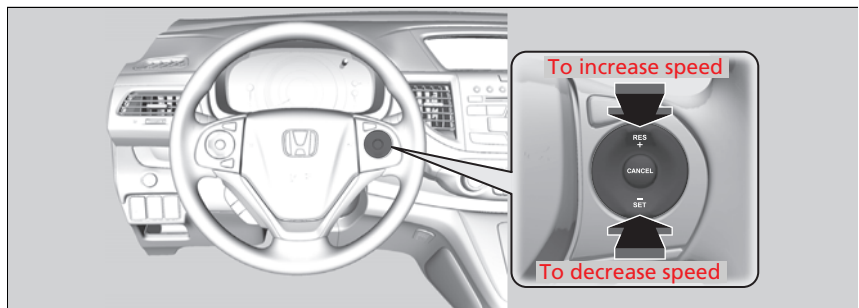

- Each time you press the button, the vehicle speed is increased or decreased by about 1 mph (1.6 km/h).
- If you keep the button pressed, the vehicle speed increases or decreases until you release it. This speed is then set.

■ To Cancel

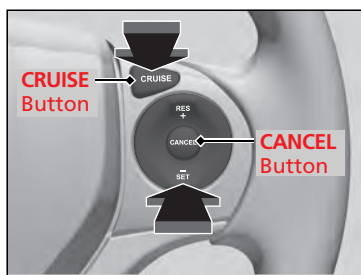

To cancel cruise control, do any of the following:

- Press the **CANCEL** button.
- Press the **CRUISE** button.
- Depress the brake pedal.

The **CRUISE CONTROL** indicator goes off.

▶▶ To Adjust the Vehicle Speed

You can set the vehicle speed using the **-/SET** button on the steering wheel when adjusting the speed with the accelerator and brake pedals.

▶▶ To Cancel

Resuming the prior set speed:
After cruise control has been canceled, you can still resume the prior set speed by pressing the **RES/+** button while driving at a speed of at least 25 mph (40 km/h) or more.

- You cannot set or resume in the following situations:
- When vehicle speed is less than 25 mph (40 km/h)
 - When the **CRUISE** button is turned off

At vehicle speeds of 22 mph (35 km/h) or less, cruise control is canceled automatically.

VSA® (Vehicle Stability Assist), aka ESC (Electronic Stability Control), System

Helps to stabilize the vehicle during cornering if the vehicle turns more or less than what was intended. It also assists in maintaining traction on slippery surfaces. It does so by regulating engine output and selectively applying the brakes.

VSA® Operation

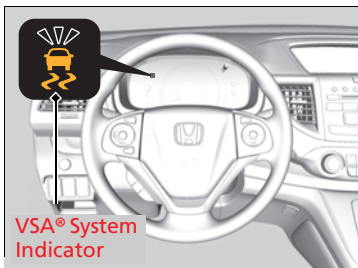

When VSA® activates, you may notice that the engine does not respond to the accelerator. You may also notice some noise from the hydraulic system. You will also see the indicator blink.

VSA® (Vehicle Stability Assist), aka ESC (Electronic Stability Control), System

The VSA® may not function properly if tire types and size are mixed. Make sure to use the same size and types of tire, and the air pressures as specified.

When the VSA® indicator comes on and stays on while driving, there may be a problem with the system. While this may not interfere with normal driving, have your vehicle checked by a dealer immediately.

VSA® cannot enhance stability in all driving situations and does not control the entire braking system. You still need to drive and corner at speeds appropriate for the conditions and always leave a sufficient margin of safety.

The main function of the VSA® system is generally known as Electronic Stability Control (ESC). The system also includes a traction control function.

■ VSA® On and Off

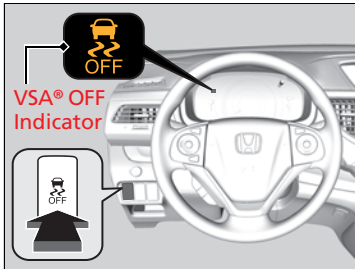

This button is on the driver side control panel. To turn the VSA® system on and off, press and hold it until you hear a beep.

VSA® stops and the indicator comes on.

To turn it on again, press the  (VSA® OFF) button until you hear a beep.

VSA® is turned on every time you start the engine, even if you turned it off the last time you drove the vehicle.

▶▶ VSA® (Vehicle Stability Assist), aka ESC (Electronic Stability Control), System

Without VSA®, your vehicle will have normal braking and cornering ability, but it will not have VSA® traction and stability enhancement.

In certain unusual conditions when your vehicle gets stuck in shallow mud or fresh snow, it may be easier to free it with VSA® temporarily switched off.

When the VSA® system is off, the traction control system is also off. You should only attempt to free your vehicle with VSA® off if you are not able to free it when the system is on.

Immediately after freeing your vehicle, be sure to switch VSA® on again. We do not recommend driving your vehicle with the VSA® and traction control systems switched off.

If the low tire pressure, or TPMS indicator comes on or blinks, the VSA® system comes on automatically. In this case, you cannot turn the system off by pressing the  button.

You may hear a motor sound coming from the engine compartment while system checks are being performed immediately after starting the engine or while driving. This is normal.

Real Time AWD with Intelligent Control System™*

When the system senses a loss of front wheel traction, it automatically transfers some power to the rear wheels. This allows you to utilize all available traction and may increase mobility.

You still need to exercise the same care when accelerating, steering, and braking that you would in a two wheel drive vehicle.

If you excessively spin all four wheels and overheat the AWD system, only the front wheels receive power. Stop until the system cools down.

TPMS (Tire Pressure Monitoring System)



Monitors the tire pressure while you are driving. If your vehicle's tire pressure becomes significantly low, the low tire pressure indicator comes on.

Real Time AWD with Intelligent Control System™*

NOTICE

Do not continuously spin the front tires of your vehicle. Continuously spinning the front tires can cause transmission or rear differential damage.

The AWD system may not function properly if tire type and size are mixed. Make sure to use the same size and type of tire, and the air pressures as specified.

➤ [Tire and Wheel Replacement P. 304](#)

TPMS (Tire Pressure Monitoring System)

Conditions such as low ambient temperature and altitude change directly affect tire pressure and can trigger the low tire pressure indicator to come on.

➤ [If the Low Tire Pressure Indicator Comes On P. 334](#)

Tire pressure checked and inflated in:

- Warm weather can become under-inflated in colder weather.
- Cold weather can become over-inflated in warmer weather.

The low tire pressure indicator will not come on as a result of over inflation.

U.S. models

Tire Pressure Monitoring System (TPMS) - Required Federal Explanation

Each tire, including the spare (if provided), should be checked monthly when cold and inflated to the inflation pressure recommended by the vehicle manufacturer on the vehicle placard or tire inflation pressure label.

(If your vehicle has tires of a different size than the size indicated on the vehicle placard or tire inflation pressure label, you should determine the proper tire inflation pressure for those tires.)

As an added safety feature, your vehicle has been equipped with a tire pressure monitoring system (TPMS) that illuminates a low tire pressure telltale when one or more of your tires is significantly under-inflated.



Accordingly, when the low tire pressure telltale illuminates, you should stop and check your tires as soon as possible, and inflate them to the proper pressure.

Driving on a significantly under-inflated tire causes the tire to overheat and can lead to tire failure. Under-inflation also reduces fuel efficiency and tire tread life, and may affect the vehicle's handling and stopping ability.

ORG

TOC

Driving

Index

Home

Please note that the TPMS is not a substitute for proper tire maintenance, and it is the driver's responsibility to maintain correct tire pressure, even if under-inflation has not reached the level to trigger illumination of the TPMS low tire pressure telltale.

Your vehicle has also been equipped with a TPMS malfunction indicator to indicate when the system is not operating properly. The TPMS malfunction indicator is combined with the low tire pressure telltale. When the system detects a malfunction, the telltale will flash for approximately one minute and then remain continuously illuminated. This sequence will continue upon subsequent vehicle start-ups as long as the malfunction exists.

When the malfunction indicator is illuminated, the system may not be able to detect or signal low tire pressure as intended.

TPMS malfunctions may occur for a variety of reasons, including the installation of replacement or alternate tires or wheels on the vehicle that prevent the TPMS from functioning properly.

Always check the TPMS malfunction telltale after replacing one or more tires or wheels on your vehicle to ensure that the replacement or alternate tires and wheels allow the TPMS to continue to function properly.

Brake System

■ Parking Brake

Use the parking brake to keep the vehicle stationary when parking.

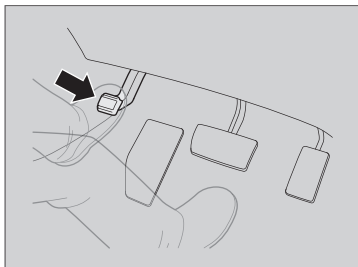

To apply:

Depress the parking brake pedal down with your foot.

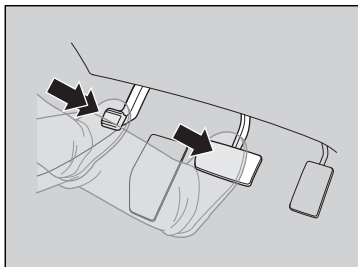

To release:

1. Depress the brake pedal.
2. Depress the parking brake.

☒ Parking Brake

NOTICE

Release the parking brake fully before driving. The rear brakes and axle can be damaged if you drive with the parking brake applied.

If you start driving without fully releasing the parking brake, a buzzer sounds as a warning.

Always apply the parking brake when parking.

To prevent the parking brake from freezing when the outside temperature is extremely cold, do not apply it, but do the following:

Put the shift lever in **P**, then use a block or other wheel chock to stop the wheels from turning.

Foot Brake

Your vehicle is equipped with disc brakes at all four wheels. A vacuum power assist helps reduce the effort needed on the brake pedal. The brake assist system increases the stopping force when you depress the brake pedal hard in an emergency situation. The anti-lock brake system (ABS) helps you retain steering control when braking very hard.

➤ [Brake Assist System](#) P. 257

➤ [ABS \(Anti-lock Brake System\)](#) P. 256

⊞ Foot Brake

Check the brakes after driving through deep water, or if there is a buildup of road surface water. If necessary, dry the brakes by lightly depressing the pedal several times.

If you hear a continuous metallic friction sound when applying the brakes, the brake pads need to be replaced. Have the vehicle checked by a dealer.

Constantly using the brake pedal while going down a long hill builds up heat, which reduces the brake effectiveness. Apply engine braking by taking your foot off the accelerator pedal and downshifting to a lower gear.

Do not rest your foot on the brake pedal while driving, as it will lightly apply the brakes and cause them to lose effectiveness over time and reduce pad life. It will also confuse drivers behind you.

ABS (Anti-lock Brake System)

Helps prevent the wheels from locking up, and helps you retain steering control by pumping the brakes rapidly, much faster than you.

The electronic brake distribution (EBD) system, which is part of the ABS, also balances the front-to-rear braking distribution according to vehicle loading.

You should never pump the brake pedal. Let the ABS work for you by always keeping firm, steady pressure on the brake pedal. This is sometimes referred to as “stomp and steer.”

■ ABS operation

The brake pedal may pulsate slightly when the ABS is working. Keep holding the pedal firmly down. On dry pavement, you need to press on the brake pedal very hard before the ABS activates. However, you may feel the ABS activate immediately if you are trying to stop on snow or ice.

When the vehicle speed goes under 6 mph (10 km/h), the ABS stops.

ⓘ ABS (Anti-lock Brake System)

NOTICE

The ABS may not function correctly if you use an incorrect tire type and size.

When the **ABS** indicator comes on while driving, there may be a problem with the system. While normal braking is not affected, there is a possibility of the ABS not operating. Have the vehicle checked by a dealer immediately.

The ABS does not reduce the time or distance it takes to stop the vehicle. It only helps with steering control during hard braking.

In the following cases, your vehicle may need more stopping distance than a vehicle without the ABS:

- When driving on rough road surfaces, including when driving on uneven surfaces, such as gravel or snow.
- When tire chains are installed.

You may hear a motor sound coming from the engine compartment while system checks are being performed immediately after starting the engine or while driving. This is normal.

Brake Assist System

Designed to assist the driver by generating greater braking force when you depress the brake pedal hard during emergency braking.

■ Brake assist system operation

Depress the brake pedal firmly for more powerful braking.

When brake assist operates, the pedal may wiggle slightly and an operating noise may be heard. This is normal. Keep holding the brake pedal firmly down.

When Stopped

1. Depress the brake pedal firmly with the shift lever in **D**.
2. Firmly apply the parking brake.
3. Move the shift lever from **D** to **P**.
4. Turn off the engine.

Always set the parking brake firmly, in particular if you are parked on an incline.

» Parking Your Vehicle

Do not park your vehicle near flammable objects, such as dry grass, oil, or timber. Heat from the exhaust can cause a fire.

» When Stopped

NOTICE

The following can damage the transmission:

- Depressing the accelerator and brake pedals simultaneously.
- Holding the vehicle in place when facing uphill by depressing the accelerator pedal.
- Moving the shift lever into **P** before the vehicle stops completely.

Raise the wiper arms when snow is expected.

About Your Multi-View Rear Camera

Models with navigation system

See the Navigation System Manual.

Models without navigation system

The multi-information display can display your vehicle's rear view. The display automatically changes to the rear view when the shift lever is moved to **R**.

Multi-View Rear Camera Display Area

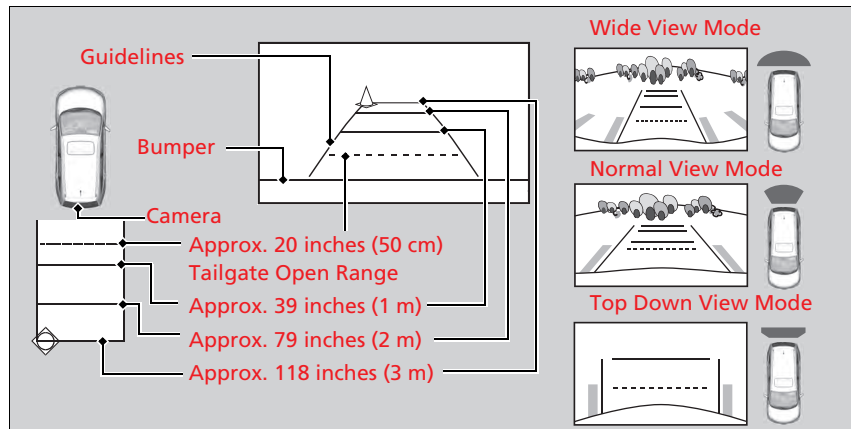

You can view three different camera angles on the rearview display. Press the selector knob to switch the angle.

If the last used viewing mode is Wide or Normal, the same mode is selected the next time you shift into **R**. If Top view was last used, Wide mode is selected.

About Your Multi-View Rear Camera

The rear camera view is restricted. You cannot see the corner ends of the bumper or what is underneath the bumper. Its unique lens also makes objects appear closer or farther than they actually are.

Visually confirm that it is safe to drive before backing up. Certain conditions, such as weather, lighting, and high temperatures, may also restrict the rear view. Do not rely on the rearview display which does not give you all information about conditions at the back of your vehicle.

If the camera lens is covered with dirt or moisture, use a soft, moist cloth to keep the lens clean and free of debris.

Fuel Information

■ Fuel recommendation

Unleaded gasoline, pump octane number 87 or higher

Use of lower octane gasoline can cause a persistent, heavy metallic knocking noise that can lead to engine damage.

■ Top tier detergent gasoline

Because the level of detergency and additives in gasoline vary in the market, Honda endorses the use of “TOP TIER Detergent Gasoline” where available to help maintain the performance and reliability of your vehicle. TOP TIER Detergent Gasoline meets a new gasoline standard jointly established by leading automotive manufacturers to meet the needs of today’s advanced engines.

Qualifying gasoline retailers will, in most cases, identify their gasoline as having met “TOP TIER Detergent Gasoline” standards at the retail location. This fuel is guaranteed to contain the proper level of detergent additives and be free of metallic additives. The proper level of detergent additives, and absence of harmful metallic additives in gasoline, help avoid build-up of deposits in your engine and emission control system.

For further important fuel-related information for your vehicle, or on information on gasoline that does not contain MMT, visit www.hondacars.com. In Canada, visit www.honda.ca for additional information on gasoline. For more information on top tier gasoline, visit www.toptiergas.com.

» Fuel Information

NOTICE

We recommend quality gasoline containing detergent additives that help prevent fuel system and engine deposits. In addition, in order to maintain good performance, fuel economy, and emissions control, we strongly recommend the use of gasoline that does NOT contain harmful manganese-based fuel additives such as MMT, if such gasoline is available.

Use of gasoline with these additives may adversely affect performance, and cause the malfunction indicator lamp on your instrument panel to come on. If this happens, contact a dealer for service.

Some gasoline today is blended with oxygenates such as ethanol. Your vehicle is designed to operate on oxygenated gasoline containing up to 10% ethanol by volume. Do not use gasoline containing methanol. If you notice any undesirable operating symptoms, try another service station or switch to another brand of gasoline.

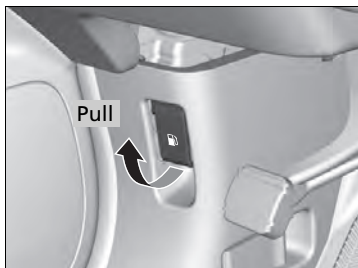
■ Fuel tank capacity: 15.3 US gal (58 liters)**How to Refuel**

1. Stop your vehicle with the service station pump on the left side of the vehicle in the rear.
2. Turn off the engine.
3. Pull on the fuel fill door release handle under the lower left corner of the dashboard.
▶ The fuel fill door opens.

▶ How to Refuel

⚠ WARNING

Gasoline is highly flammable and explosive. You can be burned or seriously injured when handling fuel.

- Stop the engine, and keep heat, sparks, and flame away.
- Handle fuel only outdoors.
- Wipe up spills immediately.

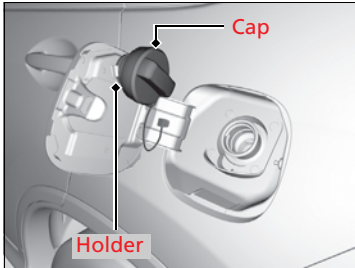
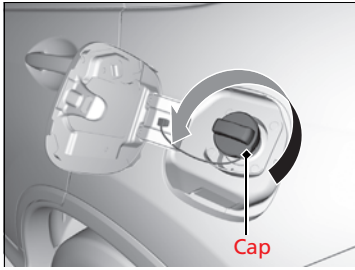

4. Remove the fuel fill cap slowly. If you hear a release of air, wait until this stops, then turn the knob slowly to open the fuel fill cap.

5. Place the fuel fill cap in the holder.

6. Insert the fuel filler nozzle fully.
 ▶ When the tank is full, the filler nozzle will click off automatically. This leaves space in the fuel tank in case the fuel expands with a change in the temperature.

7. After filling, replace the fuel fill cap, tightening it until you hear it click at least once.
 ▶ Shut the fuel fill door by hand.

▶▶ How to Refuel

The filler nozzle automatically stops to leave space in the fuel tank so that fuel does not overflow as a result of changes in air temperature.

If the filler nozzle keeps turning off when the tank is not full, there may be a problem with the pump's fuel vapor recovery system. Try filling at another pump. If this does not fix the problem, consult a dealer.

Do not continue to add fuel after the filler nozzle has automatically stopped. Additional fuel can exceed the full tank capacity.

Improving Fuel Economy

Fuel economy depends on several conditions, including driving conditions, your driving habits, the condition of your vehicle, and loading. Depending on these and other conditions, you may or may not achieve the rated fuel economy of this vehicle.

Maintenance and Fuel Economy

You can optimize your fuel economy with proper maintenance of your vehicle. Always maintain your vehicle in accordance with the messages displayed on the information display/multi-information display.

- Use the recommended viscosity engine oil, displaying the API Certification Seal.
- Maintain the specified tire pressure.
- Do not load the vehicle with excess cargo.
- Keep your vehicle clean. A buildup of snow or mud on your vehicle's underside adds weight and increases wind resistance.

Improving Fuel Economy

Direct calculation is the recommended method to determine actual fuel consumed while driving.

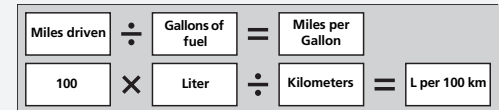

In Canada, posted fuel economy numbers are established following a simulated test. For more information on how this test is performed, please visit <http://oee.nrcan.gc.ca/>

Accessories

When installing accessories, check the following:

- Do not install accessories on the windshield. They can obstruct your view and delay your reaction to driving conditions.
- Do not install accessories on the side pillars or across the side windows. Accessories installed in these areas may interfere with proper operation of the side curtain airbags.
- Be sure electronic accessories do not overload electrical circuits or interfere with proper operation of your vehicle.
[Fuses P. 335](#)
- Before installing any electronic accessory, have the installer contact a dealer for assistance. If possible, have a dealer inspect the final installation.

Accessories and Modifications

WARNING

Improper accessories or modifications can affect your vehicle's handling, stability, and performance, and cause a crash in which you can be seriously hurt or killed.

Follow all instructions in this owner's manual regarding accessories and modifications.

Honda Genuine accessories are recommended to ensure proper operation on your vehicle.

Modifications

Do not modify your vehicle or use non-Honda components that can affect its handling, stability, and reliability.

Overall vehicle performance can be affected. Always make sure all equipment is properly installed and maintained, and that it meets federal, state, province, territory, and local regulations.

Maintenance

This chapter discusses basic maintenance.



Before Performing Maintenance		
Inspection and Maintenance	266	
Safety When Performing Maintenance.....	267	
Parts and Fluids Used in Maintenance Service	268	
Maintenance Minder™	269	
Maintenance Under the Hood		
Maintenance Items Under the Hood.....	275	
Opening the Hood	276	
Recommended Engine Oil	277	
Oil Check	278	
Adding Engine Oil	279	
Changing the Engine Oil and Oil Filter	280	
Engine Coolant.....	282	
Transmission Fluid.....	284	
Brake Fluid.....	285	
Refilling Window Washer Fluid.....	286	
Replacing Light Bulbs	287	
Checking and Maintaining Wiper Blades	294	
Checking and Maintaining Tires		
Checking Tires	298	
Tire and Loading Information Label.....	299	
Tire Labeling	299	
DOT Tire Quality Grading (U.S. Vehicles).....	301	
Wear Indicators.....	303	
Tire Service Life.....	303	
Tire and Wheel Replacement	304	
Tire Rotation	305	
Winter Tires	306	
Battery	307	
Remote Transmitter Care		
Replacing the Button Battery	308	
Remote Control and Wireless Headphone Care*	309	
Heating and Cooling System*/Climate Control System* Maintenance	311	
Cleaning		
Interior Care	312	
Exterior Care.....	314	

* Not available on all models

Inspection and Maintenance

For your safety, perform all listed inspections and maintenance to keep your vehicle in good condition. If you become aware of any abnormality (noise, smell, insufficient brake fluid, oil residue on the ground, etc.), have your vehicle inspected by a dealer. (Note, however, that service at a dealer is not mandatory to keep your warranties in effect.) Refer to the separate maintenance booklet for detailed maintenance and inspection information.

Types of Inspection and Maintenance

Daily inspections

Perform inspections before long distance trips, when washing the vehicle, or when refueling.

Periodic inspections

- Check the automatic transmission fluid level monthly.
[Automatic Transmission Fluid P. 284](#)
- Check the brake fluid level monthly.
[Checking the Brake Fluid P. 285](#)
- Check the tire pressure monthly. Examine the tread for wear and foreign objects.
[Checking and Maintaining Tires P. 298](#)
- Check the operation of the exterior lights monthly.
[Replacing Light Bulbs P. 287](#)
- Check the condition of the wiper blades at least every six months.
[Checking and Maintaining Wiper Blades P. 294](#)

Inspection and Maintenance

U.S. models

Maintenance, replacement, or repair of emissions control devices and systems may be done by any automotive repair establishment or individuals using parts that are "certified" to EPA standards.

According to state and federal regulations, failure to perform maintenance on the maintenance main items marked with # will not void your emissions warranties. However, all maintenance services should be performed in accordance with the intervals indicated by the information display/multi-information display.

[Maintenance Service Items P. 272](#)

If you want to perform complex maintenance tasks that require more skills and tools, you can purchase a subscription to the Service Express website at www.techinfo.honda.com.

[Authorized Manuals P. 351](#)

If you want to perform maintenance yourself, make sure that you have the necessary tools and skills first. After performing maintenance, update the records in the separate maintenance booklet.

Safety When Performing Maintenance

Some of the most important safety precautions are given here. However, we cannot warn you of every conceivable hazard that can arise in performing maintenance. Only you can decide whether or not you should perform a given task.

Maintenance Safety

- To reduce the possibility of fire or explosion, keep cigarettes, sparks, and flames away from the battery and all fuel related parts.
- Never leave rags, towels, or other flammable objects under the hood.
 - ▶ Heat from the engine and exhaust can ignite them causing a fire.
- To clean parts, use a commercially available degreaser or parts cleaner, not gasoline.
- Wear eye protection and protective clothing when working with the battery or compressed air.
- Engine exhaust contains carbon monoxide, which is poisonous and can kill you.
 - ▶ Only operate the engine if there is sufficient ventilation.

Vehicle Safety

- The vehicle must be in a stationary condition.
 - ▶ Make sure your vehicle is parked on level ground, the parking brake is set, and the engine is off.
- Be aware that hot parts can burn you.
 - ▶ Make sure to let the engine and exhaust system cool thoroughly before touching vehicle parts.
- Be aware that moving parts can injure you.
 - ▶ Do not start the engine unless instructed, and keep your hands and limbs away from moving parts.

⚠ Safety When Performing Maintenance

⚠ WARNING

Improperly maintaining this vehicle or failing to correct a problem before driving can cause a crash in which you can be seriously hurt or killed.

Always follow the inspection and maintenance recommendations according to the schedules in this owner's manual.

⚠ WARNING

Failure to properly follow maintenance instructions and precautions can cause you to be seriously hurt or killed.

Always follow the procedures and precautions in this owner's manual.

Parts and Fluids Used in Maintenance Service

The use of Honda genuine parts and fluids is recommended when maintaining and servicing your vehicle. Honda genuine parts are manufactured according to the same high quality standards used in Honda vehicles.

If the engine oil life is less than 15%, you will see the Maintenance Minder messages appear on the information display and the multi-information display every time you turn the ignition switch to ON **II**. The messages notify you when to change the engine oil, or when to bring your vehicle to a dealer for indicated maintenance services.

To Use Maintenance Minder™

■ Displaying the Engine Oil Life on the Information Display

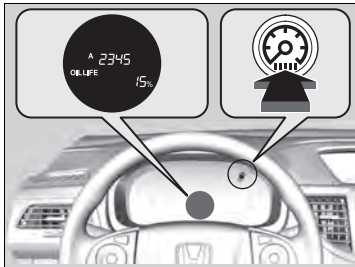

1. Turn the ignition switch to ON **II**.
2. Press the (Select/Reset) knob repeatedly until the engine oil life appears on the information display.

The Maintenance Minder indicator () stays on in the instrument panel after the engine oil life becomes 0%. Have the indicated maintenance done by a dealer immediately.

▣ To Use Maintenance Minder™

Based on the engine operating conditions, the remaining engine oil life is calculated and displayed as a percentage.

Displayed Engine Oil Life (%)	Calculated Engine Oil Life (%)
100	100 to 91
90	90 to 81
80	80 to 71
70	70 to 61
60	60 to 51
50	50 to 41
40	40 to 31
30	30 to 21
20	20 to 16
15	15 to 11
10	10 to 6
5	5 to 1
0	0



There is a list of maintenance main and sub items you can view on the multi-information display.

[➤ Maintenance Service Items P. 272](#)

■ Displaying the Engine Oil Life and Maintenance Items on the Multi-information Display





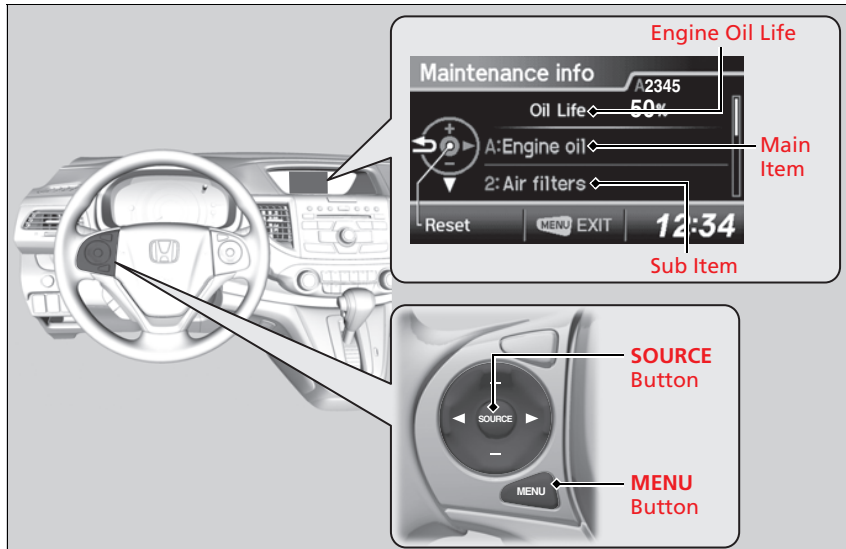

Maintenance items, which should be serviced at the same time that you replace the engine oil, appear on the multi-information display.

You can view them on the **Maintenance info** screen at any time.

1. Turn the ignition switch to ON .
2. Press the **MENU** button to go to the **Vehicle Menu** screen.
3. Select **Vehicle Information** with the , then press the **SOURCE** button.
4. Press the **SOURCE** button again to go to the **Maintenance info** screen. The engine oil life appears on the multi-information display.

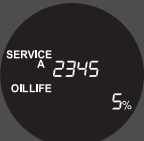

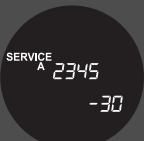
Maintenance Minder Messages on the Multi-Information Display and Information Display

Oil Life Display on the Information Display	Oil Life Display	Explanation	Information	Maintenance Minder Indicator
	<p>15%</p> 	<p>The engine oil life indicator starts to appear along with other due soon maintenance item codes when the remaining oil life becomes 15 percent.</p>	<p>The engine oil is approaching the end of its service life.</p>	 <p>Starts to come on when the remaining engine oil life becomes 15 percent.</p>
	<p>5%</p> 	<p>The SERVICE message also starts to appear along with the engine oil life indicator and the maintenance item codes.</p>	<p>The engine oil has almost reached the end of its service life, and the maintenance items should be inspected and serviced as soon as possible.</p>	<p>It goes off when the display is switched.</p>
	<p>—</p>	<p>The remaining engine oil life has passed its service life, and a negative distance appears after driving over 10 miles (U.S. models) or 10 km (Canadian models). The negative distance on the display blinks.</p>	<p>The engine oil life has passed. The maintenance items must be inspected and serviced immediately.</p>	 <p>Stays on as a reminder even when the display is switched.</p>

Maintenance Service Items

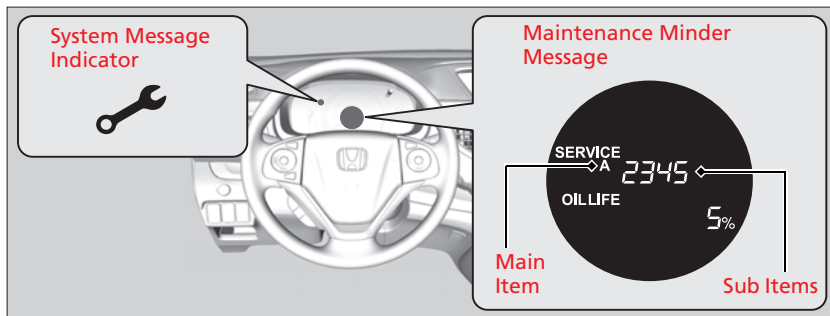

Maintenance Service Items

- Independent of the Maintenance Minder information, replace the brake fluid every 3 years.
- Inspect idle speed every 160,000 miles (256,000 km).
- Adjust the valves during services A, B, 1, 2, or 3 if they are noisy.

CODE	Maintenance Main Items
A	<ul style="list-style-type: none"> • Replace engine oil*¹
B	<ul style="list-style-type: none"> • Replace engine oil*¹ and oil filter • Inspect front and rear brakes • Check parking brake adjustment • Inspect tie rod ends, steering gearbox, and boots • Inspect suspension components • Inspect driveshaft boots • Inspect brake hoses and lines (Including ABS/VSA) • Inspect all fluid levels and condition of fluids • Inspect exhaust system[#] • Inspect fuel lines and connections[#]

CODE	Maintenance Sub Items
1	<ul style="list-style-type: none"> • Rotate tires
2	<ul style="list-style-type: none"> • Replace air cleaner element*² • Replace dust and pollen filter*³ • Inspect drive belt
3	<ul style="list-style-type: none"> • Replace transmission fluid*⁴
4	<ul style="list-style-type: none"> • Replace spark plugs • Inspect valve clearance
5	<ul style="list-style-type: none"> • Replace engine coolant
6	<ul style="list-style-type: none"> • Replace rear differential fluid*

*1: If a message **SERVICE** does not appear more than 12 months after the display is reset, change the engine oil every year.
 #: See information on maintenance and emissions warranty.





*2: If you drive in dusty conditions, replace the air cleaner element every 15,000 miles (24,000 km).
 *3: If you drive primarily in urban areas that have high concentrations of soot in the air from industry and from diesel-powered vehicles, replace the dust and pollen filter every 15,000 miles (24,000 km).
 *4: If you tow your vehicle behind a motorhome, the transmission fluid must be changed every 2 years or 30,000 miles (48,000 km), whichever comes first.

Resetting the Display

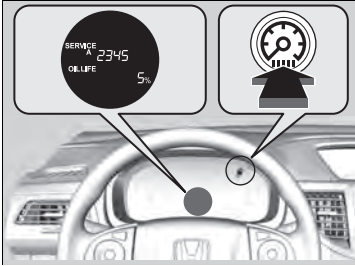
Reset the engine oil life display if you have performed the maintenance service.

On the information display



1. Turn the ignition switch to ON .
2. Display the engine oil life by repeatedly pressing the  (Select/Reset) knob.
3. Press and hold the  knob for ten seconds or more.
 - ▶ The engine oil life indicator and the maintenance item codes blink.
4. Press the  knob for five seconds or more.
 - ▶ The displayed maintenance items disappear, and the engine oil life display returns to 100%.

Resetting the Display



NOTICE

Failure to reset the engine oil life after a maintenance service results in the system showing incorrect maintenance intervals, which can lead to serious mechanical problems.

The dealer will reset the engine oil life display after completing the required maintenance service. If someone other than a dealer performs maintenance service, reset the engine oil life display yourself.

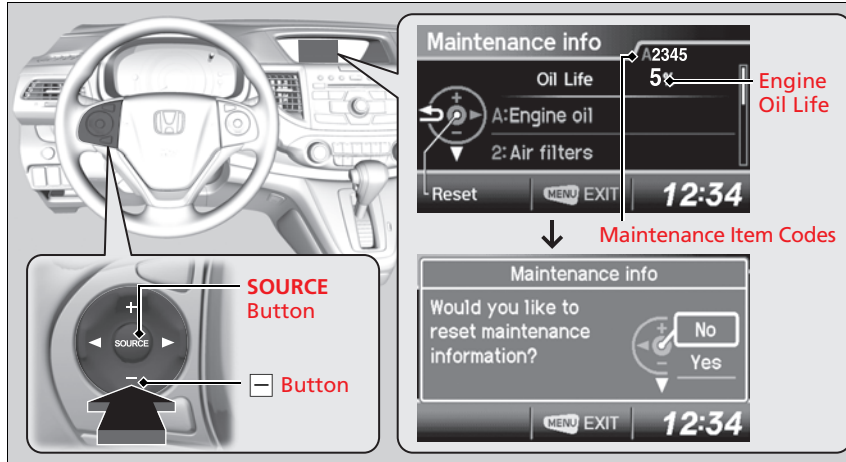
On the multi-information display



1. Turn the ignition switch to ON .
2. Go to the **Maintenance info** screen.
 - ▶ **Displaying the Engine Oil Life and Maintenance Items on the Multi-information Display** P. 270
3. Press the **SOURCE** button.
 - ▶ The oil life reset mode is displayed on the multi-information display.
4. Select **Yes** with the , then press the **SOURCE** button.
 - ▶ The displayed maintenance items disappear, and the engine oil life display returns to 100%.
 - ▶ Any maintenance items that are necessary for your vehicle at the next maintenance service will appear.

To cancel the oil life reset mode, select **No**, then press the **SOURCE** button.

Maintenance Items Under the Hood

ORG

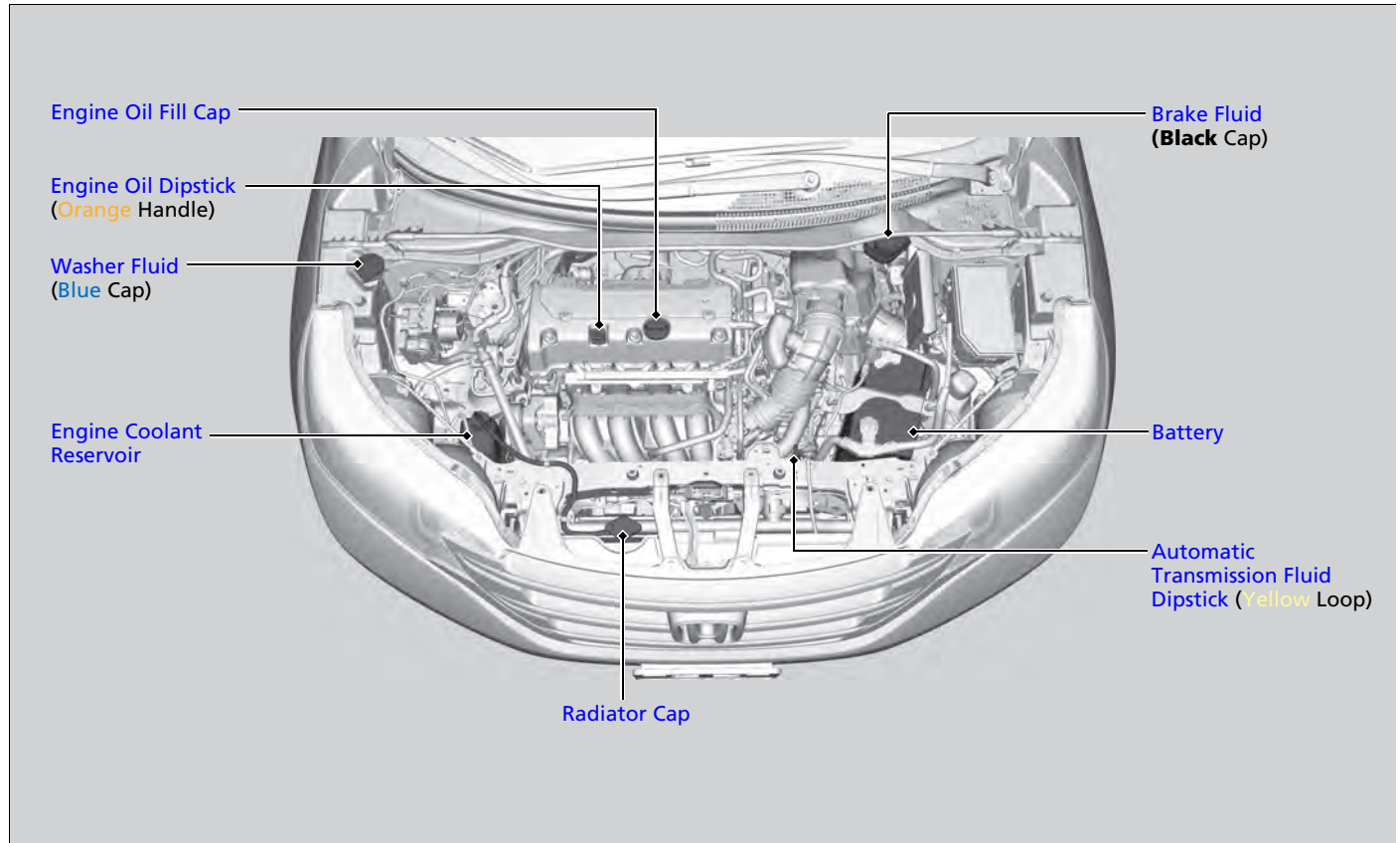

TOC

Maintenance

Index

Home

Opening the Hood

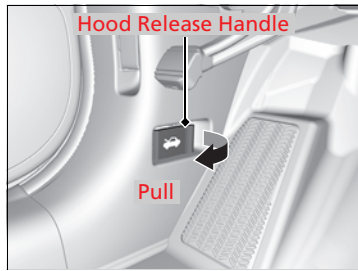

1. Park the vehicle on a level surface, and set the parking brake.
2. Pull the hood release handle under the lower left corner of the dashboard.
 - The hood will pop up slightly.

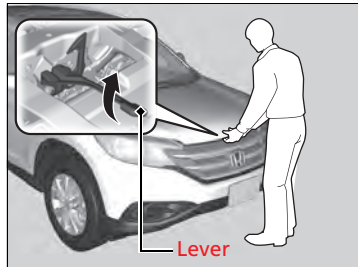

3. Push up the hood latch lever in the center of the hood to release the lock mechanism, and open the hood.

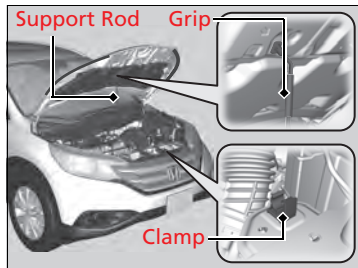

4. Remove the support rod from the clamp using the grip. Mount the support rod in the hood.

When closing, remove the support rod, and stow it in the clamp, then gently lower the hood. Remove your hand at a height of approximately 12 inches (30 cm) and let the hood close.

►► Opening the Hood

NOTICE

Do not open the hood when the wiper arms are raised.

The hood will strike the wipers, and may damage either the hood or the wipers.

When closing the hood, check that the hood is securely latched.

If the hood latch lever moves stiffly, or if you can open the hood without lifting the lever, the latch mechanism should be cleaned and lubricated.

Recommended Engine Oil

- **Genuine Honda Motor Oil**
- **Premium-grade 0W-20 detergent oil with an API Certification Seal on the container.**



Oil is a major contributor to your engine's performance and longevity. If you drive the vehicle with insufficient or deteriorated oil, the engine may fail or be damaged.

This seal indicates the oil is energy conserving and that it meets the American Petroleum Institute's latest requirements.

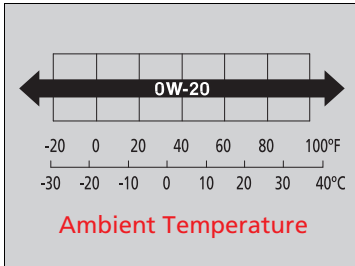

Use a Genuine Honda Motor Oil or another commercial engine oil of suitable viscosity for the ambient temperature as shown.

■ Synthetic oil

You may also use synthetic motor oil if it is labeled with the API Certification Seal and is the specified viscosity grade.

☒ Recommended Engine Oil

Engine Oil Additives

Your vehicle does not require oil additives. In fact, they may adversely affect the engine performance and durability.

Oil Check

We recommend that you check the engine oil level every time you refuel. Park the vehicle on level ground.

Wait approximately three minutes after turning the engine off before you check the oil.

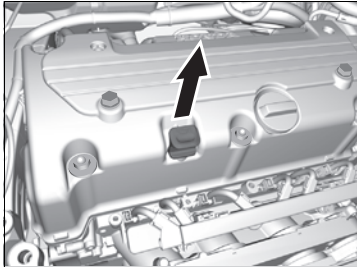

1. Remove the dipstick (orange handle).
2. Wipe the dipstick with a clean cloth or paper towel.
3. Insert the dipstick back all the way into its hole.
4. Remove the dipstick again, and check the level. It should be between the upper and lower marks. Add oil if necessary.

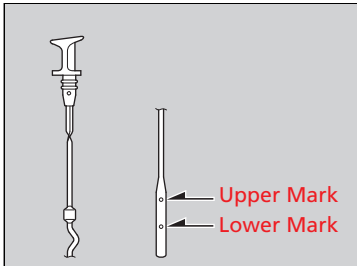

Oil Check

If the oil level is near or below the lower mark, slowly add oil being careful not to overfill.

Adding Engine Oil

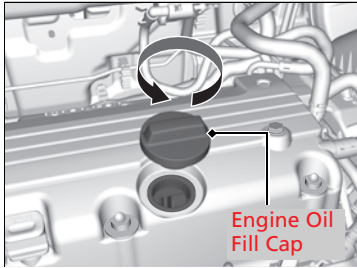

1. Unscrew and remove the engine oil fill cap.
2. Add oil slowly.
3. Reinstall the engine oil fill cap, and tighten it securely.
4. Wait for three minutes and recheck the engine oil dipstick.

⊠ Adding Engine Oil

If any oil spills, wipe it up immediately. Spilled oil may damage the engine compartment components.

NOTICE

Do not fill the engine oil above the upper mark. Overfilling the engine oil can result in leaks and engine damage.

Changing the Engine Oil and Oil Filter

You must change the engine oil and oil filter regularly in order to maintain the engine's lubrication. The engine may be damaged if they are not changed regularly.

Change the oil and filter in accordance with the maintenance message on the information display/multi-information display.

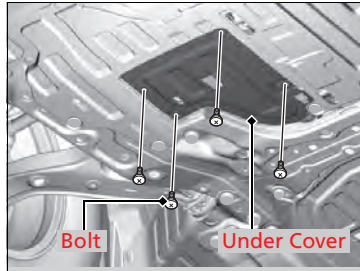

1. Run the engine until it reaches normal operating temperature, and then turn the engine off.
2. Open the hood and remove the engine oil fill cap.
3. Remove the bolts on the undercarriage and remove the under cover.
4. Remove the drain bolt and washer from the bottom of the engine, and drain the oil into a suitable container.

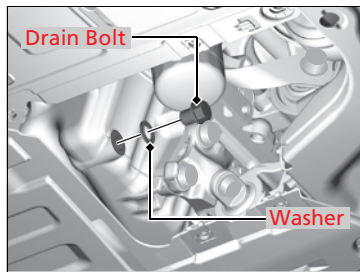

Changing the Engine Oil and Oil Filter

NOTICE

You may damage the environment if you do not dispose of the oil in a suitable way. If you are changing the oil by yourself, appropriately dispose of the used oil. Put the oil in a sealed container and take it to a recycling center. Do not throw the oil away into a garbage can or onto the ground.

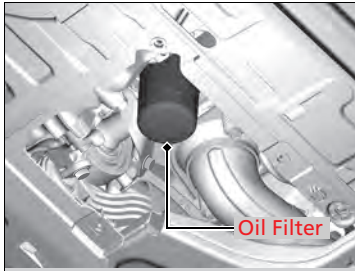

5. Remove the oil filter and dispose of the remaining oil.
6. Check that the filter gasket is not stuck to the engine contact surface.
 - If it is stuck, you must detach it.
7. Wipe away dirt and dust adhering to the contact surface of the engine block, and install a new oil filter.
 - Apply a light coat of new engine oil to the oil filter gasket.
8. Put a new washer on the drain bolt, then reinstall the drain bolt.
 - Tightening torque:
30 lbf·ft (40 N·m, 4.0 kgf·m)
9. Pour the recommended engine oil into the engine.
 - Engine oil change capacity (including filter):
4.2 US qt (4.0 L)
10. Reinstall the engine oil fill cap securely and start the engine.
11. Run the engine for a few minutes, and then check that there is no leak from the drain bolt or oil filter.
12. Stop the engine, wait for three minutes, and then check the oil level on the dipstick.
 - If necessary, add more engine oil.

✘ Changing the Engine Oil and Oil Filter

You will need a special wrench to replace the oil filter. You can buy this wrench from a dealer.

When installing the new oil filter, follow the instructions supplied with the oil filter.

Reinstall the engine oil fill cap. Start the engine. The low oil pressure indicator should go off within five seconds. If it does not, turn off the engine, and check your work.

Engine Coolant

Specified coolant: Honda Long Life Antifreeze/Coolant Type 2

This coolant is premixed with 50% antifreeze and 50% water. Do not add any straight antifreeze or water.

We recommend you check the engine coolant level every time you refuel. Check the reserve tank first. If it is completely empty, also check the coolant level in the radiator. Add the engine coolant accordingly.

Reserve Tank

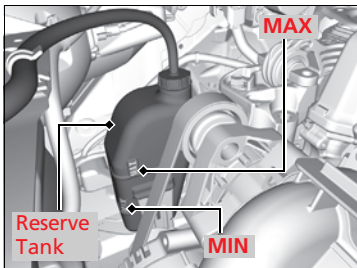

1. Check the amount of coolant in the reserve tank.

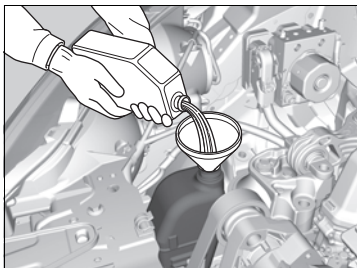

2. If the coolant level is below the **MIN** mark, add the specified coolant until it reaches the **MAX** mark.
3. Inspect the cooling system for leaks.

Engine Coolant

NOTICE

If temperatures consistently below -22°F (-30°C) are expected, the coolant mixture should be changed to a higher concentration. Consult a dealer for more information.

If Honda antifreeze/coolant is not available, you may use another major brand non-silicate coolant as a temporary replacement. Check that it is a high quality coolant recommended for aluminum engines. Continued use of any non-Honda coolant can result in corrosion, causing the cooling system to malfunction or fail. Have the cooling system flushed and refilled with Honda antifreeze/coolant as soon as possible.

Do not add rust inhibitors or other additives to your vehicle's coolant system. They may not be compatible with the coolant or with the engine components.

Radiator

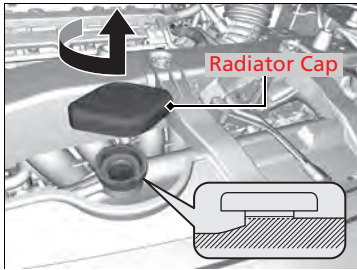

1. **Make sure the engine and radiator are cool.**
2. Turn the radiator cap counterclockwise and relieve any pressure in the coolant system. Do not push the cap down when turning.
3. Push down and turn the radiator cap counterclockwise to remove it.
4. The coolant level should be up to the base of the filler neck. Add coolant if it is low.
5. Put the radiator cap back on, and tighten it fully.
6. Pour coolant into the reserve tank until it reaches the **MAX** mark. Put the cap back on the reserve tank.

Radiator

⚠ WARNING

Removing the radiator cap while the engine is hot can cause the coolant to spray out, seriously scalding you.

Always let the engine and radiator cool down before removing the radiator cap.

NOTICE

Pour the fluid slowly and carefully so you do not spill any. Clean up any spills immediately; they can damage components in the engine compartment.

Transmission Fluid

Automatic Transmission Fluid

Specified fluid: Honda ATF DW-1 (automatic transmission fluid)

Check the fluid level when the engine is at normal operating temperature.

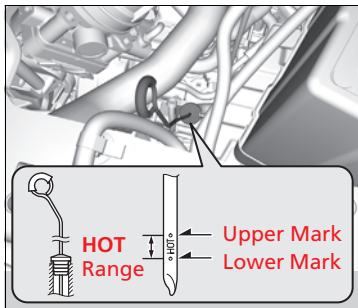

1. Park on level ground, and start the engine.
2. Wait until the radiator fan starts and then turn off the engine.
 - Perform step 3 after waiting for about 60 seconds (less than 90 seconds).
3. Remove the dipstick (yellow loop) from the transmission and wipe it with a clean cloth.
4. Insert the dipstick all the way back into the transmission securely, as shown in the image.
5. Remove the dipstick and check the fluid level.
 - It should be between the upper and lower marks in the **HOT** range.
6. If the level is below the lower mark, add fluid into the dipstick hole to bring it to the level between the upper and lower marks, and have your vehicle checked by a dealer immediately.

Automatic Transmission Fluid

NOTICE

Do not mix Honda ATF DW-1 with other transmission fluids.

Using a transmission fluid other than Honda ATF

DW-1 may adversely affect the operation and durability of your vehicle's transmission, and damage the transmission.

Any damage caused by using a transmission fluid that is not equivalent to Honda ATF DW-1 is not covered by Honda's new vehicle warranty.

NOTICE

Pour the fluid slowly and carefully so you do not spill any. Clean up any spills immediately; they can damage components in the engine compartment.

Brake Fluid

Specified fluid: Honda Heavy Duty Brake Fluid DOT 3

Checking the Brake Fluid

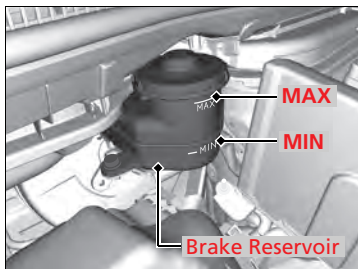

The fluid level should be between the **MIN** and **MAX** marks on the side of the reservoir.

Brake Fluid

NOTICE

Brake fluid marked DOT 5 is not compatible with your vehicle's braking system and can cause extensive damage.

If the specified brake fluid is not available, you should use only DOT 3 or DOT 4 fluid from a sealed container as a temporary replacement.

Using any non-Honda brake fluid can cause corrosion and decrease the longevity of the system. Have the brake system flushed and refilled with Honda Heavy Duty Brake Fluid DOT 3 as soon as possible.

If the brake fluid level is at or below the **MIN** mark, have a dealer inspect for leaks or worn brake pads as soon as possible.

Refilling Window Washer Fluid

Check the amount of window washer fluid using the washer fluid level gauge on the cap.

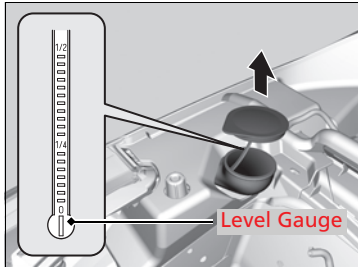

If the level is low, fill the washer reservoir.

► Refilling Window Washer Fluid

NOTICE

Do not use engine antifreeze or a vinegar/water solution in the windshield washer reservoir. Antifreeze can damage your vehicle's paint. A vinegar/water solution can damage the windshield washer pump.

Models with washer level sensor

If the washer fluid is low, the indicator appears on the instrument panel.

Pour the washer fluid carefully. Do not overflow the reservoir.

Headlight Bulbs

When replacing, use the following bulbs.

High/Low beam headlight: 60/55W (H4/HB2)

High/Low Beam Headlight

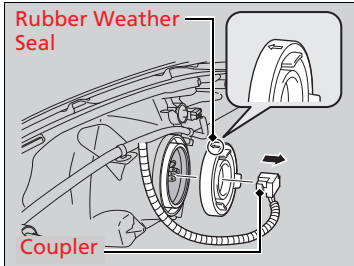

1. Remove the coupler.
2. Remove the rubber weather seal.

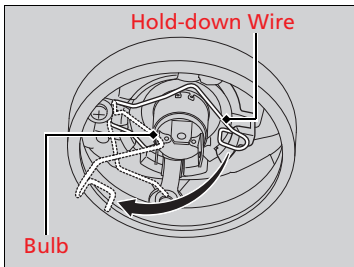

3. Remove the hold-down wire, then remove the bulb.
4. Insert a new bulb.

Headlight Bulbs

NOTICE

Halogen bulbs get very hot when lit.

Oil, perspiration, or a scratch on the glass can cause the bulb to overheat and shatter.

The headlight aim is set by the factory, and does not need to be adjusted. However, if you regularly carry heavy items in the cargo area or tow a trailer, have the aiming readjusted at a dealer or by a qualified technician.

The H4/HB2 type is halogen bulb.

When replacing a bulb, handle it by its base, and protect the glass from contact with your skin or hard objects. If you touch the glass, clean it with denatured alcohol and a clean cloth.

The exterior lights' inside lenses (headlights, brake lamps, etc.) may fog temporarily after a car wash or while driving in the rain. This does not impact the exterior light function.

However, if you see a large amount of water or ice accumulated inside the lenses, have your vehicle inspected by a dealer.

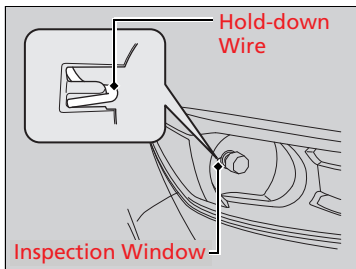

5. Reinstall the hold-down wire. Hook the end of the wire on the knob in the slot.
 - You can see if the hold-down wire is in the right place from the inspection window.
6. Reinstall the rubber weather seal.
7. Insert the coupler into the connector of the bulb.

Fog Light Bulbs*

When replacing, use the following bulbs.

Fog Light: 55 W (H11)

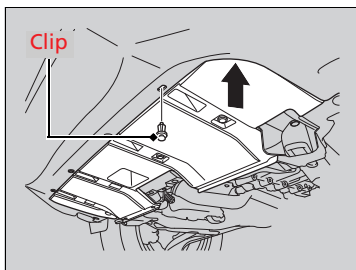

1. Remove the clip using a flat-tip screwdriver, and push up the under cover.

► Fog Light Bulbs*

NOTICE

Halogen bulbs get very hot when lit. Oil, perspiration, or a scratch on the glass can cause the bulb to overheat and shatter.

The fog lights are halogen bulbs. When replacing a bulb, handle it by its plastic case, and protect the glass from contact with your skin or hard objects. If you touch the glass, clean it with denatured alcohol and a clean cloth.

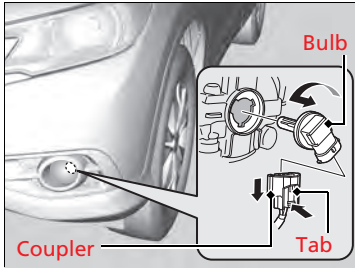

2. Push the tab to remove the coupler.
3. Rotate the old bulb to the left to remove.
4. Insert new bulb.

Side Marker Light Bulb

When replacing, use the following bulbs.

Side Marker Light: 3 CP

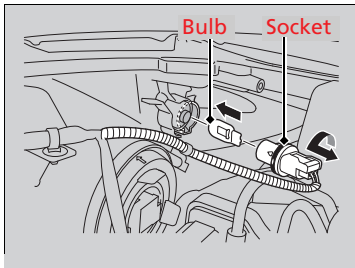

1. Turn the socket to the left and remove it, then remove the old bulb.
2. Insert a new bulb.

☒ Fog Light Bulbs*

Insert a flat-tip screwdriver, lift and remove the central pin to remove the clip.

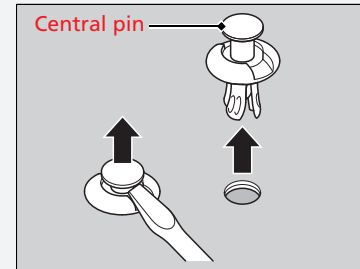

Insert the clip with the central pin raised, and push until it is flat.

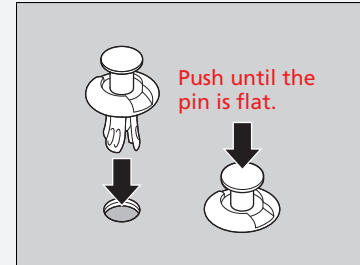

* Not available on all models

Front Turn Signal/Parking Light Bulbs

When replacing, use the following bulbs.

Front Turn Signal/Parking: 24/2.2CP

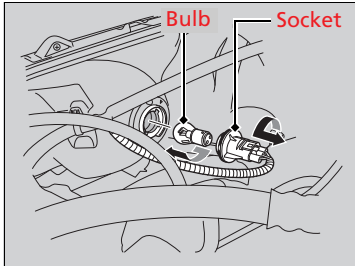

1. Turn the socket to the left and remove it.
2. Push in the old bulb, rotate to the left until it unlocks, and remove.
3. Insert new bulb.

Brake Light, Taillight, Back-Up Light, Rear Turn Signal Light and Lower Rear Side Marker Light Bulbs

When replacing, use the following bulbs.

Lower Rear Side Marker/Brake/Taillight: 21/5 W

Back-Up Light: 21 W

Rear Turn Signal Light: 21 W (Amber)

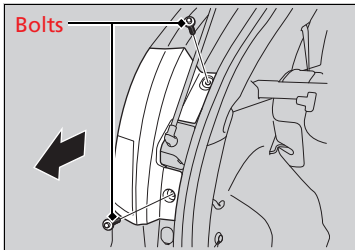

1. Use a Phillip-head screwdriver to remove the bolts.
2. Pull the light assembly out of the rear pillar.

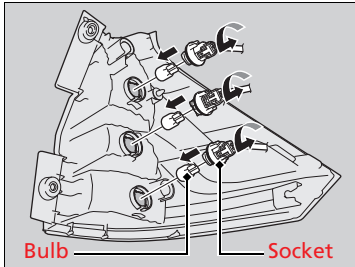

3. Turn the socket to the left and remove it.
Remove the old bulb.
4. Insert a new bulb.

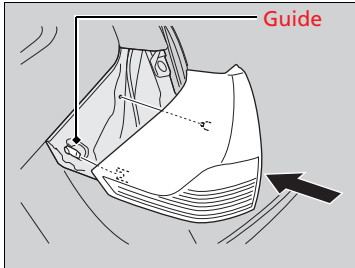

5. Reinstall the light assembly by sliding it on to the guide on the body.

Upper Rear Side Marker/Taillight

When replacing, use the following bulbs.

Upper Rear Side Marker/Taillight: 3CP

1. Remove the lower taillight assembly.

[▶ Brake Light, Taillight, Back-Up Light, Rear Turn Signal Light and Lower Rear Side Marker Light Bulbs P. 290](#)

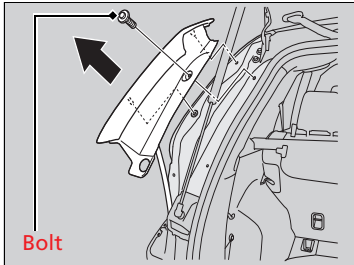

2. Use a Phillip-head screwdriver to remove the bolt.

3. Pull the light assembly out of the rear pillar.

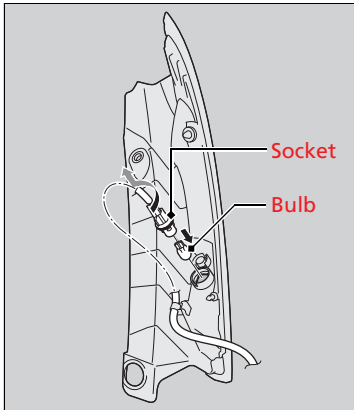

4. Turn the socket to the left and remove it. Remove the old bulb.

5. Insert a new bulb.

Rear License Plate Light Bulb

When replacing, use the following bulb.

Rear License Plate Light: 3 CP

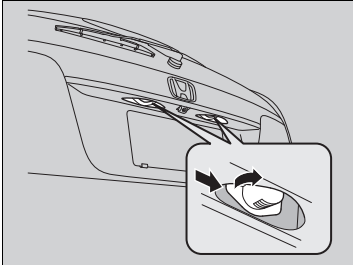

1. Push the left edge of the lens to the right and pull out the licence light assembly.

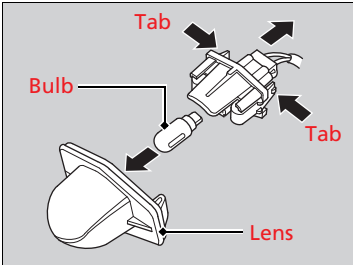

2. Push the tabs to remove the lens.
3. Remove the old bulb.
4. Insert a new bulb.

High-Mount Brake Light Bulb

High-mount brake light bulbs are LED type. Have an authorized Honda dealer inspect and replace the light bulbs.

Checking Wiper Blades

If the wiper blade rubber has deteriorated, it will leave streaks and the metal wiper arm may scratch the window glass.

Changing the Front Wiper Blade Rubber

Changing the Front Wiper Blade Rubber

NOTICE

Avoid dropping the wiper arm; it may damage the windshield.

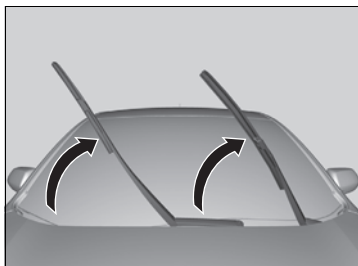

1. Lift the driver side wiper arm first, then the passenger side.

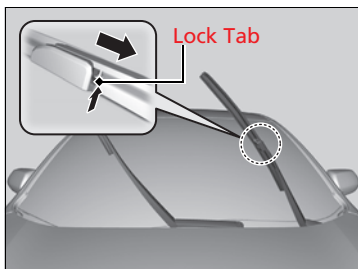

2. Push the lock tab up.
3. Slide the blade from the wiper arm.

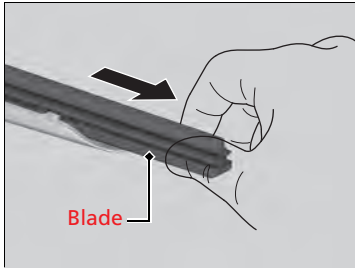

4. Slide the wiper blade out from its holder by pulling the tabbed end out.

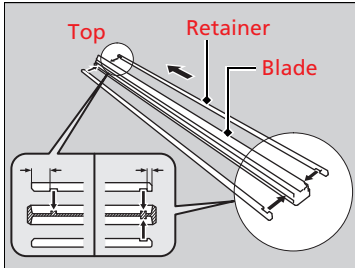

5. Remove the retainers from the rubber blade that has been removed, and mount to a new rubber blade.
 ▶ Correctly align the rubber protrusion and the retainer grooves.

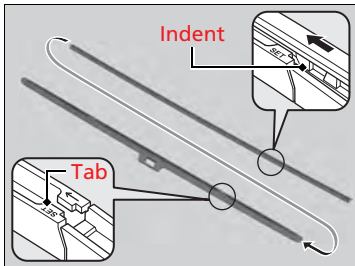

6. Slide the new wiper blade onto the holder from the bottom end.
 ▶ The tab on the holder should fit in the indent of the wiper blade.

7. Slide the wiper blade onto the wiper arm, then push down the lock tab.

8. Lower the passenger side wiper arm first, then the driver side.

Changing the Rear Wiper Blade Rubber

ORG



1. Raise the wiper arm off.

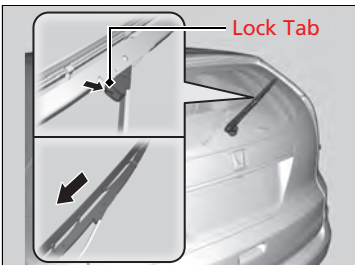

2. Pull up the lock tab and release the wiper arm.

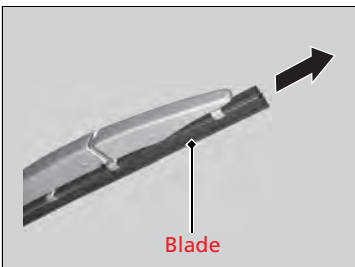

3. Slide the wiper blade out from the end with the indent.

▶▶ Changing the Rear Wiper Blade Rubber

NOTICE

Avoid dropping the wiper arm; it may damage the windshield.

TOC

Maintenance

Index

Home

ORG

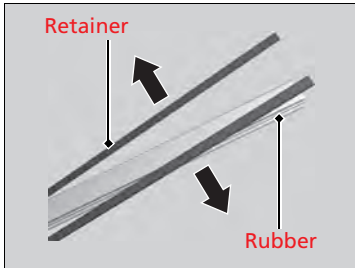

4. Remove the retainers from wiper blade and mount to a new rubber blade.



5. Slide the wiper blade onto the holder.
▶ Make sure it is engaged correctly, then install the wiper blade assembly onto the wiper arm.

TOC

Maintenance

Index

Home

Checking Tires

To safely operate your vehicle, your tires must be of the proper type and size, in good condition with adequate tread, and properly inflated.

■ Inflation guidelines

Properly inflated tires provide the best combination of handling, tread life, and comfort. Refer to the driver's doorjamb label or specification's page for the specified pressure.

Underinflated tires wear unevenly, adversely affect handling and fuel economy, and are more likely to fail from overheating.

Overinflated tires make your vehicle ride harshly, are more prone to road hazards, and wear unevenly.

Every day before you drive, look at each of the tires. If one looks lower than the others, check the pressure with a tire gauge.

At least once a month or before long trips, use a gauge to measure the pressure in all tires, including the spare. Even tires in good condition can lose 1 to 2 psi (10 to 20 kPa, 0.1 to 0.2 kgf/cm²) per month.

■ Inspection guidelines

Every time you check inflation, also examine the tires and valve stems.

Look for:

- Bumps or bulges on the side or in the tread. Replace the tire if you find any cuts, splits, or cracks in the side of the tire. Replace it if you see fabric or cord.
- Remove any foreign objects and inspect for air leaks.
- Uneven tread wear. Have a dealer check the wheel alignment.
- Excessive tread wear.

[▶ Wear Indicators P. 303](#)

- Cracks or other damage around valve stem.

☒ Checking Tires

⚠ WARNING

Using tires that are excessively worn or improperly inflated can cause a crash in which you can be seriously hurt or killed.

Follow all instructions in this owner's manual regarding tire inflation and maintenance.

Measure the air pressure when tires are cold. This means the vehicle has been parked for at least three hours, or driven less than 1 mile (1.6 km). If necessary, add or release air until the specified pressure is reached.

If checked when hot, tire pressure can be as much as 4–6 psi (30–40 kPa, 0.3–0.4 kgf/cm²) higher than if checked when cold.

Have a dealer check the tires if you feel a consistent vibration while driving. New tires and any that have been removed and reinstalled should be properly balanced.

Tire and Loading Information Label

The label attached to the driver's doorjamb provides necessary tire and loading information.

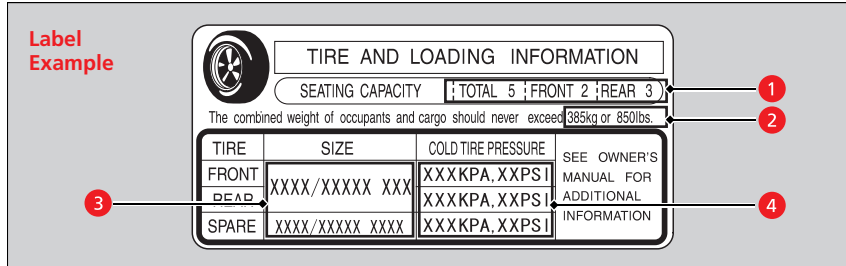

Tire and Loading Information Label

The tire and loading information label attached to the driver's doorjamb contains:

- 1 The number of people your vehicle can carry.
- 2 The total weight your vehicle can carry. Do not exceed this weight.
- 3 The original tire sizes for front, rear, and spare.
- 4 The proper cold tire pressure for front, rear, and spare.

Tire Labeling

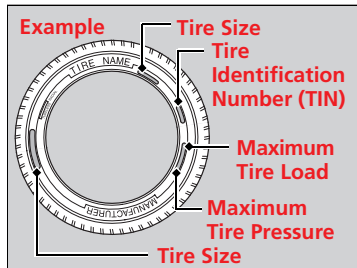

The tires that came on your vehicle have a number of markings. Those you should be aware of are described below.

Tire Sizes

Following is an example of tire size with an explanation of what each component means.

215/70R16 100S

215: Tire width in millimeters.

70: Aspect ratio (the tire's section height as a percentage of its width).

R: Tire construction code (R indicates radial).

16: Rim diameter in inches.

100: Load index (a numerical code associated with the maximum load the tire can carry).

S: Speed symbol (an alphabetical code indicating the maximum speed rating).

Tire Sizes

Whenever tires are replaced, they should be replaced with tires of the same size.

■ Tire Identification Number (TIN)

The tire identification number (TIN) is a group of numbers and letters that look like the example in the side column. TIN is located on the sidewall of the tire.

■ Glossary of Tire Terminology

Cold Tire Pressure – The tire air pressure when the vehicle has been parked for at least three hours or driven less than 1 mile (1.6 km).

Load Rating – Means the maximum load that a tire is rated to carry for a given inflation pressure.

Maximum Inflation Pressure – The maximum tire air pressure that the tire can hold.

Maximum Load Rating – Means the load rating for a tire at the maximum permissible inflation pressure for that tire.

Recommended Inflation Pressure – The cold tire inflation pressure recommended by the manufacturer.

Treadwear Indicators (TWI) – Means the projections within the principal grooves designed to give a visual indication of the degrees of wear of the tread.

▶▶ Tire Identification Number (TIN)

DOT B97R FW6X 2209

DOT: This indicates that the tire meets all requirements of the U.S. Department of Transportation.

B97R: Manufacturer's identification mark.

FW6X: Tire type code.

22 09: Date of manufacture.

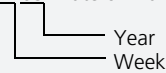

DOT Tire Quality Grading (U.S. Vehicles)

The tires on your vehicle meet all U.S. Federal Safety Requirements. All tires are also graded for treadwear, traction, and temperature performance according to Department of Transportation (DOT) standards. The following explains these gradings.

Uniform Tire Quality Grading

Quality grades can be found where applicable on the tire sidewall between tread holder and maximum section width.

Treadwear

The treadwear grade is a comparative rating based on the wear rate of the tire when tested under controlled conditions on a specified government test course. For example, a tire graded 150 would wear one and one-half (1 1/2) times as well on the government course as a tire graded 100. The relative performance of tires depends upon the actual conditions of their use, however, and may depart significantly from the norm due to variations in driving habits, service practices and differences in road characteristics and climate.

Uniform Tire Quality Grading

For example:

Treadwear 200
Traction AA
Temperature A

All passenger car tires must conform to Federal Safety Requirements in addition to these grades.

■ Traction

The traction grades, from highest to lowest, are AA, A, B, and C. Those grades represent the tire's ability to stop on wet pavement as measured under controlled conditions on specified government test surfaces of asphalt and concrete. A tire marked C may have poor traction performance.

■ Temperature

The temperature grades are A (the highest), B, and C, representing the tire's resistance to the generation of heat and its ability to dissipate heat when tested under controlled conditions on a specified indoor laboratory test wheel. Sustained high temperature can cause the material of the tire to degenerate and reduce tire life, and excessive temperature can lead to sudden tire failure. The grade C corresponds to a level of performance which all passenger car tires must meet under the Federal Motor Vehicle Safety Standard No. 109. Grades B and A represent higher levels of performance on the laboratory test wheel than the minimum required by law.

▶▶ Traction

Warning: The traction grade assigned to this tire is based on straight-ahead braking traction tests, and does not include acceleration, cornering, hydroplaning, or peak traction characteristics.

▶▶ Temperature

Warning: The temperature grade for this tire is established for a tire that is properly inflated and not overloaded. Excessive speed, underinflation, or excessive loading, either separately or in combination, can cause heat buildup and possible tire failure.

Wear Indicators

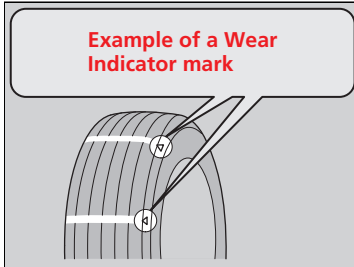

The groove where the wear indicator is located is 1/16 inch (1.6 mm) shallower than elsewhere on the tire. If the tread has worn so that the indicator is exposed, replace the tire.

Worn out tires have poor traction on wet roads.

Tire Service Life

The life of your tires is dependent on many factors, including driving habits, road conditions, vehicle loading, inflation pressure, maintenance history, speed, and environmental conditions (even when the tires are not in use).

In addition to regular inspections and inflation pressure maintenance, it is recommended that you have annual inspections performed once the tires reach five years old. All tires, including the spare, should be removed from service after 10 years from the date of manufacture, regardless of their condition or state of wear.

Tire and Wheel Replacement

Replace your tires with radials of the same size, load range, speed rating, and maximum cold tire pressure rating (as shown on the tire's sidewall). Using tires of a different size or construction can cause the ABS, VSA® (vehicle stability assist), hill start assist, and the AWD* system to work incorrectly.

It is best to replace all four tires at the same time. If that isn't possible, replace the front or rear tires in pairs.

Make sure that the wheel's specifications match those of the original wheels.

If you replace a wheel, only use TPMS specified wheels approved for your vehicle.

▶▶ Tire and Wheel Replacement

WARNING

Installing improper tires on your vehicle can affect handling and stability. This can cause a crash in which you can be seriously hurt or killed.

Always use the size and type of tires recommended in this owner's manual.

Tire Rotation

Rotating tires according to the maintenance messages on the information display/ multi-information display helps to distribute wear more evenly and increase tire life.

■ Tires without rotation marks

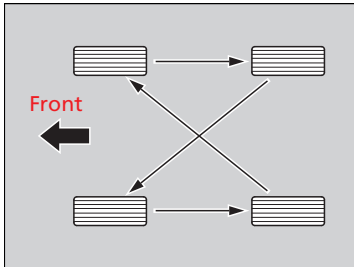

Rotate the tires as shown here.

■ Tires with rotation marks

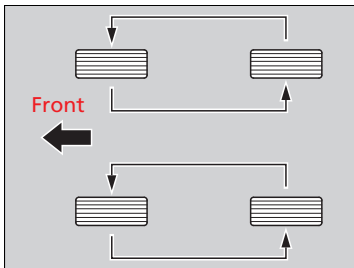

Rotate the tires as shown here.

☒ Tire Rotation

Tires with directional tread patterns should only be rotated front to back (not from one side to the other). Directional tires should be mounted with the rotation indication mark facing forward, as shown below.

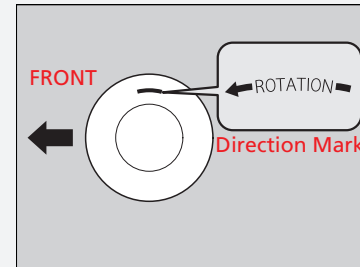

Winter Tires

If driving on snowy or frozen roads, mount all season marked "M+S" tires, snow tires, or tire chains; reduce speed; and maintain sufficient distance between vehicles when driving.

Be particularly careful when operating the steering wheel or brakes to prevent skidding.

Use tire chains, snow tires, or all season tires when necessary or according to the law.

When mounting, refer to the following points.

For winter tires:

- Select the size and load ranges that are the same as the original tires.
- Mount the tires to all four wheels.

For tire chains:

- Install them on the front tires only.
- Because your vehicle has limited tire clearance, we strongly recommend using the chains listed below:

Cable-type: SCC Radial Chain SC1042

- Follow the chain manufacturer's instruction when installing. Mount them as tightly as you can.
- Check that the chains do not touch the brake lines or suspension.
- Drive slowly.

❧ Winter Tires

WARNING

Using the wrong chains, or not properly installing chains, can damage the brake lines and cause a crash in which you can be seriously injured or killed.

Follow all instructions in this owner's manual regarding the selection and use of tire chains.

NOTICE

Traction devices that are the wrong size or improperly installed can damage your vehicle's brake lines, suspension, body, and wheels. Stop driving if they are hitting any part of the vehicle.

When tire chains are mounted, follow the chain manufacturer's instructions regarding vehicle operational limits.

If your vehicle is equipped with summer tires, be aware that these tires are not designed for winter driving conditions. For more information, contact a dealer.

Checking the Battery

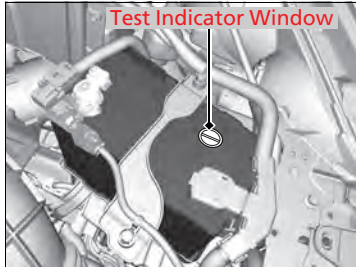

Check the battery condition monthly. Look at the test indicator window and check the terminals for corrosion.

If your vehicle's battery is disconnected or goes dead:

- The audio system is disabled.
➤ [Reactivating the audio system P. 152](#)
- The clock resets.
➤ [Clock P. 96](#)
- The navigation system* is disabled.
➤ [Refer to the navigation system manual](#)

Charging the Battery

Disconnect both battery cables to prevent damaging your vehicle's electrical system. Always disconnect the negative (-) cable first, and reconnect it last.

Battery

⚠ WARNING

The battery gives off explosive hydrogen gas during normal operation.

A spark or flame can cause the battery to explode with enough force to kill or seriously hurt you.

When conducting any battery maintenance, wear protective clothing and a face shield, or have a skilled technician do it.

WARNING: Battery post, terminals, and related accessories contain lead and lead compounds.

Wash your hands after handling.

The test indicator's color information is on the battery.

When you find corrosion, clean the battery terminals by applying a baking powder and water solution. Clean terminals with a damp towel. Cloth/towel dry the battery. Coat the terminals with grease to help prevent future corrosion.

* Not available on all models

Replacing the Button Battery

If the indicator does not come on when the button is pressed, replace the battery.

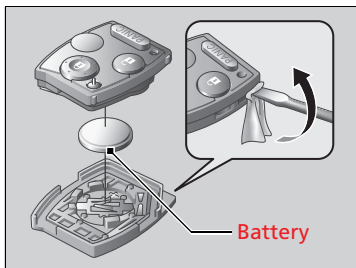
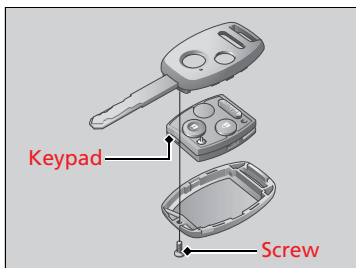

Battery type: CR1616

1. Unscrew the cover with a small Phillips-head screwdriver. Press a button to pry open the transmitter.
2. Open the keypad.
 - ▶ Wrap the small flat-tip screwdriver with a cloth to prevent scratching the transmitter.
3. Make sure to replace the battery with the correct polarity.

Replacing the Button Battery

NOTICE

An improperly disposed of battery can damage the environment. Always confirm local regulations for battery disposal.

Replacement batteries are commercially available or at a dealer.

Models with Rear Entertainment System

Replacing the Battery

Remote Control

If it takes several pushes on the remote control buttons to operate the rear entertainment system*.

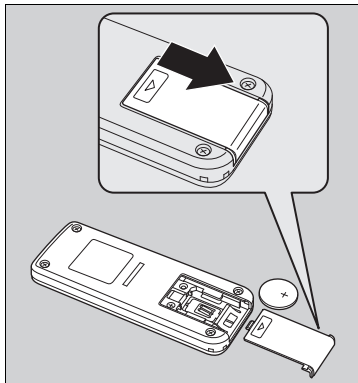

Battery type: CR2025

1. Remove the cover.
2. Make sure to replace the battery with the correct polarity.

Replacing the Battery

NOTICE

An improperly disposed of battery can damage the environment. Always confirm local regulations for battery disposal.

Replacement batteries are commercially available or at a dealer.

■ Wireless Headphone

If there is no sound coming from the wireless headphone, replace the battery.

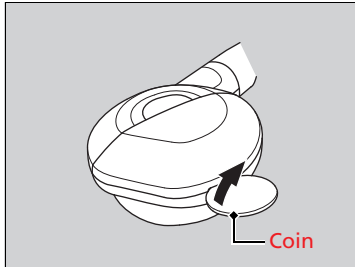

Battery type: AAA

1. To open the cover, insert a coin in the slot and twist it slightly to pry the cover away from the earpiece.
2. Make sure to replace the battery with the correct polarity.

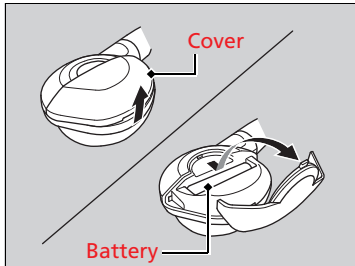

Dust and Pollen Filter

The heating and cooling system*/climate control system* is equipped with a dust and pollen filter that collects pollen, dust, and other debris in the air. The Maintenance Minder™ messages will let you know when to replace the filter.

We recommend that you replace the dust and pollen filter sooner when using your vehicle in areas with high concentrations of dust.

☒ Dust and Pollen Filter

If the airflow from the heating and cooling system*/climate control system* deteriorates noticeably, and the windows fog up easily, the filter may need to be replaced. Please contact a dealer for replacement.

* Not available on all models

Interior Care

Use a damp cloth with a mixture of mild detergent and warm water to remove dirt. Use a clean cloth to remove detergent residue.

Cleaning Seat Belts

Use a soft brush with a mixture of mild soap and warm water to clean the seat belts. Let the belts air dry. Wipe the openings of the seat belt anchors using a clean cloth.

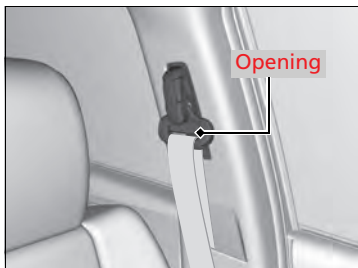

Interior Care

Do not spill liquids inside the vehicle.

Electrical devices and systems may malfunction if liquids are splashed on them.

Do not use silicone based sprays on electrical devices such as audio devices and switches.

Doing so may cause the items to malfunction or a fire inside the vehicle.

If a silicone based spray is inadvertently used on electrical devices, consult a dealer.

Depending on their composition, chemicals and liquid aromatics may cause discoloration, wrinkles, and cracking to resin-based parts and textiles.

Do not use alkali solvents or organic solvents such as benzene or gasoline.

After using chemicals, make sure to gently wipe them off using a dry cloth.

Do not place used cloths on top of resin based parts or textiles for long periods of time without washing.

Floor Mats

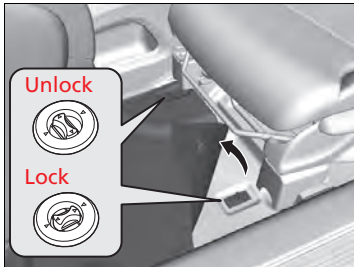

The driver's floor mat hooks over the floor anchors, which keep the mat from sliding forward. To remove a mat for cleaning, turn the anchor knobs to the unlock position. When reinstalling the mat after cleaning, turn the knobs to the lock position.

Do not put additional floor mats on top of the anchored mat.

Maintaining Genuine Leather*

Vacuum dirt and dust from the leather frequently. Pay close attention to the pleats and seams. Clean the leather with a soft cloth dampened with a 90% water and 10% neutral soap solution. Then buff it with a clean, dry cloth. Remove any dust or dirt on leather surfaces immediately.

Floor Mats

If you use any floor mats that were not originally provided with your vehicle, make sure they are designed for your specific vehicle, fit correctly, and are securely anchored by the floor anchors. Position the rear seat floor mats properly. If they are not properly positioned, the floor mats can interfere with the front seat functions.

* Not available on all models

Exterior Care

Dust off the vehicle body after you drive.

Regularly inspect your vehicle for scratches on painted surfaces. A scratch on a painted surface can result in body rust. If you find a scratch, promptly repair it.

Using an Automated Car Wash

Wash the vehicle regularly. Wash more frequently when driving in the following conditions:

- If driving on roads with road salt.
- If driving in coastal areas.
- If tar, soot, bird droppings, insects, or tree sap are stuck to painted surfaces.

Using an Automated Vehicle Wash

- Remove the audio antenna.

[▶ Audio Antenna P. 152](#)

- Fold in the door mirrors.

Make sure to follow the instructions indicated on the automated car wash.

Using High Pressure Cleaners

- Keep sufficient distance between the cleaning nozzle and the vehicle body.
- Take particular care around the windows. Standing too close may cause water to enter the vehicle interior. Do not spray water into the engine compartment.

Using an Automated Car Wash

Do not spray water into the air intake vents or engine compartment. It can cause a malfunction.



■ Applying Wax

A good coat of automotive body wax helps protect your vehicle's paint from the elements. Wax will wear off over time and expose your vehicle's paint to the elements, so reapply as necessary.

■ Maintaining the Bumpers and Other Resin Coated Parts

If you get gasoline, oil, engine coolant, or battery fluid on resin coated parts, they may be stained or the coating may peel. Promptly wipe it away using a soft cloth and clean water.

■ Cleaning the Window

Wipe using a glass cleaner.

■ Maintaining Aluminum Wheels*

Aluminum is susceptible to deterioration caused by salt and other road contaminants. Use a sponge and mild detergent to wipe away promptly. Be careful not to use harsh chemicals (including some commercial wheel cleaners) or a stiff brush. They can damage the clear coat of the aluminum alloy wheels that helps keep the aluminum from corroding and tarnishing.

☒ Applying Wax

NOTICE

Chemical solvents and strong cleaners can damage the paint, metal, and plastic on your vehicle. Wipe up spills immediately.

☒ Maintaining the Bumpers and Other Resin Coated Parts

Ask a dealer about the correct coating material when you want to repair the painted surface of the parts made of resin.

☒ Cleaning the Window

Wires are mounted to the inside of the rear window. Wipe along the same direction as the wires with a soft cloth so as not to damage them.

* Not available on all models

Handling the Unexpected

This chapter explains how to handle unexpected troubles.



- Tools**
- Types of Tools..... 318
- If a Tire Goes Flat**
- Changing a Flat Tire..... 319
- Engine Does Not Start**
- Checking the Engine..... 325
- Jump Starting**..... 326
- Shift Lever Does Not Move**..... 328
- Overheating**
- How to Handle Overheating..... 329

- Indicator, Coming On/Blinking**
- If the Low Oil Pressure Indicator Comes On 331
- If the Charging System Indicator Comes On 331
- If the Malfunction Indicator Lamp Comes On or Blinks 332
- If the Brake System Indicator Comes On (Red)..... 333
- If the EPS System Indicator Comes On... 333
- If the Low Tire Pressure Indicator Comes On 334

- If the TPMS Indicator Comes On 334
- Fuses**
- Fuse Locations 335
- Inspecting and Changing Fuses..... 337
- Emergency Towing**..... 338
- When You Cannot Open the Tailgate** ..339

Types of Tools

Types of Tools

The tools were stored in the luggage area.

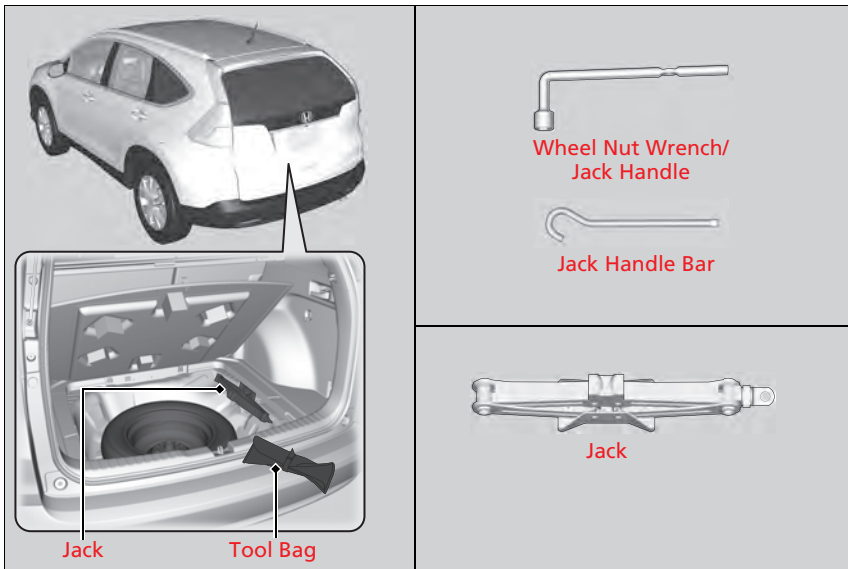

Changing a Flat Tire

If a tire goes flat while driving, grasp the steering wheel firmly, and brake gradually to reduce speed. Then, stop in a safe place. Replace the flat tire with a compact spare tire. Go to a dealer as soon as possible to have the full-size tire repaired or replaced.

1. Park the vehicle on firm, level, and non-slippery and apply the parking brake.
2. Move the shift lever to **P**.
3. Turn on the hazard warning lights and turn the ignition switch to LOCK **0**.

Changing a Flat Tire

Periodically check the tire pressure of the compact spare. It should be set to the specified pressure.
Specified Pressure: 60 psi (420 kPa, 4.2 kgf/cm²)

When driving with the compact spare tire, keep the vehicle speed under 50 mph (80 km/h). Replace with a full-size tire as soon as possible.

The compact spare tire and wheel in your vehicle are specifically for this model.

Do not use them with another vehicle.

Do not use another type of compact spare tire or wheel with your vehicle.

Do not mount tire chains on a compact spare tire. If a chain-mounted front tire goes flat, remove one of the full-size rear tires and replace it with the compact spare tire. Remove the flat front tire and replace it with the full-size tire that was removed from the rear. Mount the tire chains on the front tire.

Do not use a puncture-repairing agent on a flat tire, as it can damage the tire pressure sensor.

Continued

■ Getting Ready to Replace the Flat Tire

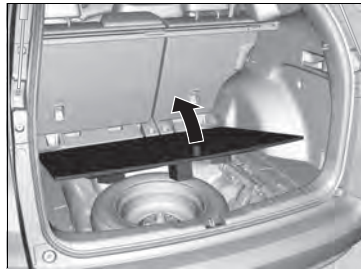

1. Open the cargo area floor lid.

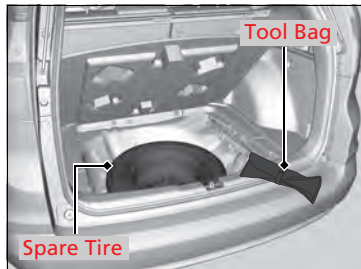

2. Take the tool bag out of the cargo area. Take the wheel nut wrench and jack handle bar out of the tool bag.

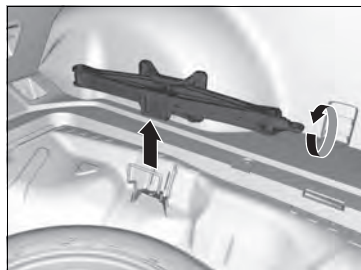

3. Take the jack out of the spare tire area.
4. Unscrew the wing bolt, and remove the spacer cone. Then, remove the spare tire.

ORG

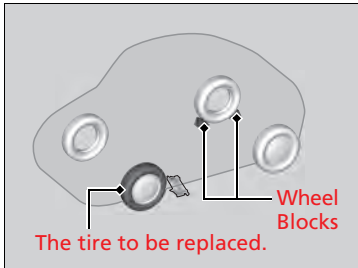

5. Place a wheel block or rock in front and rear of the wheel diagonal to the flat tire.



6. Place the compact spare tire wheel side up under the vehicle body, near the tire that needs to be replaced.



7. Loosen each wheel nut about one turn using the wheel nut wrench.

Handling the Unexpected

TOC

Index

Home

How to Set Up the Jack

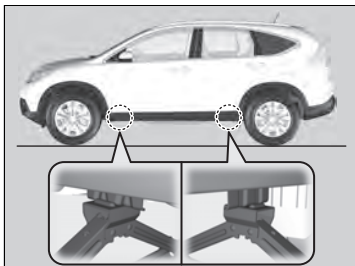

1. Place the jack under the jacking point closest to the tire to be changed.

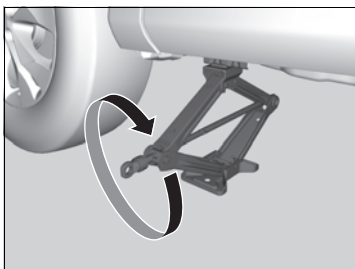

2. Turn the end bracket clockwise as shown in the image until the top of the jack contacts the jacking point.

▶ Make sure that the jacking point tab is resting in the jack notch.

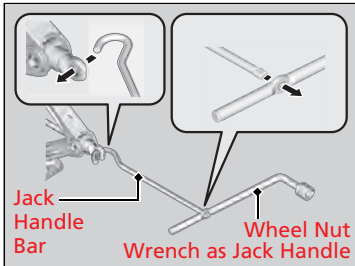

3. Raise the vehicle, using the jack handle bar and the jack handle, until the tire is off the ground.

How to Set Up the Jack

⚠ WARNING

The vehicle can easily roll off the jack, seriously injuring anyone underneath.

Follow the directions for changing a tire exactly, and never get under the vehicle when it is supported only by the jack.

Do not use the jack with people or luggage in the vehicle.

Use the jack provided in your vehicle. Other jacks may not support the weight ("load") or may not fit in the jacking point.

The following instructions must be followed to use the jack safely.

- Do not use while the engine is running.
- Use only where the ground is firm and level.
- Use only at the jacking points.
- Do not get in the vehicle while using the jack.
- Do not put anything on top of or underneath the jack.

Replacing the Flat Tire

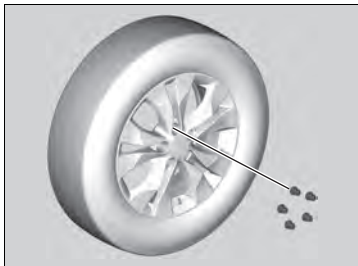

1. Remove the wheel nuts and flat tire.

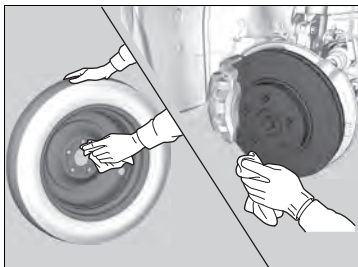

2. Wipe the mounting surfaces of the wheel with a clean cloth.

3. Mount the compact spare tire.

4. Screw the wheel nuts until they touch the lips around the mounting holes, then stop rotating.

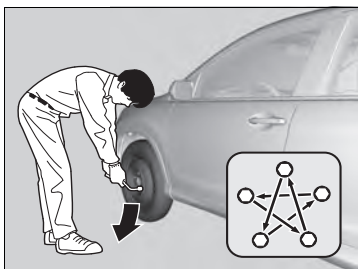

5. Lower the vehicle and remove the jack. Tighten the wheel nuts in the order indicated in the image. Go around, tightening the nuts, two to three times in this order.

Wheel nut torque:

80 lbf·ft (108 N·m, 11 kgf·m)

Replacing the Flat Tire

Do not over tighten the wheel nuts by applying extra torque using your foot or a pipe.

■ Storing the Flat Tire

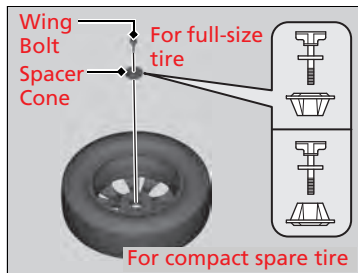

1. Remove the center cap.
2. Place the flat tire face down in the spare tire well.
3. Remove the spacer cone from the wing bolt, flip it over, and insert it back on the bolt. Secure the flat tire with the wing bolt.
4. Securely store the wheel nut wrench and jack handle bar back in the tool bag. Store the bag in the cargo area.
5. Store the jack in its holder. Turn the jack's end bracket to lock it in place.

■ TPMS and the Spare Tire

If you replace a flat tire with the spare tire, the low tire pressure indicator comes on while you are driving. After driving for a few miles (kilometers), the indicator will go off and the **TPMS** indicator comes on, but this is normal.

If you replace the tire with a specified regular tire, the low tire pressure or **TPMS** indicator will go off after a few miles (kilometers).

▶▶ Storing the Flat Tire

⚠ WARNING

Loose items can fly around the interior in a crash and can seriously injure the occupants.
Store the wheel, jack, and tools securely before driving.

▶▶ TPMS and the Spare Tire

The system cannot monitor the pressure of the spare tire. Manually check the spare tire pressure to be sure that it is correct.

Use the TPMS specific wheels. Each is equipped with a tire pressure sensor mounted inside the tire behind the valve stem.

Checking the Engine

If the engine does not start, check the starter.

☒ Checking the Engine

If you must start the vehicle immediately, use an assisting vehicle to jump start it.

➤ [Jump Starting P. 326](#)

Starter condition

Checklist

Starter doesn't turn or turns over slowly.

The battery may be dead. Check each of the items on the right and respond accordingly.

Check the brightness of the interior lights.

Turn on the interior lights and check the brightness.

- If the interior lights are dim or do not come on at all
➤ [Battery P. 307](#)
- If the interior lights come on normally ➤ [Inspecting and Changing Fuses P. 337](#)

The starter turns over normally but the engine doesn't start.

There may be a problem with the fuse. Check each of the items on the right and respond accordingly.

Review the engine start procedure.

Follow its instructions, and try to start the engine again. ➤ [Starting the Engine P. 239](#)

Check the immobilizer system indicator.

When the immobilizer system indicator is blinking, the engine cannot be started.

➤ [Immobilizer System P. 106](#)

Check the fuel level.

There should be enough fuel in the tank. ➤ [Fuel Gauge P. 77](#)

Check the fuse.

Check all fuses, or have the vehicle checked by a dealer.

➤ [Inspecting and Changing Fuses P. 337](#)

If the problem continues:

➤ [Emergency Towing P. 338](#)

Jump Starting Procedure

Turn off the power to electric devices, such as audio and lights. Turn off the engine, then open the hood.

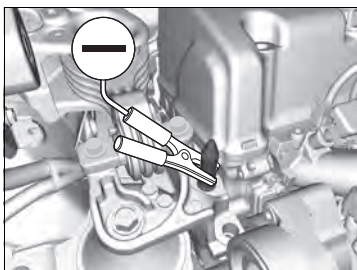
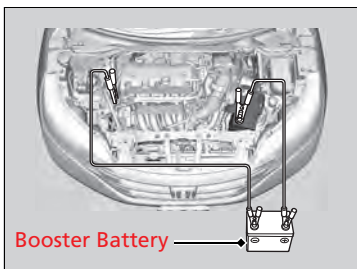

1. Connect the first jumper cable to your vehicle's \oplus terminal.
2. Connect the other end of the first jumper cable to the booster battery \oplus terminal.
▶ Use a 12 volt booster battery only.
3. Connect the second jumper cable to the booster battery \ominus terminal.
4. Connect the other end of the second jumper cable to the engine mounting bolt as shown.
Do not connect this jumper cable to any other part.
5. If your vehicle is connected to another vehicle, start the assisting vehicle's engine and increase its rpm slightly.
6. Attempt to start your vehicle's engine. If it turns over slowly, check that the jumper cables have good metal-to-metal contact.

Jump Starting

⚠ WARNING

A battery can explode if you do not follow the correct procedure, seriously injuring anyone nearby.

Keep all sparks, open flames, and smoking materials away from the battery.

Securely attach the jumper cables clips so that they do not come off when the engine vibrates. Also be careful not to tangle the jumper cables or allow the cable ends to touch each other while attaching or detaching the jumper cables.

Battery performance degrades in cold conditions and may prevent the engine from starting.

What to Do After the Engine Starts

Once your vehicle's engine has started, remove the jumper cables in the following order.

1. Disconnect the jumper cable from your vehicle's ground.
2. Disconnect the other end of the jumper cable from the booster \ominus terminal.
3. Disconnect the jumper cable from your vehicle's \oplus terminal.
4. Disconnect the other end of the jumper cable from the booster \oplus terminal.

Have your vehicle inspected by a nearby service station or a dealer.

Follow the procedure below if you cannot move the shift lever out of the **P** position.

Releasing the Lock

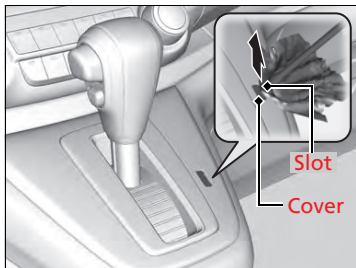

1. Set the parking brake.
2. Remove the key from the ignition switch.
3. Wrap a cloth around the tip of a small flat-tip screwdriver. Put it into the shift lock release slot as shown in the image, and remove the cover.

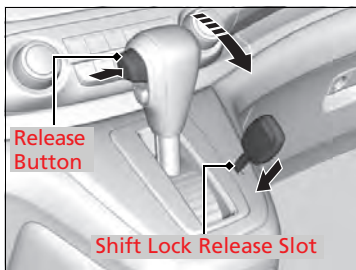

4. Insert the key into the shift lock release slot.
5. While pushing on the key down, press the shift lever release button and place the shift lever into **N**.
 - ▶ The lock is now released. Have the shift lever checked by a dealer as soon as possible.

How to Handle Overheating

Overheating symptoms are as follows:

- The temperature gauge needle is at the **H** mark or the engine suddenly loses power.
- Steam or spray comes out of the engine compartment.

■ First thing to do

1. Immediately park the vehicle in a safe place.
2. Turn off all accessories and turn on the hazard warning lights.
 - ▶ **No steam or spray present:** Keep the engine running and open the hood.
 - ▶ **Steam or spray is present:** Turn off the engine and wait until it subsides. Then open the hood.

☒ How to Handle Overheating

⚠ WARNING

Steam and spray from an overheated engine can seriously scald you.

Do not open the hood if steam is coming out.

NOTICE

Continuing to drive with the temperature gauge needle at the **H** mark may damage the engine.

Continued

■ Next thing to do

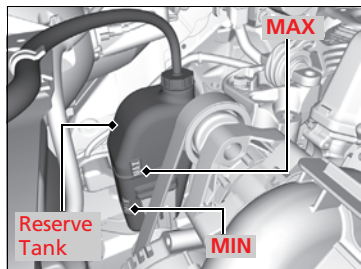

1. Check that the cooling fan is operating and stop the engine once the temperature gauge needle goes down.
 - If the cooling fan is not operating, immediately stop the engine.
2. Once the engine has cooled down, inspect the coolant level and check the cooling system components for leaks.
 - If the coolant level in the reserve tank is low, add coolant until it reaches the **MAX** mark.
 - If there is no coolant in the reserve tank, check that the radiator is cool. Cover the radiator cap with a heavy cloth and open the cap. If necessary, add coolant up to the base of the filler neck, and put the cap back on.

■ Last thing to do

Once the engine has cooled sufficiently, restart it and check the temperature gauge. If the temperature needle has gone down, resume driving. If it has not gone down, contact a dealer for repairs.

►► How to Handle Overheating

⚠ WARNING

Removing the radiator cap while the engine is hot can cause the coolant to spray out, seriously scalding you.

Always let the engine and radiator cool down before removing the radiator cap.

If the coolant is leaking, contact a dealer for repairs.

Use water as an emergency/temporary measure only. Have a dealer flush the system with proper antifreeze as soon as possible.

If the Low Oil Pressure Indicator Comes On



■ Reasons for the indicator to come on

Comes on when the engine oil pressure is low.

■ What to do as soon as the indicator comes on

1. Immediately park the vehicle on level ground in a safe place.
2. If necessary, turn the hazard warning lights on.

■ What to do after parking the vehicle

1. Stop the engine and let it sit for about three minutes.
2. Open the hood and check the oil level.
 - ▶ [Oil Check P. 278](#)
3. Start the engine and check the low oil pressure indicator.
 - ▶ The indicator goes off: Start driving again.
 - ▶ The indicator does not go off within 10 seconds: Stop the engine and contact a dealer for repairs immediately.

☒ If the Low Oil Pressure Indicator Comes On

NOTICE

Running the engine with low oil pressure can cause serious mechanical damage almost immediately.

If the Charging System Indicator Comes On



■ Reasons for the indicator to come on

Comes on when the battery is not being charged.

■ What to do when the indicator comes on

Turn off the heating and cooling system*/climate control system*, rear defogger, and other electrical systems, and immediately contact a dealer for repairs.

☒ If the Charging System Indicator Comes On

If you need to stop temporarily, do not turn off the engine. Restarting the engine may rapidly discharge the battery.

* Not available on all models

If the Malfunction Indicator Lamp Comes On or Blinks



■ Reasons for the indicator lamp to come on or blink

- Comes on when there is a problem with the engine emissions control system, or the fuel fill cap is missing, or loose.
- Blinks when engine misfiring is detected.

■ What to do when the indicator lamp comes on

Avoid high speeds and immediately get your vehicle inspected at a dealer.

■ What to do when the indicator lamp blinks

Park the vehicle in a safe place with no flammable items and wait at least 10 minutes or more with the engine stopped until it cools.

■ Check/Tighten Fuel Cap Message

■ The message appears on when:

An evaporative system leak is detected. This may be caused by the fuel fill cap being loose or not being installed.

■ What to do when the message appears:

1. Stop the engine.
2. Check if the fuel fill cap is fully installed.
 - ▶ If not, loosen the cap, and then retighten it until it clicks at least once.
3. Drive for several days of normal driving.
 - ▶ The message should go off.

■ When the malfunction indicator lamp comes on

The malfunction indicator lamp comes on if the system continues to detect a leak of gasoline vapor. If this happens, follow the procedures described earlier to check the fuel fill cap.

⚠ If the Malfunction Indicator Lamp Comes On or Blinks

NOTICE

If you drive with the malfunction indicator lamp on, the emissions control system and the engine could be damaged.

If the malfunction indicator lamp blinks again when restarting the engine, drive to the nearest dealer at 31 mph (50 km/h) or less. Have your vehicle inspected.

If the Brake System Indicator Comes On (Red)



■ Reasons for the indicator to come on

- The brake fluid is low.
- There is a malfunction in the brake system.

■ What to do when the indicator comes on while driving

Press the brake pedal lightly to check pedal pressure.

- If normal, check the brake fluid level the next time you stop.
- If abnormal, take immediate action. If necessary, downshift the transmission to slow the vehicle using engine braking.

☒ If the Brake System Indicator Comes On (Red)

Have your vehicle repaired immediately.

It is dangerous to drive with low brake fluid. If there is no resistance from the brake pedal, stop immediately in a safe place. If necessary downshift the gears.

If the brake system indicator and **ABS** indicator come on simultaneously, the electronic brake distribution system is not working. This can result in vehicle instability under sudden braking.

Have your vehicle inspected by a dealer immediately.

☒ If the EPS System Indicator Comes On

NOTICE

If you repeatedly turn the steering wheel at an extremely low speed, or hold the steering wheel on the full left or right position for a while, the system heats up. The system goes into a protective mode, and limits its performance. The steering wheel becomes harder and harder to operate. Once the system cools down, EPS system is restored. Repeated operation under these conditions can eventually damage the system.

If the EPS System Indicator Comes On



■ Reasons for the indicator to come on

- Comes on when there is a problem with EPS system.
- If you depress the accelerator pedal repeatedly to increase the engine speed while the engine is idling, the indicator comes on, and sometimes the steering wheel becomes harder to operate.

■ What to do when the indicator comes on

Stop the vehicle in a safe place and restart the engine.

If the indicator comes on and stays on, immediately have your vehicle inspected by a dealer.

If the Low Tire Pressure Indicator Comes On



■ Reasons for the indicator to come on

A tire pressure is significantly low. If the compact spare tire is installed, the indicator stays on for a while, then goes off after driving a few miles (kilometers).

■ What to do when the indicator comes on

Stop your vehicle in a safe place. Check the tire pressure and adjust the pressure to the specified level. The specified tire pressure is on a label on the driver side doorjamb.

▶▶ If the Low Tire Pressure Indicator Comes On

NOTICE

Driving on an extremely underinflated tire can cause it to overheat. An overheated tire can fail. Always inflate your tires to the prescribed level.

If the TPMS Indicator Comes On



■ Reasons for the indicator to come on

- Comes on when there is a problem with the TPMS.
- If the compact spare is installed, the indicator comes on after driving for a few miles (kilometers).

■ What to do when the indicator comes on

Have the tire inspected by a dealer as soon as possible. If the compact spare tire causes the indicator to come on, change the tire to a full-size tire. The indicator goes off after driving for a few miles (kilometers).

Fuse Locations

If any electrical devices are not working, turn the ignition switch to LOCK  and check to see if any applicable fuse is blown.

Fuse locations are shown on the fuse box cover. Locate the fuse in question by the fuse number and box cover number.

Engine Compartment Fuse Box

Located near the brake fluid reservoir. Push the tabs to open the box.

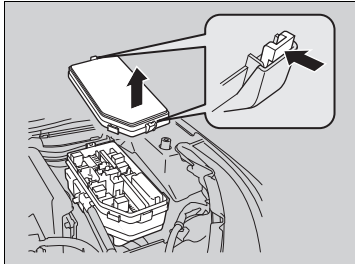

■ Circuit protected and fuse rating

	Circuit Protected	Amps
1	EPS	70 A
	–	–
	ABS/VSA Motor	40 A
	ABS/VSA FSR	20 A
	E-DPS*	(30 A)
	Main Fuse	100 A
	IG Main	50 A
	Fuse Box Main	60 A
	Fuse Box Main 2	60 A
	Headlight Main	30 A
2	–	–
	Rear Defogger	30 A
	–	–
	Blower	40 A
	Front Wiper Main	30 A
	Sub Fan Motor	20 A
3	Main Fan Motor	20 A
	–	–
4	–	–
5	–	–
6	–	–
7	–	–
8	Sub Fan Rly CL	7.5 A
9	–	–
10	Heated Door Mirror*	(7.5 A)

	Circuit Protected	Amps
11	STRLD	7.5 A
12	Fog Lights*	(20 A)
13	Premium Amp*	(20 A)
14	Horn	10 A
15	Hazard	10 A
16	Stop	10 A
17	IG Coil	15 A
18	IGP2	15 A
19	–	–
20	–	–
21	–	–
22	DBW	15 A
23	IGP	15 A
24	Left Headlight Low Beam	10 A
25	Right Headlight Low Beam	10 A
26	SMALL	20 A
27	MG Clutch	7.5 A
28	Interior Lights	7.5 A
29	Backup	10 A

* Not available on all models

Interior Fuse Box

Located under the dashboard.

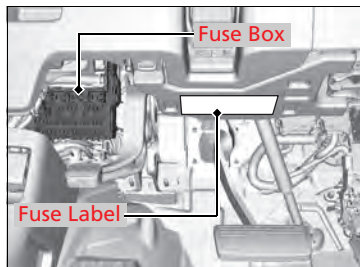

Fuse locations are shown on the label on the cover.

Locate the fuse in question by the fuse number and label number.

■ Circuit protected and fuse rating

	Circuit Protected	Amps
1	–	–
2	ACG	10 A
3	SRS	10 A
4	Fuel Pump	15 A
5	Meter	10 A
6	Power Window	7.5 A
7	VB SOL	7.5 A
8	Door Lock Motor 2 (Unlock)	15 A
9	Door Lock Motor 1 (Unlock)	15 A

	Circuit Protected	Amps
10	Trailer*	(7.5 A)
11	Moonroof*	(20 A)
12	Accessory Power Socket (Center Console)	(20 A)
13	–	–
14	Seat Heaters*	(20 A)
15	Driver's Door Lock Motor (Unlock)	10 A
16	Driver's Power Seat Sliding*	(20 A)
17	Driver's Power Seat Reclining*	(20 A)
18	–	–
19	ACC	7.5 A
20	ACC Key Lock	7.5 A
21	Daytime Running Lights	7.5 A
22	A/C	7.5 A
23	Rear Wiper	10 A
24	ABS/SA	7.5 A
25	Audio	10 A
26	–	–
27	Accessory Power Socket (Front)	20 A
28	Washer	15 A
29	ODS	7.5 A
30	Driver's Door Lock Motor (Lock)*	10 A
31	–	–

	Circuit Protected	Amps
32	Door Lock Motor 2 (Lock)	15 A
33	Door Lock Motor 1 (Lock)	15 A
34	Small Lights	10 A
35	Illumination	7.5 A
36	–	–
37	–	–
38	Left Headlight High Beam	10 A
39	Right Headlight High Beam	10 A
40	TPMS	7.5 A
41	Door Lock	20 A
42	Driver's Power Window	20 A
43	Rear Passenger's Side Power Window	20 A
44	Front Passenger's Side Power Window	20 A
45	Rear Driver's Side Power Window	20 A
46	–	–

* Not available on all models

Handling the Unexpected

ORG

TOC

Index

Home

Inspecting and Changing Fuses

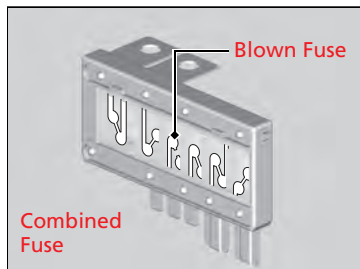

1. Turn the ignition switch to LOCK . Turn headlights and all accessories off.
2. Remove the fuse box cover.
3. Check the large fuse in the engine compartment.
 - If the fuse is blown, use a Phillips-head screwdriver to remove the screw and replace it with a new one.

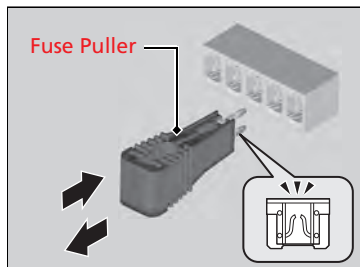

4. Inspect the small fuses in the engine compartment and the vehicle interior.
 - If there is a burned out fuse, remove it with the fuse puller and replace it with a new one.

Inspecting and Changing Fuses

NOTICE

Replacing a fuse with one that has a higher rating greatly increases the chances of damaging the electrical system.

Replace fuse with a spare fuse of the same specified amperage.

Confirm the specified amperage using the charts on P. 335 to P. 336.

Use the charts to locate the fuse in question and conform the specific amperage on the fuse label.

[► Fuse Locations P. 335](#)

There is a fuse puller on the back of the engine compartment fuse box cover.

Call a professional towing service if you need to tow your vehicle.

All models

■ Flat bed equipment

The operator loads your vehicle on the back of a truck.

This is the best way to transport your vehicle.

2WD models

■ Wheel lift equipment

The tow truck uses two pivoting arms that go under the front tires and lift them off the ground. The rear tires remain on the ground. **This is an acceptable way to tow your vehicle.**

» Emergency Towing

NOTICE

Trying to lift or tow your vehicle by the bumpers will cause serious damage. The bumpers are not designed to support the vehicle's weight.

NOTICE

Improper towing such as towing behind a motorhome or other motor vehicle can damage the transmission.

Never tow your vehicle with just a rope or chain. It is very dangerous since ropes or chains may shift from side to side or break.

What to Do When Unable to Open the Tailgate

If you cannot open the tailgate, use the following procedure.

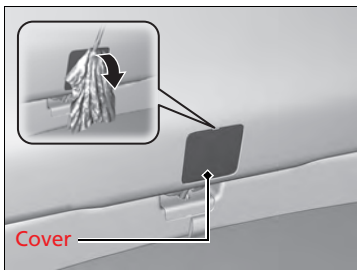

1. Use a flat-tip screwdriver and remove the cover on the inside of the tailgate.

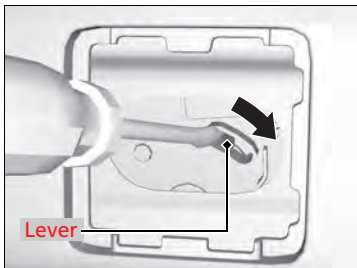

2. To open the tailgate, push the tailgate while sliding the lever to the side using a flat-tip screwdriver.

What to Do When Unable to Open the Tailgate

What to do-following up

After taking these steps, contact a dealer to have the vehicle checked.

When you open the tailgate from inside, make sure there is enough space around the tailgate, and it does not hit anyone or any object.

Information

This chapter includes your vehicle's specifications, locations of identification numbers, and other information required by regulation.



- Specifications** 342
- Identification Numbers**
 - Vehicle Identification Number (VIN)..... 344
 - Engine Number and Transmission Number..... 344
- Devices that Emit Radio Waves** 345
- Reporting Safety Defects** 346

- Emissions Testing**
 - Testing of Readiness Codes..... 347
- Warranty Coverages** 349
- Authorized Manuals**..... 351
- Customer Service Information**..... 352

Vehicle Specifications

Model	Honda CR-V
No. of Passengers:	
Front	2
Rear	3
Total	5
Weights:	
Gross Vehicle Weight Rating	U.S.: 4,332 lbs (1,965 kg) ^{*1} 4,464 lbs (2,025 kg) ^{*2} 4,564 lbs (2,070 kg) ^{*3} Canada: 1,965 kg ^{*1} 2,025 kg ^{*2} 2,070 kg ^{*3}
Gross Axle Weight Rating (Front)	U.S.: 2,227 lbs (1,010 kg) ^{*1} 2,271 lbs (1,030 kg) ^{*2} 2,326 lbs (1,055 kg) ^{*3} Canada: 1,010 kg ^{*1} 1,030 kg ^{*2} 1,055 kg ^{*3}
Gross Axle Weight Rating (Rear)	U.S.: 2,150 lbs (975 kg) ^{*1} 2,238 lbs (1,015 kg) ^{*2} 2,282 lbs (1,035 kg) ^{*3} Canada: 975 kg ^{*1} 1,015 kg ^{*2} 1,035 kg ^{*3}
Air Conditioning:	
Refrigerant Type	HFC-134a (R-134a)
Charge Quantity	13.6 – 15.4 oz (385 – 435 g)
Lubricant Type	SP-10

*1: 16 inch wheel with 2WD models

*2: 17 inch wheel with 2WD models and 16 inch wheel with 4WD models

*3: 17 inch wheel with 4WD models

Engine Specifications

Displacement	144 cu-in (2,354 cm ³)
Spark Plugs	NGK ILZKR7B-11S
	DENSO SXU22HCR11S

Fuel

Fuel Type	Unleaded gasoline, Pump octane number of 87 or higher
Fuel Tank Capacity	15.3 US gal (58 ℓ)

Battery

Capacity/Type	36AH(5)/45AH(20)
	36AH(5)/47AH(20)
	38AH(5)/47AH(20)

Washer Fluid

Tank Capacity	U.S.: 2.6 US qt (2.5 ℓ)
	Canada: 4.8 US qt (4.5 ℓ)

Light Bulbs

Headlights (High/Low Beams)	60/55W (H4/HB2)
Fog Lights	55W (H11)
Front Turn Signal/Parking Lights	24/2.2CP
Side Marker Lights	3CP
Upper Rear Side Marker/Taillights	3CP
Lower Rear Side Marker/Brake/Taillights	21/5W
Back-Up Lights	21W
Rear Turn Signal Lights	21W (Amber)
High-Mount Brake Light	LED
Rear License Plate Light	3CP
Cargo Area Light	8W
Vanity Mirror Lights ^{*1}	2W
Interior Lights	
Map Lights	8W
Ceiling Light	8W

*1: Not available on all models

■ Brake Fluid

Specified	Honda Heavy Duty Brake Fluid DOT 3
-----------	------------------------------------

■ Automatic Transmission Fluid

Specified	Honda ATF DW-1 (automatic transmission fluid)
-----------	--

Capacity	Change	2.3 US qt (2.2 ℓ)*1
		2.7 US qt (2.6 ℓ)*2

*1: 2WD models
*2: AWD models

■ Rear Differential Fluid*

Specified	Honda Dual Pump Fluid II
-----------	--------------------------

Capacity	Change	1.32 US qt (1.247 ℓ)
	Total	1.57 US qt (1.488 ℓ)

■ Engine Oil

Recommended	-Genuine Honda Motor Oil 0W-20
	-API Premium-grade 0W-20 detergent oil
Change	4.0 US qt (3.8 ℓ)

Capacity	Change	
	including filter	4.2 US qt (4.0 ℓ)

■ Engine Coolant

Specified	Honda Long-Life Antifreeze/Coolant Type2
Ratio	50/50 with distilled water
	1.64 US gal (6.2 ℓ)

Capacity	(change including the remaining 0.16 US gal (0.62 ℓ) in the reserve tank)
----------	--

■ Tire

Regular	Size	215/70R16 100S*1 225/65R17 102T*2
	Pressure psi (kPa [kgf/cm ²])	32 (220 [2.2])*1 30 (210 [2.1])*2

Compact Spare	Size	T155/90D17 101M T165/80D17 104M
	Pressure psi (kPa [kgf/cm ²])	60 (420 [4.2])

Wheel Size	Regular	16 x 6.5J*1 17 x 6.5J*2
	Compact Spare	17 x 4T

*1: Vehicle with 16 inch wheel
*2: Vehicle with 17 inch wheel

* Not available on all models

Vehicle Identification Number (VIN)

Your vehicle has a 17-digit vehicle identification number (VIN) used to register your vehicle for warranty purposes, and for licensing and insuring your vehicle. See the image below for the VIN locations.

Engine Number and Transmission Number

See the image below for the locations of your vehicle's engine number and transmission number.

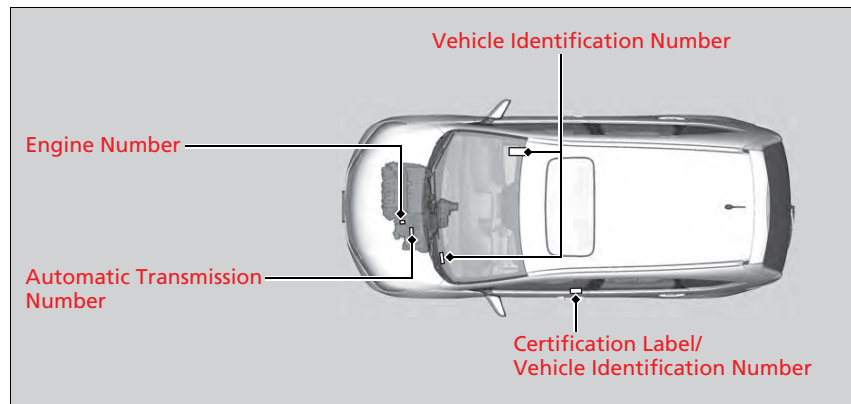

Vehicle Identification Number (VIN)

The interior vehicle identification number (VIN) is located under the cover.

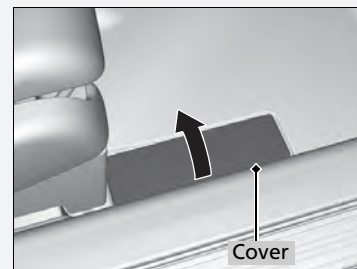

The following products and systems on your vehicle emit radio waves when in operation.

Audio System

Bluetooth® Audio

Bluetooth® HandsFreeLink®

Immobilizer System

Remote Transmitter

Tire Pressure Monitoring System (TPMS)

Models with Rear Entertainment System

Rear Entertainment System Remote Control

Each of the above complies with the appropriate requirements or the required standards of FCC (Federal Communications Commission) and Industry Canada Standard, described below:

As required by the FCC:

This device complies with Part 15 of the FCC rules. Operation is subject to the following two conditions: (1) This device may not cause harmful interference, and (2) this device must accept any interference received, including interference that may cause undesired operation.

Changes or modifications not expressly approved by the party responsible for compliance could void the user's authority to operate the equipment.

This device complies with Industry Canada Standard RSS-Gen/210/310. Operation is subject to the following two conditions: (1) this device may not cause interference, and (2) this device must accept any interference, including interference that may cause undesired operation of the device.

In the U.S.

If you believe that your vehicle has a defect which could cause a crash or could cause injury or death, you should immediately inform the National Highway Traffic Safety Administration (NHTSA) in addition to notifying American Honda Motor Co., Inc.

If NHTSA receives similar complaints, it may open an investigation, and if it finds that a safety defect exists in a group of vehicles, it may order a recall and remedy campaign. However, NHTSA cannot become involved in individual problems between you, your dealer, or American Honda Motor Co., Inc.

To contact NHTSA, you may call the Vehicle Safety Hotline toll-free at 1-888-327-4236 (TTY: 1-800-424-9153);

go to <http://www.safercar.gov>

or write to: Administrator, NHTSA,
1200 New Jersey Avenue, SE.,
Washington, DC 20590.

You can also obtain other information about motor vehicle safety from <http://www.safercar.gov>.

In Canada

If you believe that your vehicle has a defect which could cause a crash or could cause injury or death, you should immediately inform Honda Canada Inc. and you may also inform Transport Canada.

If Transport Canada receives similar complaints, it may open an investigation, and if it finds that a safety defect exists in a group of vehicles, it may lead to a recall and remedy campaign. However, Transport Canada cannot become involved in individual problems between you, your dealer, or Honda Canada Inc.

To contact Transport Canada's Defect Investigations and Recalls Division, you may call 1-800-333-0510. For more information on reporting safety defects or about motor vehicle safety, go to <http://www.tc.gc.ca/roadsafety>.

Testing of Readiness Codes

Your vehicle uses “readiness codes,” as part of its onboard self diagnostic system. Some states refer to these codes during testing to see if your vehicle’s emissions components are working properly. The codes may not be read if you go through the testing just after the battery has gone dead or been disconnected.

To check if they are set, turn the ignition switch to ON **II**, without starting the engine. The malfunction indicator lamp will come on for several seconds. If it then goes off, the readiness codes are set. If it blinks five times, the readiness codes are not set.

If you are required to have your vehicle tested before the readiness codes are ready, prepare the vehicle for retesting by doing the following:

1. Fill the fuel tank to approximately 3/4 full.
2. Park the vehicle and leave the engine off for six hours or more.
3. Make sure the ambient temperature is between 40°F and 95°F (4°C and 35°C).
4. Start the engine without touching the accelerator pedal, and let it idle for 20 seconds.
5. Keep the vehicle in **P**. Increase the engine speed to 2,000 rpm, and hold it there for about three minutes.
6. Let the engine idle with your foot off the accelerator for 20 seconds.

Testing of Readiness Codes

The readiness codes are erased when the battery is disconnected, and set again only after several days of driving under a variety of conditions.

If a testing facility determines that the readiness codes are not set, you may be requested to return at a later date to complete the test.

If the testing facility determines the readiness codes are still not set, see a dealer.

7. Select a nearby, lightly traveled major highway where you can maintain a speed of 50 to 60 mph (80 to 97 km/h) for at least 20 minutes. Drive on the highway in **D**. Do not use cruise control. When traffic allows, drive for 90 seconds without moving the accelerator pedal. (Vehicle speed may vary slightly; this is okay.) If you cannot do this for a continuous 90 seconds because of traffic conditions, drive for at least 30 seconds, then repeat it two more times (for a total of 90 seconds).
8. Drive in city/suburban traffic for at least 10 minutes. When traffic conditions allow, let the vehicle coast for several seconds without using the accelerator pedal or the brake pedal.
9. Park the vehicle and leave the engine off for 30 minutes.

■ U.S. Owners

Your new vehicle is covered by these warranties:

New Vehicle Limited Warranty – covers your new vehicle, except for the emissions control systems and accessories, against defects in materials and workmanship.

Emissions Control Systems Defects Warranty and Emissions Performance Warranty – these two warranties cover your vehicle's emissions control systems. Time, mileage, and coverage are conditional. Please read your warranty booklet for exact information.

Seat Belt Limited Warranty – a seat belt that fails to function properly is covered by a limited warranty. Please read your warranty booklet for details.

Rust Perforation Limited Warranty – all exterior body panels are covered for rust-through from the inside for the specified time period with no mileage limit.

Accessory Limited Warranty – Honda accessories are covered under this warranty. Time and mileage limits depend on the type of accessory and other factors. Please read your warranty booklet for details.

Replacement Parts Limited Warranty – covers all Honda replacement parts against defects in materials and workmanship.

Replacement Battery Limited Warranty – provides prorated coverage for a replacement battery purchased from a dealer.

Replacement Muffler Lifetime Limited Warranty – provides coverage for as long as the purchaser of the muffler owns the vehicle.

Restrictions and exclusions apply to all these warranties. Please read the 2013 Honda warranty information booklet that came with your vehicle for precise information on warranty coverages. Your vehicle's original tires are covered by their manufacturer. Tire warranty information is in a separate booklet.

■ **Canadian Owners**

Please refer to the 2013 warranty manual that came with your vehicle.

■ Service Express

For electronic copies of service publications, you can purchase a subscription to Service Express. Visit www.techinfo.honda.com for pricing and options.

■ For U.S. Owners:

The publications listed below can be purchased from Helm Incorporated. You can order a manual by phone at 1-800-782-4356 (credit card orders only), or online at www.helminc.com.

Make an inquiry to Helm Inc. at 1-800-782-4356 if you are interested in ordering other models' or other years' manuals.

Publication Form Number	Form Description
31T0A610	2013 Honda CR-V Owner's Manual
31T0A810	2013 Honda CR-V Navigation System Owner's Manual
31T0AM10	2013 Honda CR-V Service History
31T0AA10	2013 Honda CR-V Technology Reference Guide (LX/EX/EX-L/EX-L with RES)
31T0AB10	2013 Honda CR-V Technology Reference Guide (EX-L with Navigation)
HON-R	Order Form for Previous Years-Indicate Year and Model Desired

Authorized Manuals

For Canadian Owners:

Si vous avez besoin d'un Manuel du Conducteur en français, veuillez demander à votre concessionnaire de commander le numéro de pièce 33T0AC10

Honda dealership personnel are trained professionals.

They should be able to answer all your questions. If you encounter a problem that your dealership does not solve to your satisfaction, please discuss it with the dealership's service manager or general manager. If you are dissatisfied with the decision made by the dealership's management, contact Honda Customer Services.

U.S. Owners:

American Honda Motor Co., Inc.
Honda Automobile Customer Services
Mail Stop 500-2N-7A
1919 Torrance Blvd.
Torrance, CA 90501-2746
Tel: (800) 999-1009

Canadian Owners:

Honda Canada Inc.
Customer Relations
180 Honda Boulevard
Markham, ON
L6C 0H9
Tel: 1-888-9-HONDA-9
Fax: 1-877-939-0909
E-mail: Honda_cr@ch.honda.com

In Puerto Rico and the U.S. Virgin Islands:

Bella International
P.O. Box 190816
San Juan, PR 00919-0816
Tel: (787) 620-7546

Customer Service Information

When you call or write, please give us the following information:

- Vehicle Identification Number
 - **Vehicle Identification Number (VIN)**
P. 344
- Date of purchase
- Odometer reading of your vehicle
- Your name, address, and telephone number
- A detailed description of the problem
- Name of the dealer who sold the vehicle to you

Numbers

4WD 251

A

ABS (Anti-lock Brake System) 256

Accessories and Modifications 264

Accessory Power Sockets 135

Additives

Coolant 282

Engine Oil 277

Washer 286

Additives, Engine Oil 277**Adjusting**

Armrest 131

Front Seats 122

Head Restraints 125

Mirrors 120

Rear Seat Back 130

Rear Seats 129

Steering Wheel 119

Air Conditioning System (Climate**Control System)** 145

Changing the Mode 145

Defrosting the Windshield and

Windows 146

Dust and Pollen Filter 311

Recirculation/Fresh Air Mode 145

Sensors 148

Synchronized Mode 147

Using Automatic Climate Control 145

Air Conditioning System (Heating and

Cooling System) 142

Cooling 144

Defrosting the Windshield and

Windows 144

Dust and Pollen Filter 311

Heating 143

Air Pressure 299, 343**Airbags** 37

Advanced Airbags 43

After a Collision 41

Airbag Care 51

Event Data Recorder 21

Front Airbags (SRS) 40

Indicator 48, 71, 74

Passenger Airbag Off Indicator 49

Sensors 37

Side Airbag Cutoff System 46

Side Airbag Off Indicator 50

Side Airbags 44

Side Curtain Airbags 47

AM/FM Radio 156**Anti-lock Brake System (ABS)** 256

Indicator 71

Armrest 131**Audio Antenna** 152**Audio System** 150

Adjusting the Sound 155

Auxiliary Input Jack 151

Error Messages 186

General Information 190

iPod® 164

MP3/WMA/AAC 169

Pandora® 167

Reactivating 152

Recommended CDs 191

Recommended Devices 193

Security Code 152

Theft Protection 152

USB Adapter Cable 151

USB Flash Drives 193

Authorized Manuals 351**Auto Door Locking/Unlocking** 103

Customize 89

Automatic Lighting 113**Automatic Transmission** 242

Creeping 242

Fluid 284

Kickdown 242

Operating the Shift Lever 15, 244

Shift Lever Does Not Move 328

Shifting 243

Auxiliary Input Jack 151**Average Fuel Economy** 79, 82**Average Speed** 82**AWD** 251**B****Battery** 307

Charging System Indicator 69, 331

Jump Starting 326

Maintenance (Checking the Battery)	307
Maintenance (Replacing).....	308
Behind a Motorhome.....	235
Belts (Seat)	29
Beverage Holders.....	134
Bluetooth® Audio	172
Bluetooth® HandsFreeLink®	194
Booster Seats (For Children).....	64
Brake System.....	254
Anti-lock Brake System (ABS).....	256
Brake Assist System	257
Fluid	285
Foot Brake	255
Indicator.....	68, 333
Parking Brake	254
Brightness Control (Instrument Panel)....	117
Bulb Replacement.....	287
Brake Light, Taillight, Back-Up Light, Rear Turn Signal Light and Lower Rear Side Marker Light	290
Fog Lights.....	288
Front Turn Signal/Parking Light	290
Headlights	287
High-Mount Brake Light	293
Rear License Plate Light.....	293
Side Marker Lights.....	289
Upper Rear Side Marker/Taillight.....	292
Bulb Specifications.....	342

C

Carbon Monoxide Gas	65
Cargo Hook.....	137
Cargo Side Net.....	136
Carrying Cargo	227, 229
CD Player.....	161
Certification Label.....	344
Changing Bulbs	287
Charging System Indicator.....	69, 331
Child Safety.....	52
Childproof Door Locks.....	102
Child Seat.....	52
Booster Seats	64
Child Seat for Infants.....	54
Child Seat for Small Children.....	55
Installing a Child Seat with a Lap/Shoulder Seat Belt.....	60
Larger Children	63
Rear-facing Child Seat.....	54
Selecting a Child Seat.....	56
Childproof Door Locks	102
Cleaning the Exterior.....	314
Cleaning the Interior.....	312
Climate Control System.....	145
Changing the Mode	145
Defrosting the Windshield and Windows.....	146
Dust and Pollen Filter.....	311
Recirculation/Fresh Air Mode.....	145
Sensors	148
Synchronized Mode.....	147

Using Automatic Climate Control.....	145
Clock	96
Coat Hook	136
Compact Spare Tire.....	319, 343
Compass.....	223
Console Compartment.....	133
Controls	95
Coolant (Engine)	282
Adding to the Radiator	283
Adding to the Reserve Tank	282
Overheating.....	329
Creeping (Automatic Transmission).....	242
Cruise Control	246
Indicator	76
Cup Holders.....	134
Customer Service Information	352
Customized Features	84

D

Daytime Running Lights	114
Dead Battery	326
Defrosting the Windshield and Windows.....	144, 146
Detachable Anchor	34
Devices that Emit Radio Waves.....	345
Dimming	
Headlights	112
Rearview Mirror	120
Dipstick (Engine Oil)	278
Directional Signals (Turn Signal).....	112

G

Gasoline (Fuel)

Economy	263
Gauge	77
Information	260
Low Fuel Indicator	70
Refueling	260

Gauges..... 77

Gear Shift Lever Positions

Automatic Transmission	243
------------------------------	-----

Glass (care)..... 315

Glove Box..... 133

H

Halogen Bulbs..... 287, 288

Handling the Unexpected..... 317

HandsFreeLink® (HFL)..... 194

Automatic Import of Cellular Phonebook and Call History	210
Automatic Transferring	208
Caller's ID Information	208
HFL Buttons	194
HFL Menus	196
HFL Status Display.....	195
Making a Call	213
Options During a Call	217
Phone Setup	201
Receiving a Call	216
Speed Dial	211
Text Message.....	206, 218

To Clear the System	209
To Create a Security PIN	207
Hazard Warning Button	2
Head Restraints	125
Headlights.....	112
Aiming	287
Automatic Operation.....	113
Dimming	112, 114
Operating.....	112
Heaters (Seat).....	139
Heating and Cooling System	142
Cooling.....	144
Defrosting the Windshield and Windows.....	144
Dust and Pollen Filter.....	311
Heating.....	143
HFL (HandsFreeLink®).....	194
High Beam Indicator	74
Hill Start Assist System	240

I

Identification Numbers.....	344
Engine and Transmission	344
Vehicle Identification	344
Ignition Switch	111
Illumination Control.....	117
Knob.....	117
Immobilizer System	106
Indicator.....	75
Indicators	68

ABS (Anti-lock Brake System)	71
AWD System.....	71
Charging System.....	69, 331
CRUISE CONTROL.....	76, 247
CRUISE MAIN.....	76, 246
Door Open.....	28, 72
ECON Mode	75, 245
EPS (Electric Power Steering) System	73, 333
Fog Light	74
High Beam	74
Immobilizer System	75
Lights On	74
Low Fuel.....	70
Low Oil Pressure	68, 331
Low Tire Pressure.....	73, 251, 252
Maintenance Minder.....	76, 269
Malfunction Indicator Lamp	69, 332
Parking Brake and Brake System	68, 333
Seat Belt Reminder.....	30, 70
Security System Alarm.....	75
Shift Lever Position.....	69
Side Airbag Off.....	50, 74
Supplemental Restraint System	48, 71
Tailgate Open	72
TPMS	73, 253
Transmission	70
Turn Signal	74
VSA® (Vehicle Stability Assist) System	72, 249
VSA® OFF.....	72, 250

N

Numbers (Identification) 344

O

Odometer 78

Off-Highway Driving Guidelines 237

Oil (Engine) 277

Adding 279

Checking 278

Displaying Oil Life 269

Low Oil Pressure Indicator 68, 331

Recommended Engine Oil 277

Viscosity 277

Opening/Closing

Hood 276

Moonroof 110

Power Windows 108

Tailgate 104

Outside Temperature 80

Adjusting 80

Overheating 329

P

Pandora® 167

Panic Mode 107

Parking 258

Parking Brake 254

Parking Brake and Brake System

Indicator 68, 333

Passenger Airbag Off Indicator 49

Passing Indicators 112

Power Windows 108

Precautions While Driving 241

Driving Guidelines for Your Utility

Vehicle 241

Rain 241

Pregnant Women 35

Puncture (Tire) 319

R

Radiator 283

Radio (AM/FM) 156

Radio (XM®) 159

Radio Data System (RDS) 158

Range 79, 82

RDS (Radio Data System) 158

Readiness Codes (Emissions Testing) 347

Real Time AWD with Intelligent Control

System™ 251

Rear Defogger/Heated Door Mirror

Button 118

Rear Entertainment System 174

Rear Seat Back 130

Rear Seats (Folding Down) 129

Rearview Camera 259

Rearview Mirror 120

Refueling 260

Fuel Gauge 77

Gasoline 260, 342

Low Fuel Indicator 70

Regulations 252, 301, 345

Remote Transmitter 99

Replacement

Battery 308

Bulbs 287

Front Wiper Blade Rubber 294

Fuses 335, 336

Rear Wiper Blade Rubber 296

Tires 304

Reporting Safety Defects 346

Resetting a Trip Meter 79

S

Safe Driving 23

Safety Check 28

Safety Labels 66

Safety Message 22

Seat Belts 29

Adjusting the Shoulder Anchor 33

Automatic Seat Belt Tensioners 31

Checking 36

Detachable Anchor 34

Fastening 32

Installing a Child Seat with a Lap/Shoulder

Seat Belt 60

Pregnant Women 35

Reminder 30

Warning Indicator 30, 70

Seat Heaters 139

ORG	Seats.....	122	Speedometer	77	Inspection	298
	Adjusting.....	122	SRS Airbags (Airbags).....	40	Labeling	299
	Driver's Seat Lumbar Support.....	122	Starting the Engine	239	Puncture (Flat Tire)	319
	Front Seats.....	122	Does Not Start.....	325	Regulations	301
	Rear Seats.....	129	Engine Switch Buzzer	111	Rotation	305
	Seat Heaters	139	Jump Starting.....	326	Spare Tire.....	319, 343
	Security System	106	Steering Wheel	119	Summer	306
	Immobilizer System Indicator.....	75	Adjusting.....	119	Tire Chains.....	306
	Security System Alarm Indicator	75	Stopping.....	258	Wear Indicators.....	303
	Select Lever	15, 243	Summer Tires	306	Winter.....	306
	Operation	15, 244	Sunglasses Holder.....	138	Tonneau Cover	140
	Releasing	328	Supplemental Restraint System (SRS).....	40	Tools.....	318
	Won't Move	328	Switches (Around the Steering Wheel).....	2, 3, 111	Towing a Trailer	231
	Select/Reset Knob	78	Synchronized Mode.....	147	Equipment and Accessories	232
	Selecting a Child Seat	56	T		Load Limits.....	231
	Selector Knob (Audio)	153	Tachometer.....	77	Towing Your Vehicle.....	235
	Setting the Clock.....	96	Tailgate	104	Behind a Motorhome	235
	Shift Lever	15, 243	Unable to Open.....	339	Emergency	338
	Shift Lever Position Indicator	69, 244	Temperature Gauge.....	77	TPMS (Tire Pressure Monitoring System).....	251
	Shifting (Transmission)	243	Temperature Sensor	148	Indicator.....	73, 334
	Shoulder Anchor	33	Text Message	206, 218	Transmission	243
	Side Airbags	44	Time (Setting)	96	Automatic.....	243
	Cutoff System.....	46	Tire Pressure Monitoring System (TPMS).....	251	Fluid.....	284
	Off Indicator	46	Indicator.....	73, 334	Number.....	344
	Side Curtain Airbags.....	47	Tires.....	298	Shift Lever Position Indicator.....	69, 244
	SMS Text Message.....	206, 218	Air Pressure	299, 343	Trip Meter.....	79
	Snow Tires	306	Checking and Maintaining.....	298	Troubleshooting.....	317
	Spare Tire	319, 343			Blown Fuse.....	335, 336
	Spark Plugs.....	342			Brake Pedal Vibrates.....	19
	Specifications	342			Buzzer Sounds When Opening Door.....	20
	Specified Fuel	260, 342				

Emergency Towing	338
Engine Won't Start	325
Noise When Braking	20
Overheating.....	329
Puncture/Flat Tire.....	319
Rear Door Won't Open	19, 102
Select Lever Won't Move	328
Warning Indicators	68
Turn Signals.....	112
Indicators (Instrument Panel).....	74

U

Unlocking the Doors.....	99
Unlocking the Front Doors from the Inside	11
USB Adapter Cable	150, 151
USB Flash Drives.....	193

V

Valet Key.....	98
Vanity Mirrors.....	5
Vehicle Identification Number.....	344
Vehicle Stability Assist (VSA®).....	249
Off Button.....	250
Off Indicator	72
System Indicator	72
Viscosity (Oil).....	277, 343
VSA® (Vehicle Stability Assist)	249

W

Wallpaper	90
Warning Indicator On/Blinking	331
Warning Labels.....	66
Warranties (Warranty Manual provided separately)	349
Watts.....	342
Wear Indicators (Tire)	303
Wheel Nut Wrench (Jack Handle)	322
Window Washers	115
Adding/Refilling Fluid	286
Switch.....	115
Windows (Opening and Closing)	108
Windshield.....	115
Cleaning	315
Defrosting/Defogging.....	144, 146
Washer Fluid	286
Wiper Blades.....	294
Wipers and Washers.....	115
Winter Tires	306
Snow Tires	306
Tire Chains.....	306
Wipers and Washers.....	115
Checking and Replacing Wiper Blades.....	294
Front.....	115
Rear	116
WMA.....	161, 169
Worn Tires	298

X Y Z

XM® Radio	159
-----------------	-----