

## **Zoom-Zoom**

**All children instinctively know it.**

**A few adults still remember it.**

**One unique car company refuses to outgrow it.**

**In grown-up language, it means the exhilaration and**

**liberation that come from experiencing sheer motion.**

**But as usual, children put it much better and simply call it "Go Zoom-Zoom."**

**We practice it every day.**

**It's why we build the kind of cars we do.**

**Zoom-Zoom.**

**Can we re-awaken it in you today?**

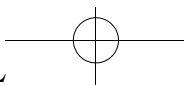

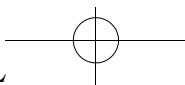
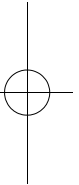
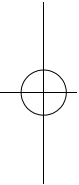
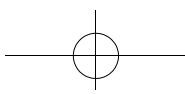



## A Word to Mazda Owners

---

Thank you for choosing a Mazda. We at Mazda design and build vehicles with complete customer satisfaction in mind.

To help ensure enjoyable and trouble-free operation of your Mazda, read this manual carefully and follow its recommendations.

An Authorized Mazda Dealer knows your vehicle best. So when maintenance or service is necessary, that's the place to go.

Our nationwide network of Mazda professionals is dedicated to providing you with the best possible service.

We assure you that all of us at Mazda have an ongoing interest in your motoring pleasure and in your full satisfaction with your Mazda product.

**Mazda Motor Corporation**  
HIROSHIMA, JAPAN

### **Important Notes About This Manual**

Keep this manual in the glove box as a handy reference for the safe and enjoyable use of your Mazda. Should you resell the vehicle, leave this manual with it for the next owner.

All specifications and descriptions are accurate at the time of printing. Because improvement is a constant goal at Mazda, we reserve the right to make changes in specifications at any time without notice and without obligation.

### **Air Conditioning and the Environment**

Your Mazda's genuine air conditioner is filled with HFC134a (R134a), a refrigerant that has been found not to damage the earth's ozone layer. If the air conditioner does not operate properly, consult an Authorized Mazda Dealer.

### **Perchlorate**

Certain components of this vehicle such as [air bag modules, seat belt pretensioners, lithium batteries, ...] may contain Perchlorate Material— Special handling may apply for service or vehicle end of life disposal. See [www.dtsc.ca.gov/hazardouswaste/perchlorate](http://www.dtsc.ca.gov/hazardouswaste/perchlorate).

**Please be aware that this manual applies to all models, equipment and options. As a result, you may find some explanations for equipment not installed on your vehicle.**

©2011 Mazda Motor Corporation  
Printed in Japan Dec. 2011 (Print1)

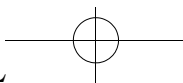

## How to Use This Manual

---

We want to help you get the most driving pleasure from your vehicle. Your owner's manual, when read from cover to cover, can do that in many ways.

Illustrations complement the words of the manual to best explain how to enjoy your Mazda. By reading your manual, you can find out about the features, important safety information, and driving under various road conditions.

The symbol below in this manual means "Do not do this" or "Do not let this happen".

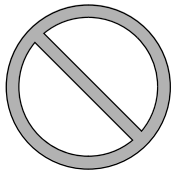

**Index:** A good place to start is the Index, an alphabetical listing of all information in your manual.

You'll find several WARNINGS, CAUTIONS, and NOTES in the manual.

### **WARNING**

*A WARNING indicates a situation in which serious injury or death could result if the warning is ignored.*

### **CAUTION**

*A CAUTION indicates a situation in which bodily injury or damage to your vehicle, or both, could result if the caution is ignored.*

### **NOTE**

*A NOTE provides information and sometimes suggests how to make better use of your vehicle.*

The symbol below, located on some parts of the vehicle, indicates that this manual contains information related to the part. Please refer to the manual for a detailed explanation.

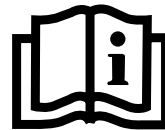

## Table of Contents

<b>Pictorial Index</b> Interior, exterior views and part identification of your Mazda.	<b>1</b>
<b>Essential Safety Equipment</b> Important information about safety equipment, including seats, seat belt system, child-restraint systems and SRS air bags.	<b>2</b>
<b>Before Driving</b> Use of various features, including keys, doors, mirrors and windows.	<b>3</b>
<b>When Driving</b> Information concerning safe driving and stopping.	<b>4</b>
<b>Interior Features</b> Use of various features for ride comfort, including air-conditioning and audio system.	<b>5</b>
<b>Maintenance and Care</b> How to keep your Mazda in top condition.	<b>6</b>
<b>If Trouble Arises</b> Helpful information on what to do if a problem arises with the vehicle.	<b>7</b>
<b>Customer Information and Reporting Safety Defects</b> Important consumer information including warranties and add-on equipment.	<b>8</b>
<b>Specifications</b> Technical information about your Mazda.	<b>9</b>
<b>Index</b>	<b>10</b>

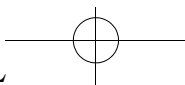
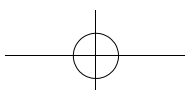



# 1 Pictorial Index

Interior, exterior views and part identification of your Mazda.

<b>Interior Overview .....</b>	<b>1-2</b>
Interior Equipment (View A) .....	1-2
Interior Equipment (View B) .....	1-3
Interior Equipment (View C) .....	1-4
<b>Exterior Overview .....</b>	<b>1-5</b>

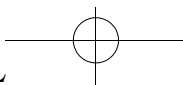

Pictorial Index

# Interior Overview

## Interior Equipment (View A)

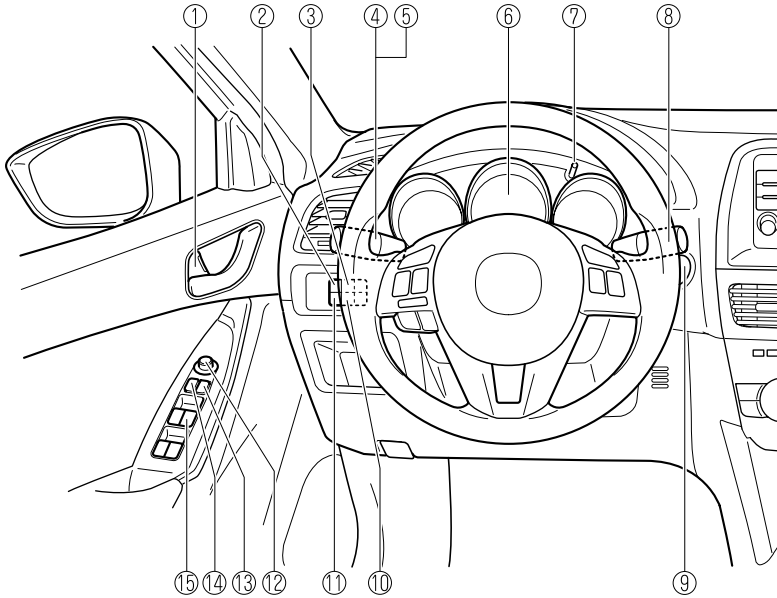

① Door-lock knob .....	page 3-15
② TCS OFF switch .....	page 4-62
③ Tire pressure monitoring system set switch .....	page 4-72
④ Turn and lane-change signal .....	page 4-45
⑤ Lighting control .....	page 4-40
⑥ Instrument cluster .....	page 4-9
⑦ Dashboard illumination knob .....	page 4-11
⑧ Wiper and washer lever .....	page 4-46
⑨ Push button start .....	page 4-2
⑩ AFS OFF switch .....	page 4-44
⑪ BSM OFF switch .....	page 4-77
⑫ Outside mirror switch .....	page 3-25
⑬ Door-lock switch .....	page 3-13
⑭ Power window lock switch .....	page 3-30
⑮ Power window switches .....	page 3-28

**1-2** The equipment and installation position varies by vehicle



Pictorial Index  
**Interior Overview**

**Interior Equipment (View B)**

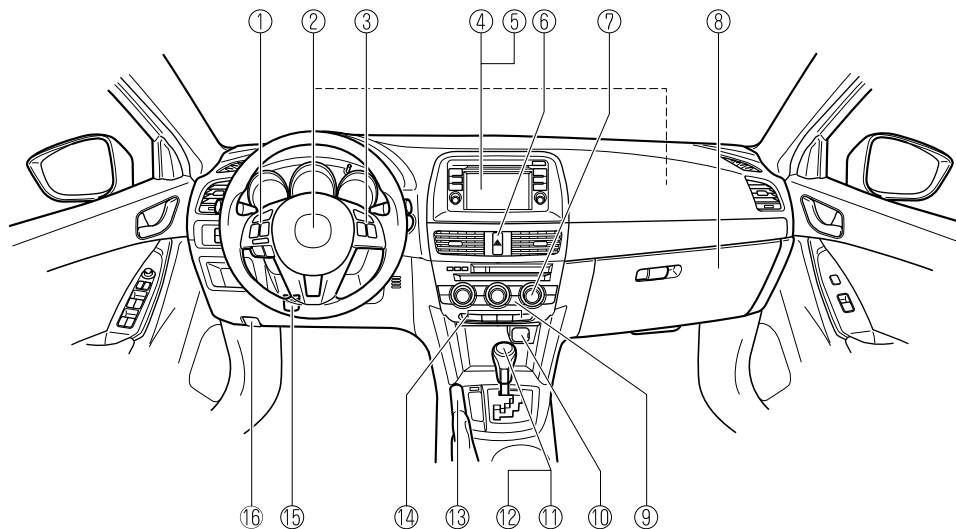

- ① Audio control switches ..... page 5-56
- ② SRS air bags ..... page 2-38
- ③ Cruise control switches ..... page 4-67
- ④ Navigation system (if equipped) ..... Refer to the separate manual
- ⑤ Audio system ..... page 5-13
- ⑥ Hazard warning flasher switch ..... page 4-52
- ⑦ Climate control system ..... page 5-2
- ⑧ Glove compartment ..... page 5-104
- ⑨ Rear window defroster switch ..... page 4-51
- ⑩ Accessory socket ..... page 5-100
- ⑪ MT shift lever ..... page 4-31
- ⑫ AT shift lever ..... page 4-33
- ⑬ Parking brake ..... page 4-57
- ⑭ Seat warmer switches ..... page 2-6
- ⑮ Lock release lever ..... page 3-24
- ⑯ Hood release handle ..... page 6-17

The equipment and installation position varies by vehicle **1-3**

Pictorial Index

# Interior Overview

## Interior Equipment (View C)

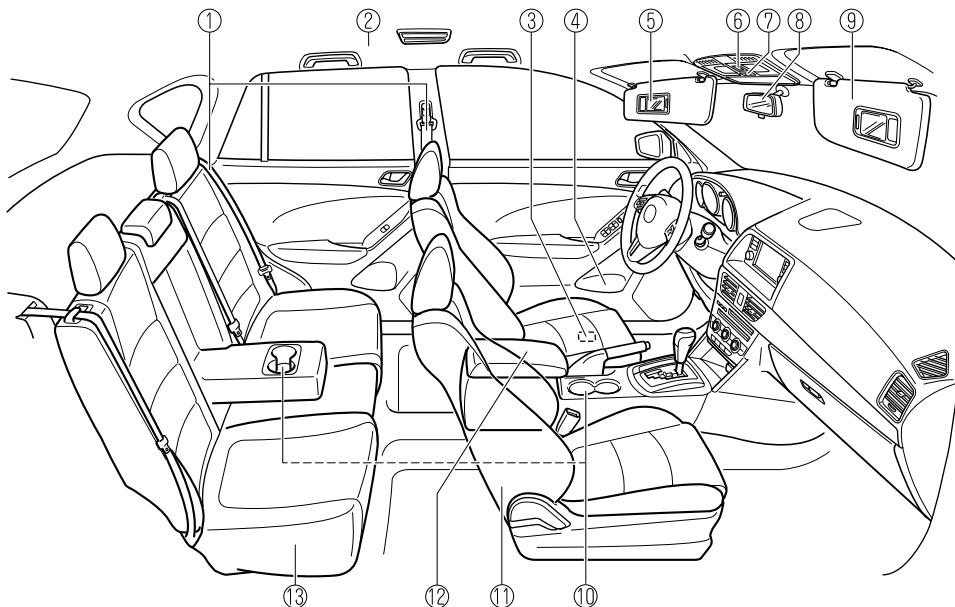

① Seat belts .....	page 2-13
② SRS curtain air bag .....	page 2-38
③ Remote fuel-filler lid release .....	page 3-22
④ Bottle holder .....	page 5-103
⑤ Vanity mirror .....	page 5-96
⑥ Moonroof switch .....	page 3-31
⑦ Overhead lights .....	page 5-97
⑧ Rearview mirror .....	page 3-26
⑨ Sunvisor .....	page 5-96
⑩ Cup holders .....	page 5-102
⑪ Front seat .....	page 2-4
⑫ Center console .....	page 5-104
⑬ Rear seat .....	page 2-7

**1-4** The equipment and installation position varies by vehicle

Pictorial Index  
**Exterior Overview**

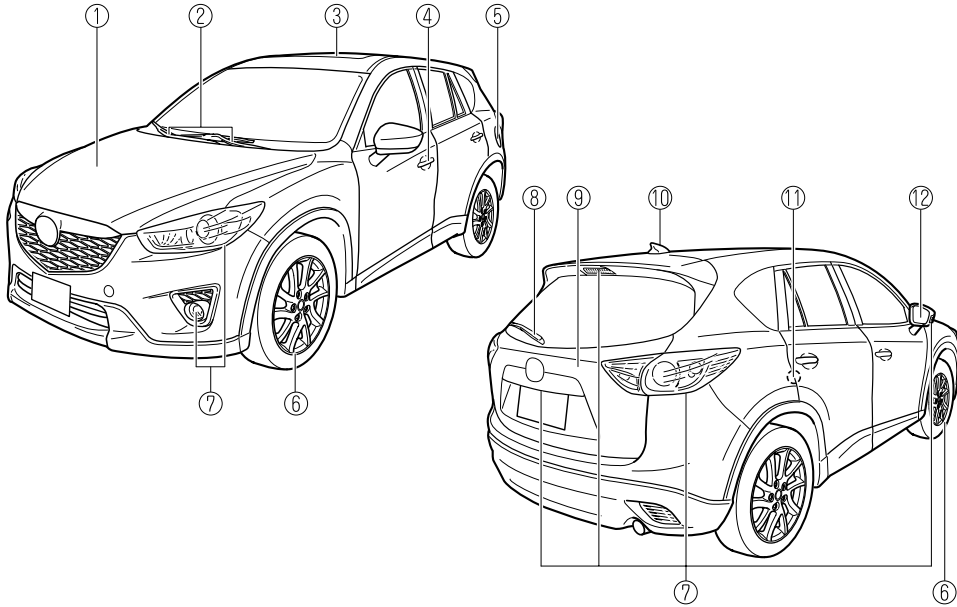

① Hood .....	page 6-17
② Windshield wiper blades .....	page 6-26
③ Moonroof .....	page 3-31
④ Doors and keys .....	page 3-11
⑤ Fuel-filler lid .....	page 3-22
⑥ Wheels and Tires .....	page 6-35
⑦ Exterior lights .....	page 6-40
⑧ Rear window wiper blade .....	page 6-28
⑨ Liftgate .....	page 3-16
⑩ Antenna .....	page 5-13
⑪ Child safety locks .....	page 3-16
⑫ Outside mirror .....	page 3-25

The equipment and installation position varies by vehicle **1-5**

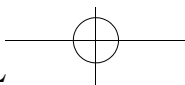
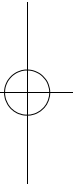
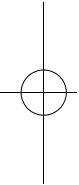
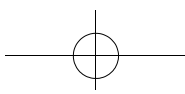

# 2

## Essential Safety Equipment

Important information about safety equipment, including seats, seat belt system, child-restraint systems and SRS air bags.

<b>Seats .....</b>	<b>2-2</b>
Seat Precaution .....	2-2
Front Seat .....	2-4
Rear Seat .....	2-7
Head Restraints .....	2-11
<b>Seat Belt Systems .....</b>	<b>2-13</b>
Seat Belt Precautions .....	2-13
Seat Belt .....	2-16
Seat Belt Warning Systems .....	2-17
Front Seat Belt Pretensioner and Load Limiting Systems .....	2-17
Center-Rear Position Seat Belt .....	2-19
Seat Belt Extender .....	2-20
<b>Child Restraint .....</b>	<b>2-22</b>
Child Restraint Precautions .....	2-22
Child-Restraint System Installation .....	2-27
Installing Child-Restraint Systems .....	2-28
<b>SRS Air Bags .....</b>	<b>2-38</b>
Supplemental Restraint System (SRS) Precautions .....	2-38
Supplemental Restraint System Components .....	2-45
How the SRS Air Bags Work .....	2-46
SRS Air Bag Deployment Criteria .....	2-50
Limitations to SRS Air Bag .....	2-51
Driver and Front Passenger Occupant Classification System * .....	2-53
Constant Monitoring .....	2-59
<b>Secondary Collision Reduction (SCR) .....</b>	<b>2-60</b>
Secondary Collision Reduction (SCR) .....	2-60

\*Some models. **2-1**

Essential Safety Equipment

## Seats

### Seat Precaution

#### WARNING

**Make sure the adjustable components of a seat are locked in place:**

*Adjustable seats and seatbacks that are not securely locked are dangerous. In a sudden stop or collision, the seat or seatback could move, causing injury. Make sure the adjustable components of the seat are locked in place by attempting to slide the seat forward and backward and rocking the seatback.*

**Do not drive with the seatback unlocked:**

*All of the seatbacks play an important role in your protection in a vehicle. Leaving the seatback unlocked is dangerous as it can allow passengers to be ejected or thrown around and baggage to strike occupants in a sudden stop or collision, resulting in severe injury. After adjusting the seatback at any time, even when there are no other passengers, rock the seatback to make sure it is locked in place.*

**Adjust the driver's seat only when the vehicle is stopped:**

*Adjusting the driver's seat while the vehicle is moving is dangerous. The driver could lose control of the vehicle and have an accident.*

**Do not modify or replace the front seats:**

*Modifying or replacing the front seats such as replacing the upholstery or loosening any bolts is dangerous. The front seats contain air bag components essential to the supplemental restraint system. Such modifications could damage the supplemental restraint system and result in serious injury. Consult an Authorized Mazda Dealer if there is any need to remove or reinstall the front seats.*

**Do not drive with damaged front seats:**

*Driving with damaged front seats is dangerous. A collision, even one not strong enough to inflate the air bags, could damage the front seats which contain essential air bag components. If there was a subsequent collision, an air bag may not deploy which could lead to injuries. Always have an Authorized Mazda Dealer inspect the front seats, front seat belt pretensioners and air bags after a collision.*

**Do not drive with either front seats reclined:**

*Sitting in a reclined position while the vehicle is moving is dangerous because you do not get the full protection from seat belts. During sudden braking or a collision, you can slide under the lap belt and suffer serious internal injuries. For maximum protection, sit well back and upright.*

**Do not stack cargo higher than the seatbacks:**

*Stacking luggage or other cargo higher than the seatbacks is dangerous. During sudden braking or a collision, objects can fly around and become projectiles that may hit and injure passengers.*

Essential Safety Equipment  
**Seats**

**Make sure luggage and cargo is secured before driving:**

*Not securing cargo while driving is dangerous as it could move or be crushed during sudden braking or a collision and cause injury.*

**Never allow a passenger to sit or stand on the folded seatback while the vehicle is moving:**

*Driving with a passenger on the folded seatback is dangerous. Allowing a child to sit up on the folded seatback while the vehicle is moving is particularly dangerous. In a sudden stop or even a minor collision, a child not in a proper seat or child-restraint system and seat belt could be thrown forward, back or even out of the vehicle resulting in serious injuries or death. The child in the baggage area could be thrown into other occupants and cause serious injury.*

**⚠ CAUTION**

- *When operating a seat, be careful not to put your hands or fingers near the moving parts of the seat or on the side trim to prevent injury.*
- **(Manual Seat)**  
*When returning a rear-reclined seatback to its upright position, make sure you hold onto the seatback with your other hand while operating the lever. If the seatback is not supported, it will flip forward suddenly and could cause injury.*
- **(Power Seat)**  
*The seat-bottom power adjustment is operated by motors. Avoid extended operation because excessive use can damage the motors.*
  - *To prevent the battery from running down, avoid using the power adjustment when the engine is stopped. The adjuster uses a large amount of electrical power.*
  - *Do not use the switch to make more than one adjustment at a time.*

**NOTE**

*When returning a rear seat to its original position, also replace the seat belt to its normal position. Verify that the seat belt pulls out and retracts.*

Essential Safety Equipment

# Seats

## Front Seat

### ▼ Seat Operation

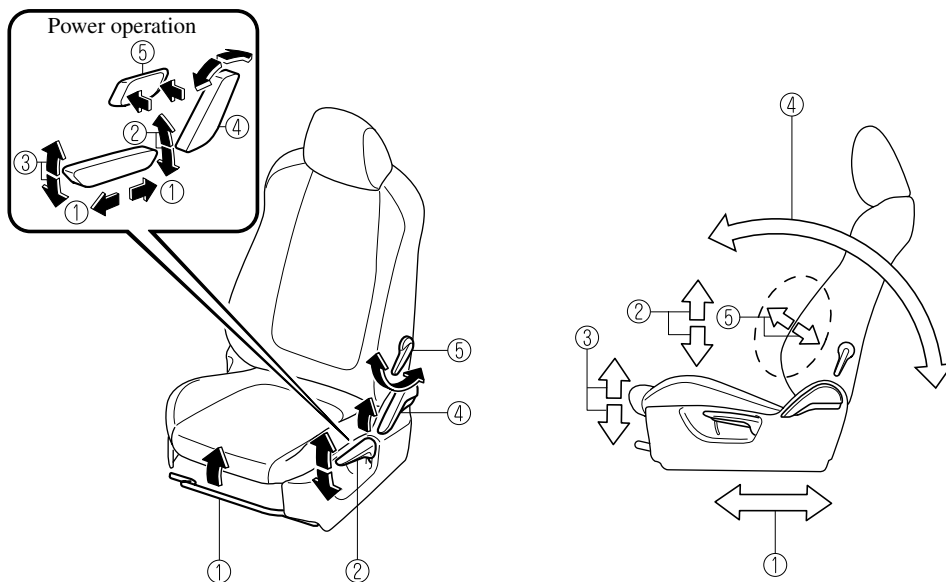

#### ① Seat Slide

(Manual Seat)

To move a seat forward or backward, raise the lever and slide the seat to the desired position and release the lever.

Make sure the lever returns to its original position and the seat is locked in place by attempting to push it forward and backward.

(Power Seat)

To slide the seat, move the slide lifter switch on the outside of the seat to the front or back and hold it. Release the switch at the desired position.

#### ② Height Adjustment (Driver's Seat)

(Manual Seat)

To adjust the seat height, move the lever up or down.

(Power Seat)

To adjust the seat height, move the switch up or down.

#### ③ Front Height Adjustment of Seat Bottom (Driver's Seat)\*

(Power Seat)

To adjust the front height of the seat bottom, raise or lower the front of the slide lifter switch.



④ **Seat Recline**

(Manual Seat)

To change the seatback angle, lean forward slightly while raising the lever. Then lean back to the desired position and release the lever.

Make sure the lever returns to its original position and the seatback is locked in place by attempting to push it forward and backward.

(Power Seat)

To change the seatback angle, press the front or rear side of the reclining switch. Release the switch at the desired position.

⑤ **Lumbar Support Adjustment (Driver's Seat) \***

(Manual Operation)

To increase the seat firmness, push the lever backward. Pull the lever forward to decrease firmness.

(Power Operation)

To increase the seat firmness, press and hold the front part of the switch to the desired position, then release it.

Press the rear part of the switch to decrease firmness.

Essential Safety Equipment

## Seats

### ▼ Seat Warmer\*

The front seats are electrically heated. The ignition must be switched ON. Press the seat warmer switch to illuminate the indicator light while the ignition is switched ON. The mode changes as follow each time the seat warmer switch is pressed.

#### Fully Automatic Type Climate Control

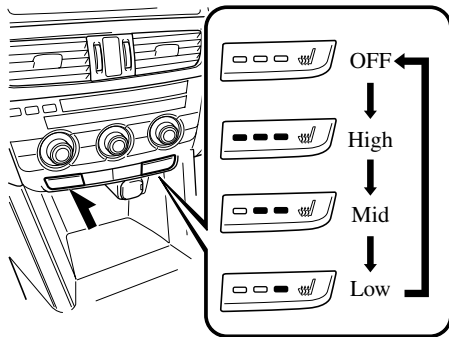

#### Manual Type Climate Control

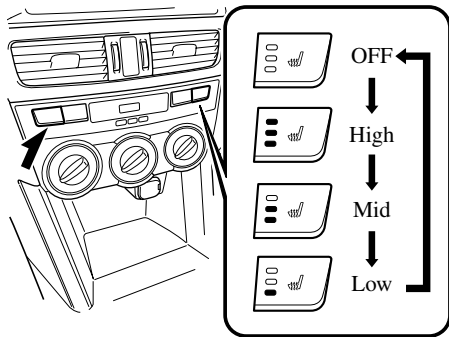

### **⚠ WARNING**

#### **Be careful when using the seat warmer:**

*The heat from the seat warmer may be too hot for some people, as indicated below, and could cause a low-temperature burn.*

- *Infants, small babies, elderly people, and physically challenged people*
- *People with delicate skin*
- *People who are excessively fatigued*
- *People who are intoxicated*
- *People who have taken sleep-inducing medicine such as sleeping pills or cold medicine*

#### **Do not use the seat warmer with anything having high moisture-retention ability such as a blanket or cushion on the seat:**

*The seat may be heated excessively and cause a low-temperature burn.*

#### **Do not use the seat warmer even when taking a short nap in the vehicle:**

*The seat may be heated excessively and cause a low-temperature burn.*

#### **Do not place heavy objects with sharp projections on the seat, or insert needles or pins into it:**

*This could cause the seat to become excessively heated and result in injury from a minor burn.*

### **⚠ CAUTION**

*Do not use organic solvents to clean the seat. It may damage the seat surface and the heater.*

**NOTE**

- *If the ignition is switched off while the seat warmer is operating (High, Mid or Low) and then switched ON again, the seat warmer will automatically operate at the temperature set before switching off the ignition.*
- *Use the seat warmer when the engine is running, and do not continue to use it for a long period of time.*
- *The temperature of the seat warmer cannot be adjusted beyond High, Mid and Low because the seat warmer is controlled by a thermostat.*

## Rear Seat

### ▼ Split Folding

The seatbacks can be folded down to provide more space in the luggage compartment.

### **⚠ WARNING**

**Tightly secure cargo in the luggage compartment when it is transported with the seatbacks folded down:**

*Driving without tightly securing cargo and luggage is dangerous as it could move and become an obstruction to driving during emergency braking or a collision resulting in an unexpected accident.*

**Always remove the child-restraint system from the rear seat before operating the remote handle levers for the rear seat:**

*Operating the remote handle levers while a rear-facing child-restraint system is in the rear seat is dangerous. It could cause injury to a child seated in the child-restraint system when the seatback suddenly flips forward.*

**Make sure there is nobody in the rear seat area before operating (pulling) the remote handle levers (Vehicles with remote handle):**

*Not checking the rear seat area for persons before folding the seatbacks with the strap/remote handle levers is dangerous. The rear seat area is difficult to see from the rear of the vehicle. Operating (pulling) the remote handle levers without checking could cause injury to a person when a seatback suddenly flips forward.*

Essential Safety Equipment

## Seats

### **CAUTION**

- *When operating the rear seatback knob, make sure you support the seatback with your hand. If the seatback is not supported with your hand, it will flip forward suddenly and could cause injury to the finger that pushes the rear seatback knob down.*
- *(Vehicles with remote handle) Before folding the seatbacks down with the remote handle levers, make sure there is no cup in a rear cup holder. Folding the seatbacks with the remote handle levers while a cup is in the cup holder could soil or damage the seat bottom and seatback.*
- *(Vehicles with remote handle) Be careful of the following when using the remote handle levers:
  - *On a downward slope, the seatback could flip forward faster than on a flat surface.*
  - *On an upward slope, the seatback may not fold down. When the seatbacks cannot be folded down with levers, pull the rear seatback forward from inside the vehicle.**

### **Folding both seatbacks down**

#### **Using remote handle\***

After checking that the rear seats are clear, open the liftgate compartment and pull the remote handle levers on the left and right sides of the liftgate compartment.

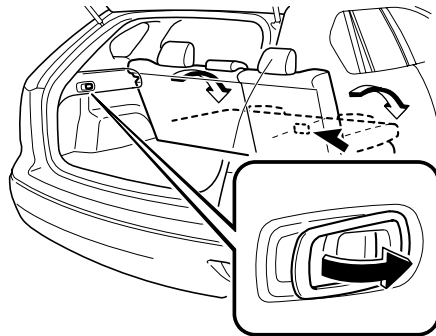

#### **Using push knob**

Push the rear seatback knob down.

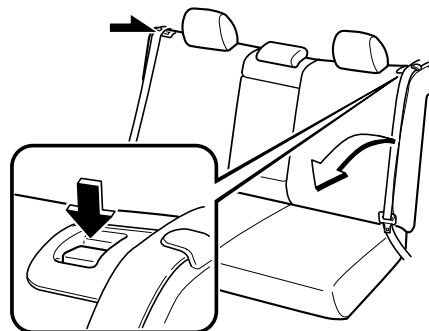

Essential Safety Equipment  
**Seats**

**Folding only center seat \***

**⚠ CAUTION**

*Be careful when operating the remote handle with the center seat folded down. If a person sitting in the right rear seat places a hand on the center seat, it could be pinched by a seatback or seat component causing injury.*

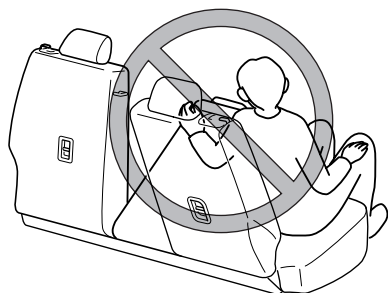

**Using remote handle**

1. Store the center seat head restraint.
2. After checking that the center seat is clear, open the liftgate compartment and pull the inside remote handle levers on the left side of the liftgate compartment.

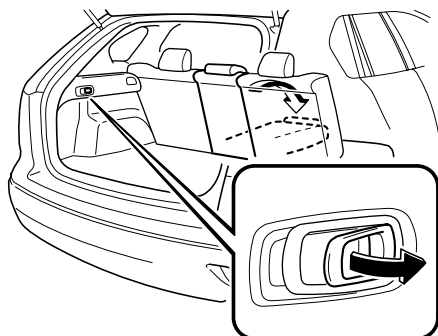

**Using strap**

1. Store the center seat head restraint.
2. Pull the strap on the back of the seatback to fold the seatback forward.

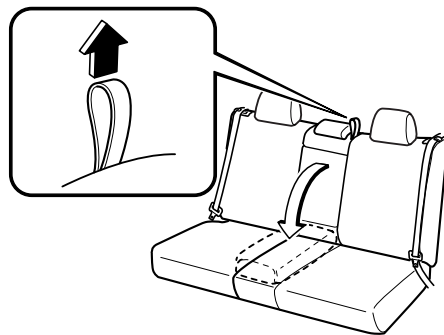

**To return the seatbacks to the upright position**

1. Lift the seatbacks upright.
2. Pull on the top of the seatbacks from inside the vehicle to make sure they are locked.

\*Some models.

Essential Safety Equipment

## Seats

### **⚠ WARNING**

**Always make sure the seat belts are fully pulled out from under the seatbacks:**

*A seat belt caught under a seatback after the seatback is returned to its upright position is dangerous. In a collision or sudden stop, the seat belt cannot provide adequate protection.*

**When returning the seatback to the upright position, make sure there is no red indication:**

*A rear seatback not fully returned and locked in the upright position is dangerous. Sudden stops or maneuvering could cause a seatback to flip forward suddenly resulting in injury. If the red indicator is visible on the back of the rear seatback knob, the seatback is not locked in the upright position.*

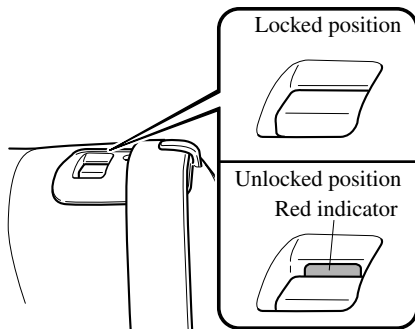

### **▼ Armrest\***

The rear armrest in the center of the rear seatback can be used (no occupant in the center seat) or placed upright.

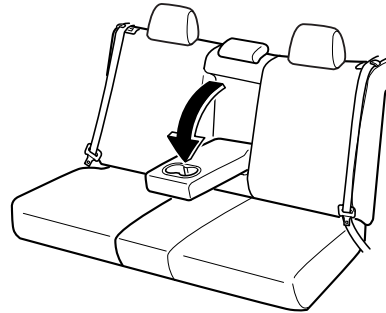

Essential Safety Equipment  
**Seats**

## Head Restraints

Your vehicle is equipped with head restraints on all outboard seats and the rear center seat. The head restraints are intended to help protect you and the passengers from neck injury.

### **⚠ WARNING**

***Always drive with the head restraints installed when seats are being used and make sure they are properly adjusted.:***

*Driving with the head restraints adjusted too low or removed is dangerous. With no support behind your head, your neck could be seriously injured in a collision.*

### **Height adjustment**

To raise a head restraint, pull it up to the desired position.

To lower the head restraint, press the stop-catch release, then push the head restraint down.

Adjust the head restraint so that the center is even with the top of the passenger's ears.

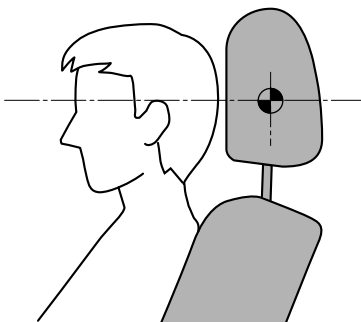

### Front outboard seat

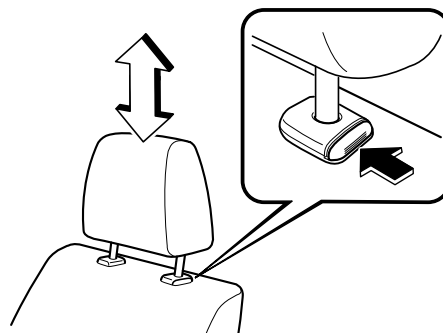

### Rear outboard seat

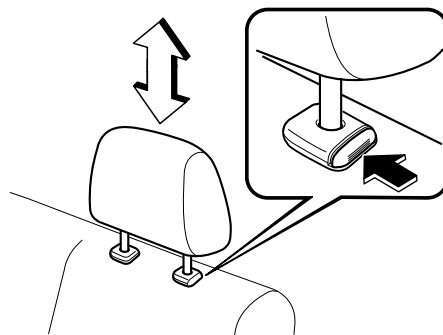

### Rear center seat

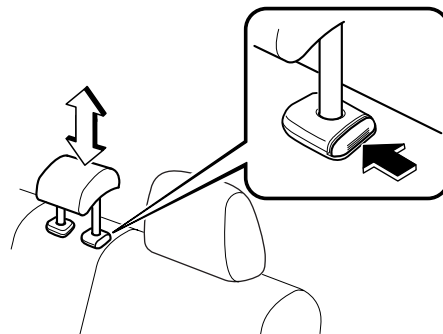

Essential Safety Equipment

## Seats

---

### **Removal/Installation**

To remove the head restraint, pull it up while pressing the stop-catch.

To install the head restraint, insert the uprights into the holes while pressing the stop-catch.

### **WARNING**

***Always drive with the head restraints set up when seats are being used and make sure they are properly set up:***

*Driving with the head restraints not set up is dangerous. With no support behind your head, your neck could be seriously injured in a collision.*



Essential Safety Equipment  
**Seat Belt Systems**

## Seat Belt Precautions

Seat belts help to decrease the possibility of severe injury during accidents and sudden stops. Mazda recommends that the driver and all passengers always wear seat belts.

All of the seat belt retractors are designed to keep the lap/shoulder belts out of the way when not in use.

The driver's seat belt has no provisions for child-restraint systems and has only an emergency locking mode. The driver may wear it comfortably, and it will lock during a collision.

However, in some models (with automatic locking mode) the front passenger's seat and all rear lap/shoulder belt retractors operate in two modes: emergency locking mode, and for child-restraint systems, automatic locking mode. While we recommend you put all children in the rear seats, if you must use the front passenger seat for a child, slide the front passenger seat as far back as possible and make sure any child-restraint system is secured properly.

### **⚠ WARNING**

***Always wear your seat belt and make sure all occupants are properly restrained:***

*Not wearing a seat belt is extremely dangerous. During a collision, occupants not wearing seat belts could hit someone or things inside the vehicle or even be thrown out of the vehicle. They could be seriously injured or even killed. In the same collision, occupants wearing seat belts would be much safer.*

***Do not wear twisted seat belts:***

*Twisted seat belts are dangerous. In a collision, the full width of the belt is not available to absorb the impact. This puts more force on the bones beneath the belt, which could cause serious injury or death. So, if your seat belt is twisted, you must straighten the seat belt to remove any twists and to allow the full width of the belt to be used.*

***Never use one seat belt on more than one person at a time:***

*Using one seat belt for more than one person at a time is dangerous. A seat belt used in this way cannot spread the impact forces properly and the two passengers could be crushed together and seriously injured or even killed. Never use one belt for more than one person at a time and always operate the vehicle with each occupant properly restrained.*

***Do not operate a vehicle with a damaged seat belt:***

*Using a damaged seat belt is dangerous. An accident could damage the belt webbing of the seat belt in use. A damaged seat belt cannot provide adequate protection in a collision. Have an Authorized Mazda Dealer inspect all seat belt systems in use during an accident before they are used again.*

Essential Safety Equipment

## Seat Belt Systems

---

**Have your seat belts changed immediately if the pretensioner or load limiter has been expended:**

*Always have an Authorized Mazda Dealer immediately inspect the front seat belt pretensioners and air bags after any collision. Like the air bags, the front seat belt pretensioners and load limiters will only function once and must be replaced after any collision that caused them to deploy. A seat belt with an expended pretensioner or load limiter is still better than wearing no seat belt at all; however, if the front seat belt pretensioners and load limiters are not replaced, the risk of injury in a collision will increase.*

**Positioning the Shoulder Portion of the Seat Belt:**

*Improper positioning of the shoulder portion of the seat belt is dangerous. Always make sure the shoulder portion of the seat belt is positioned across your shoulder and near your neck, but never under your arm, on your neck, or on your upper arm.*

**Positioning the Lap Portion of the Seat Belt:**

*The lap portion of the seat belt worn too high is dangerous. In a collision, this would concentrate the impact force directly on the abdominal area, causing serious injury. Wear the lap portion of the belt snugly and as low as possible.*

*In a rollover crash, an unbelted person is significantly more likely to die than a person wearing a seat belt.*

**⚠ CAUTION**

*Belt retraction may become difficult if the belts and rings are soiled, so try to keep them clean. For more details about cleaning the seat belts, refer to "Cleaning the Lap/Shoulder Belt Webbing" (page 6-62).*

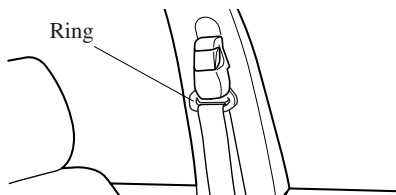

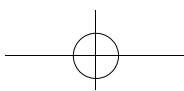

Essential Safety Equipment  
**Seat Belt Systems**

---

**▼ Pregnant Women and Persons with Serious Medical Conditions**

Pregnant women should always wear seat belts. Ask your doctor for specific recommendations.

The lap belt should be worn **SNUGLY AND AS LOW AS POSSIBLE OVER THE HIPS**. The shoulder belt should be worn across your shoulder properly, but never across the stomach area.

Persons with serious medical conditions also should wear seat belts. Check with your doctor for any special instructions regarding specific medical conditions.



**▼ Emergency Locking Mode**

When the seat belt is fastened, it will always be in the emergency locking mode. In the emergency locking mode, the belt remains comfortable on the occupant and the retractor will lock in position during a collision.

If the belt is locked and cannot be pulled out, retract the belt once, and then try pulling it out slowly. If this fails, pull the belt strongly one time and loosen, then pull it out again slowly.

In some models (with automatic locking mode), when the seat belt is fastened, it will always be in the emergency locking mode until it is switched to automatic locking mode by pulling it all the way out to its full length. If the belt feels tight and hinders comfortable movement while the vehicle is stopped or in motion, it may be in the automatic locking mode because the belt has been pulled too far out. To return the belt to the more comfortable emergency locking mode, wait until the vehicle has stopped in a safe, level area, retract the belt fully to convert it back to emergency locking mode and then extend it around you again.

**▼ Automatic Locking Mode\***

Always use the automatic locking mode to keep the child-restraint system from shifting to an unsafe position in the event of an accident. To enable seat belt automatic locking mode, pull it all the way out and connect it as instructed on the child-restraint system. It will retract down to the child-restraint system and stay locked on it. See the section on child restraint (page 2-22).

\*Some models. **2-15**

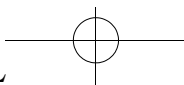

Essential Safety Equipment

# Seat Belt Systems

## Seat Belt

### ▼ Fastening the Seat Belt

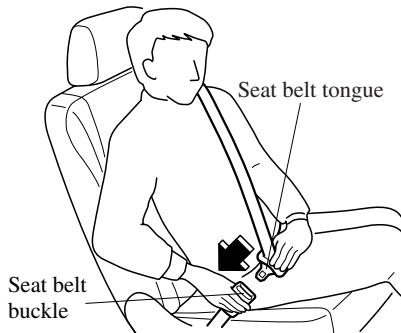

Position the lap belt as low as possible, not on the abdominal area, then adjust the shoulder belt so that it fits snugly against your body.

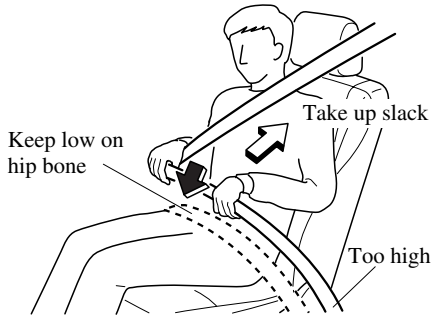

### ▼ Unfastening the Seat Belt

Depress the button on the seat belt buckle. If the belt does not fully retract, pull it out and check for kinks or twists. Then make sure it remains untwisted as it retracts.

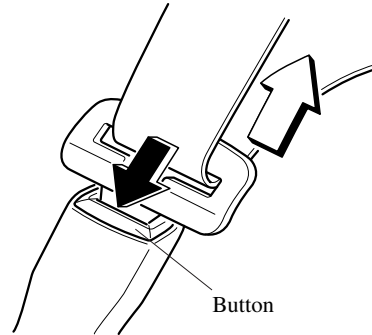

#### **NOTE**

*If a belt does not fully retract, inspect it for kinks and twists. If it is still not retracting properly, have it inspected at an Authorized Mazda Dealer.*

### ▼ Front Shoulder Belt Adjuster

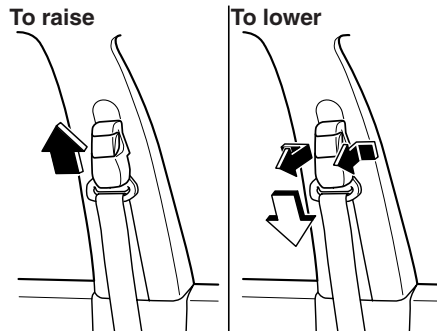

Make sure the adjuster is locked.

Essential Safety Equipment  
**Seat Belt Systems**

**Seat Belt Warning Systems**

If it detects that the driver's seat belt is unfastened, the warning light or beep alerts the driver.

Refer to Warning/Indicator Lights on page 4-15.

**Front Seat Belt Pretensioner and Load Limiting Systems**

For optimum protection, the driver and front passenger seat belts are equipped with pretensioner and load limiting systems. For both these systems to work properly you must wear the seat belt properly.

**Pretensioners:**

In moderate or severe frontal or near-frontal accidents, the front air bag and pretensioner systems deploy simultaneously.

For deployment details, refer to the SRS Air Bag Deployment Criteria (page 2-50). The front seat belt retractors remove slack quickly as the air bags are expanding. Any time the air bags and seat belt pretensioners have fired they must be replaced.

A system malfunction or operation conditions are indicated by a warning. Refer to Warning/Indicator Lights on page 4-15.

Refer to Air Bag/Front Seat Belt Pretensioner System Warning Beep on page 7-32.

**(With Driver and Front Passenger Occupant Classification System)**

In addition, the pretensioner system for the front passenger, like the front and side passenger air bag, is designed to only deploy in accordance with the total seated weight on the front passenger seat.

For details, refer to the front passenger seat weight sensors(page 2-53).

Essential Safety Equipment

## Seat Belt Systems

### Load limiter:

The load limiting system releases belt webbing in a controlled manner to reduce belt force on the occupant's chest. While the most severe load on a seat belt occurs in frontal collisions, the load limiter has an automatic mechanical function and can activate in any accident mode with sufficient occupant movement.

Even if the pretensioners have not fired, the load limiting function must be checked by an Authorized Mazda Dealer.

### **WARNING**

***Wear seat belts only as recommended in this owner's manual:***

*Incorrect positioning of the driver and front passenger seat belts is dangerous. Without proper positioning, the pretensioner and load limiting systems cannot provide adequate protection in an accident and this could result in serious injury. For more details about wearing seat belts, refer to "Fastening the seat belts" (page 2-16).*

***Have your seat belts changed immediately if the pretensioner or load limiter has been expended:***

*Always have an Authorized Mazda Dealer immediately inspect the front seat belt pretensioners and air bags after any collision. Like the air bags, the front seat belt pretensioners and load limiters will only function once and must be replaced after any collision that caused them to deploy. A seat belt with an expended pretensioner or load limiter is still better than wearing no seat belt at all; however, if the front seat belt pretensioners and load limiters are not replaced, the risk of injury in a collision will increase.*

***Do not modify the components or wiring, or use electronic testing devices on the pretensioner system:***

*Modifying the components or wiring of the pretensioner system, including the use of electronic testing devices is dangerous. You could accidentally activate it or make it inoperable which would prevent it from activating in an accident. The occupants or repairers could be seriously injured.*

***Properly dispose of the pretensioner system:***

*Improper disposal of the pretensioner system or a vehicle with non-deactivated pretensioners is dangerous. Unless all safety procedures are followed, injury could result. Ask an Authorized Mazda Dealer how to safely dispose of the pretensioner system or how to scrap a pretensioner-equipped vehicle.*

Essential Safety Equipment  
**Seat Belt Systems**

**NOTE**

- The pretensioner system will activate in a moderate or greater frontal or near-frontal, or a severe side collision. It will not activate in most rollovers, rear impacts.

**(With Driver and Front Passenger Occupant Classification System)**

The pretensioner system will activate in a severe roll-over accident.

In addition, the pretensioner system for the front passenger is designed to only deploy in accordance with the total seated weight on the front passenger seat.

- Some smoke (non-toxic gas) will be released when the air bags and pretensioners deploy. This does not indicate a fire. This gas normally has no effect on occupants, however, those with sensitive skin may experience light skin irritation. If residue from the deployment of the air bags or the front pretensioner system gets on the skin or in the eyes, wash it off as soon as possible.

### Center-Rear Position Seat Belt

Before using the center-rear lap/shoulder belt make sure tongue (A) and anchor buckle (B) are fastened.

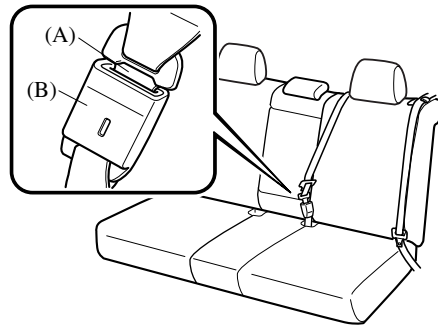

#### ▼ Fastening the Seat Belt

1. Grasp the seat belt tongue (C).
2. Slowly pull out the lap/shoulder belt.
3. Insert the seat belt tongue (C) into the seat belt buckle (D) until you hear a click sound.

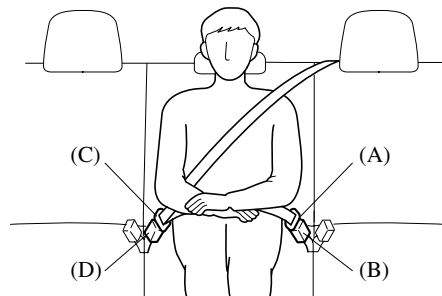

Essential Safety Equipment

## Seat Belt Systems

### **WARNING**

#### ***Fastening the Center-Rear Seat Belt with Only One Buckle:***

*Fastening the center-rear seat belt with only one buckle is dangerous. If only one pair of seat belt tongues and buckles is fastened (either seat belt tongue (C) and seat belt anchor buckle (D) or seat belt tongue (A) and seat belt buckle (B)), then the seat belt cannot provide full protection. In a sudden stop or collision, the user could slide under the belt and suffer serious injuries. Always make sure that both pairs of seat belt tongues and buckles are fastened properly.*

### **Seat Belt Extender**

If your seat belt is not long enough, even when fully extended, a seat belt extender may be available to you at no charge from your Authorized Mazda Dealer.

This extender will be only for you and for the particular vehicle and seat. Even if it plugs into other seat belts, it may not hold in the critical moment of a crash.

When ordering an extender, only order one that provides the necessary additional length to fasten the seat belt properly.

Please contact your Authorized Mazda Dealer for more information.

### **WARNING**

#### ***Do not use a seat belt extender unless it is necessary:***

*Using a seat belt extender when not necessary is dangerous. The seat belt will be too long and not fit properly. In an accident, the seat belt will not provide adequate protection and you could be seriously injured. Only use the extender when it is required to fasten the seat belt properly.*



Essential Safety Equipment  
**Seat Belt Systems**

**Do not use an improper extender:**

*Using a seat belt extender that is for another person or a different vehicle or seat is dangerous. The seat belt will not provide adequate protection and the user could be seriously injured in an accident. Only use the extender provided for you and for the particular vehicle and seat. NEVER use the extender in a different vehicle or seat. If you sell your Mazda, do not leave your seat belt extender in the vehicle. It could be used accidentally by the new owner of the vehicle. After removing the seat belt extender, discard it. Never use the seat belt extender in any other vehicle you may own in the future.*

**Do not use an extender that is too long:**

*Using an extender that is too long is dangerous. The seat belt will not fit properly. In an accident, the seat belt will not provide adequate protection and you could be seriously injured. Do not use the extender or choose one shorter in length if the distance between the extender's buckle and the center of the user's body is less than 15 cm (6 in).*

**Do not leave a seat belt extender connected to the buckle:**

*Leaving a seat belt extender connected to the buckle without using the seat belt is dangerous. When the seat belt extender is connected to the driver's seat belt buckle (or front passenger) seat, the SRS driver's (or front passenger's) air bag system will determine that the driver (or front passenger) is wearing the seat belt even if the driver (or front passenger) is not wearing it. This condition could cause the driver's (or front passenger's) air bag to not activate correctly and result in death or serious injury in the event of collision. Always wear the seat belt with the seat belt extender.*

**Do not use the seat belt extender when installing a child-restraint system on the front or rear passenger seat:**

*Using a seat belt extender to fasten a child-restraint system on any seat is dangerous. Always follow the child-restraint system manufacturer's installation instructions and never use a seat belt extender.*

**NOTE**

*When not in use, remove the seat belt extender and store it in the vehicle. If the seat belt extender is left connected, the seat belt extender might get damaged as it will not retract with the rest of the seat belt and can easily fall out of the door when not in use and be damaged. In addition, the seat belt warning light will not illuminate and function properly.*



Essential Safety Equipment

## Child Restraint

### Child Restraint Precautions

Mazda strongly urges the use of child-restraint systems for children small enough to use them.

You are required by law to use a child-restraint system for children in the U.S. and Canada. Check your local and state or provincial laws for specific requirements regarding the safety of children riding in your vehicle.

Whatever child-restraint system you consider, please pick the appropriate one for the age and size of the child, obey the law and follow the instructions that come with the individual child-restraint system.

A child who has outgrown child-restraint systems should sit in the rear and use seat belts, both lap and shoulder. If the shoulder belt crosses the neck or face, move the child closer to the center of the vehicle in the outboard seats, and towards the buckle on the right if the child is seated on the center seat.

Statistics confirm that the rear seat is the best place for all children up to 12 years of age, and more so with a supplemental restraint system (air bags).

A rear-facing child-restraint system should **NEVER** be used on the front seat with the air bag system activated. The front passenger's seat is also the least preferred seat for other child-restraint systems.

#### **(With Driver and Front Passenger Occupant Classification System)**

To reduce the chance of injuries caused by deployment of the front passenger air bag, the front passenger seat weight sensors work as a part of the supplemental restraint system. This system deactivates the front passenger front and side air bags and also the front passenger seat belt pretensioner system when the front passenger air bag deactivation indicator light illuminates.

When an infant or small child sits on the front passenger seat, the system shuts off the front passenger front and side air bags and seat belt pretensioner system, so make sure the front passenger air bag deactivation indicator light illuminates.

Even if the front passenger air bag is shut off, Mazda strongly recommends that children be properly restrained and child-restraint systems of all kinds are properly secured on the rear seats which are the best place for children.

For more details, refer to “Front passenger seat weight sensors” (page 2-53).

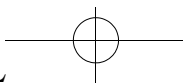

Essential Safety Equipment  
**Child Restraint**

**⚠ WARNING**

**Use the correct size child-restraint system:**

*For effective protection in vehicle accidents and sudden stops, a child must be properly restrained using a seat belt or child-restraint system depending on age and size. If not, the child could be seriously injured or even killed in an accident.*

**Follow the manufacturer's instructions and always keep the child-restraint system buckled down:**

*An unsecured child-restraint system is dangerous. In a sudden stop or a collision it could move causing serious injury or death to the child or other occupants. Make sure any child-restraint system is properly secured in place according to the child-restraint system manufacturer's instructions. When not in use, remove it from the vehicle or fasten it with a seat belt, or latch it down to BOTH LATCH lower anchors for LATCH child-restraint systems and the corresponding tether anchor.*

**Always secure a child in a proper child-restraint system:**

*Holding a child in your arms while the vehicle is moving is extremely dangerous. No matter how strong the person may be, he or she cannot hold onto a child in a sudden stop or collision and it could result in serious injury or death to the child or other occupants. Even in a moderate accident, the child may be exposed to air bag forces that could result in serious injury or death to the child, or the child may be slammed into an adult, causing injury to both child and adult.*

**Never use a rear-facing child-restraint system in the front seat with an air bag that could deploy:**

*Rear-facing child-restraint systems on the front seat are particularly dangerous even though you may feel assured that a front passenger air bag will not deploy based on the fact that the front passenger air bag deactivation indicator light illuminates. The child-restraint system can be hit by a deploying air bag and moved violently backward resulting in serious injury or death to the child.*

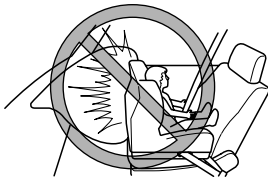

Essential Safety Equipment

## Child Restraint

---

*Some vehicles with a front passenger air bag have a warning label attached as shown below. The warning label reminds you not to put a rear-facing child-restraint system on the front passenger seat at any time.*



**Do not install a front-facing child-restraint system on the front passenger seat unless it is unavoidable:**

*In a collision, the force of a deploying air bag could cause serious injury or death to the child. If installing a front-facing child-restraint system on the front passenger seat is unavoidable, move the front passenger seat as far back as possible.*



Essential Safety Equipment  
**Child Restraint**

**Seating a child in a child-restraint system on the front passenger seat is dangerous under certain conditions (With Driver and Front Passenger Occupant Classification System):**

Your vehicle is equipped with front passenger seat weight sensors. Even with the front passenger seat weight sensors, if you must use the front passenger seat to seat a child, using a child-restraint system on the front passenger seat under the following conditions increases the danger of the front passenger air bag deploying and could result in serious injury or death to the child.

- The front passenger air bag deactivation indicator light does not illuminate when seating a child in the child-restraint system.
- Luggage or other items are placed on the seat with the child in the child-restraint system.
- A rear passenger or luggage pushing or pulling down on the front passenger seatback.
- A rear passenger puts their feet on the front seat rails.
- Luggage or other items are placed on the seatback or hung on the head restraint.
- Heavy items are placed in the seatback map pocket.
- The seat is washed.
- Liquids are spilled on the seat.
- The front passenger seat is moved backward, pushing into luggage or other items placed behind it.
- The front passenger seatback contacts the rear seat.
- Luggage or other items are placed between the front passenger seat and driver seat.
- Any accessories, which might increase the total seated weight on the front passenger seat, are attached to the front passenger seat.

The designated positions with seat belts on the rear seats are the safest places for children. Always use seat belts and child restraints.

**Do not allow a child or anyone to lean over or against the side window of a vehicle with side and curtain air bags:**

It is dangerous to allow anyone to lean over or against the side window, the area of the front passenger seat, the front and rear window pillars and the roof edge along both sides from which the side and curtain air bags deploy, even if a child-restraint system is used. The impact of inflation from a side or curtain air bag could cause serious injury or death to an out of position child. Furthermore, leaning over or against the front door could block the side and curtain air bags and eliminate the advantages of supplemental protection. With the front air bag and the additional side air bag that comes out of the front seat, the rear seat is always a better location for children. Take special care not to allow a child to lean over or against the side window, even if the child is seated in a child-restraint system.

Essential Safety Equipment

## Child Restraint

---

**Never use one seat belt on more than one person at a time:**

*Using one seat belt for more than one person at a time is dangerous. A seat belt used in this way cannot spread the impact forces properly and the two passengers could be crushed together and seriously injured or even killed. Never use one belt for more than one person at a time and always operate the vehicle with each occupant properly restrained.*

**Always remove the child-restraint system from the rear seat before operating the remote handle levers for the rear seat:**

*Operating the remote handle levers while a rear-facing child-restraint system is in the rear seat is dangerous. It could cause injury to a child seated in the child-restraint system when the seatback suddenly flips forward.*

**⚠ CAUTION**

*A seat belt or child-restraint system can become very hot in a closed vehicle during warm weather. To avoid burning yourself or a child, check them before you or your child touches them.*

**NOTE**

*Your Mazda is equipped with LATCH lower anchors for attachment of specially designed LATCH child-restraint systems in the rear seats. When using these anchors to secure a child-restraint system, refer to "Using LATCH Lower Anchor" (page 2-35).*

Essential Safety Equipment  
**Child Restraint**

## Child-Restraint System Installation

### ▼ Child-Restraint System Types

In this owner's manual, explanation of child-restraint systems is provided for the following three types of popular child-restraint systems: infant seat, child seat, booster seat.

#### **NOTE**

- *Installation position is determined by the type of child-restraint system. Always read the manufacturer's instructions and this owner's manual carefully.*
- *Due to variations in the design of child-restraint systems, vehicle seats and seat belts, all child-restraint systems may not fit all seating positions. Before purchasing a child-restraint system, it should be tested in the specific vehicle seating position (or positions) where it is intended to be used. If a previously purchased child-restraint system does not fit, you may need to purchase a different one that will.*

#### **Infant seat**

An infant seat provides restraint by bracing the infant's head, neck and back against the seating surface.

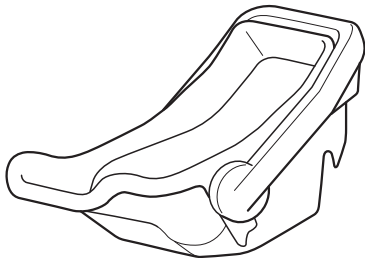

#### **Child seat**

A child seat restrains a child's body using the harness.



#### **Booster seat**

A booster seat is a child restraint accessory designed to improve the fit of the seat belt system around the child's body.

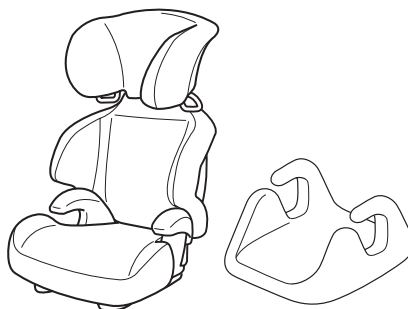

Essential Safety Equipment

## Child Restraint

### Installing Child-Restraint Systems

Accident statistics reveal that a child is safer in the rear seat. The front passenger's seat is clearly the worst choice for any child under 12, and with rear-facing child-restraint systems it is clearly unsafe due to air bags.

#### NOTE

*Even if your vehicle is equipped with front passenger seat weight sensors (page 2-53), which automatically deactivates the front passenger air bag, a rear seat is the safest place for a child of any age or size.*

Some child-restraint systems now come with tethers and therefore must be installed on the seats that take tethers to be effective. In your Mazda, tethered child-restraint systems can only be accommodated in the three positions on the rear seat.

Some child-restraint systems also employ specially designed LATCH attachments; refer to "Using LATCH Lower Anchor" (page 2-35).

### **⚠ WARNING**

***Tethered Child-Restraint Systems Work Only on Tether-Equipped Rear Seats:***

*Installation of a tether equipped child-restraint system in the front passenger's seat defeats the safety design of the system and will result in an increased chance of serious injury if the child-restraint system goes forward without benefit of being tethered.*

*Place tether equipped child-restraint systems where there are tether anchors.*

#### ▼ Anchor Bracket Location

Anchor brackets for securing child-restraint systems are equipped in the vehicle. Locate each anchor position using the illustration.

To install a child-restraint system, always follow the instruction manual accompanying the child-restraint system.

Installation of a child-restraint system equipped with a tether.

#### Anchor bracket location

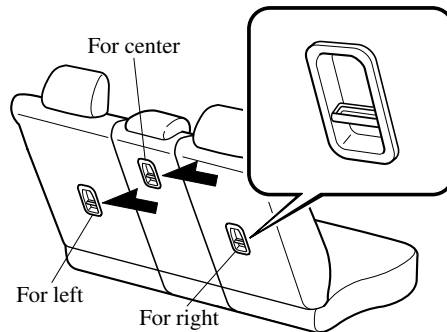



Essential Safety Equipment  
**Child Restraint**

**⚠ WARNING**

**Always attach the tether strap to the correct tether anchor position:**

*Attaching the tether strap to the incorrect tether anchor position is dangerous. In a collision, the tether strap could come off and loosen the child-restraint system. If the child-restraint system moves it could result in death or injury to the child.*

Securing an LATCH-compatible child-restraint system.

**LATCH lower anchor location**

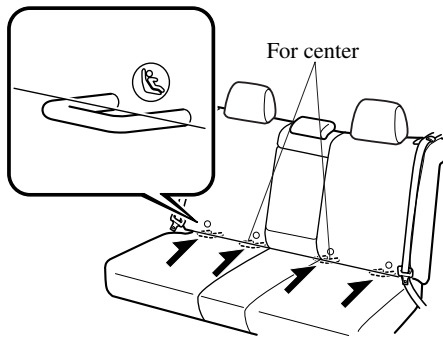

When installing on the center seat, use the anchor for the center seat.

**NOTE**

*The markings above the LATCH lower anchors indicate the locations of the LATCH lower anchors for the attachment of a child-restraint system.*

**▼ Using Automatic Locking Mode**

Follow these instructions when using a child-restraint system, unless you are attaching a LATCH-equipped child-restraint system to the rear LATCH lower anchors. Refer to “Using LATCH Lower Anchor” (page 2-35).

**NOTE**

*Follow the child-restraint system manufacturer's instructions carefully. If you are not sure whether you have a LATCH system or tether, check in the child-restraint system manufacturer's instructions and follow them accordingly. Depending on the type of child-restraint system, it may use LATCH system instead of seat belts or if the belt goes across the child's chest, may recommend against using automatic locking mode.*

1. Make sure the seatback is securely latched by pushing it back until it is fully locked.
2. Raise the head restraint to the top locked position.  
Refer to Head Restraints on page 2-11.
3. Secure the child-restraint system with the lap portion of the lap/shoulder belt. See the manufacturer's instructions on the child-restraint system for belt routing instructions.

Essential Safety Equipment

## Child Restraint

4. To get the retractor into the automatic locking mode, pull the shoulder belt portion of the seat belt until the entire length of the belt is out of the retractor.

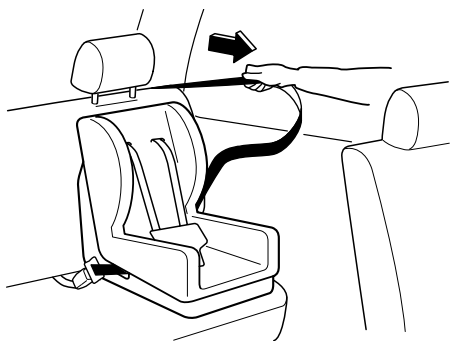

5. Push the child-restraint system firmly into the vehicle seat. Be sure the belt retracts as snugly as possible. A clicking noise from the retractor will be heard during retraction if the system is in the automatic locking mode. If the belt does not lock the seat down tight, repeat this step.

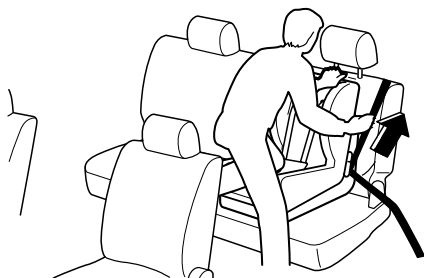

### NOTE

*Inspect this function before each use of the child-restraint system. You should not be able to pull the shoulder belt out of the retractor while the system is in the automatic locking mode. When you remove the child-restraint system, be sure the belt fully retracts to return the system to emergency locking mode before occupants use the seat belts.*

6. If your child-restraint system requires the use of a tether strap, refer to the manufacturer's instructions to hook and tighten the tether strap.

Essential Safety Equipment  
**Child Restraint**

**⚠ WARNING**

**Use the tether and tether anchor only for a child-restraint system:**

*Using the tether or tether anchor to secure anything but a child-restraint system is dangerous. This could weaken or damage the tether or tether anchor and result in injury.*

**Always route the tether strap between the head restraint and the seatback:**

*Routing the tether strap on top of the head restraint is dangerous. In a collision the tether strap could slide off the head restraint and loosen the child-restraint system. The child-restraint system could move which may result in death or injury to the child.*

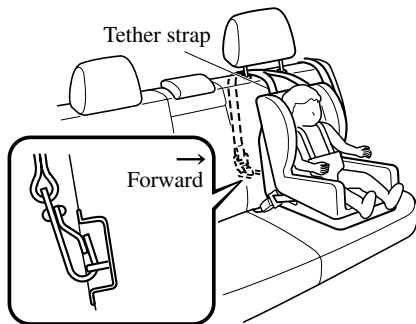

**Always attach the tether strap to the correct tether anchor position:**

*Attaching the tether strap to the incorrect tether anchor position is dangerous. In a collision, the tether strap could come off and loosen the child-restraint system. If the child-restraint system moves it could result in death or injury to the child.*

**▼ If You Must Use the Front Seat for Children**

If you cannot put all children in the rear seat, at least put the smallest children in the rear and be sure the largest child up front uses the shoulder belt over the shoulder.

NEVER put a rear-facing child-restraint system on the front passenger seat whether your vehicle is equipped with a seat weight sensor or not.

This seat is also not set up for tethered child-restraint systems, put them in one of the rear seat positions set up with tether anchors.

Likewise the LATCH child-restraint system cannot be secured in the front passenger's seat and should be used in the rear seat.

Do not allow anyone to sleep against the side window if you have optional side and curtain air bags, it could cause serious injuries to an out of position occupant. As children more often sleep in cars, it is better to put them in the rear seat. If installing the child-restraint system on the front seat is unavoidable, follow these instructions when using a front-facing child-restraint system in the front passenger's seat.

**NOTE**

- To check if your front seats have side air bags:  
*Mazda vehicles equipped with side air bag will have a "SRS AIRBAG" tag on the outboard shoulder of the front seats.*
- To check if your vehicle has curtain air bags:  
*Mazda vehicles equipped with curtain air bag will have an "SRS AIRBAG" marking on the window pillars along the roof edge.*

Essential Safety Equipment

## Child Restraint

### **⚠ WARNING**

**Always move the front passenger seat as far back as possible if installing a front-facing child-restraint system on it is unavoidable:**

*As your vehicle has front air bags and doubly so because your vehicle has side air bags, a front-facing child-restraint system should be put on the front passenger seat only when it is unavoidable.*

*Even if the front passenger air bag deactivation indicator light illuminates, always move the seat as far back as possible, because the force of a deploying air bag could cause serious injury or death to the child.*

**Never use a rear-facing child-restraint system in the front seat with an air bag that could deploy:**

*Rear-facing child-restraint systems on the front seat are particularly dangerous.*

*Even in a moderate collision, the child-restraint system can be hit by a deploying air bag and moved violently backward resulting in serious injury or death to the child. Even though you may feel assured that the front passenger air bag will not deploy based on the fact that the front passenger air bag deactivation indicator light illuminates, you should not use a rear-facing child-restraint system in the front seat.*

**Do not allow a child or anyone to lean over or against the side window of a vehicle with side and curtain air bags:**

*It is dangerous to allow anyone to lean over or against the side window, the area of the front passenger seat, the front and rear window pillars and the roof edge along both sides from which the side and curtain air bags deploy, even if a child-restraint system is used. The impact of inflation from a side or curtain air bag could cause serious injury or death to an out of position child. Furthermore, leaning over or against the front door could block the side and curtain air bags and eliminate the advantages of supplemental protection. With the front air bag and the additional side air bag that comes out of the front seat, the rear seat is always a better location for children. Take special care not to allow a child to lean over or against the side window, even if the child is seated in a child-restraint system.*

### **Front Passenger's Seat Child-Restraint System Installation (With automatic locking mode seat belt)**

1. Switch the ignition ON.

Essential Safety Equipment  
**Child Restraint**

- Slide the seat as far back as possible.

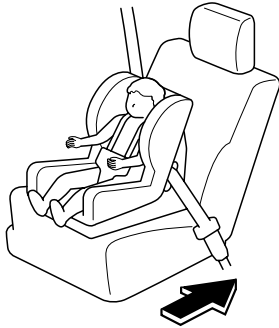

- Place the child-restraint system on the seat without putting your weight on the seat and fasten the seat belt. See the manufacturer's instructions on the child-restraint system for belt routing instructions.
- To get the retractor into the automatic locking mode, pull the shoulder belt portion of the seat belt until the entire length of the belt is out of the retractor.
- Push the child-restraint system firmly into the vehicle seat. Be sure the belt retracts as snugly as possible. A clicking noise from the retractor will be heard during retraction if the system is in automatic locking mode. If the belt does not lock the seat down tight, repeat the previous step and also this one.

**NOTE**

- Inspect this function before each use of the child-restraint system. You should not be able to pull the shoulder belt out of the retractor while the system is in the automatic locking mode. When you remove the child-restraint system, be sure the belt fully retracts to return the system to emergency locking mode before occupants use the seat belts.
  - Follow the child-restraint system manufacturer's instructions carefully. Depending on the type of child-restraint system, it may not employ seat belts which are in automatic locking mode.
- Seat your child safely in the child-restraint system and secure the child according to the instructions from the child-restraint system manufacturer.
  - (With Driver and Front Passenger Occupant Classification System)**  
Make sure the front passenger air bag deactivation indicator light illuminates after installing a child-restraint system on the front passenger seat. If the front passenger air bag deactivation indicator light does not illuminate, remove the child-restraint system, switch the ignition to OFF, and then re-install the child-restraint system. (page 2-53)

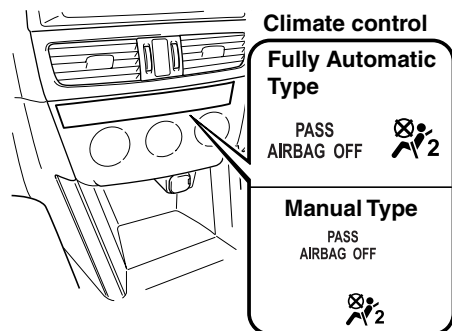

Essential Safety Equipment

## Child Restraint

---

### **WARNING**

***Do not seat a child in a child-restraint system on the front passenger seat if the front passenger air bag deactivation indicator light does not illuminate (With Driver and Front Passenger Occupant Classification System):***

*While it is always better to install any child-restraint system on the rear seat, it is imperative that a child-restraint system **ONLY** be used on the front passenger seat if the deactivation indicator light illuminates when the child is seated in the child-restraint system (page 2-53). Seating a child in a child-restraint system installed on the front passenger seat with the front passenger air bag deactivation indicator light not illuminated is dangerous. If this indicator light does not illuminate, this means that the front passenger front and side air bags, and seat belt pretensioner are ready for deployment. If an accident were to deploy an air bag, a child in a child-restraint system sitting in the front passenger seat could be seriously injured or killed. If the indicator light does not illuminate after seating a child in a child-restraint system on the front passenger seat, seat a child in a child-restraint system on the rear seat and consult an Authorized Mazda Dealer as soon as possible.*



Essential Safety Equipment  
**Child Restraint**

▼ **Using LATCH Lower Anchor**

Your Mazda is equipped with LATCH lower anchors for attachment of specially designed LATCH child-restraint systems in the rear seats. Both anchors must be used, otherwise the seat will bounce around and put the child in danger. Most LATCH child-restraint systems must also be used in conjunction with a tether to be effective. If they have a tether you must use it to better assure your child's safety.

**! WARNING**

**Follow the manufacturer's instructions for the use of the child-restraint system:**

*An unsecured child-restraint system is dangerous. In a sudden stop or a collision it could move causing serious injury or death to the child or other occupants. Make sure the child-restraint system is properly secured in place according to the child-restraint system manufacturer's instructions.*

**Never attach two child-restraint systems to the same LATCH lower anchor:**

*Attaching two child-restraint systems to the same LATCH lower anchor is dangerous. In a collision, one anchor may not be strong enough to hold two child-restraint system attachments, and it may break, causing serious injury or death. If you use the seat position for another child-restraint system when an outboard LATCH position is occupied, use the center seat belts instead, and the tether if tether-equipped.*

**Make sure the child-restraint system is properly secured:**

*An unsecured child-restraint system is dangerous. In a sudden stop or a collision it could move causing serious injury or death to the child or other occupants. Follow the child-restraint system manufacturer's instructions on belt routing to secure the seat just as you would with a child in it so that nobody is tempted to put a child in an improperly secured seat later on. When not in use, remove it from the vehicle or fasten it with a seat belt, or latch it down to BOTH LATCH lower anchors for LATCH child-restraint systems.*

**Make sure there are no seat belts or foreign objects near or around the LATCH child-restraint system:**

*Not following the child-restraint system manufacturer's instructions when installing the child-restraint system is dangerous. If seat belts or a foreign object prevent the child-restraint system from being securely attached to the LATCH lower anchors and the child-restraint system is installed improperly, the child-restraint system could move in a sudden stop or collision causing serious injury or death to the child or other occupants. When installing the child-restraint system, make sure there are no seat belts or foreign objects near or around the LATCH lower anchors. Always follow the child-restraint system manufacturer's instructions.*

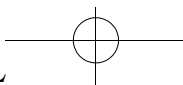

Essential Safety Equipment

## Child Restraint

### Installation on rear outboard seats

1. First, adjust the front seat to allow clearance between the child-restraint system and the front seat (page 2-4).
2. Make sure the seatback is securely latched by pushing it back until it is fully locked.
3. Expand the area between the seat bottom and the seatback slightly to verify the locations of the LATCH lower anchors (page 2-28).
4. Raise the head restraint to the top locked position.  
Refer to Head Restraints on page 2-11.
5. Secure the child-restraint system using BOTH LATCH lower anchors, following the child-restraint system manufacturer's instruction. Pull on the child-restraint to be sure both anchors are engaged.
6. If your child-restraint system came equipped with a tether, that means it is very important to properly secure the tether for child safety. Please carefully follow the child-restraint system manufacturer's instructions when installing tethers.

### **⚠ WARNING**

#### **Use the tether and tether anchor only for a child-restraint system:**

*Using the tether or tether anchor to secure anything but a child-restraint system is dangerous. This could weaken or damage the tether or tether anchor and result in injury.*

#### **Always route the tether strap between the head restraint and the seatback:**

*Routing the tether strap on top of the head restraint is dangerous. In a collision the tether strap could slide off the head restraint and loosen the child-restraint system. The child-restraint system could move which may result in death or injury to the child.*

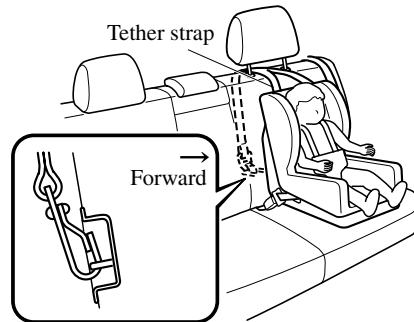

#### **Always attach the tether strap to the correct tether anchor position:**

*Attaching the tether strap to the incorrect tether anchor position is dangerous. In a collision, the tether strap could come off and loosen the child-restraint system. If the child-restraint system moves it could result in death or injury to the child.*



Essential Safety Equipment  
**Child Restraint**

**Installation on rear center seat**

The LATCH lower anchors at the center of the rear seat are much further apart than the sets of LATCH lower anchors for child-restraint system installation at other seating positions. Child-restraint systems with rigid LATCH attachments cannot be installed on the center seating position. Some LATCH equipped child-restraint systems can be placed in the center position and will reach the nearest LATCH lower anchors which are 420 mm (16.5 in) apart. LATCH compatible child-restraint systems (with attachments on belt webbing) can be used at this seating position only if the child-restraint system manufacturer's instructions state that the child-restraint system can be installed to LATCH lower anchors that are 420 mm (16.5 in) apart. Do not attach two child-restraint systems to the same LATCH lower anchor. If your child-restraint system has a tether, it must also be used for your child's optimum safety.

The procedure for installation on the rear outboards seats is the same. For the LATCH position, refer to Anchor Bracket Location (page 2-28).

**⚠ WARNING**

**Always route the tether strap between the head restraint and the seatback:**

*Routing the tether strap on top of the head restraint is dangerous. In a collision the tether strap could slide off the head restraint and loosen the child-restraint system. The child-restraint system could move which may result in death or injury to the child.*

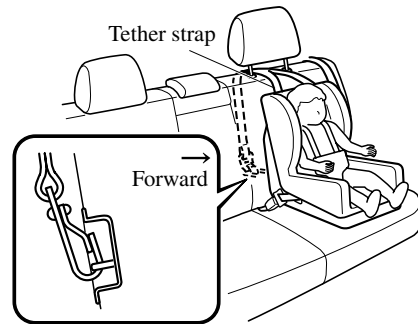

**Always attach the tether strap to the correct tether anchor position:**

*Attaching the tether strap to the incorrect tether anchor position is dangerous. In a collision, the tether strap could come off and loosen the child-restraint system. If the child-restraint system moves it could result in death or injury to the child.*

Essential Safety Equipment

## SRS Air Bags

### Supplemental Restraint System (SRS) Precautions

The front and side supplemental restraint systems (SRS) include up to 6 air bags. **Please verify which kinds of air bags are equipped on your vehicle by locating the “SRS AIRBAG” location indicators.** These indicators are visible in the area where the air bags are installed.

The air bags are installed in the following locations:

- The steering wheel hub (driver air bag)
- The front passenger dashboard (front passenger air bag)
- The outboard sides of the front seatbacks (side air bags)
- The front and rear window pillars, and the roof edge along both sides (curtain air bags)

Vehicles with the Driver and Front Passenger Occupant Classification System have a sensor which detects an impending roll-over accident.

The air bag supplemental restraint systems are designed to provide supplemental protection in certain situations so seat belts are always important in the following ways:

Without seat belt usage, the air bags cannot provide adequate protection during an accident. Seat belt usage is necessary to:

- Keep the occupant from being thrown into an inflating air bag.
- Reduce the possibility of injuries during an accident that is not designed for air bag inflation, such as rear impact.
- Reduce the possibility of injuries in frontal or side collisions or roll-over accidents that are not severe enough to activate the air bags.
- Reduce the possibility of being thrown from your vehicle.
- Reduce the possibility of injuries to lower body and legs during an accident because the air bags provide no protection to these parts of the body.
- Hold the driver in a position which allows better control of the vehicle.

Essential Safety Equipment  
**SRS Air Bags**

**If your vehicle is also equipped with a driver and front passenger occupant classification system, refer to the Driver and Front Passenger Occupant Classification System (page 2-53) for details.**

If your vehicle is equipped with a driver and front passenger occupant classification system, the front passenger air bag deactivation indicator light illuminates for a specified time after the ignition is switched ON.

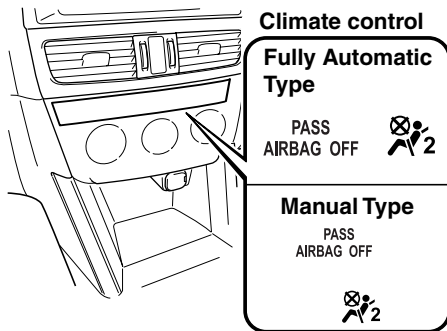

Small children must be protected by a child-restraint system as stipulated by law in every state and province. In certain states and provinces, larger children must use a child-restraint system (page 2-22).

Carefully consider which child-restraint system is necessary for your child and follow the installation directions in this Owner's Manual as well as the child-restraint system manufacturer's instructions.

**⚠ WARNING**

**Seat belts must be worn in air bag equipped vehicles:**

*Depending only on the air bags for protection during an accident is dangerous. Alone, air bags may not prevent serious injuries. The appropriate air bags can be expected to inflate only in the first accident, such as frontal, near frontal or side collisions or roll-over accident that are at least moderate. Vehicle occupants should always wear seat belts.*

**Children should not ride in the front passenger seat:**

*Placing a child, 12 years or under, in the front seat is dangerous. The child could be hit by a deploying air bag and be seriously injured or even killed. A sleeping child is more likely to lean against the door and be hit by the side air bag in moderate collision to the front-passenger side of the vehicle. Whenever possible, always secure a child 12 years and under on the rear seats with an appropriate child-restraint system for the child's age and size.*

Essential Safety Equipment  
**SRS Air Bags**

---

**Never use a rear-facing child-restraint system in the front seat with an air bag that could deploy:**

*Rear-facing child-restraint systems on the front seat are particularly dangerous even though you may feel assured that a front passenger air bag will not deploy based on the fact that the front passenger air bag deactivation indicator light illuminates. The child-restraint system can be hit by a deploying air bag and moved violently backward resulting in serious injury or death to the child.*

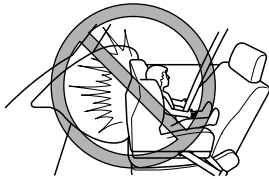

**Do not sit too close to the driver and front passenger air bags:**

*Sitting too close to the driver and front passenger air bag modules or placing hands or feet on them is extremely dangerous. The driver and front passenger air bags inflate with great force and speed. Serious injuries could occur if someone is too close. The driver should always hold onto only the rim of the steering wheel. The front seat passenger should keep both feet on the floor. Front seat occupants should adjust their seats as far back as possible and always sit upright against the seatbacks with seat belts worn properly.*

**Sit in the center of the seat and wear seat belts properly:**

*Sitting too close to the side air bag modules or placing hands on them, or sleeping up against the door or hanging out the windows is extremely dangerous. The side and curtain air bags inflate with great force and speed directly expanding along the door on the side the car is hit. Serious injury could occur if someone is sitting too close to the door or leaning against a window, or if rear seat occupants grab the sides of the front seatbacks. Give the side and curtain air bags room to work by sitting in the center of the seat while the vehicle is moving with seat belts worn properly.*

**Do not attach objects on or around the area where driver and front passenger air bags deploy:**

*Attaching an object to the driver and front passenger air bag modules or placing something in front of them is dangerous. In an accident, an object could interfere with air bag inflation and injure the occupants.*



Essential Safety Equipment  
**SRS Air Bags**

---

**Do not attach objects on or around the area where a side air bag deploys:**

Attaching objects to the front seat in such a way as to cover the outboard side of the seat in any way is dangerous. In an accident the object could interfere with the side air bag, which inflates from the outboard side of the front seats, impeding the added protection of the side air bag system or redirecting the air bag in a way that is dangerous. Furthermore, the bag could be cut open releasing the gas.

Do not hang net bags, map pouches or backpacks with side straps on the front seats. Never use seat covers on the front seats. Always keep the side air bag modules in your front seats free to deploy in the event of a side collision.

**Do not attach objects on or around the area where a curtain air bag deploys:**

Attaching objects to the areas where the curtain air bag activates such as on the windshield glass, side door glass, front and rear window pillars and along the roof edge and assist grips is dangerous. In an accident the object could interfere with the curtain air bag, which inflates from the front and rear window pillars and along the roof edge, impeding the added protection of the curtain air bag system or redirecting the air bag in a way that is dangerous. Furthermore, the bag could be cut open releasing the gas.

Do not place hangers or any other objects on the assist grips. When hanging clothes, hang them on the coat hook directly. Always keep the curtain air bag modules free to deploy in the event of a side collision or roll-over accident.

**Do not touch the components of the supplemental restraint system after the air bags have inflated:**

Touching the components of the supplemental restraint system after the air bags have inflated is dangerous. Immediately after inflation, they are very hot. You could get burned.

**Never install any front-end equipment to your vehicle:**

Installation of front-end equipment, such as frontal protection bar (kangaroo bar, bull bar, push bar, or other similar devices), snowplow, or winches, is dangerous. The air bag crash sensor system could be affected. This could cause air bags to inflate unexpectedly, or it could prevent the air bags from inflating during an accident. Front occupants could be seriously injured.

**Do not modify the suspension:**

Modifying the vehicle suspension is dangerous. If the vehicle's height or the suspension is modified, the vehicle will be unable to accurately detect a collision or roll-over accident resulting in incorrect or unexpected air bag deployment and the possibility of serious injuries.

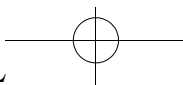

Essential Safety Equipment

## SRS Air Bags

---

**To prevent false detection by the air bag sensor system, heed the following:**

- **Do not use tires or wheels other than those specified for your Mazda:**  
*Use of any tire or wheel other than those specified for your Mazda (page 9-7) is dangerous. Use of such wheels will prevent the vehicle's accident detections system from accurately detecting a collision or roll-over accident resulting in incorrect or unexpected air bag deployment and the possibility of serious injuries.*
- **Do not overload your vehicle:**  
*Overloading your vehicle is dangerous as it could prevent the air bag crash sensor system from accurately detecting a collision or roll-over accident resulting in incorrect or unexpected air bag deployment and the possibility of serious injuries. The gross axle weight rating (GAWR) and the gross vehicle weight rating (GVWR) for your vehicle are on the Motor Vehicle Safety Standard Label on the driver's door frame. Do not exceed these ratings.*
- **Do not drive the vehicle off-road:**  
*Driving your Mazda off-road is dangerous because the vehicle has not been designed to do so. Driving the vehicle off-road could prevent the air bag crash sensor system from accurately detecting a collision or roll-over accident resulting in incorrect or unexpected air bag deployment and the possibility of serious injuries.*

**Do not modify a front door or leave any damage unrepaired. Always have an Authorized Mazda Dealer inspect a damaged front door:**

*Modifying a front door or leaving any damage unrepaired is dangerous. Each front door has a side crash sensor as a component of the supplemental restraint system. If holes are drilled in a front door, a door speaker is left removed, or a damaged door is left unrepaired, the sensor could be adversely affected causing it to not detect the pressure of an impact correctly during a side collision. If a sensor does not detect a side impact correctly, the side and curtain air bags and the front seat belt pretensioner may not operate normally which could result in serious injury to occupants.*

**Do not modify the supplemental restraint system:**

*Modifying the components or wiring of the supplemental restraint system is dangerous. You could accidentally activate it or make it inoperable. Do not make any modifications to the supplemental restraint system. This includes installing trim, badges, or anything else over the air bag modules. It also includes installing extra electrical equipment on or near system components or wiring. An Authorized Mazda Dealer can provide the special care needed in the removal and installation of front seats. It is important to protect the air bag wiring and connections to assure that the bags do not accidentally deploy and that the seats retain an undamaged air bag connection.*

Essential Safety Equipment  
**SRS Air Bags**

---

**Do not place luggage or other objects under the front seats:**

*Placing luggage or other objects under the front seats is dangerous. The components essential to the supplemental restraint system could be damaged, and in the event of a side collision, the appropriate air bags may not deploy, which could result in death or serious injury. To prevent damage to the components essential to the supplemental restraint system, do not place luggage or other objects under the front seats.*

**Do not operate a vehicle with damaged air bag/seat belt pretensioner system components:**

*Expended or damaged air bag/seat belt pretensioner system components must be replaced after any collision which caused them to deploy or damage them. Only a trained Authorized Mazda Dealer can fully evaluate these systems to see that they will work in any subsequent accident. Driving with an expended or damaged air bag or pretensioner unit will not afford you the necessary protection in the event of any subsequent accident which could result in serious injury or death.*

**Do not remove interior air bag parts:**

*Removing any components such as the front seats, front dashboard, the steering wheel or parts on the front and rear window pillars and along the roof edge, containing air bag parts or sensors is dangerous. These parts contain essential air bag components. The air bag could accidentally activate and cause serious injuries. Always have an Authorized Mazda Dealer remove these parts.*

**Dispose of the air bag properly:**

*Improper disposal of an air bag or a vehicle with live air bags in it can be extremely dangerous. Unless all safety procedures are followed, injury can result. Ask an Authorized Mazda Dealer how to safely dispose of an air bag or how to scrap an air bag equipped vehicle.*



Essential Safety Equipment  
**SRS Air Bags**

---

**NOTE**

- *If it becomes necessary to have the components or wiring system for the supplementary restraint system modified to accommodate a person with certain medical conditions in accordance with a certified physician, contact an Authorized Mazda Dealer; refer to “Customer Assistance (U.S.A.)” (page 8-2).*
- *When an air bag deploys, a loud inflation noise can be heard and some smoke will be released. Neither is likely to cause injury, however, the texture of the air bags may cause light skin injuries on body parts not covered with clothing through friction.*
- *Should you sell your Mazda, we urge you to tell the new owner of its air bag systems and that familiarization with all instructions about them, from the Owner's Manual, is important.*
- *On some models, a highly-visible label is displayed which warns against the use of rear-facing child-restraint systems on the front passenger seat.*

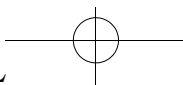
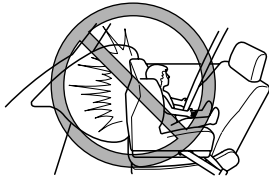



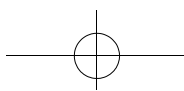

## Supplemental Restraint System Components

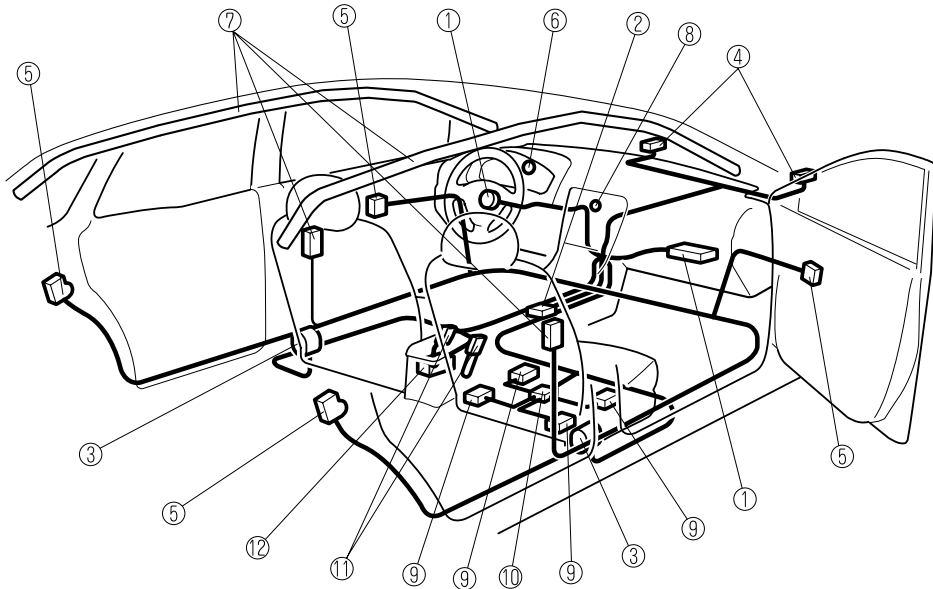

- ① Driver/Front passenger inflators and air bags
- ② Roll-over sensor \*, crash sensors, and diagnostic module (SAS unit)
- ③ Front seat belt pretensioners (page 2-17)
- ④ Front air bag sensors
- ⑤ Side crash sensors
- ⑥ Air bag/front seat belt pretensioner system warning light (page 4-15)
- ⑦ Side and curtain inflators and air bags
- ⑧ Front passenger air bag deactivation indicator light (page 2-53)
- ⑨ Front passenger seat weight sensors (page 2-53)
- ⑩ Front passenger seat weight sensor control module
- ⑪ Driver and front passenger seat belt buckle switches (page 2-58)
- ⑫ Driver seat slide position sensor (page 2-53)

**NOTE**

⑧ -⑫ are equipped only on models with the driver and front passenger occupant classification system.

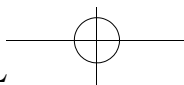

Essential Safety Equipment

## SRS Air Bags

### How the SRS Air Bags Work

Your Mazda is equipped with the following types of SRS air bags. SRS air bags are designed to work together with the seat belts to help to reduce injuries during an accident. The SRS air bags are designed to provide further protection for passengers in addition to the seat belt functions. Be sure to wear seat belts properly.

#### ▼ Front Seat Belt Pretensioners

The front seat belt pretensioners are designed to deploy in moderate or severe frontal, near frontal collisions. In addition, during a side collision, the pretensioner operates on the side in which the collision occurs.

#### **(With Driver and Front Passenger Occupant Classification System)**

The front seat belt pretensioners are also designed to deploy in a roll-over accident.

#### ▼ Driver Air Bag

The driver's air bag is mounted in the steering wheel.

When air bag crash sensors detect a frontal impact of greater than moderate force, the driver's air bag inflates quickly helping to reduce injury mainly to the driver's head or chest caused by directly hitting the steering wheel.

For more details about air bag deployment, refer to "SRS Air Bag Deployment Criteria" (page 2-50).

#### **(With Driver and Front Passenger Occupant Classification System)**

The driver's dual-stage air bag controls air bag inflation in two energy stages. During an impact of moderate severity the driver's air bag deploys with lesser energy, whereas during more severe impacts, it deploys with more energy.



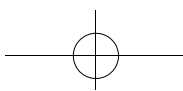

Essential Safety Equipment  
**SRS Air Bags**

---

▼ **Front Passenger Air Bag**

The front passenger air bag is mounted in the front passenger dashboard.  
The inflation mechanism for the front passenger air bag is the same as the driver's air bag, as mentioned above.  
For more details about air bag deployment, refer to “SRS Air Bag Deployment Criteria” (page 2-50).

**(With Driver and Front Passenger Occupant Classification System)**

In addition, the front passenger air bag is designed to only deploy in accordance with the total seated weight on the front passenger seat. For details, refer to the driver and front passenger occupant classification system (page 2-53).

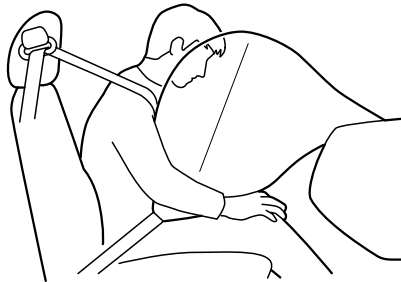

▼ **Side Air Bags**

The side air bags are mounted in the outboard sides of the front seatbacks.  
When the air bag crash sensors detect a side impact of greater than moderate force, the system inflates the side air bag only on the side in which the vehicle was hit. The side air bag inflates quickly to reduce injury to the driver or front passenger's chest caused by directly hitting interior parts such as a door or window.  
For more details about air bag deployment, refer to “SRS Air Bag Deployment Criteria” (page 2-50).

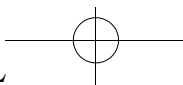

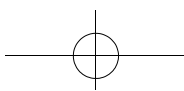

Essential Safety Equipment  
**SRS Air Bags**

---

**(With Driver and Front Passenger Occupant Classification System)**

In addition, the front passenger side air bag is designed to only deploy in accordance with the total seated weight on the front passenger seat. For details, refer to the driver and front passenger occupant classification system (page 2-53).

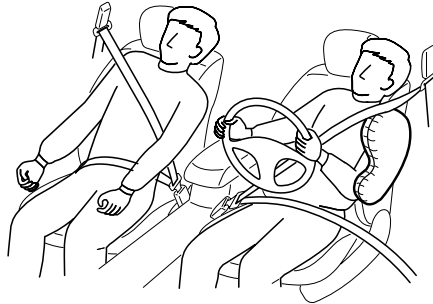

**▼ Curtain Air Bags**

The curtain air bags are mounted in the front and rear window pillars, and the roof edge along both sides.

When the air bag crash sensors detect a side impact of greater than moderate force, the curtain air bag inflates quickly and helps to reduce injury mainly to the rear outboard passenger's head caused by directly hitting interior parts such as a door or window. For more details about air bag deployment, refer to "SRS Air Bag Deployment Criteria" (page 2-50).

**In a side impact:**

Greater than moderate impact to one side of the vehicle will cause the curtain air bag on that side only to inflate.

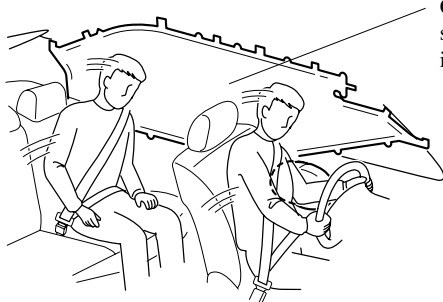

Only one side curtain air bag will deploy on the side of the vehicle that receives the force of an impact.

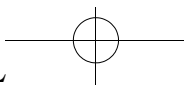

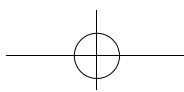

Essential Safety Equipment  
**SRS Air Bags**

**(With Driver and Front Passenger Occupant Classification System)**

**In a roll-over:**

In response to a vehicle roll-over, both curtain air bags inflate.

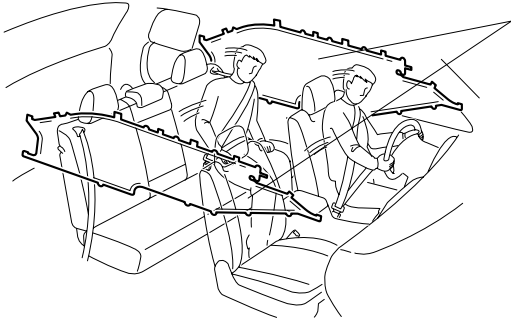

Both curtain air bags will deploy after the roll-over accident is detected.

**(With Driver and Front Passenger Occupant Classification System)**

**In an angled collision:**

During a collision, driver/front passenger air bag and the curtain air bag will deploy.



**▼ Warning Light/Beep**

A system malfunction or operation conditions are indicated by a warning.

Refer to Warning/Indicator Lights on page 4-15.

Refer to Air Bag/Front Seat Belt Pretensioner System Warning Beep on page 7-32.

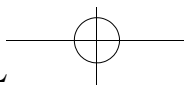





**Essential Safety Equipment**  
**SRS Air Bags**

**SRS Air Bag Deployment Criteria**

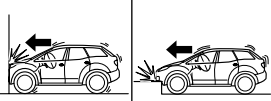
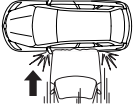
This chart indicates the applicable SRS equipment that will deploy depending on the type of collision.

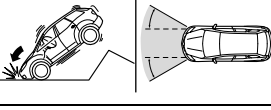
(The illustrations are the representative cases of collisions.)

SRS equipment	Types of collision			
	A severe frontal/near frontal collision	A severe side collision	A roll-over/near roll-over <sup>*3</sup>	A rear collision
				
				
				
Front seat belt pretensioner	X <sup>*1</sup> (both sides)	X <sup>*1</sup> (impact side only)	X <sup>*1</sup> (both sides)	No air bag and front seat belt pretensioner will be activated in a rear collision.
Driver air bag	X			
Front passenger air bag	X <sup>*1</sup>			
Side air bag		X <sup>*1</sup> (impact side only)		
Curtain air bag	X <sup>*2</sup>	X (impact side only)	X (both sides)	

X: The SRS air bag equipment is designed to deploy in a collision.

**\*1 (With Driver and Front Passenger Occupant Classification System)**

The front passenger front and side air bags and the seat belt pretensioner are designed to deploy depending on the condition of the total seated weight on the front passenger seat.

**\*2 (With Driver and Front Passenger Occupant Classification System)**

In an angled collision, the curtain air bag might deploy.

**\*3 (With Driver and Front Passenger Occupant Classification System)**

In a roll-over accident, the seat belt pretensioners and the curtain air bags deploy.

## Limitations to SRS Air Bag

In severe collisions such as those described previously in “SRS Air Bag Deployment Criteria”, the applicable SRS air bag equipment will deploy. However, in some accidents, the equipment may not deploy depending on the type of collision and its severity.

### Limitations to front/near front collision detection:

The following illustrations are examples of front/near front collisions that may not be detected as severe enough to deploy the SRS air bag equipment.

Impacts involving trees or poles

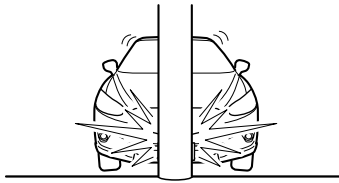

Frontal offset impact to the vehicle

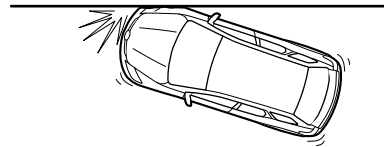

Rear-ending or running under a truck's tail gate

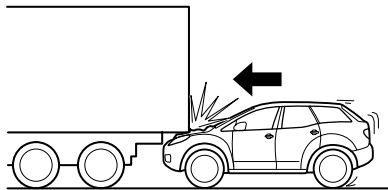

### Limitations to side collision detection:

The following illustrations are examples of side collisions that may not be detected as severe enough to deploy the SRS air bag equipment.

Side impacts involving trees or poles

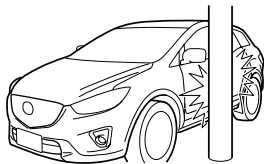

Side impacts with two-wheeled vehicles

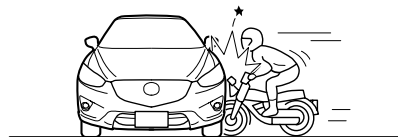



Essential Safety Equipment  
**SRS Air Bags**

---

Roll-over (Without Driver and Front Passenger Occupant Classification System)



**(With Driver and Front Passenger Occupant Classification System)**

**Limitations to roll-over detection:**

The following illustration is an example of an accident that may not be detected as a roll-over accident. Therefore, the front seat belt pretensioners and curtain air bags may not deploy.

Pitch end over end

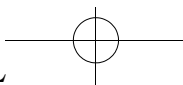
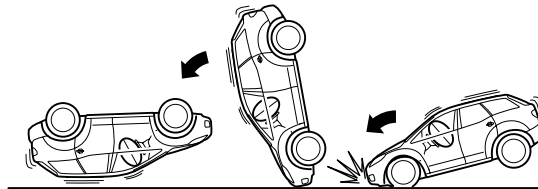





## **Driver and Front Passenger Occupant Classification System\***

First, please read “Supplemental Restraint System (SRS) Precautions” (page 2-38) carefully.

### **▼ Driver Seat Slide Position Sensor**

Your vehicle is equipped with a driver seat slide position sensor as a part of the supplemental restraint system. The sensor is located under the driver seat. The sensor determines whether the driver seat is fore or aft of a reference position and sends the seat position to the diagnostic module (SAS unit). The SAS unit is designed to control the deployment of the driver air bag depending on how close the driver seat is to the steering wheel.

A system malfunction or operation conditions are indicated by a warning. Refer to Warning/Indicator Lights on page 4-15.

### **▼ Front Passenger Seat Weight Sensor**

Your vehicle is equipped with a front passenger seat weight sensors as a part of the supplemental restraint system. These sensors are located under both of the front passenger seat rails. These sensors determine the total seated weight on the front passenger seat and monitor the seat belt buckle for the front passenger seat. The SAS unit is designed to prevent the front passenger front and side air bags and seat belt pretensioner system from deploying if the front passenger air bag deactivation indicator light illuminates. To reduce the chance of injuries caused by deployment of the front passenger air bag, the system deactivates the front passenger front and side air bags and also the seat belt pretensioner system when the front passenger air bag deactivation indicator light illuminates. Refer to the following table for the front passenger air bag deactivation indicator light illumination conditions.

This system shuts off the front passenger front and side air bags and seat belt pretensioner system, so make sure the front passenger air bag deactivation indicator light illuminates according to the following table.

The air bag/front seat belt pretensioner system warning light flashes and the front passenger air bag deactivation indicator light illuminates if the sensors have a possible malfunction. If this happens, the front passenger front and side air bags and seat belt pretensioner system will not deploy.

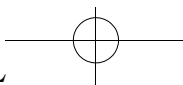

**Essential Safety Equipment**  
**SRS Air Bags**

**Front passenger air bag deactivation indicator light**

This indicator light illuminates to remind you that the front passenger front and side air bags and seat belt pretensioner will not deploy during a collision.

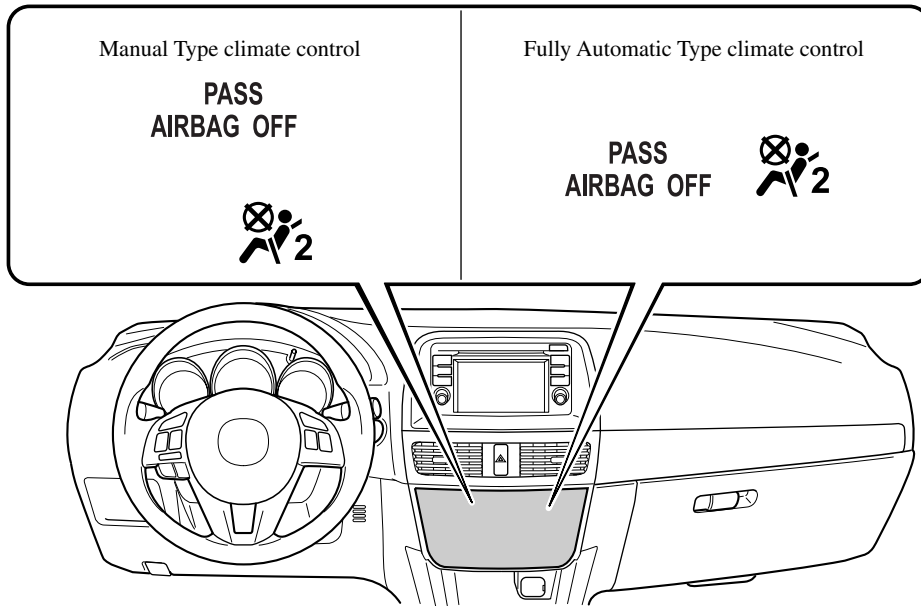

If the front passenger weight sensors are normal, the indicator light illuminates when the ignition is switched ON. The light turns off after a few seconds.

The front/passenger air bag deactivation indicator light illuminates or is off under the following conditions:

Condition detected by the front passenger occupant classification system	Front passenger air bag deactivation indicator light	Front passenger front and side air bags	Front passenger seat belt pretensioner system
Empty (Not occupied)	On	Deactivated	Deactivated
Child or child-restraint system*1	On	Deactivated	Deactivated
Adult*2	Off	Ready	Ready

\*1 : If a larger child sits on the front passenger seat, the sensors might detect the child as being an adult depending on the child's physique.

\*2 : If a smaller adult sits on the front passenger seat, the sensors might detect the person as being a child depending on the person's physique.

The curtain air bag is ready for inflating regardless of the chart above.

If the front passenger air bag deactivation indicator light does not illuminate when the ignition is switched ON and does not illuminate as indicated in the above chart, do not allow a child to sit in the front passenger seat and consult an Authorized Mazda Dealer as soon as possible. The system may not work properly in an accident.



Essential Safety Equipment  
**SRS Air Bags**

---

**⚠ WARNING**

***Do not decrease the total seated weight on the front passenger seat:***

*When an adult or large child sits on the front passenger seat, decreasing the total seated weight on the front passenger seat required for air bag deployment is dangerous. The front passenger seat weight sensors will detect the reduced total seated weight condition and the front passenger front and side air bags and seat belt pretensioner system will not deploy during an accident. The front passenger will not have the supplementary protection of the air bag, which could result in serious injury. Decreasing the total seated weight on the front passenger seat could result in an air bag not deploying under the following conditions, for example:*

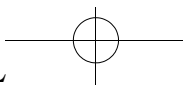

## Essential Safety Equipment SRS Air Bags

---

- *A front passenger is seated as shown in the following figure:*

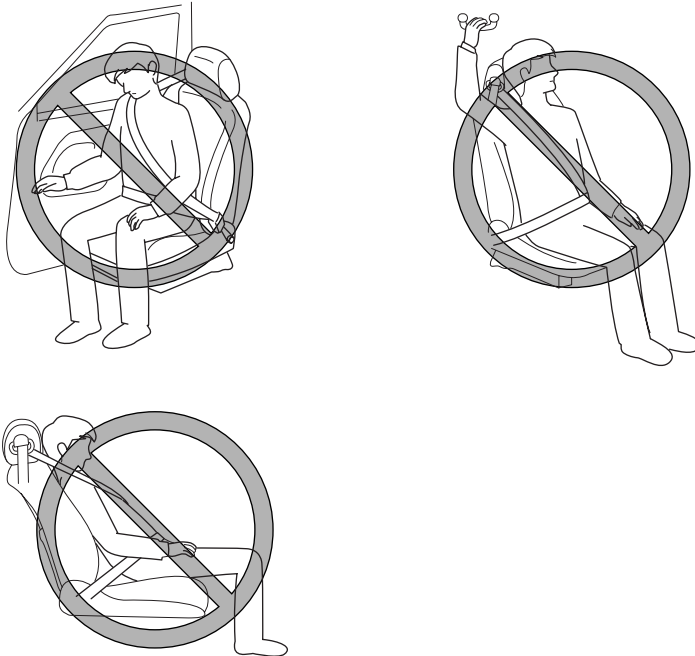

- *A rear passenger pushes up on the front passenger seat with their feet.*  
➤ *Luggage or other items placed under the front passenger seat or between the front passenger seat and driver seat that push up the front passenger seat bottom.*  
➤ *Any accessories which might decrease the total seated weight on the front passenger seat are attached to the front passenger seat.*  
*The front passenger front and side air bags and seat belt pretensioner systems will deactivate if the front passenger air bag deactivation indicator light illuminates.*

Essential Safety Equipment  
**SRS Air Bags**

**Do not increase the total seated weight on the front passenger seat:**

*When an infant or small child sits on the front passenger seat, increasing the total seated weight on the front passenger seat is dangerous. The front passenger seat weight sensors will detect the increased total seated weight, which could result in the unexpected deployment of the front passenger front and side air bags and seat belt pretensioner system in an accident and may cause serious injury. Increasing the total seated weight on the front passenger seat could result in the front passenger front and side air bags and seat belt pretensioner system deployment in an accident under the following conditions, for example:*

- *Luggage or other items are placed on the seat with the child in the child-restraint system.*
- *A rear passenger or luggage push or pull down on the front passenger seatback.*
- *A rear passenger steps on the front passenger seat rails with their feet.*
- *Luggage or other items are placed on the seatback or hung on the head restraint.*
- *Heavy items are placed in the seatback map pocket.*
- *The seat is washed.*
- *Liquids are spilled on the seat.*
- *The front passenger seat is moved backward, pushing into luggage or other items placed behind it.*
- *The front passenger seatback contacts the rear seat.*
- *Luggage or other items are placed between the front passenger seat and driver seat.*
- *Any accessories which might increase the total seated weight on the front passenger seat are attached to the front passenger seat.*

**⚠ CAUTION**

- *To assure proper deployment of the front air bag and to prevent damage to the sensors in the front seat bottoms:*
  - *Do not place sharp objects on the front seat bottoms or leave heavy luggage on them.*
  - *Do not spill any liquids on the front seats or under the front seats.*
- *To allow the sensors to function properly, always perform the following:*
  - *Adjust the front seats as far back as possible and always sit upright against the seatbacks with seat belts worn properly.*
  - *If you place your child on the front passenger seat, secure the child-restraint system properly and slide the front passenger seat as far back as possible(page 2-29).*

## Essential Safety Equipment

# SRS Air Bags

---

### **NOTE**

- *The system requires about 10 seconds to alternate between turning the front passenger front and side air bags and seat belt pretensioner system on or off.*
- *The front passenger air bag deactivation indicator light may illuminate repeatedly if luggage or other items are put on the front passenger seat, or if the temperature of the vehicle's interior changes suddenly.*
- *The front passenger air bag deactivation indicator light may illuminate for 10 seconds if the total seated weight on the front passenger seat changes.*
- *The air bag/front seat belt pretensioner system warning light might illuminate if the front passenger seat receives a severe impact.*
- *If the front passenger air bag deactivation indicator light does not illuminate after installing a child-restraint system on the front passenger seat, first, re-install your child-restraint system according to the procedure in this owner's manual. Then, if the front passenger air bag deactivation indicator light still does not illuminate, install the child-restraint system on the rear seat and consult an Authorized Mazda Dealer as soon as possible.*
- *If the front passenger air bag deactivation indicator light illuminates when an adult is seated in the front passenger seat, have the passenger re-adjust their posture by sitting with their feet on the floor, and then re-fastening the seat belt. If the front passenger air bag deactivation indicator light still illuminates, move the passenger to the rear seat. If sitting in the rear seat is not possible, slide the front passenger seat as far back as possible. Consult an Authorized Mazda Dealer as soon as possible.*

### **▼ Driver and Front Passenger Buckle Switches**

The buckle switches on the front seat belts detect whether or not the front seat belts are securely fastened and further control the deployment of the air bags.

## Constant Monitoring

The following components of the air bag systems are monitored by a diagnostic system:

- Crash sensors, and diagnostic module (SAS unit)
- Front air bag sensors
- Air bag modules
- Side crash sensors
- Air bag/Front seat belt pretensioner system warning light
- Front seat belt pretensioners
- Related wiring

### **(With Driver and Front Passenger Occupant Classification System)**

- Front passenger air bag deactivation indicator light
- Driver seat slide position sensor
- Front passenger seat weight sensors
- Front passenger seat weight sensor control module
- Front passenger seat belt buckle switches

The diagnostic module continuously monitors the system's readiness. This begins when the ignition is switched ON and continues while the vehicle is being driven.

Essential Safety Equipment

## Secondary Collision Reduction (SCR)

---

### Secondary Collision Reduction (SCR)

If your vehicle is involved in a collision, the Secondary Collision Reduction (SCR) operates the hazard warning (SCR hazard) to reduce the possibility of a secondary accident after an initial collision. The Secondary Collision Reduction (SCR) operates when it detects a certain amount of impact.

#### CAUTION

*The Secondary Collision Reduction (SCR) may not operate under the following conditions:*

- *A certain amount of impact is not detected.*
- *An important part for the system operation is damaged.*
- *The Air Bag/Front Seat Belt Pretensioner System warning light in the instrument cluster illuminates.*  
*Refer to Warning/Indicator Lights on page 4-15.*

#### ▼ Hazard Warning (SCR hazard)

The hazard warning (SCR hazard) flashes the turn signal indicators during a collision to caution the vehicles surrounding your vehicle when it detects a certain amount of impact. While the hazard warning (SCR hazard) is operating, all the turn signal indicators are flashed automatically.

After the system has been activated it can be turned off by pressing the hazard warning light switch two times or switching the ignition off.

#### **NOTE**

*The hazard warning (SCR hazard) does not operate if the ignition is switched off.*



# 3 Before Driving

Use of various features, including keys, doors, mirrors and windows.

<b>Keys .....</b>	<b>3-2</b>	<b>Driving Tips .....</b>	<b>3-37</b>
Keys .....	3-2	Break-In Period .....	3-37
Keyless Entry System .....	3-3	Money-Saving Suggestions .....	3-37
<b>Advanced Keyless Entry System .....</b>	<b>3-8</b>	Hazardous Driving .....	3-38
Advanced Keyless Entry System .....	3-8	Floor Mat .....	3-38
Operational Range .....	3-9	Rocking the Vehicle .....	3-39
<b>Doors and Locks .....</b>	<b>3-10</b>	Winter Driving .....	3-39
Door Locks .....	3-10	Driving In Flooded Area .....	3-41
Liftgate .....	3-16	Overloading .....	3-41
<b>Fuel and Emission .....</b>	<b>3-19</b>	Driving on Uneven Road .....	3-42
Fuel and Engine Exhaust		<b>Towing .....</b>	<b>3-43</b>
Precautions .....	3-19	Trailer Towing (U.S.A. and	
Fuel-Filler Lid and Cap .....	3-22	Canada) .....	3-43
<b>Steering Wheel .....</b>	<b>3-24</b>		
Steering Wheel .....	3-24		
<b>Mirrors .....</b>	<b>3-25</b>		
Mirrors .....	3-25		
<b>Windows .....</b>	<b>3-28</b>		
Power Windows .....	3-28		
Moonroof* .....	3-31		
<b>Security System .....</b>	<b>3-33</b>		
Modification and Add-On			
Equipment .....	3-33		
Immobilizer System .....	3-33		
Theft-Deterrent System* .....	3-35		

\*Some models. **3-1**

Before Driving

## Keys

### Keys

#### **⚠ WARNING**

**Do not leave the key in your vehicle with children and keep them in a place where your children will not find or play with them:**

*Leaving children in a vehicle with the key is dangerous. This could result in someone being badly injured or even killed. Children may find these keys to be an interesting toy to play with and could cause the power windows or other controls to operate, or even make the vehicle move.*

#### **⚠ CAUTION**

- *Because the key (transmitter) uses low-intensity radio waves, it may not function correctly under the following conditions:*
  - *The key is carried with communication devices such as cellular phones.*
  - *The key contacts or is covered by a metal object.*
  - *The key is near electronic devices such as personal computers.*
  - *Non-Mazda genuine electronic equipment is installed in the vehicle.*
  - *There is equipment which discharges radio waves near the vehicle.*
- *The key (transmitter) may consume battery power excessively if it receives high-intensity radio waves. Do not place the key near electronic devices such as televisions or personal computers.*
- *To avoid damage to the key (transmitter), DO NOT:*
  - *Drop the key.*
  - *Get the key wet.*
  - *Disassemble the key.*
  - *Expose the key to high temperatures on places such as the dashboard or hood, under direct sunlight.*
  - *Expose the key to any kind of magnetic field.*
  - *Place heavy objects on the key.*
  - *Put the key in an ultrasonic cleaner.*
  - *Put any magnetized objects close to the key.*

A code number is stamped on the plate attached to the key set; detach this plate and store it in a safe place (not in the vehicle) for use if you need to make a replacement key (auxiliary key). Also write down the code number and keep it in a separate safe and convenient place, but not in the vehicle.

If your key (auxiliary key) is lost, consult your Authorized Mazda Dealer and have your code number ready.

**NOTE**

*The driver must carry the key to ensure the system functions properly.*

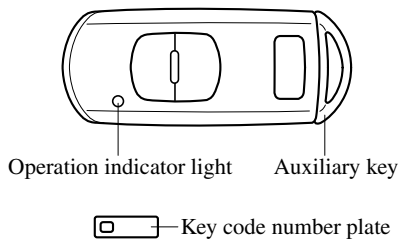

Pull out the auxiliary key from the key.

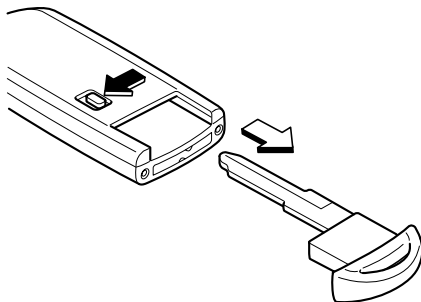

## Keyless Entry System

This system uses the key buttons to remotely lock and unlock the doors and the liftgate.

The system can start the engine without having to take the key out of your purse or pocket.

It can also help you signal for attention. Operating the theft-deterrent system is also possible on theft-deterrent system-equipped vehicles.

Press the buttons slowly and carefully.

System malfunctions or operations are indicated by the following warnings.

- KEY Warning Light (Red)/KEY Indicator (Green)  
Refer to Warning/Indicator Lights on page 4-15.
- Ignition Not Switched Off (STOP) Warning Beep  
Refer to Ignition Not Switched Off (STOP) Warning Beep on page 7-33.
- Key Removed from Vehicle Warning Beep  
Refer to Key Removed from Vehicle Warning Beep on page 7-33.

If you have a problem with the key (transmitter), consult an Authorized Mazda Dealer.

If your key (transmitter) is lost or stolen, consult an Authorized Mazda Dealer as soon as possible for a replacement and to make the lost or stolen key (transmitter) inoperative.

Before Driving

## Keys

### CAUTION

*Radio equipment like this is governed by laws.*

*Changes or modifications not expressly approved by the party responsible for compliance could void the user's authority to operate the equipment.*

### NOTE

- *The keyless entry system operation may vary due to local conditions.*
- *The keyless entry system is fully operational (door/liftgate lock/unlock) when the push button start is switched off. The system does not operate if the push button start is switched to any position other than off.*
- *If the key (transmitter) does not operate when pressing a button or the operational range becomes too small, the battery may be dead. To install a new battery, refer to Replace Electrical Battery (page 6-32).*
- *Additional key (transmitter) can be obtained at an Authorized Mazda Dealer. Up to 6 keys can be used with the keyless functions per vehicle. Bring all key (transmitter) to an Authorized Mazda Dealer when additional key (transmitter) are required.*

### ▼ Transmitter

#### NOTE

- *If your vehicle has a theft-deterrent system, the hazard warning lights flash when the system is armed or turned off. Refer to Theft-Deterrent System on page 3-35.*
- **(With the advanced keyless function)**  
*A beep sound can be heard for confirmation when the doors and liftgate are locked/unlocked using the key (transmitter). If you prefer, the beep sound can be turned off. The volume of the beep sound can also be changed. Refer to Personalization Features on page 9-8.*

The operation indicator light flashes when the buttons are pressed.

#### Lock button

To lock the doors and the liftgate, press the lock button and the hazard warning lights will flash once.

#### **(With the advanced keyless function)**

A beep sound will be heard once.

To confirm that all doors and the liftgate have been locked, press the lock button again within 5 seconds. If they are closed and locked, the horn will sound.



## NOTE

- *Doors and the liftgate cannot be locked by pressing the lock button while any other door or the liftgate is open. The hazard warning lights will also not flash.*
- *Doors and the liftgate can be locked by pressing the lock button while any other door or the liftgate is open. The hazard warning lights will not flash.*  
*When the lock button is pressed while any door is open and then the door is closed, all doors and the liftgate are locked.*
- *Confirm that all doors and the liftgate are locked visually or audibly by use of the double click.*
- *When any door is opened from the outside while the key is inside the vehicle, the closed doors are locked and all the doors are automatically unlocked by closing the open door. The beep sound is heard for about 10 seconds to notify the driver that the key has been left in the vehicle.*
- *Make sure all doors and the liftgate are locked after pressing the button.*
- **(With theft-deterrent system)**  
*When the doors are locked by pressing the lock button on the key while the theft-deterrent system is armed, the hazard warning lights will flash once to indicate that the system is armed.*

## **Unlock button**

To unlock the driver's door, press the unlock button and the hazard warning lights will flash twice.

### **(With the advanced keyless function)**

A beep sound will be heard twice.

To unlock all doors and the liftgate, press the unlock button again within 3 seconds and two more beep sounds will be heard.



## NOTE

- *The system can be set to unlock all doors by performing a single operation.*  
*Refer to Personalization Features on page 9-8.*
- **(Auto re-lock function)**  
*After unlocking with the transmitter, all doors and the liftgate will automatically lock if any of the following operations are not performed within about 60 seconds. If your vehicle has a theft-deterrent system, the hazard warning lights will flash for confirmation.*  
*The time required for the doors to lock automatically can be changed.*  
*Refer to Personalization Features on page 9-8.*
  - *A door or the liftgate is opened.*
  - *The push button start is switched to any position other than off.*
- **(With theft-deterrent system)**  
*When the doors are unlocked by pressing the unlock button on the transmitter while the theft-deterrent system is turned off, the hazard warning lights will flash twice to indicate that the system is turned off.*

Before Driving

## Keys

### Panic button

If you witness from a distance someone attempting to break into or damage your vehicle, pressing the panic button will activate the vehicle's alarm.

# ! HOLD

### **NOTE**

The panic button will work whether any door or the liftgate is open or closed.

### **(Turning on the alarm)**

Pressing the panic button for 1 second or more will trigger the alarm for about 2 minutes and 30 seconds, and the following will occur:

- The horn sounds intermittently.
- The hazard warning lights flash.

### **(Turning off the alarm)**

The alarm stops by pressing any button on the transmitter.

### ▼ **Operational Range**

The system operates only when the driver is in the vehicle or within operational range while the key is being carried.

### Starting the Engine

### **NOTE**

- Starting the engine may be possible even if the key is outside of the vehicle and extremely close to a door and window, however, always start the engine from the driver's seat.  
If the vehicle is started and the key is not in the vehicle, the vehicle will not restart after it is shut off and the push button start is switched to off.
- The luggage compartment is out of the assured operational range, however, if the key (transmitter) is operable the engine will start.

### **With the advanced keyless function**

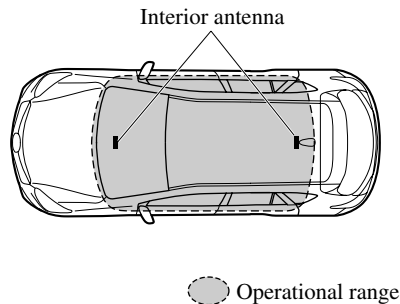

## Without the advanced keyless function

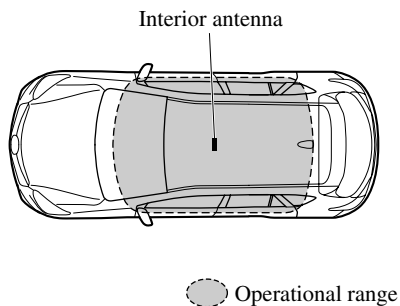

### NOTE

The engine may not start if the key is placed in the following areas:

- Around the dashboard
- In the storage compartments such as the glove box
- On the rear parcel shelf
- In the luggage compartment

### ▼ Key Suspend Function

If a key is left in the vehicle, the functions of the key left in the vehicle are temporarily suspended to prevent theft of the vehicle.

The following are inoperable:

- Starting the engine using the push button start.
- **(With the advanced keyless function)** Operating the request switches.

To restore these functions, perform any one of the following:

- Press a button on the key which has had its functions temporarily suspended.

- For vehicles with a type A meter, messages are displayed in the instrument cluster.

#### **(Manual transaxle)**

When carrying another key, depress the clutch pedal until the KEY indicator light (green) illuminates.

#### **(Automatic transaxle)**

When carrying another key, depress the brake pedal until the KEY indicator light (green) illuminates.

Refer to Warning/Indicator Lights on page 4-15.

Before Driving

## Advanced Keyless Entry System

### Advanced Keyless Entry System

#### WARNING

**Radio waves from the key may affect medical devices such as pacemakers:**

*Before using the key near people who use medical devices, ask the medical device manufacturer or your physician if radio waves from the key will affect the device.*

The advanced keyless function allows you to lock/unlock the doors/liftgate, or open the liftgate while carrying the key without using the key.

System malfunctions or operations are indicated by the following warnings.

- Request switch Inoperable Warning Beep  
Refer to Request Switch Inoperable Warning Beep (With the advanced keyless function) on page 7-33.
- Key Left-in-luggage Compartment Warning Beep  
Refer to Key Left-in-luggage Compartment Warning Beep (With the advanced keyless function) on page 7-33.
- Key Left-in-vehicle Warning Beep  
Refer to Key Left-in-vehicle Warning Beep (With the advanced keyless function) on page 7-34.

#### **NOTE**

*The advanced keyless entry system functions can be deactivated to prevent any possible adverse effect on a user wearing a pacemaker or other medical device. If the system is deactivated, you will be unable to start the engine by carrying the key. Consult an Authorized Mazda Dealer for details. If the advanced keyless entry system has been deactivated, you can start the engine by following the procedure indicated when the key battery goes dead.*

*Refer to Engine Start Function When Key Battery is Dead on page 4-6.*



Before Driving  
**Advanced Keyless Entry System**

### Operational Range

The system operates only when the driver is in the vehicle or within operational range while the key is being carried.

**NOTE**

*When the battery power is low, or in places where there are high-intensity radio waves or noise, the operational range may become narrower or the system may not operate.*

#### ▼ Locking, Unlocking the Doors and the Liftgate

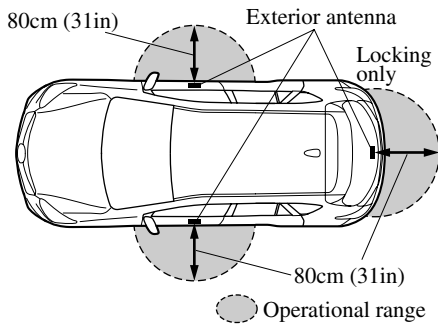

**NOTE**

*The system may not operate if you are too close to the windows, door handles, or liftgate.*

#### ▼ Opening the Liftgate

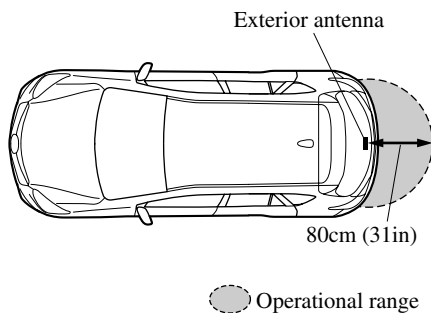

Before Driving

## Doors and Locks

### Door Locks

#### WARNING

**Always take all children and pets with you or leave a responsible person with them:**

*Leaving a child or a pet unattended in a parked vehicle is dangerous. In hot weather, temperatures inside a vehicle can become high enough to cause brain damage or even death.*

**Do not leave the key in your vehicle with children and keep them in a place where your children will not find or play with them:**

*Leaving children in a vehicle with the key is dangerous. This could result in someone being badly injured or even killed.*

**Keep all doors locked when driving:**

*Unlocked doors in a moving vehicle are dangerous. Passengers can fall out if a door is accidentally opened and can more easily be thrown out in an accident.*

**Always close all the windows and moonroof, lock the doors and take the key with you when leaving your vehicle unattended:**

*Leaving your vehicle unlocked is dangerous as children could lock themselves in a hot vehicle, which could result in death. Also, a vehicle left unlocked becomes an easy target for thieves and intruders.*

**After closing the doors, always verify that they are securely closed:**

*Doors not securely closed are dangerous, if the vehicle is driven with a door not securely closed, the door could open unexpectedly resulting in an accident.*

**Always confirm the safety around the vehicle before opening a door:**

*Suddenly opening a door is dangerous. A passing vehicle or a pedestrian could be hit and cause an accident.*

#### NOTE

- *The vehicle lock-out prevention feature prevents you from locking yourself out of the vehicle. All doors and the liftgate will automatically unlock if they are locked using the power door locks with any door or the liftgate open.*
- **(Door unlock (control) system with collision detection)**  
*This system automatically unlocks the doors in the event the vehicle is involved in an accident to allow passengers to get out of the vehicle immediately and prevent being trapped inside. While the ignition is switched ON and in the event the vehicle receives an impact strong enough to inflate the air bags, all the doors are automatically unlocked after about 6 seconds have elapsed from the time of the accident. The doors may not unlock depending on how an impact is applied, the force of the impact, and other conditions of the accident.  
If door-related systems or the battery is malfunctioning, the doors will not unlock.*

Before Driving  
**Doors and Locks**

▼ **Locking, Unlocking with Key**

All doors and the liftgate lock automatically when the driver's door is locked with the key.

All doors and the liftgate unlock when the driver's door is unlocked and the key is held in the unlock position for one second or longer.

Turn the key toward the front to lock, toward the back to unlock.

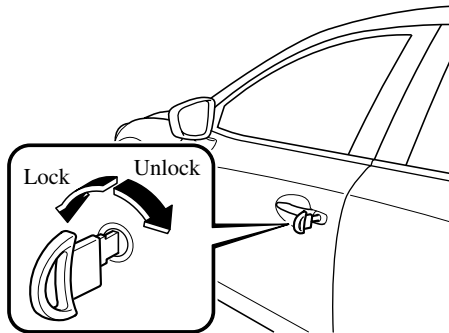

**NOTE**

*Holding the key in the unlocked position in the driver's door lock for about a second unlocks all doors and the liftgate. To unlock only the driver's door, insert the key into the driver's door lock and turn the key briefly to the unlock position and then immediately return it to the center position.*

▼ **Locking, Unlocking with Request Switch (With the advanced keyless function)**

All doors and the liftgate can be locked/unlocked by pressing the request switch on the front doors while the key is being carried.

The request switch on the liftgate can only be used to lock all doors and the liftgate.

**Front doors**

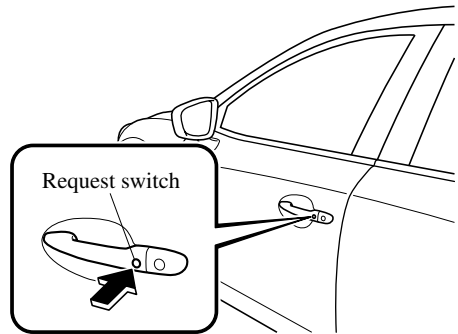

**Liftgate (Lock only)**

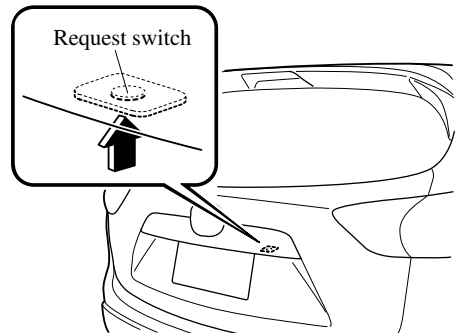

**To lock**

To lock the doors and the liftgate, press the request switch. A beep sound will be heard once and the hazard warning lights will flash once.

**To unlock**

**Driver's door request switch**

To unlock the driver's door, press the request switch. A beep sound will be heard twice and the hazard warning lights will flash twice.

To unlock all doors and the liftgate, press the request switch again within 3 seconds and two more beep sounds will be heard.

Before Driving

## Doors and Locks

### Front passenger door request switch

To unlock all doors and the liftgate, press the request switch. A beep sound will be heard twice and the hazard warning lights will flash twice.

#### NOTE

- The system can be set to unlock all doors by performing a single operation.  
Refer to Personalization Features on page 9-8.
- Confirm that all doors and the liftgate are securely locked.
- All doors and the liftgate cannot be locked when any door or the liftgate is open.
- It may require a few seconds for the doors to unlock after the request switch is pressed.
- A beep sound is heard for confirmation when the doors and the liftgate are locked/unlocked using the request switch. If you prefer, the beep sound can be turned off. The volume of the beep sound can also be changed.  
Refer to Personalization Features on page 9-8.
- **(With theft-deterrent system)**  
The hazard warning lights flash when the theft-deterrent system is armed or turned off.  
Refer to Theft-Deterrent System on page 3-35.

- The setting can be changed so that the doors and the liftgate are locked automatically without pressing the request switch.

Refer to Personalization Features on page 9-8.

#### **(Auto-lock function)**

Three seconds after the doors and the liftgate are closed and the key is out of the operational range, the doors and the liftgate will lock automatically. Also, the hazard warning lights flash once. (Even if the driver is in the operational range, all doors and the liftgate are locked automatically after about 30 seconds.) If you are out of the operational range before the doors and the liftgate are completely closed or another key is left in the vehicle, the auto-lock function will not work. Always make sure that all doors and the liftgate are closed and locked before leaving the vehicle. The auto-lock function does not close the power windows.

- **(Auto re-lock function)**  
After unlocking with the request switch, all doors and the liftgate will automatically lock if any of the following operations are not performed within about 60 seconds. If your vehicle has a theft-deterrent system, the hazard warning lights will flash for confirmation.  
The time required for the doors to lock automatically can be changed.  
Refer to Personalization Features on page 9-8.
  - A door or the liftgate is opened.
  - The ignition is switched to any position other than off.

Before Driving  
**Doors and Locks**

▼ **Locking, Unlocking with Transmitter**

All doors and the liftgate can be locked/unlocked by operating the keyless entry system transmitter, refer to Keyless Entry System (page 3-3).

▼ **Locking, Unlocking with Door-Lock Switch**

All doors and the liftgate lock automatically when lock side is pressed. They all unlock when unlock side is pressed.

To lock all the doors/liftgate from an open front door, press the lock side of the door lock switch and then close the door.

**Driver's door**

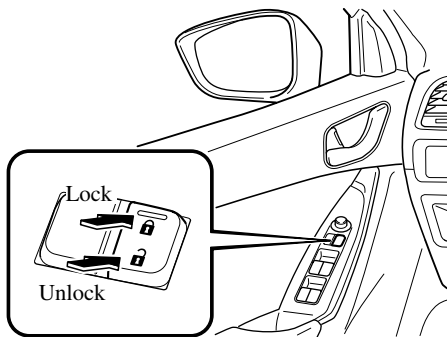

**Front passenger's door**

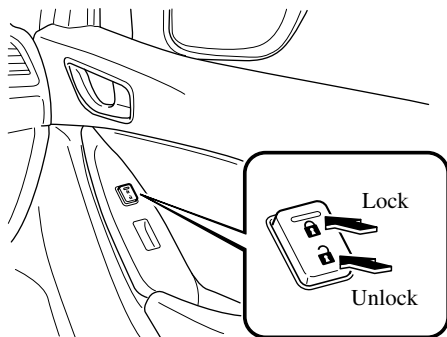

▼ **Auto Lock/Unlock Function**

**⚠ WARNING**

**Do not pull the inner handle on a front door:**

*Pulling an inner handle on a front door while the vehicle is moving is dangerous. Passengers can fall out of the vehicle if a front door accidentally opens, which could result in death or serious injury.*

- When the vehicle speed exceeds 20 km/h (12 mph), all doors and the liftgate lock automatically.
- When the ignition is switched off, all doors and the liftgate unlock automatically.

These functions can also be disabled so that they do not operate.

**Auto lock/unlock function setting change using door-lock switch**

The doors and the liftgate can set to lock or unlock automatically by selecting any one of the functions from the following table and using the driver's door-lock switch on the interior door panel to perform the setting change as indicated in the procedure which follows.

Settings can be changed using the following operation.

Before Driving

## Doors and Locks

**NOTE**

- *Function number 3 is the factory setting for your vehicle.*
- *There are only a total of five auto lock/unlock settings available for automatic transaxle vehicles, and three for manual transaxle vehicles. Be sure to press the unlock side of the driver's door-lock switch the correct number of times according to the selected function number. If the switch is mistakenly pressed six times on an automatic transaxle vehicle or four times on a manual transaxle, the procedure will be invalidated. If this occurs, start the procedure from the beginning.*

Function number	Function*1
1	The auto door-lock function is disabled.
2	All the doors and the liftgate lock automatically when the vehicle speed is about 20 km/h (12 mph) or more.
3	All the doors and the liftgate lock automatically when the vehicle speed is about 20 km/h (12 mph) or more. All the doors and the liftgate unlock when the ignition is switched from ON to Off.
4	<b>(Automatic transaxle vehicles only)</b> When the ignition is switched ON and the shift lever is shifted from park (P) to any other gear position, all the doors and the liftgate lock automatically.
5	<b>(Automatic transaxle vehicles only)</b> When the ignition is switched ON and the shift lever is shifted from park (P) to any other gear position, all the doors and the liftgate lock automatically. When the shift lever is shifted to park (P) while the ignition is switched ON, all the doors and the liftgate unlock automatically.

\*1 Other settings for the auto door lock function are available at an Authorized Mazda Dealer. For details consult an Authorized Mazda Dealer. Refer to Personalization Features on page 9-8.

1. Safely park the vehicle. All doors must remain closed.
2. Switch the ignition ON.
3. Press and hold the lock side of the driver's door-lock switch within 20 seconds of switching the ignition ON, and make sure a beep sound is heard about eight seconds afterwards.
4. Referring to the auto lock/unlock function setting table, determine the function number for the desired setting. Press the unlock side of the driver's door-lock switch the same number of times as the selected function number (Ex. If you select function 2, press the unlock side of the switch only 2 times).
5. Three seconds after the function setting has been changed, a beep sound will beep in the amount of the selected function number. (Ex. Function number 3 = 3 beep sounds)

**NOTE**

- *The doors cannot be locked or unlocked while the setting function is being performed.*
- *The procedure can be cancelled by pressing the lock side of the driver's door-lock switch.*

Before Driving  
**Doors and Locks**

▼ **Locking, Unlocking with Door-Lock Knob**

To lock any door from the inside, press the door-lock knob.

To unlock, pull it outward.

This does not operate the other door locks.

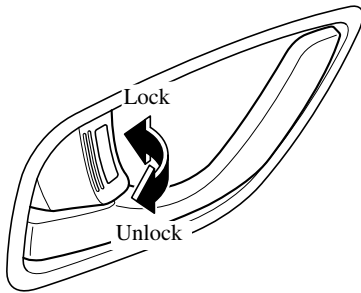

To lock the front passenger door with the door-lock knob from the outside, press the door-lock knob to the lock position and close the door (holding the door handle pulled is not required).

This does not operate the other door locks.

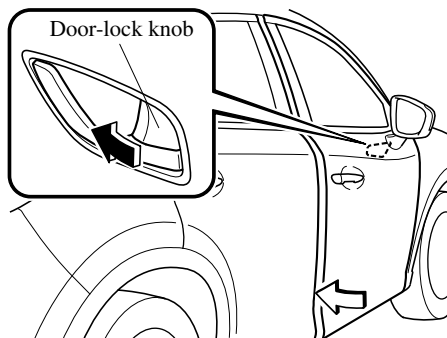

**NOTE**

When locking the door this way:

- Be careful not to leave the key inside the vehicle.
- The driver's door lock knob cannot be used while the driver's door is open.
- The red indication can be seen when the door-lock knob is unlocked.

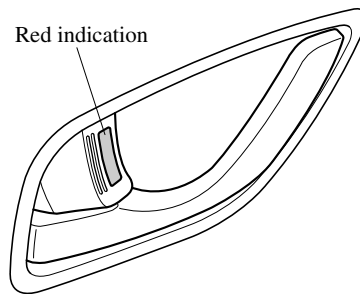

Before Driving

## Doors and Locks

### ▼ Rear Door Child Safety Locks

These locks are intended to help prevent children from accidentally opening the rear doors. Use them both whenever a child rides in the vehicle.

If you slide the child safety lock to the lock position before closing that door, the door cannot be opened from the inside. The door can be opened only by pulling the outside handle.

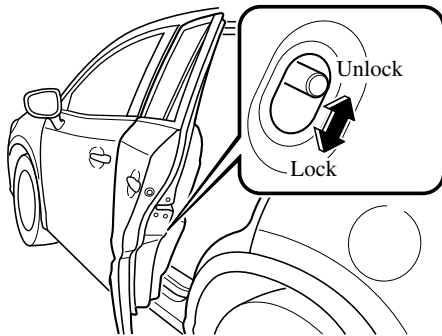

## Liftgate

### ⚠ WARNING

**Never allow a person to ride in the luggage compartment:**

*Allowing a person to ride in the luggage compartment is dangerous. The person in the luggage compartment could be seriously injured or killed during sudden braking or a collision.*

**Do not drive with the liftgate open:**

*Exhaust gas in the cabin of a vehicle is dangerous. An open liftgate in a moving vehicle will cause exhaust gas to be drawn into the cabin. This gas contains CO (carbon monoxide), which is colorless, odorless, and highly poisonous, and it can cause loss of consciousness and death. Moreover, an open liftgate could cause occupants to fall out in an accident.*



## Doors and Locks

### **CAUTION**

*Be careful not to apply excessive force to the damper stay on the liftgate such as by putting your hand on the stay. Otherwise, the damper stay may bend and affect the liftgate operation.*

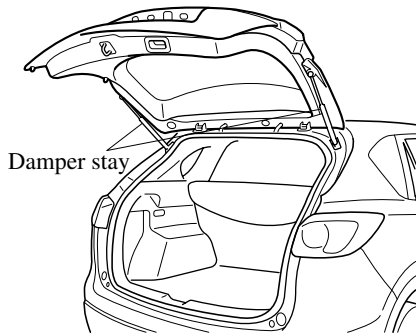

### **▼ Opening and Closing the Liftgate**

#### **Opening the liftgate with Electric liftgate opener**

Press the electric liftgate opener on the liftgate, and then raise the liftgate when the latch releases.

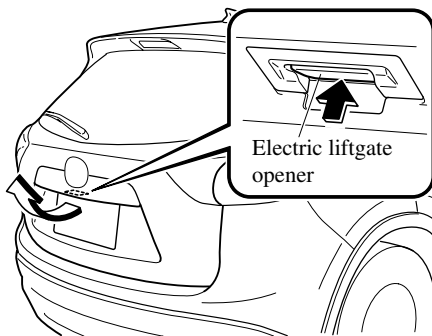

While the ignition is switched ON, the liftgate can be opened only when the vehicle is stopped with the parking brake applied (manual transaxle), or with the selector lever in the P position (automatic transaxle).

#### **NOTE**

- **(With the advanced keyless function)**
  - *A locked liftgate can also be opened while the key is being carried.*
  - *When using the advanced keyless function to open the liftgate, it may require a few seconds for the liftgate to unlock after the electric liftgate opener is pressed.*
  - *The liftgate can be closed when the doors are locked with the key left in the vehicle. However, to prevent leaving the key in the vehicle, the liftgate can be opened by pressing the electric liftgate opener.*
- *When the liftgate is unlocked by pressing the electric liftgate opener, the liftgate raises slightly to allow it to be opened. If the liftgate is not operated for a certain period of time after the electric liftgate opener has been pressed, the liftgate cannot be raised any more from its slightly raised position. Press the electric liftgate opener again to fully open the liftgate. To close the liftgate from its slightly raised position, open it first by pressing the electric liftgate opener, and waiting for 1 second or longer then close it.*

*The door-ajar warning light will illuminate if the liftgate is not fully closed.*
- *The sound of the latch may be heard for a few seconds after the electric liftgate opener has been pressed, however, this does not indicate a malfunction.*

Before Driving

## Doors and Locks

---

### Closing the liftgate

To close, lower the liftgate slowly using the liftgate grip recess, and then push the liftgate closed using both hands.

Do not slam it. Pull up on the liftgate to make sure it is secure.

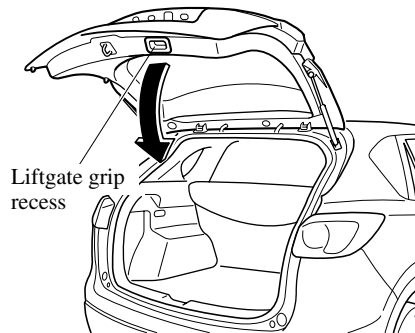

Before Driving  
**Fuel and Emission**

## Fuel and Engine Exhaust Precautions

### ▼ Fuel Requirements

Vehicles with catalytic converters or oxygen sensors must use **ONLY UNLEADED FUEL**, which will reduce exhaust emissions and keep spark plug fouling to a minimum.

Your Mazda will perform best with fuel listed in the table.

Fuel	Octane Rating* (Anti-knock index)
Regular unleaded fuel	87 [ (R+ M)/2 method] or above (91 RON or above)

\* U.S. federal law requires that octane ratings be posted on gasoline station pumps.

Fuel with a rating lower than 87 octane (91 RON) could cause the emission control system to lose effectiveness. It could also cause engine knocking and serious engine damage.

### **CAUTION**

- **USE ONLY UNLEADED FUEL.**  
*Leaded fuel is harmful to the catalytic converter and oxygen sensors and will lead to deterioration of the emission control system and or failures.*
- *Your vehicle can only use oxygenated fuels containing no more than 10 % ethanol by volume. Damage to your vehicle may occur when ethanol exceeds this recommendation, or if the gasoline contains any methanol. Stop using gasohol of any kind if your vehicle engine is performing poorly.*
- *Never add fuel system additives. Otherwise, the emission control system could be damaged. Consult an Authorized Mazda Dealer for details.*

Gasoline blended with oxygenates such as alcohol or ether compounds are generally referred to as oxygenated fuels. The common gasoline blend that can be used with your vehicle is ethanol blended at no more than 10 %. Gasoline containing alcohol, such as ethanol or methanol, may be marketed under the name "Gasohol".

Vehicle damage and drivability problems resulting from the use of the following may not be covered by the Mazda warranty.

- Gasohol containing more than 10 % ethanol.
- Gasoline or gasohol containing methanol.
- Leaded fuel or leaded gasohol.

Before Driving

## Fuel and Emission

---

### ▼ Emission Control System

Your vehicle is equipped with an emission control system (the catalytic converter is part of this system) that enables your vehicle to comply with existing exhaust emissions requirements.

#### **WARNING**

**Never park over or near anything flammable:**

*Parking over or near anything flammable, such as dry grass, is dangerous. Even with the engine turned off, the exhaust system remains very hot after normal use and could ignite anything flammable. A resulting fire could cause serious injury or death.*

#### **CAUTION**

*Ignoring the following precautions could cause lead to accumulate on the catalyst inside the converter or cause the converter to get very hot. Either condition will damage the converter and cause poor performance.*

- **USE ONLY UNLEADED FUEL.**
- *Do not drive your Mazda with any sign of engine malfunction.*
- *Do not coast with the ignition switched off.*
- *Do not descend steep grades in gear with the ignition switched off.*
- *Do not operate the engine at high idle for more than 2 minutes.*
- *Do not tamper with the emission control system. All inspections and adjustments must be made by a qualified technician.*
- *Do not push-start or pull-start your vehicle.*

#### **NOTE**

- *Under U.S. federal law, any modification to the original-equipment emission control system before the first sale and registration of a vehicle is subject to penalties. In some states, such modification made on a used vehicle is also subject to penalties.*
- *While the engine is off, the sound of a valve opening and closing can be heard at the rear of the right side of the vehicle, however this does not indicate an abnormality. Your vehicle has a self-checking device and it operates while the engine is off.*

Before Driving

## Fuel and Emission

### ▼ Engine Exhaust (Carbon monoxide)

#### **! WARNING**

**Do not drive your vehicle if you smell exhaust gas inside the vehicle:**

*Engine exhaust gas is dangerous. This gas contains carbon monoxide (CO), which is colorless, odorless, and poisonous. When inhaled, it can cause loss of consciousness and death. If you smell exhaust gas inside your vehicle, keep all windows fully open and contact an Authorized Mazda Dealer immediately.*

**Do not run the engine when inside an enclosed area:**

*Running the engine inside an enclosed area, such as a garage, is dangerous. Exhaust gas, which contains poisonous carbon monoxide, could easily enter the cabin. Loss of consciousness or even death could occur.*

**Open the windows or adjust the heating or cooling system to draw fresh air when idling the engine:**

*Exhaust gas is dangerous. When your vehicle is stopped with the windows closed and the engine running for a long time even in an open area, exhaust gas, which contains poisonous carbon monoxide, could enter the cabin. Loss of consciousness or even death could occur.*

**Clear snow from underneath and around your vehicle, particularly the tail pipe, before starting the engine:**

*Running the engine when a vehicle is stopped in deep snow is dangerous. The exhaust pipe could be blocked by the snow, allowing exhaust gas to enter the cabin. Because exhaust gas contains poisonous carbon monoxide, it could cause loss of consciousness or even death to occupants in the cabin.*

Before Driving

## Fuel and Emission

### Fuel-Filler Lid and Cap

#### **⚠ WARNING**

*When removing the fuel-filler cap, loosen the cap slightly and wait for any hissing to stop. Then remove it:*

*Fuel spray is dangerous. Fuel can burn skin and eyes and cause illness if ingested. Fuel spray is released when there is pressure in the fuel tank and the fuel-filler cap is removed too quickly.*

*Before refueling, stop the engine, and always keep sparks and flames away from the filler neck:*

*Fuel vapor is dangerous. It could be ignited by sparks or flames causing serious burns and injuries. Additionally, use of the incorrect fuel-filler cap or not using a fuel-filler cap may result in fuel leak, which could result in serious burns or death in an accident.*

#### **⚠ CAUTION**

*(U.S.A. and Canada)*

*Always use only a genuine Mazda fuel-filler cap or an approved equivalent, available at an Authorized Mazda Dealer. The wrong cap can result in a serious malfunction of the fuel and emission control systems. It may also cause the check engine light in the instrument cluster to illuminate.*

#### ▼ Fuel-Filler Lid

To open, pull the remote fuel-filler lid release.

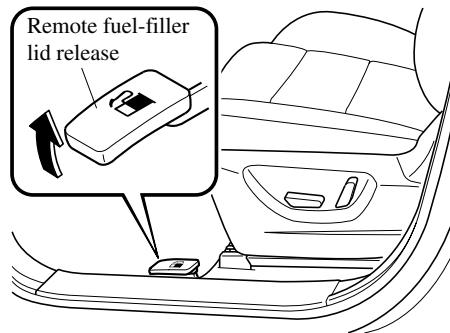

#### ▼ Fuel-Filler Cap

To remove the fuel-filler cap, turn it counterclockwise. Attach the removed cap to the inner side of the fuel lid.

To close the fuel-filler cap, turn it clockwise until a click is heard.

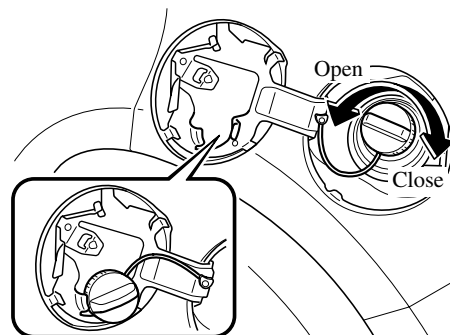

Before Driving  
**Fuel and Emission**

---

**▲ CAUTION**

***(U.S.A. and Canada)***

*If the check fuel cap warning light illuminates, the fuel-filler cap may not be properly installed. If the warning light illuminates, park your vehicle safely off the right-of-way, remove the fuel-filler cap and reinstall it correctly. After the cap has been correctly installed, the fuel cap warning light may continue to illuminate until a number of driving cycles have been completed. A drive cycle consists of starting the engine (after four or more hours with the engine off) and driving the vehicle on city and highway roads.*

*Continuing to drive with the check fuel cap warning light illuminated could cause the check engine light to illuminate as well.*

Before Driving

## Steering Wheel

### Steering Wheel

#### **⚠ WARNING**

***Never adjust the steering wheel while the vehicle is moving:***

*Adjusting the steering wheel while the vehicle is moving is dangerous. Moving it can very easily cause the driver to abruptly turn to the left or right. This can lead to loss of control or an accident.*

#### **▼ Steering Wheel Adjustment**

To change the angle or length of the steering wheel:

1. Stop the vehicle, and then pull down the lock release lever under the steering column.

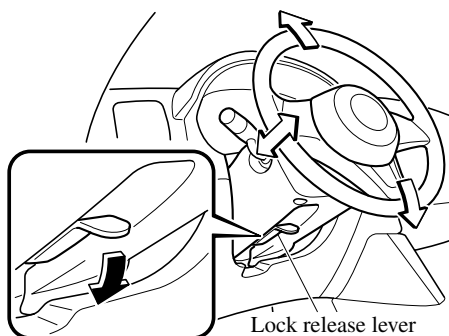

2. Tilt the steering wheel and/or adjust the steering column length to the desired positions, and then push the lever up to lock the column.
3. Attempt to push the steering wheel up and down to make sure it's locked before driving.

3-24



Before Driving  
**Mirrors**

## Mirrors

Before driving, adjust the inside and outside mirrors.

### ▼ Outside Mirrors

#### **! WARNING**

*Be sure to look over your shoulder before changing lanes:*

*Changing lanes without taking into account the actual distance of the vehicle in the convex mirror is dangerous. You could have a serious accident. What you see in the convex mirror is closer than it appears.*

#### Mirror type

##### **Flat type (driver's side)**

Flat surface mirror.

##### **Convex type (front passenger side)**

The mirror has single curvature on its surface.

#### Power mirror adjustment

The ignition must be switched to ACC or ON position.

To adjust:

1. Rotate the mirror adjusting switch to the left or right to choose the left or right side mirror.

2. Depress the mirror switch in the appropriate direction.

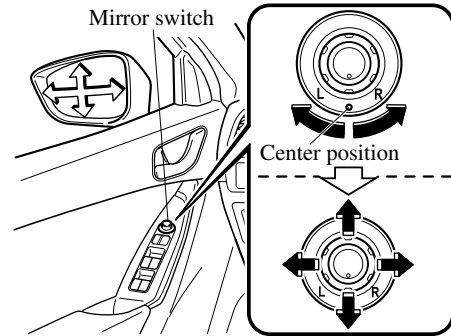

After adjusting the mirror, lock the control by rotating the switch in the center position.

#### Folding mirror

#### **! WARNING**

*Always return the outside mirrors to the driving position before you start driving:*

*Driving with the outside mirrors folded in is dangerous. Your rear view will be restricted, and you could have an accident.*

Fold the outside mirror rearward until it is flush with the vehicle.

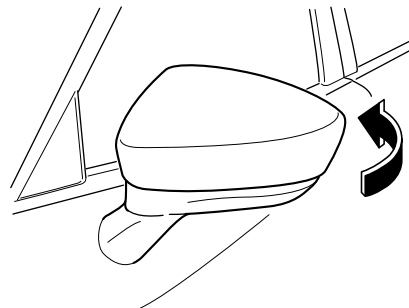

Before Driving

## Mirrors

### ▼ Rearview Mirror

#### **⚠ WARNING**

**Do not stack cargo or objects higher than the seatbacks:**

*Cargo stacked higher than the seatbacks is dangerous. It can block your view in the rearview mirror, which might cause you to hit another car when changing lanes.*

#### **Rearview mirror adjustment**

Before driving, adjust the rearview mirror to center on the scene through the rear window.

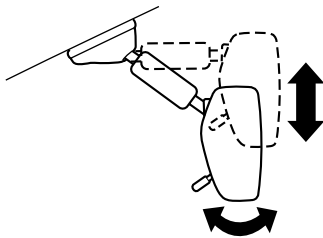

#### **NOTE**

*For the manual day/night mirror, perform the adjustment with the day/night lever in the day position.*

### **Reducing glare from headlights**

#### **Manual day/night mirror**

Push the day/night lever forward for day driving. Pull it back to reduce glare of headlights from cars at the rear.

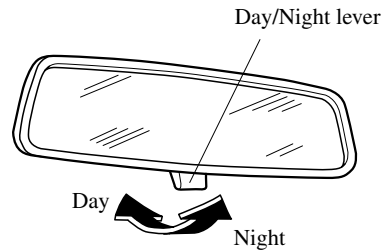

#### **Auto-dimming mirror**

The auto-dimming mirror automatically reduces glare of headlights from cars at the rear when the ignition is switched ON.

Press the OFF button (○) to cancel the automatic dimming function. The indicator light will turn off.

To reactivate the automatic dimming function, press the ON button (|). The indicator light will illuminate.

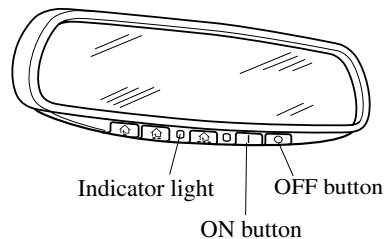



## Before Driving Mirrors

### NOTE

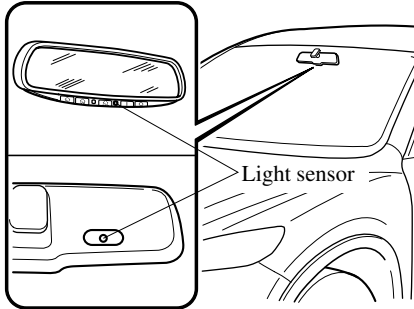
- Do not use glass cleaner or suspend objects on or around the light sensor. Otherwise, light sensor sensitivity will be affected and may not operate normally.



- For information regarding the 3 buttons (  ,  ,  ) on the auto-dimming mirror:  
Refer to HomeLink Wireless Control System on page 4-53.
- The auto-dimmer function is canceled when the ignition is switched ON and the shift lever/selector lever is in reverse (R).

Before Driving

## Windows

### Power Windows

The ignition must be switched ON for the power windows to operate.

#### **⚠ WARNING**

**Make sure the opening is clear before closing a window:**

*Closing power windows are dangerous. A person's hands, head, or even neck could be caught by the window and result in serious injury or even death. This warning applies especially to children.*

**Always lock all passenger power windows with the power window lock switch on the driver's side while children are in the vehicle, and never allow children to play with power window switches:**

*Leaving the power window switches unlocked while children are in the vehicle is dangerous. Power window switches that are not locked with the power window lock switch would allow children to operate power windows unintentionally which could result in serious injury if a child's hands, head or neck becomes caught by the window.*

#### **⚠ CAUTION**

*To prevent burning out the fuse and damaging the power window system, do not open or close more than three windows at once.*

### ▼ Operating the Driver's Side Power Window

#### Normal opening/closing

To open the window to the desired position, lightly hold down the switch.  
To close the window to the desired position, lightly pull up the switch.

#### Master control switches

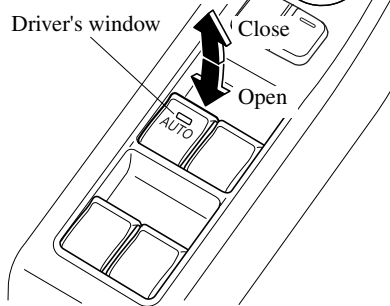

#### Auto-opening/closing

To fully open the window automatically, press the switch completely down, then release. The window will fully open automatically.

To fully close the window automatically, pull the switch completely up, then release. The window will fully close automatically.

To stop the window partway, pull or press the switch in the opposite direction and then release it.

Before Driving  
**Windows**

**Power window system initialization procedure**

If the battery was disconnected during vehicle maintenance, or for other reasons (such as a switch continues to be operated after the window is fully open/closed), the window will not fully open and close automatically.

The power window auto function will only resume on the power window that has been reset.

- 1 Switch the ignition ON.
- 2 Make sure that the power window lock switch located on the driver's door is not depressed.
- 3 Press the switch and fully open the window.
- 4 Pull up the switch to fully close the window and continue holding the switch for about 2 seconds after the window fully closed.

**Jam-safe window**

If a person's hands, head or an object blocks the window during the auto-closing operation, the window will stop and open halfway.

**⚠ WARNING**

***Make sure nothing blocks the window just before it reaches the fully closed position or while holding up the power window switch:***

*Blocking the power window just before it reaches the fully closed position or while holding up the power window switch is dangerous. In this case, the jam-safe function cannot prevent the window from closing all the way. If fingers are caught, serious injuries could occur.*

**NOTE**

- *Depending on driving conditions, a closing power window could stop and start opening when the window feels a shock that is similar to something blocking it. In the event the jam-safe function activates and the power window cannot be closed automatically, pull and hold the switch and the window will close.*
- *The jam-safe window function does not operate until the system has been reset.*

**Engine-off power window operation**

The power window can be operated for about 40 seconds after the ignition is switched from ON to off with all doors closed. If any door is opened, the power window will stop operating.

**NOTE**

*For engine-off operation of the power window, the switch must be held up firmly throughout window closure because the auto-closing function will be inoperable.*

Before Driving

## Windows

### ▼ Operating the Passenger Power Windows

The power windows may be operated when the power window lock switch on the driver's door is in the unlocked position.

The passenger windows may be opened or closed using the master control switches on the driver's door.

#### Master control switches

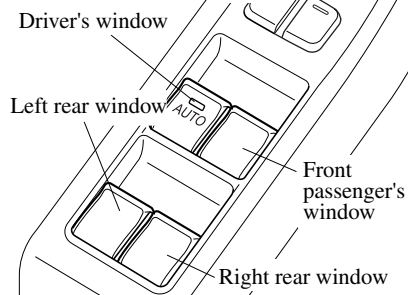

To open the window to the desired position, hold down the switch.  
To close the window to the desired position, pull up the switch.

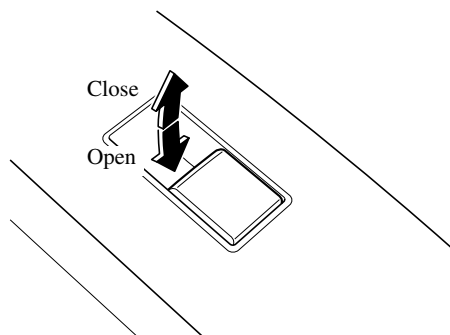

### ▼ Power Window Lock Switch

With the lock switch in the unlocked position (button not depressed), all power windows on each door can be operated.

With the lock switch in the locked position (button depressed), only the driver's side power window can be operated.

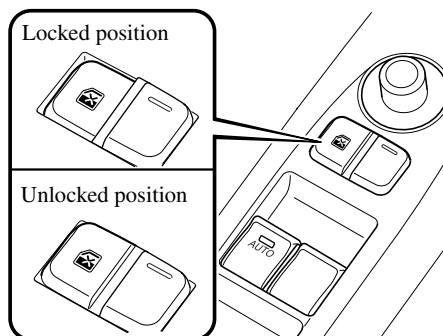

#### **⚠ WARNING**

***Unless a passenger needs to operate a power window, keep the power window lock switch in the locked position:***

*Unintentional power window operation is dangerous. A person's hands, head, or neck could be caught by the window and result in serious injury.*

Before Driving  
**Windows**

**Moonroof\***

The moonroof can be opened or closed electrically only when the ignition is switched ON.

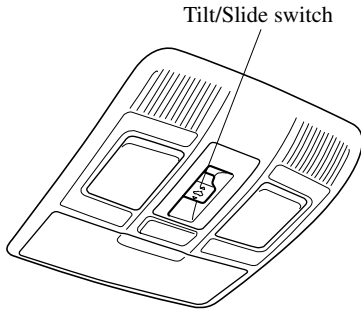

**⚠ WARNING**

**Do not let passengers stand up or extend part of the body through the open moonroof while the vehicle is moving:**

*Extending the head, arms, or other parts of the body through the moonroof is dangerous. The head or arms could hit something while the vehicle is moving. This could cause serious injury or death.*

**Make sure the opening is clear before closing the moonroof:**

*A closing moonroof is dangerous. The hands, head, or even neck of a person, especially a child, could be caught in it as it closes, causing serious injury or even death.*

**NOTE**

*Before washing your Mazda, make sure the moonroof is completely closed so that water does not get inside the cabin area. After washing your Mazda or after it rains, wipe the water off the moonroof before operating it to avoid water penetration which could cause rust and water damage to your headliner.*

**▼ Tilt Operation**

The rear of the moonroof can be tilted open to provide more ventilation.

To fully tilt automatically, momentarily press the tilt/slide switch.

To stop tilting partway, press the tilt/slide switch.

To close to the desired position, press the tilt/slide switch in the forward direction.

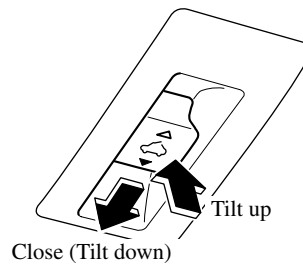

**▼ Slide Operation**

To fully open automatically, momentarily press the tilt/slide switch in the backward direction.

To stop tilting partway, press the tilt/slide switch.

Before Driving

## Windows

To close to the desired position, press the tilt/slide switch in the forward direction.

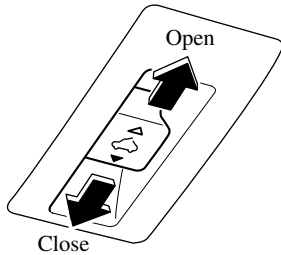

### ▼ Power Moonroof Re-set Procedure

If the battery is disconnected, the moonroof will not operate. The moonroof will not operate correctly until it is re-set. Carry out the following procedure to re-set the moonroof and resume operation:

1. Switch the ignition ON.
2. Press the tilt switch, to partially tilt open the rear of the moonroof.
3. Repeat Step 2. The rear of the moonroof tilts open to the fully open position, then closes a little.

#### **NOTE**

*If the re-set procedure is performed while the moonroof is in the slide position (partially open) it closes before the rear tilts opens.*

### ▼ Sunshade

The sunshade can be opened and closed by hand.

The sunshade opens automatically when the moonroof is opened, but must be closed by hand.

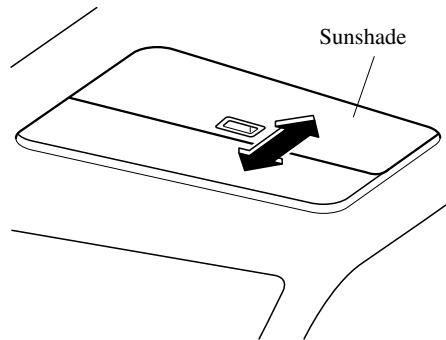

### **CAUTION**

- *The sunshade does not tilt. To avoid damaging the sunshade, do not push up on it.*
- *Do not close the sunshade while the moonroof is opening. Trying to force the sunshade closed could damage it.*



Before Driving  
**Security System**

## Modification and Add-On Equipment

Mazda cannot guarantee the immobilizer and the theft-deterrent systems' operation if the system has been modified or if any add-on equipment has been installed.

### CAUTION

*To avoid damage to your vehicle, do not modify the system or install any add-on equipment to the immobilizer and the theft-deterrent systems or the vehicle.*

## Immobilizer System

The immobilizer system allows the engine to start only with a key the system recognizes.

If someone attempts to start the engine with an unrecognized key, the engine will not start, thereby helping to prevent the theft of your vehicle.

If you have a problem with the immobilizer system or the key, consult an Authorized Mazda Dealer.

### CAUTION

- *Radio equipment like this is governed by laws. Changes or modifications not expressly approved by the party responsible for compliance could void the user's authority to operate the equipment.*
- *To avoid damage to the key, do not:
  - *Drop the key.*
  - *Get the key wet.*
  - *Expose the key to any kind of magnetic field.*
  - *Expose the key to high temperatures on places such as the dashboard or hood, under direct sunlight.**
- *If the engine does not start with the correct key, and the security indicator light keeps illuminating or flashing, the system may have a malfunction. Consult an Authorized Mazda Dealer.*

Before Driving

## Security System

### NOTE

- *The keys carry a unique electronic code. For this reason, and to assure your safety, obtaining a replacement key requires some waiting time. They are only available through an Authorized Mazda Dealer.*
- *Always keep a spare key in case one is lost. If a key is lost, consult an Authorized Mazda Dealer as soon as possible.*
- *If you lose a key, an Authorized Mazda Dealer will reset the electronic codes of your remaining keys and immobilizer system. Bring all the remaining keys to an Authorized Mazda Dealer to reset. Starting the vehicle with a key that has not been reset is not possible.*

### ▼ Operation

#### NOTE

- *The engine may not start and security indicator light may illuminate or flash if the key is placed in an area where it is difficult for the system to detect the signal, such as on the dashboard or in the glove compartment. Move the key to a location within the signal range, switch the ignition off, and then restart the engine.*
- *Signals from a TV or radio station, or from a transceiver or mobile telephone could interfere with your immobilizer system. If you are using the proper key and the engine fails to start, check the security indicator light.*

### Arming

The system is armed when the push button start is pressed from ON to off. The security indicator light in the instrument cluster flashes every 2 seconds until the system is disarmed. Refer to Warning/Indicator Lights on page 4-15.



### Disarming

The system is disarmed when the ignition is switched ON with the correct programmed key. The security indicator light illuminates for about 3 seconds and then turns off. If the engine does not start with the correct key, and the security indicator light remains illuminated or flashing, try the following: Make sure the key is within the operational range for signal transmission. Switch the ignition off, and then restart the engine. If the engine does not start after 3 or more tries, contact an Authorized Mazda Dealer.

#### NOTE

- *If the security indicator light flashes continuously while you are driving, do not shut off the engine. Go to an Authorized Mazda Dealer and have it checked. If the engine is shut off while the indicator light is flashing, you will not be able to restart it.*
- *Because the electronic codes are reset when the immobilizer system is repaired, the keys are needed. Make sure to bring all the keys to an Authorized Mazda Dealer so that they can be programmed.*

Before Driving  
**Security System**

## Theft-Deterrent System \*

If the theft deterrent system detects an inappropriate entry into the vehicle, which could result in the vehicle or its contents being stolen, the alarm alerts the surrounding area of an abnormality by sounding the horn and flashing the hazard warning lights.

The system will not function unless it's properly armed. So when you leave the vehicle, follow the arming procedure correctly.

### ▼ Operation

#### System triggering conditions

The horn sounds intermittently and the hazard warning lights flash for about 30 seconds when the system is triggered by any one of the following:

- Unlocking a door with the door lock switch or an inside door-lock knob.
- Forcing open a door, the hood or the liftgate.
- Opening the hood by operating the hood release handle.
- Switching the ignition ON without using the push button start.

If the system is triggered again, the lights and horn will activate until the driver's door or the liftgate is unlocked with the auxiliary key or with the transmitter.

#### **(With advanced key)**

The lights and horn can also be deactivated by pressing the request switch on a door.

#### **NOTE**

*If the battery goes dead while the theft-deterrent system is armed, the horn will activate and the hazard warning lights will flash when the battery is charged or replaced.*

### ▼ How to Arm the System

1. Close the windows and the moonroof\* securely.
2. Press the push button start off.
3. Make sure the hood, the doors, and the liftgate are closed.
4. Press the lock button on the transmitter or lock the driver's door from the outside with the auxiliary key. The hazard warning lights will flash once.

The following method will also arm the theft-deterrent system:

Press the door-lock switch “” while any door is open and then close all of the doors.

#### **(With the advanced keyless function)**

Press a request switch.

The security indicator light in the instrument panel flashes twice per second for 20 seconds.

Refer to Warning/Indicator Lights on page 4-15.



5. After 20 seconds, the system is fully armed.

Before Driving

## Security System

### NOTE

- The theft deterrent system can also be armed by activating the auto relock function with all the doors, the liftgate and the hood closed.  
Refer to Transmitter on page 3-4.
- The system will disarm if one of the following operations takes place within 20 seconds after pressing the lock button:
  - Unlocking a door.
  - Any door or the liftgate is opened.
  - The hood is opened.
  - The ignition is switched on.
  - **(With the advanced keyless function)**  
Press the electric liftgate opener while the key is being carried.

To rearm the system, do the arming procedure again.

- When the doors are locked by pressing the lock button on the transmitter or using the auxiliary key while the theft-deterrent system is armed, the hazard warning lights will flash once to indicate that the system is armed.

### ▼ To Turn Off an Armed System

An armed system can be turned off using any one of the following methods:

- Unlock the driver's door with the auxiliary key.
- Press the unlock button on the transmitter.
- Switch the ignition ON.
- **(With the advanced keyless function)**  
Press a request switch on the doors.

The hazard warning lights will flash twice.

### NOTE

When the doors are unlocked by pressing the unlock button on the transmitter or using the auxiliary key while the theft-deterrent system is turned off, the hazard warning lights will flash twice to indicate that the system is turned off.

### ▼ To Stop the Alarm

A triggered alarm can be turned off using any one of the following methods:

- Unlock the driver's door with the auxiliary key.
- Press the unlock button on the transmitter.
- The engine is started with the push button start.
- **(With the advanced keyless function)**
  - Press a request switch on the doors.
  - Press the electric liftgate opener while the key is being carried.

The hazard warning lights will flash twice.

### ▼ Theft-Deterrent Labels



A label indicating that your vehicle is equipped with a Theft-Deterrent System is in the glove compartment.

Mazda recommends that you affix it to the lower rear corner of a front door window.

Before Driving  
**Driving Tips**

### Break-In Period

No special break-in is necessary, but a few precautions in the first 1,000 km (600 miles) may add to the performance, economy, and life of your Mazda.

- Do not race the engine.
- Do not maintain one constant speed, either slow or fast, for a long period of time.
- Do not drive constantly at full-throttle or high engine rpm for extended periods of time.
- Avoid unnecessary hard stops.
- Avoid full-throttle starts.
- Do not tow a trailer.

### Money-Saving Suggestions

How you operate your Mazda determines how far it will travel on a tank of fuel. Use these suggestions to help save money on fuel and repairs.

- Avoid long warm-ups. Once the engine runs smoothly, begin driving.
- Avoid fast starts.
- Keep the engine tuned. Follow the maintenance schedule (page 6-3) and have an Authorized Mazda Dealer perform inspections and servicing.
- Use the air conditioner only when necessary.
- Slow down on rough roads.
- Keep the tires properly inflated.
- Do not carry unnecessary weight.
- Do not rest your foot on the brake pedal while driving.
- Keep the wheels in correct alignment.
- Keep windows closed at high speeds.
- Slow down when driving in crosswinds and headwinds.

### **WARNING**

***Never stop the engine when going down a hill:***

*Stopping the engine when going down a hill is dangerous. This causes the loss of power steering and power brake control, and may cause damage to the drivetrain. Any loss of steering or braking control could cause an accident.*

Before Driving

## Driving Tips

### Hazardous Driving

#### **⚠ WARNING**

**Be extremely careful if it is necessary to downshift on slippery surfaces:**

*Downshifting into lower gear while driving on slippery surfaces is dangerous. The sudden change in tire speed could cause the tires to skid. This could lead to loss of vehicle control and an accident.*

When driving on ice or in water, snow, mud, sand, or similar hazards:

- Be cautious and allow extra distance for braking.
- Avoid sudden braking and sudden maneuvering.
- Do not pump the brakes. Continue to press down on the brake pedal. Refer to Antilock Brake System (ABS) on page 4-61.
- If you get stuck, select a lower gear and accelerate slowly. Do not spin the front wheels.
- For more traction in starting on slippery surfaces such as ice or packed snow, use sand, rock salt, chains, carpeting, or other nonslip material under the front wheels.

#### **NOTE**

*Use snow chains only on the front wheels.*

### Floor Mat

#### **⚠ WARNING**

**Make sure the floor mats are hooked on the retention pins to prevent them from bunching up under the foot pedals:**

*Using a floor mat that is not secured is dangerous as it will interfere with the accelerator and brake pedal operation, which could result in an accident.*

**Do not install two floor mats, one on top of the other, on the driver's side:**

*Installing two floor mats, one on top of the other, on the driver's side is dangerous as the retention pins can only keep one floor mat from sliding forward.*

*In using a heavy duty floor mat for winter use always remove the original floor mat.*

*Loose floor mat(s) will interfere with the foot pedal and could result in an accident.*

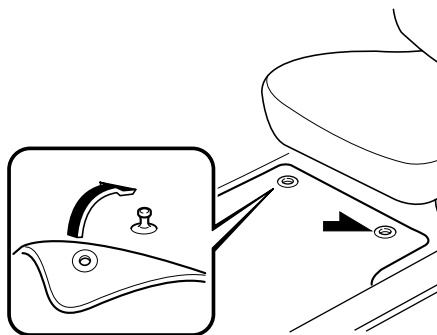

When setting a floor mat, position the floor mat so that its grommets are inserted over the pointed end of the retention posts.

Before Driving  
**Driving Tips**

### Rocking the Vehicle

#### **⚠ WARNING**

***Do not spin the wheels at more than 56 km/h (35 mph), and do not allow anyone to stand behind a wheel when pushing the vehicle:***

*When the vehicle is stuck, spinning the wheels at high speed is dangerous. The spinning tire could overheat and explode. This could cause serious injuries.*

#### **⚠ CAUTION**

*Too much rocking may cause engine overheating, transaxle failure, and tire damage.*

If you must rock the vehicle to free it from snow, sand or mud, depress the accelerator slightly and slowly move the shift lever from 1 (D) to R.

### Winter Driving

Carry emergency gear, including tire chains, window scraper, flares, a small shovel, jumper cables, and a small bag of sand or salt.

Ask an Authorized Mazda Dealer to perform the following precautions:

- Have the proper ratio of antifreeze in the radiator.  
Refer to Engine Coolant on page 6-22.
- Inspect the battery and its cables. Cold reduces battery capacity.
- Use only cold-weather engine oil (page 6-20).
- Inspect the ignition system for damage and loose connections.
- Use washer fluid made with antifreeze—but do not use engine coolant antifreeze for washer fluid (page 6-25).
- Do not use the parking brake in freezing weather as it may freeze. Instead, shift to P with an automatic transaxle and to 1 or R with a manual transaxle. Block the rear wheels.
- Do not apply excessive force to a window scraper when removing ice or frozen snow on the mirror glass and windshield.
- Never use warm or hot water for removing snow or ice from windows and mirrors as it could result in the glass cracking.
- Braking performance can be adversely affected if snow or ice adheres to the brake equipment. If this situation occurs, drive the vehicle slowly, releasing the accelerator pedal and lightly applying the brakes several times until the brake performance returns to normal.

Before Driving

## Driving Tips

### ▼ Snow Tires

#### Use snow tires on all four wheels

Do not go faster than 120 km/h (75 mph) while driving with snow tires. Inflate snow tires 30 kPa (0.3 kgf/cm<sup>2</sup>, 4.3 psi) more than recommended on the tire pressure label (driver's door frame), but never more than the maximum cold-tire pressure shown on the tires.

Your vehicle is originally equipped with all season radials designed to be used all year around. In some extreme climates you may find it necessary to replace them with snow tires during the winter months to further improve traction on snow and ice covered roads.

#### **⚠ WARNING**

**Use only the same size and type tires (snow, radial, or non-radial) on all four wheels:**

*Using tires different in size or type is dangerous. Your vehicle's handling could be greatly affected and result in an accident.*

#### **⚠ CAUTION**

*Check local regulations before using studded tires.*

### ▼ Tire Chains

Check local regulations before using tire chains.

#### **⚠ CAUTION**

- *Chains may affect handling.*
- *Do not go faster than 50 km/h (30 mph) or the chain manufacturer's recommended limit, whichever is lower.*
- *Drive carefully and avoid bumps, holes, and sharp turns.*
- *Avoid locked-wheel braking.*
- *Do not use chains on a temporary spare tire; it may result in damage to the vehicle and to the tire.*
- *Do not use chains on roads that are free of snow or ice. The tires and chains could be damaged.*
- *Chains may scratch or chip aluminum wheels.*

#### **NOTE**

*The tire pressure monitoring system may not function correctly when using tire chains.*

Install the chains on the front tires only. Do not use chains on the rear tires. Please consult an Authorized Mazda Dealer.

#### **Installing the chains**

1. Secure the chains on the front tires as tightly as possible. Always follow the chain manufacturer's instructions.
2. Retighten the chains after driving 1/2 —1 km (1/4—1/2 mile).



Before Driving  
**Driving Tips**

### Driving In Flooded Area

#### **! WARNING**

*Dry off brakes that have become wet by driving slowly, releasing the accelerator pedal and lightly applying the brakes several times until the brake performance returns to normal:*

*Driving with wet brakes is dangerous. Increased stopping distance or the vehicle pulling to one side when braking could result in a serious accident. Light braking will indicate whether the brakes have been affected.*

#### **! CAUTION**

*Do not drive the vehicle on flooded roads as it could cause short circuiting of electrical/electronic parts, or engine damage or stalling from water absorption. If the vehicle has been immersed in water, consult an Authorized Mazda Dealer.*

### Overloading

#### **! WARNING**

*Be careful not to overload your vehicle: The gross axle weight rating (GAWR) and the gross vehicle weight rating (GVWR) of your vehicle are on the Motor Vehicle Safety Standard Label on the driver's door frame. Exceeding these ratings can cause an accident or vehicle damage. You can estimate the weight of your load by weighing the items (or people) before putting them in the vehicle.*

Before Driving

## Driving Tips

### Driving on Uneven Road

Your vehicle's suspension and underbody can be damaged if driven on rough/uneven roads or over speed bumps at excessive speeds. Use care and reduce speed when traveling on rough/uneven roads or over speed bumps.

Use care not to damage the vehicle's underbody, bumpers or muffler(s) when driving under the following conditions:

- Ascending or descending a slope with a sharp transition angle
- Ascending or descending a driveway or trailer ramp with a sharp transition angle

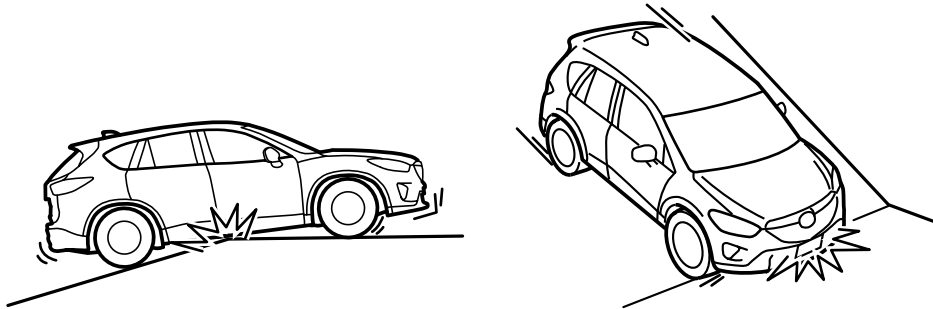

Your vehicle is equipped with low profile tires allowing class-leading performance and handling. As a result, the sidewall of the tires are very thin and the tires and wheels can be damaged if driven through potholes or on rough/uneven roads at excessive speeds. Use care and reduce speed when traveling on rough/uneven roads or through potholes.

## Trailer Towing (U.S.A. and Canada)

Your Mazda was designed and built primarily to carry passengers and cargo. If you tow a trailer, follow these instructions because driver and passenger safety depends on proper equipment and safe driving habits. Towing a trailer will affect handling, braking, durability, performance, and fuel economy. Never overload vehicle or trailer. Consult an Authorized Mazda Dealer if you need further details.

### **CAUTION**

*Do not tow a trailer during the first 1,000 km (600 miles) of your new Mazda. If you do, you may damage the engine, transaxle, differential, wheel bearings, and other power train components.*

### **Weight Limits**

#### **TTW**

**The total trailer weight (TTW), gross axle weight rating (GAWR), trailer load, and trailer tongue load must be within the prescribed limits.**

**The total trailer weight (TTW) is the sum of the weights of the trailer load (trailer weight plus cargo), trailer hitch, vehicle passengers, and vehicle load. Never allow the total trailer weight (TTW) to exceed specifications in the Trailer Towing-Load Table.**

#### **GAWR and GVWR**

Do not exceed front and rear GAWR (gross axle weight rating) and GVWR (gross vehicle weight rating). If you do, vehicle handling, braking, and performance will be affected. These values are also on the Motor Vehicle Safety Certification Label posted on the driver's door frame.

#### **High-altitude operation**

In a high-altitude operating environment, a gasoline engine loses power at a rate of 3 % to 4 % per 304 m (1,000 ft) of elevation. In these conditions, a reduction in gross vehicle weight and gross combination weight is recommended.

**Before Driving**  
**Towing**

**TRAILER TOWING-LOAD TABLE**

Because vehicle weights vary, adjustments must be made to meet the requirements in this table.

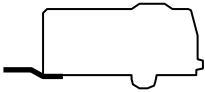
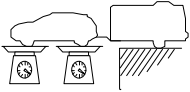
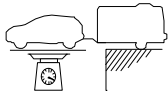
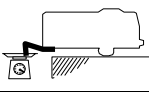
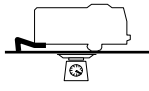
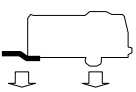
Item		Model			
		2WD		AWD	
		Manual transaxle	Automatic transaxle		
<b>MAX. TTW</b>	Add trailer's weight, load and hitch; vehicle passengers and vehicle load*1 	907 kg (2,000 lb)			
<b>MAX. GAWR</b>		Front	964 kg (2,125 lb)	1,000 kg (2,205 lb)	1,016 kg (2,240 lb)
		Rear	966 kg (2,130 lb)	964 kg (2,125 lb)	1,011 kg (2,229 lb)
<b>MAX. GVWR</b>		1,927 kg (4,248 lb)	1,961 kg (4,323 lb)	2,024 kg (4,462 lb)	
<b>TRAILER-TONGUE LOAD</b>	Tongue load		Tongue load/Trailer load × 100 = 10 % to 15 %		
	Trailer load				
<b>DISTRIBUTION OF TRAILER LOAD</b>		Front	60 %		
		Rear	40 %		

\*1 i.e. baggage, food, camp gear

GAWR: Gross Axle Weight Rating

GVWR: Gross Vehicle Weight Rating

Before Driving  
**Towing**

**⚠ WARNING**

**Always keep tow loads within specified limits as indicated in the Trailer Towing-Load Table:**

*Attempting to tow loads greater than those specified is dangerous as it may cause serious handling and performance problems that could result in personal injury or vehicle damage, or both.*

**Load your trailer with the weight about 60 % toward the front and 40 % toward the rear:**

*Loading the trailer with more weight in the rear than in the front is dangerous. Doing so could cause you to lose control. The trailer tongue load must be 10 %—15 % of the total trailer load (sum of the weights of the trailer and cargo).*

**Always have the total trailer weight and tongue load determined prior to departure:**

*Attempting to tow loads without determining the total trailer weight and tongue load is dangerous. Trailer sway from crosswinds, rough roads or other causes could result in loss of control and a serious accident.*

**⚠ CAUTION**

*The total trailer weight and tongue load can be determined by weighing the trailer on platform scales at a highway weight station or a trucking company.*

**▼ Trailer Hitch**

Use only a hitch ball recommended by the trailer manufacturer that conforms to the gross trailer weight requirement.

When not towing a trailer, remove the trailer hitch (if detachable) to reduce the possibility of damage as a result of the vehicle being rear-ended.

Before Driving

## Towing

### **WARNING**

**Always make sure the trailer hitch is securely attached before departure:**

*An unsecured trailer hitch is dangerous as it causes greater trailer sway from crosswinds, rough roads or other causes, resulting in loss of control and a serious accident.*

*Examine all trailer-hitch mounting bolts regularly and tighten any that are loose. If the hitch is removed, seal any open mounting holes to prevent exhaust, dust, water, dirt and other foreign elements from filtering in, possibly endangering personal safety and damaging your vehicle.*

*Do not install a hitch that stiffens the bumper as it will reduce the bumper's performance.*

**Make sure there are no exhaust gas leaks into the passenger compartment if any mounting bolts are connected to the body:**

*Modifying your vehicle exhaust system is dangerous. Exhaust gas entering the vehicle could cause loss of consciousness or even death.*

*When mounting the trailer hitch, make no modifications to the vehicle exhaust system.*

### **CAUTION**

- *Make all hitch adjustments with actual loads. Do not load and unload vehicle while adjusting hitch. This action will change the vehicle height.*
- *Do not use an axle-mounted hitch. This may damage the axle and related parts.*

### ▼ **Tires**

When towing a trailer, make sure all tires are inflated to the recommended cold-tire pressure, as indicated on the tire pressure chart on the driver's door frame. Trailer tire size, load rating, and inflation pressures should conform to tire manufacturer specifications.

### **WARNING**

**Never use the temporary spare tire when towing:**

*Using the temporary spare tire on your vehicle when towing a trailer is dangerous as it could result in tire failure, loss of control, and injury to vehicle occupants.*



Before Driving  
**Towing**

▼ **Safety Chains**

Safety chains must be used as a precautionary measure should the trailer become unintentionally unhitched. They should cross under the trailer tongue and attach to the hitch. Leave enough slack to allow full turns. Consult literature published by your trailer or hitch manufacturer for more details.

**⚠ WARNING**

***Make sure the safety chain is securely attached to both the trailer and the vehicle prior to departure:***

*Towing a trailer without using a safety chain securely attached to both the trailer and the vehicle is dangerous. If damage occurs to the coupling unit or hitch ball, the trailer could wander into another lane and cause a collision.*

▼ **Trailer Lights**

Trailer lights must comply with all federal, state, and local regulations. Equip your trailer as required before towing it day or night.

**⚠ CAUTION**

*Do not connect a trailer lighting system directly to the lighting system of your Mazda. This may damage your vehicle's electrical system and lighting systems. Have a recreational vehicle dealer or trailer rental agency connect the system, and inspect the brake lights and turn signals yourself before each trip.*

▼ **Trailer Brakes**

If the total trailer weight exceeds 450 kg (1,000 lb), trailer brakes are required. If your trailer has brakes, make sure they comply with all federal, state, and local regulations.

**⚠ WARNING**

***Do not connect a hydraulic trailer-brake system to your vehicle's brake system:***

*Connecting a hydraulic trailer-brake system directly to the vehicle brake system is dangerous and will result in inadequate braking and possible injury.*

▼ **Trailer Towing Tips**

- Verify that your Mazda maintains a near-normal attitude when a loaded or unloaded trailer is connected. Do not drive if it has an abnormal front-up or front-down position. Inspect for incorrect tongue load, worn suspension parts, and trailer overloading.
- Make sure the trailer is properly loaded and the cargo is secure to prevent it from shifting.
- Make sure the mirrors conform to all government regulations. If they do not, install required rear view mirrors appropriate for towing purposes.

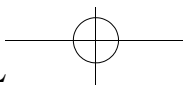



**Before Driving**

## **Towing**

---

The three main causes of vehicle-trailer accidents are driver error, excessive speed, and improper trailer loading.

### **Before driving**

- Have your cooling and braking system checked by an Authorized Mazda Dealer.
- Before starting out, inspect the operation of all vehicle and trailer lights and all vehicle-to-trailer connections. Stop and re-inspect all lights and connections after driving a short distance.

### **Driving**

- Your Mazda will handle differently with a trailer in tow, so practice turning, backing, and stopping in a traffic-free area.
- Take time to get accustomed to the extra weight and length.
- Allow more room between your vehicle and the one in front because braking distance increases with a trailer. For each 16 km/h (10 mph) of speed, allow at least one vehicle and trailer length between your Mazda and the vehicle ahead.
- Avoid jerky starts or sudden acceleration.
- Avoid sudden braking. It may cause loss of control and result in jackknifing, especially so on wet or slippery roads.
- Shift the shift lever to the D position when towing a trailer in hilly terrain or when heavily loaded.

The D position will allow operating the vehicle without frequent shifting.

### **Lane changes and turning**

Avoid quick lane changes, sudden turns, and tight turns. Slow down before turning to avoid the need of sudden braking.

A turning trailer will make a tighter arc than the tow vehicle. Compensate with turns that are larger than normal.

### **Passing**

Plan well ahead to pass other vehicles, and provide plenty of room before changing lanes. Crosswinds from passing vehicles, especially larger ones, and the effects of rough roads will affect handling.

If swaying occurs, firmly grip the steering wheel and reduce speed immediately, but gradually.

Steer straight ahead. If no extreme correction of steering or braking is made, the combination of less speed and firm steering will result in stability.

### **Backing up**

Backing a vehicle with a trailer requires practice and patience. Back slowly, and have a helper outside at the rear of the trailer to reduce the risk of an accident.

To turn the trailer, place your hand at the bottom of the steering wheel and turn it in the direction you want the trailer to go. Make only slight movements to prevent sharp or prolonged turning.

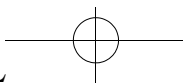





Before Driving  
**Towing**

**Ascending a hill**

Shift into a lower gear to reduce the possibility of overloading or overheating the engine, or both.

**Descending a hill**

Shift into a lower gear and use engine compression as a braking effect.

** WARNING**

***Always use lower gears to reduce speed:***

*Holding the brake pedal down too long or too frequently is dangerous as it could cause the brakes to overheat and lose power, resulting in loss of control and a serious accident. Use lower gears to help reduce speed. Pull off the road and allow brakes to cool down whenever braking performance feels reduced.*

**Overheated engine**

The extra weight of the trailer may strain the engine on hot days and on long or steep upgrades.

If the temperature gauge indicates overheating, turn off the air conditioner, drive safely to the side of the road, park off the right-of-way and wait for engine to cool. Refer to Overheating (page 7-18).

**Parking**

Always make sure the tires of the trailer and the tow vehicle are blocked while parked. Apply the parking brake firmly and put the transaxle in P.

**Avoid parking on an incline, but if you must, follow these instructions:**

1. Depress and hold down the brake pedal.
2. Have a helper put wheel blocks against the downhill side of all vehicle and trailer tires.
3. Then release the brake pedal slowly until the blocks bear the load.
  - If the grade is downhill, turn the steering wheel so that the front of the front tires face the curb.
  - If it is uphill, face the rear of the front tires against the curb.
4. Firmly apply the parking brake.
5. Shift the transaxle into P, and stop the engine.

**To restart after parking on an incline:**

1. With the transaxle in P, start the engine. (Be sure to depress and hold the brake pedal.)
2. Shift into gear.

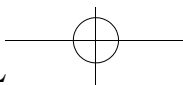



**Before Driving**

## **Towing**

---

3. Release the parking brake (also the foot brake) and pull away from the wheel blocks. Stop; apply the parking brake and shift into P.
4. Have a helper retrieve the wheel blocks.

### **Fuel consumption**

Trailer towing causes higher fuel consumption.

### **Maintenance**

If you tow a trailer frequently, have your vehicle serviced as shown in Scheduled Maintenance (page 6-3).

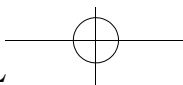

# 4 When Driving

Information concerning safe driving and stopping.

<b>Start/Stop Engine</b> .....	<b>4-2</b>	<b>Power Steering</b> .....	<b>4-66</b>
Ignition Switch .....	4-2	Power Steering .....	4-66
Starting the Engine .....	4-3	<b>Cruise Control</b> .....	<b>4-67</b>
Turning the Engine Off .....	4-7	Cruise Control .....	4-67
<b>Instrument Cluster and Display</b> .....	<b>4-9</b>	<b>Tire Pressure Monitoring System</b> .....	<b>4-70</b>
Meters and Gauges .....	4-9	Tire Pressure Monitoring System .....	4-70
Warning/Indicator Lights .....	4-15	<b>Blind Spot Monitoring (BSM) System</b> .....	<b>4-74</b>
<b>Transaxle</b> .....	<b>4-31</b>	Blind Spot Monitoring (BSM) System* .....	4-74
Manual Transaxle Operation .....	4-31	<b>Rear View Monitor</b> .....	<b>4-78</b>
Automatic Transaxle Controls .....	4-33	Rear View Monitor* .....	4-78
<b>Switches and Controls</b> .....	<b>4-40</b>		
Lighting Control .....	4-40		
Fog Lights* .....	4-45		
Turn and Lane-Change Signals .....	4-45		
Windshield Wipers and Washer .....	4-46		
Rear Window Wiper and Washer .....	4-50		
Rear Window Defroster .....	4-51		
Horn .....	4-52		
Hazard Warning Flasher .....	4-52		
HomeLink Wireless Control System* .....	4-53		
<b>Brake</b> .....	<b>4-56</b>		
Brake System .....	4-56		
<b>ABS/TCS/DSC</b> .....	<b>4-61</b>		
Antilock Brake System (ABS) .....	4-61		
Traction Control System (TCS) .....	4-61		
Dynamic Stability Control (DSC) .....	4-62		
<b>AWD</b> .....	<b>4-64</b>		
All-Wheel Drive (AWD) Operation...	4-64		

\*Some models. **4-1**

When Driving

## Start/Stop Engine

### Ignition Switch

#### ▼ Push Button Start Positions

The system operates only when the driver is in the vehicle or within operational range while the key is being carried.

Each time the push button start is pressed, the ignition switches in the order of off, ACC, and ON. Pressing the push button start again from ON switches the ignition off.

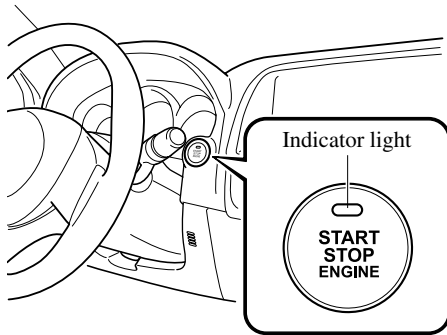

#### NOTE

- The engine starts by pressing the push button start while depressing the clutch pedal (manual transaxle) or the brake pedal (automatic transaxle). To switch the ignition position, press the push button start without depressing the pedal.
- Do not leave the ignition switched ON while the engine is not running. Doing so could result in the battery going dead. If the ignition is left in ACC (For automatic transaxle, the shift lever is in the P position, and the ignition is in ACC), the ignition switches off automatically after about 25 minutes.

#### Off

The power supply to electrical devices turns off and the push button start indicator light (amber) also turn off.

#### ⚠ WARNING

**Before leaving the driver's seat, always switch the ignition off, set the parking brake, and make sure the shift lever is in P (automatic transaxle) or in 1st gear or R (manual transaxle):**

Leaving the driver's seat without switching the ignition off, setting the parking brake, and shifting the shift lever to P (automatic transaxle) or to 1st gear or R (manual transaxle) is dangerous. Unexpected vehicle movement could occur which could result in an accident.

In addition, if your intention is to leave the vehicle for even a short period, it is important to switch the ignition off, as leaving it in another position will disable some of the vehicle's security systems and run the battery down.

#### ACC (Accessory)

Some electrical accessories will operate and the indicator light (amber) illuminates.

#### NOTE

The keyless entry system does not function while the push button start has been pressed to ACC, and the doors will not lock/unlock even if they have been locked manually.

When Driving  
**Start/Stop Engine**

**ON**

This is the normal running position after the engine is started. The indicator light (amber) turns off. (The indicator light (amber) illuminates when the ignition is switched ON and the engine is not running.)

Some indicator lights/warning lights should be inspected before the engine is started (page 4-15).

**NOTE**

*When the push button start is pressed to ON, the sound of the fuel pump motor operating near the fuel tank can be heard. This does not indicate an abnormality.*

**Starting the Engine**

**⚠ WARNING**

**Radio waves from the key may affect medical devices such as pacemakers:**

*Before using the key near people who use medical devices, ask the medical device manufacturer or your physician if radio waves from the key will affect the device.*

**NOTE**

- *The key must be carried because the key carries an immobilizer chip that must communicate with the engine controls at short range.*
- *The engine can be started when the push button start is pressed from off, ACC, or ON.*
- *The advanced keyless entry system functions can be deactivated to prevent any possible adverse effect on a user wearing a pacemaker or other medical device. If the system is deactivated, you will be unable to start the engine by carrying the key. Consult an Authorized Mazda Dealer for details. If the advanced keyless entry system has been deactivated, you can start the engine by following the procedure indicated when the key battery goes dead. Refer to Engine Start Function When Key Battery is Dead on page 4-6.*
- *After starting a cold engine, the engine speed increases and a whining sound from the engine compartment can be heard. This is for improved exhaust gas purification and does not indicate defect of the parts.*

1. Make sure you are carrying the key.
2. Occupants should fasten their seat belts.

When Driving

## Start/Stop Engine

3. Make sure the parking brake is on.
4. Continue to press the brake pedal firmly until the engine has completely started.
5. **(Manual transaxle)**  
Continue to press the clutch pedal firmly until the engine has completely started.  
**(Automatic transaxle)**  
Put the vehicle in park (P). If you must restart the engine while the vehicle is moving, shift into neutral (N).

### NOTE

#### **(Manual transaxle)**

*The starter will not operate if the clutch pedal is not depressed sufficiently.*

#### **(Automatic transaxle)**

*The starter will not operate if the shift lever is not in P or N and the brake pedal is not depressed sufficiently.*

6. Verify that the KEY indicator light (green) in the instrument cluster and the push button start indicator light (green) illuminate. Refer to Warning/Indicator Lights on page 4-15. If the push button start indicator light (green) flashes, make sure that the key is being carried. If the push button start indicator light (green) flashes with the key being carried, hold the key over the push button start and start the engine. Refer to Engine Start Function When Key Battery is Dead on page 4-6.



### **CAUTION**

*If the KEY warning light (red) illuminates, or the push button start indicator light (amber) flashes, this could indicate a problem with the engine starting system and the inability to start the engine or switch the ignition to ACC or ON. Have your vehicle inspected at an Authorized Mazda Dealer as soon as possible.*

When Driving  
**Start/Stop Engine**

**NOTE**

- Under the following conditions, the KEY warning light (red) flashes after the push button start is pressed to inform the driver that the push button start will not switch to ACC even if it is pressed from off.
    - The key battery is dead.
    - The key is out of operational range.
    - The key is placed in areas where it is difficult for the system to detect the signal (page 3-6).
    - A key from another manufacturer similar to the key is in the operational range.
  - **(Forced engine starting method)**  
If the KEY warning light (red) illuminates, or the push button start indicator light (amber) flashes, this could indicate a problem with the engine starting system. Have your vehicle inspected at an Authorized Mazda Dealer as soon as possible. If this occurs, the engine can be force-started. Press and hold the push button start until the engine starts. Other procedures necessary for starting the engine such as having the key in the cabin, and depressing the brake pedal (Automatic transaxle) or the clutch pedal (Manual transaxle) are required.
  - When the engine is force-started, the KEY warning light (red) remains illuminated and the push button start indicator light (amber) remains flashing.
  - **(Automatic transaxle)**  
When the shift lever is in the neutral (N) position, the KEY indicator light (green) and the push button start indicator light (green) do not illuminate.
7. Press the push button start after both the KEY indicator light (green) in the instrument cluster and the push button start indicator light (green) illuminate.

**NOTE**

- After starting the engine, the push button start indicator light (amber) turn off and the ignition is in the ON position.
  - After pressing the push button start and before the engine starts, the operation sound of the fuel pump motor from near the fuel tank can be heard, however, this does not indicate a malfunction.
8. After starting the engine, let it idle for about ten seconds.

**NOTE**

- Whether the engine is cold or warm, it should be started without the use of the accelerator.
- If the engine does not start the first time, refer to Starting a Flooded Engine under Emergency Starting. If the engine still does not start, have your vehicle inspected by an Authorized Mazda Dealer (page 7-17).

When Driving

## Start/Stop Engine

### ▼ Engine Start Function When Key Battery is Dead

#### **CAUTION**

*When starting the engine by holding the transmitter over the push button start due to a dead key battery or a malfunctioning key, be careful not to allow the following.*

*Otherwise the signal from the key will not be received correctly and the engine may not start.*

- Metal parts of other keys or metal objects touch the key.



- Spare keys or keys for other vehicles equipped with an immobilizer system touch or come near the key.



- Devices for electronic purchases, or security passage which touch or come near the key.

If the engine cannot be started due to a dead key battery, the engine can be started using the following procedure:

1. Depress the brake pedal (automatic transaxle vehicle) or fully depress the clutch pedal (manual transaxle vehicle).
2. Verify that the push button start indicator light (green) flashes.

#### **NOTE**

*The push button start indicator light (green) will flash even if the push button start is pressed before depressing the brake pedal or clutch pedal. If the clutch pedal is depressed on a manual transaxle vehicle or the brake pedal is depressed on an automatic transaxle vehicle under this condition, the engine can be started by resuming the procedure following this.*

3. Touch the push button start using the backside of the key while the push button start indicator light (green) flashes.

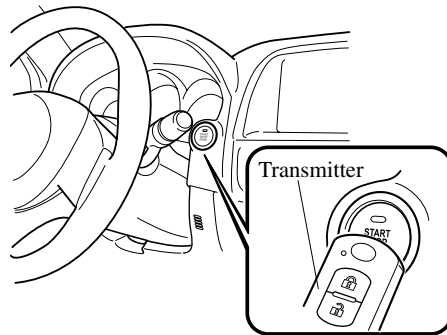

4. After the push button start indicator light (green) changes to full illumination, press the push button start.



When Driving  
**Start/Stop Engine**

**NOTE**

- *The engine cannot be started unless the clutch pedal is fully depressed on a manual transaxle vehicle or the brake pedal is fully depressed on an automatic transaxle vehicle.*
- *If there is a malfunction with the push button start function, the push button start indicator light (amber) flashes. In this case, the engine may start, however, have the vehicle checked at an Authorized Mazda Dealer as soon as possible.*
- *When touching the push button start using the backside of the key, touch the lock button side of the transmitter to the push button start.*
- *If the push button start indicator light (green) does not illuminate, perform the operation from the beginning again. If it does not illuminate, have the vehicle checked at an Authorized Mazda Dealer.*
- *If you just want to change the ignition position (with a dead key battery), after the push button start indicator light (green) changes to illumination, release the clutch pedal on a manual transaxle vehicle or the brake pedal on an automatic transaxle vehicle, and press the push button start. The ignition switches in the order of ACC, ON, and OFF each time it is pressed. Once the ignition switches off, the ignition position can no longer be switched. Therefore, if the engine starts, perform the operation from the beginning again.*

**Turning the Engine Off**

**⚠ WARNING**

**Do not stop the engine while the vehicle is moving:**

*Stopping the engine while the vehicle is moving for any reason other than in an emergency is dangerous. Stopping the engine while the vehicle is moving will result in reduced braking ability due to the loss of power braking, which could cause an accident and serious injury.*

1. Stop the vehicle completely.
2. **(Manual transaxle)**  
Shift into neutral.  
**(Automatic transaxle)**  
Shift the shift lever to the P position.
3. Press the push button start to turn off the engine. The ignition position is off.

**⚠ CAUTION**

*When leaving the vehicle, make sure the push button start is pressed to off.*

When Driving

## Start/Stop Engine

---

### **NOTE**

- *The electrical fan in the engine compartment could turn on for a few minutes after the ignition is switched from ON to OFF, whether or not the A/C is on or off, to cool the engine compartment quickly.*
- *When the push button start is pressed to off from ON, the KEY indicator light (green) flashes for approximately 30 seconds indicating that the remaining battery power of the key is low. Replace with a new battery before the key becomes unusable. Refer to Replace electrical battery (page 6-32).*
- **(Automatic transaxle)**  
*If the engine is turned off while the shift lever is in a position other than P, the ignition switches to ACC.*

### **▼ Emergency Engine Stop**

Continuously pressing the push button start while the engine is running and the vehicle is stopped, or quickly pressing it any number of times will turn the engine off immediately.

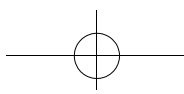

When Driving

## Instrument Cluster and Display

### Meters and Gauges

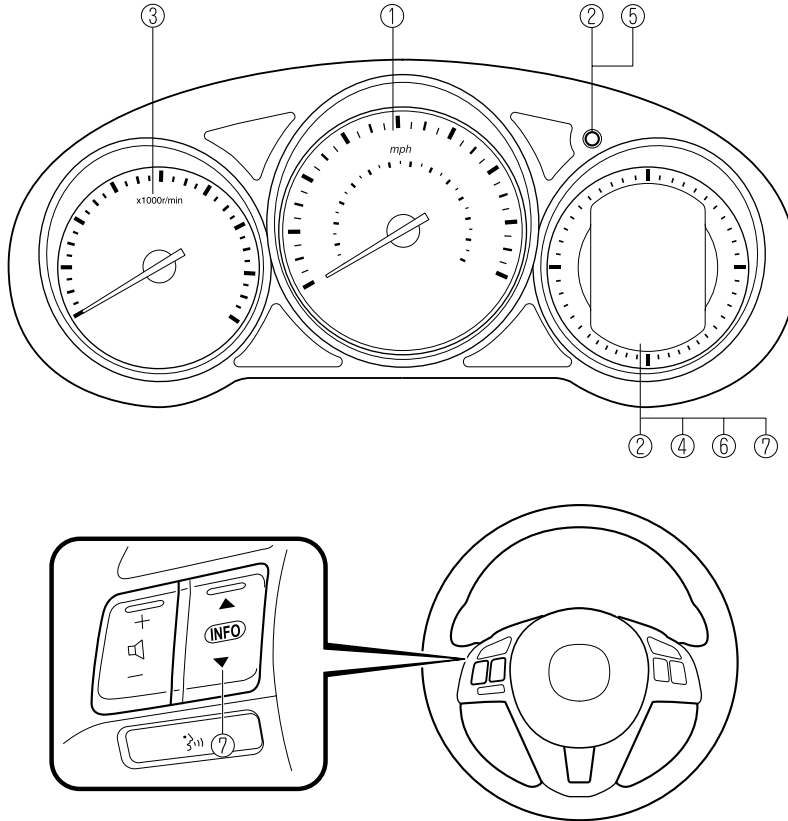

- ① Speedometer ..... page 4-10
- ② Odometer, Trip Meter and Trip Meter Selector ..... page 4-10
- ③ Tachometer ..... page 4-11
- ④ Fuel Gauge ..... page 4-11
- ⑤ Dashboard Illumination ..... page 4-11
- ⑥ Outside Temperature Display ..... page 4-12
- ⑦ Trip Computer and INFO Switch ..... page 4-13

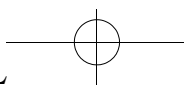

When Driving

## Instrument Cluster and Display

### ▼ Speedometer

The speedometer indicates the speed of the vehicle.

### ▼ Odometer, Trip Meter and Trip Meter Selector

The display mode can be changed between trip meter A and trip meter B by pressing the selector while one of them is displayed. The selected mode will be displayed.

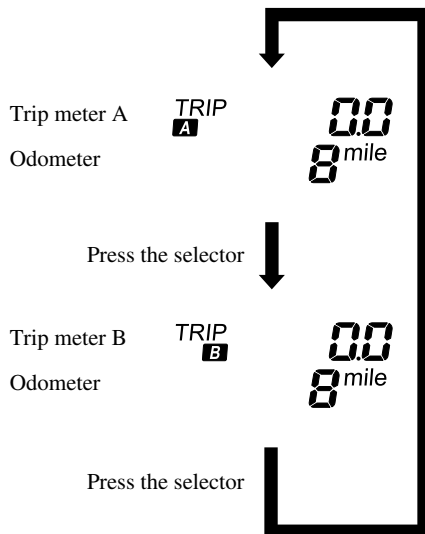

#### NOTE

When the ignition is switched to ACC or OFF, the odometer or trip meters cannot be displayed, however, pressing the selector button can inadvertently switch the trip meters or reset them during an approximate ten-minute period in the following cases:

- After the ignition is switched to OFF from ON.
- After the driver's door is opened.

### Odometer

The odometer records the total distance the vehicle has been driven.

### Trip meter

The trip meter can record the total distance of two trips. One is recorded in trip meter A, and the other is recorded in trip meter B.

For instance, trip meter A can record the distance from the point of origin, and trip meter B can record the distance from where the fuel tank is filled.

When trip meter A is selected, pressing the selector again within one second will change to trip meter B mode.

When trip meter A is selected, TRIP A will be displayed. When trip meter B is selected, TRIP B will be displayed.

The trip meter records the total distance the vehicle is driven until the meter is again reset. Return it to "0.0" by holding the selector depressed for 1 second or more. Use this meter to measure trip distances and to compute fuel consumption.

#### NOTE

- Only the trip meters record tenths of kilometers (miles).
- The trip record will be erased when:
  - The power supply is interrupted (blown fuse or the battery is disconnected).
  - The vehicle is driven over 9999.9 km (mile).

## When Driving Instrument Cluster and Display

### ▼ Tachometer

The tachometer shows engine speed in thousands of revolutions per minute (rpm).

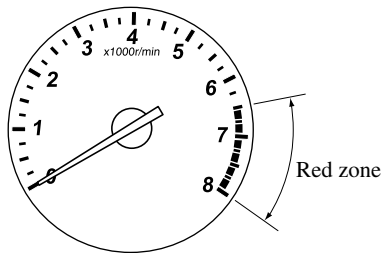

### ⚠ CAUTION

Do not run the engine with the tachometer needle in the RED ZONE. This may cause severe engine damage.

### ▼ Fuel Gauge

The fuel gauge shows approximately how much fuel is remaining in the tank when the ignition is switched ON. We recommend keeping the tank over 1/4 full.

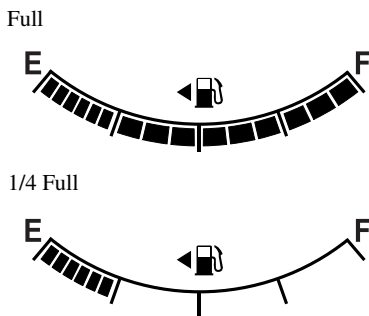

If the low fuel warning light illuminates or the fuel level is very low, refuel as soon as possible.

Refer to Warning/Indicator Lights on page 4-15.

### NOTE

- After refueling, it may require some time for the indicator to stabilize. In addition, the indicator may deviate while driving on a slope or curve since the fuel moves in the tank.
- The direction of the arrow (🛢) indicates that the fuel-filler lid is on the left side of the vehicle.

### ▼ Dashboard Illumination

Rotate the knob to adjust the brightness of the instrument cluster and other illuminations in the dashboard.

### NOTE

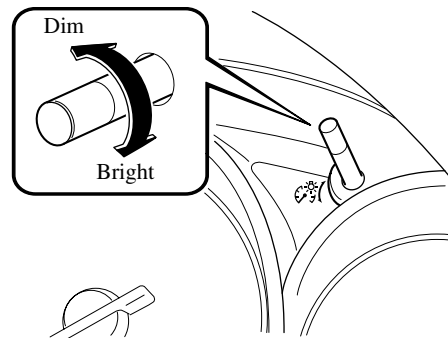

- The brightness of dashboard illuminations can be adjusted when the headlight switch is in the or position.
- When the dashboard illumination brightness cannot be adjusted any more, a beep sound will be heard.



When Driving

## Instrument Cluster and Display



### Canceling the illumination dimmer

When the headlight switch is in the  or  position, the illumination of the instrument cluster dims.

When driving on snowy or foggy roads, or in other situations when the instrument cluster's visibility is reduced due to glare from surrounding brightness, cancel the illumination dimmer and increase the illumination intensity.

To cancel the illumination dimmer, rotate the knob clockwise fully. You will hear a beep sound and the illumination dimmer will be canceled.

### **NOTE**

- This symbol () indicates the knob to adjust the brightness of the dashboard illumination.
- If the dashboard illumination knob is kept at the illumination dimmer cancel position, the instrument cluster will not dim when the headlight switch is turned to the  or  position again. Rotate the dashboard illumination knob counterclockwise to activate the illumination dimmer.

### **▼ Outside Temperature Display**

When the ignition is switched ON, the outside temperature is displayed.



OUTSIDE  78°F

### **NOTE**

*Under the following conditions, the outside temperature display may differ from the actual outside temperature depending on the surroundings and vehicle conditions:*

- Significantly cold or hot temperatures.
- Sudden changes in outside temperature.
- The vehicle is parked.
- The vehicle is driven at low speeds.

The outside temperature unit can be switched between Celsius and Fahrenheit using the following procedure.

1. Press the INFO button with the ignition switched off and continue pressing the INFO button for 5 seconds or longer while switching the ignition ON. The outside temperature display flashes.
2. Press the up  or down  part of the INFO switch to change the outside temperature unit.
3. Press and hold the INFO button for 3 seconds or longer while the outside temperature display is flashing. The outside temperature display illuminates.

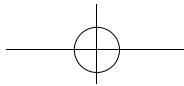

When Driving

## Instrument Cluster and Display

### ▼ Trip Computer and INFO Switch

The following information can be selected by pressing the up ▲ or down ▼ part of the INFO switch with the ignition switched ON.

- The approximate distance you can travel on the available fuel.
- The average fuel economy.
- The current fuel economy.
- The average vehicle speed.

If you have any problems with your trip computer, consult an Authorized Mazda Dealer.

#### Distance-to-empty mode

This mode displays the approximate distance you can travel on the remaining fuel based on the fuel economy.

The distance-to-empty will be calculated and displayed every second.

RANGE

100

miles

### NOTE

- Even though the distance-to-empty display may indicate a sufficient amount of remaining driving distance before refueling is required, refuel as soon as possible if the fuel level is very low or the low fuel warning light illuminates.
- The display will not change unless you add more than approximately 10 L (11 US gal, 8.8 Imp gal) of fuel.
- The distance-to-empty is the approximate remaining distance the vehicle can be driven until all the graduation marks in the fuel gauge indicating the remaining fuel supply disappear.

#### Average fuel economy mode

This mode displays the average fuel economy by calculating the total fuel consumption and the total traveled distance since purchasing the vehicle, re-connecting the battery after disconnection, or resetting the data. The average fuel economy is calculated and displayed every minute.

AVG

22.4<sup>mpg</sup>

To clear the data being displayed, press the INFO button for more than 1.5 seconds.

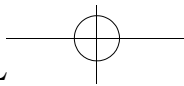

When Driving

## Instrument Cluster and Display

After pressing the INFO button, --- L/100 km (--- mpg) will be displayed for about 1 minute before the fuel economy is recalculated and displayed.

### Current fuel economy mode

This mode displays the current fuel economy by calculating the amount of fuel consumption and the distance traveled.

Current fuel economy will be calculated and displayed every 2 seconds.

CURRENT

22.4 mpg

When you've slowed to about 5 km/h (3 mph), --- L/100 km (--- mpg) will be displayed.

### Average vehicle speed mode

This mode displays the average vehicle speed by calculating the distance and the time traveled since connecting the battery or resetting the data.

Average vehicle speed will be calculated and displayed every 10 seconds.

AVG

25 mph

To clear the data being displayed, press the INFO button for more than 1.5 seconds. After pressing the INFO button, --- km/h (--- mph) will be displayed for about 1 minute before the vehicle speed is recalculated and displayed.



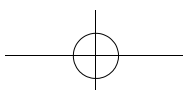







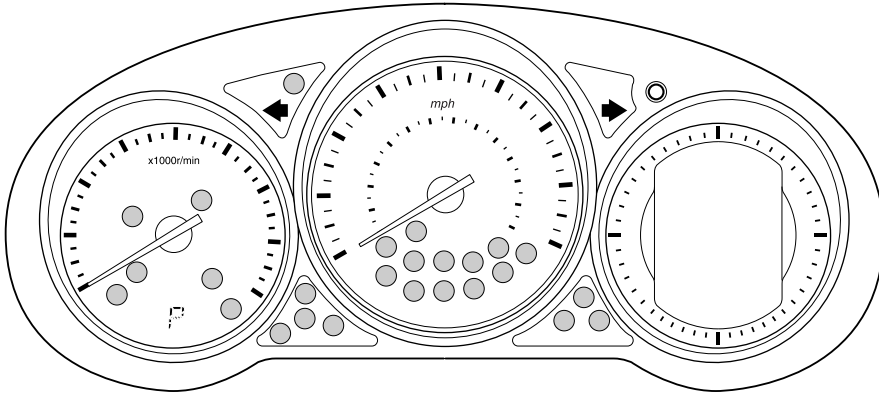

When Driving

## Instrument Cluster and Display

### Warning/Indicator Lights







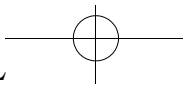





Warning/Indicator lights will appear in any of the highlighted areas

Signal	Warning/Indicator Lights	Page
 BRAKE	Brake System Warning Light	4-17
	Master Warning Light	4-18
	Antilock Brake System (ABS) Warning Light	4-18
	Charging System Warning Light	4-19
	Engine Oil Pressure Warning Light	4-19
	Check Engine Light	4-20
	High Engine Coolant Temperature Warning Light (Red)	4-20



When Driving





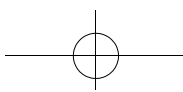

## Instrument Cluster and Display

Signal	Warning/Indicator Lights	Page
<b>4WD</b>	AWD Warning Light	4-21
<b>AT</b>	Automatic Transaxle Warning Light	4-21
	Power Steering Malfunction Indicator Light	4-22
	Air Bag/Front Seat Belt Pretensioner System Warning Light	4-22
	Low Fuel Warning Light	4-18
	Check Fuel Cap Warning Light	4-23
	Seat Belt Warning Light	4-23
	Door-Ajar Warning Light	4-24
	Low Washer Fluid Level Warning Light	4-25
	Tire Pressure Monitoring System Warning Light	4-25
	KEY Warning Light (Red)/Indicator Light (Green)	4-26
	Traction Control System (TCS)/Dynamic Stability Control (DSC) Indicator Light	4-27
<b>TCS OFF</b>	Traction Control System (TCS) OFF Indicator Light	4-28
<b>AFS OFF</b>	Adaptive Front Lighting System (AFS) OFF Indicator Light	4-28
	Low Engine Coolant Temperature Indicator Light (Blue)	4-28
<b>PRNDM</b>	Shift Position Indicator Light	4-28



When Driving

## Instrument Cluster and Display

Signal	Warning/Indicator Lights	Page
	Headlight High-Beam Indicator Light	4-29
	Turn Signal/Hazard Warning Indicator Lights	4-29
	Security Indicator Light	4-29
	Cruise Main Indicator Light (Amber)/Cruise Set Indicator Light (Green)	4-29
	Blind Spot Monitoring (BSM) System OFF Indicator Light	4-30
	Lights-On Indicator Light	4-30

### ▼ Warning (Display Indication)

Message information such as system operations or malfunctions is indicated in the display. Check the vehicle condition or have the vehicle inspected at an Authorized Mazda Dealer according to the indication.

### ▼ Brake System Warning Light



This warning has the following functions:

#### **Parking brake warning**

The light illuminates when the parking brake is applied with the ignition switched to START or ON. It turns off when the parking brake is fully released.

### **Low brake fluid level warning**

If the light stays on after the parking brake is fully released there may be a problem with the brakes.

Drive to the side of the road and park off the right-of-way.

You may notice that the pedal is harder to depress or that it may go closer to the floor. In either case, it will take longer to stop the vehicle.

1. With the engine stopped, open the hood and check the brake fluid level immediately, and then add fluid if required (page 6-24).
2. After adding fluid, check the light again.

If the warning light remains on, or if the brakes do not operate properly, do not drive the vehicle. Have it towed to an Authorized Mazda Dealer.

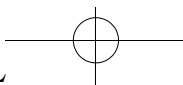

When Driving

## Instrument Cluster and Display

Even if the light turns off, have your brake system inspected as soon as possible by an Authorized Mazda Dealer.

### NOTE

*Having to add brake fluid is sometimes an indicator of leakage. Consult an Authorized Mazda Dealer as soon as possible even if the brake light is no longer illuminated.*

### WARNING

**Do not drive with the brake system warning light illuminated. Contact an Authorized Mazda Dealer to have the brakes inspected as soon as possible:**

*Driving with the brake system warning light illuminated is dangerous. It indicates that your brakes may not work at all or that they could completely fail at any time. If this light remains illuminated, after checking that the parking brake is fully released, have the brakes inspected immediately.*

### ▼ Master Warning Light



This warning light stays on for a few seconds when the ignition is switched ON.

The light illuminates continuously if any one of the following occurs. Consult an Authorized Mazda Dealer.

- There is a malfunction in the battery management system.

- There is a malfunction in the brake switch.

### ▼ ABS Warning Light



The warning light stays on for a few seconds when the ignition is switched ON.

If the ABS warning light stays on while you're driving, the ABS control unit has detected a system malfunction. If this occurs, your brakes will function normally as if the vehicle had no ABS. Should this happen, consult an Authorized Mazda Dealer as soon as possible.

### NOTE

*When the engine is jump-started to charge the battery, uneven rpm occurs and the ABS warning light may illuminate. If this occurs, it is the result of the weak battery and does not indicate an ABS malfunction. Recharge the battery.*

When Driving

## Instrument Cluster and Display

### ▼ Electronic Brake Force Distribution System Warning

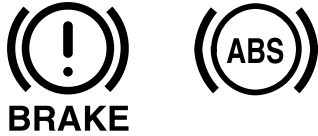

If the electronic brake force distribution control unit determines that some components are operating incorrectly, the control unit may illuminate the brake system warning light and the ABS warning light on simultaneously. The problem is likely to be the electronic brake force distribution system.

#### **⚠ WARNING**

***Do not drive with both the ABS warning light and brake warning light illuminated. Have the vehicle towed to an Authorized Mazda Dealer to have the brakes inspected as soon as possible:***

*Driving when the brake system warning light and ABS warning light are illuminated simultaneously is dangerous.*

*When both lights are illuminated, the rear wheels could lock more quickly in an emergency stop than under normal circumstances.*

### ▼ Charging System Warning Light



This warning light illuminates when the ignition is switched ON and turns off when the engine is started.

If the warning light illuminates while driving, it indicates a malfunction of the alternator or of the charging system. Drive to the side of the road and park off the right-of-way. Consult an Authorized Mazda Dealer.

#### **⚠ CAUTION**

***Do not continue driving when the charging system warning light is illuminated because the engine could stop unexpectedly.***

### ▼ Engine Oil Pressure Warning Light



This warning light illuminates when the ignition is switched ON and turns off when the engine is started.

This warning light indicates low engine oil pressure.

When Driving

## Instrument Cluster and Display

If the light illuminates while driving:

1. Drive to the side of the road and park off the right-of-way on level ground.
2. Turn off the engine and wait 5 minutes for the oil to drain back into the oil pan.
3. Inspect the engine oil level (page 6-21). If it's low, add the appropriate amount of engine oil while being careful not to overfill.
4. Start the engine and check the warning light.

If the light remains illuminated even after you add oil, stop the engine immediately and have your vehicle towed to an Authorized Mazda Dealer.

### CAUTION

*Do not run the engine if the oil pressure is low. It could result in extensive engine damage.*

### ▼ Check Engine Light



This indicator light illuminates when the ignition is switched ON and turns off when the engine is started.

If this light illuminates while driving, the vehicle may have a problem. It is important to note the driving conditions when the light illuminated and consult an Authorized Mazda Dealer.

The check engine light may illuminate in the following cases:

- The fuel tank level being very low or approaching empty.
- The engine's electrical system has a problem.
- The emission control system has a problem.
- **(U.S.A. and Canada)**  
The fuel-filler cap is missing or not tightened securely.

If the check engine light remains on or flashes continuously, do not drive at high speeds and consult an Authorized Mazda Dealer as soon as possible.

### ▼ High Engine Coolant Temperature Warning Light (Red)



When the ignition is switched ON, the light illuminates momentarily and then turns off.

The light flashes when the engine coolant temperature is extremely high, and illuminates when the engine coolant temperature increases further.

### Handling Procedure

#### Flashing light

Drive slowly to reduce engine load until you can find a safe place to stop the vehicle and wait for the engine to cool down.

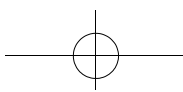

When Driving

## Instrument Cluster and Display

### Illuminated light

This indicates the possibility of overheating. Park the vehicle in a safe place immediately and stop the engine. Refer to Overheating (page 7-18).

#### CAUTION

*Do not drive the vehicle with the high engine coolant temperature warning light illuminated. Otherwise, it could result in damage to the engine.*

### ▼ AWD Warning Light

# 4WD

This warning light stays on for a few seconds when the ignition is switched ON.

The warning light will illuminate or flash under the following conditions:

- Illuminates when there is an abnormality with the AWD system.
- Illuminates if there is too much difference in tire radius between the front and rear wheels.
- Flashes when the differential oil temperature is abnormally high.
- Flashes when there are continually large differences between front and rear wheel rotation, such as when trying to pull away from an icy surface, or when trying to extricate the vehicle from mud, sand or similar conditions.

### When illuminated

If the AWD warning light illuminates, contact an Authorized Mazda Dealer.

### When flashing

Park the vehicle in a safe place. After a few moments, if the warning light stops flashing, you can resume driving. If the light does not stop flashing, contact an Authorized Mazda Dealer.

### ▼ Automatic Transaxle Warning Light

# AT

This warning light stays on for a few seconds when the ignition is switched ON.

The light illuminates when the transaxle has a problem.

#### CAUTION

*If the automatic transaxle warning light illuminates, the transaxle has an electrical problem. Continuing to drive your Mazda in this condition could cause damage to your transaxle. Consult an Authorized Mazda Dealer as soon as possible.*

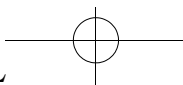

When Driving

## Instrument Cluster and Display

### ▼ Power Steering Malfunction Indicator Light



This indicator light illuminates when the ignition is switched ON, and turns off when the engine is started.

The power steering malfunction indicator light illuminates if there is a malfunction with the power steering while the engine is running.

If the indicator light illuminates, park the vehicle in a safe place immediately and stop the engine.

If the indicator light does not turn off even if the engine is restarted afterwards, consult an Authorized Mazda Dealer.

#### **NOTE**

- *If the indicator light illuminates, the power steering will not operate normally. If this happens, the steering wheel can still be operated, however, the operation may feel heavy compared to normal, and the steering wheel could vibrate when turning.*
- *Repeatedly jerking the steering wheel left and right while the vehicle is stopped or moving extremely slowly will cause the power steering system to go into protective mode which will make the steering feel heavy, but this does not indicate a problem. If this occurs, park the vehicle safely and wait a few seconds for the system to return to normal.*

### ▼ Air Bag/Front Seat Belt Pretensioner System Warning Light



If the air bag/front seat belt pretensioner system is working properly, the warning light illuminates when the ignition is switched ON or after the engine is cranked. The warning light turns off after a specified period of time.

A system malfunction is indicated if the warning light constantly flashes, constantly illuminates or does not illuminate at all when the ignition is switched ON. If any of these occur, consult an Authorized Mazda Dealer as soon as possible. The system may not operate in an accident.

#### **⚠ WARNING**

***Never tamper with the air bag/pretensioner systems and always have an Authorized Mazda Dealer perform all servicing and repairs:***

*Self-servicing or tampering with the systems is dangerous. An air bag/pretensioner could accidentally activate or become disabled causing serious injury or death.*



When Driving  
**Instrument Cluster and Display**

**▼ Low Fuel Warning Light**



This warning light signals that the fuel tank will soon be empty. Refuel as soon as possible.

**▼ Check Fuel Cap Warning Light \***



This warning light illuminates for a few seconds when the ignition is switched ON.

If the check fuel cap warning light illuminates while driving, the fuel-filler cap may not be installed properly. Stop the engine and reinstall the fuel-filler cap. Refer to Fuel-Filler Cap on page 3-22.

**▼ Seat Belt Warning Light**

**Driver's seat**



**Front passenger's seat \***

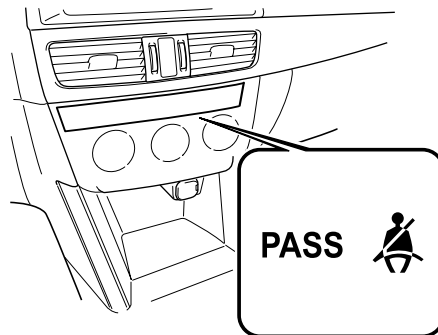

**With warning light for front passenger's seat**

The seat belt warning light illuminates if the driver or front passenger's seat is occupied and the seat belt is not fastened with the ignition switched ON.

**Without warning light for front passenger's seat**

The seat belt warning light illuminates if the driver's seat is occupied and the seat belt is not fastened with the ignition switched ON.

When Driving

## Instrument Cluster and Display

### Seat belt reminder

#### **NOTE**

Consult an Authorized Mazda Dealer to deactivate or restore the belt reminder. Though the belt reminder can be deactivated, doing so will defeat the purpose of the system to warn the driver and the front passenger in the event that their seat belts are not fastened. For the safety of the driver and front passenger, Mazda recommends not deactivating the belt reminder.

### **Front seat**

If the vehicle is driven with the driver or front passenger's seat belt unfastened, the seat belt warning light illuminates and a warning beep sounds.

#### **NOTE**

Some models do not have the seat belt reminder function for the front passenger's seat.

If the driver or front passenger's seat belt is unfastened (only when the front passenger seat is occupied) and the vehicle is driven at a speed faster than about 20 km/h (12 mph), the warning light will flash and a beep sound will be heard. After a short time, the warning light stops flashing, but remains illuminated, and the beep sound stops.

Until a seat belt is fastened or a given period of time has elapsed, the beep sound will not stop even if the vehicle speed falls below 20 km/h (12 mph).

#### **NOTE**

- The warning light flashes and a beep sound will be heard for about 6 seconds if the driver's seat belt is not fastened when the ignition is switched ON.
- If a driver or front passenger's seat belt is unfastened after the beep sound turns off (warning light remains illuminated), and the vehicle speed exceeds 20 km/h (12 mph), the warning light flashes and beep sound activates again.
- Placing heavy items on the front passenger seat may cause the front passenger seat belt warning function to operate depending on the weight of the item.
- To allow the front passenger seat weight sensor to function properly, do not place and sit on an additional seat cushion on the front passenger seat. The sensor may not function properly because the additional seat cushion could cause sensor interference.
- When a small child sits on the front passenger seat, it is possible that the warning light will not operate.

### **▼ Door-Ajar Warning Light**



This warning light illuminates when any door or the liftgate is not securely closed. Close the door or the liftgate securely before driving the vehicle.

When Driving

## Instrument Cluster and Display

### ▼ Low Washer Fluid Level Warning Light\*



This warning light indicates that little washer fluid remains. Add fluid (page 6-25).

### ▼ Tire Pressure Monitoring System Warning Light



This warning light illuminates for a few seconds when the ignition is switched ON.

The warning light illuminates and a beep is heard when tire pressure is too low in one or more tires, and flashes when there is a system malfunction.

### **⚠ WARNING**

*If the tire pressure monitoring system warning light illuminates or flashes, or the tire pressure warning beep sound is heard, decrease vehicle speed immediately and avoid sudden maneuvering and braking:*

*If the tire pressure monitoring system warning light illuminates or flashes, or the tire pressure warning beep sound is heard, it is dangerous to drive the vehicle at high speeds, or perform sudden maneuvering or braking. Vehicle drivability could worsen and result in an accident. To determine if you have a slow leak or a flat, pull over to a safe position where you can check the visual condition of the tire and determine if you have enough air to proceed to a place where air may be added and the system monitored again by an Authorized Mazda Dealer or a tire repair station.*

**Do not ignore the TPMS Warning Light:** *Ignoring the TPMS warning light is dangerous, even if you know why it is illuminated. Have the problem taken care of as soon as possible before it develops into a more serious situation that could lead to tire failure and a dangerous accident.*

### **Warning light illuminates/Warning beep sounds**

When the warning light illuminates, and the warning beep sound is heard (about 3 seconds), tire pressure is too low in one or more tires.

\*Some models. **4-25**

When Driving

## Instrument Cluster and Display

Adjust the tire pressure to the correct tire pressure. Refer to the specification charts (page 9-7).

### NOTE

- *Perform tire pressure adjustment when the tires are cold. Tire pressure will vary according to the tire temperature, therefore let the vehicle stand for 1 hour or only drive it 1.6 km (1 mile) or less before adjusting the tire pressures. When pressure is adjusted on hot tires to the cold inflation pressure, the TPMS warning light/beep may turn on after the tires cool and pressure drops below specification. Also, an illuminated TPMS warning light, resulting from the tire air pressure dropping due to cold ambient temperature will remain illuminated even if the ambient temperature rises. In this case, it will also be necessary to adjust the tire air pressures. If the TPMS warning light illuminates due to a drop in tire air pressure, make sure to check and adjust the tire air pressures.*
- *Tires lose air naturally over time and the TPMS cannot tell if the tires are getting too soft over time or you have a flat. However, when you find one low tire in a set of four—that is an indication of trouble; you should have someone drive the vehicle slowly forward so you can inspect any low tire for cuts and any metal objects sticking through tread or sidewall. Put a few drops of water in the valve stem to see if it bubbles indicating a bad valve. Leaks need to be addressed by more than simply refilling the trouble tire as leaks are dangerous - take it to an Authorized Mazda Dealer.*

If the warning light illuminates again even after the tire pressures are adjusted, there may be a tire puncture. Replace the punctured tire with the temporary spare tire (page 7-7).

### Warning light flashes

If the tire pressure monitoring system has a malfunction, the tire pressure warning light flashes for about 1 minute when the ignition is switched ON and then continues illuminating. Have your vehicle checked by an Authorized Mazda Dealer as soon as possible.

### ▼ **KEY Warning Light (Red)/KEY Indicator Light (Green)**



This indicator has two colors.

### KEY Warning Light (Red)

#### When illuminated

If any malfunction occurs in the keyless entry system, it illuminates continuously.

### **CAUTION**

*If the key warning indicator light illuminates or the push button start indicator light (amber) flashes, the engine may not start. If the engine cannot be started, try starting it using the emergency operation for starting the engine, and have the vehicle inspected at an Authorized Mazda Dealer as soon as possible.*

When Driving

## Instrument Cluster and Display

### When flashing

- Under the following conditions, the KEY warning light (red) flashes to notify the driver that the ignition cannot be switched from off.
  - The key battery is dead.
  - The key is not within operational range.
  - The key is placed in areas where it is difficult for the system to detect the signal (page 3-6).
  - A key from another manufacturer similar to the key is in the operational range.
- Under the following conditions, the KEY warning light (red) will flash continuously when the ignition has not been switched off to notify the driver that the key has been removed from the vehicle. The KEY warning light (red) will stop flashing when the key is back inside the vehicle:  
The ignition has not been switched off and all the doors and the liftgate are closed after removing the key from the vehicle.

### NOTE

*Because the key utilizes low-intensity radio waves, the Key Removed From Vehicle Warning may activate if the key is carried together with a metal object or it is placed in a poor signal reception area.*

### **KEY Indicator Light (Green)**

#### When illuminated

When the brake pedal is depressed with an automatic transaxle or the clutch pedal is depressed with a manual transaxle, the system confirms that the correct key is inside the vehicle, the KEY indicator light (green) illuminates, and the engine can be started (page 4-3).

### When flashing

When the ignition is switched from ON to off, the KEY indicator light (green) flashes for approximately 30 seconds indicating that the remaining battery power is low. Replace with a new battery before the key becomes unusable. Refer to Replace Electrical Battery on page 6-32.

### ▼ TCS/DSC Indicator Light



This indicator light stays on for a few seconds when the ignition is switched ON. If the TCS or DSC is operating, the indicator light flashes.

If the light stays on, the TCS, DSC or the brake assist system may have a malfunction and they may not operate correctly. Take your vehicle to an Authorized Mazda Dealer.

### NOTE

- *In addition to the indicator light flashing, a slight lugging sound will come from the engine. This indicates that the TCS/DSC is operating properly.*
- *On slippery surfaces, such as fresh snow, it will be impossible to achieve high rpm when the TCS is on.*

When Driving

## Instrument Cluster and Display

### ▼ TCS OFF Indicator Light

**TCS  
OFF**

This indicator light stays on for a few seconds when the ignition is switched ON.

It also illuminates when the TCS OFF switch is pressed and TCS is switched off. Refer to TCS OFF Switch on page 4-62.

If the light remains illuminated and the TCS is not switched off, take your vehicle to an Authorized Mazda Dealer. The DSC may have a malfunction.

### ▼ AFS OFF Indicator Light\*

**AFS  
OFF**

#### When illuminated

This indicator light illuminates briefly when the ignition is switched ON, and then turns off.

Pressing the AFS OFF switch cancels the AFS function and illuminates the indicator light.

#### When flashing

The indicator light flashes continuously if the system is malfunctioning. Consult an Authorized Mazda Dealer.

#### **NOTE**

- Even if the AFS is not operating due to some malfunction, the normal headlight function is still operable.
- If there is a malfunction with the headlight auto-leveling function, the indicator light flashes.

### ▼ Low Engine Coolant Temperature Indicator Light (Blue)



The light illuminates continuously when the engine coolant temperature is low and turns off after the engine is warm.

If the low engine coolant temperature indicator light remains illuminated after the engine has been sufficiently warmed up, the temperature sensor could have a malfunction. Consult an Authorized Mazda Dealer.

### ▼ Shift Position Indicator Light



This indicates the selected shift position.

#### Gear position indicator

In manual shift mode, the "M" of the shift position indicator illuminates and the numeral for the selected gear displays.

When Driving

## Instrument Cluster and Display

### ▼ Headlight High-Beam Indicator Light



This light indicates one of two things:

- The high-beam headlights are on.
- The turn signal lever is in the flash-to-pass position.

### ▼ Turn Signal/Hazard Warning Indicator Lights



When operating the turn signal lights, the left or right turn signal indicator light flashes to indicate which turn signal light is operating (page 4-45).

When operating the hazard warning lights, both turn signal indicator lights flash (page 4-52).

If an indicator light remains illuminated (does not flash) or if it flashes abnormally, one of the turn signal bulbs may be burned out. Consult an Authorized Mazda Dealer.

### ▼ Security Indicator Light



This indicator light starts flashing every 2 seconds when the ignition is switched from ON to OFF and the immobilizer system is armed.

The light stops flashing when the ignition is switched ON with the correct key. At this time, the immobilizer system is disarmed and the light illuminates for about 3 seconds and then turns off.

If the engine does not start with the correct key, and the security indicator light keeps illuminating or flashing, the system may have a malfunction. Consult an Authorized Mazda Dealer.

### ▼ Cruise Main Indicator Light (Amber)/Cruise Set Indicator Light (Green)



The indicator light has two colors.

#### **Cruise Main Indicator Light (Amber)**

The indicator light illuminates amber when the ON switch is pressed and the cruise control system is activated.

When Driving

## Instrument Cluster and Display

---

### **Cruise Set Indicator Light (Green)**

The indicator light illuminates green when a cruising speed has been set.

### **▼ BSM OFF Indicator Light \***

**BSM  
OFF**

This indicator light illuminates for a few seconds when the ignition is switched ON.

The BSM OFF indicator light illuminates when the BSM system is turned off by pressing the BSM OFF switch.

The indicator light flashes if the BSM system has a malfunction. Consult an Authorized Mazda Dealer.

#### **NOTE**

*If the vehicle is driven on a road with less traffic and few vehicles that the radar sensors can detect, the system may pause (The BSM OFF indicator light in the instrument panel flashes). However, it does not indicate a malfunction.*

### **▼ Lights-On Indicator Light**



This indicator light illuminates when the exterior lights and dashboard illumination are on.

The light continues to flash if the lighting system has a malfunction. Consult an Authorized Mazda Dealer.

**4-30** \*Some models.



When Driving  
**Transaxle**

**Manual Transaxle Operation**

▼ **Manual Transaxle Shift Pattern**

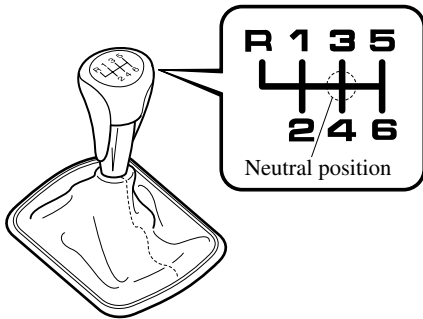

The shift pattern of the transaxle is conventional, as shown.

Depress the clutch pedal all the way down while shifting; then release it slowly.

Your vehicle is equipped with a device to prevent shifting to R (reverse) by mistake. Push the shift lever downward and shift to R.

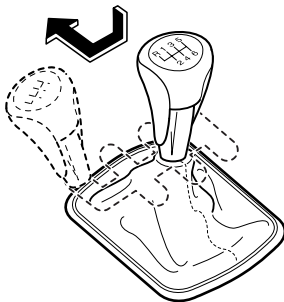

**⚠ WARNING**

**Do not use sudden engine braking on slippery road surfaces or at high speeds:**

*Shifting down while driving on wet, snowy, or frozen roads, or while driving at high speeds causes sudden engine braking, which is dangerous. The sudden change in tire speed could cause the tires to skid. This could lead to loss of vehicle control and an accident.*

**Be sure to leave the shift lever in 1 or R position and set the parking brake when leaving the vehicle unattended:**  
*Otherwise the vehicle could move and cause an accident.*

**⚠ CAUTION**

- *Keep your foot off the clutch pedal except when shifting gears. Also, do not use the clutch to hold the vehicle on an upgrade. Riding the clutch will cause needless clutch wear and damage.*
- *Do not apply any excessive lateral force to the gear lever when changing from 5th to 4th gear. This could lead to the accidental selection of 2nd gear, which can result in damage to the transaxle.*
- *Make sure the vehicle comes to a complete stop before shifting to R. Shifting to R while the vehicle is still moving may damage the transaxle.*

**NOTE**

*If shifting to R is difficult, shift back into neutral, release the clutch pedal, and try again.*

When Driving

## Transaxle

### ▼ Recommendations for Shifting

#### Upshifting

For normal acceleration, we recommend these shift points.

(U.S.A. and Canada)

Gear	Vehicle speed
1 to 2	24 km/h (15 mph)
2 to 3	42 km/h (26 mph)
3 to 4	60 km/h (37 mph)
4 to 5	75 km/h (46 mph)
5 to 6	79 km/h (49 mph)

(Mexico)

Gear	Vehicle speed
1 to 2	15 km/h (9 mph)
2 to 3	35 km/h (22 mph)
3 to 4	50 km/h (31 mph)
4 to 5	70 km/h (43 mph)
5 to 6	100 km/h (62 mph)

For cruising (U.S.A. and Canada)

Gear	Vehicle speed
1 to 2	13 km/h (8 mph)
2 to 3	29 km/h (18 mph)
3 to 4	49 km/h (30 mph)
4 to 5	63 km/h (39 mph)
5 to 6	70 km/h (43 mph)

#### Downshifting



When you must slow down in heavy traffic or on a steep **upgrade**, downshift before the engine starts to overwork. This reduces the chance of stalling and gives better acceleration when you need more speed.

On a steep **downgrade**, downshifting helps maintain safe speed and prolongs brake life.

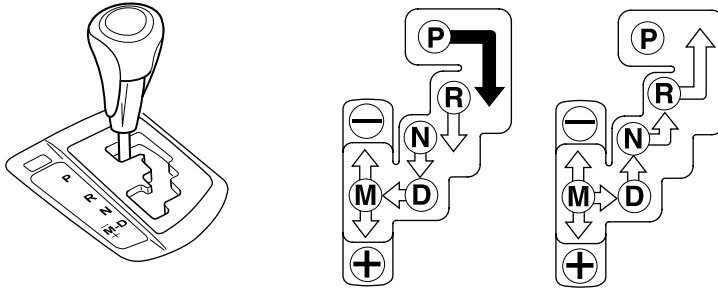
## Automatic Transaxle Controls



### Various Lockouts:

-  Indicates that you must depress the brake pedal to shift (The ignition must be switched to ON).
-  Indicates the shift lever can be shifted freely into any position.

### **NOTE**

*The Sport AT has an option that is not included in the traditional automatic transaxle giving the driver the option of selecting each gear instead of leaving it to the transaxle to shift gears. Even if you intend to use the automatic transaxle functions as a traditional automatic, you should also be aware that you can inadvertently shift into manual shift mode and an inappropriate gear may be retained as the vehicle speed increases. If you notice the engine speed going higher or hear the engine racing, confirm you have not accidentally slipped into manual shift mode (page 4-36).*

When Driving

## Transaxle

### ▼ Warning Light

A system malfunction or operation conditions are indicated by a warning. Refer to Warning/Indicator Lights on page 4-15.

### ▼ Transaxle Ranges

- The shift position indicator light in the instrument cluster illuminates. Refer to Warning/Indicator Lights on page 4-15.
- The shift lever must be in P or N to operate the starter.

### P (Park)

P locks the transaxle and prevents the front wheels from rotating.

#### **! WARNING**

**Always set the shift lever to P and set the parking brake:**

*Only setting the shift lever to the P position without using the parking brake to hold the vehicle is dangerous. If P fails to hold, the vehicle could move and cause an accident.*

#### **! CAUTION**

- *Shifting into P, N or R while the vehicle is moving can damage your transaxle.*
- *Shifting into a driving gear or reverse when the engine is running faster than idle can damage the transaxle.*

### R (Reverse)

In position R, the vehicle moves only backward. You must be at a complete stop before shifting to or from R, except under rare circumstances as explained in Rocking the Vehicle (page 3-39).

### N (Neutral)

In N, the wheels and transaxle are not locked. The vehicle will roll freely even on the slightest incline unless the parking brake or brakes are on.

#### **! WARNING**

***If the engine is running faster than idle, do not shift from N or P into a driving gear:***

*It's dangerous to shift from N or P into a driving gear when the engine is running faster than idle. If this is done, the vehicle could move suddenly, causing an accident or serious injury.*

***Do not shift into N when driving the vehicle:***

*Shifting into N while driving is dangerous. Engine braking cannot be applied when decelerating which could lead to an accident or serious injury.*

#### **! CAUTION**

***Do not shift into N when driving the vehicle. Doing so can cause transaxle damage.***

### **NOTE**

*Apply the parking brake or depress the brake pedal before moving the shift lever from N to prevent the vehicle from moving unexpectedly.*

When Driving  
**Transaxle**

**D (Drive)**

D is the normal driving position. From a stop, the transaxle will automatically shift through a 6-gear sequence.

**M (Manual)**

M is the manual shift mode position. Gears can be shifted up or down by operating the shift lever. Refer to Manual Shift Mode (page 4-36).

**▼ Active Adaptive Shift (AAS)**

Active Adaptive Shift (AAS) automatically controls the transaxle shift points to best suit the road conditions and driver input. This improves driving comfort.

The transaxle may switch to AAS mode when driving up and down slopes, cornering, or depressing the accelerator pedal quickly while the shift lever is in the D position.

Depending on the driving conditions and vehicle operations, it may not be possible to shift gears, however, this does not indicate a problem because the AAS mode will maintain the optimum gear position.

**▼ Shift-Lock System**

**The shift-lock system prevents shifting out of P unless the brake pedal is depressed.**

To shift from P:

1. Depress and hold the brake pedal.
2. Start the engine.
3. Move the shift lever.

**NOTE**

- When the ignition is switched off, the shift lever cannot be shifted from P.
- The ignition cannot be switched to OFF if the shift lever is not in P.

**▼ Shift-Lock Override**

If the shift lever will not move from P using the proper shift procedure, continue to hold down the pedal.

1. Remove the shift-lock override cover using a cloth-wrapped flat head screwdriver.
2. Insert a screwdriver and push it down.

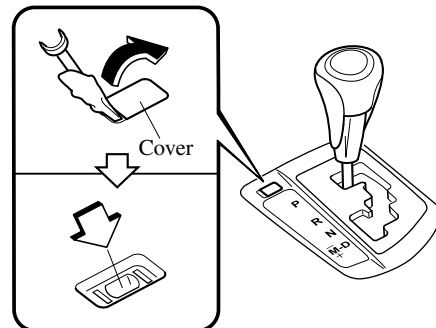

3. Move the shift lever.
4. Take the vehicle to an Authorized Mazda Dealer to have the system checked.

When Driving

## Transaxle

### ▼ Manual Shift Mode

This mode gives you the feel of driving a manual transaxle vehicle by operating the shift lever and allows you to control engine rpm and torque to the drive wheels much like a manual transaxle when more control is desired.

To change to manual shift mode, shift the lever from D to M.

#### **NOTE**

*Changing to manual shift mode while driving will not damage the transaxle.*

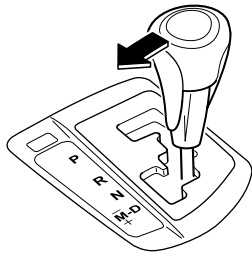

To return to automatic shift mode, shift the lever from M to D.

#### **NOTE**

- If you change to manual shift mode when the vehicle is stopped, the gear will shift to M1.
- If you change to manual shift mode without depressing the accelerator pedal when driving in D range, 5th gear/6th gear, the gear will shift to M4/M5.

### Indicators

#### **Manual shift mode indicator**

In manual shift mode, the “M” of the shift position indicator in the instrument panel illuminates.

#### **Gear position indicator**

The numeral for the selected gear illuminates.

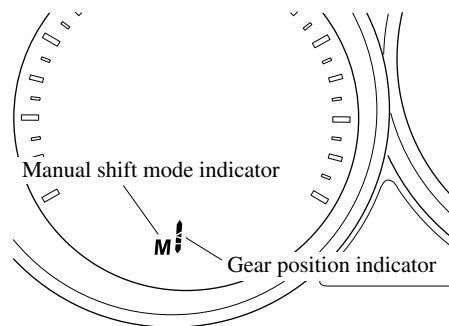

#### **NOTE**

- If the gears cannot be shifted down when driving at higher speeds, the gear position indicator will flash twice to signal that the gears cannot be shifted down (to protect the transaxle).
- If the automatic transaxle fluid (ATF) temperature becomes too high, there is the possibility that the transaxle will switch to automatic shift mode, canceling manual shift mode and turning off the gear position indicator illumination. This is a normal function to protect the AT. After the ATF temperature has decreased, the gear position indicator illumination turns back on and driving in manual shift mode is restored.

## When Driving Transaxle

### **Shifting**

#### **Manually Shifting up**

**(M1 → M2 → M3 → M4 → M5 → M6)**

To shift up to a higher gear, tap the shift lever back (+) once.

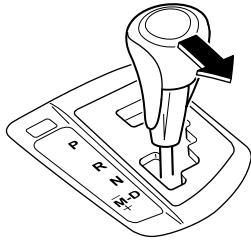

#### **NOTE**

- When driving slowly, the gears may not shift up.
- In manual shift mode, gears do not shift up automatically. Do not run the engine with the tachometer needle in the RED ZONE. If the tachometer needle enters the RED ZONE, you may feel engine-braking because the fuel delivery will be stopped to protect the engine. However, this does not indicate an abnormality.
- When depressing the accelerator fully, the transaxle will shift to a lower gear, depending on vehicle speed (Except M2 → M1).

#### **Manually Shifting down**

**(M6 → M5 → M4 → M3 → M2 → M1)**

To shift down to a lower gear, tap the shift lever forward (-) once.

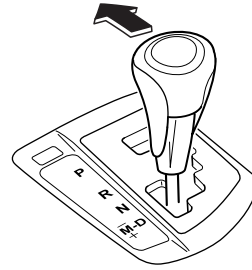

#### **⚠ WARNING**

**Do not use engine braking on slippery road surfaces or at high speeds:**

Shifting down while driving on wet, snowy, or frozen roads, or while driving at high speeds causes sudden engine braking, which is dangerous. The sudden change in tire speed could cause the tires to skid. This could lead to loss of vehicle control and an accident.

#### **NOTE**

- When driving at high speeds, the gear may not shift down.
- During deceleration, the gear may automatically shift down depending on vehicle speed.
- When depressing the accelerator fully, the transaxle will shift to a lower gear, depending on vehicle speed (Except M2 → M1).

When Driving

## Transaxle

### Second gear fixed mode

When the shift lever is tapped back (+) while the vehicle is stopped or driven at about 9.3 km/h (5.7 mph) or less, the transaxle is set in the second gear fixed mode. The gear is fixed in second while in this mode for easier starting and driving on slippery roads. If the shift lever is tapped back (+) or forward (-) while in the second gear fixed mode, the mode will be canceled.

### Shifting specification

#### Shifting up

If the vehicle speed is lower than the speed specified for each gear, the gear cannot be shifted up to a higher gear.

Gear	Vehicle speed
M1 → M2	9.3 km/h (5.8 mph)
M2 → M3	22.5 km/h (14.0 mph)
M3 → M4	31.2 km/h (19.4 mph)
M4 → M5	43.8 km/h (27.3 mph)
M5 → M6	53.5 km/h (33.3 mph)

#### Shifting down

If the vehicle speed is higher than the speed specified for each gear, the gear cannot be shifted to a lower gear so as to protect the transaxle.

Gear	Vehicle speed
M6 → M5	237.5 km/h (147.5 mph)
M5 → M4	167.3 km/h (103.9 mph)
M4 → M3	115.2 km/h (71.58 mph)
M3 → M2	81.3 km/h (50.5 mph)
M2 → M1	42.7 km/h (26.5 mph)

#### **NOTE**

*Regarding the vehicle speed at the highest gear indicated above, achieving this speed may not actually be possible depending on various driving conditions such as the wind, upslope, and road surface.*

During deceleration, the gears shift down automatically when speed is reduced to the following:

Gear	Vehicle speed
M6 → M5	47 km/h (29 mph)
M5 → M4	39.8 km/h (24.7 mph)
M4 → M3	28.2 km/h (17.5 mph)
M3 → M2	11.9 km/h (7.39 mph)
M2 → M1	6.3 km/h (3.9 mph)

#### **NOTE**

*The gear does not shift down to M1 automatically while in the second gear fixed mode.*

If the vehicle is kicked down at the following speeds or lower, the gears shift down automatically:

Gear	Vehicle speed
M6 → M5	216.1 km/h (134.2 mph)
M5 → M4	139.3 km/h (86.5 mph)
M4 → M3	57.6 km/h (35.7 mph)
M3 → M2	41.4 km/h (25.7 mph)

### Recommendations for shifting (U.S.A. and Canada)

#### Upshifting

For normal acceleration and cruising, we recommend these shift points.

Gear	Vehicle speed
M1 to M2	24 km/h (15 mph)
M2 to M3	40 km/h (25 mph)
M3 to M4	65 km/h (40 mph)
M4 to M5	73 km/h (45 mph)
M5 to M6	81 km/h (50 mph)

#### Downshifting

When you must slow down in heavy traffic or on a steep **upgrade**, downshift before the engine starts to overwork. This gives better acceleration when you need more speed.



When Driving  
**Transaxle**

On a steep **downgrade**, downshifting helps maintain safe speed and prolongs brake life.

▼ **Driving Tips**

**⚠ WARNING**

***Do not allow the vehicle to move in reverse on an up-slope while the selector lever is in a forward gear position, or move forward on a down-slope while the selector lever is in the reverse position.***

*Otherwise, the engine will stop, causing the loss of the power brake and power steering functions, and make it difficult to control the vehicle which could result in an accident.*

**Passing**

For extra power when passing another vehicle or climbing steep grades, depress the accelerator fully. The transaxle will shift to a lower gear, depending on vehicle speed.

**Climbing steep grades from a stop**

To climb a steep grade from a stopped position:

1. Depress the brake pedal.
2. Shift to D or M1, depending on the load weight and grade steepness.
3. Release the brake pedal while gradually accelerating.

**Descending steep grades**

When descending a steep grade, shift to lower gears, depending on load weight and grade steepness. Descend slowly, using the brakes only occasionally to prevent them from overheating.

When Driving

# Switches and Controls

## Lighting Control

### ▼ Headlights

- Turn the headlight switch to turn the headlights, other exterior lights and dashboard illumination on or off.
- A system malfunction or operation conditions are indicated by a warning. Refer to Warning/Indicator Lights on page 4-15.

**NOTE**

- *If the light switch is left on, the lights will automatically switch off (if equipped) approximately 30 seconds after switching the ignition off. The time setting can be changed. Refer to Personalization Features on page 9-8.*
- *To prevent discharging the battery, do not leave the lights on while the engine is off unless safety requires them.*

### Without auto-light control

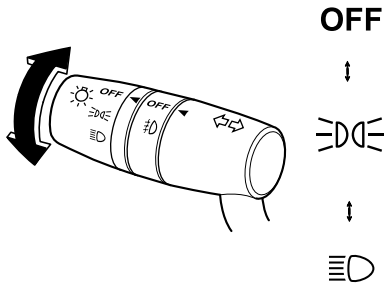

Switch Position	OFF		☞☞☞		☞☞☞	
Ignition Position	ON	OFF	ON	OFF	ON	OFF
Headlights	Off	Off	Off	Off	On	On
Daytime running lights	On	Off	On	Off	Off	Off
Taillights						
Parking lights						
License lights	Off	Off	On	On	On	On
Side-marker lights						
Dashboard illumination						

When Driving  
**Switches and Controls**

**With auto-light control**

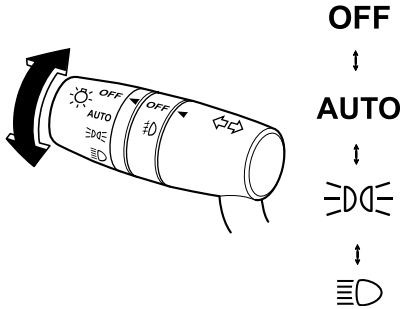

Switch Position	OFF		AUTO		☞☐☞		☞☐	
	ON	OFF	ON	OFF	ON	OFF	ON	OFF
Headlights	Off	Off	Auto*	Off	Off	Off	On	On
Daytime running lights	On	Off	Auto*	Off	On	Off	Off	Off
Taillights								
Parking lights					On	On	On	On
License lights	Off	Off	Auto*	Off	On	On	On	On
Side-marker lights								
Dashboard illumination								

\* The headlight and other light settings switch automatically depending on the surrounding brightness detected by the sensor.

When Driving

## Switches and Controls

### **Auto-light control**

When the headlight switch is in the AUTO position and the ignition is switched ON, the light sensor senses the surrounding lightness or darkness and automatically turns the headlights, other exterior lights and dashboard illumination on or off (see chart above).

### **CAUTION**

- Do not shade the light sensor by adhering a sticker or a label on the windshield. Otherwise the light sensor will not operate correctly.

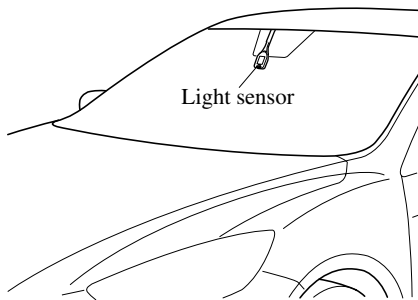

- The light sensor also works as a rain sensor for the auto-wiper control. Keep hands and scrapers clear of the windshield when the wiper lever is in the AUTO position and the ignition is switched ON as fingers could be pinched or the wipers and wiper blades damaged when the wipers activate automatically. If you are going to clean the windshield, be sure the wipers are turned off completely — this is particularly important when clearing ice and snow — when it is particularly tempting to leave the engine running.

### **NOTE**

- The headlights, other exterior lights and dashboard illumination may not turn off immediately even if the surrounding area becomes well-lit because the light sensor determines that it is nighttime if the surrounding area is continuously dark for several minutes such as inside long tunnels, traffic jams inside tunnels, or in indoor parking lots.  
In this case, the light turns off if the light switch is turned to the OFF position.
- **(Without auto headlight off function)**  
When the headlight switch is in the AUTO position and the ignition is switched to ACC or the ignition is switched off, the headlights, other exterior lights and dashboard illumination will turn off.
- The dashboard illumination can be adjusted by rotating the knob in the instrument cluster. Also, the day/night mode can be changed by rotating the knob until a beep sound is heard. To adjust the brightness of the dashboard illumination: Refer to Dashboard Illumination on page 4-11.
- The sensitivity of the AUTO lights may be changed by an Authorized Mazda Dealer. Refer to Personalization Features on page 9-8.

When Driving  
**Switches and Controls**

**Xenon fusion headlight bulbs \***

The low-beam bulbs of the headlights have xenon fusion bulbs that produce a bright white beam over a wide area.

**⚠ WARNING**

**Do not replace the xenon fusion bulbs yourself**

*Replacing the xenon fusion bulbs yourself is dangerous. Because the xenon fusion bulbs require high voltage, you could receive an electric shock if the bulbs are handled incorrectly. Consult an Authorized Mazda Dealer when the replacement is necessary.*

**NOTE**

*If the headlights flicker, or the brightness weakens, the bulb-life may be depleted and a replacement is necessary. Consult an Authorized Mazda Dealer.*

**▼ Headlight High-Low Beam**

Press the lever forward to turn on the high beams.

Pull the lever back to its original position for the low beams.

The headlight high-beam indicator light in the instrument cluster illuminates while the high beams are turned on.

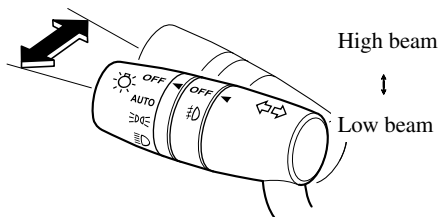

**▼ Flashing the Headlights**

To flash the headlights, pull the lever fully towards you (the headlight switch does not need to be on). The headlight high-beam indicator light in the instrument cluster illuminates simultaneously. The lever will return to the normal position when released.

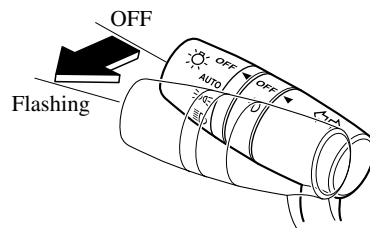

\*Some models. **4-43**

When Driving

## Switches and Controls

### ▼ Headlight Leveling\*

The number of passengers and weight of cargo in the luggage compartment change the angle of the headlights.

The angle of the headlights will be automatically adjusted when turning on the headlights.

A system malfunction or operation conditions are indicated by a warning. Refer to Warning/Indicator Lights on page 4-15.

### ▼ Adaptive Front Lighting System (AFS)\*

The adaptive front lighting system (AFS) automatically adjusts the headlight beams to the left or right in conjunction with the operation of the steering wheel after the headlights have been turned on and the vehicle speed is about 2 km/h (2 mph) or higher.

A system malfunction or operation conditions are indicated by a warning. Refer to Warning/Indicator Lights on page 4-15.

### AFS OFF switch

Pressing the AFS OFF switch turns off the AFS. The AFS OFF indicator light in the instrument cluster illuminates.

Pressing the AFS OFF switch again turns off the switch illumination and turns on the AFS operation. The AFS OFF indicator light turns off.

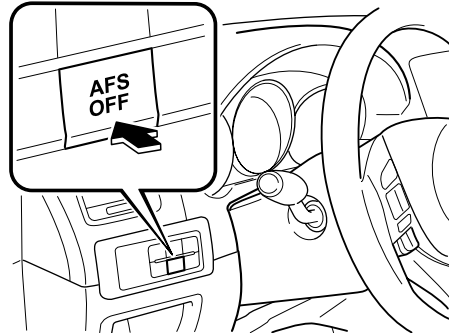

### ▼ Daytime Running Lights (Canada)

In Canada, vehicles must be driven with the headlights on during daytime operation.

For that reason, the daytime running lights automatically turn on when the ignition is switched ON.



#### **NOTE**

*The Daytime Running Lights turn off when the parking brake is operated or the shift lever is shifted to the P position (automatic transaxle vehicle).*

## Switches and Controls

### Fog Lights\*

Use this switch to turn on the fog lights. The fog lights will improve visibility at night and during foggy conditions.

To turn the fog lights on, rotate the fog light switch to the  position. The headlight switch must be in the  position before turning on the fog lights.

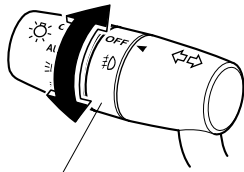

Fog light switch

OFF



To turn the fog lights off, rotate the fog light switch to the OFF position or turn the headlight switch to the  or OFF position.

#### NOTE

- The fog lights will turn off when the headlights are set at high beams.
- **(With auto-light control)**

If the fog light switch is in the  position and the headlight switch is in the AUTO position, the fog lights will turn on when the headlights, the exterior lights and dashboard illumination turn on.

### Turn and Lane-Change Signals

#### NOTE

- If an indicator light stays on without flashing or if it flashes abnormally, one of the turn signal bulbs may be burned out.
- A personalized function is available to change the turn indicator sound volume. Refer to Personalization Features on page 9-8.

#### ▼ Turn Signals

Move the signal lever down (for a left turn) or up (for a right turn) to the stop position. The signal will self-cancel after the turn is completed.

If the indicator light continues to flash after a turn, manually return the lever to its original position.

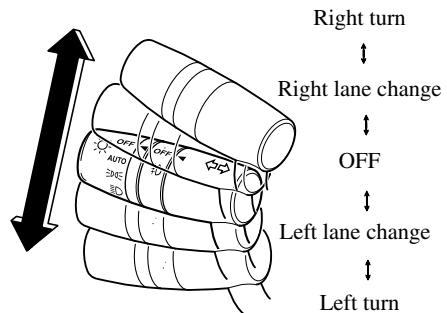

Right turn



Right lane change



OFF



Left lane change



Left turn

Green indicators on the dashboard show which signal is working.

When Driving

## Switches and Controls

### ▼ Lane-Change Signals

#### (Without Smart Turn)

Move the lever slightly toward the direction of the change —until the indicator flashes— and hold it there. It will return to the off position when released.

#### (With Smart Turn)

To signal a lane change, press the turn signal lever up or down halfway and release. After releasing the lever, the turn signal indicator flashes three times.

#### **NOTE**

*A personalized function is available to change the number of flashes.  
Refer to Personalization Features on page 9-8.*

### Windshield Wipers and Washer

The ignition must be switched ON.

#### **⚠ WARNING**

***Use only windshield washer fluid or plain water in the reservoir:***

*Using radiator antifreeze as washer fluid is dangerous. If sprayed on the windshield, it will dirty the windshield, affect your visibility, and could result in an accident.*

***Only use windshield washer fluid mixed with anti-freeze protection in freezing weather conditions:***

*Using windshield washer fluid without anti-freeze protection in freezing weather conditions is dangerous as it could freeze on the windshield and block your vision which could cause an accident. In addition, make sure the windshield is sufficiently warmed using the defroster before spraying the washer fluid.*



When Driving  
**Switches and Controls**

**NOTE**

Because heavy ice and snow can jam the wiper blades, the wiper motor is protected from motor breakdown, overheating and possible fire by a circuit breaker. This mechanism will automatically stop operation of the blades, but only for about 5 minutes.

If this happens, turn off the wiper switch and park off the right-of-way, and remove the snow and ice.

After 5 minutes, turn on the switch and the blades should operate normally. If they do not resume functioning, consult an Authorized Mazda Dealer as soon as possible. Drive to the side of the road and park off the right-of-way. Wait until the weather clears before trying to drive with the wipers inoperative.

**▼ Windshield Wipers**

Turn the wipers on by pressing the lever up or down.

**With intermittent wiper**

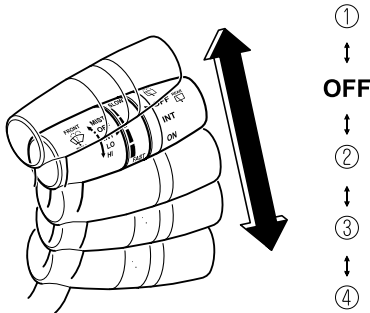

Switch Position	Wiper operation	
①	MIST	Single wipe cycle (mist)
②	INT	Intermittent
③	LO	Low speed
④	HI	High speed

**With auto-wiper control**

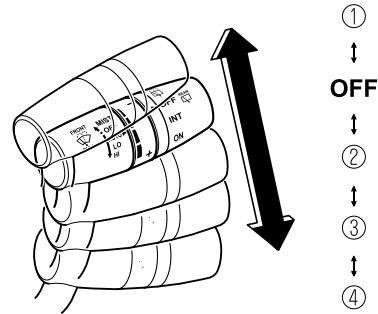

Switch Position	Wiper operation	
①	MIST	Single wipe cycle (mist)
②	AUTO	Auto control
③	LO	Low speed
④	HI	High speed

**Variable-speed intermittent wipers**

Set the lever to the intermittent position and choose the interval timing by rotating the ring.

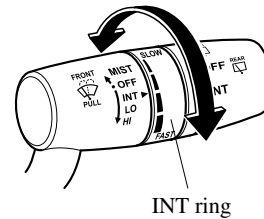

When Driving

## Switches and Controls

### Auto-wiper control

When the wiper lever is in the AUTO position, the rain sensor senses the amount of rainfall on the windshield and turns the wipers on or off automatically (off—intermittent—low speed—high speed).

The sensitivity of the rain sensor can be adjusted by turning the switch on the wiper lever.

From the center position (normal), rotate the switch downward for higher sensitivity (faster response) or rotate it upward for less sensitivity (slower response).

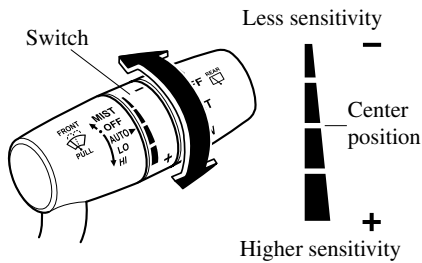

### **CAUTION**

- *Do not shade the rain sensor by adhering a sticker or a label on the windshield. Otherwise the rain sensor will not operate correctly.*

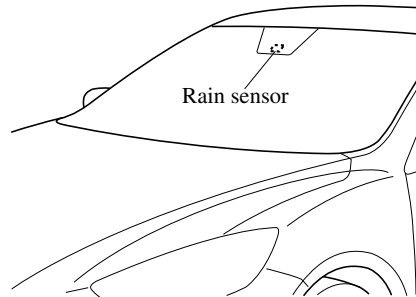

## Switches and Controls

➤ *When the wiper lever is in the AUTO position and the ignition is switched ON, the wipers may move automatically in the following cases:*

- *If the windshield above the rain sensor is touched or wiped with a cloth.*
- *If the windshield is struck with a hand or other object from either outside or inside the vehicle.*

*Keep hands and scrapers clear of the windshield when the wiper lever is in the AUTO position and the ignition is switched ON as fingers could be pinched or the wipers and wiper blades damaged when the wipers activate automatically.*

*If you are going to clean the windshield, be sure the wipers are turned off completely—this is particularly important when clearing ice and snow—when it is most likely that the engine is left running.*

### **NOTE**

- *Switching the auto-wiper lever from the OFF to the AUTO position while driving activates the windshield wipers once, after which they operate according to the rainfall amount.*
- *The auto-wiper control may not operate when the rain sensor temperature is about  $-10^{\circ}\text{C}$  ( $14^{\circ}\text{F}$ ) or lower, or about  $85^{\circ}\text{C}$  ( $185^{\circ}\text{F}$ ) or higher.*
- *If the windshield is coated with water repellent, the rain sensor may not be able to sense the amount of rainfall correctly and auto-wiper control may not operate properly.*
- *If dirt or foreign matter (Such as ice or matter containing salt water) adheres to the windshield above the rain sensor or if the windshield is iced, it could cause the wipers to move automatically. However, if the wipers cannot remove this ice, dirt or foreign matter, the auto-wiper control will stop operation. In this case, set the wiper lever to the low speed position or high speed position for manual operation, or remove the ice, dirt or foreign matter by hand to restore the auto-wiper operation.*
- *If the auto-wiper lever is left in the AUTO position, the wipers could operate automatically from the effect of strong light sources, electromagnetic waves, or infrared light because the rain sensor uses an optical sensor. It is recommended that the auto-wiper lever be switched to the OFF position other than when driving the vehicle under rainy conditions.*
- *The auto-wiper control functions can be turned off.*  
*Refer to Personalization Features on page 9-8.*

When Driving

## Switches and Controls

### ▼ Windshield Washer

Pull the lever toward you and hold it to spray washer fluid.

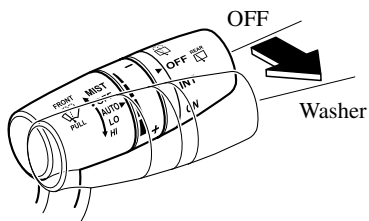

#### NOTE

With the wiper lever in the OFF or intermittent position/AUTO position, the wipers will operate continuously until the lever is released.

If the washer does not work, inspect the fluid level (page 6-25). If it's normal, consult an Authorized Mazda Dealer.

### Rear Window Wiper and Washer

The ignition must be switched ON.

#### ▼ Rear Window Wiper

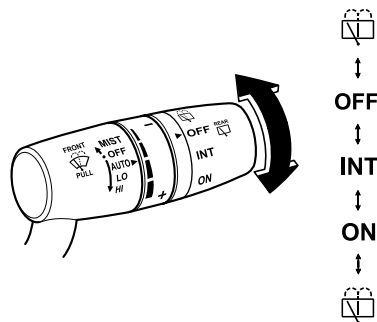

Turn the wiper on by turning the rear wiper/washer switch.

Switch Position		Wiper operation
①	INT	Intermittent
②	ON	Normal

#### ▼ Rear Window Washer

To spray washer fluid, turn the rear wiper/washer switch to the  position. After the switch is released, the washer will stop.

If the washer does not work, inspect the fluid level (page 6-25). If it's normal and the washer still does not work, consult an Authorized Mazda Dealer.

When Driving  
**Switches and Controls**

### Rear Window Defroster

The rear window defroster clears frost, fog, and thin ice from the rear window.

The ignition must be switched ON.

Press the switch to turn on the rear window defroster. The rear window defroster operates for about 15 minutes and turns off automatically. The indicator light illuminates during operation.

To turn off the rear window defroster before the 15 minutes has elapsed, press the switch again.

### Fully Automatic Type Climate Control

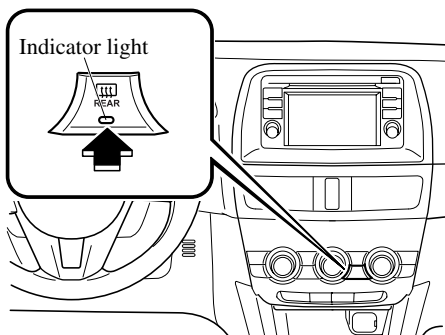

### Manual Type Climate Control

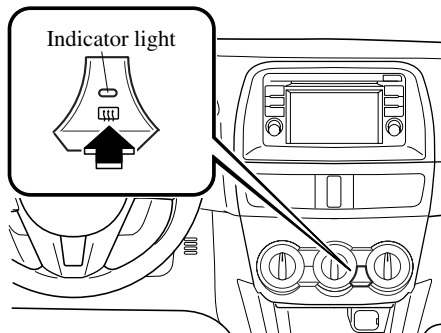

### CAUTION

*Do not use sharp instruments or window cleaners with abrasives to clean the inside of the rear window surface. They may damage the defroster grid inside the window.*

### NOTE

*This defroster is not designed for melting snow. If there is an accumulation of snow on the rear window, remove it before using the defroster.*

### ▼ Mirror Defroster\*

To turn on the mirror defrosters, switch the ignition ON and press the rear window defroster switch (page 4-51).

When Driving

## Switches and Controls

### Horn

To sound the horn, press the  mark on the steering wheel.

### Hazard Warning Flasher

The hazard warning lights should always be used when you stop on or near a roadway in an emergency.

The hazard warning lights warn other drivers that your vehicle is a traffic hazard and that they must take extreme caution when near it.

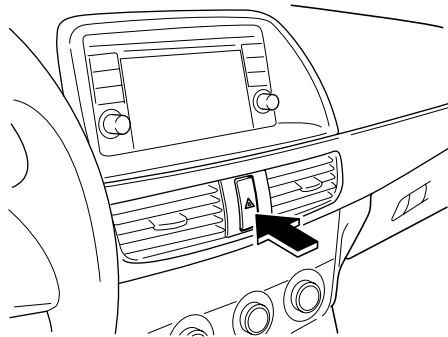

Depress the hazard warning flasher and all the turn signals will flash. The hazard warning indicator lights in the instrument cluster flash simultaneously.

#### **NOTE**

- *The turn signals do not work when the hazard warning lights are on.*
- *Check local regulations about the use of hazard warning lights while the vehicle is being towed to verify that it is not in violation of the law.*

When Driving  
**Switches and Controls**

## HomeLink Wireless Control System\*

### NOTE

HomeLink and HomeLink house are registered trademarks of Johnson Controls.

The HomeLink system replaces up to 3 hand-held transmitters with a single built-in component in the auto-dimming mirror. Pressing the HomeLink button on the auto-dimming mirror activates garage doors, gates and other devices surrounding your home.

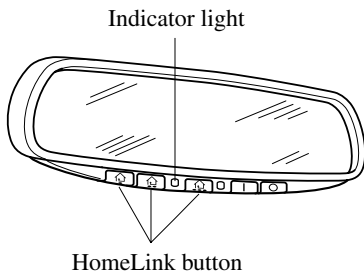

### **⚠ WARNING**

**Do not use the HomeLink system with any garage door opener that lacks the safety stop and reverse feature:**

Using the HomeLink system with any garage door opener that lacks the safety stop and reverse feature as required by federal safety standards is dangerous. (This includes garage doors manufactured before April 1, 1982.)

Using these garage door openers can increase the risk of serious injury or death. For further information, contact HomeLink at 1-800-355-3515 or [www.homelink.com](http://www.homelink.com) or your Authorized Mazda Dealer.

**Always check the areas surrounding garage doors and gates for people or obstructions before programming or during operation of the HomeLink system:**

Programming or operating the HomeLink system without verifying the safety of areas surrounding garage doors and gates is dangerous and could result in an unexpected accident and serious injury if someone were to be hit.

### NOTE

The programming will not be erased even if the battery is disconnected.

### ▼ Pre-programming the HomeLink System

### NOTE

It is recommended that a new battery be placed in the hand-held transmitter of the device being programmed to HomeLink for quicker training and accurate transmission of the radio-frequency signal.

When Driving

## Switches and Controls

- Verify that there is a remote control transmitter available for the device you would like to program.
- Disconnect the power to the device.

### ▼ Programming the HomeLink System

#### CAUTION

*When programming a garage door opener or a gate, disconnect the power to these devices before performing programming, as continuous operation of the devices could damage the motor.*

The HomeLink system provides 3 buttons which can be individually selected and programmed using the transmitters for current, on-market devices as follows:

1. Position the end of your hand-held transmitter 2.5—7.5 cm (1—3 inches) away from the HomeLink button you wish to program while keeping the indicator light in view.
2. Simultaneously press and hold both the chosen HomeLink and hand-held transmitter buttons. **Do not release the buttons until step 3 has been completed.**

#### NOTE

*Some gate operators and garage door openers may require you to replace this Programming Step 2 with procedures noted in the “Gate Operator/Canadian Programming” section.*

3. After the HomeLink indicator light changes from a slow to a rapidly blinking light, release both the HomeLink and hand-held transmitter buttons.

#### NOTE

*If the HomeLink indicator light does not change to a rapidly blinking light, contact HomeLink at [www.homelink.com](http://www.homelink.com) or call 1-800-355-3515 for assistance.*

4. Firmly press and hold the programmed HomeLink button for five seconds, and then release it. Perform this operation two times to activate the door. If the door does not activate, press and hold the just-trained HomeLink button and observe the indicator light.

If the indicator light **stays on constantly, programming is complete** and your device should activate when the HomeLink button is pressed and released.

#### NOTE

*To program the remaining two HomeLink buttons, begin with “Programming” — step 1.*

If the indicator light blinks **rapidly for two seconds and then turns to a constant light, continue with “Programming” steps 5—7** to complete the programming of a rolling code equipped device (most commonly a garage door opener).

5. At the garage door opener receiver (motor-head unit) in the garage, locate the “learn” or “smart” button. This can usually be found where the hanging antenna wire is attached to the motor-head unit.
6. Firmly press and release the “learn” or “smart” button. (The name and color of the button may vary by manufacturer.)

#### NOTE

*There are 30 seconds in which to initiate step 7.*



When Driving

## Switches and Controls

- Return to the vehicle and firmly **press, hold for two seconds and release** the programmed HomeLink button. Repeat the “**press/hold/release**” sequence a second time, and, depending on the brand of the garage door opener (or other rolling code equipped device), repeat this sequence a third time to complete the programming process.

HomeLink should now activate your rolling code equipped device.

### **NOTE**

*To program the remaining two HomeLink buttons, begin with “Programming” — step 1.*

For questions or comments, please contact HomeLink at [www.homelink.com](http://www.homelink.com) or 1-800-355-3515.

### ▼ Gate operator/Canadian Programming

Canadian radio-frequency laws require transmitter signals to “time-out” (or quit) after several seconds of transmission — which may not be long enough for HomeLink to pick up the signal during programming. Similar to this Canadian law, some U.S. gate operators are designed to “time-out” in the same manner.

If you live in Canada or you are having difficulties programming a gate operator by using the “Programming” procedures (regardless of where you live), **replace “Programming HomeLink” step 2** with the following:

### **NOTE**

*If programming a garage door opener or gate operator, it is advised to unplug the device during the “cycling” process to prevent possible overheating.*

Continue to press and hold the HomeLink button while you **press and release — every two seconds** (“cycle”) your hand-held transmitter until the frequency signal has successfully been accepted by HomeLink. (The indicator light will flash slowly and then rapidly.)

Proceed with “Programming” step 3 to complete.

### ▼ Operating the HomeLink System



Press the programmed HomeLink button to operate a programmed device. The code will continue being transmitted for a maximum of 20 seconds.

### ▼ Reprogramming the HomeLink system

To program a device to HomeLink using a HomeLink button previously trained, follow these steps:

- Press and hold the desired HomeLink button. **DO NOT** release the button.
- The indicator light will begin to flash after 20 seconds. Without releasing the HomeLink button, proceed with “Programming” - step 1.

### ▼ Erasing Programmed HomeLink Buttons

To erase the existing programming from all three operating channels, press and hold the two outside buttons (  ,  ) on the auto-dimming mirror until the HomeLink indicator light begins to flash after approximately 10 seconds. Verify that the programming has been erased when you resell the vehicle.

When Driving

## Brake

### Brake System

#### ▼ Foot Brake

Your Mazda has power-assisted brakes that adjust automatically through normal use.

Should power-assist fail, you can stop by applying greater force than normal to the brake pedal. But the distance required to stop will be greater than usual.

#### **WARNING**

***Do not coast with the engine stalled or turned off, find a safe place to stop:***

*Coasting with the engine stalled or turned off is dangerous. Braking will require more effort, and the brake's power-assist could be depleted if you pump the brake. This will cause longer stopping distances or even an accident.*

***Shift to a lower gear when going down steep hills:***

*Driving with your foot continuously on the brake pedal or steadily applying the brakes for long distances is dangerous. This causes overheated brakes, resulting in longer stopping distances or even total brake failure. This could cause loss of vehicle control and a serious accident. Avoid continuous application of the brakes.*

***Dry off brakes that have become wet by driving slowly, releasing the accelerator pedal and lightly applying the brakes several times until the brake performance returns to normal:***

*Driving with wet brakes is dangerous. Increased stopping distance or the vehicle pulling to one side when braking could result in a serious accident. Light braking will indicate whether the brakes have been affected.*

When Driving  
**Brake**

**CAUTION**

- Do not drive with your foot held on the clutch pedal or brake pedal, or hold the clutch pedal depressed halfway unnecessarily. Doing so could result in the following:
  - The clutch and brake parts will wear out more quickly.
  - The brakes can overheat and adversely affect brake performance.
- Always depress the brake pedal with the right foot. Applying the brakes with the unaccustomed left foot could slow your reaction time to an emergency situation resulting in insufficient braking operation.

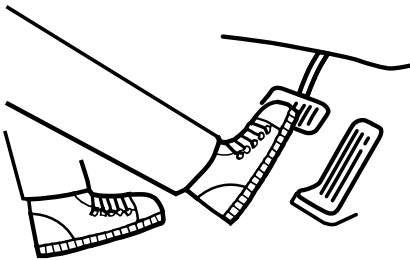

- Wear shoes appropriate for driving in order to avoid your shoe contacting the brake pedal when depressing the accelerator pedal.

▼ Parking Brake

**CAUTION**

Driving with the parking brake on will cause excessive wear of the brake pads.

**NOTE**

For parking in snow, refer to Winter Driving (page 3-39) regarding parking brake use.

**Setting the parking brake**

Depress the brake pedal and then firmly pull the parking brake lever fully upwards with sufficient force to hold the vehicle in a stationary position.

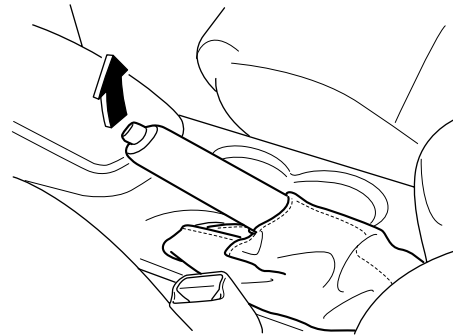

**Releasing the parking brake**

Depress the brake pedal and pull the parking brake lever upwards, then press the release button. While holding the button, lower the parking brake lever all the way down to the released position.

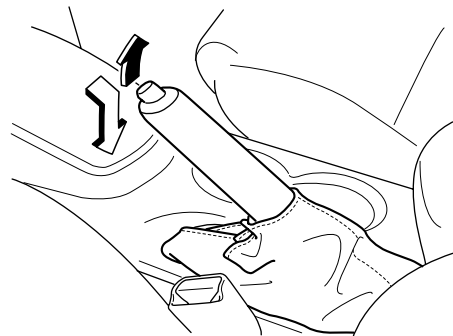

When Driving

## Brake

### ▼ Warning Light

A system malfunction or operation conditions are indicated by a warning. Refer to Warning/Indicator Lights on page 4-15.

### ▼ Brake Pad Wear Indicator

When the disc brake pads become worn, the built-in wear indicators contact the disc plates. This causes a screeching noise to warn that the pads should be replaced.

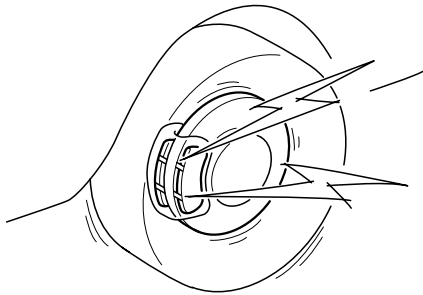

When you hear this noise, consult an Authorized Mazda Dealer as soon as possible.

### **⚠ WARNING**

**Do not drive with worn disc pads:**  
Driving with worn disc pads is dangerous. The brakes could fail and cause a serious accident. As soon as you hear a screeching noise consult an Authorized Mazda Dealer.

### ▼ Brake Assist

During emergency braking situations when it is necessary to depress the brake pedal with greater force, the brake assist system provides braking assistance, thus enhancing braking performance.

When the brake pedal is depressed hard or depressed more quickly, the brakes apply more firmly.

#### **NOTE**

- When the brake pedal is depressed hard or depressed more quickly, the pedal will feel softer but the brakes will apply more firmly. This is a normal effect of the brake assist operation and does not indicate a malfunction.
- When the brake pedal is depressed hard or depressed more quickly, a motor/pump operation noise may be heard. This is a normal effect of the brake assist and does not indicate a malfunction.
- The brake assist equipment does not supersede the functionality of the vehicle's main braking system.

### ▼ Hill Launch Assist (HLA)

Hill Launch Assist (HLA) is a function which assists the driver in accelerating from a stop while on a slope. When the driver releases the brake pedal and depresses the accelerator pedal while on a slope, the function prevents the vehicle from rolling by maintaining the braking force after the brake pedal is released.

For vehicles with a manual transaxle, Hill Launch Assist (HLA) operates on a downward slope when the shift lever is in the reverse (R) position, and on an upward slope when the shift lever is in a position other than the reverse (R) position.

For vehicles with an automatic transaxle, Hill Launch Assist (HLA) operates on a downward slope when the shift lever is in the reverse (R) position, and on an upward slope when the shift lever is in a forward gear.

### **WARNING**

**Do not rely completely on Hill Launch Assist (HLA).**

*Hill Launch Assist (HLA) is an auxiliary device for accelerating from a stop on a slope. The system only operates for about two seconds and therefore, relying only on the system, when accelerating from a stop is dangerous because the vehicle may move (roll) unexpectedly and cause an accident.*

*The vehicle could roll depending on the vehicle's load or if it is towing something. In addition, for vehicles with a manual transaxle, the vehicle could still roll depending on how the clutch pedal or the accelerator pedal is operated.*

*Always confirm the safety around the vehicle before starting to drive the vehicle.*

When Driving

## Brake

---

### **NOTE**

- *Hill Launch Assist (HLA) does not operate on a gentle slope. In addition, the gradient of the slope on which the system will operate changes depending on the vehicle's load.*
- *Hill Launch Assist (HLA) does not operate if the parking brake is applied, the vehicle has not stopped completely, or the clutch pedal is released.*
- *While Hill Launch Assist (HLA) is operating, the brake pedal may feel stiff and vibrate, however, this does not indicate a malfunction.*
- *Hill Launch Assist (HLA) does not operate while the TCS/DSC indicator light is illuminated.  
Refer to Warning/Indicator Lights on page 4-15.*
- *Hill Launch Assist (HLA) does not turn off even if the TCS OFF switch is pressed to turn off the TCS.*

When Driving  
**ABS/TCS/DSC**

### Antilock Brake System (ABS)

The ABS control unit continuously monitors the speed of each wheel. If one wheel is about to lock up, the ABS responds by automatically releasing and reapplying that wheel's brake.

The driver will feel a slight vibration in the brake pedal and may hear a chattering noise from the brake system. This is normal ABS system operation. Continue to depress the brake pedal without pumping the brakes.

A system malfunction or operation conditions are indicated by a warning. Refer to Warning/Indicator Lights on page 4-15.

#### **⚠ WARNING**

**Do not rely on ABS as a substitute for safe driving:**

*The ABS cannot compensate for unsafe and reckless driving, excessive speed, tailgating (following another vehicle too closely), driving on ice and snow, and hydroplaning (reduced tire friction and road contact because of water on the road surface). You can still have an accident.*

#### **NOTE**

*Braking distances may be longer on loose surfaces (snow or gravel, for example) which usually have a hard foundation. A vehicle with a normal braking system may require less distance to stop under these conditions because the tires will build up a wedge of surface layer when the wheels skid.*

### Traction Control System (TCS)

The Traction Control System (TCS) enhances traction and safety by controlling engine torque and braking. When the TCS detects driving wheel slippage, it lowers engine torque and operates the brakes to prevent loss of traction.

This means that on a slick surface, the engine adjusts automatically to provide optimum power to the drive wheels, limiting wheel spin and loss of traction.

A system malfunction or operation conditions are indicated by a warning. Refer to Warning/Indicator Lights on page 4-15.

#### **⚠ WARNING**

**Do not rely on the traction control system as a substitute for safe driving:**

*The traction control system (TCS) cannot compensate for unsafe and reckless driving, excessive speed, tailgating (following another vehicle too closely), and hydroplaning (reduced tire friction and road contact because of water on the road surface). You can still have an accident.*

**Use snow tires or tire chains and drive at reduced speeds when roads are covered with ice and/or snow:**

*Driving without proper traction devices on snow and/or ice-covered roads is dangerous. The traction control system (TCS) alone cannot provide adequate traction and you could still have an accident.*

When Driving

## ABS/TCS/DSC

### NOTE

To turn off the TCS, press the TCS OFF switch (page 4-62).

### ▼ TCS OFF Switch

Press the TCS OFF switch to turn off the TCS. The TCS OFF indicator light in the instrument cluster will illuminate.

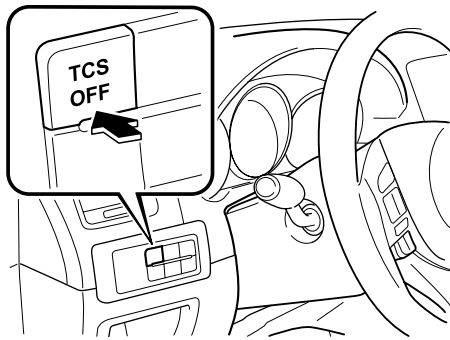

Press the switch again to turn the TCS back on. The TCS OFF indicator light will turn off.

### NOTE

- When TCS is on and you attempt to free the vehicle when it is stuck, or drive it out of freshly fallen snow, the TCS will activate. Depressing the accelerator will not increase engine power and freeing the vehicle may be difficult. When this happens, turn off the TCS.
- If the TCS is off when the engine is turned off, it automatically activates when the ignition is switched ON.
- Leaving the TCS on will provide the best traction.
- If the TCS OFF switch is pressed and held for 10 seconds or more, the TCS OFF switch malfunction detection function operates and the TCS system activates automatically. The TCS OFF indicator light turns off while the TCS system is operative.

4-62

## Dynamic Stability Control (DSC)

The Dynamic Stability Control (DSC) automatically controls braking and engine torque in conjunction with systems such as ABS and TCS to help control side slip when driving on slippery surfaces, or during sudden or evasive maneuvering, enhancing vehicle safety.

Refer to ABS (page 4-61) and TCS (page 4-61).

DSC operation is possible at speeds greater than 15 km/h (9 mph).

A system malfunction or operation conditions are indicated by a warning. Refer to Warning/Indicator Lights on page 4-15.

### ⚠ WARNING

**Do not rely on the dynamic stability control as a substitute for safe driving:**

*The dynamic stability control (DSC) cannot compensate for unsafe and reckless driving, excessive speed, tailgating (following another vehicle too closely), and hydroplaning (reduced tire friction and road contact because of water on the road surface). You can still have an accident.*



When Driving  
**ABS/TCS/DSC**

---

**⚠ CAUTION**

- *The DSC may not operate correctly unless the following are observed:*
  - *Use tires of the correct size specified for your Mazda on all four wheels.*
  - *Use tires of the same manufacturer, brand and tread pattern on all four wheels.*
  - *Do not mix worn tires.*
- *The DSC may not operate correctly when tire chains are used or a temporary spare tire is installed because the tire diameter changes.*

When Driving

## AWD

### All-Wheel Drive (AWD) Operation

- AWD provides excellent drivability on snow-covered and ice-packed roads, sand and mud, as well as on steep slopes and other slippery surfaces.
- A system malfunction or operation conditions are indicated by a warning. Refer to Warning/Indicator Lights on page 4-15.

#### **⚠ WARNING**

**Never spin a wheel that is off the ground:**

*Spinning a wheel that is off the ground as a result of the vehicle being stuck or in a ditch is dangerous. The drive assembly could be seriously damaged which could lead to an accident or could even lead to overheating, oil leakage, and a fire.*

#### ▼ AWD Driving

#### **⚠ WARNING**

**Avoid sharp turns, excessive speed and abrupt maneuvers when driving this vehicle:**

*Sharp turns, excessive speed and abrupt maneuvering of this vehicle is dangerous as it could result in the increased risk of loss of vehicle control, vehicle roll-over, personal injury or death.*

*This vehicle has a higher center of gravity. Vehicles with a higher center of gravity such as utility and AWD vehicles handle differently than vehicles with a lower center of gravity.*

*Utility and AWD vehicles are not designed for cornering at high speeds any more than low profile sports cars are designed to perform satisfactorily under off-road conditions. In addition, utility vehicles have a significantly higher rollover rate than other types of vehicles.*

**Drive carefully when the vehicle is loaded by lowering vehicle speed and applying the brakes earlier:**

*Abrupt maneuvering and sudden braking when driving a loaded vehicle is dangerous as the driving behavior of a vehicle with a high center of gravity is different when it is loaded compared to when it is not, and could result in the loss of vehicle control and an accident.*



### ▼ Tires and Tire Chains

The condition of the tires plays a large role in the performance of the vehicle. Moreover, to prevent adverse effects to the drive assembly, please note the following:

#### **Tires**

- When replacing tires, always replace all front and rear tires at the same time.
- All tires must be of the same size, manufacture, brand and tread pattern. Pay particular attention when equipping snow or other types of winter tires.
- Do not mix tread-worn tires with normal tires.
- Inspect tire inflation pressures at the specified periods and adjust to the specified pressures.

#### ***NOTE***

*Check the tire inflation pressure label attached to driver's door frame for the correct tire inflation pressure.*

- Make sure to equip the vehicle with genuine wheels of the specified size, on all wheels. With AWD, the system is calibrated for all four wheels being of the same dimensions.

#### **Tire chains**

- Install tire chains to the front tires.
- Do not use tire chains on the rear wheels.
- Do not drive the vehicle faster than 30 km/h (19 mph) with the tire chains installed.
- Do not drive the vehicle with tire chains on road conditions other than snow or ice.

### ▼ Towing

If the vehicle requires towing, have it towed with all four wheels completely off the ground(page 7-20).

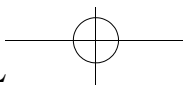

When Driving

## Power Steering

---

### Power Steering

- Power steering is only operable when the engine is running. If the engine is off or if the power steering system is inoperable, you can still steer, but it requires more physical effort. If the steering feels stiffer than usual during normal driving or the steering vibrates, consult an Authorized Mazda Dealer.
- A system malfunction or operation conditions are indicated by a warning. Refer to Warning/Indicator Lights on page 4-15.

#### CAUTION

*Never hold the steering wheel to the extreme left or right for more than 5 seconds with the engine running. This could damage the power steering system.*

When Driving  
**Cruise Control**

## Cruise Control

With cruise control, you can set and automatically maintain any speed of more than about 25 km/h (16 mph).

### **! WARNING**

**Do not use the cruise control under the following conditions:**

*Using the cruise control under the following conditions is dangerous and could result in loss of vehicle control.*

- *Hilly terrain*
- *Steep inclines*
- *Heavy or unsteady traffic*
- *Slippery or winding roads*
- *Similar restrictions that require inconsistent speed*

### ▼ Cruise Control Switch

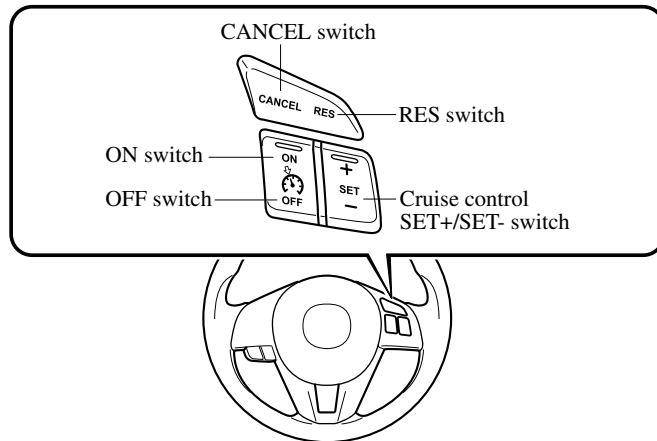

When Driving

## Cruise Control

### ▼ Activation/Deactivation

To activate the system, press the ON switch.

The cruise main indicator light (Amber) illuminates. Refer to Warning/Indicator Lights on page 4-15.

To deactivate the system, press the OFF switch.

The cruise main indicator light (Amber) turns off.

### **⚠ WARNING**

**Always turn off the cruise control system when it is not in use:**

*Leaving the cruise control system in an activation-ready state while the cruise control is not in use is dangerous as the cruise control could unexpectedly activate if the activation button is accidentally pressed, and result in loss of vehicle control and an accident.*

### ▼ To Set Speed

1. Activate the cruise control system by pressing the ON switch.  
The cruise set indicator light (Green) illuminates. Refer to Warning/Indicator Lights on page 4-15.
2. Accelerate to the desired speed, which must be more than 25 km/h (16 mph).
3. Set the cruise control by pressing the SET + or SET - switch at the desired speed. The cruise control is set at the moment the SET + or SET - switch is pressed. Release the accelerator pedal simultaneously.

### NOTE

- Release the SET + or SET - switch at the desired speed, otherwise the speed will continue increasing while the SET + switch is pressed and held, and continue decreasing while the SET - switch is pressed and held (except when the accelerator pedal is depressed).
- On a steep grade, the vehicle may momentarily slow down while ascending, or speed up while descending.
- Cruise control will turn off if the vehicle speed drops below 21 km/h (13 mph) when cruise is activated, such as when climbing a steep grade.

### ▼ To Increase Cruising Speed

Follow either of these procedures.

#### **To increase speed using cruise control switch**

Press the SET + switch and hold it. Your vehicle will accelerate.

Release the switch at the speed you want.

Press the SET+ and release it immediately to adjust the preset speed. Multiple operations will increase the preset speed according to the number of times it is operated.

#### **Increasing speed with a single SET+ operation**

Meter display for vehicle speed indicated in km/h: 1 km/h (0.6 mph)

Meter display for vehicle speed indicated in mph: 1 mph (1.6 km/h)

#### **To increase speed using accelerator pedal**

Depress the accelerator pedal to accelerate to the desired speed. Press the SET + or SET - switch and release it immediately.

When Driving  
**Cruise Control**

**NOTE**

*Accelerate if you want to speed up temporarily when the cruise control is on. Greater speed will not interfere with or change the set speed. Take your foot off the accelerator to return to the set speed.*

**▼ To Decrease Cruising Speed**

Press the SET - switch and hold it. The vehicle will gradually slow.  
Release the switch at the speed you want.

Press the SET- switch and release it immediately to adjust the preset speed. Multiple operations will decrease the preset speed according to the number of times it is operated.

**Decreasing speed with a single SET-operation**

Meter display for vehicle speed indicated in km/h: 1 km/h (0.6 mph)

Meter display for vehicle speed indicated in mph: 1 mph (1.6 km/h)

**▼ To Resume Cruising Speed at More Than 25 km/h (16 mph)**

If some other method besides the OFF switch was used to cancel cruising speed (such as applying the brake pedal) and the system is still activated, the most recent set speed will automatically resume when the RES switch is pressed.

If vehicle speed is below 25 km/h (16 mph), increase the vehicle speed up to 25 km/h (16 mph) or more and press the RES switch.

**▼ To Cancel**

To cancel the system, use **one** of these methods:

- Press the OFF switch.
- Slightly depress the brake pedal.
- Depress the clutch pedal (Manual transaxle only).
- Press the CANCEL switch.

The system turns off when the ignition is switched off.

**NOTE**

*Cruise control may cancel at about 15 km/h (9 mph) below the preset speed (such as may happen when climbing a long, steep grade).*

When Driving

## Tire Pressure Monitoring System

---

### Tire Pressure Monitoring System

- The tire pressure monitoring system monitors the air pressure of all four wheels. If the air pressure of one or more tires is too low, the system warns the driver by indicating the tire pressure monitoring system warning light in the instrument cluster and operating a beep sound. The system monitors the tire pressures indirectly using the data sent from the ABS wheel speed sensors.

To allow the system to operate correctly, the system needs to be initialized with the specified tire pressure (value on the tire pressure label). Follow the procedure and perform the initialization.

- A system malfunction or operation conditions are indicated by a warning. Refer to Warning/Indicator Lights on page 4-15.  
Refer to Tire Inflation Pressure Warning Beep on page 7-34.

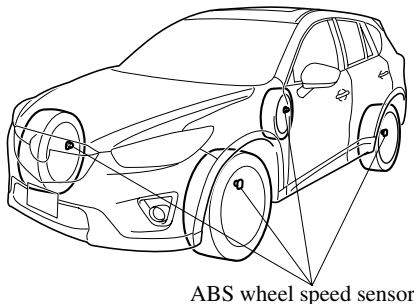



When Driving

## Tire Pressure Monitoring System

### CAUTION

- *Each tire, including the spare (if provided), should be checked monthly when cold and inflated to the inflation pressure recommended by the vehicle manufacturer on the vehicle placard or tire inflation pressure label. (If your vehicle has tires of a different size than the size indicated on the vehicle placard or tire inflation pressure label, you should determine the proper tire inflation pressure for those tires.)*

*As an added safety feature, your vehicle has been equipped with a tire pressure monitoring system (TPMS) that illuminates a low tire pressure telltale when one or more of your tires is significantly under-inflated. Accordingly, when the low tire pressure telltale illuminates, you should stop and check your tires as soon as possible, and inflate them to the proper pressure. Driving on a significantly under-inflated tire causes the tire to overheat and can lead to tire failure. Under-inflation also reduces fuel efficiency and tire tread life, and may affect the vehicle's handling and stopping ability.*

*Please note that the TPMS is not a substitute for proper tire maintenance, and it is the driver's responsibility to maintain correct tire pressure, even if under-inflation has not reached the level to trigger illumination of the TPMS low tire pressure telltale.*

- *Your vehicle has also been equipped with a TPMS malfunction indicator to indicate when the system is not operating properly. The TPMS malfunction indicator is combined with the low tire pressure telltale. When the system detects a malfunction, the telltale will flash for approximately one minute and then remain continuously illuminated. This sequence will continue upon subsequent vehicle start-ups as long as the malfunction exists. When the malfunction indicator is illuminated, the system may not be able to detect or signal low tire pressure as intended. TPMS malfunctions may occur for a variety of reasons, including the installation of replacement or alternate tires or wheels on the vehicle that prevent the TPMS from functioning properly. Always check the TPMS malfunction telltale after replacing one or more tires or wheels on your vehicle to ensure that the replacement or alternate tires and wheels allow the TPMS to continue to function properly.*
- *To avoid false readings, the system samples for a little while before indicating a problem. As a result it will not instantaneously register a rapid tire deflation or blow out.*

When Driving

## Tire Pressure Monitoring System

### NOTE

Because this system detects slight changes in tire conditions, the timing of the warning may be faster or slower in the following cases:

- The size, manufacturer, or the type of tires is different from the specification.
- The size, manufacturer, or the type of a tire is different from the others, or the level of tire wear is excessively different between them.
- A run-flat tire, studless tire, snow tire, or tire chains are used.
- An emergency tire is used (The tire pressure monitoring system warning light may flash and then continue illuminating).
- A tire is repaired using the emergency flat tire repair kit.
- The tire pressure is excessively higher than the specified pressure, or the tire pressure is suddenly lowered for some reason such as a tire burst during driving.
- The vehicle speed is lower than about 15 km/h (9.3 mph) (including when the vehicle is stopped), or the drive period is shorter than 5 minutes.
- The vehicle is driven on an extremely rough road or a slippery, icy road.
- Hard steering and rapid acceleration/deceleration are repeated such as during aggressive driving on a winding road.
- Load on the vehicle is applied to a tire such as by loading heavy luggage to one side of the vehicle.
- System initialization has not been implemented with the specified tire pressure.



### ▼ Tire Pressure Monitoring System Initialization

In the following cases, system initialization must be performed so that the system operates normally.

- A tire pressure is adjusted.
- Tire rotation is performed.
- A tire or wheel is replaced.
- The battery is replaced or completely drained.
- The tire pressure monitoring system warning light is illuminated.

### Initialization method

1. Park the car in a safe place and firmly apply the parking brake.
2. Let the tires cool, and adjust the tire pressure to the specified pressure indicated on the tire pressure label on all four tires.
3. Switch the ignition ON.

When Driving  
**Tire Pressure Monitoring System**

4. While the vehicle is parked, press and hold the tire pressure monitoring system set switch and verify that the tire pressure monitoring system warning light in the instrument cluster flashes twice and a beep sound is heard once.

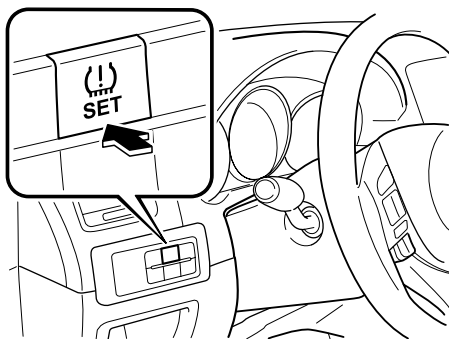

**CAUTION**

*If the system initialization is performed without adjusting the tire pressure, the system cannot detect the normal tire pressure and it may not illuminate the tire pressure monitoring system warning light even if a tire pressure is low, or it may illuminate the light even if the pressures are normal.*

*The system initialization will not be performed if the switch is pressed while the vehicle is being driven.*

When Driving

## Blind Spot Monitoring (BSM) System

### Blind Spot Monitoring (BSM) System \*

The Blind Spot Monitoring (BSM) system is designed to assist the driver by monitoring blind spots on both sides of the vehicle to the rear in certain situations such as when changing lanes on roads and freeways.

The BSM system monitors the detection areas on both sides of the vehicle to the rear when the vehicle speed is about 32 km/h (20 mph) or more, and notifies the driver of vehicles in the detection area by illuminating the BSM warning light.

If the turn signal lever is operated in the direction the BSM warning light is illuminated, the system warns the driver of the vehicle in the detection area with a beep sound.

A system malfunction or operation conditions are indicated by a warning. Refer to Warning/Indicator Lights on page 4-15. Refer to Blind Spot Monitoring (BSM) System Warning Beep on page 7-34.

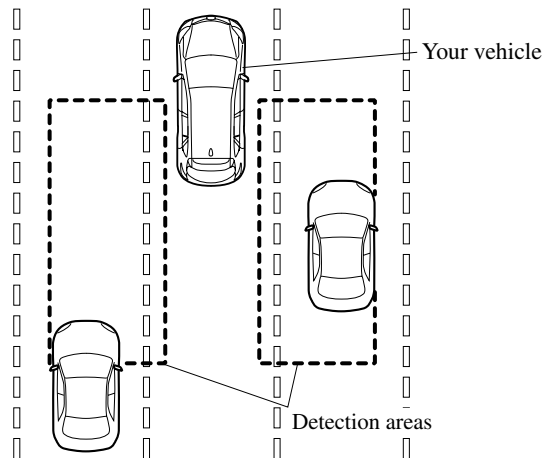

#### **⚠ WARNING**

**Do not rely completely on the BSM system and be sure to look over your shoulder before changing lanes:**

*The BSM system can assist the driver in confirming the safety of the surroundings but is not a complete substitute. The driver is responsible for assuring lane changes and other maneuvers. Always pay attention to the direction in which the vehicle is traveling and the vehicle's surroundings.*

#### **NOTE**

- The BSM system does not operate when the vehicle speed is lower than about 32 km/h (20 mph).
- The radar sensors are equipped inside the rear bumper. (page 4-80)
- The system may not operate normally when towing a trailer. Turn off the system by operating the BSM OFF switch when towing a trailer.

**4-74** \*Some models.



When Driving

## Blind Spot Monitoring (BSM) System

---

- *The radar sensors do not detect human, animal, or static objects such as fences. In addition, the system pauses when the selector lever is shifted to the R position. (The system resumes automatically when the selector lever is shifted from the R position.)*
- *The detectability of the radar sensors has its limitations. The BSM system may not operate properly under the following conditions:*
  - *Ice, snow, or soil adheres to the rear bumper surface around the radar sensors.*
  - *During adverse weather conditions such as rain or snow, or under conditions where water is sprayed.*
  - *The rear bumper area around the radar sensors is blocked by foreign material (such as stickers or a bicycle carrier).*
- *The radar sensors may not detect all types of vehicles around your vehicle, especially the following types of vehicles:*
  - *Motorcycles*
  - *Vehicles with body shapes that radar may not reflect such as a flatbed trailer with no cargo.*
  - *Vehicles with lower body height such as sports cars.*
- *Have the radar sensors inspected at an Authorized Mazda Dealer if any shock is applied to the rear bumper, even in a minor accident. If the vehicle is driven with a damaged radar sensor, the system may not operate properly resulting in an accident.*
- *For repairs or paintwork around the radar sensors, or replacement of the bumper, consult an Authorized Mazda Dealer.*
- *The radar sensors of the BSM system may be regulated under the radio wave related laws of the country where the vehicle is driven. The sensors in this system are approved for use in the U.S.A. (including territories), Canada, and Mexico. If a vehicle with a BSM system is driven in a country other than the U.S.A., Canada, or Mexico, the system has to be turned off using the BSM OFF switch.*
- *The detection area of the system has been determined based on the lane width of general freeways. Therefore on a road with a narrower lane width, the system may detect vehicles on a lane next to the adjacent lane and operate the warning light/beep. On a road with wider lane width, the system may not detect vehicles on the adjacent lane and may not operate the warning light/beep.*
- *Operation of the warning light/beep may be delayed or the system may not operate the warning light/beep under the following conditions:*
  - *The vehicle accelerates from a standing-start with a vehicle alongside.*
  - *A vehicle moves from a lane two lanes over to the adjacent lane.*
  - *The difference in vehicle speed between your vehicle and another vehicle is larger when passing or being passed, and the vehicle passes the detection area within a short period of time.*
  - *On a steep incline, or when there is a difference in height between lanes.*
  - *Immediately after the system has been activated by pressing the BSM OFF switch again after it has been turned off (BSM OFF indicator light in instrument panel illuminates) by pressing the switch.*
- *Although the system may detect objects on the road side such as parked vehicles or guardrails and operate the warning light/beep, it does not indicate a malfunction.*

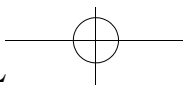



When Driving

## Blind Spot Monitoring (BSM) System

---

- If the vehicle is driven on a road with less traffic and few vehicles that the radar sensors can detect, the system may pause (The BSM OFF indicator light in the instrument panel flashes). However, it does not indicate a malfunction.
- The following conditions may affect the visibility of the BSM warning lights on the outside mirror, making it difficult to confirm the illumination of the lights:
  - Ice or snow adheres to the surface of the outside mirrors.
  - The door window glass is tinted.

### ▼ BSM Warning Light

The blind spot monitoring system alerts the driver to the presence of another vehicle in an adjacent lane using the BSM warning lights and the warning beep while the system is operational.

#### **BSM warning light**

Equipped on the left and right door mirrors.

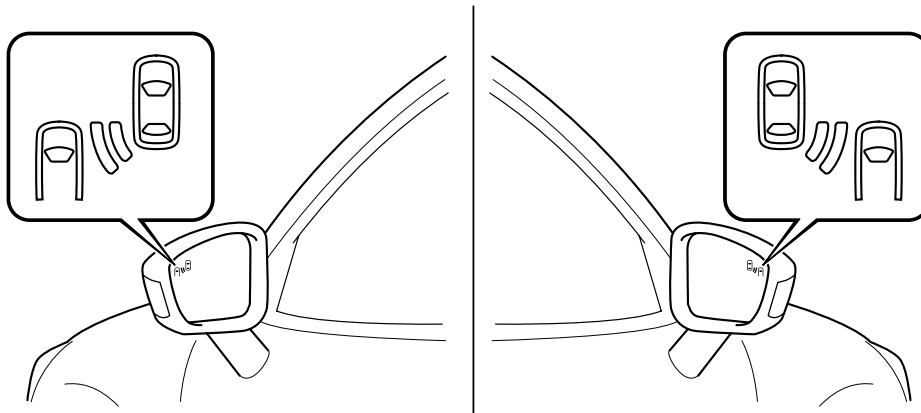

This warning light illuminates for a few seconds when the ignition is switched ON. If the BSM system detects a vehicle in the detection area while the vehicle is driven at a speed of about 32 km/h (20 mph) or more, the BSM warning light illuminates on the side of the vehicle where the rear on-coming vehicle is detected.

#### **NOTE**

- If ice or snow adhere to the outer mirror surface, the BSM warning light may not be visible.
- If the door window glass is tinted, it may affect the visibility of the BSM warning light, making it difficult to confirm the illumination of the light.

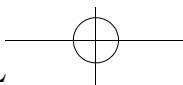

When Driving

## Blind Spot Monitoring (BSM) System

### ▼ BSM OFF Switch

When the BSM OFF switch is pressed, the BSM system turns off and the BSM OFF indicator light illuminates.

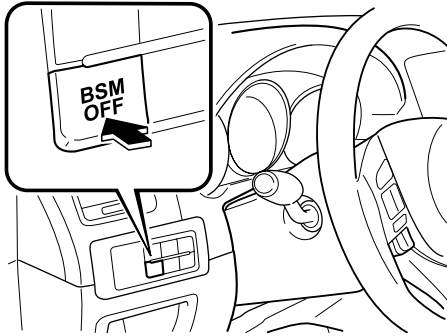

Press the BSM OFF switch again to turn on the BSM system. The BSM OFF indicator light turns off.

#### **NOTE**

- *The system may not operate normally when towing a trailer. Turn off the system by operating the BSM OFF switch when towing a trailer.*
- *If the ignition is switched off with the BSM system turned off, the system becomes operable automatically when the ignition is switched ON.*

### ▼ Care of Radar Sensors

The radar sensors are equipped inside the rear bumper.

Radar sensors

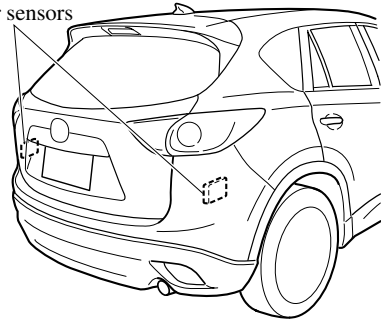

Always keep the bumper surface near the radar sensor area clean so that the BSM system operates normally. Refer to Exterior Care on page 6-55.

#### **NOTE**

- *The BSM OFF indicator light flashes if the radar sensors cannot operate normally. If the light remains flashing after cleaning the bumper surface near the radar sensor area, consult an Authorized Mazda Dealer.*
- *For repairs or paintwork around the radar sensors, or replacement of the bumper, consult an Authorized Mazda Dealer.*

When Driving

## Rear View Monitor

### Rear View Monitor\*

The rear view monitor is a visual assist system when reversing the vehicle that provides images from the rear of the vehicle.

#### **WARNING**

***Always drive carefully confirming the safety of the rear and the surrounding conditions by looking directly with your eyes:***

*Reversing the vehicle by only looking at the screen is dangerous as it may cause an accident or a collision with an object. The rear view monitor is only a visual assist device when reversing the vehicle. The images on the screen may be different from the actual conditions.*

#### **CAUTION**

- *Do not use the rear view monitor under the following conditions: Using the rear view monitor under the following conditions is dangerous and could result in injury or vehicle damage or both.*
  - *Icy or snow-covered roads.*
  - *Tire chains or a temporary spare tire is installed.*
  - *The liftgate is not fully closed.*
  - *The vehicle is on a road incline.*
- *When the display is cold, images may course across the monitor or the screen and may be dimmer than usual, which could cause difficulty in confirming the surrounding conditions of the vehicle. Always drive carefully confirming the safety of the rear and the surrounding conditions by looking directly with your eyes.*
- *Do not apply excessive force to the camera. The camera position and angle may deviate.*
- *Do not disassemble, modify, or remove it as it may no longer be waterproof.*
- *The camera cover is made of plastic. Do not apply degreasing agents, organic solvents, wax, or glass coating agents to the camera cover. If any are spilled on the cover, wipe off with a soft cloth immediately.*
- *Do not rub the cover excessively, or polish it using an abrasive compound or a hard brush. The cover may be damaged affecting the image.*



When Driving  
**Rear View Monitor**

---

**NOTE**

- If water, snow, or mud is stuck on the camera lens, wipe it off using a soft cloth. If it cannot be wiped off, use a mild detergent.
- If the camera temperature changes rapidly (Hot to cold, cold to hot), the rear view monitor may not operate correctly.
- When replacing the tires, consult an Authorized Mazda Dealer. Replacing the tires could result in deviation of the guide lines which appear on the display.
- If the vehicle's front, side, or rear has been involved in a collision, the alignment of the rear view parking camera (location, installation angle) may have deviated. Always consult an Authorized Mazda Dealer to have the vehicle inspected.

▼ **Rear View Parking Camera Location**

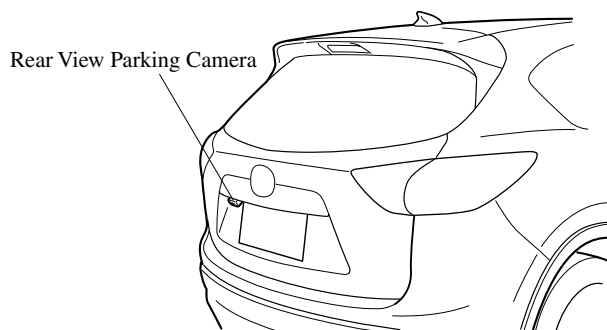

▼ **Switching to the Rear View Monitor Display**

Shift the shift lever to R with the ignition switched ON to switch the display to the rear view monitor display.

**NOTE**

When the shift lever is shifted from R to another shift lever position, the screen returns to the previous display.

When Driving

## Rear View Monitor

### ▼ Displayable Range on the Screen

The images on the screen may be different from the actual conditions.

(Screen display)

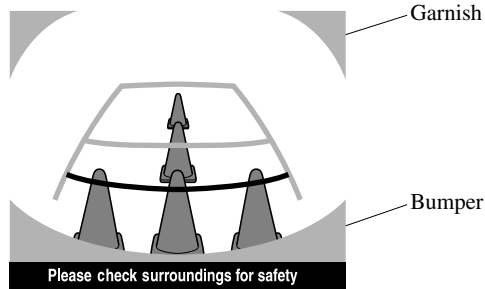

(Actual view)

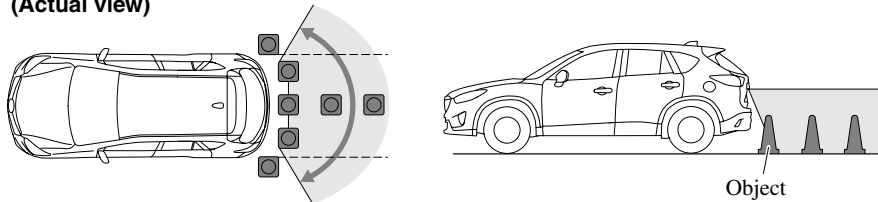

### NOTE

- The displayable range varies depending on the vehicle and road conditions.
- The displayable range is limited. Objects under the bumper or around the bumper ends cannot be displayed.
- The distance appearing in the displayed image is different from the actual distance because the rear view parking camera is equipped with a specific lens.
- Some optionally installed vehicle accessories may be picked up by the camera. Do not install any optional parts that can interfere with the camera view, such as illuminating parts or parts made of reflective material.
- It may be difficult to see the display under the following conditions, however, it does not indicate a malfunction.
  - In darkened areas.
  - When the temperature around the lens is high/low.
  - When the camera is wet such as on a rainy day or during periods of high humidity.
  - When foreign material such as mud is stuck around the camera.
  - When the camera lens reflects sunlight or headlight beams.
- Image display may be delayed if the temperature around the camera is low.

4-80



## When Driving Rear View Monitor

### ▼ Viewing the Display

Guide lines which indicate the width of the vehicle (yellow) are displayed on the screen as a reference to the approximate width of the vehicle in comparison to the width of the parking space you are about to back into.

Use this display view for parking your vehicle in a parking space or garage.

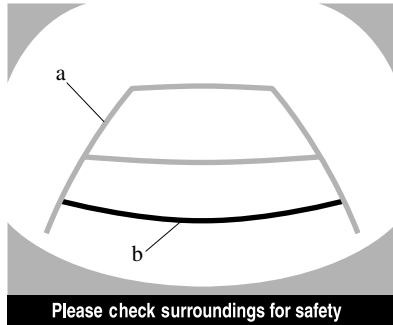

- a) Vehicle width guide lines (yellow)  
Guide lines serve as a reference to the approximate width of the vehicle.
- b) Distance guide lines  
These guide lines indicate the approximate distance to a point measured from the vehicle's rear (from the end of the bumper).  
The red and yellow lines indicate the points about 50 cm (red) and 1 meter (yellow) from the rear bumper (at the center point of each of the lines).

### **⚠ CAUTION**

*The guide lines on the screen are fixed lines. They are not synced to the driver's turning of the steering wheel. Always be careful and check the area to the vehicle's rear and the surrounding area directly with your eyes while backing up.*

### ▼ Rear View Monitor Operation

The operation of the rear view monitor when reversing the vehicle varies depending on the traffic, road, and vehicle conditions. The amount of steering and the timing also varies depending on conditions, so confirm the surrounding conditions directly with your eyes and steer the vehicle in accordance with the conditions.

Be well aware of the above cautions prior to using the rear view monitor.

#### **NOTE**

*Images displayed on the monitor from the rear view parking camera are reversed images (mirror images).*

1. Shift the shift lever to R to switch the display to the rear view monitor display.

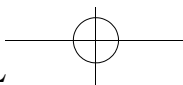

When Driving

## Rear View Monitor

---

2. Confirming the surrounding conditions, reverse the vehicle.

(Display condition)



(Vehicle condition)

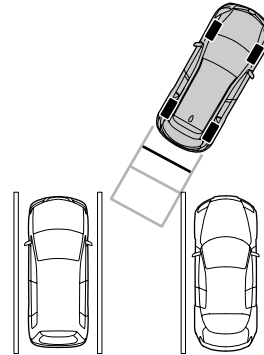

3. After your vehicle begins entering the parking space, continue backing up slowly so that the distance between the vehicle width lines and the sides of the parking space on the left and right are roughly equal.
4. Continue to adjust the steering wheel until the vehicle width guide lines are parallel to the left and right sides of the parking space.

When Driving  
**Rear View Monitor**

---

5. Once they are parallel, straighten the wheels and back your vehicle slowly into the parking space. Continue checking the vehicle's surroundings and then stop the vehicle in the best possible position. (If the parking space has division lines, check whether the vehicle width guide lines are parallel to them.)

**(Display condition)**

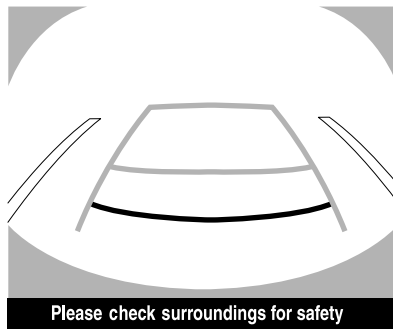

**(Vehicle condition)**

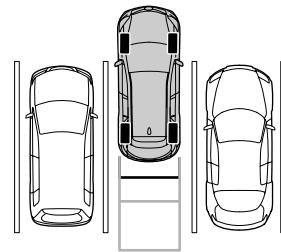

6. When the shift lever is shifted from R to another shift lever position, the screen returns to the previous display.

When Driving

## Rear View Monitor

---

### **NOTE**

*Because there may be a difference between the displayed image, such as indicated below, and the actual conditions when parking, always verify the safety at the rear of the vehicle and the surrounding area directly with your eyes.*

- *In the image of the parking space (or garage) displayed below, even though the back end and distance guide lines appear parallel in the monitor, they may not actually be parallel on the ground.*
- *When parking in a space with a division line on only one side of the parking space, the division line and the vehicle width guide line may appear parallel on the monitor, but they may not actually be parallel on the ground.*

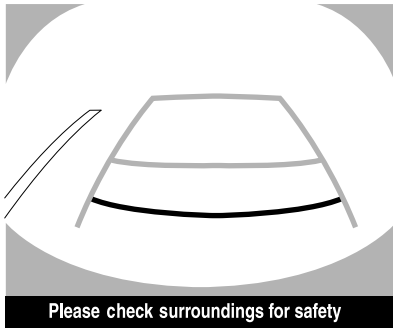



When Driving  
**Rear View Monitor**

---

▼ **Variance Between Actual Road Conditions and Displayed Image**

Some variance occurs between the actual road and the displayed road. Such variance in distance perspective could lead to an accident. Note the following conditions that may cause a variance in distance perspective.

**When the vehicle is tilted due to the weight of passengers and load**

When the vehicle rear is lowered, the object displayed on the screen appears farther than the actual distance.

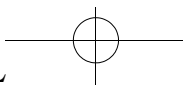
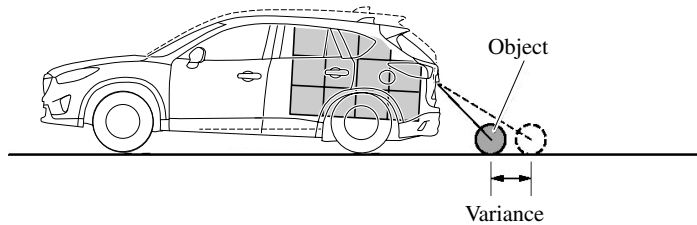

When Driving

## Rear View Monitor

### When there is a steep grade behind the vehicle

When there is a steep upgrade (downgrade) behind the vehicle, the object displayed on the screen appears farther (downgrade: closer) than the actual distance.

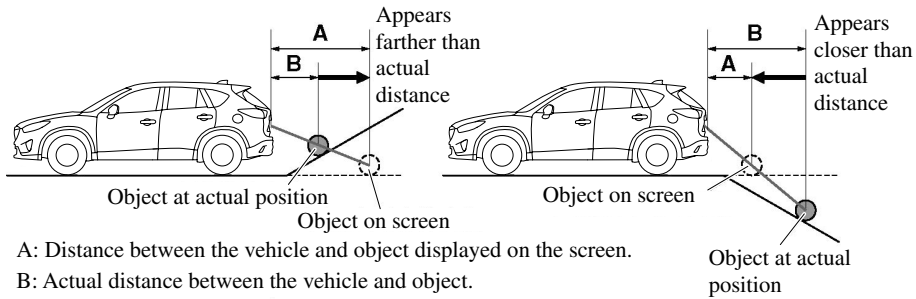



When Driving  
**Rear View Monitor**

**Three-dimensional object on vehicle rear**

Because the distance guide lines are displayed based on a flat surface, the distance to the three-dimensional object displayed on the screen is different from the actual distance.

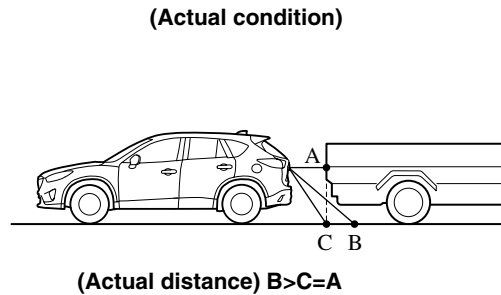
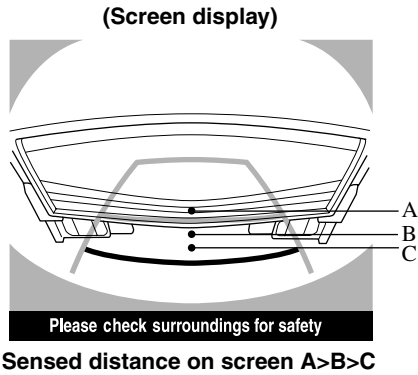

▼ **Picture Quality Adjustment**

**⚠ WARNING**

**Always adjust the picture quality of the rear view monitor while the vehicle is stopped:**

*Do not adjust the picture quality of the rear view monitor while driving the vehicle. Adjusting the picture quality of the rear view monitor such as brightness, contrast, color, and tint while driving the vehicle is dangerous as it could distract your attention from the vehicle operation which could lead to an accident.*

There are four settings which can be adjusted including, brightness, contrast, color, and tint. When adjusting, pay sufficient attention to the vehicle surroundings.

1. Press the setup button (**SETUP**) to display the picture quality adjustment screen.
2. Touch the **+** and **-** on-screen buttons to change the set value.

Touch the **Back** on-screen button to return to the camera image display.

**Reset**

All of the screen setting values can be reset to their initial settings.

1. Press the setup button (**SETUP**) to display the picture quality adjustment screen.

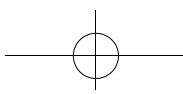

When Driving

## Rear View Monitor

---

2. Touch the  on-screen button.
3. Touch the  on-screen button.

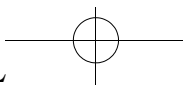

## 5 Interior Features

Use of various features for ride comfort, including air-conditioning and audio system.

<b>Climate Control System .....</b>	<b>5-2</b>
Operating Tips .....	5-2
Vent Operation .....	5-3
Manual Type .....	5-5
Fully Automatic Type .....	5-9
<b>Audio System .....</b>	<b>5-13</b>
Antenna * .....	5-13
Operating Tips for Audio System .....	5-13
Audio Set (Type A) .....	5-25
Audio Set (Type B) .....	5-35
Audio Control Switch Operation .....	5-56
AUX/USB/iPod mode * .....	5-58
<b>Bluetooth® .....</b>	<b>5-77</b>
Bluetooth® * .....	5-77
Bluetooth® Hands-Free .....	5-84
Bluetooth® Audio .....	5-89
Troubleshooting .....	5-93
<b>Interior Equipment .....</b>	<b>5-96</b>
Sunvisors .....	5-96
Interior Lights .....	5-97
Clock .....	5-99
Accessory Sockets .....	5-100
Cup Holder .....	5-102
Bottle Holder .....	5-103
Storage Compartments .....	5-103

\*Some models. **5-1**

Interior Features

## Climate Control System

### Operating Tips

- Operate the climate control system with the engine running.
  - To prevent the battery from being discharged, do not leave the fan control dial on for a long period of time with the ignition switched ON when the engine is not running.
  - Clear all obstructions such as leaves, snow and ice from the hood and the air inlet in the cowl grille to improve the system efficiency.
  - Use the climate control system to defog the windows and dehumidify the air.
  - The recirculate mode should be used when driving through tunnels or while in a traffic jam, or when you would like to shut off outside air for quick cooling of the interior.
  - Use the outside air mode for ventilation or windshield defrosting.
  - If the vehicle has been parked in direct sunlight during hot weather, open the windows to let warm air escape, then run the climate control system.
  - Run the air conditioner about 10 minutes at least once a month to keep internal parts lubricated.
- Have the air conditioner checked before the weather gets hot. Lack of refrigerant may make the air conditioner less efficient. The refrigerant specifications are indicated on a label attached to the inside of the engine compartment. Check the label before refilling the refrigerant. If the wrong type of refrigerant is used, it could result in a serious malfunction of the air conditioner. For details, consult an Authorized Mazda Dealer.

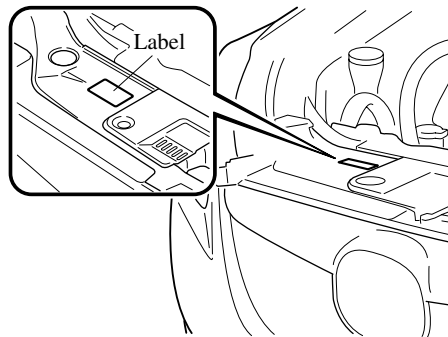

Interior Features  
**Climate Control System**

## Vent Operation

### ▼ Adjusting the Vents

#### **Directing airflow**

To adjust the direction of airflow, move the adjustment knob.

#### **NOTE**

*When using the air conditioner under humid ambient temperature conditions, the system may blow fog from the vents. This is not a sign of trouble but a result of humid air being suddenly cooled.*

#### **Side Vents**

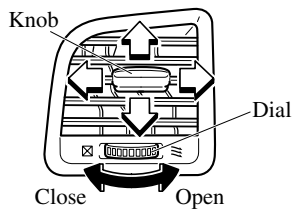

#### **Center Vents**

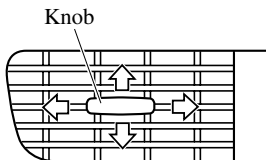

Interior Features

# Climate Control System

## ▼ Selecting the Airflow Mode

### Dashboard Vents

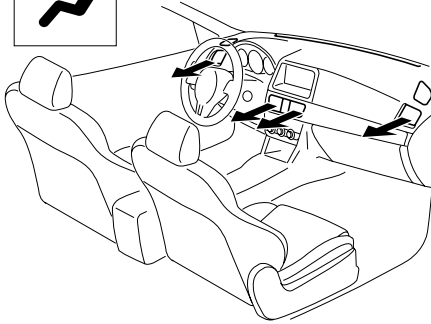

### Defroster and Floor Vents

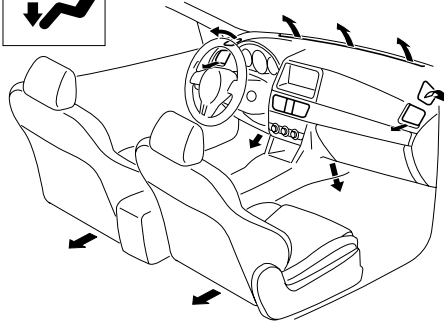

### Dashboard and Floor Vents

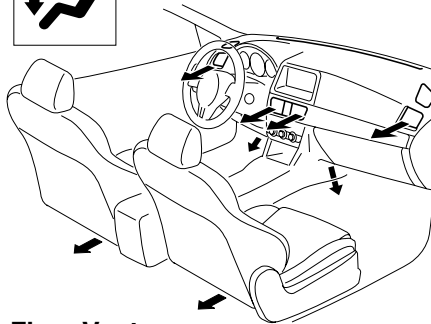

### Defroster Vents

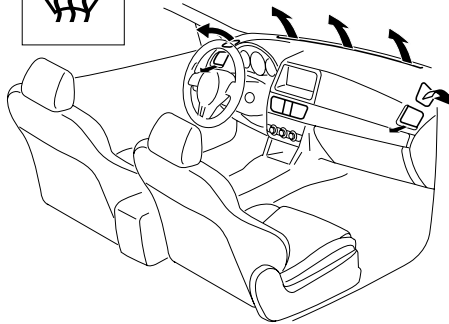

### Floor Vents

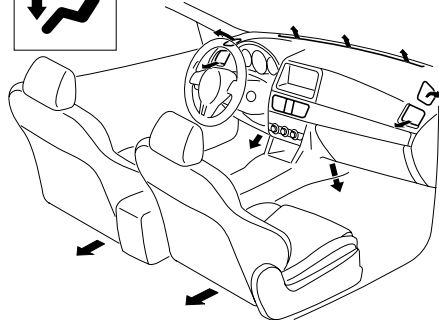

## Climate Control System

### Manual Type

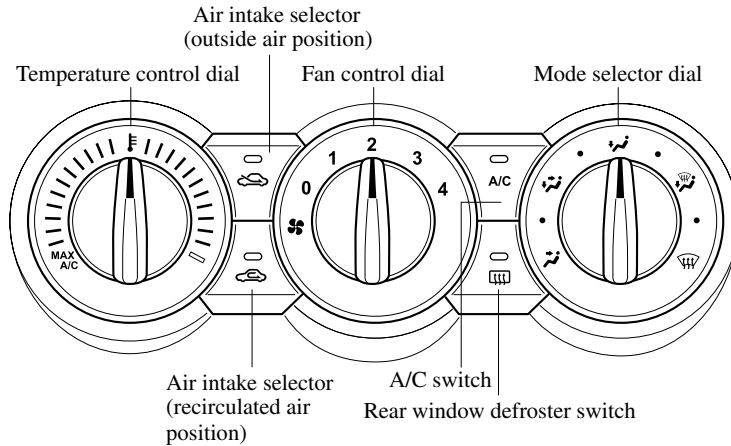

#### ▼ Control Switches

##### Temperature control dial

This dial controls temperature. Turn it clockwise for hot and counterclockwise for cold.

##### **NOTE**

When the mode is set to or with the fan control dial in a position other than 0 and the temperature control dial in the maximum cold position, the air intake selector switches to the recirculated air mode and the A/C turns on automatically.

If A/C is not desired, press the A/C switch to turn it off.

##### Fan control dial

This dial allows variable fan speeds.

- 0—Fan off
- 1—Low speed
- 2—Medium low speed
- 3—Medium high speed
- 4—High speed

##### Mode selector dial

Turn the mode selector dial to select airflow mode (page 5-4).

##### **NOTE**

- The mode selector dial can be set at the intermediate positions (●) between each mode. Set the dial to an intermediate position if you want to split the airflow between the two modes.
- For example, when the mode selector dial is at the ● position between the and positions, airflow from the floor vent is less than that of the position.

##### A/C switch

Press the A/C switch to turn the air conditioner on. The indicator light on the switch will illuminate when the fan control dial is set at position 1, 2, 3, or 4.

Press the switch once again to turn the air conditioner off.

Interior Features

## Climate Control System

### NOTE

The air conditioner may not function when the outside temperature approaches 0 °C (32 °F).

### Air intake selector

This switch controls the source of air entering the vehicle.

Press the air intake selector switch to alternate between the outside air and recirculated air modes.

### **Recirculated air mode** (🚗)

Outside air is shut off. Air within the vehicle is recirculated.

### **Outside air mode** (🚗)

Use this mode for ventilation or windshield defrosting.

### **⚠ WARNING**

**Do not use the recirculated air mode in cold or rainy weather:**

*Using the recirculated air mode in cold or rainy weather is dangerous as it will cause the windows to fog up. Your vision will be hampered, which could lead to a serious accident.*

### ▼ Heating

1. Set the mode selector dial to the 🚗 position.
2. Set the air intake selector to the outside air mode.
3. Set the temperature control dial to the hot position.
4. Set the fan control dial to the desired speed.
5. If dehumidified heating is desired, turn on the air conditioner.

### NOTE

- If the windshield fogs up easily, set the mode selector dial to the 🚗 position.
- If cooler air is desired at face level, set the mode selector dial at the 🚗 position and adjust the temperature control dial to maintain maximum comfort.
- The air to the floor is warmer than air to the face (except when the temperature control dial is set at the extreme hot or cold position).
- In the 🚗 or 🚗 position, the air conditioner is automatically turned on (however, the indicator light does not illuminate) and the outside air mode is automatically selected to defrost the windshield. In the 🚗 or 🚗 position, the outside air mode cannot be changed to the recirculated air mode.

### ▼ Cooling (With air conditioner)

1. Set the mode selector dial to the 🚗 position.
2. Set the temperature control dial to the cold position.
3. Set the fan control dial to the desired speed.
4. Turn on the air conditioner by pressing the A/C switch.
5. After cooling begins, adjust the fan control dial and temperature control dial as needed to maintain maximum comfort.



## Climate Control System

### **CAUTION**

*If the air conditioner is used while driving up long hills or in heavy traffic, monitor the engine coolant temperature warning light to see if it is illuminated or flashing (page 4-15). The air conditioner may cause engine overheating. If the warning light is illuminated or flashing, turn the air conditioning off (page 7-18).*

#### **NOTE**

- *When maximum cooling is desired, set the temperature control dial to the extreme cold position and set the air intake selector to the recirculated air mode, then set the fan control dial to position 4.*
- *If warmer air is desired at floor level, set the mode selector dial at the  position and adjust the temperature control dial to maintain maximum comfort.*
- *The air to the floor is warmer than air to the face (except when the temperature control dial is set at the extreme hot or cold position).*

#### **▼ Ventilation**



1. Set the mode selector dial to the  position.
2. Set the air intake selector to the outside air mode.
3. Set the temperature control dial to the desired position.
4. Set the fan control dial to the desired speed.

#### **▼ Windshield Defrosting and Defogging**





1. Set the mode selector dial to the  position.
2. Set the temperature control dial to the desired position.
3. Set the fan control dial to the desired speed.

### **WARNING**

**Do not defog the windshield using the  position with the temperature control set to the cold position:**

*Using the  position with the temperature control set to the cold position is dangerous as it will cause the outside of the windshield to fog up. Your vision will be hampered, which could lead to a serious accident. Set the temperature control to the hot or warm position when using the  position.*

#### **NOTE**

- *For maximum defrosting, turn on the air conditioner, set the temperature control dial to the extreme hot position, and the fan control dial to position 4.*
- *If warm air is desired at the floor, set the mode selector dial to the  position.*
- *In the  or  position, the air conditioner is automatically turned on (however, the indicator light does not illuminate) and the outside air mode is automatically selected to defrost the windshield. In the  or  position, the outside air mode cannot be changed to the recirculated air mode.*

Interior Features

## Climate Control System

---

### ▼ Dehumidifying (With air conditioner)

Operate the air conditioner in cool or cold weather to help defog the windshield and side windows.

1. Set the mode selector dial to the desired position.
2. Set the air intake selector to the outside air mode.
3. Set the temperature control dial to the desired position.
4. Set the fan control dial to the desired speed.
5. Turn on the air conditioner by pressing the A/C switch.

#### **NOTE**

*One of the functions of the air conditioner is dehumidifying the air and, to use this function, the temperature does not have to be set to cold. Therefore, set the temperature control dial to the desired position (hot or cold) and turn on the air conditioner when you want to dehumidify the cabin air.*

## Climate Control System

### Fully Automatic Type

Climate control information is displayed on the display.

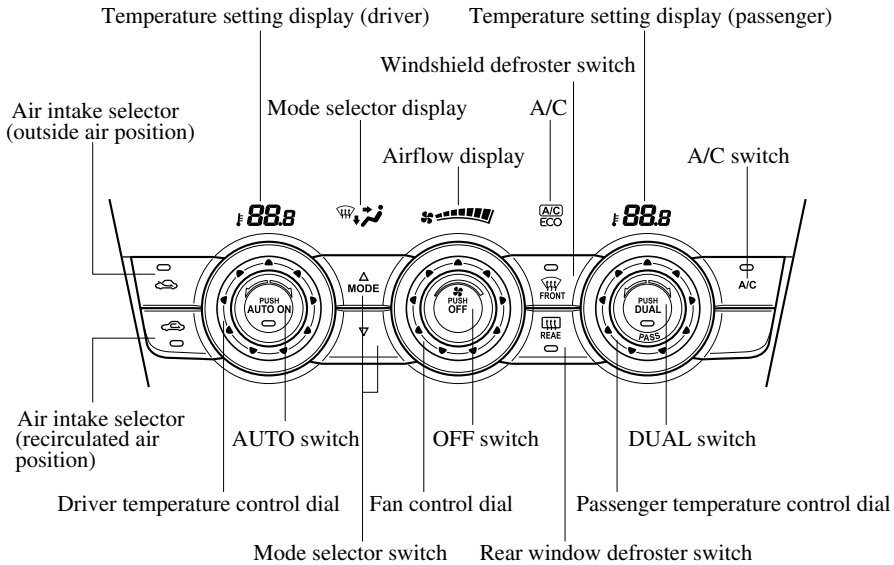

#### ▼ Control Switches

##### AUTO switch

By pressing the AUTO switch the following functions will be automatically controlled in accordance with the selected set temperature:

- Airflow temperature
- Amount of airflow
- Selection of airflow mode
- Outside/Recirculated air selection
- Air conditioner operation

#### **NOTE**

*AUTO switch indicator light*

- When on, it indicates auto operation, and the system will function automatically.
- If any of the following dials or switches are operated while in auto control, the AUTO switch indicator turns off.
  - Mode selector switch
  - Fan control dial
  - Windshield defroster switch

*The functions for dials and switches other than those operated in the above continue to operate in auto control.*

##### OFF switch

Pressing the OFF switch shuts off the climate control system.

Interior Features

## Climate Control System

### Temperature control dial

This dial controls temperature. Turn it clockwise for hot and counterclockwise for cold.

- When the DUAL switch is off:  
Turn the driver temperature control dial to control the temperature throughout the entire cabin.
- When the DUAL switch is on:  
Turn the driver or front passenger temperature control dial to independently control the temperature on each side of the cabin.

#### **NOTE**

The system changes to the individual operation mode (DUAL switch indicator light illuminated) by turning the front passenger temperature control dial even when the DUAL switch is off, which allows individual control of the set temperature for the driver and front passenger.







### Fan control dial

The fan has seven speeds. The selected speed will be displayed.

### Mode selector switch

The desired airflow mode can be selected (page 5-4).

#### **NOTE**

- With the airflow mode set to the  position and the temperature control dial set at a medium temperature, heated air is directed to the feet and air at a comparably lower temperature will flow through the central, left and right vents.
- To set the air vent to , press the windshield defroster switch.
- In the  or  position, the air conditioner is automatically turned on and the outside air mode is automatically selected to defrost the windshield. In the  or  position, the outside air mode cannot be changed to the recirculated air mode.

### A/C switch

Pressing the A/C switch while the AUTO switch is turned on will turn off the air conditioning (cooling/dehumidifying functions).

The air conditioning can be turned on and off by pressing the A/C switch while the fan control dial is on.

#### **NOTE**

- The air conditioning operates when the A/C switch is pressed even if the fan is off.
- The air conditioner may not function when the outside temperature approaches 0 °C (32 °F). (Indicator light remains on even when system is off.)

### Air intake selector

Outside or recirculated air positions can be selected. Press the switch to select outside/recirculated air positions.

#### **Recirculated air position** ()

Use this position when going through tunnels, driving in congested traffic (high engine exhaust areas) or when quick cooling is desired.

## Climate Control System

### Outside air position (↔ )

Use this mode for ventilation or windshield defrosting.

### **! WARNING**

**Do not use the ↔ position in cold or rainy weather:**

*Using the ↔ position in cold or rainy weather is dangerous as it will cause the windows to fog up. Your vision will be hampered, which could lead to a serious accident.*

### **DUAL switch**

Use the DUAL switch to change the mode between the individual operation (driver and passenger) and interconnection (simultaneous) modes.

### **Individual operation mode (indicator light illuminated)**

The set temperature can be controlled individually for the driver and front passenger.

### **Interconnection mode (indicator light turned off)**

The set temperature for the driver and front passenger is controlled simultaneously.

### **Windshield defroster switch**

Press the switch to defrost the windshield and front door windows.

### ▼ **Operation of Automatic Air Conditioning**

1. Press the AUTO switch. Selection of the airflow mode, air intake selector and amount of airflow will be automatically controlled.
2. Use the temperature control dial to select a desired temperature. Press the DUAL switch or turn the front passenger temperature control dial to control the set temperature individually for the driver and front passenger.

To turn off the system, press the OFF switch.

### **NOTE**

- *Setting the temperature to maximum high or low will not provide the desired temperature at a faster rate.*
- *When selecting heat, the system will restrict airflow until it has warmed to prevent cold air from blowing out of the vents.*

### ▼ **Windshield Defrosting and Defogging**

Press the windshield defroster switch. In this position, the outside air position is automatically selected, and the air conditioner automatically turns on. The air conditioner will directly dehumidify the air to the front windshield and side windows (page 5-4). Airflow amount will be increased.

Interior Features

## Climate Control System

### **⚠ WARNING**

**Set the temperature control to the hot or warm position when defogging (☞ position):**

*Using the ☞ position with the temperature control set to the cold position is dangerous as it will cause the outside of the windshield to fog up. Your vision will be hampered, which could lead to a serious accident.*

### **NOTE**

*Use the temperature control dial to increase the air flow temperature and defog the windshield more quickly.*

### **▼ Sunlight/Temperature Sensor**

The fully automatic air conditioner function measures inside and outside temperatures, and sunlight. It then sets temperatures inside the passenger compartment accordingly.

### **⚠ CAUTION**

*Do not obstruct either sensor, otherwise the automatic air conditioner will not operate properly.*

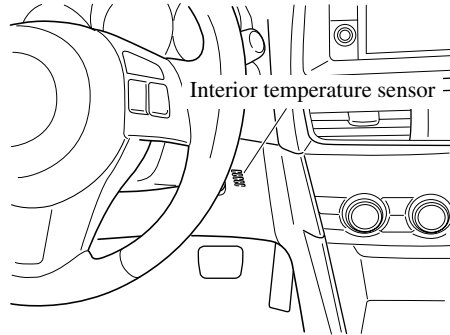
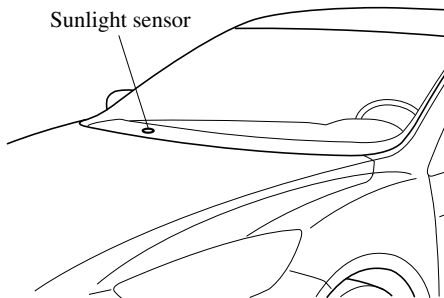

Interior Features  
**Audio System**

### Antenna \*

#### ▼ Type A

The antenna is incorporated into the window glass.

#### **CAUTION**

*When washing the inside of the window which has an antenna, use a soft cloth dampened in lukewarm water, gently wiping the antenna lines.*

*Use of glass cleaning products could damage the antenna.*

#### ▼ Type B

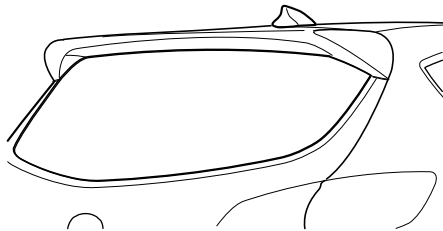

### Operating Tips for Audio System

#### **WARNING**

**Always adjust the audio while the vehicle is stopped:**

*Do not adjust the audio control switches while driving the vehicle. Adjusting the audio while driving the vehicle is dangerous as it could distract your attention from the vehicle operation which could lead to a serious accident.*

*Even if the audio control switches are equipped on the steering wheel, learn to use the switches without looking down at them so that you can keep your maximum attention on the road while driving the vehicle.*

#### **CAUTION**

*For the purposes of safe driving, adjust the audio volume to a level that allows you to hear sounds outside of the vehicle including car horns and particularly emergency vehicle sirens.*

#### **NOTE**

- To prevent the battery from being discharged, do not leave the audio system on for a long period of time when the engine is not running.*
- If a cellular phone or CB radio is used in or near the vehicle, it could cause noise to occur from the audio system, however, this does not indicate that the system has been damaged.*

Interior Features

## Audio System

Do not spill any liquid on the audio system.

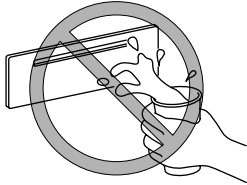

Do not insert any objects, other than CDs, into the slot.

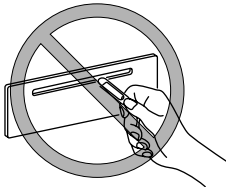

### ▼ Radio Reception

#### AM characteristics

AM signals bend around such things as buildings or mountains and bounce off the ionosphere.

Therefore, they can reach longer distances than FM signals.

Because of this, two stations may sometimes be picked up on the same frequency at the same time.

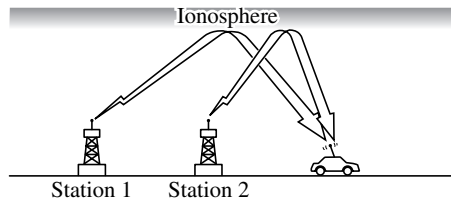

#### FM characteristics

An FM broadcast range is usually about 40—50 km (25—30 miles) from the source. Because of extra coding needed to break the sound into two channels, stereo FM has even less range than monaural (non-stereo) FM.

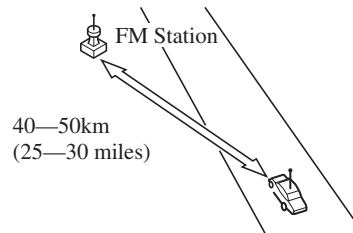

Signals from an FM transmitter are similar to beams of light because they do not bend around corners, but they do reflect. Unlike AM signals, FM signals cannot travel beyond the horizon. Therefore, FM stations cannot be received at the great distances possible with AM reception.

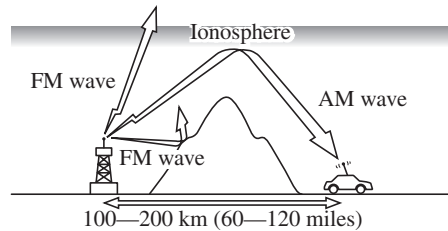

Atmospheric conditions can also affect FM reception. High humidity will cause poor reception. However, cloudy days may provide better reception than clear days.



## Interior Features Audio System

### Multipath noise

Since FM signals can be reflected by obstructions, it is possible to receive both the direct signal and the reflected signal at the same time. This causes a slight delay in reception and may be heard as a broken sound or a distortion. This problem may also be encountered when in close proximity to the transmitter.

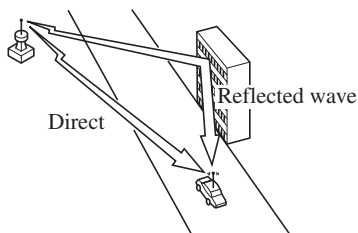

### Flutter/Skip noise

Signals from an FM transmitter move in straight lines and become weak in valleys between tall buildings, mountains, and other obstacles. When a vehicle passes through such an area, the reception conditions may change suddenly, resulting in annoying noise.

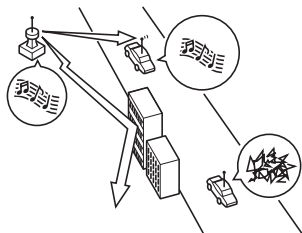

### Weak signal noise

In suburban areas, broadcast signals become weak because of distance from the transmitter. Reception in such fringe areas is characterized by sound breakup.



### Strong signal noise

This occurs very close to a transmitter tower. The broadcast signals are extremely strong, so the result is noise and sound breakup at the radio receiver.

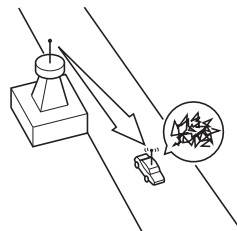

### Station drift noise

When a vehicle reaches the area of two strong stations broadcasting at similar frequencies, the original station may be temporarily lost and the second station picked up. At this time there will be some noise from this disturbance.

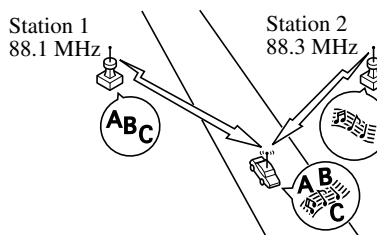

Interior Features

## Audio System

### ▼ Operating Tips for CD Player

#### Condensation phenomenon

Immediately after turning on the heater when the vehicle is cold, the CD or optical components (prism and lens) in the CD player may become clouded with condensation. At this time, the CD will eject immediately when placed in the unit. A clouded CD can be corrected simply by wiping it with a soft cloth. Clouded optical components will clear naturally in about an hour. Wait for normal operation to return before attempting to use the unit.

#### Handling the CD player

The following precautions should be observed.

- The CD revolves at high speed within the unit. Defective (cracked or badly bent) CDs should never be used.

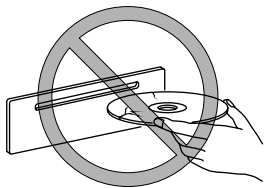

- Do not use non-conventional discs such as heart-shaped, octagonal discs, etc. The disc may not eject resulting in a malfunction.

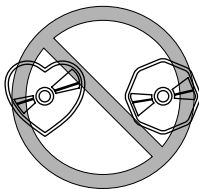

- If the memory portion of the CD is transparent or translucent, do not use the disc.

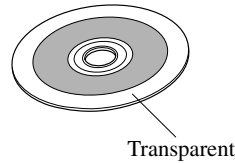

- A new CD may have rough edges on its inner and outer perimeters. If a disc with rough edges is used, proper setting will not be possible and the CD player will not play the CD. In addition, the disc may not eject resulting in a malfunction. Remove the rough edges in advance by using a ball-point pen or pencil as shown below. To remove the rough edges, rub the side of the pen or pencil against the inner and outer perimeter of the CD.

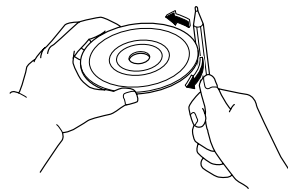

- When driving over uneven surfaces, the sound may jump.

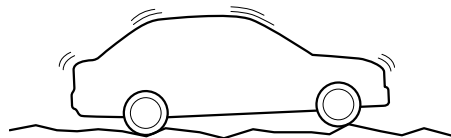

## Interior Features Audio System

- The CD player has been designed to play CDs bearing the identification logo as shown below. No other discs can be played.



- Use discs that have been legitimately produced. If illegally-copied discs such as pirated discs are used, the system may not operate properly.
- Be sure never to touch the signal surface when handling the CDs. Pick up a CD by grasping the outer edge or the edge of the hole and the outer edge.

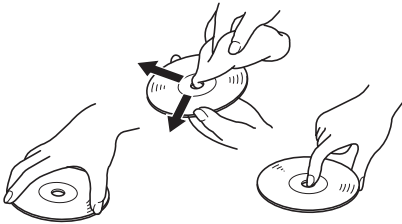

- Do not stick paper or tape on the CD. Avoid scratching the reverse side (the side without a label). The disc may not eject resulting in a malfunction.
- Dust, finger smudges, and dirt can decrease the amount of light reflected from the signal surface, thus affecting sound quality. If the CD should become soiled, gently wipe it with a soft cloth from the center of the CD to the edge.

- Do not use record sprays, antistatic agents, or household spray cleaners. Volatile chemicals such as benzine and thinner can also damage the surface of the CD and must not be used. Anything that can damage, warp, or fog plastic should never be used to clean CDs.
- Insert discs one by one. If two discs are inserted at the same time, the system may not operate properly.
- The CD player ejects the CD if the CD is inserted upside down. Also dirty and/or defective CDs may be ejected.
- Do not insert cleaning discs in the CD player.
- Do not insert any disc with a peel-off seal affixed to it.
- This unit may not be able to play certain CD-R/CD-RWs made using a computer or music CD recorder due to disc characteristics, scratches, smudges, dirt, etc., or due to dust or condensation on the lens inside the unit.
- Storing CDs in the vehicle exposed to direct sunlight or high temperature may damage the CD-R/CD-RWs, and make them unplayable.
- CD-R/CD-RW exceeding 700 MB cannot be played.
- This unit may not be able to play certain discs made using a computer due to the application (writing software) setting used. (For details, consult the store where the application was purchased.)
- It is possible that certain text data, such as titles, recorded on a CD-R/CD-RW may not be displayed when musical data (CD-DA) is playing.
- The period from when a CD-RW is inserted to when it begins playing is longer than a normal CD or CD-R.

Interior Features

## Audio System

- Completely read the instruction manual and cautions for CD-R/CD-RWs.
- Do not use discs with cellophane tape adhering, partially peeled off labels, or adhesive material exuding from the edges of the CD label. Also, do not use discs with a commercially-available CD-R label affixed. The disc may not eject resulting in a malfunction.

### ▼ Operating Tips for MP3

#### **NOTE**

*Supply of this product only conveys a license for private, non-commercial use and does not convey a license nor imply any right to use this product in any commercial (i.e. revenue-generating) real time broadcasting (terrestrial, satellite, cable and/or any other media), broadcasting/streaming via the Internet, intranets and/or other networks or in other electronic content distribution systems, such as pay-audio or audio-on-demand applications. An independent license for such use is required. For details, please visit <http://www.mp3licensing.com>.*

- This audio system handles MP3 files that have been recorded on CD-R/CD-RW/CD-ROMs. Discs that have been recorded using the following formats can be played:
  - ISO 9660 level 1
  - ISO 9660 level 2
  - Joliet extended format
  - Romeo extended format
- This unit handles MP3 files conforming to the MP3 format containing both header frames and data frames.
- This unit can play multi-session recorded discs that have up to 50 sessions.

- This unit can play MP3s with sampling frequencies of 8/11.025/12/16/22.05/24/32/44.1/48 kHz.
- This unit can play MP3 files that have been recorded in bit rates of 8 kbps to 320 kbps. Nonetheless, to insure enjoyment of music with consistent sound quality, it is recommended to use discs that have been recorded at a bit rate of 128 kbps or more.
- If a disc has both music data (CD-DA) and MP3 files, playback of the two file types differs depending on how the disc was recorded.
- Packet written discs cannot be played on this unit.
- This unit does not play CDs recorded using MP3i (MP3 interactive), MP3 PRO and RIFF MP3 formats.

#### **About folders and files**

- The order of hierarchy for MP3 files and folders during playback or other functions is from shallow to deep. The arrangement and playing order of a recorded disc containing MP3 files is as follows:
  - **File number**  
A numerical file number is assigned to each file in a folder starting from the deepest hierarchy.
  - **Folder number**  
A numerical folder number is assigned to each folder starting from the deepest hierarchy.

#### **NOTE**

*Folders and tracks (files) within the same hierarchy play in the order they were written to the disc depending on the write software.*

Interior Features  
**Audio System**

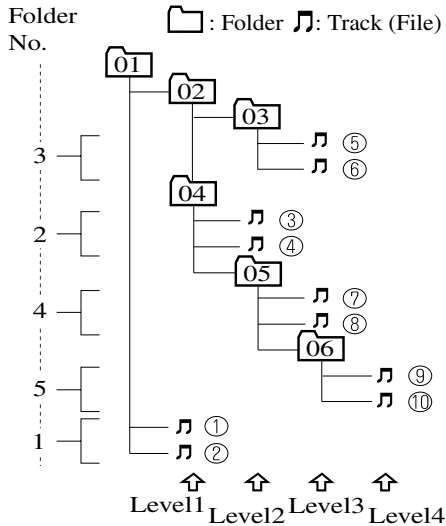

Playback may not occur in the above hierarchy depending on the audio unit.

- The folder order is automatically assigned and this order cannot be optionally set.
- Any folder without an MP3 file will be ignored. (It will be skipped and the folder number will not be displayed.)
- MP3 files not conforming to the MP3 format containing both header frames and data frames will be skipped and not played.
- This unit will play MP3 files that have up to eight levels. However, the more levels a disc has, the longer it will take to initially start playing. It is recommended to record discs with two levels or less.
- A single disc with up to 512 files can be played and a single folder with up to 255 files can be played.
- When naming an MP3 file, be sure to add an MP3 file extension (.mp3) after the file name.

- The number of characters which can be displayed is restricted.

**CAUTION**

*This unit can only play MP3 files that have an MP3 file extension (.mp3) attached. Do not attach an MP3 file extension to any other type file as it could cause noise to be emitted or a malfunction in the unit.*

**About ID3 Tag display**

- This unit can only display ID3 Tag album, track and artist names that have been input using Ver.1.0/1.1/2.2/2.3/2.4 formats. Any other data that may have been input cannot be displayed.
- This unit cannot display some characters. Characters which cannot be displayed are indicated by an asterisk (\*).

**Specialized glossary**

**MP3**

Abbreviation for “MPEG Audio Layer 3”. A technical standard for audio compression as decided by the ISO\*1 MPEG working group. Use of MP3 allows for audio data to be compressed to approximately a tenth of the source data size.

\*1 International Organization for Standardization

**ISO 9660**

An international standard for logical formatting of CD-ROM files and folders. It is divided into three separate levels based on differences in file naming procedures, data configuration and other characteristics.

Interior Features

## Audio System

### Multi-session

A session is the complete amount of data recorded from the beginning to the end of a single period of CD-ROM, CD-R/CD-RW data recording. Multi-session refers to the existence of data from two or more sessions on a single disc.

### Sampling

Refers to the process of encoding analog audio data at regular intervals and converting it to digital data. The sampling rate refers to the number of times a sample is taken in one second and is expressed in Hz units. Increasing the sampling rate improves the sound quality but also increases the data size.

### Bit rate

Refers to the volume of data per second, expressed in bps (bits per second). Generally, the larger the number of the transfer bit rate when compressing an MP3 file, the more information regarding musical reproduction it carries, and therefore the better the sound quality.

### Packet writing

A general term for the method, similar to that used for floppy discs or hard drives, of recording the required file in a single increment on a CD-R and similar.

### ID3 Tag

ID3 tag is a method for storing information related to the music in an MP3 file. Information such as track, artist and album name can be stored. This content can be freely edited using ID3 editing function software.

### VBR

Abbreviation for Variable Bit Rate. While CBR (Constant Bit Rate) is generally used, VBR varies the bit rate for audio compression according to compression conditions and this allows for compression with preference given to sound quality.

### ▼ Operating Tips for WMA

WMA is short for Windows Media Audio and is the audio compression format used by Microsoft.

Audio data can be created and stored at a higher compression ratio than MP3.

\* Microsoft and Windows Media are registered trademarks of Microsoft Corporation U.S. in the United States and other countries.

Item	Content
Specification	Windows Media Audio Version 7.0, 8.0, 9.0, 10.0
Sampling frequency	32 kHz. . . . . 32, 40, 48 kbps
	44.1 kHz. . . . . 32, 48, 64, 80, 96, 128, 160, 192, 256, 320 kbps
Bit rate	48 kHz. . . . . 64, 96, 128, 160, 192 kbps
VBR (Variable Bit Rate)	Supported
Channel mode	Stereo/Monaural
WMA tag	Title, artist name, album name

Interior Features  
**Audio System**

**CAUTION**

*This unit plays files with the (.wma) file extension as a WMA file. Do not use the WMA file extension for files other than WMA files. Otherwise, it could result in noise or a malfunction.*

- Track, artist and album name information is recorded as data termed “WMA-Tag”, and this information is displayable.
- WMA files written under specifications other than the indicated specification may not play normally or files or folder names may not display correctly.
- The file extension may not be provided depending on the computer operating system, version, software, or settings. In this case, add the file extension “.wma” to the end of the file name, and then write it to the disc.

**▼ Operating Tips for AAC**

AAC stands for Advanced Audio Coding, which is standardized voice compression established by the ISO\*1 working group (MPEG). Audio data can be created and stored at a higher compression ratio than MP3.

\*1 International Organization for Standardization

**Playable AAC file specifications**

This unit supports playback of AAC files recorded in CD-R and CD-RW.

Playable AAC files are as follows:

Item	Content
Specification	MPEG-4AAC
Sampling rate	8/11.025/12 kHz (Quarter rate) 16/22.05/24 kHz (Half rate) 32/44.1/48 kHz (Full rate)
Bit rate	24 kbps—320 kbps
VBR (Variable Bit Rate)	Supported
iTunes, m4a, Meta-Data applicable	Song title Artist name Album name

**CAUTION**

*This unit plays files with the file extension (m4a) as a AAC file. Do not use the AAC file extension for files other than AAC files. Otherwise, it could result in noise or a malfunction.*

- Song, artist, and album name information in the AAC file is recorded as data termed “iTunes, m4a, Meta-Data applicable”, and this information is displayable.
- AAC files written under specifications other than the indicated specification may not play normally or files or folder names may not display correctly.
- The file extension may not be provided depending on the computer operating system, version, software, or settings. In this case, add the file extension “.m4a” to the end of the file name, then write it to the disc.

Interior Features

## Audio System

### ▼ Operating Tips for USB memory

This unit supports playback of MP3/WMA/AAC files recorded to USB memory.

#### Playable MP3 file specifications

Playable MP3 files are as follows:

Item	Content
Specification	MPEG1 AUDIO LAYER III
	MPEG2 AUDIO LAYER III
	MPEG2.5
Sampling rate	44.1/48/32 kHz (MPEG1)
	22.05/24/16 kHz (MPEG2)
	11.025/12/8 kHz (MPEG2.5)
Bit rate	32—320 kbps (MPEG1)
	8—160 kbps (MPEG2)
	8—160 kbps (MPEG2.5)

#### **⚠ CAUTION**

*This unit plays files with the file extension (mp3) as an MP3 file. Do not use the MP3 file extension for files other than MP3 files. Otherwise, it could result in noise or a malfunction.*

- MP3 files written under specifications other than the indicated specification may not play normally or files or folder names may not display correctly.
- The file extension may not be provided depending on the computer operating system, version, software, or settings. In this case, add the file extension “.mp3” to the end of the file name, and then write it to the memory.

#### Playable WMA file specification

Playable WMA files are as follows:

Item	Content
Specification	Windows Media Audio Version 9.0
Sampling rate	22.05 kHz (MID) 44.1/48/32 kHz (HI)
Bit rate	32—320 kbps

#### **⚠ CAUTION**

*This unit plays files with the file extension (wma) as a WMA file. Do not use the WMA file extension for files other than WMA files. Otherwise, it could result in noise or a malfunction.*

- WMA files written under specifications other than the indicated specification may not play normally or files or folder names may not display correctly.
- The file extension may not be provided depending on the computer operating system, version, software, or settings. In this case, add the file extension “.wma” to the end of the file name, and then write it to the memory.

#### Playable AAC file specification

Playable AAC files are as follows:

Item	Content
Specification	MPEG4 AAC-LC MP4FF
Sampling rate	11.025 kHz 16/22.05/24 kHz 32/44.1/48 kHz
Bit rate	16—320 kbps



Interior Features  
**Audio System**

**CAUTION**

*This unit plays files with the file extension (.aac<sup>\*1</sup>/.m4a) as a AAC file. Do not use the AAC file extension for files other than AAC files. Otherwise, it could result in noise or a malfunction.*

**\*1 Type B**

*Refer to Audio Set (Type B) on page 5-35.*

- AAC files written under specifications other than the indicated specification may not play normally or files or folder names may not display correctly.
- The file extension may not be provided depending on the computer operating system, version, software, or settings. In this case, add the file extension “.aac<sup>\*1</sup>” or “.m4a” to the end of the file name, and then write it to the memory.

**\*1 Type B**

*Refer to Audio Set (Type B) on page 5-35.*

**▼ Operating Tips for iPod**

“iPod” is a registered trademark of Apple Inc. in the United States and other countries.

This unit supports playback of music files recorded to an iPod.

- “iPod” is a registered trademark of Apple Inc. in the United States and other countries.
- “iPod classic” is a registered trademark of Apple Inc. in the United States and other countries.
- “iPod nano” is a registered trademark of Apple Inc. in the United States and other countries.

- “iPod touch” is a registered trademark of Apple Inc. in the United States and other countries.
- “iPhone” is a registered trademark of Apple Inc. in the United States and other countries.

Connectable iPods are as follows:

- iPod: 5G
- iPod classic
- iPod nano: 1/2/3/4/5G
- iPod touch<sup>\*1</sup>: 1/2G
- iPhone<sup>\*1</sup>: 3G/3GS

**\*1 Only iPod function**

Interior Features

## Audio System

---

### CAUTION

- *Remove the iPod when it is not in use. Because the iPod is not designed to withstand excessive changes in temperature inside the cabin, it could be damaged or the battery may deteriorate due to the excessive temperature or humidity inside the cabin if it is left in the vehicle.*
- *If data in the iPod is lost while it is connected to the unit, Mazda cannot guarantee recovery of any lost data.*
- *If the iPod battery is deteriorated, the iPod may not recharge and playback may not be possible when it is connected to the unit. Replace the iPod battery immediately.*
- *Be careful not to pinch the iPod connecting cable when opening/closing the glove compartment.*
- *For the details on using the iPod, refer to the iPod instruction manual.*
- *When connecting the iPod to a USB port, all commands are made from the audio unit. Control on the iPod side is impossible.*

### NOTE

- *This unit cannot display the images and video in an iPod.*
- *The iPod functions on the iPod cannot be operated while it is connected to the USB port because the audio unit controls the iPod functions.*

Interior Features  
**Audio System**

**Audio Set (Type A)**

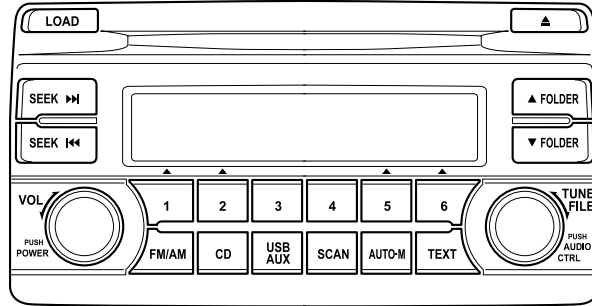

① Power/Volume/Sound Controls .....	page 5-26
② Operating the Radio .....	page 5-28
③ Operating the Compact Disc (CD) Player .....	page 5-30
④ How to use auxiliary jack/USB port .....	page 5-33
⑤ Error Indications .....	page 5-33

Interior Features

# Audio System

## ▼ Power/Volume/Sound Controls

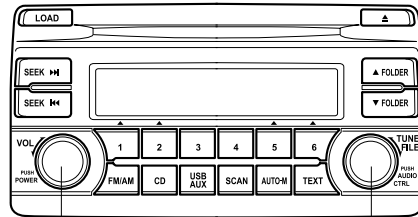

Power/Volume dial

Audio control dial

### Power ON/OFF

Switch the ignition to ACC or ON. Press the power/volume dial to turn the audio system on. Press the power/volume dial again to turn the audio system off.

### Volume adjustment

To adjust the volume, turn the power/volume dial. Turn the power/volume dial to the right to increase volume, to the left to decrease it.

### Audio sound adjustment

1. Press the audio control dial to select the function. The selected function will be indicated.

2. Turn the audio control dial to adjust the selected functions as follows:

Indication	Setting value	
	Turn Left	Turn Right
<b>ALC</b> (Automatic volume adjustment)	Level decrease	Level increase
<b>BASS</b> (Low pitch sound)	Decrease bass	Increase bass
<b>TREB</b> (Treble sound)	Decrease treble	Increase treble
<b>FADE</b> (Front/back volume balance)	Shift the sound to the front	Shift the sound to the rear
<b>BAL</b> (Left/right volume balance)	Shift the sound to the left	Shift the sound to the right
<b>BEEP</b> (Audio operation sound)	Off	On

### **NOTE**

About 5 seconds after selecting any mode, the volume function will be automatically selected. To reset bass, treble, fade, and balance, press the audio control dial for 2 seconds. The unit will beep and "CLEAR" will be displayed.



Interior Features  
**Audio System**

---

**Automatic Level Control (ALC)**

The automatic level control (ALC) changes the audio volume/quality automatically according to the vehicle speed. The faster the vehicle speed, the higher the volume increases. ALC has ALC OFF and ALC LEVEL 1 to 7 modes. At ALC LEVEL 7, the amount that the volume can increase is at the maximum. Select the mode according to the driving conditions.

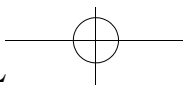

Interior Features

## Audio System

### ▼ Operating the Radio

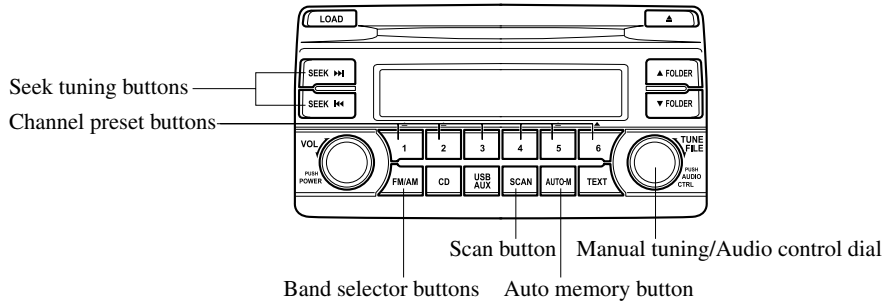

#### **Radio ON**

Press a band selector button (**FM/AM**) to turn the radio on.

#### **Band selection**

Successively pressing the band selector button (**FM/AM**) switches the bands as follows: FM1→FM2→AM.

The selected mode will be indicated. If FM stereo is being received, "ST" will be displayed.

#### **NOTE**

*If the FM broadcast signal becomes weak, reception automatically changes from STEREO to MONO for reduced noise, and the "ST" indicator will go out.*

#### **Tuning**

The radio has the following tuning methods: Manual, Seek, Scan, Preset channel, and Auto memory tuning. The easiest way to tune stations is to set them on preset channels.

#### **NOTE**

*If the power supply is interrupted (fuse blows or the battery is disconnected), the preset channels will be erased.*

#### **Manual tuning**

Turning the manual tuning dial will change the frequency higher or lower.

#### **Seek tuning**

Pressing the seek tuning button (**►►**, **◀◀**) will cause the tuner to seek a higher or lower frequency automatically.

#### **NOTE**

*If you continue to press and hold the seek tuning button (**►►**, **◀◀**), the frequency will continue changing without stopping.*

#### **Scan tuning**

Press the scan button (**SCAN**) to automatically sample strong stations. Scanning stops at each station for about 5 seconds. To hold a station, press the scan button (**SCAN**) again during this interval.

#### **Preset channel tuning**

The 6 preset channels can be used to store 6 AM and 12 FM stations.

1. To set a channel first select AM, FM1, or FM2. Tune to the desired station.

Interior Features  
**Audio System**

---

2. Depress a channel preset button for about 2 seconds until a beep is heard. The preset channel number or station frequency will be displayed. The station is now held in the memory.
3. Repeat this operation for the other stations and bands you want to store. To tune one in the memory, select AM, FM1, or FM2 and then press its channel preset button. The station frequency or the channel number will be displayed.

**Auto memory tuning**

This is especially useful when driving in an area where the local stations are not known.

Press and hold the auto memory button (**AUTO-M**) for about 2 seconds until a beep is heard; the system will automatically scan and temporarily store up to 6 stations with the strongest frequencies in each selected band in that area.

After scanning is completed, the station with the strongest frequency will be tuned and its frequency displayed. Press and release the auto memory button (**AUTO-M**) to recall stations from the auto-stored stations. One stored station will be selected each time; its frequency and channel number will be displayed.

**NOTE**

*If no stations can be tuned after scanning operations, "A" will be displayed.*

Interior Features

# Audio System

## ▼ Operating the Compact Disc (CD) Player

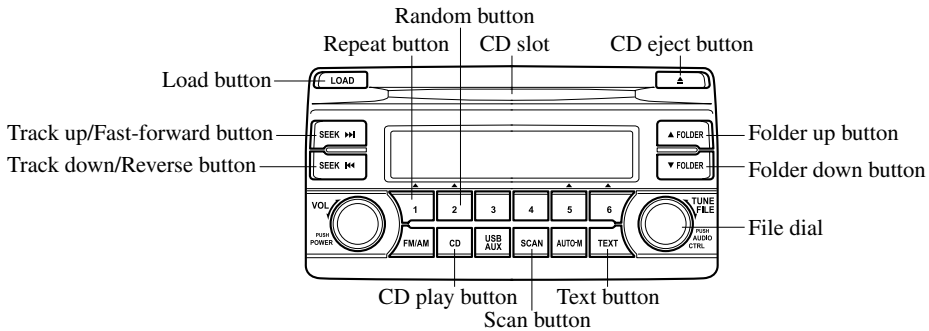

Type	Playable data
Music/MP3/WMA/AAC CD player	<ul style="list-style-type: none"> <li>• Music data (CD-DA)</li> <li>• MP3/WMA/AAC file</li> </ul>

**NOTE**

If a disc has both music data (CD-DA) and MP3/WMA/AAC files, playback of the two or three file types differs depending on how the disc was recorded.

**Inserting the CD**

Insert the CD into the slot, label-side up. The auto-loading mechanism will set the CD and begin play.

**NOTE**

There will be a short lapse before play begins while the player reads the digital signals on the CD.

**Ejecting the CD**

Press the CD eject button (▲) to eject the CD.

**Playback**

Press the CD play button (CD) to start play when a CD is in the unit. If a CD is not in the unit when the CD play button (CD) is pressed, "NO DISC" will flash on and off.

**NOTE**

When the load button (LOAD) is pressed, the CD will load and play even if the CD eject button (▲) had been previously pressed.

**Fast-forward/Reverse**

Press and hold the fast-forward button (▶▶) to advance through a track at high speed. Press and hold the reverse button (◀◀) to reverse through a track at high speed.

**Track search**

Press the track up button (▶) or turn the file dial clockwise once to skip forward to the beginning of the next track. Press the track down button (◀) or turn the file dial counterclockwise once to skip back to the beginning of the current track.

**Folder search (during MP3/WMA/AAC CD playback)**

To change to the previous folder, press the folder down button (▼), or press the folder up button (▲) to advance to the next folder.



Interior Features  
**Audio System**

**Music scan**

**During music CD playback**

This function scans the titles on a CD and plays 10 seconds of each song to aid you in finding a song you want to listen to. Press the scan button (**SCAN**) during playback to start the scan play operation (the track number will flash). Press the scan button (**SCAN**) again to cancel scan playback.

**During MP3/WMA/AAC CD playback**

This function scans the titles in a folder currently being played and plays 10 seconds of each song to aid you in finding a song you want to listen to. Press the scan button (**SCAN**) during playback to start the scan play operation (the track number will flash). Press the scan button (**SCAN**) again to cancel scan playback.

***NOTE***

*If the unit is left in scan, normal playback will resume where scan was selected.*

**Repeat playback**

**During music CD playback**

Press the repeat button (1) during playback to repeat the playback of the current song. "TRACK RPT" is displayed during playback. Press the repeat button (1) while displaying the "TRACK RPT" to cancel.

**During MP3/WMA/AAC CD playback**

**(Track repeat)**

Press the repeat button (1) during playback to repeat the playback of the current song. "TRACK RPT" is displayed during playback.

Press the repeat button (1) two times while displaying the "TRACK RPT" to cancel.

**(Folder repeat)**

Press the repeat button (1) two times during playback to repeat the playback of the current song in the folder. "FOLDER RPT" is displayed during playback.

Press the repeat button (1) while displaying "FOLDER RPT" to cancel.

**Random playback**

**During music CD playback**

Press the random button (2) during playback to play the tracks in the CD randomly. "DISC RDM" is displayed during playback.

Press the random button (2) while displaying "DISC RDM" to cancel.

**During MP3/WMA/AAC CD playback**

**(Folder random)**

Press the random button (2) during playback to play the tracks in the folder randomly. "FOLDER RDM" is displayed during playback.

Press the random button (2) two times while displaying "FOLDER RDM" to cancel.

Interior Features

# Audio System

## (CD random)

Press the random button (2) two times during playback to play the songs on the CD randomly. "DISC RDM" is displayed during playback.

Press the random button (2) while displaying "DISC RDM" to cancel.

## Switching the display

For files with a file name and other information that have been input, the display switches between display of the file name and other information each time the text button (TEXT) is pressed during playback.

## Music CD

Track number/Elapsed time

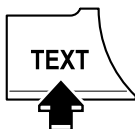

Track name

Album name

Artist name

## MP3/WMA/AAC CD

File number/Elapsed time

Folder number/File number

File name

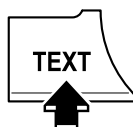

Folder name

Album name

Song name

Artist name

## NOTE

- The information viewable in the display is only CD information (such as artist name, song title) which has been recorded to the CD.
- This unit cannot display some characters. Characters which cannot be displayed are indicated by an asterisk (\*).

## Display scroll

Only 9 characters (File name) or 13 characters (Except file name) can be displayed at one time. To display the rest of the characters of a long title, press and hold the text button (TEXT). The display scrolls the next 13 characters. Press and hold the text button (TEXT) again after the last 13 characters have been displayed to return to the beginning of the title.

Interior Features  
**Audio System**

**NOTE**

*The number of characters which can be displayed is restricted.*

**Message display**

If “CHECK CD” is displayed, it means that there is some CD malfunction. Check the CD for damage, dirt, or smudges, and then properly reinsert. If the message appears again, take the unit to an Authorized Mazda Dealer for service.

**▼ How to use Auxiliary jack/USB port\***

Audio can be heard from the vehicle's speakers by connecting a commercially-available portable audio unit to the auxiliary jack. In addition, audio can be played from the vehicle audio device by connecting USB memory or an iPod to the USB port.

Refer to AUX/USB/iPod mode on page 5-58.

**▼ Error Indications**

If you see an error indication on the display, find the cause in the chart. If you cannot clear the error indication, take the vehicle to an Authorized Mazda Dealer.

Indication	Cause	Solution
CHECK CD	CD is inserted upside down	Insert the CD properly. If the error indication continues to display, consult an Authorized Mazda Dealer.
	CD is defective	Insert another CD properly. If the error indication continues to display, consult an Authorized Mazda Dealer.

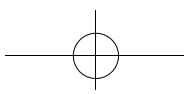

# MEMO

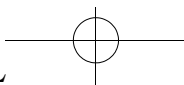
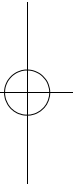
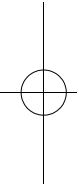

Interior Features  
**Audio System**

**Audio Set (Type B)**

**⚠ CAUTION**

*Do not press the panel strongly or press it with a sharp-pointed object. Otherwise, the panel could be damaged.*

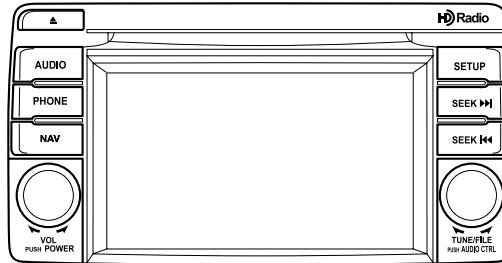

① Power/Volume/Display/Sound Controls .....	page 5-36
② Operating the Radio .....	page 5-40
③ Operating the Satellite Radio .....	page 5-44
④ Operating the Compact Disc (CD) Player .....	page 5-52
⑤ How to use the Auxiliary jack/USB port .....	page 5-55
⑥ Error Indication .....	page 5-55
⑦ Setup .....	page 5-55

Interior Features

## Audio System

### ▼ Power/Volume/Display/Sound Controls

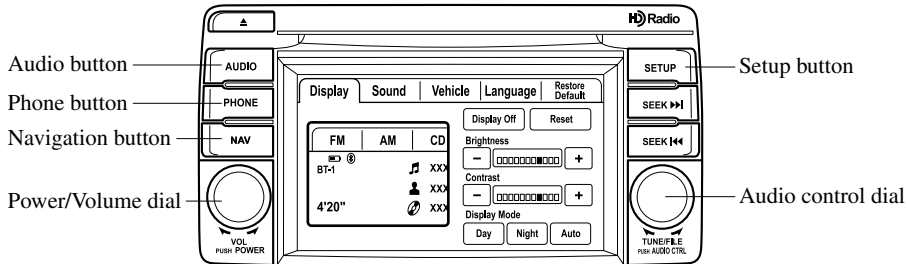

#### **Power ON/OFF**

Switch the ignition to ACC or ON.  
Press the power/volume dial to turn the audio system on. Press the power/volume dial again to turn the audio system off.

#### **Volume adjustment**

To adjust the volume, turn the power/volume dial.  
Turn the power/volume dial to the right to increase volume, to the left to decrease it.

#### **Display setting**

Press the setup button (**SETUP**) to display the display setting screen.  
Touch the **Display** on-screen tab to select the item you would like to change.

#### **Brightness adjustment**

- +** : Increase brightness
- : Decrease brightness

#### **Contrast adjustment**

- +** : Higher contrast
- : Lower contrast

#### **Tint adjustment**<sup>\*1</sup>

- +** : Green tint enhancement color
- : Red tint enhancement color

<sup>\*1</sup> Adjustment can be performed only while in the rear view camera mode.

#### **Color adjustment**<sup>\*1</sup>

- +** : To deepen a color
- : To fade a color

<sup>\*1</sup> Adjustment can be performed only while in the rear view camera mode.

#### **Daytime/nighttime screen setting**

The daytime or nighttime screen can be selected even if the headlights are illuminated or turned off (when bright screen is required at night or dark screen is required at noon).

- Day** : Daytime screen setting
- Night** : Nighttime screen setting
- Auto** : Switches screen automatically according to headlight illumination condition

#### **Display OFF**

The display can be turned off. Touch the **Display off** on-screen button to turn the display off.

Interior Features  
**Audio System**

The display can be turned back on as follows:

- Press the audio button (**AUDIO**) to display the audio screen.
- Press the navigation button (**NAV**) to display the navigation screen.
- Press the phone button (**PHONE**) to display the Bluetooth® dial screen.
- Press the setup button (**SETUP**) to display the setup dial setting screen.
- Press the audio control dial to display the setup sound setting screen.
- Shift to the R position to change to the rear view camera mode.  
 Shift to a position other than R to return to the display off condition.

**NOTE**

- *When an automatic audio operation such as going to the next song on the playlist occurs, the information concerning the audio operation is displayed even with the display turned off.*
- *The screen can also be turned off using voice recognition.*  
 Refer to Component Parts on page 5-78.

**Display setting reset**

All of the screen setting values can be reset to their initial settings.

1. Touch the  on-screen button.
2. Touch the  on-screen button.

**Audio sound adjustment**

Press the audio control dial or touch the  on-screen button to display the sound setting screen.

Indication	Setting value
Bass (Low pitch sound)	<input type="button" value="+"/> : Low pitch enhancement <input type="button" value="-"/> : Low pitch reduction
Treble (Treble sound)	<input type="button" value="+"/> : Treble enhancement <input type="button" value="-"/> : Treble reduction
Fader (Front/back volume balance)	<input type="button" value="Rear"/> : Front speaker volume reduction <input type="button" value="Front"/> : Rear speaker volume reduction
Balance (Left/right volume balance)	<input type="button" value="Left"/> : Right side volume reduction <input type="button" value="Right"/> : Left side volume reduction
Button Beep (Audio operation sound)	<input type="button" value="On/Off"/> : on/off*1
Auto Level Control*2 (Automatic volume adjustment)	<input type="button" value="+"/> : Level up <input type="button" value="-"/> : Level down
AudioPilot*3 (Automatic volume adjustment)	<input type="button" value="On/Off"/> : on/off
Centerpoint*3 (Automatic surround level adjustment)	<input type="button" value="On/Off"/> : on/off

\*1 Some functions do not turn off

\*2 Standard audio

\*3 Bose® Sound System

**Automatic Level Control (ALC)**

The automatic level control is a feature that automatically adjusts audio volume and sound quality according to the vehicle speed. The volume increases in accordance with the increase in vehicle speed, and decreases as vehicle speed decreases.

Interior Features

## Audio System

---

### AudioPilot® 2\*4

AudioPilot® 2 automatically adjusts audio volume and sound quality in accordance with the level of noise entering the vehicle interior while driving. When AudioPilot® 2 is turned on, the system automatically calculates the conditions for optimum hearing of sound which may be difficult to hear depending on exterior noise.

AudioPilot® 2 can be set on or off.

\*4 AudioPilot® 2 is a registered trademark of Bose Corporation.

### Centerpoint®\*5

Centerpoint® offers you the experience of 5.1-channel surround sound in your vehicle even with your conventional 2-channel stereo CDs. Centerpoint® can be set on or off.

\*5 Centerpoint® is a registered trademark of Bose Corporation.

### NOTE

- *Centerpoint® operates optimally with a 2-channel stereo CD. MP3 audio files can be played, however, MP3 audio files encoded with high compression may result in poor sound quality.*
- *Centerpoint® is available for 2-channel stereo audio except for AM radio/FM radio/AUX/Bluetooth® audio.*

### Sound setting reset

The settings for bass, treble, fade, and balance can be returned to their initial settings.

1. Touch the  on-screen button.
2. Touch the  on-screen button.



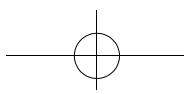

# MEMO

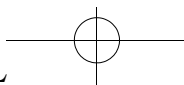
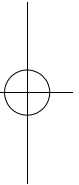
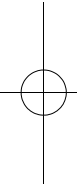

Interior Features

# Audio System

## ▼ Operating the Radio

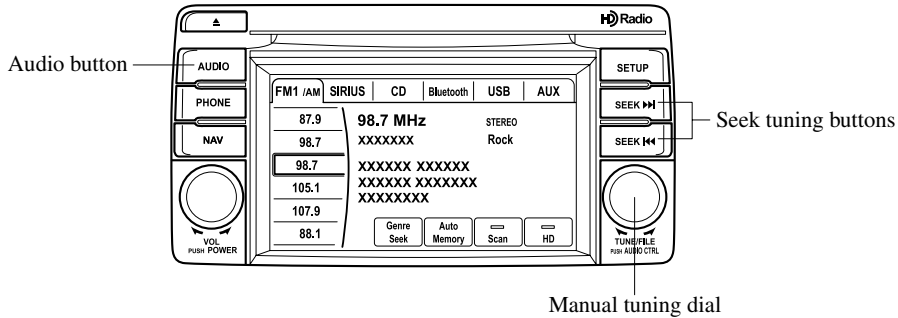

### Radio ON

Press the audio button (**AUDIO**) and touch the **FM1 /AM** on-screen tab.

### Band selection

Touch the **FM1 /AM** on-screen tab to switch the band as follows:  
FM1→FM2→AM

### **NOTE**

- **FM1/FM2** is displayed when FM1 is selected, **FM2 /AM** is displayed when FM2 is selected, and **FM/AM** is displayed when AM is selected.
- If the FM broadcast signal becomes weak, reception automatically changes from **STEREO** to **MONO** for reduced noise, and the “**STEREO**” indicator will no longer display.

### Tuning

The radio has the following tuning methods: Manual, Seek, Scan, Preset channel, and Auto memory tuning. The easiest way to tune stations is to set them on preset channels.

### **NOTE**

If the power supply is interrupted (fuse blows or the battery is disconnected), the preset channels will be erased.

### Manual tuning

Turning the manual tuning dial will change the frequency higher or lower.

### **NOTE**

When an HD Radio broadcast is being received, a receivable multicast channel is also received.

### Seek tuning

Pressing the seek tuning button (**▶▶**, **◀◀**) will cause the tuner to seek a higher or lower frequency automatically.

### **NOTE**

- If you continue to press and hold the seek tuning button (**▶▶**, **◀◀**) the frequency will continue changing without stopping.
- When an HD Radio broadcast is being received, a receivable multicast channel is also received.

## Interior Features Audio System

### Scan tuning

You can search for receivable radio stations by touching the  on-screen button.

Scanning stops at each station for about five seconds.

Touch the  on-screen button one time during reception to continue receiving a broadcasting station.

### Preset channel tuning

The six preset channels can be used to store six AM and twelve FM stations.

1. To set a channel, first select AM, FM1, or FM2. Tune to the desired station.
2. Press and hold any of the preset on-screen buttons. The reception frequency is programmed and displayed on the preset button.
3. Repeat this operation for the other stations and bands you want to store. When receiving a programmed frequency, select AM, FM1, or FM2 and touch the preset on-screen button.

#### **NOTE**

*The programmed frequency is displayed on the preset button.*

### Auto memory tuning

This is especially useful when driving in an area where the local stations are unknown. Additional AM/FM stations can be stored without disturbing the previously set channels.

1. Touch the  on-screen button. The auto memory preset list is displayed and the previously tuned frequency is received.

2. Touch the  on-screen button to display the frequencies of up to ten radio stations on the auto memory preset list.
3. Touch the desired frequency.

#### **NOTE**

*Touch the  on-screen button during auto memory tuning to return to the AM/FM main screen.*

### Radio Data System (RDS)

#### Radio text information display

A maximum of 64 characters of radio text information sent from a broadcasting station is displayed in the audio display.

#### **NOTE**

*Radio text information is a function of FM radio. Text information is not displayed in the following:*

- During HD Radio reception
- Not an RDS broadcast
- During HD reception
- RDS broadcast, but radio text is not transmitted from the radio station

#### Genre Seek

Some FM stations transmit Genre codes (Program type like a Rock, News, and so on). This code enables alternative stations transmitting the same Genre code to be found quickly. To select from the genre list, touch the  on-screen button while in the FM mode and the desired Genre Seek.

#### (To scan for Genre Seek:)

1. Touch the genre type which you want to select.

Interior Features

## Audio System

2. When  is touched, a higher frequency station is selected from the frequencies being received and a radio station corresponding to the selected genre is located.

When  is touched, a lower frequency station is selected from the frequencies being received and a radio station corresponding to the selected genre is located.

When  on-screen button is touched during genre selection, the radio frequency switches in the order of stations having the best reception.

(Example)

If the radio frequency currently being received is 89.3, the frequency switches as follows:

89.3→98.3\*1→104.3\*1→98.7→107.1

\*1 Radio stations with good reception

### NOTE

- Only one Genre can be selected.
- Touch the  on-screen button to return to the FM1 or FM2 main screen.
- If the radio reception conditions are poor, it may not be possible to receive even one station even if the genre seek button is pressed.
- If a program in the selected genre is not broadcast to a region, reception is not possible even if the reception conditions are good.
- The Genre Seek function searches for genre code (program type) which FM analog broadcasts transmit. Digitally broadcast HD Radio specialty programs (HD2-HD8) cannot be searched.
- If radio stations which are selected by scanning using the Genre Seek function are HD Radio broadcasting stations, they are changed from analog broadcasts to HD Radio broadcasts after a few seconds if the reception conditions are good. The genre is displayed after the switch, however, the genre for FM analog broadcasts may differ.

### HD Radio\*

#### What is HD Radio™ Technology and how does it work?

HD Radio™ Technology is the digital evolution of analog AM/FM radio. Your radio product has a special receiver which allows it to receive digital broadcasts (where available) in addition to the analog broadcasts it already receives. Digital broadcasts have better sound quality than analog broadcasts as digital broadcasts provide free, crystal clear audio. For more information, and a guide to available radio stations and programming, please visit [www.hdradio.com](http://www.hdradio.com).

Interior Features  
**Audio System**

**Benefits of HD Radio™ Technology**





**(Information)**



The song title, artist name and genre will appear on the screen when available by the radio station.

**(Multicast)**



On the FM radio frequency most digital stations have “multiple” or supplemental programs on each FM station.

**Listening to HD Radio™ Technology**

If  turns on by selecting a radio station which is an HD Radio broadcasting station, the analog broadcast is switched to an HD Radio broadcast automatically after a few seconds and then received. For FM, , and for AM,  is displayed, and the  illuminates in orange.





If the HD Radio broadcast is stopped and changed to an analog broadcast, press down  to turn off .

**Multicast channel selection (FM)**

Press   on-screen button to switch to the multi-cast channel for the displayed number.

The number of multi-cast channels which can be received differs depending on the radio station.

**NOTE**

- If an analog broadcast is received once and HD Radio is received while HD1 is selected, the audio unit switches to the HD Radio station automatically.
- If the reception conditions worsen while receiving an HD specialty channel (HD2 to HD8), “No HD signal” is displayed, and audio output stops.
- Once an analog broadcast is received when HD1 is selected from the preset channels, it is switched to HD Radio automatically. If the radio reception conditions are poor, or  is off, switching to HD Radio broadcasts is not possible.
- When an HD specialty channel (HD2 to HD8) is selected from the preset channels, “No HD signal” is displayed and no audio is output until HD Radio is received. If the radio reception conditions are poor, “No HD signal” continues to be displayed.
- If the  is not illuminated or does not illuminate in orange, information such as song titles of the HD Radio station are received, however, the audio output is analog. If information can no longer be received and the non-reception condition continues,  and  on-screen buttons disappear.

Interior Features

# Audio System

## ▼ Operating the Satellite Radio\*

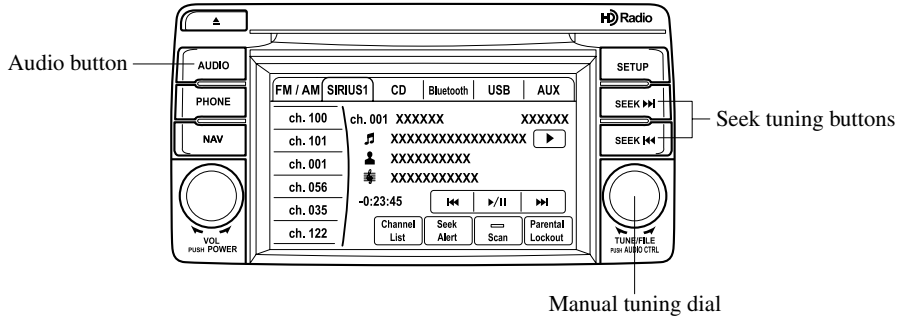

### What is satellite radio?

With over 130 channels, SIRIUS Satellite Radio brings you more of what you love. Get channels and channels of commercial-free music, plus sports, news, talk, entertainment and more.

**Commercial-free music from nearly every genre** —rock to pop, hip-hop to country, jazz, classical and more. Plus live performances and artist-dedicated channels.

**Live sports Play-by-Play & Expert Talk** —every NFL game, every NASCAR® race, 24/7 sports talk, college sports and more.

**Exclusive entertainment, comedy and talk** —The biggest names, compelling talk, hilarious comedy.

**World-class news plus local traffic and weather.**

Sign up for SIRIUS Satellite Radio today! For more information, visit [www.sirius.com](http://www.sirius.com). Satellite radio can be subscribed to and received in the United States (Except Alaska and Hawaii) and Canada.

### How to Activate Satellite Radio

You must call SIRIUS to activate your service. Activation is free and takes only a few minutes.

SIRIUS service uses an ID code to identify your radio. This code is needed to activate SIRIUS service, and report any problems.

To activate your SIRIUS radio tuner, call a SIRIUS customer service specialist at 1-888-539-7474 or you can visit SIRIUS online at [www.sirius.com](http://www.sirius.com).

Please have the following information ready:

- SIRIUS ID (12-digit electronic serial no, or ESN\*1)
- Valid credit card information (may not be required at initial sign-up)

\*1 ESN: Electronic Serial Number  
Be sure you are parked outside with a clear view of open sky, you will be instructed to turn on your radio (in SIRIUS mode and tuned to channel 184). Activation typically takes only 2—5 minutes.

Interior Features  
**Audio System**

**Displaying the SIRIUS ID (ESN)**

Turn the manual tuning dial and select channel 0 to display the twelve-digit Electronic Serial Number (ESN) for the SIRIUS tuner.

**SIRIUS operation**

All operations of the satellite radio are conducted by means of the audio unit.



**SIRIUS radio mode selection**

Touch the  on-screen tab on the audio screen to receive the previously received SIRIUS channel.

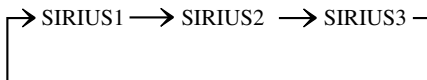
Every time the  on-screen tab is touched, the bank changes in the order shown below.



**NOTE**

- *SIRIUS1, SIRIUS2 and SIRIUS3: six stations can be stored in each bank for convenient access to your favorite stations.*
-  is displayed when SIRIUS1 is selected,  is displayed when SIRIUS2 is selected, and  is displayed when SIRIUS3 is selected.

**Operation in the initial state**

It may take some time to start up the equipment when it is in the initial state, when there is a change in the user's subscription condition, when the firmware is updated or when the SIRIUS channel map is changed.  
“Updating Channels XXX %” is displayed when the SIRIUS channel map is changed.

If the user contract content is changed, “Subscription Updated” is displayed.  
When the firmware is updated, the “Updating Receiver” is displayed.  
Updating could take as long as a few minutes depending on the geographical area. When the unit is in an initialized state, channel 184 is displayed after the display indicates “Updating Receiver”.

**NOTE**

*Do not perform the following operation while “Updating Channels XXX %”, “Updating Receiver” is displayed. Otherwise, the updating procedure will be canceled.*

- *Turning off the audio power*
- *Switching to other modes*
- *Switching the ignition off*

When the SIRIUS mode is switched to another mode, or when the power is turned off, the present channel which is being received is stored as the last channel.



**Channel up**

Turn the manual tuning dial to the right or press the seek up button ().

**Channel down**

Turn the manual tuning dial to the left or press the seek down button ().

**NOTE**

*The channel is continuously switched to the next or previous channel while the seek tuning button (, ) is continuously pressed.*

**Unsubscribed channel**

When a channel which has been preset becomes unsubscribed or the current channel being listened to becomes unsubscribed, the following is displayed:  
“Call 888-539-SIRIUS”  
“to subscribe”

Interior Features

## Audio System

### NOTE

When the subscription contract is canceled, all of the channels including channel 184 appear as unsubscribed.

### Preset channel programming

1. Select the desired channel to be programmed.
2. Long-press any of the preset on-screen buttons.

### NOTE

Six stations can be stored in each bank, SIRIUS1, SIRIUS2 and SIRIUS3 for convenient access to your favorite stations.

### Preset channel call-up

Touch the preset on-screen button for the channel which you want to select.

### NOTE

In the initial setting, all channels are preset to 184.

### Selection from channel list

Receivable channels can be displayed on the channel list screen. You can easily select the channel you want to listen from the list. Each category can be also displayed.

1. Touch the  on-screen button.
2. Touch the channel you want to listen from the list.

### NOTE

Currently available channels (including parental locked channels) are all displayed in the list.

### (Select from category list)

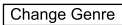
1. Touch the  on-screen button on the channel list screen.

2. Touch the category name which you want to select from the list. Touch the  on-screen button to return to the channel list screen.

### NOTE

A category can be set only when a channel which belongs to a category is being received.

### Scan tuning

Touch the  on-screen button to automatically sample stations. Scanning stops at each station for about five seconds.

To hold a station, touch the  on-screen button again during this interval.

### NOTE

Unsubscribed channels, invalid channels, parental lock channels and channel 0 are not subject to the scan, therefore these channels will skip automatically.



### Channel number, channel name, category name, artist name, song titles and information display

The information regarding the channel which is currently being received is displayed.

### NOTE

If channels not subscribed and parental locked channels can be received, the channel name, category name, artist name, song title and information is displayed.

### Display scroll

If a whole title cannot be displayed at one time, touch the  on-screen button on the right side of the title. When the last character is displayed, touch the  on-screen button to display the first character of the title.







## Interior Features Audio System

### **NOTE**

The  on-screen button is displayed only if a whole title cannot be displayed at one time.

### **Instant replay**

This function allows you to rewind and replay the program that you were previously or are currently listening to. When the  on-screen button is touched, playback starts from the beginning of the current program. When the  on-screen button is touched twice, playback starts from the beginning of the previous program. Touch and hold the  on-screen button to reverse the program while the button is being pressed.

When the  on-screen button is touched, playback starts from the beginning of the next program.

When the  on-screen button is touched while the last program is being played, the instant replay mode is canceled.

Touch and hold the  on-screen button to fast-forward the program while the button is being pressed.

When touching and holding the button until the end of the program, the instant replay mode is canceled.

### **Instant replay (PAUSE)**



If the  on-screen button is touched, instant replay mode is turned on in a paused condition (PAUSE).

Touch the  on-screen button again to resume playback from the point at which it was paused.

### **Parental lock**



Parental lock, parental unlock, parental lock code change, and parental lock code reset can be set.

### **NOTE**

- Touch the  on-screen button during all the settings to return to the previous display.
- Touch the  on-screen button during the code and master code input to delete an input number.
- If only a four-digit code or master code is input, "Done" can be selected.
- If the registered code has been forgotten, reset the code in "Initialize Parental Code" to [0000].

### **Parental lock**

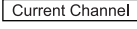
If a channel is locked, the channel is muted.



1. Turn the manual tuning dial to select the desired channel.
2. Touch the  on-screen button to display the settings screen.
3. Touch the  on-screen button to display the parental lock settings screen.
4. "Input Parental Code" is displayed, and input of the registered code is possible. To enter a number, use the numerical keypad.
5. After inputting the four digits, touch the  on-screen button to confirm the four digits.
6. If the four digits match the registered code, "Channel XXX locked" appears and mute is turned on. If they do not match the registered code, "Wrong code" appears and then the display returns to "Input Parental Code".

Interior Features

## Audio System

### Parental unlock

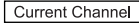

Channels locked using the parental lock function can be unlocked.

1. Select a channel to be unlocked by turning the manual tuning dial.
2. Touch the  on-screen button to display the settings screen.
3. Touch the  on-screen button to display the parental unlock settings screen.
4. “Input Parental Code” is displayed, and input of the registered code is possible. To enter a number, use the numerical keypad.
5. After inputting the four digits, touch the  on-screen button to confirm the four digits.
6. If the four digits match the registered code, “Channel XXX unlocked” appears and mute is canceled. If they do not match the registered code, “Wrong code” appears and then the display returns to “Input Parental Code”.

### Parental-lock code change

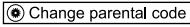
When changing the code, the new code is input after the previous one is input first.

1. Touch the  on-screen button to display the settings screen.
2. Touch the  on-screen button to display the code change screen.
3. “Enter Current Code” is displayed, and input of the registered code is possible. To enter a number, use the numerical keypad.

4. After inputting the four digits, touch the  on-screen button to confirm the four digits.
5. If the four digits match the registered code, “Enter New Code” is displayed. If they do not match the registered code, “Wrong code” appears and then the display returns to “Enter Current Code”. To enter a number, use the numerical keypad.
6. After inputting the four digits, touch the  on-screen button to confirm the four digits.
7. “Code changed” appears to indicate that the new code input has been completed.
8. The display returns to its normal display.

### NOTE

*Channels locked before changing the code remain after changing the code. To unlock a channel, input the changed code.*

### Parental-lock code reset

If the registered code has been forgotten, reset the code to the default [0000] code.

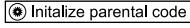
1. Touch the  on-screen button to display the settings screen.
2. Touch the  on-screen button to display the code initial screen.
3. “Enter Master Code” is displayed, and input of the registered code is possible. To enter a number, use the numerical keypad.

Interior Features  
**Audio System**

**NOTE**

*Master code:*

*The Master Code is used to initialize or re-initialize the code in the event that the code is not set to [0000] and/or the personalized code is not known. The initialization process resets the code to [0000]. The master code can potentially defeat the intent of the security of the parental lock if it is located by persons not authorized by the owner to access certain channels.*

*SIRIUS Satellite Radio Master Code: [0913]*

4. After inputting the four digits, touch the  on-screen button to confirm the four digits.
5. If the four digits match the master code, "Code initialized" appears. If they do not match the master code, "Wrong code" appears and the display returns to "Enter Master Code".
6. The code returns to the default [0000] code.

**Seek alert**

The song title and artist name for the song currently being listened to, and team names at the sports game currently being listened to can be recorded as favorites.

The user is notified when a program begins which has favorites-related information recorded.

**Selection from seek alert program list**

Select the station you want to listen to from the list to receive the program. Touch the  on-screen button to return to the receiving screen.

**Storing songs, artists, and sports team names**

**NOTE**

- A maximum of 10 songs, artists, and sports team names each can be stored.
- If the song title, artist name, sports team name cannot be displayed, "No available items for this program" is displayed.
- Even if the song title, and artist name are displayed in the main screen, it may not be possible to record information for old songs.
- If a song name is stored, the song seek function is turned on.
- If an artist name is stored, the artist seek function is turned on.
- If a sports team name is stored, the game alert function is turned on.

1. Touch the  on-screen button to display the current song and artist names currently being received. The sports team name is displayed while the sports program is being received.
2. Select the item you want to store from song title, artist name and sports team name.
3. "XXXXX (song, artist, sports team name) stored" is displayed.

**NOTE**

*If there is not enough available storage space, "Song Memory Full" or "Artist Memory Full" or "Team Memory Full" and "Delete one to store new one" are displayed. Delete from the list.*

Interior Features

## Audio System

---

### Seek alert setting

On or off switching to song seek, artist seek, or game alert function, and deletion of stored information can be performed.

Touch the  on-screen button and the  on-screen button. Touch the button you want to change from  ,  , or  .

#### (On or off switching)

Touch the  ,  , and  on-screen button.

#### (Deletion)

1. Select song title, artist name, or sports team name that you want to delete from the list.
2. Touch the  on-screen button to display “XXXXX (song, artist, sports team name) deleted”.

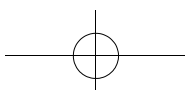

# MEMO

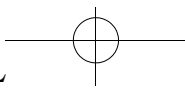
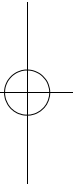
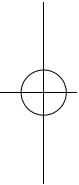

Interior Features

# Audio System

## ▼ Operating the Compact Disc (CD) Player

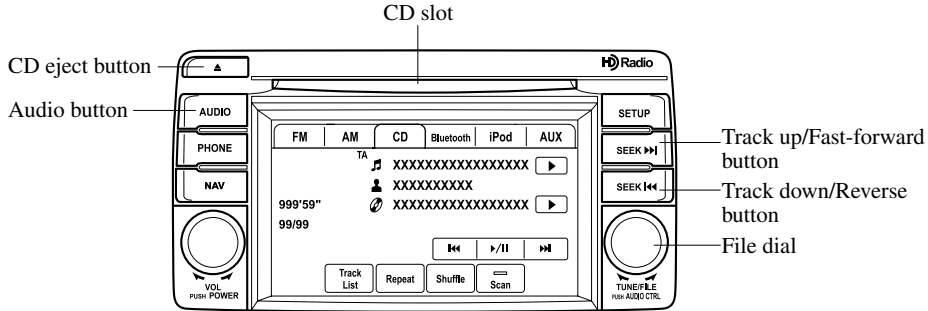

Type	Playable data
Music/MP3/WMA/AAC CD player	<ul style="list-style-type: none"> <li>• Music data (CD-DA)</li> <li>• MP3/WMA/AAC file</li> </ul>

**NOTE**

If a disc has both music data (CD-DA) and MP3/WMA/AAC files, playback of the two or three file types differs depending on how the disc was recorded.

**Inserting the CD**

Insert the CD into the slot, label-side up. The auto-loading mechanism will set the CD and begin play.

**NOTE**

There will be a short lapse before play begins while the player reads the digital signals on the CD.

**Ejecting the CD**

Press the CD eject button (▲) to eject the CD.

**Playback**

Press the audio button (AUDIO) or  on-screen tab with a CD inserted.

**Pause**

To pause playback, touch the  on-screen button.

Touch the  on-screen button during a pause to cancel it.

**Fast-forward/Reverse**

**Operations using audio panel**

Press and hold the fast-forward button (▶▶) to advance through a track at high speed.

Press and hold the reverse button (◀◀) to reverse through a track at high speed.

**Operations on screen**

Touch and hold the  on-screen button to advance through a track at high speed.

Touch and hold the  on-screen button to reverse through a track at high speed.

Interior Features  
**Audio System**

### **Track search**

#### **Operations using audio panel**

Press the track up button (▶▶) or turn the file dial clockwise once to skip forward to the beginning of the next track.

Press the track down button (◀◀) or turn the file dial counterclockwise once to skip back to the beginning of the current track.

#### **Operations on screen**

Touch the [▶▶] on-screen button once to skip forward to the beginning of the next track.

Touch the [◀◀] on-screen button once to skip back to the beginning of the current track.

### **Displaying file list**

The desired file list in the CD can be viewed.

#### **During music CD playback**

Touch the [Track List] on-screen button to display the track list in the CD.

#### **During MP3/WMA/AAC CD playback**

##### **(Viewing file list in desired folder)**

1. Touch the [Folder List] on-screen button to display the folder list in the CD.
2. Touch the folder which you want to select.

##### **(Viewing file list of current folder)**

Touch the [Current Folder] on-screen button.

### **Selecting file/track**

Select the file/track you want to play.

#### **During music CD playback**

1. Touch the [Track List] on-screen button to display the track list in the CD.
2. Touch the track you want to play.

#### **During MP3/WMA/AAC CD playback**

1. Touch the [Folder List] on-screen button to select the folder.
2. Touch the file you want to play.

#### **NOTE**

Press the [↶] on-screen button on the file list screen to display the list of folders.

### **Music scan**

#### **During music CD playback**

This function scans the titles on a CD and plays 10 seconds of each song to aid you in finding a song you want to listen to.

1. Touch the [Scan] on-screen button during playback to play 10 seconds of each subsequent track starting from the next song.
2. Touch the [Scan] on-screen button during playback of the song you want to listen to and continue the playback from that point.

#### **During MP3/WMA/AAC CD playback**

This function scans the titles in a folder currently being played and plays 10 seconds of each song to aid you in finding a song you want to listen to.

1. Touch the [Scan] on-screen button during playback to play 10 seconds of each subsequent track starting from the next song.
2. Touch the [Scan] on-screen button during playback of the song you want to listen to and continue the playback from that point.

Interior Features



## Audio System



### NOTE

- If the unit is left in scan, normal playback will resume where scan was selected.
- If all the tracks are scanned, the unit will resume normal playback.

### Repeat playback



#### During music CD playback



Touch the  on-screen button during playback to play the song currently being played repeatedly. “” is displayed during playback.

Touch the  on-screen button while “” is displayed to cancel.



#### During MP3/WMA/AAC CD playback



##### (Track repeat)

Touch the  on-screen button to play the song during playback repeatedly. “” is displayed during playback.

Touch the  on-screen button two times while “” is displayed to cancel.



##### (Folder repeat)



Touch the  on-screen button two times to play the songs in the folder repeatedly. “” is displayed during playback.

Touch the  on-screen button while “” is displayed to cancel.

### Shuffle playback



#### During music CD playback



Touch the  on-screen button during playback to play the songs in the CD shuffle. “” is displayed during playback.

Touch the  on-screen button while “” is displayed to cancel.



#### During MP3/WMA/AAC CD playback



##### (Folder shuffle)

Touch the  on-screen button during playback to play the songs in the folder shuffle. “” is displayed during playback.



Touch the  on-screen button two times while “” is displayed to cancel.

##### (CD shuffle)

Touch the  on-screen button two times during playback to play the songs in the CD shuffle. “” is displayed during playback.

Touch the  on-screen button while “” is displayed to cancel.

### Display scroll

If a whole title cannot be displayed at one time, touch the  on-screen button on the right side of the title. When the last character is displayed, touch the  on-screen button to display the first character of the title.

### NOTE

- The  on-screen button is displayed only if a whole title cannot be displayed at one time.
- The information viewable in the display is only CD information (such as artist name, song title) which has been recorded to the CD.
- This unit cannot display some characters. Character which cannot be displayed are indicated by an asterisk (\*).
- The number of characters which can be displayed is restricted.



Interior Features  
**Audio System**

**Message Display**

If “CD Error” is displayed, it means that there is some CD malfunction. Check the CD for damage, dirt, or smudges, and then properly reinsert. If the message appears again, take the unit to an Authorized Mazda Dealer for service.

**▼ How to use Auxiliary jack/USB port\***

Audio can be heard from the vehicle's speakers by connecting a commercially-available portable audio unit to the auxiliary jack. In addition, audio can be played from the vehicle audio device by connecting USB memory or an iPod to the USB port.

Refer to AUX/USB/iPod mode on page 5-58.

**▼ Error Indications**

If you see an error indication on the display, find the cause in the chart. If you cannot clear the error indication, take the vehicle to an Authorized Mazda Dealer.

Indication	Cause	Solution
CD Error	CD is inserted upside down	Insert the CD properly. If the error indication continues to display, consult an Authorized Mazda Dealer.
	CD is defective	Insert another CD properly. If the error indication continues to display, consult an Authorized Mazda Dealer.

**▼ Setup**

You can customize settings in the setup display as follows:

**Display**

Refer to Power/Volume/Display/Sound Controls on page 5-36.

**Sound**

Refer to Power/Volume/Display/Sound Controls on page 5-36.

**Vehicle**

- Door Locks
- Light Control
- Wipers Control

1. Press the setup button (**SETUP** )
2. Touch the Vehicle on-screen tab to display the vehicle setting screen.
3. Touch the desired setting item.
4. Select the desired setup item from the list by touching it.
5. Touch the OK on-screen button.

**Language**

1. Press the setup button (**SETUP** ).
2. Touch the Language on-screen tab to display the language setting screen.
3. Touch the desired language from the list.
4. Touch the OK on-screen button.

**Default (Vehicle settings only)**

1. Press the setup button (**SETUP** ).
2. Touch the Restore Default on-screen tab.
3. Touch the Continue on-screen button.
4. Touch the YES on-screen button.

\*Some models. **5-55**

Interior Features

## Audio System

5. Touch the  on-screen button.

**NOTE**

*The settings for display, sound, and language cannot be initialized.*

### Audio Control Switch Operation

When the audio unit is turned on, operation of the audio unit from the steering wheel is possible.

**NOTE**

*Because the audio unit will be turned off under the following conditions, the switches will be inoperable.*

- When the ignition is switched off.
- When the power button on the audio unit is pressed and the audio unit is turned off.

#### Without Bluetooth® Hands-Free

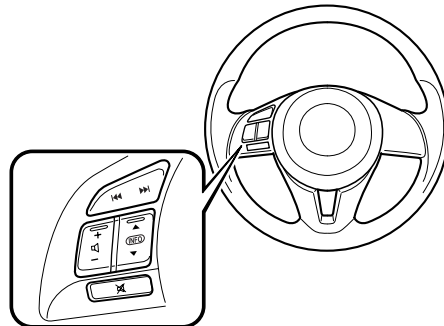

#### With Bluetooth® Hands-Free

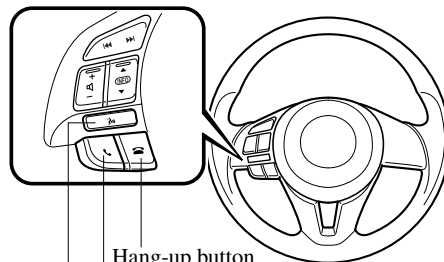

Hang-up button  
Pick-up button  
Talk button

Interior Features  
**Audio System**

**NOTE**

- The talk button, pick-up button, and hang-up button are operable with the audio unit turned off.
- Mazda has installed this system to prevent distraction while driving the vehicle and using audio controls on the dashboard. Always make safe driving your first priority.

**▼ Adjusting the Volume**

To increase the volume, press up the volume switch.

To decrease the volume, press down the volume switch.



**▼ Seek Switch**

When listening to the radio, press the seek switch (▶▶,◀◀). The radio switches to the next/previous stored station in the order that it was stored (1—6).

Press and hold the seek switch (▶▶,◀◀) to seek all usable stations at a higher or lower frequency whether programmed or not.

Radio stations which have been previously stored in the auto memory tuning can be called up by pressing the seek switch (▶▶,◀◀) while any radio station stored in the auto memory tuning is being received. Radio stations can be called up in the order they were stored with each press of the switch (▶▶,◀◀).

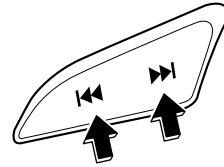

**When playing a CD or BT audio**

Press the seek switch (▶▶) to skip to the next track. Press the seek switch (◀◀) to repeat the current track. Press and hold the seek switch (▶▶,◀◀) to continuously switch the tracks up or down.

**▼ Mute Switch\***

Press the mute switch (⊗) once to mute audio, press it again to resume audio output.

**NOTE**

If the ignition is switched off with the audio muted, the mute will be canceled. Therefore, when the engine is restarted, the audio is not muted. To mute the audio again, press the mute switch (⊗).

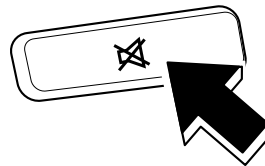

Interior Features

## Audio System

### AUX/USB/iPod mode \*

Audio can be heard from the vehicle's speakers by connecting a commercially-available portable audio unit to the auxiliary jack. In addition, audio can be played from the vehicle audio device by connecting USB memory or an iPod to the USB port.

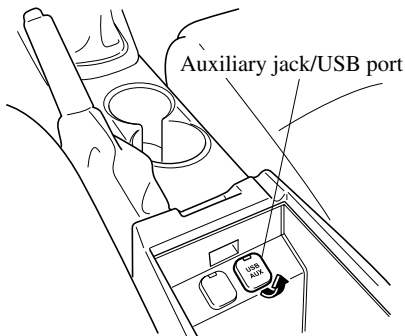

- ① How to use AUX mode ..... page 5-60
- ② How to use USB mode (Type A) ..... page 5-62
- ③ How to use USB mode (Type B) ..... page 5-66
- ④ How to use iPod mode (Type A) ..... page 5-70
- ⑤ How to use iPod mode (Type B) ..... page 5-74

### **⚠ WARNING**

**Do not adjust the portable audio unit or a similar product while driving the vehicle:**

*Adjusting the portable audio unit or a similar product while driving the vehicle is dangerous as it could distract your attention from the vehicle operation which could lead to a serious accident. Always adjust the portable audio unit or a similar product while the vehicle is stopped.*

### **⚠ CAUTION**

- Always close the auxiliary jack/USB port lid when it is not in use. If foreign matters or liquid penetrate the auxiliary jack/USB port, it may cause a malfunction.
- Depending on the portable audio device, noise may occur when using the device with it connected to the accessory socket equipped on the vehicle. (If noise occurs, do not use the accessory socket.)

Interior Features  
**Audio System**

**NOTE**

- Before using the auxiliary jack/USB port, refer to the instruction manual for the portable audio device.
- Use a commercially-available, non-impedance (3.5 $\Phi$ ) stereo mini plug for connecting the portable audio unit to the auxiliary jack. Before using the auxiliary jack, read the manufacturer's instructions for connecting a portable audio unit to the auxiliary jack.
- To prevent discharging of the battery, do not use the auxiliary input for long periods with the engine off or idling.
- Noise may occur depending on the product connected to the auxiliary jack.
- With regard to connecting a portable audio or similar device to a power source, use the battery for the device, not the accessory socket.

**▼ How to connect USB port/iPod terminal**

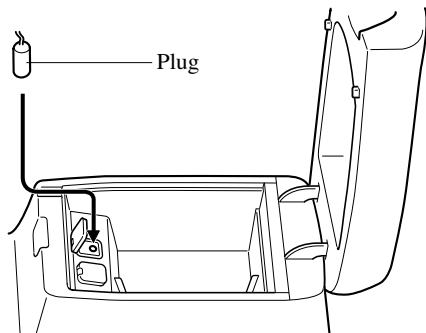

**Connecting a device**

1. Open the console lid.
2. Open the auxiliary jack/USB port lid.
3. Connect the device plug to the USB port.

**Connecting with connector cable**

1. Open the console lid.
2. Open the auxiliary jack/USB port lid.
3. Pass the connection plug cord through the cutout of the console and insert the plug into the auxiliary jack.

**⚠ WARNING**

**Do not allow the connection plug cord to get tangled with the parking brake or the shift lever:**

Allowing the plug cord to become tangled with the parking brake or the shift lever is dangerous as it could interfere with driving, resulting in an accident.

**⚠ CAUTION**

Do not place objects or apply force to the auxiliary jack with the plug connected.

**NOTE**

- Insert the plug to the auxiliary jack/USB port securely.
- Insert or pull out the plug with the plug perpendicular to the auxiliary jack/USB port hole.
- Insert or remove the plug by holding its base.

Interior Features

## Audio System

### ▼ How to use AUX mode

#### Type A



#### Type B



#### **(Type A)**

1. Switch the ignition to ACC or ON.
2. Press the power/volume dial to turn the audio system on.
3. Press the USB/AUX button (<sup>USB</sup><sub>AUX</sub>) of the audio unit to change to the AUX mode.

#### **(Type B)**

1. Switch the ignition to ACC or ON.
2. Press the power/volume dial to turn the audio system on.
3. Press the audio button (**AUDIO**) to display the audio screen.
4. Press the **AUX** on-screen tab to switch to the AUX mode.

#### **NOTE**

- When the device is not connected to the auxiliary jack, the mode does not switch to the AUX mode.
- Set the volume of the portable audio unit to the maximum within the range that the sound does not become distorted, then adjust the volume using the power/volume dial of the audio unit or the up/down switch of the audio control switch.
- Audio adjustments other than audio volume can only be done using the portable audio device.
- If the connection plug is pulled out from the auxiliary jack while in AUX mode, noise may occur.

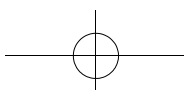

# MEMO

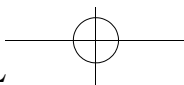
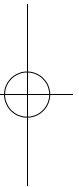
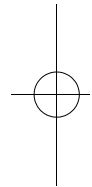

Interior Features

# Audio System

## ▼ How to use USB mode (Type A)

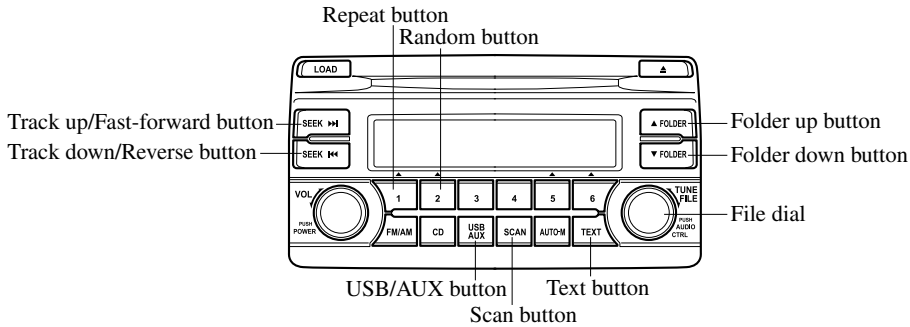

Type	Playable data
USB mode	MP3/WMA/AAC file

### Playback

1. Switch the ignition to ACC or ON.
2. Press the power/volume dial to turn the audio system on.
3. Press the USB/AUX button (  ) to switch to the USB mode and start playback.

### NOTE



- When the USB memory is not connected, the mode does not switch to USB mode.
- When there is no playable data in the USB memory, "NO CONTENTS" is indicated.
- Playback of the USB memory is in the order of the folder numbers. Folders which have no MP3/WMA/AAC files are skipped.
- Do not remove the USB memory while in the USB mode. The data may be damaged.

### Fast-forward/Reverse



Press and hold the fast-forward button (  ) to advance through a track at high speed.

Press and hold the reverse button (  ) to reverse through a track at high speed.

### Track search



Press the track up button (  ) or turn the file dial clockwise once to skip forward to the beginning of the next track. Press the track down button (  ) or turn the file dial counterclockwise once to skip back to the beginning of the current track.

### Folder search

To change to the previous folder, press the folder down button (  ), or press the folder up button (  ) to advance to the next folder.

### Music Scan

This function scans the titles in a folder currently being played and plays ten seconds of each song to aid you in finding a song you want to listen to.

Press the scan button (  ) during playback to start the scan play operation (the track number will flash). Press the scan button (  ) again to cancel scan playback.

### NOTE

If the unit is left in scan, normal playback will resume where scan was selected.



Interior Features  
**Audio System**

**Repeat playback**

**(Track repeat)**

Press the repeat button (1) during playback to play the current track repeatedly. "TRACK RPT" is displayed during playback.

Press the repeat button (1) two times while "TRACK RPT" is displayed to cancel.

**(Folder repeat)**

Press the repeat button (1) two times during playback to repeat the playback of the songs in the current folder. "FOLDER RPT" is displayed during playback.

Press the repeat button (1) while "FOLDER RPT" is displayed to cancel.

**Random playback**

**(Folder random)**

Press the random button (2) during playback to play the tracks in the folder randomly. "FOLDER RDM" is displayed during playback.

Press the random button (2) two times while "FOLDER RDM" is displayed to cancel.

**(Media random)**

Press the random button (2) two times during playback to play the songs in the USB memory randomly. "MEDIA RDM" is displayed during playback.

Press the random button (2) while "MEDIA RDM" is displayed to cancel.

**Switching the display**

For files with a file name and other information that have been input, the display switches between display of the file name and other information each time the text button (**TEXT**) is pressed during playback.

Folder number/File number

File number/Elapsed time display

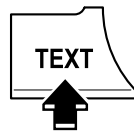

File name

Folder name

Album name

Song name

Artist name

***NOTE***

- *The information (artist name, music name) is displayed only when the USB memory information in the USB memory has information which can be displayed on the screen.*
- *This unit cannot display some characters. Characters which cannot be displayed are indicated by an asterisk (\*).*

**Display scroll**

Only 9 characters (File name) or 13 characters (Except file name) can be displayed at one time. To display the rest of the characters of a long title, press and hold the text button (**TEXT**). The display scrolls the next 13 characters. Press and hold the text button (**TEXT**) again after the last 13 characters have been displayed to return to the beginning of the title.

***NOTE***

*The number of characters which can be displayed is restricted.*

Interior Features

## Audio System

---

### Error Messages

When the message “CHECK USB” is displayed, it indicates that there is some error in the USB memory. Verify that the content recorded in the USB memory has MP3/WMA/AAC files and re-connect correctly. If the message reappears, have the unit checked by an Authorized Mazda Dealer.

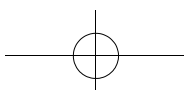

# MEMO

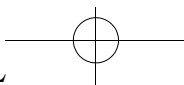
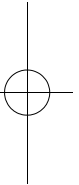
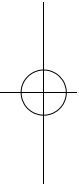

Interior Features  
**Audio System**

▼ **How to use USB mode (Type B)**

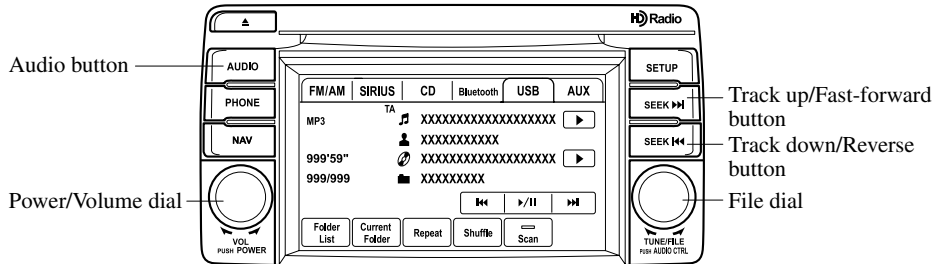

Type	Playable data
USB mode	MP3/WMA/AAC file

**Playback**

1. Switch the ignition to ACC or ON.
2. Press the power/volume dial to turn the audio system on.
3. Press the audio button (AUDIO) to display the audio screen.
4. Touch the [USB] on-screen tab to switch to USB mode and start playback.

**NOTE**

- When a USB memory is not connected to the USB port, the mode does not switch to the USB mode even if the [USB] on-screen tab is touched.
- Do not remove the USB memory while in the USB mode. Otherwise, the data could be damaged.

**Pause**

Touch the [▶/||] on-screen button to pause playback.  
 Touch the [▶/||] on-screen button while playback is paused to cancel the pause.

**Fast-forward/Reverse**

**Operations using audio panel**

Press and hold the fast-forward button (▶▶) to advance through a track at high speed.  
 Press and hold the reverse button (◀◀) to reverse through a track at high speed.

**Operations on screen**

Touch and hold the [▶▶] on-screen button to advance through a track at high speed.  
 Touch and hold the reverse button [◀◀] to reverse through a track at high speed.

**Track search**

**Operations using audio panel**

Press the track up button (▶▶) or turn the file dial clockwise once to skip forward to the beginning of the next track.  
 Press the track down button (◀◀) or turn the file dial counterclockwise once to skip back to the beginning of the current track.

**Operations on screen**

Touch the [▶▶] on-screen button once to skip forward to the beginning of the next track.

Interior Features  
**Audio System**

Touch the  on-screen button once to skip back to the beginning of the current track.

### **Displaying file list**

The optional file list in the USB memory can be viewed.

#### **(Viewing file list in optional folder)**

Touch the  on-screen button to display the folder list in the USB memory. Touch the folder to display the file list.

#### **(Viewing file list in the current folder)**

Touch the  on-screen button.

### **Selecting file**

Select a desired file to play the song.



1. Touch the  on-screen button to select the folder.
2. Touch the file you want to play.

#### **NOTE**

Press the  on-screen button on the file list screen to display the list of folders.

### **Music scan**

This function scans the titles in a folder currently being played and plays ten seconds of each song to aid you in finding a song you want to listen to.



1. Touch the  on-screen button during playback to play 10 seconds of each subsequent track starting from the next song.
2. Touch the  on-screen button during playback to continue the playback from that point.



#### **NOTE**

If the unit is left in scan, normal playback will resume where scan was selected.



### **Repeat playback**



#### **(Repeating song during playback)**

Touch the  on-screen button during playback. “” is displayed during playback.

Touch the  on-screen button two times while “” is displayed to cancel.



#### **(Repeating folder during playback)**



Touch the  on-screen button two times during playback. “” is displayed during playback.

Touch the  on-screen button while “” is displayed to cancel.



### **Shuffle playback**



#### **(To listen to tracks in shuffled order within a folder)**

Touch the  on-screen button during playback. “” is displayed during playback.



Touch the  on-screen button two times while “” is displayed to cancel.

#### **(To listen to tracks in shuffled order within USB memory)**

Touch the  on-screen button two times during playback. “” is displayed during playback.

Touch the  on-screen button while “” is displayed to cancel.

### **Text scroll**

If a whole title cannot be displayed at one time, touch the  on-screen button on the right side of each title. When the last character is displayed, touch the  on-screen button to display the first character of the title.

Interior Features

## Audio System

---

### **NOTE**

- The  on-screen button is displayed only when the whole title is not displayed.
- The information (artist name, music name) is displayed only when the USB memory has information which can be displayed on the screen.
- This unit cannot display some characters. Character which cannot be displayed are indicated by an asterisk (\*).
- The number of characters which can be displayed is restricted.

### **Error Messages**

If the message “USB Error” is displayed, it indicates that there is no playable file in the USB memory or there is an error in the USB memory. Verify that the content recorded in the USB memory has MP3/WMA/AAC files and re-connect correctly. If the message reappears, have the unit checked by an Authorized Mazda Dealer.

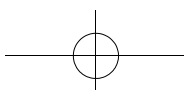

# MEMO

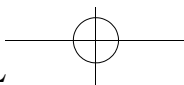
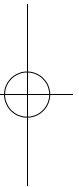
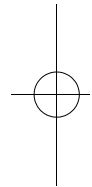

Interior Features

## Audio System

### ▼ How to use iPod mode (Type A)

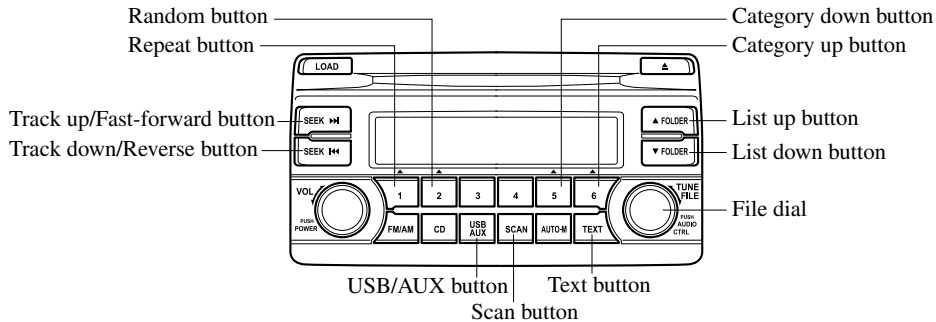

Connectable iPod is as follows:

- iPod: 5G
- iPod classic
- iPod nano: 1/2/3/4/5G
- iPod touch\*<sup>1</sup>: 1/2G
- iPhone\*<sup>1</sup>: 3G/3GS

\*1 For only iPod functions

#### **NOTE**

The iPod functions on the iPod cannot be operated while it is connected to the unit because the unit controls the iPod functions.

#### **Playback**

1. Switch the ignition to ACC or ON.
2. Press the power/volume dial to turn the audio system on.
3. Press the USB/AUX button (  ) to switch to the iPod mode and start playback.

#### **NOTE**

- When an iPod is not connected, the mode does not switch to the iPod mode.
- When there is no playable data in the iPod, "NO CONTENTS" is flashed.
- Do not remove the iPod while in the iPod mode. Otherwise, the data could be damaged.



#### **Fast-forward/Reverse**

Press and hold the fast-forward button (  ) to advance through a track at high speed.

Press and hold the reverse button (  ) to reverse through a track at high speed.

#### **Track search**

Press the track up button (  ) or turn the file dial clockwise once to skip forward to the beginning of the next track.

Press the track down button (  ) or turn the file dial counterclockwise within a few seconds after playback begins to track down. Press the track down button (  ) or turn the file dial counterclockwise after a few seconds have elapsed to start playback from the beginning of the track. The time required to track down/start playback from the beginning of a track varies depending on iPod software version.

#### **Category search**

Press the category down button (5) to select the previous category and press the category up button (6) to select the next category.





Interior Features  
**Audio System**

**NOTE**

The types of categories include Playlist, Artist, Album, Song, Podcast, Genre, Composer, and Audio book.

**List search**

Press the list down button (▼) to select the previous list and press the list up button (▲) to select the next list.

**NOTE**

When the selected category is Song or Audio book, there is no list.

**Music Scan**

This function scans the titles in a list currently being played and plays 10 seconds of each song to aid you in finding a song you want to listen to.

Press the scan button (**SCAN**) during playback to start the scan play operation (the track number will flash). Press the scan button (**SCAN**) again to cancel scan playback.

**NOTE**

If the unit is left in scan, normal playback will resume where scan was selected.

**Repeat playback**

Press the repeat button (1) during playback to repeat the playback of the song in the current list. "TRACK RPT" is displayed during playback.

Press the repeat button (1) while displaying "TRACK RPT" to cancel.

**Random playback**

**(Song random)**

Press the random button (2) during playback to play the tracks in the list randomly. "SONG RDM" is displayed during playback.

Press the random button (2) two times while "SONG RDM" is displayed to cancel.

**(Album random)**

Press the random button (2) two times during playback to play the songs in the iPod randomly. "ALBUM RDM" is displayed during playback.

Press the random button (2) while "ALBUM RDM" is displayed to cancel.

**NOTE**

The track number being played randomly is in the order of the iPod shuffle table.

**Switching the display**

For files with a file name and other information that have been input, the display switches between display of the file name and other information each time the text button (**TEXT**) is pressed during playback.

File number/Elapsed time

Category (Playlist title/Genre title  
/Composer title/Podcast title)

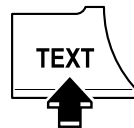

Artist name

Album name

Song name

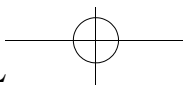

Interior Features

## Audio System

---

### **NOTE**

- *The information (artist name, music name) is displayed only when the iPod has information which can be displayed.*
- *This unit cannot display some characters. Characters which cannot be displayed are indicated by an asterisk (\*).*

### **Display scroll**

13 characters (Except file name) can be displayed at one time. To display the rest of the characters of a long title, press and hold the text button (**TEXT**). The display scrolls the next 13 characters. Press and hold the text button (**TEXT**) again after the last 13 characters have been displayed to return to the beginning of the title.

### **NOTE**

*The number of characters which can be displayed is restricted.*

### **Error Messages**

If the message “CHECK iPod” is displayed, it indicates that there is a malfunction in the iPod. Verify that the content recorded in the iPod has playable files and connect correctly. If the message reappears, have the unit checked by an Authorized Mazda Dealer.

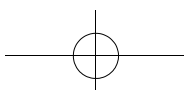

# MEMO

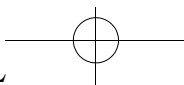
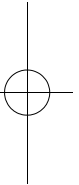
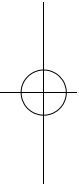

Interior Features  
**Audio System**

▼ **How to use iPod mode (Type B)**

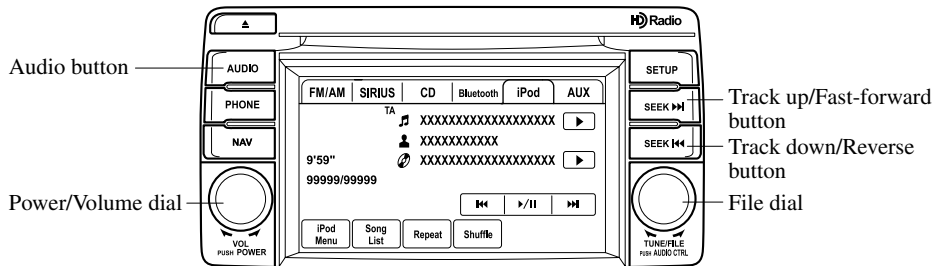

The connectable iPods are as follows:

- iPod: 5G
- iPod classic
- iPod nano: 1/2/3/4/5G
- iPod touch\*<sup>1</sup>: 1/2G
- iPhone\*<sup>1</sup>: 3G/3GS

\*1 Only iPod function

**NOTE**

*The iPod functions on the iPod cannot be operated while it is connected to the unit because the unit controls the iPod functions.*

**Playback**

1. Switch the ignition to ACC or ON.
2. Press the power/volume dial to turn the audio system on.
3. Press the audio button (AUDIO) to display the audio screen.
4. Touch the iPod on-screen tab to switch to the iPod mode and start playback.

**NOTE**

- When the iPod is connected to the USB port, the USB on-screen tab changes to the iPod on-screen tab.
- Do not remove the iPod while in the iPod mode. Otherwise, the data could be damaged.

**Pause**

Touch the >|| on-screen button to pause playback. Touch the >|| on-screen button while playback is paused to cancel the pause.

**Fast-forward/Reverse**

**Operations using audio panel**

Press and hold the fast-forward button (▶▶) to advance through a track at high speed.

Press and hold the reverse button (◀◀) to reverse through a track at high speed.

**Operations on screen**

Touch and hold the ▶▶ on-screen button to advance through a track at high speed.

Touch and hold the ◀◀ on-screen button to reverse through a track at high speed.

Interior Features  
**Audio System**

### **Track search**



#### **Operations using audio panel**

Press the track up button (▶▶) or turn the file dial clockwise once to skip forward to the beginning of the next track.

Press the track down button (◀◀) or turn the file dial counterclockwise within a few seconds after playback begins to track down. Press the track down button (◀◀) or turn the file dial counterclockwise after a few seconds have elapsed to start playback from the beginning of the track. The time required to track down/start playback from the beginning of a track varies depending on iPod software version.

#### **Operations on screen**

Touch the  on-screen button once to skip forward to the beginning of the next track.

Touch the  on-screen button within a few seconds after playback begins to track down. Touch the  on-screen button after a few seconds have elapsed to start playback from the beginning of the track. The time required to track down/start playback from the beginning of a track varies depending on iPod software version.

#### **Displaying song list**

The song list in the iPod can be viewed.

#### **NOTE**

*The song list may not display depending on the conditions.*

#### **(Displaying optional list)**

1. Touch the  on-screen button during playback.

2. Touch the category which you want to select. The record list or song list is displayed.

#### **(Displaying a list being played)**

Touch the  on-screen button.

#### **NOTE**

*Press the  on-screen button to display the upper list.*

#### **Selecting from list**



Select the desired song to play.



1. Press the  on-screen button to select the song list.
2. Touch the song you want to listen to.

#### **NOTE**

*The selected song list becomes the play list.*



#### **Repeat playback**



Touch the  on-screen button during playback. “” is displayed during playback.

Touch the  on-screen button two times while “” is displayed to cancel.



#### **Shuffle playback**



#### **(Shuffling songs in list being played)**

Touch the  on-screen button during playback. “” is displayed during playback.

Touch the  on-screen button two times while “” is displayed to cancel.

#### **(Shuffling album in list being played)**

Touch the  on-screen button two times during playback. “” is displayed during playback.

Touch the  on-screen button while “” is displayed to cancel.



Interior Features

## Audio System

### NOTE

The track number being shuffle played is in the order of the iPod shuffle table.

### Text scroll

If a whole title cannot be displayed at one time, touch the  on-screen button on the right side of the title to display the whole title. When the last character is displayed, touch the  on-screen button to display the first character of the title.

### NOTE

- The  on-screen button is displayed only when no titles are displayed.
- The information (artist name, music name) is displayed only when the iPod has information which can be displayed on the screen.
- This unit cannot display some characters. Characters which cannot be displayed are indicated by an asterisk (\*).
- The number of characters which can be displayed is restricted.

### Error Messages

If the message “iPod Error” is displayed, it indicates that there are no playable files in the iPod or there is a malfunction.

Verify that the content recorded in the iPod has playable files and re-connect correctly. If the message reappears, have the unit checked by an Authorized Mazda Dealer.

### ▼ Error Indications

If you see an error indication on the display, find the cause in the chart. If you cannot clear the error indication, take the vehicle to an Authorized Mazda Dealer.

Indication	Cause	Solution
CHECK USB		
USB Error	USB memory error	Connect other USB memory correctly. If the error indication continues to display, consult an Authorized Mazda Dealer.
CHECK iPod		
iPod Error	iPod malfunction	Connect other iPod correctly. If the error indication continues to display, consult an Authorized Mazda Dealer.

Interior Features  
**Bluetooth®**

**Bluetooth® \***

**Bluetooth® Hands-Free outline**

When a Bluetooth® device (mobile phone) is connected to the vehicle's Hands-Free unit via radio wave transmission, a call can be made or received by pressing the talk button, pick-up button, hang-up button, or voice command on the steering wheel, or by operating the panel. For example, even if a device (mobile phone) is in your coat pocket, a call can be made without taking the device (mobile phone) out and operating it directly.

**Bluetooth® audio outline**

When a portable audio unit equipped with the Bluetooth® communication function is programmed to the Bluetooth® unit, you can listen to music recorded on the programmed portable audio device from the vehicle's speakers. It is not necessary to connect the portable audio device to the vehicle's external input terminal. After programming, operate the vehicle audio control panel to play/setup the audio.

▼ **Before Using Bluetooth®**

**⚠ CAUTION**

- *A device can be programmed only when the vehicle is parked.*
- *The types of Bluetooth® mobile device which can be connected to the Bluetooth® unit are limited. However, even among these Bluetooth® mobile device there are ones which cannot be connected or have limited functionality. Each Bluetooth® mobile device to be used with the Bluetooth® system needs to be checked individually for compatibility. Therefore, consult an Authorized Mazda Dealer, a Web support center, or a call center for information regarding Bluetooth® mobile device compatibility:*

- **U.S.A.**  
Phone: 800-430-0153  
Web: [www.MazdaUSA.com/bluetooth](http://www.MazdaUSA.com/bluetooth)
- **Canada**  
Phone: 800-430-0153  
Web: [www.mazdahandsfree.ca](http://www.mazdahandsfree.ca)
- **Mexico**  
Center of Attention to Client (CAC)  
Phone: 01-800-01-MAZDA  
Web: [www.MazdaUSA.com/bluetooth](http://www.MazdaUSA.com/bluetooth)

**NOTE**

**(Available Languages)**

*The Bluetooth® Hands-Free System applies to the following languages:  
English, Spanish, Canadian French.  
Refer to Setup on page 5-55.*

Interior Features

## Bluetooth®

### ▼ Component Parts

#### Audio unit

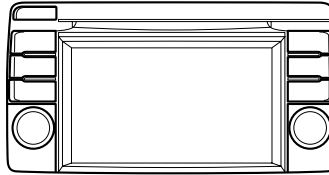

#### Talk button, Pick-up button and Hang-up button

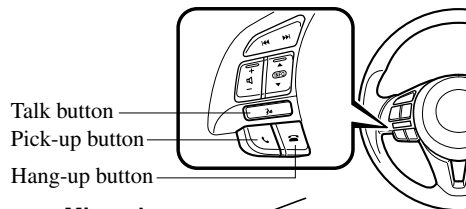

#### Microphone

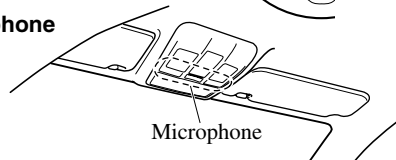

#### Audio unit (Type B)

The audio unit (Type B) is used for volume adjustment and touch panel operation. Bluetooth® information is displayed in the display. The screen is switched by touching the tab for each function to be used.

### **CAUTION**

*Do not press the panel strongly or press it with a sharp-pointed object.*

#### Display OFF

The audio unit display can be switched off by voice recognition operation.

1. Press the pick-up button or talk button.
2. Say: [Beep] "Display OFF"

#### Numeral or symbol entry

Use the numerical keypad.

Long-press the  on-screen button to input + .

Touch the  on-screen button to delete the currently input value.





### **Activating navigation system (vehicles with navigation system)**

The voice recognition command for the navigation system is activated.

1. Press the talk button.
2. **Prompt:** “Ready”
3. **Say:** [Beep] “Navigation”

### **Talk button, Pick-Up button and Hang-Up button (Hands-Free)**

The basic functions of Bluetooth® Hands-Free can be used for such things as making calls or hanging up using the talk button, pick-up button and hang-up button on the steering wheel.

### **Microphone (Hands-Free)**

The microphone is used for speaking voice commands or exchanging conversation.



### **▼ Volume Adjustment**

The power/volume dial of the audio unit is used to adjust the volume. Turn the dial to the right to increase volume, to the left to decrease it.

The volume can also be adjusted using the volume button on the steering wheel.

### **Pre-setting**

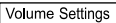
Conversation volume and the volume of the voice guidance and ringtone can each be set in advance.

1. Touch the  on-screen tab to display the Bluetooth® setting screen.
2. Touch the  on-screen button to display the volume adjustment screen.
3. **(Volume up)** Touch the  on-screen button.  
**(Volume down)** Touch the  on-screen button.
4. **Prompt:** “Phone call will be at this volume.” or “Voice guidance will be at this volume.”

### **NOTE**

*The volume of the audio unit cannot be adjusted while Bluetooth® Hands-Free is being used.*

### **▼ Voice Recognition**

To prevent a deterioration in the voice recognition rate and voice quality, the following points should be observed:

- The Hands-free system cannot perform voice recognition while voice guidance or a beep sound is operating. Wait until the voice guidance or the beep sound is finished before saying your commands.
- Dialects or different wording other than Hands-Free prompts cannot be recognized by voice recognition. Speak in the wording specified by the voice commands.
- It is not necessary to face the microphone or approach it. Speak the voice commands while maintaining a safe driving position.
- Do not speak too slow or too loud.
- Speak clearly, without pausing between words or numbers.

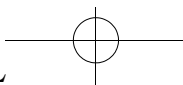

Interior Features

## Bluetooth®

- Close the windows and/or the moonroof to reduce loud noises from outside the vehicle, or turn down the airflow of the air-conditioning system while Bluetooth® Hands-Free is being used.
- Make sure the vents are not directing air towards the microphone.

### NOTE

*If the voice recognition performance is not satisfactory.*

*Refer to Troubleshooting on page 5-93.*

Please be aware that the voice recognition may still make an error despite following the above points.

When operating the audio unit or the A/C while using Bluetooth® Hands-Free, the beep sounds or voice guidance (audio unit)/cannot be heard.

### ▼ How to Use This Section

#### Voice recognition

Descriptions in the text are as follows:

**Say:** Voice commands to be spoken by you.

**Prompt:** Voice guidance output from the speaker.

### NOTE

*Say voice commands after the beep sound [Beep] is heard.*

Example)

**Say:** [Beep] “Dial”

**Prompt:** “Number, please”

**Say:** [Beep] “XXXXXXXXXXXX (Ex. “5551234”) (Telephone number)”

### Bluetooth® Hands-Free Activation Method

Press the pick-up button or talk button. The Hands-Free system is activated. Functions of the Hands-Free telephone, such as making and receiving calls, can be used after the activation. Refer to Bluetooth® Hands-Free on page 5-84.

### NOTE

- *Press the pick-up button to activate the phone mode. Press the talk button to activate the main menu. The phone, tutorial, or navigation mode can be activated in the main menu.*
- *For vehicles with a navigation system, the system operates by saying a voice recognition command of the navigation system after pressing the talk button with a short press. For voice recognition details with the navigation system, refer to the separate “NAVIGATION SYSTEM Owner’s Manual”.*

### (Tutorial)

The tutorial explains how to use Bluetooth® Hands-Free.

To activate the tutorial, do the following:

1. Press the talk button.
2. **Prompt:** “Ready”
3. **Say:** [Beep] “Tutorial”
4. Follow the prompts to receive the appropriate voice guidance instructions.

### Panel operation

### Bluetooth® Hands-Free Activation Method

Press the phone button (**PHONE** ).

Interior Features  
**Bluetooth®**

The Hands-Free system is activated. Functions of the Hands-Free telephone, such as making and receiving calls, can be used after the activation. Refer to Bluetooth® Hands-Free on page 5-84.

### ▼ Bluetooth® Preparation

#### **Device programming (Pairing)**

To use Bluetooth® Audio and Hands-Free, the device equipped with Bluetooth® has to be programmed to the unit using the following procedure. A maximum of seven devices including Bluetooth® audio devices and Hands-Free mobile phones can be programmed to one vehicle.

#### **NOTE**

- *A device can be programmed only when the vehicle is parked. If the vehicle starts to move, the pairing procedure will end. Attempting to program while driving is dangerous, therefore, pick-up your device before you start driving. Park the car in a safe place before programming.*
- *Since the communication range of a Bluetooth® equipped device is about 10 meters (32 ft), if a device is placed within a 10-meter (32 ft) radius of the vehicle, it may be detected/programmed unintentionally while another device is being programmed.*

Concerning the operation of a Bluetooth® audio device itself, refer to its instruction manual. Some Bluetooth® audio devices have PIN codes (four digits). Refer to the audio device's instruction manual because the programming procedure differs depending on whether it has a PIN code or not.

#### **Voice recognition**

1. Press the pick-up button.

2. **Prompt:** “Available options are: Call, Dial, Redial, Call back , Setup or Emergency.”
3. **Say:** [Beep] “Setup”
4. **Prompt:** “This operation can only be performed using the vehicle display. Select the desired option on the display. Note that some options are only available when the vehicle is stopped. Exiting Hands-Free mode.”
5. The Bluetooth® setting screen is displayed and the voice recognition mode is finished. Go to Step 3 below for the “Panel operation”.

#### **Panel operation**

1. Touch the **Setup** on-screen button.
2. Touch the **Bluetooth Setup** on-screen button. The list of pairing devices is displayed.
3. Touch the **Add New Device** on-screen button to display the message and switch to the device operation.
4. Using the device, perform a search for the Bluetooth® device (Peripheral device).
5. Select “Mazda” from the device list searched by the device.

Interior Features

## Bluetooth®

### NOTE

- If the Bluetooth® version for your device is 2.1 or higher, the SSP (Secure Simple Pairing) is used for indicating the pairing type without a PIN code input. The following two pairing methods for the SSP are available, and either method is selected automatically and performed.
  - Just Works
  - Numeric Comparison
- Some devices accept only a particular pairing code (Usually, "0000" or "1234"). If pairing cannot be completed, refer to the owner's manual of your mobile device, and try those numbers if necessary.

6. **(Device with Bluetooth® version 2.0)**  
Input the displayed 4-digit pairing code into the device.

**(Device with Bluetooth® version 2.1 or higher)**

- **Just Works is detected**  
The pairing is performed automatically.
- **Numeric Comparison is detected**  
Verify the displayed 6-digit code on the audio unit, which is also displayed on the device, and touch the  on-screen button.

7. **(Device with PBAP profile)**  
Call history (incoming/outgoing history) for the device is downloaded automatically.

After a device is registered, the system automatically identifies the device. By activating Bluetooth® Hands-Free again, or by activating Bluetooth® Hands-Free first after switching the ignition from OFF to ACC, the device connection condition is indicated in the display.

### Device selection



If several devices have been programmed, the Bluetooth® unit links the device last programmed. If you would like to link a different programmed device, it is necessary to change the link. The order of device priority after the link has been changed is maintained even when the ignition is switched off.

### NOTE

If the device name cannot be displayed, "... " is added at the end of the title which is displayed.



### Connecting other devices

1. Touch the  on-screen tab.
2. Touch the device name which you want to connect to display the device information screen.
3. Touch the  on-screen button to connect as a Hands-Free device. Touch the  on-screen button to connect as a Bluetooth® audio device.
4. Touch the  on-screen button.
5. **(Device with PBAP profile)**  
Call history (incoming/outgoing history) for the device is downloaded automatically.



If the connection is completed, the device name is displayed. Touch the  on-screen button to display the device list screen and display the  or  icon in the new device name which is connected.

### Disconnecting a device

1. Touch the  on-screen tab.
2. Touch the  on-screen button.

3. Touch the device name which is currently connected to display the device information screen.
4. Touch the  on-screen button to disconnect the Hands-Free device.  
Touch the  on-screen button to disconnect the audio device.
5. Touch the  on-screen button.

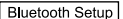
#### **Registered device deletion**



1. Touch the  on-screen tab.
2. Touch the  on-screen button.
3. Touch the device name which you want to delete.
4. Touch the  on-screen button.
5. Touch the  on-screen button.

#### **NOTE**

*If you want to delete all of the pairing devices, perform the restore default. Refer to Restore Default on page 5-83.*





#### **▼ Changing PIN Code**

PIN code (4 digits) can be changed.

1. Touch the  on-screen tab.
2. Touch the  on-screen button.
3. Delete the PIN code which is currently set.
4. Input the new PIN code to be set.
5. Touch the  on-screen button.

#### **▼ Restore Default**

All the pairing device information and phonebook data can be deleted.

1. Touch the  on-screen tab.
2. Touch the  on-screen button.
3. Touch the  on-screen button.
4. Touch the  on-screen button.

Interior Features

## Bluetooth®

### Bluetooth® Hands-Free

#### Applicable Bluetooth® specification

Ver. 2.0 or higher

#### Response profile

- HFP (Hands-Free Profile) Ver. 1.5
- DUN (Dial-up Networking Profile) Ver. 1.1
- PBAP (Phone Book Access Profile) Ver. 1.0
- OPP (Object Push Profile) Ver. 1.1

#### NOTE

- *The Bluetooth® Hands-Free system is operable several seconds after the ignition is switched to ACC or ON (requires less than 15 seconds).*
- *If the ignition is switched off during a Hands-Free call, the line is transferred to the device (Mobile phone) automatically.*

#### ▼ Making a Call Using a Telephone Number

#### NOTE

*Practice this while parked until you are confident you can do it while driving in a non-taxiing road situation. If you are not completely comfortable, make all calls from a safe parking position, and move out only when fully under control and you can devote your eyes and mind to driving.*

#### Voice recognition

1. Press the pick-up button.
2. **Prompt:** “Available options are: Call, Dial, Redial, Call back , Setup or Emergency.”
3. **Say:** [Beep] “Dial”
4. **Prompt:** “Dial. Number, please”
5. **Say:** [Beep] “XXXXXXXXXXXX (Ex. “5551234”) (Telephone number)

5-84

6. **Prompt:** “XXXXXXXXXXXX. (Ex “5551234”) (Telephone number (first choice))”
7. **Prompt:** “Press the pick-up button to dial, or continue to add numbers. You can also say ‘Option A’ or ‘Option B’ to replace the last block of digits with the displayed alternate, or say ‘Go Back’ to delete the last block of digits.”

#### NOTE

*The options may not be indicated depending on the conditions.*

#### 8. (Dialing)

Press the pick-up button or say, “Dial”, then go to Step 9.

#### (Adding/inputting telephone number)

Say, “XXXX” (desired telephone number). Then go to Step 9.

#### (The last recognized telephone number is replaced by Option A or B)

Say, “Option A” or “Option B”. Then go to Step 6.

#### (Telephone number correction)

Say, “Go Back”. The prompt replies, “The last entered numbers have been removed”. Then go back to Step 4 or Step 7.

9. The call is made.

#### NOTE



*The “Dial” command and a telephone number can be combined.*

*Ex. In Step 3, say, “Dial 1234567”, then, Steps 4 and 5 can be skipped.*

### **Panel operation**

1. Input the telephone number using the numerical keypad.
2. Touch the  on-screen button to make the call.

### **▼ Receiving an Incoming Call**

1. **Prompt:** “Incoming call, press the pick-up button to answer”
2. To accept the call, press the pick-up button or touch the  on-screen button.  
To reject the call, press the hang-up button or touch the  on-screen button.

### **▼ Hanging Up a Call**

Press the hang-up button or touch the  on-screen button during the call.

### **▼ Help Function Use**

The help function informs the user of all the available voice commands under the current conditions.

1. Press the pick-up button or talk button.
2. **Say:** [Beep] “Help”
3. Follow the prompts to receive the appropriate voice guidance instructions.

### **▼ Cancel**

The Bluetooth® Hands-Free system transitions to standby status if the following operation is performed while the system is activating. Press the hang-up button, or the talk button with a long press.

### **▼ Returning to Previous Operation**



This command is for returning to the previous operation while in the voice recognition mode.

**Say:** [Beep] “Go Back”

### **▼ Phonebook Usage**

#### **Import contact (Download Phonebook)**

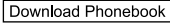
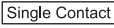

Phonebook data from your device (Mobile phone) can be sent and registered to your Bluetooth® Hands-Free phonebook using Bluetooth®.

1. Touch the  on-screen tab.
2. Touch the  on-screen button.
3. Touch the  or  on-screen button to switch to the device operation.

#### **NOTE**

- If the phonebook has been already registered to the Hands-Free unit during “all phonebooks download”, the current phonebook is overwritten.
  - A maximum of 1000 contacts can be registered to the phonebook.
  - Phonebook, incoming/outgoing call record, and speed dialing memory is exclusive to each mobile phone to protect privacy.
4. Download will be started from the mobile phone.

#### **Phonebook data deletion**

1. Touch the  on-screen tab.
2. Touch the contact information which you want to delete.
3. Touch the  on-screen button.

Interior Features

## Bluetooth®

### Making calls using the phonebook

#### Voice recognition

Telephone calls can be made by saying the name of a person (voice tag) whose phone number has been registered in Bluetooth® Hands-Free in advance. Refer to Import contact (Download Phonebook).

1. Press the pick-up button.
2. **Prompt:** “Available options are: Call, Dial, Redial, Call back , Setup or Emergency.”
3. **Say:** [Beep] “Call”
4. **Prompt:** “Call. Name, please.”
5. **Say:** [Beep] “XXXXXX... (Ex. “John”)”  
(Say a name registered in the phonebook.)  
The name spoken will be searched for in the phonebook.  
If a contact is matched, go to Step 7.  
If multiple contacts are matched, go to Step 6.

#### **NOTE**

*If multiple contacts or a name with a similar pronunciation to the name you spoke has been registered to the phonebook, multiple contact information may be identified in the phonebook. If multiple contacts are identified in the phonebook, a maximum of three contacts are listed as a dialing choice.*

6. **Prompt:** “Would you like to call XXXXX... (Choice 1)?”  
**(Person you would like to call)**  
**Say:** [Beep] “Yes.” Then go to Step 7.  
**(Person you do not want to call)**  
**Say:** [Beep] “No” Then go to Step 6  
(Maximum 3 times)

7. **Prompt:** “Would you like to call XXXXX... (Ex. “John”) at home, at work, or mobile, or other... or press the hang-up button to exit Hands-Free mode.”
8. **Say:** [Beep] “XXXXXX... (Ex. “at home”)”
9. **Prompt:** “XXXXXX... (Ex. “John”) XXXX (Ex. “at home”). Press the pick-up button to call, or say Go Back to enter a different name.”
10. **(Dialing)** Press the pick-up button or say “Call”. Then go to Step 11.  
**(Name correction)** Say, “Go Back”. Then go back to Step 4.
11. The call is made.

#### **NOTE**

*The “Call” command and the voice tag can be combined.*

*Ex. In Step 3, say, “Call John’s phone”, then, Steps 4 and 5 can be skipped.*

#### **Panel operation**

1. Touch the  on-screen tab to display the phonebook screen.
2. Touch the contact you would like to call to display the screen indicating the details for the contact.
3. Touch the desired phone number to make the call.



### ▼ Making a Call Using the Call History

A call can be made using the call history (incoming/outgoing history) downloaded from the mobile phone (Redial/Call back). The call history is downloaded automatically when connecting or pairing the Hands-Free and mobile phone.

#### **Redial Function**

1. Press the pick-up button.
2. **Prompt:** “Available options are: Call, Dial, Redial, Call back , Setup or Emergency.”
3. **Say:** [Beep] “Redial”
4. A call is made to the most recent call in the Call history (outgoing).

#### **Call back Function**

1. Press the pick-up button.
2. **Prompt:** “Available options are: Call, Dial, Redial, Call back , Setup or Emergency.”
3. **Say:** [Beep] “Call back”
4. A call is made to the most recent call in the Call history (incoming).

### ▼ Emergency calls

A call can be made to the emergency phone number (911: U.S.A./Canada, 066: Mexico) using the voice input command. It may not function properly in some areas in Mexico.





1. Press the pick-up button.
2. **Prompt:** “Available options are: Call, Dial, Redial, Call back, Setup, or Emergency.”
3. **Say:** [Beep] “Emergency”

4. **Prompt:** “Emergency. Press the Pick-Up button to dial the Emergency number.”
5. (Dialing) Press the pick-up button or say “Call.”
6. **Prompt:** “Dialing XXX (911: U.S.A/C anada, 066: Mexico).”

### ▼ Speed Dial Usage

A maximum of eight telephone numbers can be registered. It will take less time to make a call after registering the telephone number. In addition, you do not have to look for the person you want to call in the phonebook.

#### **Speed Dial registration from phonebook**

1. Touch the  on-screen tab.
2. **(New registration)**  
Touch the  on-screen button.  
**(Changing registered contacts to other contacts)**  
Touch the  on-screen button.
3. Touch the  on-screen button.
4. Touch the contact you would like to register to the speed dial.
5. Touch the telephone number you would like to register.
6. Verify that the registered name and telephone number are displayed in the phonebook, and touch the  on-screen button.



#### **Making calls using the Speed Dial**

1. Touch the  on-screen tab.
2. Touch the contact information you would like to call.

Interior Features



## Bluetooth®

### **Speed Dial data deletion**

1. Touch the  on-screen tab.
2. Touch the  on-screen button for the contact you would like to delete.
3. Touch the  on-screen button to display the confirmation screen.

### **▼ Mute**

The microphone can be muted during a call.

Touch the  on-screen button.  
Touch the  on-screen button during mute to cancel the mute.

### **▼ Transferring a Call**

#### **Transferring a call from Hands-Free to a mobile phone**

Communication between the Hands-Free unit and a device (Mobile phone) is canceled, and the line can be switched to a standard call using a device (Mobile phone).

Touch the  on-screen button.

#### **Transferring a call from a device (mobile phone) to Hands-Free**

Communication between devices (mobile phone) can be switched to Bluetooth® Hands-Free.

Touch the  on-screen button.

### **▼ Multi-Call Functions**

#### **Call waiting**

A call can be interrupted to receive an incoming call from a third party.

### **Call interrupt**

A call can be switched to a new incoming call.

Touch the  on-screen button or press the pick-up button on the steering wheel.

#### ***NOTE***

- *After receiving a new incoming call, the previous call is placed on hold.*
- *Touch the  on-screen button or press the hang-up button on the steering wheel to refuse a call.*

### **Switching calls**

Switching back to the previous call can also be done.

Touch the  on-screen button or press the pick-up button on the steering wheel.

### **Three-way call function**

Touch the  on-screen button.

### **▼ DTMF (Dual Tone Multi-Frequency Signal) Transmission**

This function is used when transmitting DTMF via the Numerical Keypad. The receiver of a DTMF transmission is generally a home telephone answering machine or a company's automated guidance call center.

1. Touch the  on-screen button after connecting to a home device or service to display the tone transmission screen.
2. Input the number using a numerical keypad.

#### ***NOTE***

*If the DTMF code has two or more digits or symbols, each one must be transmitted individually.*

▼ **Mazda Bluetooth® Hands-Free Customer Service**

- U.S.A.  
 Phone: 800-430-0153 (Toll-free)  
[www.MazdaUSA.com/bluetooth](http://www.MazdaUSA.com/bluetooth)
- Canada  
 Phone: 800-430-0153 (Toll-free)  
[www.mazdahandsfree.ca](http://www.mazdahandsfree.ca)
- Mexico  
 Center of Attention to Client (CAC)  
 Phone: 01-800-01-MAZDA (Toll-free)  
[www.MazdaUSA.com/bluetooth](http://www.MazdaUSA.com/bluetooth)

**Bluetooth® Audio**

**Applicable Bluetooth® specification**  
 Ver. 2.0 or higher

**Response profile**

- A2DP (Advanced Audio Distribution Profile) Ver. 1.0/1.2
- AVRCP (Audio/Video Remote Control Profile) Ver. 1.0/1.3/1.4

A2DP is a profile which transmits only audio to the Bluetooth® unit. If your Bluetooth® audio device corresponds only to A2DP, but not AVRCP, you cannot operate it using the control panel of the vehicle's audio system. In this case, the Bluetooth® audio device can be operated by controlling the device itself, the same as when a portable audio system without the Bluetooth® communication function is connected to the AUX terminal.

Function	A2DP	A2DP·AVRCP		
		Ver. 1.0	Ver. 1.3	Ver. 1.4
Playback	—	X	X	X
Pause	—	X	X	X
File (Track) up/down	—	X	X	X
Reverse	—	—	X	X
Fast-forward	—	—	X	X
Text display	—	—	X	X
Folder up/down	—	—	—	X
Repeat	—	—	—	X
Random	—	—	—	X
Scan	—	—	—	X

X: Available  
 —: Not available

Interior Features

## Bluetooth®

### NOTE

- The system may not operate normally depending on the Bluetooth® audio device.
- To make sure that your Bluetooth® audio device is Ver. 1.0, 1.3 or 1.4, refer to the Owner's Manual for the Bluetooth® audio device.
- The battery consumption of Bluetooth® audio devices is higher while Bluetooth® connected.

### USB connecting

If a general mobile phone device is USB connected during music playback over the Bluetooth® connection, the Bluetooth® connection is disconnected. For this reason, you cannot have music playback over a Bluetooth® connection and music playback using a USB connection at the same time.

### ▼ How to Use the Bluetooth® Audio System

#### Switching to Bluetooth® audio mode

To listen to music or voice audio recorded to a Bluetooth® audio device, switch to the Bluetooth® audio mode to operate the audio device using the audio system control panel. Any Bluetooth® audio device must be programmed to the vehicle's Bluetooth® unit before it can be used.

Refer to Bluetooth® Preparation on page 5-81.

1. Switch the ignition to ACC or ON.
2. Turn on the Bluetooth® audio device's power.  
Make sure that the “Ⓜ” symbol is displayed in the audio unit's display.

### NOTE

Some Bluetooth® audio devices need a certain amount of time before the “Ⓜ” symbol is displayed in the audio unit's display.

3. Press the audio button (AUDIO) and then touch the  on-screen tab to switch to the Bluetooth® audio mode and start playback.

### NOTE



- If the Bluetooth® audio device does not begin playback, press the  on-screen button.
- If the mode is switched from Bluetooth® audio mode to another mode (radio mode), audio playback from the Bluetooth® audio device stops.

### Playback



1. To listen to a Bluetooth® audio device over the vehicle's speaker system, switch the mode to Bluetooth® audio mode. (Refer to “Switching to Bluetooth® audio mode”)
2. To stop playback, press the  on-screen button.
3. Press the button again to resume playback.

### Selecting a file (track)

#### Selects the next file (track)

Short-press the track up button () or touch the  on-screen button.

#### Selects the beginning of the current file (track)

Short-press the track down button () or touch the  on-screen button.

Interior Features  
**Bluetooth®**

**Fast-forward/Reverse (AVRCP Ver. 1.3 or higher)**



**Fast-forward**

Press and hold the fast-forward button (▶▶) or touch and hold the  on-screen button.

**Reverse**



Press and hold the reverse down button (◀◀) or touch and hold the  on-screen button.

**Folder search (only AVRCP Ver. 1.4)**

To change to the previous folder, touch the  on-screen button, or touch the  on-screen button to advance to the next folder.

**Music scan (only AVRCP Ver. 1.4)**

This function scans the titles in a folder currently being played and plays 10 seconds of each song to aid you in finding a song you want to listen to.

1. Touch the  on-screen button during playback to play 10 seconds of each subsequent track starting from the next song.
2. Touch the  on-screen button again during playback of the song which you want to listen to continue the playback from that point.

**Repeat playback (only AVRCP Ver. 1.4)**

**Track repeat**

Touch the  on-screen button to play the song during playback repeatedly. “🎵” is displayed during playback.

Touch the  on-screen button two times while “🎵” is displayed to cancel.

**Folder repeat**

Touch the  on-screen button two times to play the songs in the folder repeatedly. “📁” is displayed during playback.

Touch the  on-screen button while “📁” is displayed to cancel.

**Shuffle playback (only AVRCP Ver. 1.4)**

**Folder shuffle**

Touch the  on-screen button during playback to play the songs in the folder shuffle. “📁” is displayed during playback.



Touch the  on-screen button two times while “📁” is displayed to cancel.

**Device shuffle**

Touch the  on-screen button two times during playback to play the songs in the device shuffle. “📁” is displayed during playback.

Touch the  on-screen button while “📁” is displayed to cancel.

**Display scroll**

If a whole title cannot be displayed at one time, touch the  on-screen button on the right side of the title. When the last character is displayed, touch the  on-screen button to display the first character of the title.

Interior Features

## Bluetooth®

---

### ▼ Bluetooth® Audio Device Information Display

If a Bluetooth® audio device is connected, the following information is displayed in the display.

	AVRCP Ver. lower than 1.3	AVRCP Ver. 1.3	AVRCP Ver. 1.4 or higher
Device name	X	X	X
Remaining battery charge of device	—	X	X
Title	—	X	X
Artist name	—	X	X
Album name	—	X	X
File number	—	X	X
Playback time	—	X	X
Folder number	—	—	X

#### **NOTE**

*Some information may not display depending on the device, and if the information cannot be displayed, "-----" is indicated.*

## Troubleshooting

Bluetooth® does not operate under the following conditions. Check whether the following conditions apply to your Bluetooth® device:

- The device is not being operated correctly.
- The device is not connected to the Bluetooth® unit equipped on the vehicle.
- The device's battery is weak.
- A device which interferes with radio wave reception has been placed in the vehicle.
- The ignition switch has been turned off.

If none of the above conditions apply, refer to the following to see if any of the problem symptoms correspond to your device.

If the problem cannot be resolved, consult an Authorized Mazda Dealer or Mazda Bluetooth® Hands-Free Customer Service.

### **Device pairing, connection problems**

Symptom	Cause	Solution method
Unable to perform pairing	—	First make sure the device is compatible with the Bluetooth® unit, and then check whether the Bluetooth® function and the Find Mode/Visible setting*1 on the device are turned on. If pairing is still not possible after this, contact an Authorized Mazda Dealer or Mazda Bluetooth® Hands-Free Customer Service.
Unable to perform pairing	The Bluetooth® function and the Find Mode/Visible setting*1 on the device may turn off automatically after a period of time has elapsed depending on the device.	Check whether the Bluetooth® function and the Find Mode/Visible setting*1 on the device are turned on and pairing or reconnect.
Does not connect automatically when starting the engine		
Automatically connects, but then disconnects suddenly		
Disconnects intermittently	Is the device in a location in which radio wave interference can occur easily? (Inside a bag in a rear seat, in the rear pocket of a pair of pants)	Move the device to a location in which radio wave interference is less likely to occur.

\*1 Setting which detects the existence of a device external to the Bluetooth® unit

Interior Features

**Bluetooth®**

**Voice recognition related problems**

Symptom	Cause	Solution method
Poor voice recognition False recognition of numbers	<ul style="list-style-type: none"> <li>Excessive, slow speech.</li> <li>Excessive, forceful speech (shouting).</li> <li>Speaking before the beep sound has ended.</li> <li>Loud noise (speaking or noise from outside/inside vehicle).</li> <li>Airflow from A/C is blowing against the microphone.</li> <li>Speaking in off-standard expressions (dialect).</li> </ul>	Regarding the causes indicated on the left, be careful with how you speak. In addition, when numbers are spoken in a sequence, recognition ability will improve if no stop is placed between the numbers.
Names in the phonebook are not easily recognized	The Bluetooth® system is under a condition in which recognition is difficult.	By carrying out the following measures, the rate of recognition will improve. <ul style="list-style-type: none"> <li>Clear memory from the phonebook which is not used very often.</li> <li>Avoid shortened names, use full names.</li> </ul> (Recognition improves the longer the name is. By not using names such as "Mom", "Dad", recognition will improve.)
You want to skip guidance.	—	Guidance can be skipped by quickly pressing and releasing the Talk button.
When the Talk button is pressed, voice recognition ends	Is the Talk button being held pressed for too long?	Operate the Talk button as follows: <ul style="list-style-type: none"> <li>Press the button and release it within 0.7 seconds to start voice recognition and skip the guidance.</li> <li>Press the button for longer than 0.7 seconds to turn off voice recognition or end a conversation.</li> </ul>

**Regarding problems with calls**

Symptom	Cause	Solution method
When starting a call, vehicle noise from the other party can be heard.	For about three seconds after starting a call, the Bluetooth® unit's Noise Suppression function requires time to adapt to the call environment.	This does not indicate a problem with the device.
The other party cannot be heard or the speaker's voice is quiet	Is the volume set at zero or low?	Increase the volume.



Interior Features  
**Bluetooth®**

**Other problems**

Symptom	Cause	Solution method
The indication for the remaining battery is different between the vehicle and the device.	The indication method is different between the vehicle and the device.	—
When a call is made from the vehicle, the telephone number is updated in the incoming/outgoing call record but the name does not appear.	Has the number been registered into the phonebook?	If the number has been registered into the phonebook, the incoming/outgoing call record is updated by the name in the phonebook when the engine is restarted.
The cell phone does not synchronize with the vehicle regarding the incoming/outgoing call record.	Some types of cell phones do not synchronize automatically.	Operate the cell phone for synchronization.
It takes a long time to complete the function for changing the language.	A maximum of 30 seconds is required.	—

Interior Features

## Interior Equipment

### Sunvisors

When you need a sunvisor, lower it for use in front or swing it to the side.

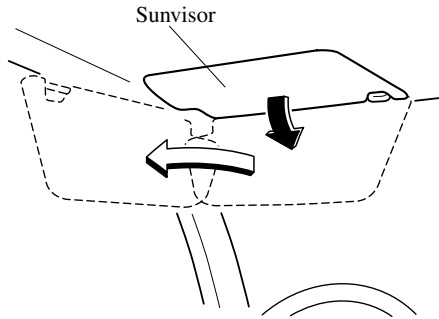

### ▼ Side Extension Sunvisors \*

The visor extender extends the sun visor's range of sun shading.  
To use, pull it out.

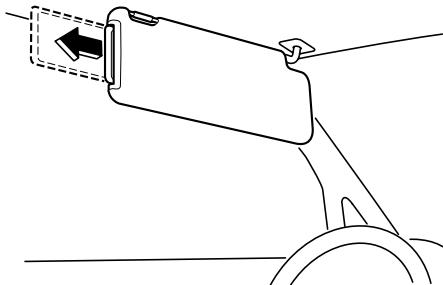

### **⚠ CAUTION**

*When moving the sunvisor, retract the visor extender to its original position. Otherwise, the visor extender could hit the rearview mirror.*

### ▼ Vanity Mirrors

To use the vanity mirror, lower the sunvisor.

If your vehicle is equipped with a vanity mirror light, it will illuminate when you open the cover.

## Interior Equipment

### Interior Lights

#### Overhead Lights

Switch Position	Overhead Lights
OFF	Light off
DOOR	<ul style="list-style-type: none"> <li>Light is on when any door is open</li> <li>Light is on or off when the illuminated entry system is on</li> </ul>
ON	Light on

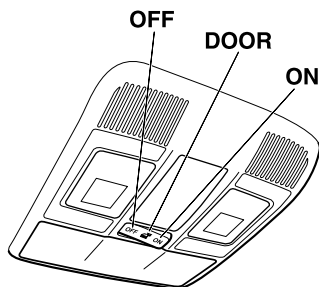

#### Map Lights

When the front overhead light switch is in the DOOR or OFF position, press the lens to illuminate the map lights, and then press the lens again to turn them off.

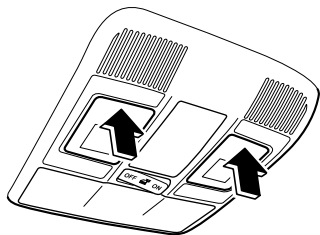

#### NOTE

The map lights will not turn off even if the lens is pressed in the following cases:

- The front overhead light switch is ON.
- The front overhead light switch is in the DOOR position with the door open.
- The illuminated entry system is on.

#### Rear Map Lights

When the front overhead light switch is in the DOOR or OFF position, press the lens to illuminate the rear map light, and then press the lens again to turn it off.



#### NOTE

- The rear map light illuminates/turns off when you turn the front overhead light switch on or off.
- The rear map light will not turn off even if the lens is pressed in the following cases:
  - The front overhead light switch is ON.
  - The front overhead light switch is in the DOOR position with the door open.
  - The illuminated entry system is on.

Interior Features

## Interior Equipment

### Luggage Compartment Lights

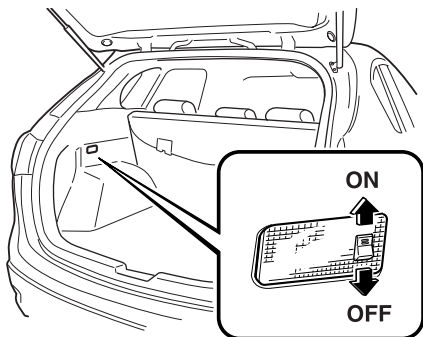

Switch Position	Luggage Compartment Light
OFF	Light off
ON	Light on when the liftgate is open

### ▼ Illuminated Entry System

When the illuminated entry system operates, the overhead light (switch is in the DOOR position) turn on for:

- About 30 seconds after the driver's door is unlocked and the ignition is switched off.
- About 15 seconds after all doors are closed and the ignition is switched off.
- About 5 seconds after all doors are closed and the ignition is switched off when key is out of the vehicle.
- Illuminates for about 15 seconds when the ignition is returned from ACC to OFF.

The light also turns off when:

- The ignition is switched on and all doors are closed.
- The driver's door is locked.

### NOTE

- **Battery saver**  
*If any door or the liftgate is left opened, the light goes out after about 30 minutes to save the battery.*
- *The operation of the illuminated entry system can be changed. Refer to Personalization Features on page 9-8.*

## Interior Equipment

### Clock

The time is displayed when the ignition is switched to ACC or ON.

#### With Fully Automatic Type Climate Control System

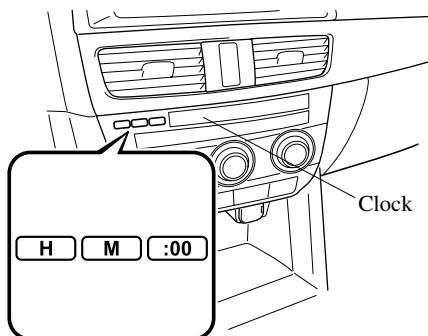

#### With Manual Type Climate Control System

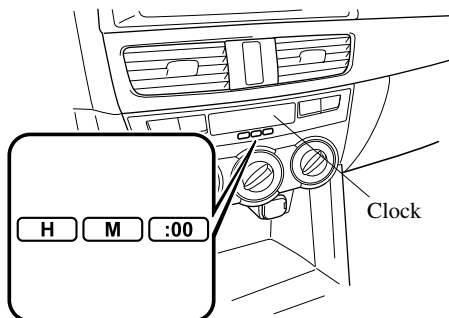

#### Time setting

1. Switch the ignition ACC or ON.
2. Adjust the time using the time setting buttons (H , M ).  
The hours advance while the time setting button (H ) is pressed.  
The minutes advance while the time setting button (M ) is pressed.

#### Time resetting

1. Switch the ignition to ACC or ON.
2. Press the :00 button.
3. When the button is pressed, the time will be reset as follows:

(Example)

12:01—12:29→12:00

12:30—12:59→1:00

#### **NOTE**

*When the :00 button is pressed, the seconds will start at "00".*

Interior Features

## Interior Equipment

### Accessory Sockets

Only use genuine Mazda accessories or the equivalent requiring no greater than 120 W (DC 12 V, 10 A).

#### Front

The ignition must be switched to ACC or ON.

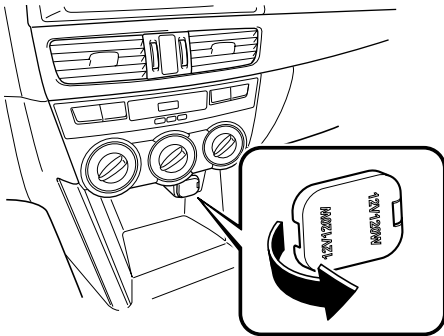

#### Center, Rear

The accessory sockets can be used regardless of whether the ignition is on or off.

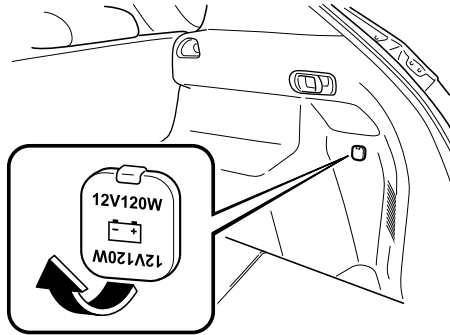
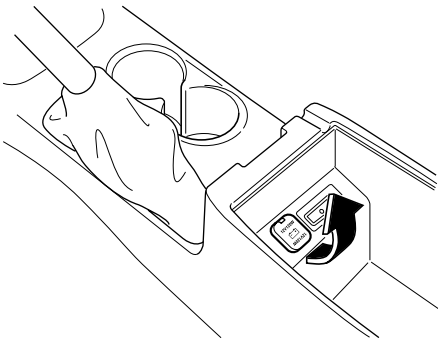

## Interior Equipment

### **CAUTION**

- *To prevent accessory socket damage or electrical failure, pay attention to the following:*
  - *Do not use accessories that require more than 120 W (DC 12 V, 10 A).*
  - *Do not use accessories that are not genuine Mazda accessories or the equivalent.*
  - *Close the cover when the accessory socket is not in use to prevent foreign objects and liquids from getting into the accessory socket.*
  - *Correctly insert the plug into the accessory socket.*
  - *Do not insert the cigarette lighter into the accessory socket.*
- *Noise may occur on the audio playback depending on the device connected to the accessory socket.*
- *Depending on the device connected to the accessory socket, the vehicle's electrical system may be affected, which could cause the warning light to illuminate. Disconnect the connected device and make sure that the problem is resolved. If the problem is resolved, disconnect the device from the socket and switch the ignition off. If the problem is not resolved, consult an Authorized Mazda Dealer.*

### **NOTE**

*To prevent discharging of the battery, do not use the socket for long periods with the engine off or idling.*

### **Connecting the accessory socket**

1. Open the lid.
2. Pass the connection plug cord through the cutout of the console and insert the plug into the accessory socket.

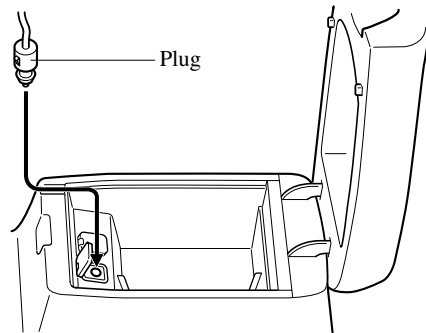

Interior Features

## Interior Equipment

### Cup Holder

#### **⚠ WARNING**

**Never use a cup holder to hold hot liquids while the vehicle is moving:**

*Using a cup holder to hold hot liquids while the vehicle is moving is dangerous. If the contents spill, you could be scalded.*

**Do not put anything other than cups or drink cans in cup holders:**

*Putting objects other than cups or drink cans in a cup holder is dangerous. During sudden braking or maneuvering, occupants could be hit and injured, or objects could be thrown around the vehicle, causing interference with the driver and the possibility of an accident. Only use a cup holder for cups or drink cans.*

#### ▼ Front

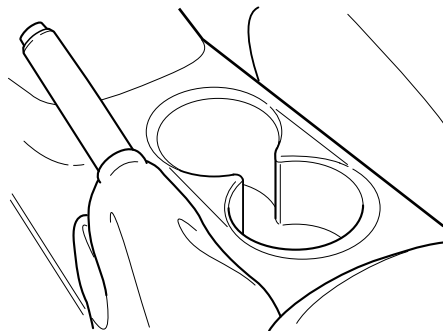

#### ▼ Rear \*

The rear cup holder is on the rear center armrest.

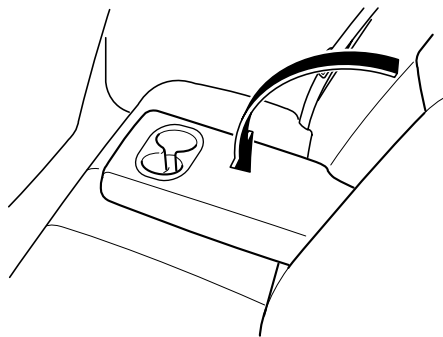



## Interior Equipment

### Bottle Holder

Bottle holders are on the inside of the doors.

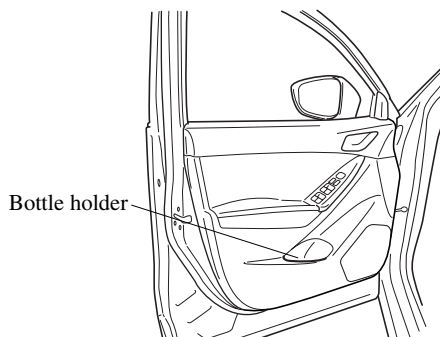

#### **CAUTION**

*Do not use the bottle holders for containers without caps. The contents may spill when the door is opened or closed.*

### Storage Compartments

#### **WARNING**

*Keep storage boxes closed when driving:*

*Driving with the storage boxes open is dangerous. To reduce the possibility of injury in an accident or a sudden stop, keep the storage boxes closed when driving.*

#### **CAUTION**

*Do not leave lighters or eyeglasses in the storage boxes while parked under the sun. A lighter could explode or the plastic material in eyeglasses could deform and crack from high temperature.*

#### ▼ Overhead Console

This console box is designed to store eyeglasses or other accessories. Push and release to open.

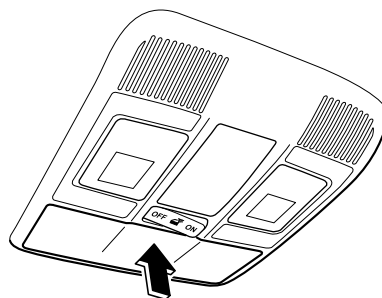

Interior Features

## Interior Equipment

### ▼ Glove Compartment

To open the glove compartment, pull the latch toward you.

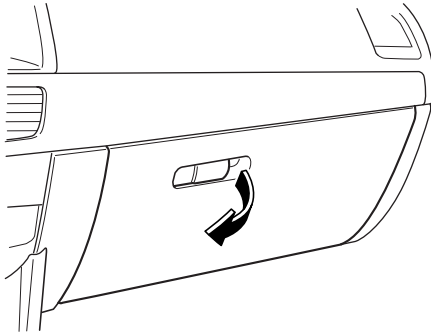

### ▼ Center Console

To open, pull the release latch.

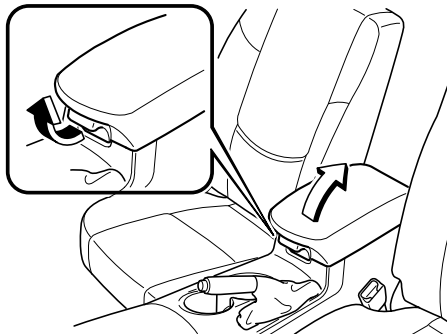

### Storage tray

The storage tray can be removed.

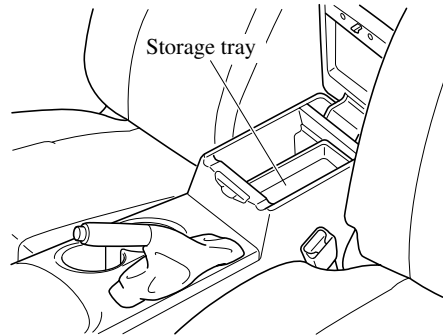

### ▼ Cargo Securing Loops

#### **⚠ WARNING**

***Make sure luggage and cargo is secured before driving:***

***Not securing cargo while driving is dangerous as it could move or be crushed during sudden braking or a collision and cause injury.***

Use the loops in the luggage compartment to secure cargo with a rope or net. The tensile strength of the loops is 196 N (20 kgf, 44 lbf). Do not apply excessive force to the loops as it will damage them.

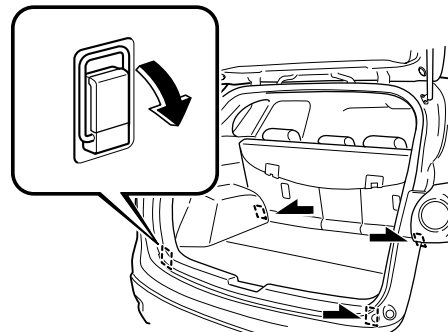

## Interior Equipment

### ▼ Rear Coat Hooks

#### **! WARNING**

**Never hang heavy or sharp objects on the assist grips and coat hooks:**

*Hanging heavy or sharp-ended objects such as a coat hanger from the assist grips or coat hooks is dangerous as they can fly off and hit an occupant in the cabin if a curtain air bag was to deploy, which could result in serious injury or death.*

Always hang clothes on the coat hooks and the assist grips without hangers.

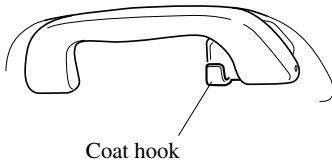

### ▼ Luggage Compartment

Golf bags can be carried in the luggage compartment. Up to four golf bags can be carried in the luggage compartment.

Place each of the first three golf bags into the luggage compartment with the bottom of each bag pointed to the right, and then set the top of each bag so that it is pointed to the left.

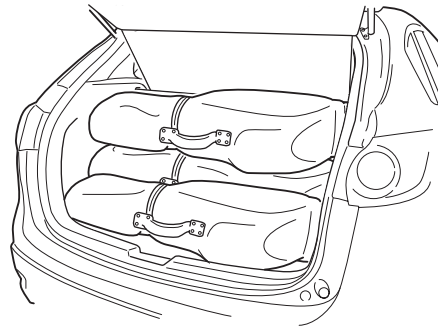
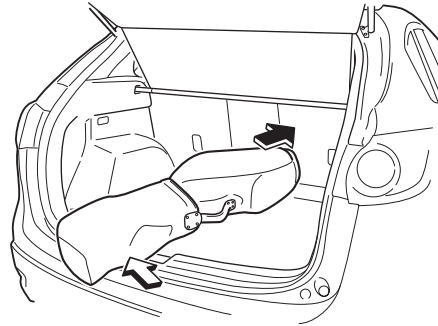

Place the fourth golf bag with its top pointed to the left, and then set the bottom of the bag so that it is pointed to the right.

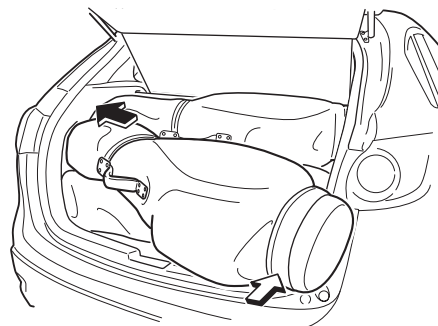



Interior Features

## Interior Equipment

---

**NOTE**

*Some golf bags cannot fit depending on their size.*

**5-106**

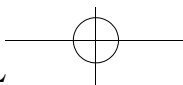



# 6 Maintenance and Care

How to keep your Mazda in top condition.

<b>Essential Information .....</b>	<b>6-2</b>
Introduction .....	6-2
<b>Scheduled Maintenance .....</b>	<b>6-3</b>
Scheduled Maintenance (U.S.A., Canada, and Puerto Rico) ....	6-3
Scheduled Maintenance (Mexico) .....	6-8
<b>Owner Maintenance .....</b>	<b>6-15</b>
Owner Maintenance Precautions .....	6-15
Hood .....	6-17
Engine Compartment Overview .....	6-19
Engine Oil .....	6-20
Engine Coolant .....	6-22
Brake/Clutch Fluid .....	6-24
Washer Fluid .....	6-25
Body Lubrication .....	6-26
Wiper Blades .....	6-26
Battery .....	6-30
Replace Electrical Battery .....	6-32
Tires .....	6-35
Light Bulbs .....	6-40
Fuses .....	6-49
<b>Appearance Care .....</b>	<b>6-55</b>
Exterior Care .....	6-55
Interior Care .....	6-60

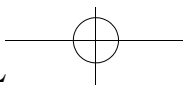

Maintenance and Care

## Essential Information

---

### Introduction

Be extremely careful and prevent injury to yourself and others or damage to your vehicle when using this manual for inspection and maintenance.

If you are unsure about any procedure it describes, we strongly urge you to have a reliable and qualified service shop perform the work, preferably an Authorized Mazda Dealer.

Factory-trained Mazda technicians and genuine Mazda parts are best for your vehicle. Without this expertise and the parts that have been designed and made especially for your Mazda, inadequate, incomplete, and insufficient servicing may result in problems. This could lead to vehicle damage or an accident and injuries.

For expert advice and quality service, consult an Authorized Mazda Dealer.

The owner should retain evidence that proper maintenance has been performed as prescribed.

Claims against the warranty resulting from lack of maintenance, as opposed to defective materials or authorized Mazda workmanship, will not be honored.

Any auto repair shop using parts equivalent to your Mazda's original equipment may perform maintenance. **But we recommend that it always be done by an Authorized Mazda Dealer using genuine Mazda parts.**

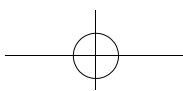

Maintenance and Care  
**Scheduled Maintenance**

---

**Scheduled Maintenance (U.S.A., Canada, and Puerto Rico)**

Follow Schedule 1 if the vehicle is operated mainly where none of the following conditions apply.

- Repeated short-distance driving
- Driving in dusty conditions
- Driving with extended use of brakes
- Driving in areas where salt or other corrosive materials are used
- Driving on rough or muddy roads
- Extended periods of idling or low-speed operation
- Driving for long periods in cold temperatures or extremely humid climates
- Driving in extremely hot conditions
- Driving in mountainous conditions continually

If any do apply, follow Schedule 2 (Canada and Puerto Rico residents follow Schedule 2).

**NOTE**

*After the prescribed period, continue to follow the described maintenance at the recommended intervals.*

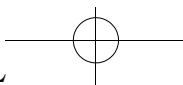

Maintenance and Care

# Scheduled Maintenance

## ▼ Schedule 1

Maintenance Interval	Number of months or kilometers (miles), whichever comes first								
	Months	6	12	18	24	30	36	42	48
	×1000 km	12	24	36	48	60	72	84	96
	×1000 miles	7.5	15	22.5	30	37.5	45	52.5	60
<b>ENGINE</b>									
Drive belts						I			
Engine oil	R	R	R	R	R	R	R	R	R
Engine oil filter	R	R	R	R	R	R	R	R	R
<b>COOLING SYSTEM</b>									
Engine coolant	FL22 type*1	Replace at first 192,000 km (120,000 miles) or 10 years; after that, every 96,000 km (60,000 miles) or 5 years							
	Others	Replace at first 96,000 km (60,000 miles) or 4 years; after that, every 2 years							
<b>FUEL SYSTEM</b>									
Air filter						R			
Fuel lines and hoses*2					I				I
Hoses and tubes for emission*2									I
<b>IGNITION SYSTEM</b>									
Spark plugs	Replace every 120,000 km (75,000 miles)								
<b>CHASSIS and BODY</b>									
Brake lines, hoses and connections					I				I
Disc brakes		I			I		I		I
Tire (Rotation)	Rotate every 12,000 km (7,500 miles)								
Steering operation and linkages					I				I
Front and rear suspension, ball joints and wheel bearing axial play					I				I
Rear differential oil	*3*4								
Transfer oil	*4								
Driveshaft dust boots					I				I
Bolts and nuts on chassis and body					T				T
Exhaust system and heat shields	Inspect every 72,000 km (45,000 miles) or 5 years								
All locks and hinges	L	L	L	L	L	L	L	L	L



Maintenance and Care  
**Scheduled Maintenance**

Maintenance Interval	Number of months or kilometers (miles), whichever comes first								
	Months	6	12	18	24	30	36	42	48
	×1000 km	12	24	36	48	60	72	84	96
	×1000 miles	7.5	15	22.5	30	37.5	45	52.5	60
<b>AIR CONDITIONER SYSTEM</b>									
Cabin air filter					R				R

**Chart symbols:**

**I:** Inspect: Inspect and clean, repair, adjust, fill up, or replace if necessary.

**R:** Replace

**L:** Lubricate

**T:** Tighten

**Remarks:**

- \*1 Use FL22 type coolant in vehicles with the inscription "FL22" on the radiator cap itself or the surrounding area. Use FL22 when replacing the coolant.
- \*2 According to state/provincial and federal regulations, failure to perform maintenance on these items will not void your emissions warranties. However, Mazda recommends that all maintenance services be performed at the recommended time or mileage/kilometer period to ensure long-term reliability.
- \*3 If the vehicle is operated primarily under any of the following conditions, replace the rear differential oil at every 45,000 km (28,100 miles).
  - a) Towing a trailer or using a car-top carrier
  - b) Driving in dusty, sandy or wet conditions
  - c) Extended periods of idling or low speed operation
  - d) Repeated short trips of less than 16 km (10 miles)
- \*4 If this component has been submerged in water, the oil should be replaced.

Maintenance and Care

# Scheduled Maintenance

## ▼ Schedule 2

Maintenance Interval	Number of months or kilometers (miles), whichever comes first												
	Months	4	8	12	16	20	24	28	32	36	40	44	48
	×1000 km	8	16	24	32	40	48	56	64	72	80	88	96
	×1000 miles	5	10	15	20	25	30	35	40	45	50	55	60
<b>ENGINE</b>													
Drive belts								I					
Engine oil	Puerto Rico	Replace every 5,000 km (3,000 miles) or 3 months											
	Others	R	R	R	R	R	R	R	R	R	R	R	R
Engine oil filter		R	R	R	R	R	R	R	R	R	R	R	R
<b>COOLING SYSTEM</b>													
Engine coolant	FL22 type*1	Replace at first 192,000 km (120,000 miles) or 10 years; after that, every 96,000 km (60,000 miles) or 5 years											
	Others	Replace at first 96,000 km (60,000 miles) or 4 years; after that, every 2 years											
Engine coolant level		I	I	I	I	I	I	I	I	I	I	I	I
<b>FUEL SYSTEM</b>													
Air filter	Puerto Rico						R						R
	Others							R					
Fuel lines and hoses*2							I						I
Hoses and tubes for emission*2													I
<b>IGNITION SYSTEM</b>													
Spark plugs		Replace every 120,000 km (75,000 miles)											
<b>ELECTRICAL SYSTEM</b>													
Function of all lights		I	I	I	I	I	I	I	I	I	I	I	I
<b>CHASSIS and BODY</b>													
Brake lines, hoses and connections							I						I
Brake and clutch fluid level		I	I	I	I	I	I	I	I	I	I	I	I
Disc brakes				I			I			I			I
Tire (Rotation)		Rotate every 8,000 km (5,000 miles)											
Tire inflation pressure and tire wear		I	I	I	I	I	I	I	I	I	I	I	I
Steering operation and linkages							I						I
Front and rear suspension, ball joints and wheel bearing axial play							I						I
Rear differential oil		*3*4											
Transfer oil		*4											
Driveshaft dust boots							I						I
Bolts and nuts on chassis and body							T						T
Exhaust system and heat shields		Inspect every 72,000 km (45,000 miles) or 5 years											
All locks and hinges		L	L	L	L	L	L	L	L	L	L	L	L
Washer fluid level		I	I	I	I	I	I	I	I	I	I	I	I

## Scheduled Maintenance

Maintenance Interval	Number of months or kilometers (miles), whichever comes first												
	Months	4	8	12	16	20	24	28	32	36	40	44	48
	×1000 km	8	16	24	32	40	48	56	64	72	80	88	96
	×1000 miles	5	10	15	20	25	30	35	40	45	50	55	60
<b>AIR CONDITIONER SYSTEM</b>													
Cabin air filter		Replace every 40,000 km (25,000 miles) or 2 years											

**Chart symbols:**

**I:** Inspect: Inspect and clean, repair, adjust, fill up, or replace if necessary.

**R:** Replace

**L:** Lubricate

**T:** Tighten

**Remarks:**

- \*1 Use FL22 type coolant in vehicles with the inscription “FL22” on the radiator cap itself or the surrounding area. Use FL22 when replacing the coolant.
- \*2 According to state/provincial and federal regulations, failure to perform maintenance on these items will not void your emissions warranties. However, Mazda recommends that all maintenance services be performed at the recommended time or mileage/kilometer period to ensure long-term reliability.
- \*3 If the vehicle is operated primarily under any of the following conditions, replace the rear differential oil at every 45,000 km (28,100 miles).
  - a) Towing a trailer or using a car-top carrier
  - b) Driving in dusty, sandy or wet conditions
  - c) Extended periods of idling or low speed operation
  - d) Repeated short trips of less than 16 km (10 miles)
- \*4 If this component has been submerged in water, the oil should be replaced.



Maintenance and Care

## Scheduled Maintenance

---

### Scheduled Maintenance (Mexico)

Follow Schedule 1 if the vehicle is operated mainly where none of the following conditions apply.

- Repeated short-distance driving
- Driving in dusty conditions
- Driving with extended use of brakes
- Driving in areas where salt or other corrosive materials are used
- Driving on rough or muddy roads
- Extended periods of idling or low-speed operation
- Driving for long periods in cold temperatures or extremely humid climates
- Driving in extremely hot conditions
- Driving in mountainous conditions continually

If any do apply, follow Schedule 2.

**NOTE**

*After the prescribed period, continue to follow the described maintenance at the recommended intervals.*

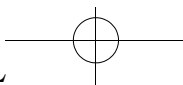

Maintenance and Care  
**Scheduled Maintenance**

▼ **Schedule 1**

Maintenance Interval	Number of months or kilometers, whichever comes first												
	Months	6	12	18	24	30	36	42	48	54	60	66	72
	×1000 km	10	20	30	40	50	60	70	80	90	100	110	120
<b>ENGINE</b>													
Drive belts				I					I				I
Engine oil	R	R	R	R	R	R	R	R	R	R	R	R	R
Engine oil filter	R	R	R	R	R	R	R	R	R	R	R	R	R
<b>COOLING SYSTEM</b>													
Cooling system				I					I				I
Engine coolant	FL22 type *1	Replace at first 200,000 km or 10 years; after that, every 100,000 km or 5 years											
	Others	Replace every 2 years											
<b>FUEL SYSTEM</b>													
Air filter		R		R		R		R		R		R	
Fuel lines and hoses				I*2					I*2				I
Hoses and tubes for emission				I*2					I*2				I
Fuel filter	Replace every 60,000 km												
<b>IGNITION SYSTEM</b>													
Spark plugs	Replace every 120,000 km												
<b>CHASSIS and BODY</b>													
Brake lines, hoses and connections		I		I		I		I		I		I	
Brake and clutch fluid level	I	I	I			I	I	I		I	I	I	
Brake fluid				R					R				R
Disc brakes	I	I	I	I	I	I	I	I	I	I	I	I	I
Tire (Rotation)	Rotate every 10,000 km												
Tire inflation pressure and tire wear	I	I	I	I	I	I	I	I	I	I	I	I	I
Steering operation and linkages	I	I	I	I	I	I	I	I	I	I	I	I	I
Front and rear suspension, ball joints and wheel bearing axial play		I		I			I		I			I	
Rear differential oil	*3*4												
Transfer oil	*4												
Driveshaft dust boots		I		I		I		I		I		I	
Bolts and nuts on chassis and body		T		T		T		T		T		T	
Exhaust system and heat shields		I		I		I		I		I		I	
All locks and hinges	L	L	L	L	L	L	L	L	L	L	L	L	L
Washer fluid level	I	I	I	I	I	I	I	I	I	I	I	I	I

Maintenance and Care

## Scheduled Maintenance

Maintenance Interval	Number of months or kilometers, whichever comes first												
	Months	6	12	18	24	30	36	42	48	54	60	66	72
	×1000 km	10	20	30	40	50	60	70	80	90	100	110	120
<b>AIR CONDITIONER SYSTEM</b>													
Cabin air filter					R				R				R

**Chart symbols:**

**I:** Inspect: Inspect and clean, repair, adjust, fill up, or replace if necessary.

**R:** Replace

**L:** Lubricate

**T:** Tighten

**Remarks:**

- \*1 Use FL22 type coolant in vehicles with the inscription “FL22” on the radiator cap itself or the surrounding area. Use FL22 when replacing the coolant.
- \*2 According to state/provincial and federal regulations, failure to perform maintenance on these items will not void your emissions warranties. However, Mazda recommends that all maintenance services be performed at the recommended time or kilometer period to ensure long-term reliability.
- \*3 If the vehicle is operated primarily under any of the following conditions, replace the rear differential oil at every 45,000 km.
  - a) Towing a trailer or using a car-top carrier
  - b) Driving in dusty, sandy or wet conditions
  - c) Extended periods of idling or low speed operation
  - d) Repeated short trips of less than 16 km
- \*4 If this component has been submerged in water, the oil should be replaced.

Maintenance and Care  
**Scheduled Maintenance**

▼ **Schedule 2**

Maintenance Interval	Number of months or kilometers, whichever comes first												
	Months	3	6	9	12	15	18	21	24	27	30	33	36
	×1000 km	5	10	15	20	25	30	35	40	45	50	55	60
<b>ENGINE</b>													
Drive belts									I				
Engine oil	R	R	R	R	R	R	R	R	R	R	R	R	R
Engine oil filter	R	R	R	R	R	R	R	R	R	R	R	R	R
<b>COOLING SYSTEM</b>													
Cooling system									I				
Engine coolant	FL22 type *1	Replace at first 200,000 km or 10 years; after that, every 100,000 km or 5 years											
	Others	Replace every 2 years											
Engine coolant level	I	I	I	I	I	I	I	I	I	I	I	I	I
<b>FUEL SYSTEM</b>													
Air filter		C		R		C		R		C		R	
Fuel lines and hoses								I**2					
Hoses and tubes for emission								I**2					
Fuel filter	Replace every 60,000 km												
<b>IGNITION SYSTEM</b>													
Spark plugs	Replace every 120,000 km												
<b>ELECTRICAL SYSTEM</b>													
Function of all lights	I	I	I	I	I	I	I	I	I	I	I	I	I
<b>CHASSIS and BODY</b>													
Brake lines, hoses and connections				I				I					I
Brake and clutch fluid level		I		I		I				I			I
Brake fluid								R					
Disc brakes		I		I		I		I		I			I
Tire (Rotation)	Rotate every 10,000 km												
Tire inflation pressure and tire wear		I		I		I		I		I			I
Steering operation and linkages		I		I		I		I		I			I
Front and rear suspension, ball joints and wheel bearing axial play				I					I				I
Rear differential oil	*3*4												
Transfer oil	*4												
Driveshaft dust boots				I				I					I
Bolts and nuts on chassis and body				T				T					T
Exhaust system and heat shields				I				I					I
All locks and hinges		L		L		L		L		L			L
Washer fluid level		I		I		I		I		I			I

Maintenance and Care

# Scheduled Maintenance

Maintenance Interval	Number of months or kilometers, whichever comes first												
	Months	3	6	9	12	15	18	21	24	27	30	33	36
	×1000 km	5	10	15	20	25	30	35	40	45	50	55	60
<b>AIR CONDITIONER SYSTEM</b>													
Cabin air filter					R				R				R

**Chart symbols:**

**I:** Inspect: Inspect and clean, repair, adjust, fill up, or replace if necessary.

**R:** Replace

**L:** Lubricate

**C:** Clean

**T:** Tighten

**Remarks:**

- \*1 Use FL22 type coolant in vehicles with the inscription “FL22” on the radiator cap itself or the surrounding area. Use FL22 when replacing the coolant.
- \*2 According to state/provincial and federal regulations, failure to perform maintenance on these items will not void your emissions warranties. However, Mazda recommends that all maintenance services be performed at the recommended time or kilometer period to ensure long-term reliability.
- \*3 If the vehicle is operated primarily under any of the following conditions, replace the rear differential oil at every 45,000 km.
  - a) Towing a trailer or using a car-top carrier
  - b) Driving in dusty, sandy or wet conditions
  - c) Extended periods of idling or low speed operation
  - d) Repeated short trips of less than 16 km
- \*4 If this component has been submerged in water, the oil should be replaced.



Maintenance and Care  
**Scheduled Maintenance**

(Cont.)

Maintenance Interval	Number of months or kilometers, whichever comes first												
	Months	39	42	45	48	51	54	57	60	63	66	69	72
	×1000 km	65	70	75	80	85	90	95	100	105	110	115	120
<b>ENGINE</b>													
Drive belts				I									I
Engine oil	R	R	R	R	R	R	R	R	R	R	R	R	R
Engine oil filter	R	R	R	R	R	R	R	R	R	R	R	R	R
<b>COOLING SYSTEM</b>													
Cooling system				I									I
Engine coolant	FL22 type*1	Replace at first 200,000 km or 10 years; after that, every 100,000 km or 5 years											
	Others	Replace every 2 years											
Engine coolant level	I	I	I	I	I	I	I	I	I	I	I	I	I
<b>FUEL SYSTEM</b>													
Air filter		C		R		C		R		C			R
Fuel lines and hoses				I*2									I*2
Hoses and tubes for emission				I*2									I*2
Fuel filter	Replace every 60,000 km												
<b>IGNITION SYSTEM</b>													
Spark plugs	Replace every 120,000 km												
<b>ELECTRICAL SYSTEM</b>													
Function of all lights	I	I	I	I	I	I	I	I	I	I	I	I	I
<b>CHASSIS and BODY</b>													
Brake lines, hoses and connections				I					I				I
Brake and clutch fluid level		I					I		I		I		
Brake fluid				R									R
Disc brakes		I		I			I		I		I		I
Tire (Rotation)	Rotate every 10,000 km												
Tire inflation pressure and tire wear		I		I			I		I		I		I
Steering operation and linkages		I		I			I		I		I		I
Front and rear suspension, ball joints and wheel bearing axial play				I					I				I
Rear differential oil	*3*4												
Transfer oil	*4												
Driveshaft dust boots				I					I				I
Bolts and nuts on chassis and body				T					T				T
Exhaust system and heat shields				I					I				I
All locks and hinges		L		L			L		L		L		L
Washer fluid level		I		I			I		I		I		I

Maintenance and Care

# Scheduled Maintenance

Maintenance Interval	Number of months or kilometers, whichever comes first												
	Months	39	42	45	48	51	54	57	60	63	66	69	72
	×1000 km	65	70	75	80	85	90	95	100	105	110	115	120
<b>AIR CONDITIONER SYSTEM</b>													
Cabin air filter					R				R				R

**Chart symbols:**

**I:** Inspect: Inspect and clean, repair, adjust, fill up, or replace if necessary.

**R:** Replace

**L:** Lubricate

**C:** Clean

**T:** Tighten

**Remarks:**

- \*1 Use FL22 type coolant in vehicles with the inscription “FL22” on the radiator cap itself or the surrounding area. Use FL22 when replacing the coolant.
- \*2 According to state/provincial and federal regulations, failure to perform maintenance on these items will not void your emissions warranties. However, Mazda recommends that all maintenance services be performed at the recommended time or kilometer period to ensure long-term reliability.
- \*3 If the vehicle is operated primarily under any of the following conditions, replace the rear differential oil at every 45,000 km.
  - a) Towing a trailer or using a car-top carrier
  - b) Driving in dusty, sandy or wet conditions
  - c) Extended periods of idling or low speed operation
  - d) Repeated short trips of less than 16 km
- \*4 If this component has been submerged in water, the oil should be replaced.

Maintenance and Care  
**Owner Maintenance**

## Owner Maintenance Precautions

The owner or a qualified service technician should make these vehicle inspections at the indicated intervals to ensure safe and dependable operation.

Bring any problem to the attention of an Authorized Mazda Dealer or qualified service technician as soon as possible.

### **When Refueling**

- Brake and clutch fluid level (page 6-24)
- Engine coolant level (page 6-22)
- Engine oil level (page 6-21)
- Washer fluid level (page 6-25)

### **At Least Monthly**

Tire inflation pressures (page 6-35)

### **At Least Twice a Year (For Example, Every Spring and Fall)**

You can do the following scheduled maintenance items if you have some mechanical ability and a few basic tools and if you closely follow the directions in this manual.

- Engine coolant (page 6-22)
- Engine oil (page 6-20)

Improper or incomplete service may result in problems. This section gives instructions only for items that are easy to perform.

As explained in the Introduction (page 6-2), several procedures can be done only by a qualified service technician with special tools.

Improper owner maintenance during the warranty period may affect warranty coverage. For details, read the separate Mazda Warranty statement provided with the vehicle. If you are unsure about any servicing or maintenance procedure, have it done by an Authorized Mazda Dealer.

There are strict environmental laws regarding the disposal of waste oil and fluids. Please dispose of your waste properly and with due regard to the environment.

We recommend that you entrust the oil and fluid changes of your vehicle to an Authorized Mazda Dealer.

Maintenance and Care

## Owner Maintenance

---

### **WARNING**

**Do not perform maintenance work if you lack sufficient knowledge and experience or the proper tools and equipment to do the work. Have maintenance work done by a qualified technician:**

*Performing maintenance work on a vehicle is dangerous if not done properly. You can be seriously injured while performing some maintenance procedures.*

**If you must run the engine while working under the hood, make certain that you remove all jewelry (especially rings, bracelets, watches, and necklaces) and all neckties, scarves, and similar loose clothing before getting near the engine or cooling fan which may turn on unexpectedly:**

*Working under the hood with the engine running is dangerous. It becomes even more dangerous when you wear jewelry or loose clothing.*

*Either can become entangled in moving parts and result in injury.*



**Switch the ignition to off and make sure the fan is not running before attempting to work near the cooling fan:**

*Working near the cooling fan when it is running is dangerous. The fan could continue running indefinitely even if the engine has stopped and the engine compartment temperature is high. You could be hit by the fan and seriously injured.*

**Do not leave items in the engine compartment:**

*After you have finished checking or doing servicing in the engine compartment, do not forget and leave items such as tools or rags in the engine compartment.*

*Tools or other items left in the engine compartment could cause engine damage or a fire leading to an unexpected accident.*

## Owner Maintenance

### Hood

#### **! WARNING**

**Always check that the hood is closed and securely locked:**

*A hood that is not closed and securely locked is dangerous as it could fly open while the vehicle is moving and block the driver's vision which could result in a serious accident.*

#### ▼ Opening the Hood

1. With the vehicle parked, pull the release handle to unlock the hood.

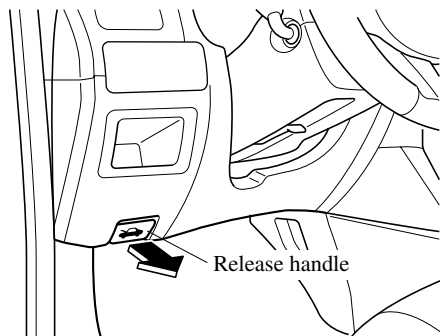

2. Insert your hand into the hood opening, slide the latch lever to the right, and lift up the hood.

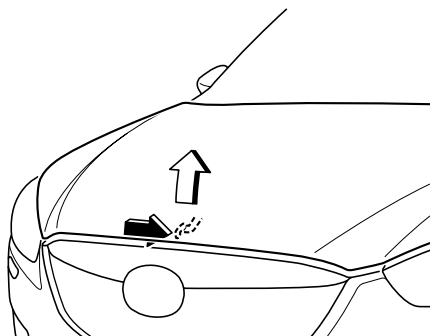

3. Grasp the support rod in the padded area and secure it in the support rod hole indicated by the arrow to hold the hood open.

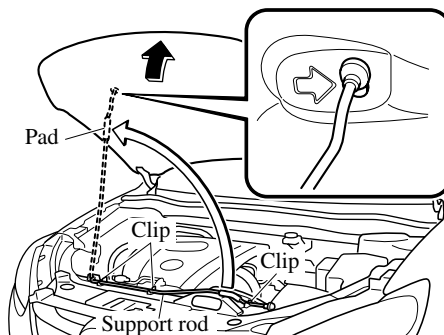

Maintenance and Care

## Owner Maintenance

### ▼ Closing the Hood

1. Check under the hood area to make certain all filler caps are in place and all loose items (e.g. tools, oil containers, etc.) have been removed.
2. Lift the hood, grasp the padded area on the support rod, and secure the support rod in the clip. Verify that the support rod is secured in the clip before closing the hood.

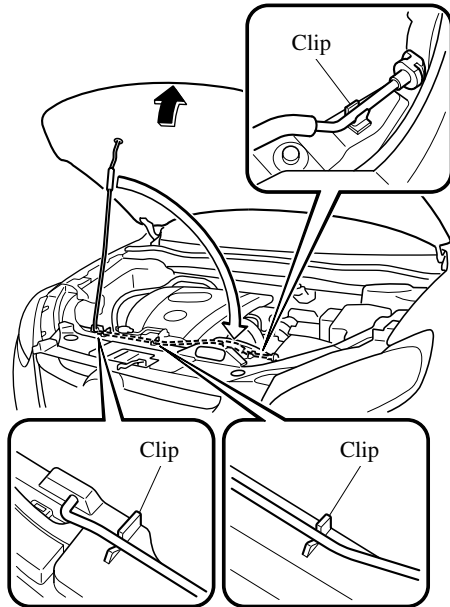

3. Lower the hood slowly until it rests in the unlocked position, and then remove your hands. Push the front center edge of the hood downward until a latching sound is heard, and the hood closes completely.

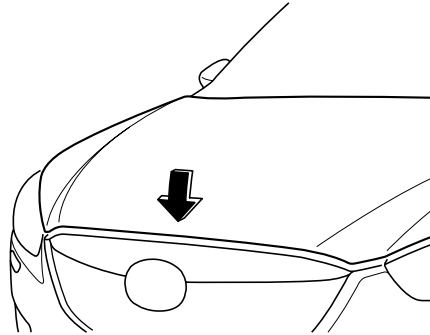

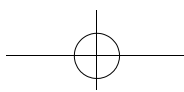

Maintenance and Care  
**Owner Maintenance**

**Engine Compartment Overview**

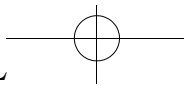
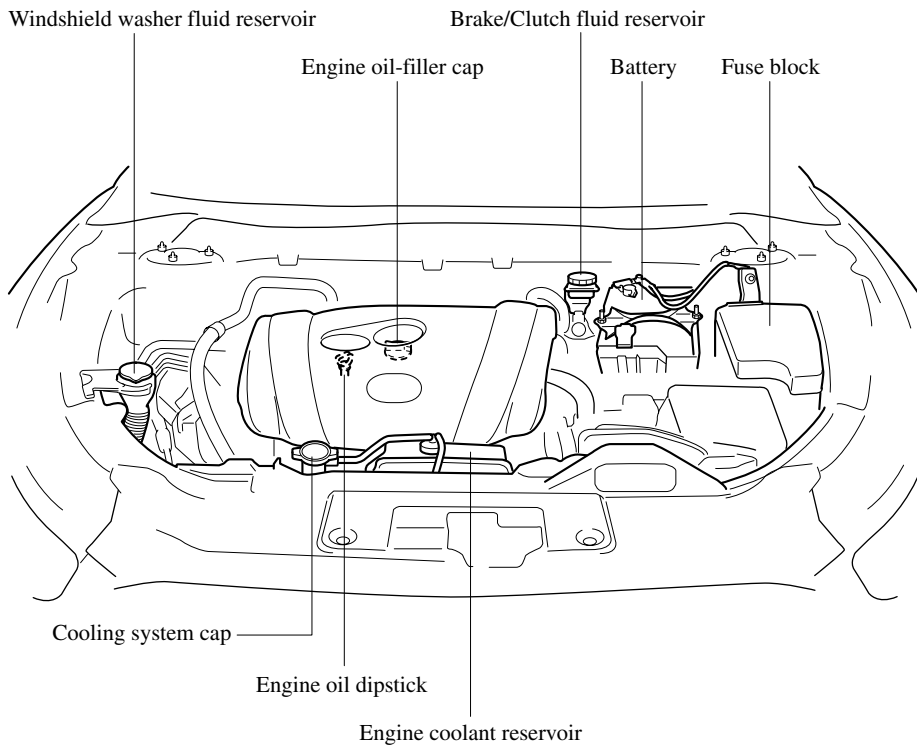

Maintenance and Care

## Owner Maintenance

### Engine Oil

**NOTE**

Have an Authorized Mazda Dealer change your vehicle engine oil.

▼ **Recommended Oil**

**U.S.A. and CANADA**

**0W-20 full synthetic recommended:**

Mazda genuine oil is used in your Mazda vehicle and 0W-20 lubricant is recommended. Mazda genuine 0W-20 oil is required to achieve optimum fuel economy. If 0W-20 is not available, 5W-20 may be used for oil level maintenance and oil changes however, it must be replaced with 0W-20 at the next oil change to maintain optimum performance. Recommended viscosity: SAE 0W-20

For maintenance service, Mazda recommends Mazda genuine parts and Castrol®.



(ILSAC)

Only use SAE 0W-20 oil with the American Petroleum Institute (API) symbol and ILSAC GF-5. Oil with this trademark symbol conforms to the current engine and emission system protection standards and fuel economy requirements of the International Lubricant Standardization and Approval Committee (ILSAC), comprised of U.S. and Japanese automobile manufacturers.

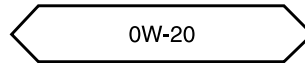
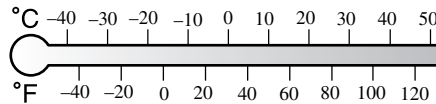

**Except U.S.A. and CANADA**

**Use SAE 5W-30 engine oil.**

Oil container labels provide important information.

A chief contribution this type of oil makes to fuel economy is reducing the amount of fuel necessary to overcome engine friction.

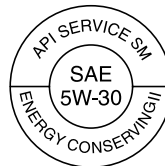

(ILSAC)



Maintenance and Care  
**Owner Maintenance**

The quality designation SM, or ILSAC must be on the label.

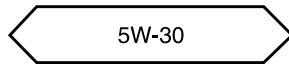
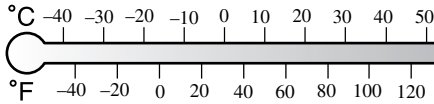

▼ **Inspecting Engine Oil Level**

1. Be sure the vehicle is on a level surface.
2. Warm up the engine to normal operating temperature.
3. Turn it off and wait at least 5 minutes for the oil to return to the oil pan.
4. Pull out the dipstick, wipe it clean, and reinsert it fully.

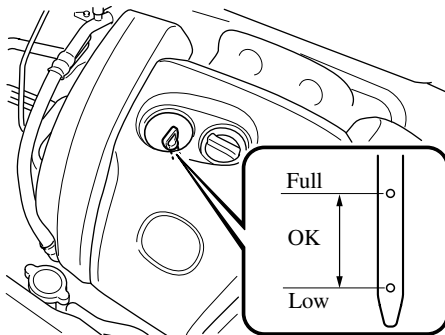

5. Pull it out again and examine the level. The level is normal if it is between Low and Full. If it is near or below Low, add enough oil to bring the level to Full.

**CAUTION**

*Do not add engine oil over Full. This may cause engine damage.*

6. Make sure the O-ring on the dipstick is positioned properly before reinserting the dipstick.
7. Reinsert the dipstick fully.

Maintenance and Care

## Owner Maintenance

### Engine Coolant

#### ▼ Inspecting Coolant Level

#### **⚠ WARNING**

**Do not use a match or live flame in the engine compartment. DO NOT ADD COOLANT WHEN THE ENGINE IS HOT:**

*A hot engine is dangerous. If the engine has been running, parts of the engine compartment can become very hot. You could be burned. Carefully inspect the engine coolant in the coolant reservoir, but do not open it.*



**Switch the ignition to off and make sure the fan is not running before attempting to work near the cooling fan:**

*Working near the cooling fan when it is running is dangerous. The fan could continue running indefinitely even if the engine has stopped and the engine compartment temperature is high. You could be hit by the fan and seriously injured.*



**Do not remove either cooling system cap when the engine and radiator are hot:**

*When the engine and radiator are hot, scalding coolant and steam may shoot out under pressure and cause serious injury.*

#### **NOTE**

*Changing the coolant should be done by an Authorized Mazda Dealer.*

Inspect the antifreeze protection and coolant level in the coolant reservoir at least once a year—at the beginning of the winter season—and before traveling where temperatures may drop below freezing.

Inspect the condition and connections of all cooling system and heater hoses. Replace any that are swollen or deteriorated.

The coolant should be at full in the radiator and between the F and L marks on the coolant reservoir when the engine is cool.

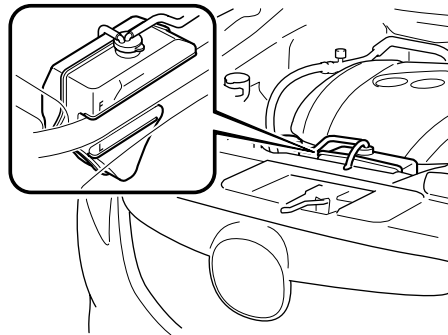

If it is at or near L, add enough coolant to the coolant reservoir to provide freezing and corrosion protection and to bring the level to F.

Securely tighten the coolant reservoir tank cap after adding coolant.

Maintenance and Care  
**Owner Maintenance**

**CAUTION**

- **Radiator coolant will damage paint.**  
*Rinse it off quickly if spilled.*
- **Use only soft (demineralized) water in the coolant mixture.**  
*Water that contains minerals will cut down on the coolant's effectiveness.*
- **Do not add only water. Always add a proper coolant mixture.**
- **The engine has aluminum parts and must be protected by an ethylene-glycol-based coolant to prevent corrosion and freezing.**
- **DO NOT USE coolants Containing Alcohol, methanol, Borate or Silicate.**  
*These coolants could damage the cooling system.*
- **DO NOT MIX alcohol or methanol with the coolant. This could damage the cooling system.**
- **Do not use a solution that contains more than 60% antifreeze.**  
*This would reduce effectiveness.*

**NOTE**

*If the "FL22" mark is shown on or near the cooling system cap, it is recommended to use Mazda Genuine FL22 engine coolant (page 6-3).*



If the coolant reservoir is empty or new coolant is required frequently, consult an Authorized Mazda Dealer.

Maintenance and Care

## Owner Maintenance

### Brake/Clutch Fluid

#### ▼ Inspecting Brake/Clutch Fluid Level

The brakes and clutch draw fluid from the same reservoir.

Inspect the fluid level in the reservoir regularly. It should be kept at MAX.

The level normally drops with accumulated distance, a condition associated with wear of brake and clutch linings. If it is excessively low, have the brake/clutch system inspected by an Authorized Mazda Dealer.

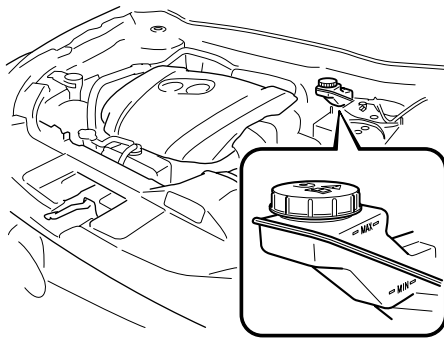

#### ▼ Adding Brake/Clutch Fluid

#### **⚠ WARNING**

***Be careful not to spill brake fluid on yourself or on the engine:***

*Spilled brake fluid is dangerous. If it gets in your eyes, they could be seriously injured. If this happens, immediately flush your eyes with water and get medical attention. Brake fluid spilled on a hot engine could cause a fire.*

***If the brake/clutch fluid level is low, have the brakes and clutch inspected:***

*Low brake/clutch fluid levels are dangerous. Low levels could signal brake lining wear or a brake system leak. Your brakes could fail and cause an accident.*

If the fluid level is low, add fluid until it reaches MAX.

Before adding fluid, thoroughly clean the area around the cap.

#### **⚠ CAUTION**

- *Brake and clutch fluid will damage painted surfaces. If brake or clutch fluid does get on a painted surface, wash it off with water immediately.*
- *Using nonspecified brake and clutch fluids (page 9-4) will damage the systems. Mixing different fluids will also damage them.*

*If the brake/clutch system frequently requires new fluid, consult an Authorized Mazda Dealer.*

Maintenance and Care  
**Owner Maintenance**

## Washer Fluid

### ▼ Inspecting Washer Fluid Level

#### **⚠ WARNING**

**Use only windshield washer fluid or plain water in the reservoir:**

*Using radiator antifreeze as washer fluid is dangerous. If sprayed on the windshield, it will dirty the windshield, affect your visibility, and could result in an accident.*

#### **Using Washer Fluid Without Anti-freeze Protection in Cold Weather:**

*Operating your vehicle in temperatures below 4 degrees C (40 degrees F) using washer fluid without anti-freeze protection is dangerous as it could cause impaired windshield vision and result in an accident. In cold weather, always use washer fluid with anti-freeze protection.*

#### **NOTE**

*State or local regulations may restrict the use of volatile organic compounds (VOCs), which are commonly used as anti-freeze agents in washer fluid. A washer fluid with limited VOC content should be used only if it provides adequate freeze resistance for all regions and climates in which the vehicle will be operated.*

Inspect fluid level in the washer fluid reservoir; add fluid if necessary.

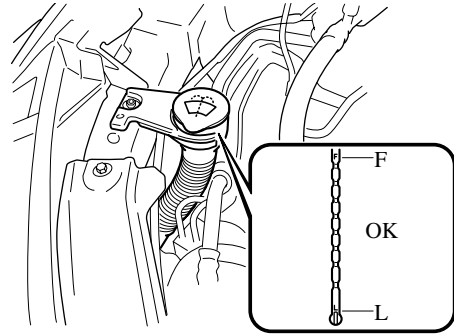

The top of the float should be between F and L.

Use plain water if washer fluid is unavailable. But use only washer fluid in cold weather to prevent it from freezing.

#### **NOTE**

*Front and rear washer fluid is supplied from the same reservoir.*

Maintenance and Care

## Owner Maintenance

### Body Lubrication

All moving points of the body, such as door and hood hinges and locks, should be lubricated each time the engine oil is changed. Use a nonfreezing lubricant on locks during cold weather.

Make sure the hood's secondary latch keeps the hood from opening when the primary latch is released.

### Wiper Blades

#### CAUTION

- *Hot waxes applied by automatic car washers have been known to affect the wiper's ability to clean windows.*
- *To prevent damage to the wiper blades, do not use gasoline, kerosene, paint thinner, or other solvents on or near them.*
- *When the wiper lever is in the AUTO position and the ignition is switched ON, the wipers may move automatically in the following cases:*
  - *If the windshield above the rain sensor is touched.*
  - *If the windshield above the rain sensor is wiped with a cloth.*
  - *If the windshield is struck with a hand or other object.*
  - *If the rain sensor is struck with a hand or other object from inside the vehicle.*

*Be careful not to pinch hands or fingers as it may cause injury, or damage the wipers. When washing or servicing your Mazda, make sure the wiper lever is in the OFF position.*

Contamination of either the windshield or the blades with foreign matter can reduce wiper effectiveness. Common sources are insects, tree sap, and hot wax treatments used by some commercial car washes.

If the blades are not wiping properly, clean the window and blades with a good cleaner or mild detergent; then rinse thoroughly with clean water. Repeat if necessary.

Maintenance and Care  
**Owner Maintenance**

▼ **Replacing Windshield Wiper Blades**

When the wipers no longer clean well, the blades are probably worn or cracked. Replace them.

**CAUTION**

*To prevent damage to the wiper arms and other components, do not try to sweep the wiper arm by hand.*

**NOTE**

*To prevent damage to the wiper arm blades when raising both the driver and passenger side wiper arms, raise the driver side wiper arm first. Conversely, when setting down the wiper arms, set the passenger side wiper arm down first.*

1. Raise the wiper arm.
2. Open the clip and slide the blade assembly in the direction of the arrow.

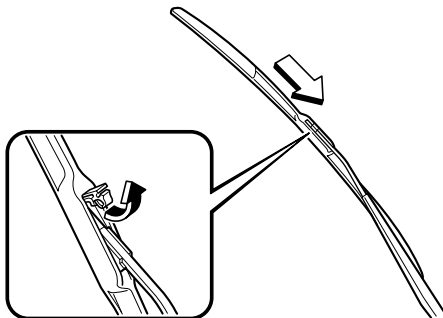

3. Tilt the blade assembly and remove it from the arm.

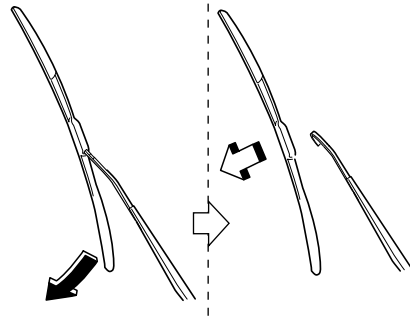

**CAUTION**

*To prevent damage to the windshield let the wiper arm down easily, do not let it slap down on the windshield.*

4. Pull down the blade rubber and slide it out of blade holder.

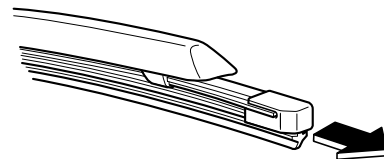

Maintenance and Care

## Owner Maintenance

5. Remove the metal stiffeners from each blade rubber and install them in the new blade.

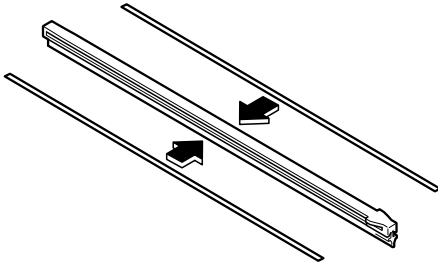

### **CAUTION**

- Do not bend or discard the stiffeners. You need to use them again.
- If the metal stiffeners are switched, the blade's wiping efficiency could be reduced. So do not use the driver's side metal stiffeners on the passenger's side, or vice versa.
- Be sure to reinstall the metal stiffeners in the new blade rubber so that the curve is the same as it was in the old blade rubber.

6. Carefully insert the new blade rubber. Then install the blade assembly in the reverse order of removal.

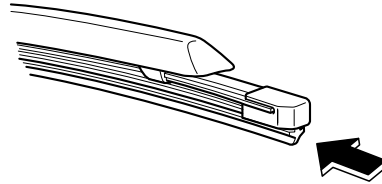

### ▼ Replacing Rear Window Wiper Blade

When the wiper no longer cleans well, the blade is probably worn or cracked. Replace it.

### **CAUTION**

To prevent damage to the wiper arm and other components, do not move the wiper by hand.

1. Remove the cover and raise the wiper arm.

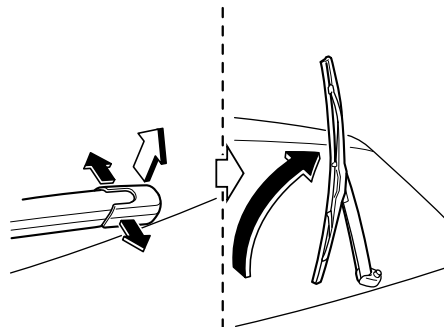



Maintenance and Care  
**Owner Maintenance**

2. Firmly rotate the wiper blade to the right until it unlocks, then remove the blade.

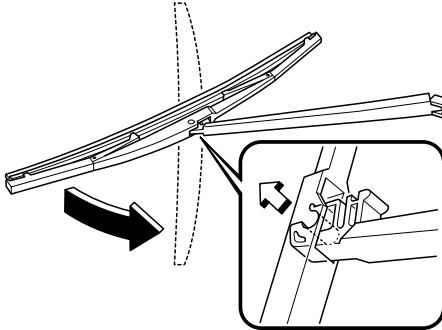

**CAUTION**

*To prevent damage to the rear window, do not let the wiper arm fall on it.*

3. Pull down the blade rubber and slide it out of the blade holder.

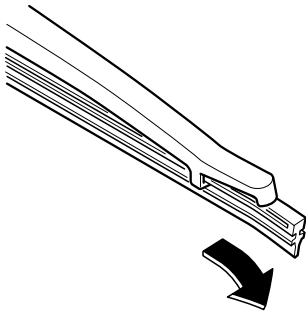

4. Remove the metal stiffeners from the blade rubber and install them in the new blade.

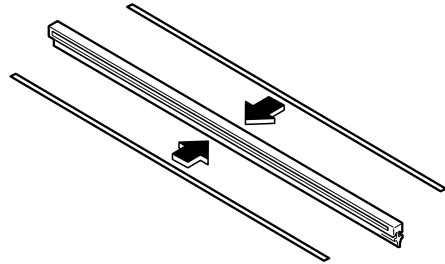

**CAUTION**

*Do not bend or discard the stiffeners. You need to use them again.*

5. Carefully insert the new blade rubber. Then install the blade assembly in the reverse order of removal.

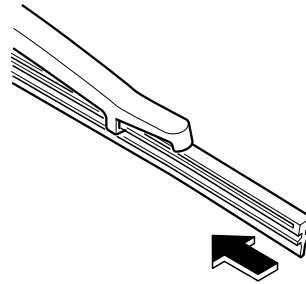

Maintenance and Care

## Owner Maintenance

### Battery

#### **WARNING**

**Wash hands after handling the battery and related accessories:**

*Battery posts, terminals and related accessories contain lead and lead compounds, chemicals known to the State of California to cause cancer and reproductive harm.*



**Read the following precautions carefully before using the battery or inspecting to ensure safe and correct handling:**



**Always wear eye protection when working near the battery:**

*Working without eye protection is dangerous. Battery fluid contains SULFURIC ACID which could cause blindness if splashed into your eyes. Also, hydrogen gas produced during normal battery operation, could ignite and cause the battery to explode.*



**Wear eye protection and protective gloves to prevent contact with battery fluid:**

*Spilled battery fluid is dangerous. Battery fluid contains SULFURIC ACID which could cause serious injuries if it gets in eyes, or on the skin or clothing. If this happens, immediately flush your eyes with water for 15 minutes or wash your skin thoroughly and get medical attention.*



**Always keep batteries out of the reach of children:**

*Allowing children to play near batteries is dangerous. Battery fluid could cause serious injuries if it gets in the eyes or on the skin.*



**Keep flames and sparks away from open battery cells and do not allow metal tools to contact the positive (+) or negative (-) terminal of the battery when working near a battery. Do not allow the positive (+) terminal to contact the vehicle body:**

*Flames and sparks near open battery cells are dangerous. Hydrogen gas, produced during normal battery operation, could ignite and cause the battery to explode. An exploding battery can cause serious burns and injuries. Keep all flames including cigarettes and sparks away from open battery cells.*



Maintenance and Care

## Owner Maintenance

---



**Keep all flames, including cigarettes, and sparks away from open battery cells:**  
*Flames and sparks near open battery cells are dangerous. Hydrogen gas, produced during normal battery operation, could ignite and cause the battery to explode. An exploding battery can cause serious burns and injuries.*

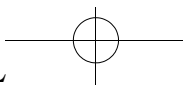

Maintenance and Care

## Owner Maintenance

### NOTE

Remove the battery cover before performing battery maintenance.

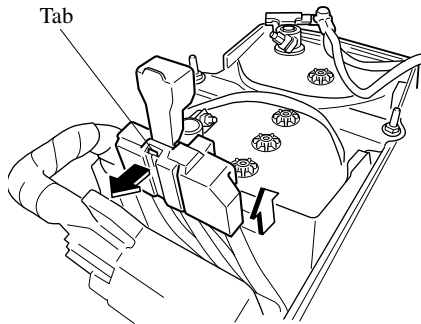

### ▼ Battery Maintenance

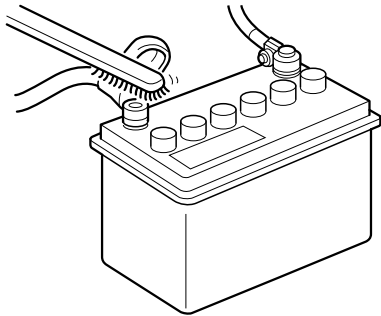

To get the best service from a battery:

- Keep it securely mounted.
- Keep the top clean and dry.
- Keep terminals and connections clean, tight, and coated with petroleum jelly or terminal grease.
- Rinse off spilled electrolyte immediately with a solution of water and baking soda.
- If the vehicle will not be used for an extended time, disconnect the battery cables and charge the battery every six weeks.

## Replace Electrical Battery

If the buttons on the transmitter are inoperable and the operation indicator light does not flash, the battery may be dead.

Replace with a new battery before the transmitter becomes unusable.

### ⚠ CAUTION

- Make sure the battery is installed correctly. Battery leakage could occur if it is not installed correctly.
- When replacing the battery, be careful not to touch any of the internal circuitry and electrical terminals, bend the electrical terminals, or get dirt in the transmitter as the transmitter could be damaged.
- There is the danger of explosion if the battery is not correctly replaced.
- Dispose of used batteries according to the following instructions.
  - Insulate the plus and minus terminals of the battery using cellophane or equivalent tape.
  - Never disassemble.
  - Never throw the battery into fire or water.
  - Never deform or crush.
- Replace only with the same type battery (CR2025 or equivalent).

The following conditions indicate that the battery power is low:

- The KEY indicator light (green) flashes in the instrument cluster for about 30 seconds after the engine is turned off (for vehicles with a type A meter, messages are displayed in the instrument cluster).

Maintenance and Care  
**Owner Maintenance**

- The system does not operate and the operation indicator light on the transmitter does not flash when the buttons are pressed.
- The system's operational range is reduced.

Replacing the battery at an Authorized Mazda Dealer is recommended to prevent damage to the key. If replacing the battery by yourself, follow the instruction below.

**Replacing the key battery**

1. Pull out the auxiliary key.

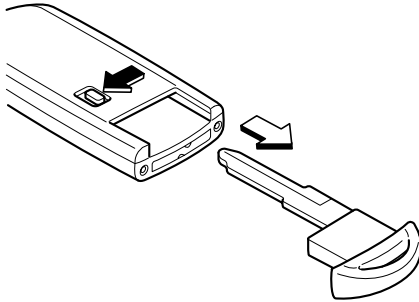

2. Insert a small, flathead screwdriver into the groove shown in the figure and rotate the screwdriver to open the cover slightly.

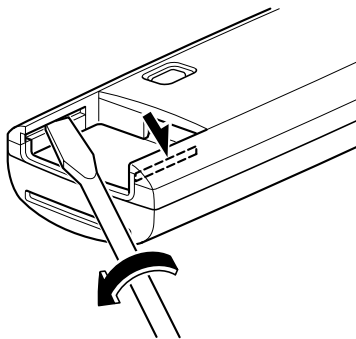

3. Insert the small, flathead screwdriver into the gap between the cover and the transmitter, and then rotate the screwdriver to detach the cover.

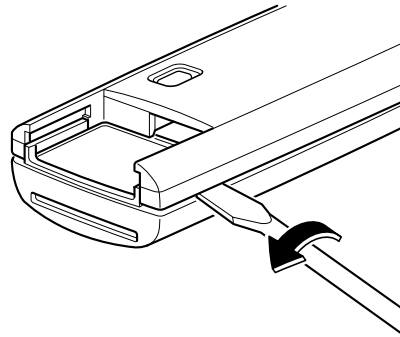

4. Remove the battery cap, then remove the battery.

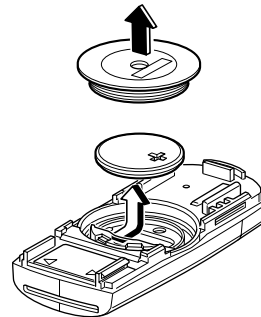

Maintenance and Care

## Owner Maintenance

5. Insert a new battery with the positive pole facing up, and then cover the battery with the battery cap.

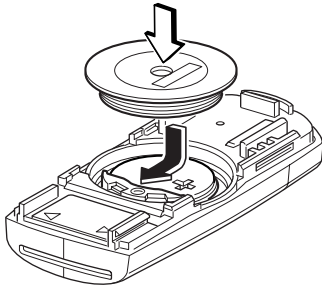

6. Close the cover.

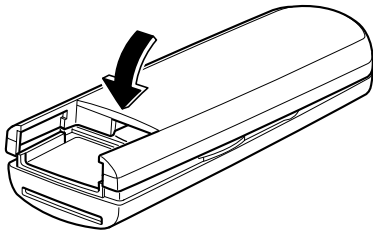

7. Reinsert the auxiliary key.

### **CAUTION**

- Be careful not to allow the rubber ring shown in the figure to be scratched or damaged.
- If the rubber ring detaches, reattach it before inserting a new battery.

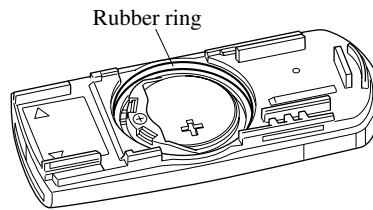

## Owner Maintenance

### Tires

For reasons of proper performance, safety, and better fuel economy, always maintain recommended tire inflation pressures and stay within the recommended load limits and weight distribution.

#### WARNING

##### **Using Different Tire Types:**

*Driving your vehicle with different types of tires is dangerous. It could cause poor handling and poor braking; leading to loss of control. Except for the limited use of the temporary spare tire, use only the same type tires (radial, bias-belted, bias-type) on all four wheels.*

##### **Using Wrong-Sized Tires:**

*Using any other tire size than what is specified for your Mazda (page 9-7) is dangerous. It could seriously affect ride, handling, ground clearance, tire clearance, and speedometer calibration. This could cause you to have an accident. Use only tires that are the correct size specified for your Mazda.*

### ▼ Tire Inflation Pressure

#### WARNING

***Always inflate the tires to the correct pressure:***

*Overinflation or underinflation of tires is dangerous. Adverse handling or unexpected tire failure could result in a serious accident.*

*Refer to Tires on page 9-7.*

***Use only a Mazda-genuine tire valve cap:***

*Use of a non-genuine part is dangerous as the correct tire air pressure cannot be maintained if the tire valve becomes damaged. If the vehicle is driven under this condition, the tire air pressure will decrease which could result in a serious accident. Do not use any part for the tire valve cap that is not a Mazda-genuine part.*

Inspect all tire pressures monthly (including the spare) when the tires are cold. Maintain recommended pressures for the best ride, handling, and minimum tire wear.

Refer to the specification charts (page 9-7).

Maintenance and Care

## Owner Maintenance

### NOTE

- *Always check tire pressure when tires are cold.*
- *Warm tires normally exceed recommended pressures. Do not release air from warm tires to adjust the pressure.*
- *Underinflation can cause reduced fuel economy, uneven and accelerated tire wear, and poor sealing of the tire bead, which will deform the wheel and cause separation of tire from rim.*
- *Overinflation can produce a harsh ride, uneven and accelerated tire wear, and a greater possibility of damage from road hazards.*

*Keep your tire pressure at the correct levels. If one frequently needs inflating, have it inspected.*

### ▼ Tire Rotation

#### **⚠ WARNING**

#### **Rotate tires periodically:**

*Irregular tire wear is dangerous. To equalize tread wear for maintaining good performance in handling and braking, rotate the tires according to the scheduled maintenance charts. Refer to Scheduled Maintenance on page 6-3.*

During rotation, inspect them for correct balance.

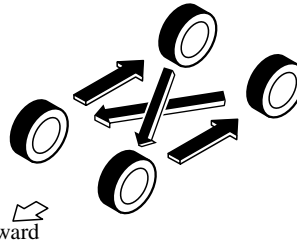

Do not include (TEMPORARY USE ONLY) spare tire in rotation.

Also, inspect them for uneven wear and damage. Abnormal wear is usually caused by one or a combination of the following:

- Incorrect tire pressure
- Improper wheel alignment
- Out-of-balance wheel
- Severe braking

After rotation, inflate all tire pressures to specification (page 9-7) and inspect the lug nuts for tightness.

#### **⚠ CAUTION**

*Rotate unidirectional tires and radial tires that have an asymmetrical tread pattern or studs only from front to rear, not from side to side. Tire performance will be reduced if rotated from side to side.*



Maintenance and Care  
**Owner Maintenance**

▼ Replacing a Tire

**! WARNING**

**Always use tires that are in good condition:**

*Driving with worn tires is dangerous. Reduced braking, steering, and traction could result in an accident.*

**Replace all four tires at the same time:**

*Replacing just one tire is dangerous. It could cause poor handling and poor braking resulting in loss of vehicle control. Mazda strongly recommends that you replace all four tires at the same time.*

If a tire wears evenly, a wear indicator will appear as a solid band across the tread.

Replace the tire when this happens.

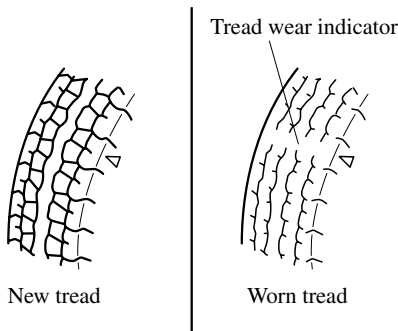

You should replace the tire before the band crosses the entire tread.

**NOTE**

*Tires degrade over time, even when they are not being used on the road. It is recommended that tires generally be replaced when they are 6 years or older. Heat caused by hot climates or frequent high loading conditions can accelerate the aging process. You should replace the spare tire when you replace the other road tires due to the aging of the spare tire. The period in which the tire was manufactured (both week and year) is indicated by a 4-digit number. Refer to Tire Labeling on page 8-25.*

▼ Temporary Spare Tire

Inspect the temporary spare tire at least monthly to make sure it is properly inflated and stored.

**NOTE**

*The temporary spare tire condition gradually deteriorates even if it has not been used.*

The temporary spare tire is easier to handle because of its construction which is lighter and smaller than a conventional tire. This tire should be used only for an emergency and only for a short distance.

Use the temporary spare tire only until the conventional tire is repaired, which should be as soon as possible.

Refer to Tires on page 9-7.

Maintenance and Care

## Owner Maintenance

### CAUTION

- Do not use your temporary spare tire rim with a snow tire or a conventional tire. Neither will properly fit and could damage both tire and rim.
- The temporary spare tire has a tread life of less than 5,000 km (3,000 miles). The tread life may be shorter depending on driving conditions.
- The temporary spare tire is for limited use, however, if the tread wear solid-band indicator appears, replace the tire with the same type of temporary spare (page 6-38).

### NOTE

Tires degrade over time, even when they are not being used on the road. It is recommended that tires generally be replaced when they are 6 years or older. Heat caused by hot climates or frequent high loading conditions can accelerate the aging process. You should replace the spare tire when you replace the other road tires due to the aging of the spare tire. The period in which the tire was manufactured (both week and year) is indicated by a 4-digit number. Refer to Tire Labeling on page 8-25.

### ▼ Replacing a Wheel

### WARNING

**Always use wheels of the correct size on your vehicle:**

*Using a wrong-sized wheel is dangerous. Braking and handling could be affected, leading to loss of control and an accident.*

### CAUTION

A wrong-sized wheel may adversely affect:

- Tire fit
- Wheel and bearing life
- Ground clearance
- Snow-chain clearance
- Speedometer calibration
- Headlight aim
- Bumper height
- Tire Pressure Monitoring System

When replacing a wheel, make sure the new one is the same as the original factory wheel in diameter, rim width, and offset (inset/outset).

Proper tire balancing provides the best riding comfort and helps reduce tread wear. Out-of-balance tires can cause vibration and uneven wear, such as cupping and flat spots.

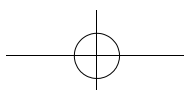

# MEMO

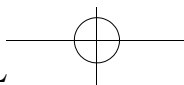
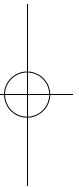
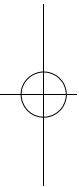

Maintenance and Care

# Owner Maintenance

## Light Bulbs

### With xenon fusion headlights

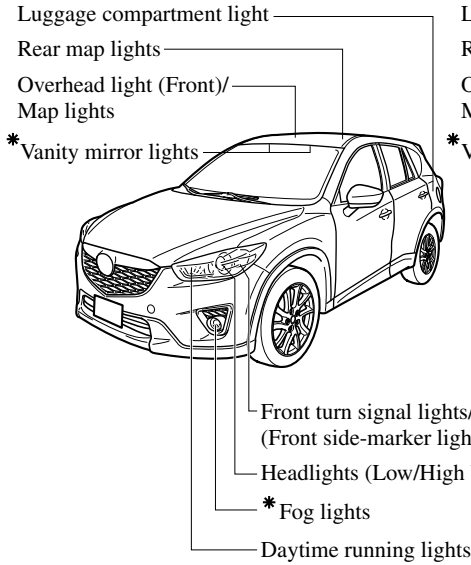

### With halogen headlights

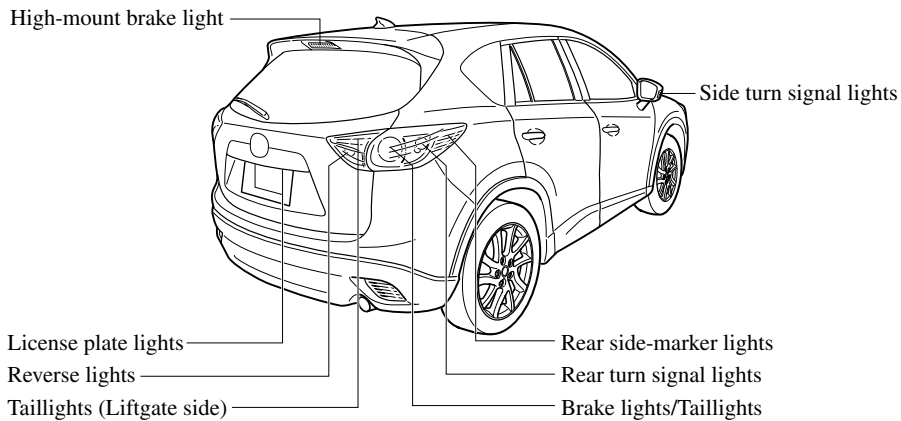
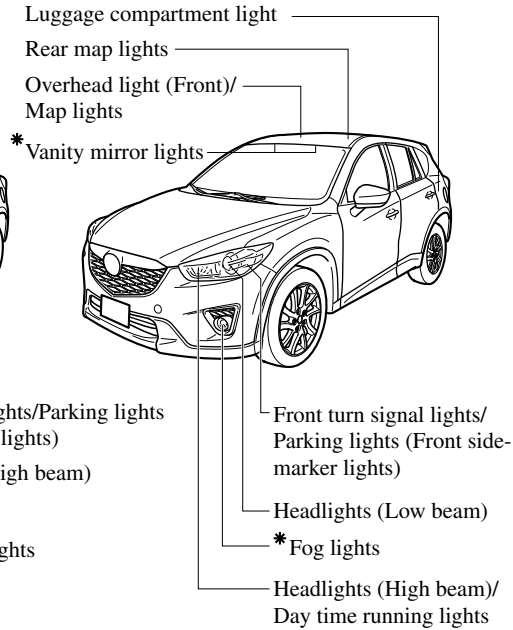

\*Some models.

## Owner Maintenance

### **⚠ WARNING**

**Do not replace the xenon fusion bulbs yourself:**

*Replacing the xenon fusion bulbs yourself is dangerous. Because the xenon fusion bulbs require high voltage, you could receive an electric shock if the bulbs are handled incorrectly. Consult an Authorized Mazda Dealer when the replacement is necessary.*

**Never touch the glass portion of a halogen bulb with your bare hands and always wear eye protection when handling or working around the bulbs:**

*When a halogen bulb breaks, it is dangerous. These bulbs contain pressurized gas. If one is broken, it will explode and serious injuries could be caused by the flying glass. If the glass portion is touched with bare hands, body oil could cause the bulb to overheat and explode when lit.*

**Always keep halogen bulbs out of the reach of children:**

*Playing with a halogen bulb is dangerous. Serious injuries could be caused by dropping a halogen bulb or breaking it some other way.*

### **NOTE**

- *To replace the bulb, contact an Authorized Mazda Dealer.*
- *If the halogen bulb is accidentally touched, it should be cleaned with rubbing alcohol before being used.*
- *Use the protective cover and carton for the replacement bulb to dispose of the old bulb promptly and out of the reach of children.*

### ▼ Replacing Exterior Light Bulbs

#### **Headlights (With xenon fusion headlights)**

##### **Low/High beam bulbs**

You cannot replace the low/high beam bulbs by yourself. The bulbs must be replaced at an expert repairer, we recommend an Authorized Mazda Dealer.

##### **Daytime running lights**

1. Make sure the ignition is switched off, and the headlight switch is off.
2. Lift the hood.
3. Disconnect the connector from the unit by pressing the tab on the connector with your finger and pulling the connector downward.

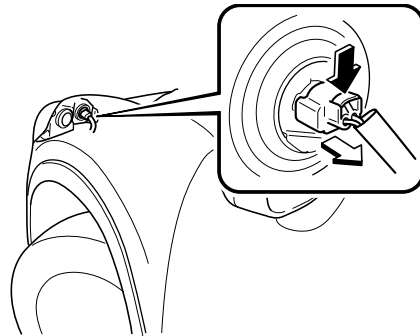

Maintenance and Care

## Owner Maintenance

4. Turn the socket and bulb assembly to remove it. Carefully remove the bulb from its socket in the reflector by gently pulling it straight back out of the socket.

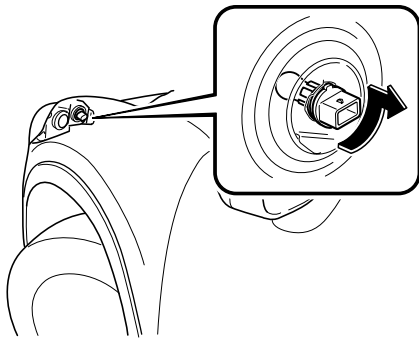

5. Install the new bulb in the reverse order of the removal procedure.

### Headlights (With halogen headlights)

#### Low-beam bulbs, High-beam bulbs/ Daytime running lights

1. Make sure the ignition is switched off, and the headlight switch is off.
2. Lift the hood.
3. **(Right side)**  
Remove the windshield washer fluid reservoir from the guide.

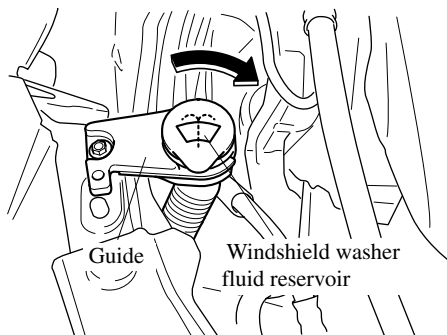

6-42

4. Disconnect the connector from the unit by pressing the tab on the connector with your finger and pulling the connector downward.

#### Low-beam bulbs

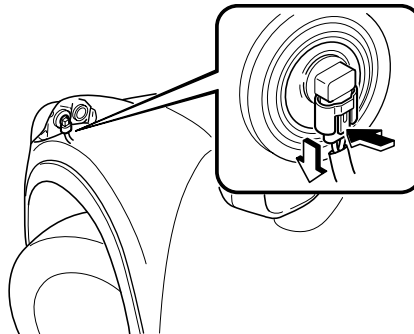

#### High-beam bulbs/Daytime running lights

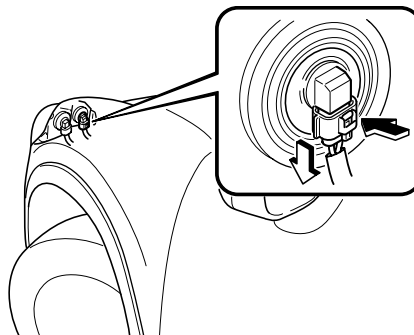

5. Turn the socket and bulb assembly to remove it. Carefully remove the bulb from its socket in the reflector by gently pulling it straight backward out of the socket.

Maintenance and Care  
**Owner Maintenance**

**Low-beam bulbs**

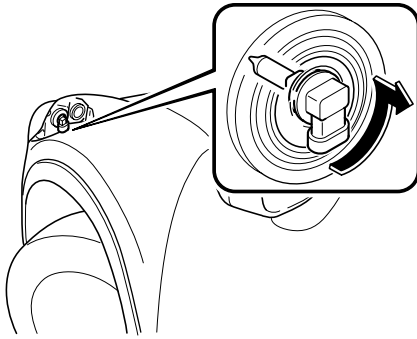

**High-beam bulbs/Daytime running lights**

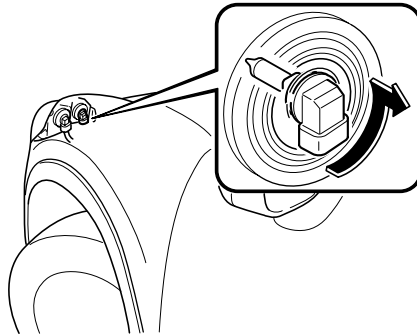

6. Install the new bulb in the reverse order of the removal procedure.

**Front turn signal lights/Parking lights  
(Front side-marker lights)**

1. Make sure the ignition is switched off, and the headlight switch is off.
2. If you are changing the right low-beam bulb, start the engine, turn the steering wheel all the way to the right, and turn off engine. If you are changing the left low-beam bulb, turn the steering wheel to the left.

3. Pull the center of each plastic retainer and remove the retainers.

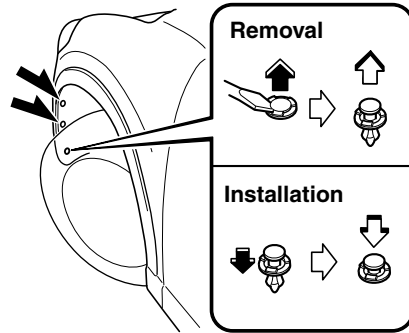

4. Turn the screw counterclockwise and remove it, and then partially peel back the mudguard.

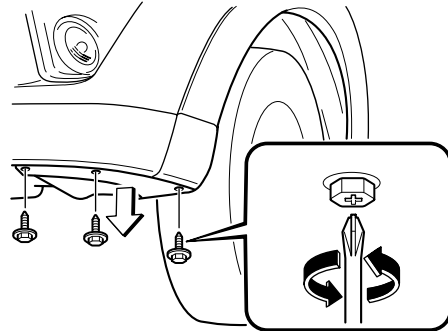

5. Turn the socket and bulb assembly counterclockwise and remove it.

Maintenance and Care

## Owner Maintenance

6. Disconnect the bulb from the socket.

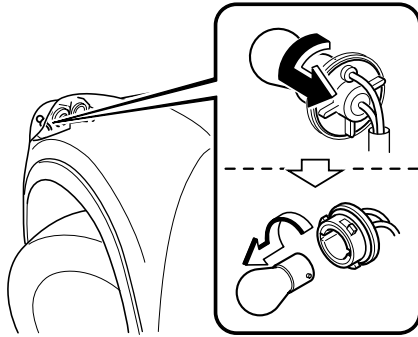

7. Install the new bulb in the reverse order of the removal procedure.

### Fog lights \*

1. Make sure the ignition is switched off, and the headlight switch is off.
2. If you are changing the right low-beam bulb, start the engine, turn the steering wheel all the way to the right, and turn off engine. If you are changing the left low-beam bulb, turn the steering wheel to the left.
3. Pull the center of each plastic retainer and remove the retainers.

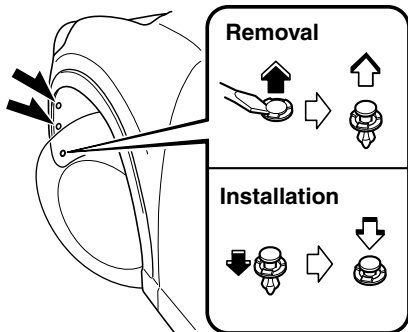

4. Turn the screw counterclockwise and remove it, and then partially peel back the mudguard.

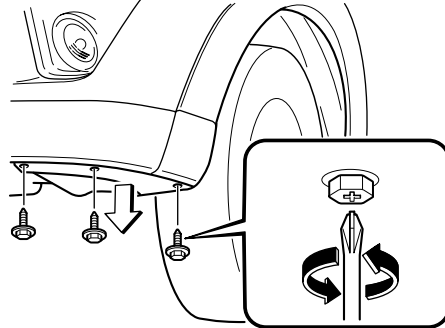

5. Disconnect the connector from the unit by pressing the tab on the connector with your finger and pulling the connector downward.

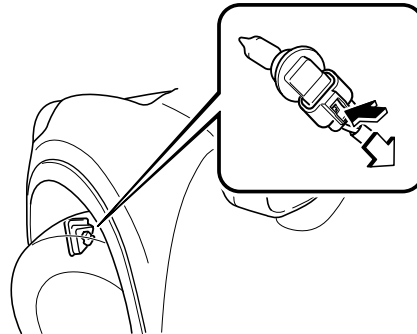



Maintenance and Care  
**Owner Maintenance**

6. Turn the socket and bulb assembly to remove it. Carefully remove the bulb from its socket in the reflector by gently pulling it straight back out of the socket.

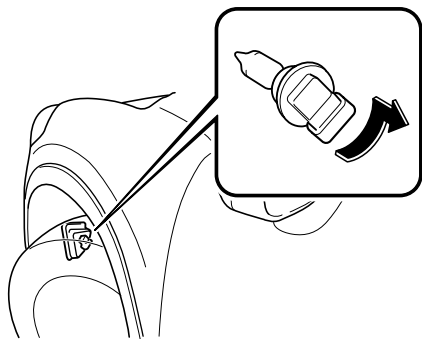

7. Install the new bulb in the reverse order of the removal procedure.

**Side-turn signal lights**

Due to the complexity and difficulty of the procedure, the LED bulbs must be replaced by an Authorized Mazda Dealer.

**NOTE**

*LED bulb replacement is not possible because it is built into the unit. Replace the unit.*

**Brake lights/Taillights, Rear turn signal lights, Rear side-marker lights, Taillights (Liftgate side), Reverse lights**

1. Make sure the ignition is switched off, and the headlight switch is off.
2. Remove the cover with a cloth-wrapped flathead screwdriver to the cover.

**Brake lights/Taillights, Rear turn signal lights, Rear side-marker lights**

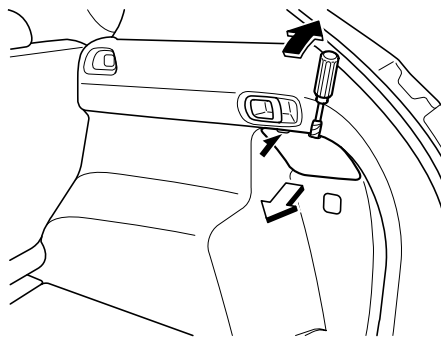

**Taillights (Liftgate side), Reverse lights**

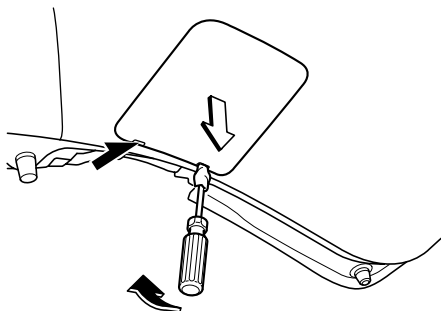

3. Turn the socket and bulb assembly counterclockwise and remove it.
4. Disconnect the bulb from the socket.

Maintenance and Care

## Owner Maintenance

### Brake lights/Taillights

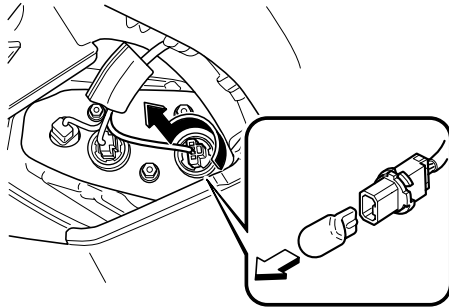

### Rear turn signal lights

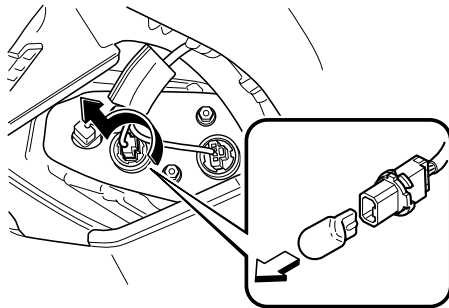

### Rear side-marker lights

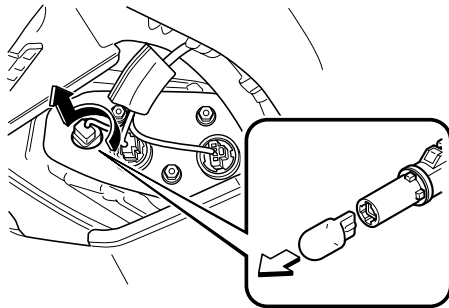

### Taillights (Liftgate side)

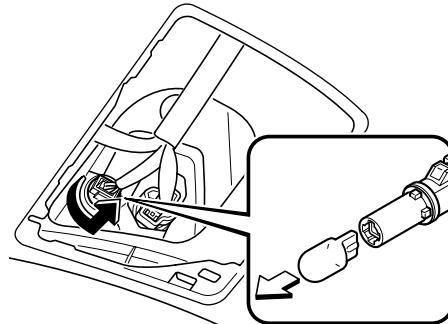

### Reverse lights

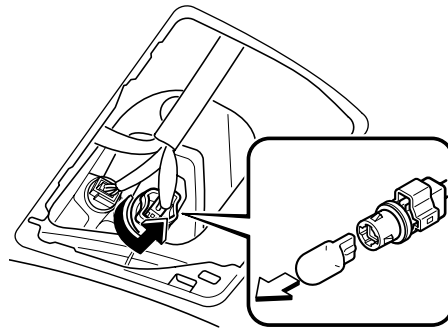

5. Install the new bulb in the reverse order of the removal procedure.

### High-mount brake light

Due to the complexity and difficulty of the procedure, the LED bulbs must be replaced by an Authorized Mazda Dealer.

### **NOTE**

*LED bulb replacement is not possible because it is built into the unit. Replace the unit.*

### License plate lights

1. Make sure the ignition is switched off, and the headlight switch is off.

Maintenance and Care  
**Owner Maintenance**

2. Wrap a flathead screwdriver with a soft cloth to prevent damage to the lens, and then remove the lens by carefully prying on the edge of the lens with a flathead screwdriver.
3. Disconnect the bulb by pulling it out.

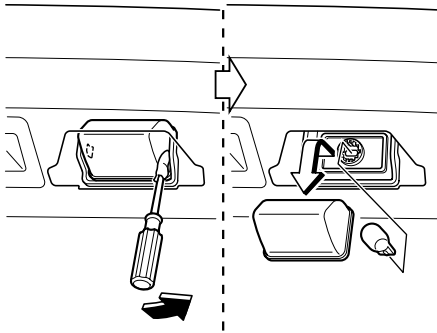

4. Install the new bulb in the reverse order of the removal procedure.

**▼ Replacing Interior Light Bulbs**

**Overhead light (Front)/Map lights,**  
**Rear map lights, Vanity mirror lights \***

1. Wrap a small flathead screwdriver with a soft cloth to prevent damage to the lens, and then remove the lens by carefully prying on the edge of the lens with the flathead screwdriver.
2. Disconnect the bulb by pulling it out.

**Overhead light (Front)/Map lights**

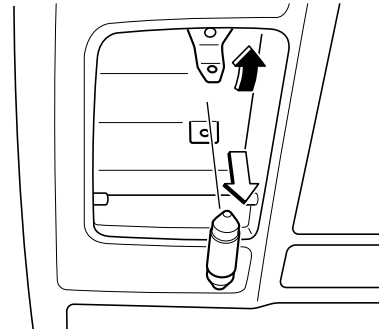
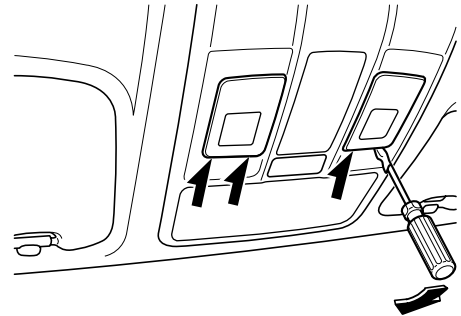

**Rear map lights**

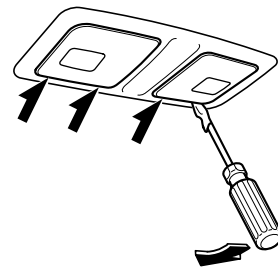

\*Some models. **6-47**

Maintenance and Care

## Owner Maintenance

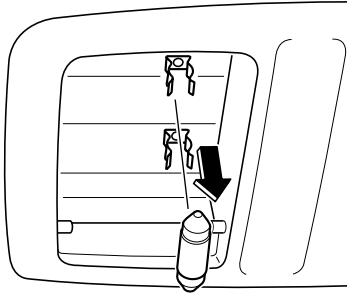

### Vanity mirror lights

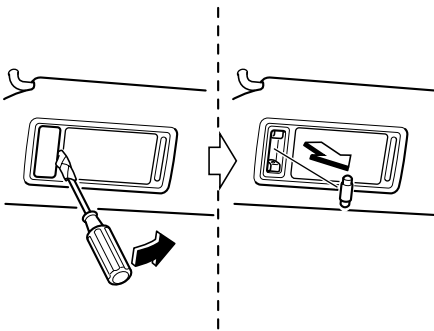

3. Install the new bulb in the reverse order of the removal procedure.

### Luggage compartment light

1. Wrap a small flathead screwdriver with a soft cloth to prevent damage to the lens and remove the lens by carefully prying on the edge of the lens with the flathead screwdriver.

2. Disconnect the bulb by pulling it out.

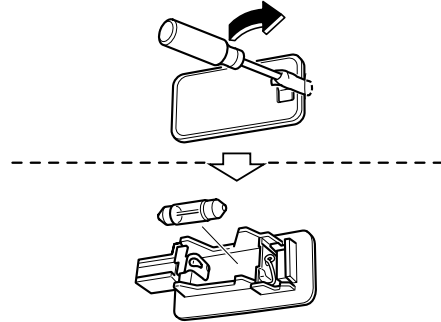

3. Install the new bulb in the reverse order of the removal procedure.

Maintenance and Care  
**Owner Maintenance**

## Fuses

Your vehicle's electrical system is protected by fuses.

If any lights, accessories, or controls do not work, inspect the appropriate circuit protector. If a fuse has blown, the inside element will be melted.

If the same fuse blows again, avoid using that system and consult an Authorized Mazda Dealer as soon as possible.

### ▼ Fuse Replacement

#### Replacing the fuses on the vehicle's left side

If the electrical system does not work, first inspect the fuses on the vehicle's left side.

1. Make sure the ignition is switched off, and other switches are off.
2. Open the fuse panel cover.

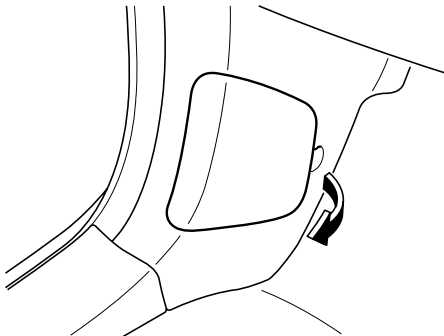

3. Pull the fuse straight out with the fuse puller provided on the fuse block located in the engine compartment.

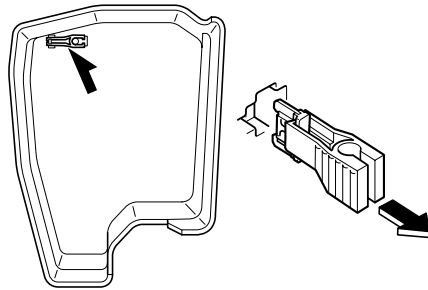

4. Inspect the fuse and replace it if it is blown.

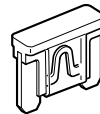

Normal

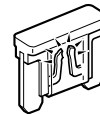

Blown

5. Insert a new fuse of the same amperage rating, and make sure it fits tightly. If it does not fit tightly, have an expert install it. We recommend an Authorized Mazda Dealer. If you have no spare fuses, borrow one of the same rating from a circuit not essential to vehicle operation, such as the AUDIO or OUTLET circuit.

Maintenance and Care

## Owner Maintenance

### **CAUTION**

*Always replace a fuse with a genuine Mazda fuse or equivalent of the same rating. Otherwise you may damage the electric system.*

6. Reinstall the cover and make sure that it is securely installed.

### **Replacing the fuses under the hood**

If the headlights or other electrical components do not work and the fuses in the cabin are normal, inspect the fuse block under the hood. If a fuse is blown, it must be replaced. Follow these steps:

1. Make sure the ignition is switched off, and other switches are off.
2. Remove the fuse block cover.

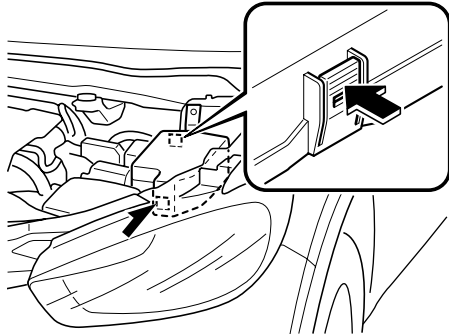

3. If any fuse but the MAIN fuse is blown, replace it with a new one **of the same amperage rating**.

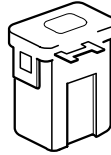

Normal

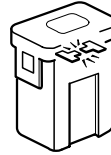

Blown

### **WARNING**

**Do not replace the main fuse by yourself. Have an Authorized Mazda Dealer perform the replacement:**

*Replacing the fuse by yourself is dangerous because the MAIN fuse is a high current fuse. Incorrect replacement could cause an electrical shock or a short circuit resulting in a fire.*

4. Reinstall the cover and make sure that it is securely installed.

Maintenance and Care  
**Owner Maintenance**

▼ **Fuse Panel Description**

**Fuse block (Engine compartment)**

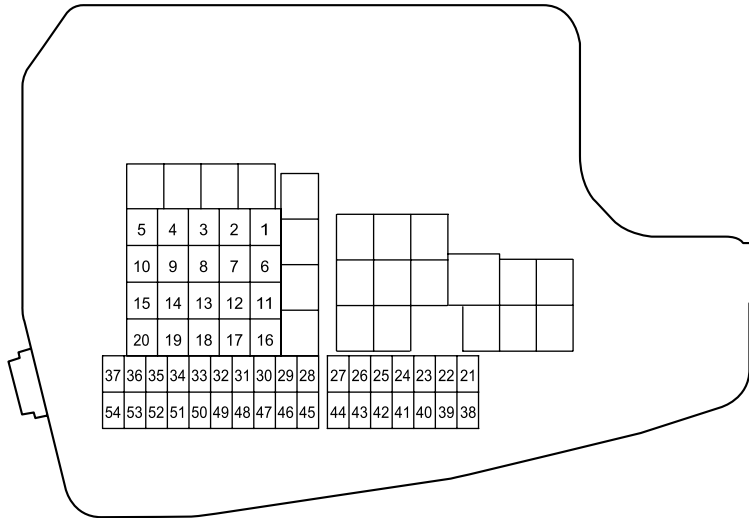

DESCRIPTION	FUSE RATING	PROTECTED COMPONENT	
1	ADD FAN GE	30 A	Cooling fan
2	IG2	30 A	For protection of various circuits
3	INJECTOR	30 A	Engine control system
4	FAN DE	—	—
5	P.WINDOW1	30 A	Power windows
6	—	—	—
7	ADD FAN DE	—	—
8	EVVT	20 A	Engine control system
9	DEFOG	40 A	Rear window defroster
10	DCDC DE	—	—
11	FAN GE	30 A	Cooling fan
12	—	—	—
13	—	—	—
14	—	—	—
15	ENG.MAIN	40 A	Engine control system
16	ABS/DSC M	50 A	ABS, Dynamic stability control system
17	CABIN.+B	50 A	For protection of various circuits

Maintenance and Care

## Owner Maintenance

DESCRIPTION		FUSE RATING	PROTECTED COMPONENT
18	WIPER	20 A	Front window wiper and washer
19	HEATER	40 A	Air conditioner
20	DCDC REG	—	—
21	ENGINE.IG1	7.5 A	Engine control system
22	C/U IG1	15 A	For protection of various circuits
23	H/L LOW L HID L	15 A	Headlight (LH)* <sup>1</sup> , Headlight low beam (LH)* <sup>2</sup>
24	H/L LOW R	15 A	Headlight low beam (RH)* <sup>2</sup>
25	ENGINE3	15 A	Engine control system
26	ENGINE2	15 A	Engine control system
27	ENGINE1	15 A	Engine control system
28	AT	15 A	Transaxle control system
29	H/CLEAN	—	—
30	A/C	7.5 A	Air conditioner
31	AT PUMP	—	—
32	STOP	10 A	Brake lights
33	R.WIPER	15 A	Rear window wiper
34	H/L HI	20 A	Headlight main beam* <sup>2</sup>
35	HID R	15 A	Headlight (RH)* <sup>1</sup>
36	FOG	15 A	Fog lights *
37	ENG.+B	7.5 A	Engine control system
38	AUDIO2	7.5 A	Audio system
39	—	—	—
40	METER2	—	—
41	METER1	10 A	Instrument cluster
42	SRS1	7.5 A	Air bag
43	BOSE	25 A	Bose <sup>®</sup> Sound System-equipped model
44	AUDIO1	15 A	Audio system
45	ABS/DSC S	30 A	ABS, Dynamic stability control system
46	FUEL PUMP	15 A	Fuel system
47	FUEL WARM	—	—
48	TAIL	15 A	Taillights, License plate lights
49	—	—	—
50	HAZARD	25 A	Hazard warning flashers, Turn signal lights, Parking lights (Front side-marker lights)
51	DRL	15 A	Daytime running lights *
52	R.OUTLET2	15 A	Accessory sockets

**6-52** \*Some models.



Maintenance and Care  
**Owner Maintenance**

DESCRIPTION		FUSE RATING	PROTECTED COMPONENT
53	HORN	15 A	Horn
54	ROOM	15 A	Overhead light

\*1 With xenon fusion headlights  
 \*2 With halogen headlights

**Fuse block (Left side)**

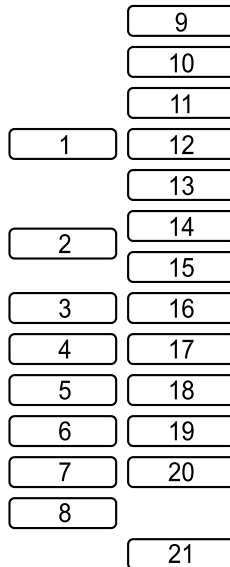

DESCRIPTION		FUSE RATING	PROTECTED COMPONENT
1	P.SEAT D	30 A	Power seat*
2	P.WINDOW3	—	—
3	R.OUTLET3	15 A	Accessory sockets
4	P.WINDOW2	25 A	Power windows
5	SRS2/ESCL	15 A	Seat weight sensor*
6	D.LOCK	25 A	Power door locks
7	SEAT WARM	20 A	Seat warmer*
8	SUNROOF	10 A	Moonroof*
9	F.OUTLET	15 A	Accessory sockets
10	MIRROR	7.5 A	Power control mirror
11	R.OUTLET1	—	—
12	—	—	—

\*Some models. **6-53**



Maintenance and Care

## Owner Maintenance

---

DESCRIPTION		FUSE RATING	PROTECTED COMPONENT
13	—	—	—
14	—	—	—
15	—	—	—
16	—	—	—
17	M.DEF	7.5 A	Mirror defroster*
18	—	—	—
19	—	—	—
20	—	—	—
21	—	—	—

**6-54** \*Some models.

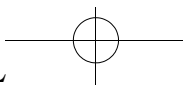

## Appearance Care

### Exterior Care

The paintwork on your Mazda represents the latest technical developments in composition and methods of application.

Environmental hazards, however, can harm the paint's protective properties, if proper care is not taken.

Here are some examples of possible damage, with tips on how to prevent them.

#### **Etching Caused by Acid Rain or Industrial Fallout**

##### **Occurrence**

Industrial pollutants and vehicle emissions drift into the air and mix with rain or dew to form acids. These acids can settle on a vehicle's finish. As the water evaporates, the acid becomes concentrated and can damage the finish.

And the longer the acid remains on the surface, the greater the chance is for damage.

##### **Prevention**

It is necessary to wash and wax your vehicle to preserve its finish according to the instructions in this section. These steps should be taken immediately after you suspect that acid rain has settled on your vehicle's finish.

#### **Damage Caused by Bird Dropping, Insects, or Tree Sap**

##### **Occurrence**

Bird droppings contain acids. If these are not removed they can eat away the clear and color base coat of the vehicle's paintwork.

When insects stick to the paint surface and decompose, corrosive compounds form. These can erode the clear and color base coat of the vehicle's paintwork if they are not removed.

Tree sap will harden and adhere permanently to the paint finish. If you scratch the sap off while it is hard, some vehicle paint could come off with it.

##### **Prevention**

It is necessary to have your Mazda washed and waxed to preserve its finish according to the instructions in this section. This should be done as soon as possible.

Bird droppings can be removed with a soft sponge and water. If you are traveling and these are not available, a moistened tissue may also take care of the problem. The cleaned area should be waxed according to the instructions in this section.

Insects and tree sap are best removed with a soft sponge and water or a commercially available chemical cleaner.

Another method is to cover the affected area with dampened newspaper for one to two hours. After removing the newspaper, rinse off the loosened debris with water.

#### **Water Marks**

##### **Occurrence**

Rain, fog, dew, and even tap water can contain harmful minerals such as salt and lime. If moisture containing these minerals settles on the vehicle and evaporates, the minerals will concentrate and harden to form white rings. The rings can damage your vehicle's finish.

Maintenance and Care

## Appearance Care

### Prevention

It is necessary to wash and wax your vehicle to preserve its finish according to the instructions in this section. These steps should be taken immediately after you find water marks on your vehicle's finish.

### Paint Chipping

#### Occurrence

Paint chipping occurs when gravel thrown in the air by another vehicle's tires hits your vehicle.

#### How to avoid paint chipping

Keeping a safe distance between you and the vehicle ahead reduces the chances of having your paint chipped by flying gravel.

#### NOTE

- *The paint chipping zone varies with the speed of the vehicle. For example, when traveling at 90 km/h (56 mph), the paint chipping zone is 50 m (164 ft).*
- *In low temperatures a vehicle's finish hardens. This increases the chance of paint chipping.*
- *Chipped paint can lead to rust forming on your Mazda. Before this happens, repair the damage by using Mazda touch-up paint according to the instructions in this section. Failure to repair the affected area could lead to serious rusting and expensive repairs.*

Follow **all** label and container directions when using a chemical cleaner or polish. Read all warnings and cautions.

### ▼ Maintaining the Finish

#### Washing

#### CAUTION

- *When the wiper lever is in the AUTO position and the ignition is switched ON, the wipers may move automatically in the following cases:*
  - *If the windshield above the rain sensor is touched or wiped with a cloth.*
  - *If the windshield is struck with a hand or other object from either outside or inside the vehicle.*

*Keep hands and scrapers clear of the windshield when the wiper lever is in the AUTO position and the ignition is switched ON as fingers could be pinched or the wipers and wiper blades damaged when the wipers activate automatically.*

*If you are going to clean the windshield, be sure the wipers are turned off completely—this is particularly important when clearing ice and snow—when it is most likely that the engine is left running.*

- *Do not spray water in the engine compartment. Otherwise, it could result in engine-starting problems or damage to electrical parts.*

To help protect the finish from rust and deterioration, wash your Mazda thoroughly and frequently, at least once a month, with lukewarm or cold water.

## Appearance Care

If the vehicle is washed improperly, the paint surface could be scratched. Here are some examples of how scratching could occur.

Scratches occur on the paint surface when:

- The vehicle is washed without first rinsing off dirt and other foreign matter.
- The vehicle is washed with a rough, dry, or dirty cloth.
- The vehicle is washed at a car wash that uses brushes that are dirty or too stiff.
- Cleansers or wax containing abrasives are used.

### NOTE

- *Mazda is not responsible for scratches caused by automatic car washes or improper washing.*
- *Scratches are more noticeable on vehicles with darker paint finishes.*

To minimize scratches on the vehicle's paint finish:

- Rinse off any dirt or other foreign matter using lukewarm or cold water before washing.
- Use plenty of lukewarm or cold water and a soft cloth when washing the vehicle. Do not use a nylon cloth.
- Rub gently when washing or drying the vehicle.
- Take your vehicle only to a car wash that keeps its brushes well maintained.
- Do not use abrasive cleansers or wax that contain abrasives.

### CAUTION

*Do not use steel wool, abrasive cleaners, or strong detergents containing highly alkaline or caustic agents on chrome-plated or anodized aluminum parts. This may damage the protective coating; also, cleaners and detergents may discolor or deteriorate the paint.*

Pay special attention to removing salt, dirt, mud, and other foreign material from the underside of the fenders, and make sure the drain holes in the lower edges of the doors and rocker panels are clean.

Insects, tar, tree sap, bird droppings, industrial fallout, and similar deposits can damage the finish if not removed immediately. When prompt washing with plain water is ineffective, use a mild soap made for use on vehicles.

Thoroughly rinse off all soap with lukewarm or cold water. Do not allow soap to dry on the finish.

After washing the vehicle, dry it with a clean chamois to prevent water spots from forming.

Maintenance and Care

## Appearance Care

### **⚠ WARNING**

***Dry off brakes that have become wet by driving slowly, releasing the accelerator pedal and lightly applying the brakes several times until the brake performance returns to normal:***

*Driving with wet brakes is dangerous. Increased stopping distance or the vehicle pulling to one side when braking could result in a serious accident. Light braking will indicate whether the brakes have been affected.*

### **When using a high water pressure car wash**

High water temperature and high water pressure car washers are available depending on the type of car wash machine. If the car washer nozzle is put too close to the vehicle, the force of the spray could damage or deform the molding, affect the sealability of parts, and allow water to penetrate the interior. Keep a sufficient space (30 cm or more) between the nozzle and the vehicle. In addition, do not spend too much time spraying the same area of the vehicle, and be very careful when spraying between gaps in doors and around windows.

### **Waxing**

Your vehicle needs to be waxed when water no longer beads on the finish. Always wash and dry the vehicle before waxing it. In addition to the vehicle body, wax the metal trim to maintain its luster.

1. Use wax which contains no abrasives. Waxes containing abrasive will remove paint and could damage bright metal parts.

2. Use a good grade of natural wax for metallic, mica, and solid colors.
3. When waxing, coat evenly with the sponge supplied or a soft cloth.
4. Wipe off the wax with a soft cloth.

### **NOTE**

*A spot remover to remove oil, tar, and similar materials will usually also take off the wax. Rewax these areas even if the rest of the vehicle does not need it.*

### **▼ Repairing Damage to the Finish**

Deep scratches or chips on the finish should be repaired promptly. Exposed metal quickly rusts and can lead to major repairs.

### **⚠ CAUTION**

*If your Mazda is damaged and needs metal parts repaired or replaced, make sure the body shop applies anti-corrosion materials to all parts, both repaired and new. This will prevent them from rusting.*

### **▼ Bright-Metal Maintenance**

- Use tar remover to remove road tar and insects. Never do this with a knife or similar tool.
- To prevent corrosion on bright-metal surfaces, apply wax or chrome preservative and rub it to a high luster.
- During cold weather or in coastal areas, cover bright-metal parts with a coating of wax or preservative heavier than usual. It would also help to coat them with noncorrosive petroleum jelly or some other protective compound.

## Appearance Care

### CAUTION

*Do not use steel wool, abrasive cleaners, or strong detergents containing highly alkaline or caustic agents on chrome-plated or anodized aluminum parts. This may result in damage to the protective coating and cause discoloration or paint deterioration.*

### ▼ Underbody Maintenance

Road chemicals and salt used for ice and snow removal and solvents used for dust control may collect on the underbody. If not removed, they will speed up rusting and deterioration of such underbody parts as fuel lines, frame, floor pan, and exhaust system, even though these parts may be coated with anti-corrosive material.

Thoroughly flush the underbody and wheel housings with lukewarm or cold water at the end of each winter. Try also to do this every month.

Pay special attention to these areas because they easily hide mud and dirt. **It will do more harm than good to wet down the road grime without removing it.**

The lower edges of doors, rocker panels, and frame members have drain holes that should not be clogged. Water trapped there will cause rusting.

### WARNING

***Dry off brakes that have become wet by driving slowly, releasing the accelerator pedal and lightly applying the brakes several times until the brake performance returns to normal:***

*Driving with wet brakes is dangerous. Increased stopping distance or the vehicle pulling to one side when braking could result in a serious accident. Light braking will indicate whether the brakes have been affected.*

### ▼ Aluminum Wheel Maintenance

A protective coating is provided over the aluminum wheels. Special care is needed to protect this coating.

### CAUTION

*Do not use any detergent other than mild detergent. Before using any detergent, verify the ingredients. Otherwise, the product could discolor or stain the aluminum wheels.*

### NOTE

- *Do not use a wire brush or any abrasive cleaner, polishing compound, or solvent on aluminum wheels. They may damage the coating.*
- *Always use a sponge or soft cloth to clean the wheels.*  
*Rinse the wheels thoroughly with lukewarm or cold water. Also, be sure to clean the wheels after driving on dusty or salted roads to help prevent corrosion.*
- *Avoid washing your vehicle in an automatic car wash that uses high-speed or hard brushes.*
- *If your aluminum wheels lose luster, wax the wheels.*

Maintenance and Care

## Appearance Care

### ▼ Plastic Part Maintenance

- When cleaning the plastic lenses of the lights, do not use gasoline, kerosene, rectified spirit, paint, thinner, highly acidic detergents, or strongly alkaline detergents. Otherwise, these chemical agents can discolor or damage the surfaces resulting in a significant loss in functionality. If plastic parts become inadvertently exposed to any of these chemical agents, flush with water immediately.
- If plastic parts such as the bumpers become inadvertently exposed to chemical agents or fluids such as gasoline, oil, engine coolant, or battery fluid, it could cause discoloration, staining, or paint peeling. Wipe off any such chemical agents or fluids using a soft cloth immediately.
- High water temperature and high water pressure car washers are available depending on the type of high pressure car washer device. If the car washer nozzle is put too close to the vehicle or aimed at one area for an extended period of time, it could deform plastic parts or damage the paint.
- Do not use wax containing compounds (polish). Otherwise, it could result in paint damage.
- In addition, do not use an electrical or air tool to apply wax. Otherwise, the frictional heat generated could result in deformation of plastic parts or paint damage.

### Interior Care

#### **⚠ WARNING**

#### ***Do not spray water in the cabin:***

*Splashing water on electrical parts such as the audio unit and switches is dangerous as it could cause a malfunction or a fire.*

### ▼ Dashboard Precautions

Prevent caustic solutions such as perfume and cosmetic oils from contacting the dashboard. They will damage and discolor the dashboard. If these solutions get on the dashboard, wipe them off immediately.

#### **⚠ CAUTION**

*Do not use glazing agents. Glazing agents contain ingredients which may cause discoloration, wrinkling, cracks and peeling.*

### Instrument panel top (soft pad)

- Extremely soft material is used for the soft pad surface. When cleaning, it is recommended that you use a clean towel dampened in a mild detergent to remove soiling.
- If the soft pad surface is rubbed harshly, it could result in the surface being damaged leaving white scratch marks.

### ▼ Cleaning the Upholstery and Interior Trim

#### Vinyl

Remove dust and loose dirt from vinyl with a whisk broom or vacuum cleaner. Clean vinyl with a leather-and-vinyl cleaner.



## Appearance Care

### **Leather\***

Remove dust and sand first using a vacuum cleaner or other means, then wipe dirt off using a soft cloth with a leather cleaner or a soft cloth soaked in mild soap.

Wipe off the remaining cleaner or soap using a cloth soaked in clean water and wrung out well.

Remove moisture with a dry, soft cloth and allow the leather to further dry in a well-ventilated, shaded area. If the leather gets wet such as from rain, also remove moisture and dry it as soon as possible.

### ***NOTE***

- *Because genuine leather is a natural material, its surface is not uniform and it may have natural scars, scratches, and wrinkles.*
- *To maintain the quality for as long as possible, periodical maintenance, about twice a year, is recommended.*
- *Sand and dust on the seat surface may damage the overcoat of the genuine leather surfaces and accelerate wear.*
- *Greasy soiling on genuine leather may cause molding and stains.*
- *Rubbing hard with a stiff brush or cloth may cause damage.*
- *Do not wipe the leather using alcohol, chlorine bleach, or organic solvents such as thinner, benzene, or gasoline. Otherwise, it may cause discoloration or stains.*
- *If the seats get wet, promptly remove moisture with a dry cloth. Remaining moisture on the surface may cause deterioration such as hardening and shrinkage.*
- *Exposure to direct sunlight for long periods may cause deterioration and shrinkage. When parking the car under direct sunlight for long periods, shade the interior using sunshades.*
- *Do not leave vinyl products on the seats for long periods as they may affect the leather quality and coloring. If the cabin temperature becomes hot, the vinyl may deteriorate and adhere to the genuine leather.*

### **Fabric**

Remove dust and loose dirt from fabric with a whisk broom or vacuum cleaner. Clean it with a mild soap solution good for upholstery and carpets. Remove fresh spots immediately with a fabric spot cleaner.

Maintenance and Care

## Appearance Care

To keep the fabric looking clean and fresh, take care of it. Otherwise its color will be affected, it can be stained easily, and its fire-resistance may be reduced.

### **CAUTION**

*Use only recommended cleaners and procedures. Others may affect appearance and fire-resistance.*

### **Piano black panel\***

The following parts are fitted with panels that have been treated with a special coating that resists scratching.

Dash decoration panel

When the panel needs to be cleaned, use a soft cloth to wipe off dirt from the surface.

### **NOTE**

*Scratches or nicks on the panels resulting from the use of a hard brush or cloth may not be repairable.*

### **▼ Cleaning the Lap/Shoulder Belt Webbing**

Clean the webbing with a mild soap solution recommended for upholstery or carpets. Follow instructions. Do not bleach or dye the webbing; this may weaken it.

After cleaning the belts, thoroughly dry the belt webbing and make sure there is no remaining moisture before retracting them.

### **WARNING**

***Have an Authorized Mazda Dealer replace damaged seat belts immediately:***

*Using damaged seat belts is dangerous. In a collision, damaged belts cannot provide adequate protection.*

### **▼ Cleaning the Window Interiors**

If the windows become covered with an oily, greasy, or waxy film, clean them with glass cleaner. Follow the directions on the container.

### **CAUTION**

- *Do not scrape or scratch the inside of the window glass. It could damage the thermal filaments and the antenna lines.*
- *When washing the inside of the window glass, use a soft cloth dampened in lukewarm water, gently wiping the thermal filaments and the antenna lines. Use of glass cleaning products could damage the thermal filaments and the antenna lines.*

Maintenance and Care  
**Appearance Care**

---

▼ **Cleaning the Floor Mats**

Rubber floor mats should be cleaned with mild soap and water only.

**⚠ WARNING**

***Do not use rubber cleaners, such as tire cleaner or tire shine, when cleaning rubber floor mats:***

*Cleaning the rubber floor mats with rubber cleaning products makes the floor mats slippery.*

*This may cause an accident when depressing the accelerator, brake, or clutch (Manual transaxle) pedal or when getting in or out of the vehicle.*

After removing the floor mats for cleaning, always reinstall them securely. Refer to Floor Mat on page 3-38.

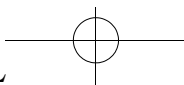
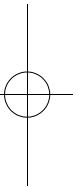
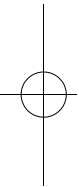
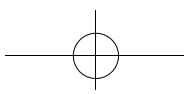

# 7

## If Trouble Arises

Helpful information on what to do if a problem arises with the vehicle.

<b>Parking in an Emergency .....</b>	<b>7-2</b>
Parking in an Emergency .....	7-2
<b>Flat Tire .....</b>	<b>7-3</b>
Spare Tire and Tool Storage .....	7-3
Changing a Flat Tire .....	7-7
<b>Battery Runs Out .....</b>	<b>7-14</b>
Jump-Starting .....	7-14
<b>Emergency Starting .....</b>	<b>7-17</b>
Starting a Flooded Engine .....	7-17
Push-Starting .....	7-17
<b>Overheating .....</b>	<b>7-18</b>
Overheating .....	7-18
<b>Emergency Towing .....</b>	<b>7-20</b>
Towing Description .....	7-20
Tiedown Hooks .....	7-21
Recreational Towing .....	7-23
<b>Warning/Indicator Lights and Warning Sounds .....</b>	<b>7-24</b>
When Warning/Indicator Lights Illuminate/Flash .....	7-24
Warning Sound is Activated .....	7-32
<b>When Liftgate Cannot be Opened .....</b>	<b>7-35</b>
When Liftgate Cannot be Opened .....	7-35

If Trouble Arises

## Parking in an Emergency

---

### Parking in an Emergency

The hazard warning lights should always be used when you stop on or near a roadway in an emergency.

The hazard warning lights warn other drivers that your vehicle is a traffic hazard and that they must take extreme caution when near it.

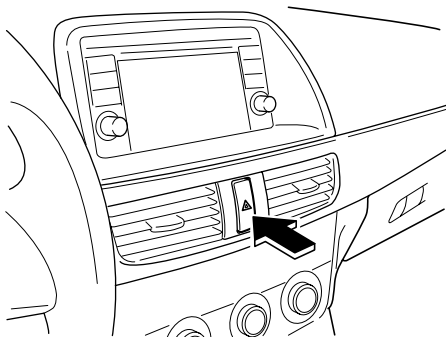

Depress the hazard warning flasher and all the turn signals will flash. The hazard warning indicator lights in the instrument cluster flash simultaneously.

#### **NOTE**

- *The turn signals do not work when the hazard warning lights are on.*
- *Check local regulations about the use of hazard warning lights while the vehicle is being towed to verify that it is not in violation of the law.*

If Trouble Arises  
**Flat Tire**

## Spare Tire and Tool Storage

Spare tire and tools are stored in the locations illustrated in the diagram.  
**Except Mexico**

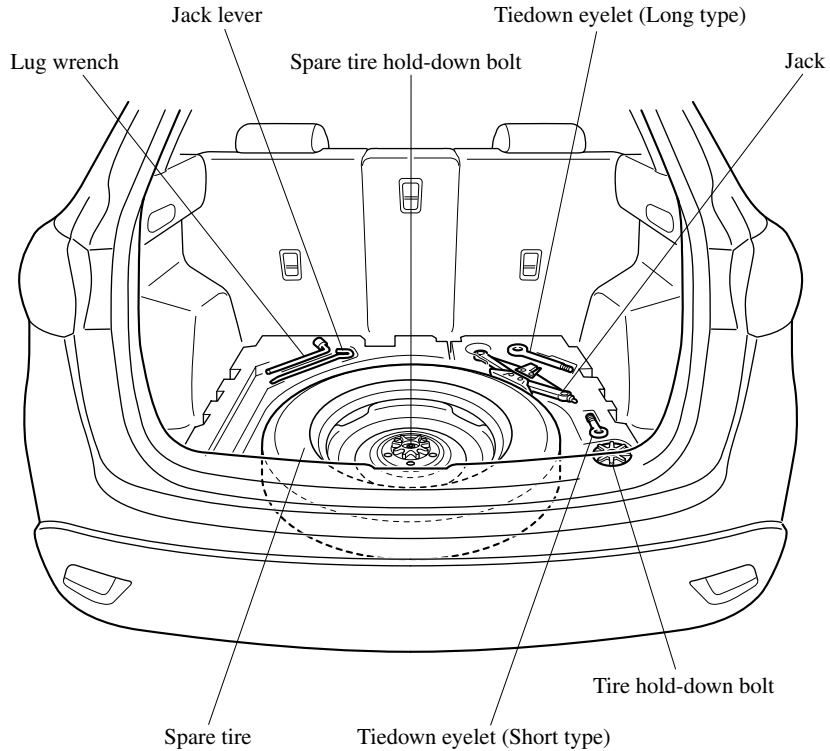



If Trouble Arises  
**Flat Tire**

---

**Mexico**

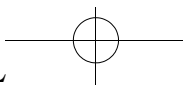
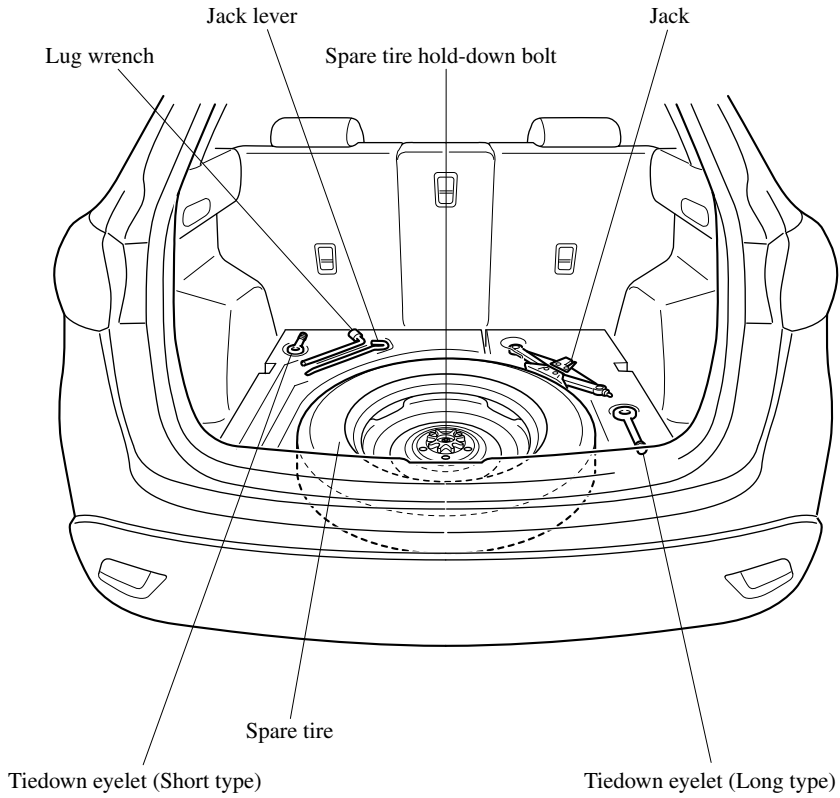



If Trouble Arises  
**Flat Tire**

▼ **Jack**

**To remove the jack**

1. Open the trunk board.

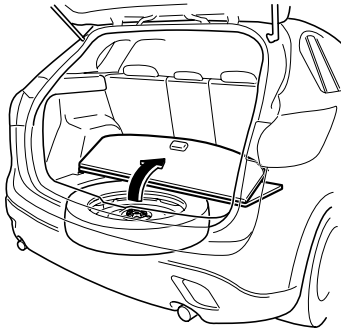

2. Secure the trunk board by attaching the hook to the head restraint.

**Without luggage compartment cover**

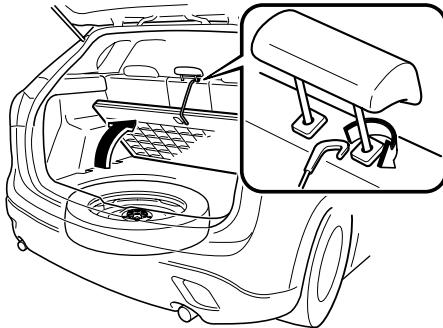

**With luggage compartment cover**

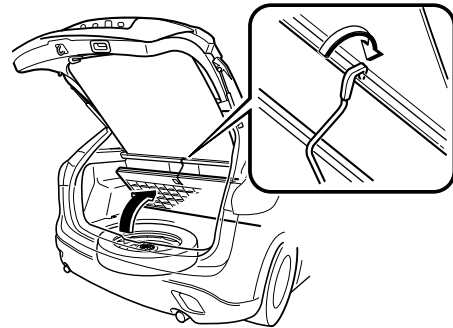

3. Remove the jack.

**To secure the jack**

Perform the removal procedure in reverse.

**Maintenance**

- Always keep the jack clean.
- Make sure the moving parts are kept free from dirt or rust.
- Make sure the screw thread is adequately lubricated.

▼ **Spare Tire**

Your Mazda has a temporary spare tire. The temporary spare tire is lighter and smaller than a conventional tire, and is designed only for emergency use and should be used only for VERY short periods. Temporary spare tires should NEVER be used for long drives or extended periods.

If Trouble Arises

## Flat Tire

### **⚠ WARNING**

**Do not install the temporary spare tire on the front wheels (driving wheels):**  
*Driving with the temporary spare tire on one of the front driving wheels is dangerous. Handling will be affected. You could lose control of the vehicle, especially on ice or snow bound roads, and have an accident. Move a regular tire to the front wheel and install the temporary spare tire to the rear.*

### **⚠ CAUTION**

- *When using the temporary spare tire, driving stability may decrease compared to when using only the conventional tire. Drive carefully.*
- *To avoid damage to the temporary spare tire or to the vehicle, observe the following precautions:*
  - *Do not exceed 80 km/h (50 mph).*
  - *Avoid driving over obstacles. Also, do not drive through an automatic car wash. This tire's diameter is smaller than a conventional tire, so the ground clearance is reduced about 10 mm (0.4 in).*
  - *Do not use a tire chain on this tire because it will not fit properly.*
  - *Do not use your temporary spare tire on any other vehicle, it has been designed only for your Mazda.*
  - *Use only one temporary spare tire on your vehicle at the same time.*

### **To remove the spare tire**

1. Open the trunk board.

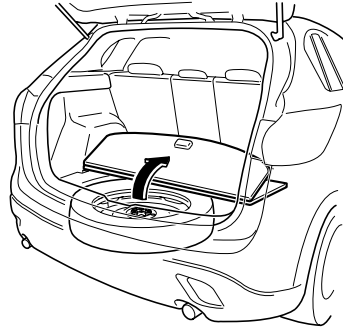

2. Secure the trunk board by attaching the hook to the head restraint.

### **Without luggage compartment cover**

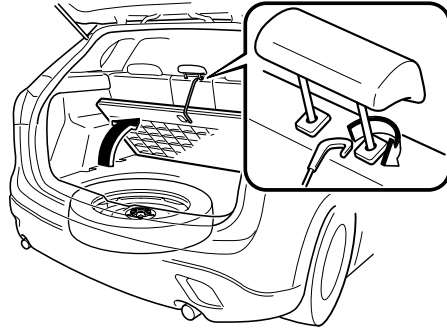

### **With luggage compartment cover**

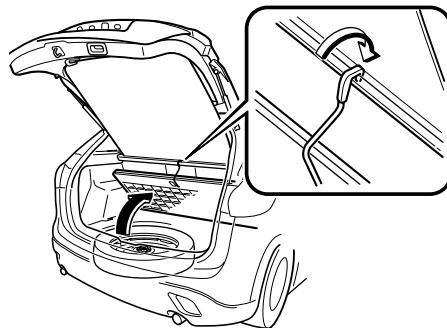

If Trouble Arises  
**Flat Tire**

3. Turn the spare tire hold-down bolt counterclockwise.

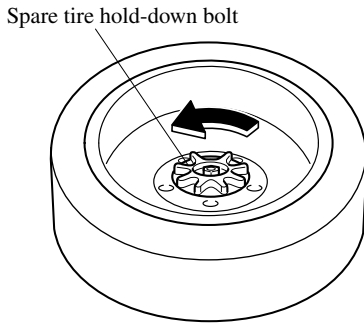

**To secure the spare tire**

Store the spare tire in the reverse order of removal. After storing, verify that the spare tire is stored securely.

**Changing a Flat Tire**

**NOTE**

If the following occurs while driving, it could indicate a flat tire.

- Steering becomes difficult.
- The vehicle begins to vibrate excessively.
- The vehicle pulls in one direction.

If you have a flat tire, drive slowly to a level spot that is well off the road and out of the way of traffic to change the tire. Stopping in traffic or on the shoulder of a busy road is dangerous.

**⚠ WARNING**

**Be sure to follow the directions for changing a tire:**

*Changing a tire is dangerous if not done properly. The vehicle can slip off the jack and seriously injure someone. No person should place any portion of their body under a vehicle that is supported by a jack.*

**Never allow anyone inside a vehicle supported by a jack:**

*Allowing someone to remain in a vehicle supported by a jack is dangerous. The occupant could cause the vehicle to fall resulting in serious injury.*

**NOTE**

Make sure the jack is well lubricated before using it.

1. Park on a level surface off the right-of-way and firmly set the parking brake.
2. Put a vehicle with an automatic transaxle in Park (P), a manual transaxle in Reverse (R) or 1, and turn off the engine.
3. Turn on the hazard warning flasher.

If Trouble Arises

## Flat Tire

4. Have everyone get out of the vehicle and away from the vehicle and traffic.
5. Remove the jack, tool, and spare tire (page 7-3).
6. Block the wheel diagonally opposite the flat tire. When blocking a wheel, place a tire block both in front and behind the tire.

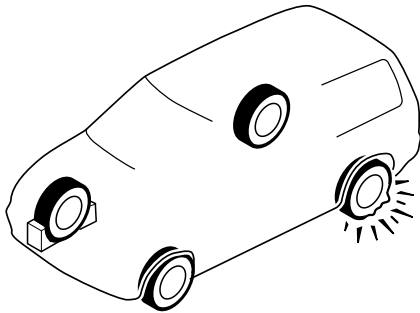

### NOTE

When blocking a tire, use rocks or wood blocks of sufficient size if possible to hold the tire in place.

### ▼ Removing a Flat Tire

1. If your vehicle is equipped with steel wheels, pry off the center cap with the beveled end of the jack lever.

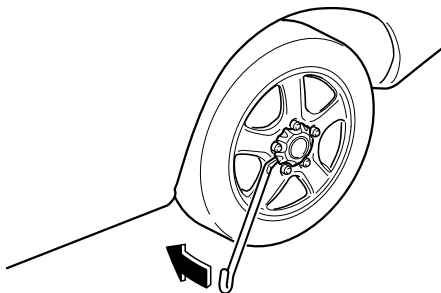

### CAUTION

Use the jack lever when removing the center cap. Using your hands to remove it may cause an injury. In addition, using a tool other than the jack lever may cause damage to the wheel or the center cap.

2. Loosen the lug nuts by turning them counterclockwise one turn each, but do not remove any lug nuts until the tire has been raised off the ground.

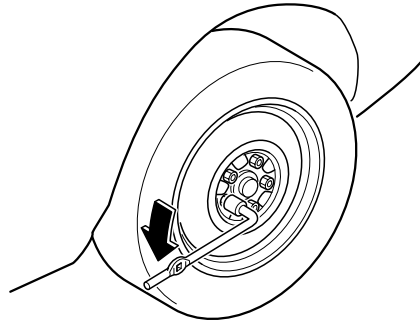

3. Place the jack on the ground.
4. Turn the jack screw in the direction shown in the figure and adjust the jack head so that it is close to the jack-up position.

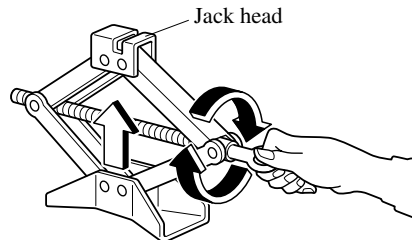

If Trouble Arises  
**Flat Tire**

5. Place the jack under the jack-up position closest to the tire being changed with the jack head squarely under the jack-up point.

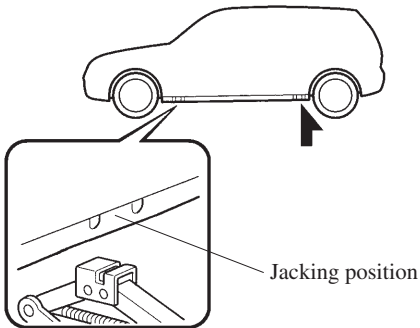

6. Continue raising the jack head gradually by rotating the screw with your hand until the jack head is inserted into the jack-up position.

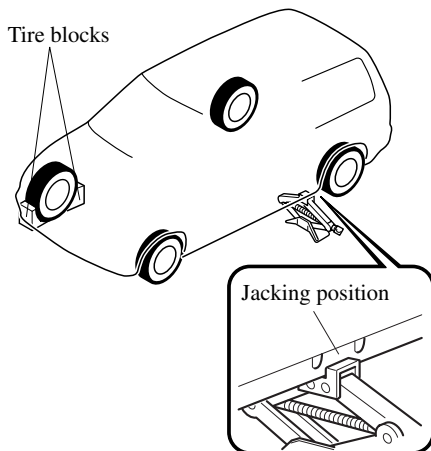

**⚠ WARNING**

**Use only the front and rear jacking positions recommended in this manual:**

Attempting to jack the vehicle in positions other than those recommended in this manual is dangerous. The vehicle could slip off the jack and seriously injure or even kill someone. Use only the front and rear jacking positions recommended in this manual.

**Do not jack up the vehicle in a position other than the designated jack-up position or place any objects on or under the jack:**

Jacking up the vehicle in a position other than the designated jack-up position or placing objects on or under the jack is dangerous as it could deform the vehicle body or the vehicle could fall off the jack resulting in an accident.

**Use only the jack provided with your Mazda:**

Using a jack that is not designed for your Mazda is dangerous. The vehicle could slip off the jack and seriously injure someone.

**Never place objects under the jack:**

Jacking the vehicle with an object under the jack is dangerous. The jack could slip and someone could be seriously injured by the jack or the falling vehicle.

If Trouble Arises

## Flat Tire

7. Insert the jack lever and attach the lug wrench to tire jack.

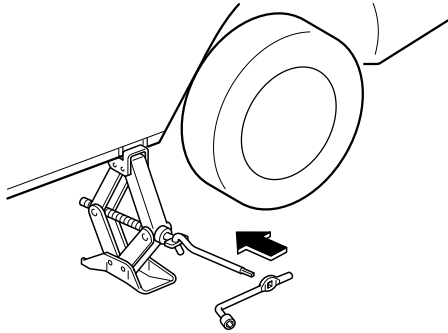

8. Turn the jack handle clockwise and raise the vehicle high enough so that the spare tire can be installed. Before removing the lug nuts, make sure your Mazda is firmly in position and that it cannot slip or move.

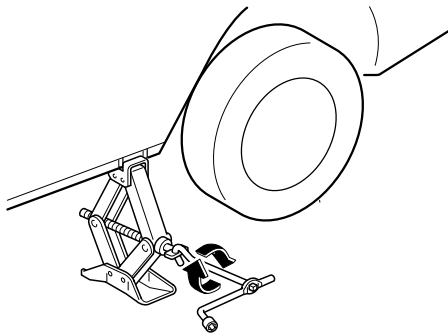

### **⚠ WARNING**

**Do not jack up the vehicle higher than is necessary:**

*Jacking up the vehicle higher than is necessary is dangerous as it could destabilize the vehicle resulting in an accident.*

**Do not start the engine or shake the vehicle while it is jacked up:**

*Starting the engine or shaking the vehicle while it is jacked up is dangerous as it could cause the vehicle to fall off the jack resulting in an accident.*

**Never go under the vehicle while it is jacked up:**

*Going under the vehicle while it is jacked up is dangerous as it could result in death or serious injury if the vehicle were to fall off the jack.*

9. Remove the lug nuts by turning them counterclockwise; then remove the wheel and center cap.

If Trouble Arises  
**Flat Tire**

▼ **Locking Lug Nuts**

If your vehicle has optional anti-theft wheel lug nuts, one on each wheel will lock the tires and you must use a special key to unlock them. This key is attached to the lug wrench and is stored with the spare tire. Register them with the lock manufacturer by filling out the card provided in the glove compartment and mailing it in the accompanying envelope. If you lose this key, consult an Authorized Mazda Dealer or use the lock manufacturer's order form, which is with the registration card.

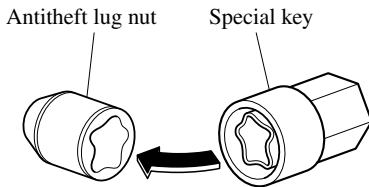

**To remove an anti-theft lug nut**

1. Obtain the key for the anti-theft lug nut.
2. Place the key on top of the nut, and be sure to hold the key square to it. If you hold the key at an angle, you may damage both key and nut. Do not use a power impact wrench.
3. Place the lug wrench on top of the key and apply pressure. Turn the wrench counterclockwise.

**To install the nut**

1. Place the key on top of the nut, and be sure to hold the key square to it. If you hold the key at an angle, you may damage both key and nut. Do not use a power impact wrench.
2. Place the lug wrench on top of the key, apply pressure, and turn it clockwise.

▼ **Mounting the Spare Tire**

1. Remove dirt and grime from the mounting surfaces of the wheel and hub, including the hub bolts, with a cloth.

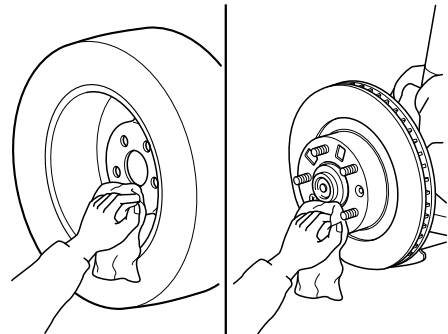

**⚠ WARNING**

***Make sure the mounting surfaces of the wheel, hub and lug nuts are clean before changing or replacing tires:***

*When changing or replacing a tire, not removing dirt and grime from the mounting surfaces of the wheel, hub and hub bolts is dangerous. The lug nuts could loosen while driving and cause the tire to come off, resulting in an accident.*

2. Mount the spare tire.

If Trouble Arises

## Flat Tire

3. Install the lug nuts with the beveled edge inward; tighten them by hand.

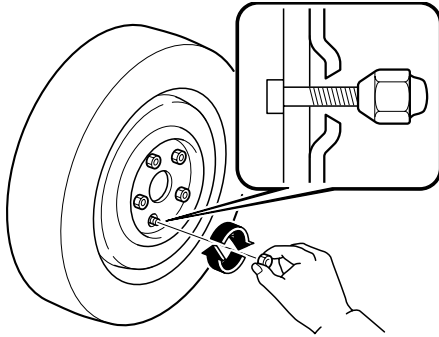

### **⚠ WARNING**

**Do not apply oil or grease to lug nuts and bolts and do not tighten the lug nuts beyond the recommended tightening torque:**

*Applying oil or grease to lug nuts and bolts is dangerous. The lug nuts could loosen while driving and cause the tire to come off, resulting in an accident. In addition, lug nuts and bolts could be damaged if tightened more than necessary.*

4. Turn the lug wrench counterclockwise and lower the vehicle. Use the lug wrench to tighten the nuts in the order shown.

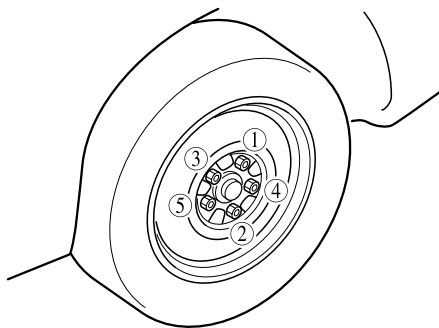

If you are unsure of how tight the nuts should be, have them inspected at an Authorized Mazda Dealer.

Nut tightening torque	
N·m (kgf·m, ft·lbf)	108—147 (12—14, 80—108)

### **⚠ WARNING**

**Always securely and correctly tighten the lug nuts:**

*Improperly or loosely tightened lug nuts are dangerous. The wheel could wobble or come off. This could result in loss of vehicle control and cause a serious accident.*

**Be sure to reinstall the same nuts you removed or replace them with metric nuts of the same configuration:**

*Because the wheel studs and lug nuts on your Mazda have metric threads, using a non-metric nut is dangerous. On a metric stud, it would not secure the wheel and would damage the stud, which could cause the wheel to slip off and cause an accident.*

5. **(Aluminum wheel equipped vehicle)** Remove the center cap by tapping it with the lug wrench.
6. Store the damaged tire, using the tire hold-down bolt to hold it in place.

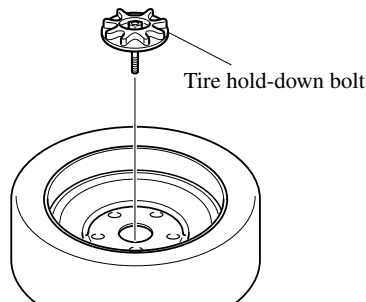



If Trouble Arises  
**Flat Tire**

7. Remove the tire blocks and store the tools and jack.
8. Check the inflation pressure. Refer to Tires on page 9-7.
9. Have the flat tire repaired or replaced as soon as possible.

**! WARNING**

***Do not drive with any tires that have incorrect air pressure:***

*Driving on tires with incorrect air pressure is dangerous. Tires with incorrect pressure could affect handling and result in an accident. When you check the regular tires' air pressure, check the spare tire, too.*

**NOTE**

*To prevent the jack and tool from rattling, store them properly.*

If Trouble Arises

## Battery Runs Out

### Jump-Starting

Jump-starting is dangerous if done incorrectly. So follow the procedure carefully. If you feel unsure about jump-starting, we strongly recommend that you have a competent service technician do the work.

#### **WARNING**



#### **Follow These Precautions Carefully:**

To ensure safe and correct handling of the battery, read the following precautions carefully before using the battery or inspecting it.



**Do not allow the positive (+) terminal to contact any other metal object that could cause sparks:**

Flames and sparks near open battery cells are dangerous. Hydrogen gas, produced during normal battery operation, could ignite and cause the battery to explode. An exploding battery can cause serious burns and injuries. When working near a battery, do not allow metal tools to contact the positive (+) or negative (-) terminal of the battery.



**Keep all flames, including cigarettes, and sparks away from open battery cells:**

Flames and sparks near open battery cells are dangerous. Hydrogen gas, produced during normal battery operation, could ignite and cause the battery to explode. An exploding battery can cause serious burns and injuries.

**Do not jump-start a frozen battery or one with a low fluid level:**

Jump-starting a frozen battery or one with a low fluid level is dangerous. It may rupture or explode, causing serious injury.

**Connect the negative cable to a good ground point away from the battery:**

Connecting the end of the second jumper cable to the negative (-) terminal of the discharged battery is dangerous.

A spark could cause the gas around the battery to explode and injure someone.

**Route the jumper cables away from parts that will be moving:**

Connecting a jumper cable near or to moving parts (cooling fans, belts) is dangerous. The cable could get caught when the engine starts and cause serious injury.

If Trouble Arises

## Battery Runs Out

### **CAUTION**

*Use only a 12 V booster system. You can damage a 12 V starter, ignition system, and other electrical parts beyond repair with a 24 V power supply (two 12 V batteries in series or a 24 V motor generator set).*

Connect cables in numerical order and disconnect in reverse order.

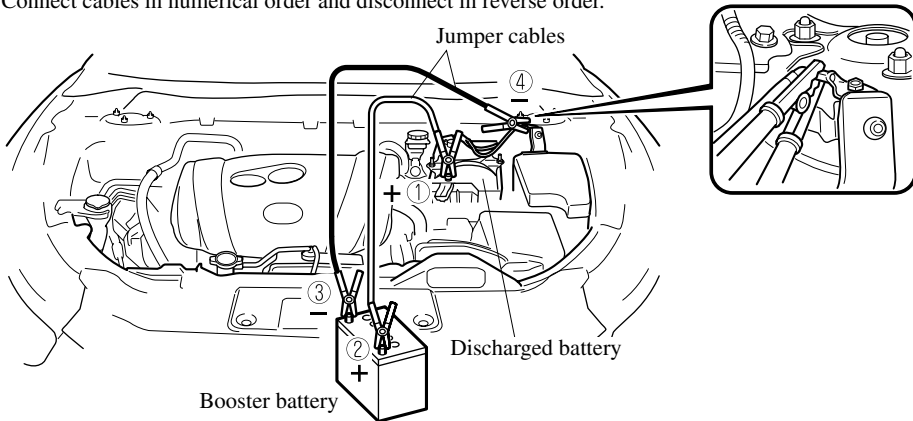

1. Remove the battery cover.

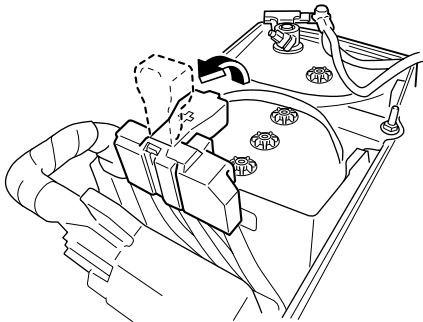

2. Make sure the booster battery is 12 V and that its negative terminal is grounded.

3. If the booster battery is in another vehicle, do not allow both vehicles to touch. Turn off the engine of the vehicle with the booster battery and all unnecessary electrical loads in both vehicles.

4. Connect the jumper cables in the exact sequence as in the illustration.

- Connect one end of a cable to the positive terminal on the discharged battery (1).
- Attach the other end to the positive terminal on the booster battery (2).
- Connect one end of the other cable to the negative terminal of the booster battery (3).
- Connect the other end to the ground point indicated in the illustration away from the discharged battery (4).



If Trouble Arises

## Battery Runs Out

---

5. Start the engine of the booster vehicle and run it a few minutes. Then start the engine of the other vehicle.
6. When finished, carefully disconnect the cables in the reverse order described in the illustration.
7. If the battery cover has been removed, install it in the reverse order of removal.

### **NOTE**

*Verify that the covers are securely installed.*

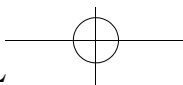

If Trouble Arises

## Emergency Starting

### Starting a Flooded Engine

If the engine fails to start, it may be flooded (excessive fuel in the engine).

Follow this procedure:

1. If the engine does not start within five seconds on the first try, wait ten seconds and try again.
2. Make sure the parking brake is on.
3. Depress the accelerator all the way and hold it there.
4. Depress the clutch pedal (Manual transaxle) or the brake pedal (Automatic transaxle), then press the push button start. If the engine starts, release the accelerator immediately because the engine will suddenly rev up.
5. If the engine fails to start, crank it without depressing the accelerator.

If the engine still does not start using the above procedure, have your vehicle inspected by an Authorized Mazda Dealer.

### Push-Starting

Do not push-start your Mazda.

#### **WARNING**

**Never tow a vehicle to start it:**

*Towing a vehicle to start it is dangerous. The vehicle being towed could surge forward when its engine starts, causing the two vehicles to collide. The occupants could be injured.*

#### **CAUTION**

*Do not push-start a vehicle that has a manual transaxle. It can damage the emission control system.*

#### **NOTE**

*You cannot start a vehicle with an automatic transaxle by pushing it.*

If Trouble Arises

## Overheating

### Overheating

If the High engine coolant temperature warning light illuminates, the vehicle loses power, or you hear a loud knocking or pinging noise, the engine is probably too hot.

#### **WARNING**



**Switch the ignition to off and make sure the fan is not running before attempting to work near the cooling fan:**

*Working near the cooling fan when it is running is dangerous. The fan could continue running indefinitely even if the engine has stopped and the engine compartment temperature is high. You could be hit by the fan and seriously injured.*



**Do not remove either cooling system cap when the engine and radiator are hot:**

*When the engine and radiator are hot, scalding coolant and steam may shoot out under pressure and cause serious injury.*

**Open the hood ONLY after steam is no longer escaping from the engine:**

*Steam from an overheated engine is dangerous. The escaping steam could seriously burn you.*

If the High engine coolant temperature warning light illuminates:

1. Drive safely to the side of the road and park off the right-of-way.

2. Put a vehicle with an automatic transaxle in park (P), a manual transaxle in neutral.
3. Apply the parking brake.
4. Turn off the air conditioner.
5. Check whether coolant or steam is escaping from the engine compartment.

#### **If steam is coming from the engine compartment:**

Do not go near the front of the vehicle. Stop the engine. Wait until the steam dissipates, then open the hood and start the engine.

#### **If neither coolant nor steam is escaping:**

Open the hood and idle the engine until it cools.

#### **CAUTION**

*If the cooling fan does not operate while the engine is running, the engine temperature will increase. Stop the engine and call an Authorized Mazda Dealer.*

6. Make sure the cooling fan is operating, then turn off the engine after the temperature has decreased.
7. When cool, check the coolant level. If it is low, look for coolant leaks from the radiator and hoses.

If Trouble Arises  
**Overheating**

**If you find a leak or other damage, or if coolant is still leaking:**

Stop the engine and call an Authorized Mazda Dealer.

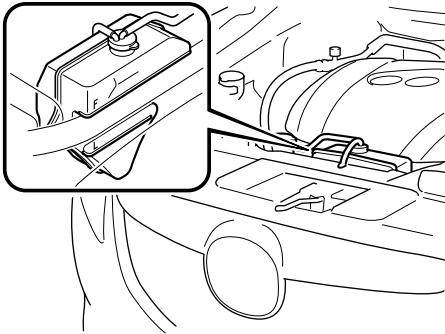

**If you find no problems, the engine is cool, and no leaks are obvious:**

Carefully add coolant as required (page 6-22).

**⚠ CAUTION**

*If the engine continues to overheat or frequently overheats, have the cooling system inspected. The engine could be seriously damaged unless repairs are made. Consult an Authorized Mazda Dealer.*

If Trouble Arises

## Emergency Towing

### Towing Description

We recommend that towing be done only by an Authorized Mazda Dealer or a commercial tow-truck service.

Proper lifting and towing are necessary to prevent damage to the vehicle. Particularly when towing a AWD vehicle, where all the wheels are connected to the drive train, proper transporting of the vehicle is absolutely essential to avoid damaging the drive system. Government and local laws must be followed.

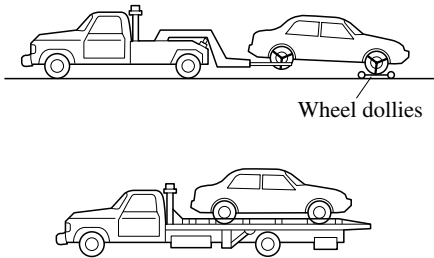

A towed 2WD vehicle should have its drive wheels (front wheels) off the ground. If excessive damage or other conditions prevent this, use wheel dollies.

When towing a 2WD vehicle with the rear wheels on the ground, release the parking brake.

A towed AWD vehicle must have all its wheels off the ground.

### **⚠ WARNING**

**Always tow a AWD vehicle with all four wheels off the ground:**

*Towing a AWD vehicle with either the front or rear wheels on the ground is dangerous as the drive train could be damaged, or the vehicle could trail away from the tow truck and cause an accident. If the drive train has been damaged, transport the vehicle on a flat bed truck.*

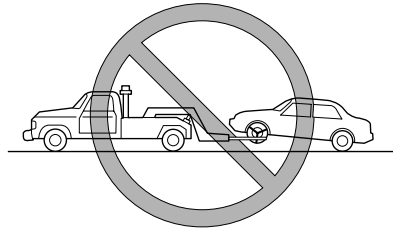



If Trouble Arises

## Emergency Towing

### **CAUTION**

- Do not tow the vehicle pointed backward with driving wheels on the ground. This may cause internal damage to the transaxle.

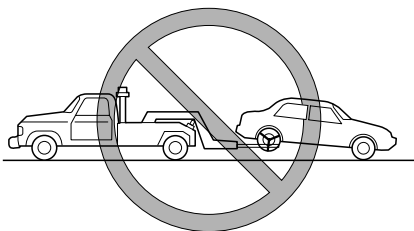

- Do not tow with sling-type equipment. This could damage your vehicle. Use wheel-lift or flatbed equipment.

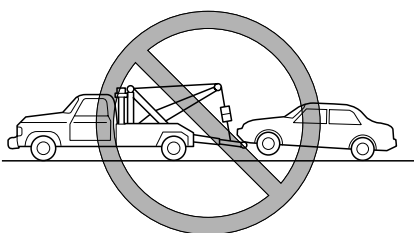

### Tiedown Hooks

#### **CAUTION**

Do not use the front and rear tiedown eyelets for towing the vehicle. They have been designed only for securing the vehicle to a transport vessel during shipping. Using the eyelets for any other purpose could result in the vehicle being damaged.

#### ▼ Tiedown Hooks

1. Remove the tiedown eyelet and the lug wrench from the luggage compartment (page 7-3).
2. Wrap a flathead screwdriver or similar tool with a soft cloth to prevent damage to a painted bumper, and open the cap located on the front or rear bumper.

#### Front

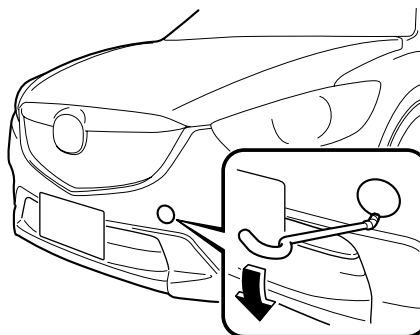

If Trouble Arises

## Emergency Towing

### Rear

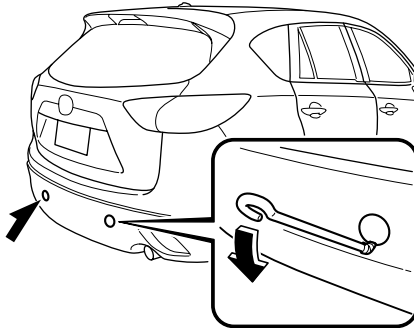

### **CAUTION**

*Do not use excessive force as it may damage the cap or scratch the painted bumper surface.*

### **NOTE**

*Remove the cap completely and store it so as not to lose it.*

3. Securely install the tiedown eyelet using the lug wrench.

### Front

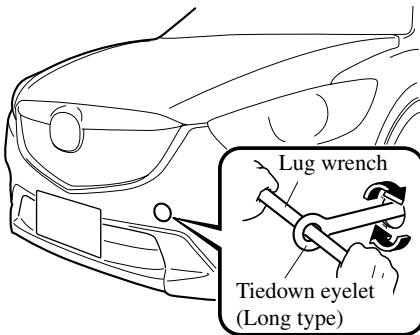

### Rear

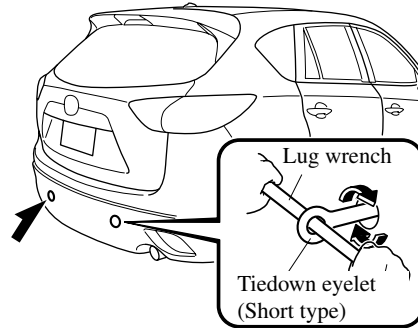

4. Hook the tying rope to the tiedown eyelet.

### Front

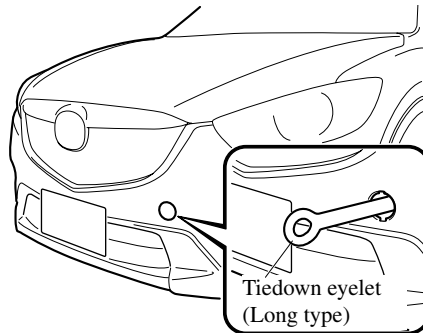

### Rear

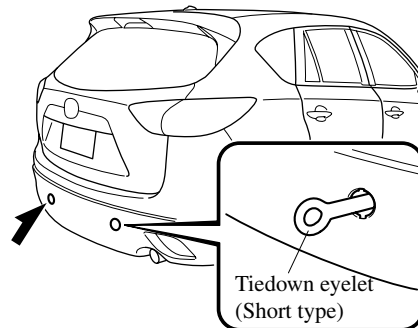



If Trouble Arises

## Emergency Towing

### CAUTION

*If the tiedown eyelet is not securely tightened, it may loosen or disengage from the bumper when tying the vehicle. Make sure that the tiedown eyelet is securely tightened to the bumper.*

### Recreational Towing

An example of “recreational towing” is towing your vehicle behind a motorhome. The transaxle is not designed for towing this vehicle on all 4 wheels.

When doing recreational towing refer to “Towing Description” (page 7-20) and “Tiedown Hooks” (page 7-21) and carefully follow the instructions.

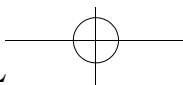
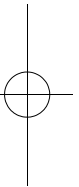
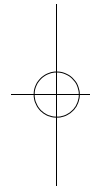

If Trouble Arises

## Warning/Indicator Lights and Warning Sounds

### When Warning/Indicator Lights Illuminate/Flash

#### ▼ If the brake system warning light illuminates



**BRAKE**

If the light stays on after the parking brake is fully released there may be a problem with the brakes.

Drive to the side of the road and park off the right-of-way.

You may notice that the pedal is harder to depress or that it may go closer to the floor. In either case, it will take longer to stop the vehicle.

1. With the engine stopped, open the hood and check the brake fluid level immediately, and then add fluid if required (page 6-24).
2. After adding fluid, check the light again.

If the warning light remains on, or if the brakes do not operate properly, do not drive the vehicle. Have it towed to an Authorized Mazda Dealer.

Even if the light turns off, have your brake system inspected as soon as possible by an Authorized Mazda Dealer.

#### **NOTE**

*Having to add brake fluid is sometimes an indicator of leakage. Consult an Authorized Mazda Dealer as soon as possible even if the brake light is no longer illuminated.*

#### **⚠ WARNING**

**Do not drive with the brake system warning light illuminated. Contact an Authorized Mazda Dealer to have the brakes inspected as soon as possible:**

*Driving with the brake system warning light illuminated is dangerous. It indicates that your brakes may not work at all or that they could completely fail at any time. If this light remains illuminated, after checking that the parking brake is fully released, have the brakes inspected immediately.*

#### ▼ If the master warning light illuminates



The light illuminates continuously if any one of the following occurs. Consult an Authorized Mazda Dealer.

- There is a malfunction in the battery management system.
- There is a malfunction in the brake switch.

If Trouble Arises

## Warning/Indicator Lights and Warning Sounds

### ▼ If the antilock brake system (ABS) warning light illuminates



If the ABS warning light stays on while you're driving, the ABS control unit has detected a system malfunction. If this occurs, your brakes will function normally as if the vehicle had no ABS. Should this happen, consult an Authorized Mazda Dealer as soon as possible.

#### NOTE

*When the engine is jump-started to charge the battery, uneven rpm occurs and the ABS warning light may illuminate. If this occurs, it is the result of the weak battery and does not indicate an ABS malfunction. Recharge the battery.*

### ▼ If the brake system warning light and the ABS warning light illuminate simultaneously

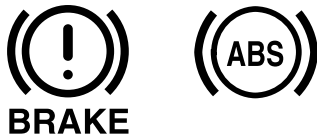

If the electronic brake force distribution control unit determines that some components are operating incorrectly, the control unit may illuminate the brake system warning light and the ABS warning light on simultaneously. The problem is likely to be the electronic brake force distribution system.

### ⚠ WARNING

**Do not drive with both the ABS warning light and brake warning light illuminated. Have the vehicle towed to an Authorized Mazda Dealer to have the brakes inspected as soon as possible:**

*Driving when the brake system warning light and ABS warning light are illuminated simultaneously is dangerous.*

*When both lights are illuminated, the rear wheels could lock more quickly in an emergency stop than under normal circumstances.*

### ▼ If the charging system warning light illuminates



If the warning light illuminates while driving, it indicates a malfunction of the alternator or of the charging system. Drive to the side of the road and park off the right-of-way. Consult an Authorized Mazda Dealer.

### ⚠ CAUTION

**Do not continue driving when the charging system warning light is illuminated because the engine could stop unexpectedly.**

If Trouble Arises

## Warning/Indicator Lights and Warning Sounds

### ▼ If the engine oil pressure warning light illuminates



This warning light indicates low engine oil pressure.

If the light illuminates while driving:

1. Drive to the side of the road and park off the right-of-way on level ground.
2. Turn off the engine and wait 5 minutes for the oil to drain back into the oil pan.
3. Inspect the engine oil level (page 6-21). If it's low, add the appropriate amount of engine oil while being careful not to overfill.
4. Start the engine and check the warning light.

If the light remains illuminated even after you add oil, stop the engine immediately and have your vehicle towed to an Authorized Mazda Dealer.

#### CAUTION

*Do not run the engine if the oil pressure is low. It could result in extensive engine damage.*

### ▼ If the check engine light illuminates or flashes



If this light illuminates while driving, the vehicle may have a problem. It is important to note the driving conditions when the light illuminated and consult an Authorized Mazda Dealer.

The check engine light may illuminate in the following cases:

- The fuel tank level being very low or approaching empty.
- The engine's electrical system has a problem.
- The emission control system has a problem.
- **(U.S.A. and Canada)**  
The fuel-filler cap is missing or not tightened securely.

If the check engine light remains on or flashes continuously, do not drive at high speeds and consult an Authorized Mazda Dealer as soon as possible.

If Trouble Arises

## Warning/Indicator Lights and Warning Sounds

### ▼ If the high engine coolant temperature warning light (red) illuminates or flashes



The light flashes when the engine coolant temperature is extremely high, and illuminates when the engine coolant temperature increases further.

#### **Handling Procedure**

##### **Flashing light**

Drive slowly to reduce engine load until you can find a safe place to stop the vehicle and wait for the engine to cool down.

##### **Illuminated light**

This indicates the possibility of overheating. Park the vehicle in a safe place immediately and stop the engine. Refer to Overheating (page 7-18).

#### **CAUTION**

*Do not drive the vehicle with the high engine coolant temperature warning light illuminated. Otherwise, it could result in damage to the engine.*

### ▼ If the AWD warning light illuminates or flashes

# 4WD

The warning light will illuminate or flash under the following conditions:

- Illuminates when there is an abnormality with the AWD system.
- Illuminates if there is too much difference in tire radius between the front and rear wheels.
- Flashes when the differential oil temperature is abnormally high.
- Flashes when there are continually large differences between front and rear wheel rotation, such as when trying to pull away from an icy surface, or when trying to extricate the vehicle from mud, sand or similar conditions.

#### **When illuminated**

If the AWD warning light illuminates, contact an Authorized Mazda Dealer.

#### **When flashing**

Park the vehicle in a safe place. After a few moments, if the warning light stops flashing, you can resume driving. If the light does not stop flashing, contact an Authorized Mazda Dealer.

If Trouble Arises

## Warning/Indicator Lights and Warning Sounds

### ▼ If the automatic transaxle warning light illuminates

# AT

The light illuminates when the transaxle has a problem.

#### CAUTION

*If the automatic transaxle warning light illuminates, the transaxle has an electrical problem. Continuing to drive your Mazda in this condition could cause damage to your transaxle. Consult an Authorized Mazda Dealer as soon as possible.*

### ▼ If the power steering malfunction indicator light illuminates



The power steering malfunction indicator light illuminates if there is a malfunction with the power steering while the engine is running.

If the indicator light illuminates, park the vehicle in a safe place immediately and stop the engine.

If the indicator light does not turn off even if the engine is restarted afterwards, consult an Authorized Mazda Dealer.

#### NOTE

- *If the indicator light illuminates, the power steering will not operate normally. If this happens, the steering wheel can still be operated, however, the operation may feel heavy compared to normal, and the steering wheel could vibrate when turning.*
- *Repeatedly jerking the steering wheel left and right while the vehicle is stopped or moving extremely slowly will cause the power steering system to go into protective mode which will make the steering feel heavy, but this does not indicate a problem. If this occurs, park the vehicle safely and wait a few seconds for the system to return to normal.*

### ▼ If the air bag/front seat belt pretensioner system warning light illuminates or flashes



A system malfunction is indicated if the warning light constantly flashes, constantly illuminates or does not illuminate at all when the ignition is switched ON. If any of these occur, consult an Authorized Mazda Dealer as soon as possible. The system may not operate in an accident.



If Trouble Arises

## Warning/Indicator Lights and Warning Sounds

### **⚠ WARNING**

**Never tamper with the air bag/pretensioner systems and always have an Authorized Mazda Dealer perform all servicing and repairs:**

*Self-servicing or tampering with the systems is dangerous. An air bag/pretensioner could accidentally activate or become disabled causing serious injury or death.*

#### ▼ If the tire pressure monitoring system warning light flashes



If the tire pressure monitoring system has a malfunction, the tire pressure warning light flashes for about 1 minute when the ignition is switched ON and then continues illuminating. Have your vehicle checked by an Authorized Mazda Dealer as soon as possible.

#### ▼ If the KEY warning light (red) illuminates



If any malfunction occurs in the keyless entry system, it illuminates continuously.

### **⚠ CAUTION**

*If the key warning indicator light illuminates or the push button start indicator light (amber) flashes, the engine may not start. If the engine cannot be started, try starting it using the emergency operation for starting the engine, and have the vehicle inspected at an Authorized Mazda Dealer as soon as possible.*

#### ▼ If the traction control system (TCS)/dynamic stability control (DSC) indicator light illuminates



If the light stays on, the TCS, DSC or the brake assist system may have a malfunction and they may not operate correctly. Take your vehicle to an Authorized Mazda Dealer.

#### **NOTE**

- *In addition to the indicator light flashing, a slight lugging sound will come from the engine. This indicates that the TCS/DSC is operating properly.*
- *On slippery surfaces, such as fresh snow, it will be impossible to achieve high rpm when the TCS is on.*

If Trouble Arises

## Warning/Indicator Lights and Warning Sounds

- ▼ If the traction control system (TCS) OFF indicator light illuminates

**TCS  
OFF**

If the light remains illuminated and the TCS is not switched off, take your vehicle to an Authorized Mazda Dealer. The DSC may have a malfunction.

- ▼ If the adaptive front lighting system (AFS) OFF indicator light flashes \*

**AFS  
OFF**

The indicator light flashes continuously if the system is malfunctioning. Consult an Authorized Mazda Dealer.

### NOTE

- Even if the AFS is not operating due to some malfunction, the normal headlight function is still operable.
- If there is a malfunction with the headlight auto-leveling function, the indicator light flashes.

- ▼ If the low engine coolant temperature indicator light (blue) does not turn off



If the low engine coolant temperature indicator light remains illuminated after the engine has been sufficiently warmed up, the temperature sensor could have a malfunction. Consult an Authorized Mazda Dealer.

- ▼ If the turn signal/hazard warning indicator light illuminates or flashes at an abnormally high speed



If an indicator light remains illuminated (does not flash) or if it flashes abnormally, one of the turn signal bulbs may be burned out. Consult an Authorized Mazda Dealer.

If Trouble Arises

## Warning/Indicator Lights and Warning Sounds

### ▼ If the security indicator light illuminates or flashes



If the engine does not start with the correct key, and the security indicator light keeps illuminating or flashing, the system may have a malfunction. Consult an Authorized Mazda Dealer.

### ▼ If the blind spot monitoring (BSM) system OFF indicator light flashes\*

**BSM  
OFF**

The indicator light flashes if the BSM system has a malfunction. Consult an Authorized Mazda Dealer.

#### **NOTE**

*If the vehicle is driven on a road with less traffic and few vehicles that the radar sensors can detect, the system may pause (The BSM OFF indicator light in the instrument panel flashes). However, it does not indicate a malfunction.*

### ▼ If the lights-on indicator light flashes



The light continues to flash if the lighting system has a malfunction. Consult an Authorized Mazda Dealer.

\*Some models. **7-31**

If Trouble Arises

## Warning/Indicator Lights and Warning Sounds

### Warning Sound is Activated

#### ▼ Lights-On Reminder

If lights are on and the ignition is switched to ACC or the ignition is switched off, a continuous beep sound will be heard when the driver's door is opened.

#### NOTE

- When the ignition is switched to ACC, the "Ignition Not Switched Off (STOP) Warning Beep" (page 7-33) overrides the lights-on reminder.
- A personalized function is available to change the sound volume for the lights-on reminder. Refer to Personalization Features on page 9-8.

#### ▼ Air Bag/Front Seat Belt Pretensioner System Warning Beep

If a malfunction is detected in the air bag/front seat belt pretensioner systems and the warning light, a warning beep sound will be heard for about 5 seconds every minute.

The air bag and seat belt pretensioner system warning beep sound will continue to be heard for approximately 35 minutes. Have your vehicle inspected at an Authorized Mazda Dealer as soon as possible.

### WARNING

**Do not drive the vehicle with the air bag/front seat belt pretensioner system warning beep sounding:**

*Driving the vehicle with the air bag/front seat belt pretensioner system warning beep sounding is dangerous. In a collision, the air bags and the front seat belt pretensioner system will not deploy and this could result in death or serious injury.*

**Contact an Authorized Mazda Dealer to have the vehicle inspected as soon as possible.**

#### ▼ Seat Belt Warning Beep

If the driver's seat belt is not fastened when the ignition is switched ON, a beep sound will be heard for about 6 seconds. If the driver or the front passenger's seat belt is not fastened and the vehicle is driven at a speed faster than about 20 km/h (12 mph), a beep sound will be heard again for a specified period of time.

#### NOTE

- Some models do not have the seat belt warning function for the front passenger's seat.
- Placing heavy items on the front passenger seat may cause the front passenger seat belt warning function to operate depending on the weight of the item.
- To allow the front passenger seat weight sensor to function properly, do not place and sit on an additional seat cushion on the front passenger seat. The sensor may not function properly because the additional seat cushion could cause sensor interference.
- When a small child sits on the front passenger seat, it is possible that the warning beep will not operate.

If Trouble Arises

## Warning/Indicator Lights and Warning Sounds

### ▼ Ignition Not Switched Off (STOP) Warning Beep

If the driver's door is opened while the ignition is switched to ACC, a continuous beep sound will be heard and the KEY warning light (red) flashes to notify the driver that the ignition has not been switched off (STOP). Left in this condition, the keyless entry system will not operate, the car cannot be locked, and the battery power will be depleted.

### ▼ Key Removed from Vehicle Warning Beep

Under the following conditions, a beep sound will be heard and the KEY warning light (red) will flash continuously when the ignition has not been switched off to notify the driver that the key has been removed. The KEY warning light (red) will stop flashing when the key is back inside the vehicle:

The ignition has not been switched off and all the doors are closed after removing the key from the vehicle. (A beep sound will be heard 6 times.)

#### **NOTE**

*Because the key utilizes low-intensity radio waves, the Key Removed From Vehicle Warning may activate if the key is carried together with a metal object or it is placed in a poor signal reception area.*

### ▼ Request Switch Inoperable Warning Beep (With the advanced keyless function)

If the request switch is pressed under the following conditions while the key is being carried, a beep will be heard for about 2 seconds to indicate that the front doors and the liftgate can not be locked.

- A door or the liftgate is open (door ajar included).
- The ignition has not been switched to off.

### ▼ Key Left-in-luggage Compartment Warning Beep (With the advanced keyless function)

If the key is left in the luggage compartment with all doors locked and the liftgate closed, a beep sound is heard for about 10 seconds to remind the driver the key has been left in the luggage compartment. If this happens, open the liftgate by pressing the electric liftgate opener and remove the key. A key removed from the luggage compartment may not function because its functions may have been temporarily suspended. To restore the key function, perform the applicable procedure (page 3-7).

If Trouble Arises

## Warning/Indicator Lights and Warning Sounds

---

### ▼ Key Left-in-vehicle Warning Beep (With the advanced keyless function)

When any door is opened from the outside while the key is inside the vehicle, the closed doors are locked and all the doors are automatically unlocked by closing the open door. The beep sound is heard for about 10 seconds to notify the driver that the key has been left in the vehicle.

If this happens, the doors and the liftgate lock but the functions of the key left in the vehicle cabin may be temporarily suspended.

Perform the following procedure to restore the functions of the key (page 3-7).

### ▼ Tire Inflation Pressure Warning Beep

The warning beep sound will be heard for about 3 seconds when there is any abnormality in tire inflation pressures (page 4-70).

### ▼ Blind Spot Monitoring (BSM) System Warning Beep\*

The warning beep operates when the turn signal lever is operated to the side where the BSM warning light is illuminated.

#### **NOTE**

*A personalized function is available to change the BSM warning beep sound volume. Refer to Personalization Features on page 9-8.*

If Trouble Arises  
**When Liftgate Cannot be Opened**

**When Liftgate Cannot be Opened**

If the vehicle battery is dead or there is a malfunction in the electrical system and the liftgate can not be opened, perform the following procedure as an emergency measure to Open it:

1. Remove the cap on the interior surface of the liftgate with a flathead screwdriver.

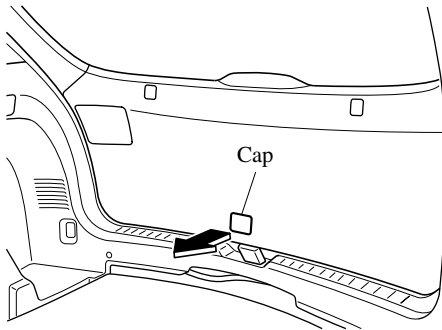

2. Turn the lever to the right to unlock the liftgate.

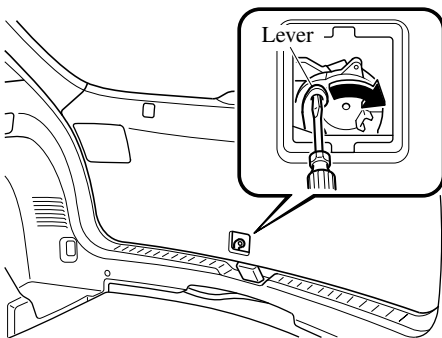

After performing this emergency measure, have the vehicle inspected at an Authorized Mazda Dealer as soon as possible.

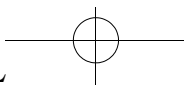
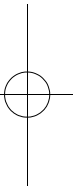
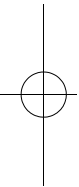
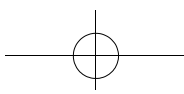



# 8

## Customer Information and Reporting Safety Defects

Important consumer information including warranties and add-on equipment.

<b>Customer Assistance .....</b>	<b>8-2</b>	<b>Tire Information (U.S.A.) .....</b>	<b>8-25</b>
Customer Assistance (U.S.A.) .....	8-2	Tire Labeling .....	8-25
Customer Assistance (Canada) .....	8-7	Location of the Tire Label (Placard) .....	8-31
Customer Assistance (Puerto Rico) ...	8-10	Tire Maintenance .....	8-34
Customer Assistance (Mexico) .....	8-11	Vehicle Loading .....	8-37
 		Steps for Determining the Correct Load Limit: .....	8-43
<b>Mazda Importer/Distributors .....</b>	<b>8-13</b>	 	
Importer/Distributor .....	8-13	<b>Declaration of Conformity .....</b>	<b>8-44</b>
Distributor in Each Area .....	8-13	Declaration of Conformity .....	8-44
<b>Reporting Safety Defects .....</b>	<b>8-15</b>	<b>Service Publications .....</b>	<b>8-49</b>
Reporting Safety Defects (U.S.A.) ....	8-15	Service Publications .....	8-49
Reporting Safety Defects (Canada) ...	8-16		
<b>Warranty .....</b>	<b>8-17</b>		
Warranties for Your Mazda .....	8-17		
Outside the United States/Canada ....	8-18		
Registering Your Vehicle in A Foreign Country (Except United States and Canada) .....	8-19		
Add-On Non-Genuine Parts and Accessories .....	8-20		
<b>Cell Phones .....</b>	<b>8-21</b>		
Cell Phones Warning .....	8-21		
<b>Event Data Recorder .....</b>	<b>8-22</b>		
Event Data Recorder .....	8-22		
<b>Uniform Tire Quality Grading System (UTQGS) .....</b>	<b>8-23</b>		
Uniform Tire Quality Grading System (UTQGS) .....	8-23		

Customer Information and Reporting Safety Defects

## Customer Assistance

### Customer Assistance (U.S.A.)

Your complete and permanent satisfaction is our business. We are here to serve you. All Authorized Mazda Dealers have the knowledge and the tools to keep your Mazda vehicle in top condition.

If you have any questions or recommendations for improvement regarding the service of your Mazda vehicle or servicing by Mazda Dealer personnel, we recommend that you take the following steps:

#### **NOTE**

*If it becomes necessary to have the components or wiring system for the supplementary restraint system modified to accommodate a person with certain medical conditions in accordance with a certified physician, contact an Authorized Mazda Dealer.*

#### **▼STEP 1: Contact Your Mazda Dealer**

Discuss the matter with an Authorized Mazda Dealer. This is the quickest and best way to address the issue.

- If your concern has not been resolved by the CUSTOMER RELATIONS, SALES, SERVICE, or PARTS MANAGER, then please contact the GENERAL MANAGER of the dealership or the OWNER.
- If it becomes necessary to have the components or wiring system for the supplementary restraint system modified to accommodate a person with certain medical conditions in accordance with a certified physician, go to STEP 2.

#### **▼STEP 2: Contact Mazda North American Operations**

If for any reason you feel the need for further assistance after contacting your dealership management or it becomes necessary to have the components or wiring system for the supplementary restraint system modified to accommodate a person with certain medical conditions in accordance with a certified physician, you can reach Mazda North American Operations by one of the following ways.

Log on: at [www.mazdaUSA.com](http://www.mazdaUSA.com)

Answers to many questions, including how to locate or contact a local Mazda dealership in the U.S., can be found here.

E-mail: click on “Contact Us” located on the “Inside Mazda” tab, or at the bottom of the page at [www.mazdaUSA.com](http://www.mazdaUSA.com)

By phone at: 1 (800) 222-5500



Customer Information and Reporting Safety Defects

## Customer Assistance

---

By letter at:

Attn: Customer Assistance  
Mazda North American Operations  
7755 Irvine Center Drive  
Irvine, CA 92618-2922  
P.O. Box 19734  
Irvine, CA 92623-9734

In order to serve you efficiently and effectively, please help us by providing the following information:

1. Your name, address, and telephone number
2. Year and model of vehicle
3. Vehicle Identification Number (17 digits, noted on your registration or title or located on the upper driver's side corner of the dash)
4. Purchase date and current mileage
5. Your dealer's name and location
6. Your question(s)

If you live outside the U.S.A., please contact your nearest Mazda Distributor.

### ▼STEP 3: Contact Better Business Bureau (BBB)

Mazda North American Operations realizes that mutual agreement on some issues may not be possible. As a final step to ensure that your concerns are being fairly considered, Mazda North American Operations has agreed to participate in a dispute settlement program administered by the Better Business Bureau (BBB) system, at no cost to you the consumer.

BBB AUTO LINE works with consumers and the manufacturer in an attempt to reach a mutually acceptable resolution of any warranty related concerns. If the BBB is not able to facilitate a settlement they will provide an informal hearing before an arbitrator.

You are required to resort to BBB AUTO LINE before exercising rights or seeking remedies under the Federal Magnuson-Moss Warranty Act, 15 U.S.C. § 2301 et seq. To the extent permitted by the applicable state "Lemon Law", you are also required to resort to BBB AUTO LINE before exercising any rights or seeking remedies under the "Lemon Law". If you choose to seek remedies that are not created by the Magnuson-Moss Warranty Act or the applicable state "Lemon Law", you are not required to first use BBB AUTO LINE.

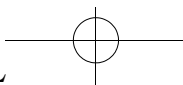

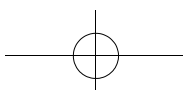

Customer Information and Reporting Safety Defects

## Customer Assistance

---

The whole process normally takes 40 days or less. The arbitration decision is not binding on you or Mazda unless you accept the decision. For more information about BBB AUTO LINE, including current eligibility standards, please call 1-800-955-5100 or visit the BBB website at [www.lemonlaw.bbb.org](http://www.lemonlaw.bbb.org).

Being truly committed to customer satisfaction is more than a phrase with Mazda. We hope to satisfy every customer directly, but if there is ever a question about our decision, Mazda believes in providing a fast, fair and free method such as the BBB AUTO LINE to ensure Mazda delivers on our commitment to do the right thing for our customers!

### ▼ California Customers

1. Mazda North American Operations participates in BBB AUTO LINE, a mediation/arbitration program administered by the Council of Better Business Bureaus [4200 Wilson Boulevard, Arlington, Virginia 22203] through local Better Business Bureaus. BBB AUTO LINE and Mazda have been certified by the Arbitration Certification Program of the California Department of Consumer Affairs.
2. If you have a problem arising under a Mazda written warranty, we encourage you to bring it to our attention. If we are unable to resolve it, you may file a claim with BBB AUTO LINE. Claims must be filed with BBB AUTO LINE within six (6) months after the expiration of the warranty.
3. To file a claim with BBB AUTO LINE, call 1-800-955-5100. There is no charge for the call.
4. In order to file a claim with BBB AUTO LINE, you will have to provide your name and address, the brand name and vehicle identification number (VIN) of your vehicle, and a statement of the nature of your problem or complaint. You will also be asked to provide: the approximate date of your acquisition of the vehicle, the vehicle's current mileage, the approximate date and mileage at the time any problem(s) were first brought to the attention of Mazda or one of our dealers, and a statement of the relief you are seeking.
5. BBB AUTO LINE staff may try to help resolve your dispute through mediation. If mediation is not successful, or if you do not wish to participate in mediation, claims within the program's jurisdiction may be presented to an arbitrator at an informal hearing. The arbitrator's decision should ordinarily be issued within 40 days from the time your complaint is filed; there may be a delay of 7 days if you did not first contact Mazda about your problem, or a delay of up to 30 days if the arbitrator requests an inspection/report by an impartial technical expert or further investigation and report by BBB AUTO LINE.

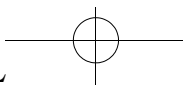

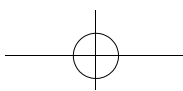

## Customer Assistance

6. You are required to use BBB AUTO LINE before asserting in court any rights or remedies conferred by California Civil Code Section 1793.22. You are also required to use BBB AUTO LINE before exercising rights or seeking remedies created by Title I of the Magnuson-Moss Warranty Act, 15 U.S.C. sec. 2301 et seq. If you choose to seek redress by pursuing rights and remedies not created by California Civil Code Section 1793.22 or Title I of the Magnuson-Moss Warranty Act, resort to BBB AUTO LINE is not required by those statutes.
7. California Civil Code Section 1793.2 (d) requires that, if Mazda or its representative is unable to repair a new motor vehicle to conform to the vehicle's applicable express warranty after a reasonable number of attempts, Mazda may be required to replace or repurchase the vehicle. California Civil Code Section 1793.22 (b) creates a presumption that Mazda has had a reasonable number of attempts to conform the vehicle to its applicable express warranties if, within 18 months from delivery to the buyer or 18,000 miles on the vehicle's odometer, whichever occurs first, one or more of the following occurs:
  - The same nonconformity [a failure to conform to the written warranty that substantially impairs the use, value or safety of the vehicle] results in a condition that is likely to cause death or serious bodily injury if the vehicle is driven **AND** the nonconformity has been subject to repair two or more times by Mazda or its agents **AND** the buyer or lessee has directly notified Mazda of the need for the repair of the nonconformity; OR
  - The same nonconformity has been subject to repair 4 or more times by Mazda or its agents **AND** the buyer has notified Mazda of the need for the repair of the nonconformity; OR
  - The vehicle is out of service by reason of repair of nonconformities by Mazda or its agents for a cumulative total of more than 30 calendar days after delivery of the vehicle to the buyer.

**NOTICE TO Mazda AS REQUIRED ABOVE SHALL BE SENT TO THE FOLLOWING ADDRESS:**

Mazda North American Operations  
7755 Irvine Center Drive  
Irvine, CA 92618  
ATTN: Customer Mediation

8. The following remedies may be sought in BBB AUTO LINE: repairs, reimbursement for money paid to repair a vehicle or other expenses incurred as result of a vehicle nonconformity, repurchase or replacement of your vehicle, and compensation for damages and remedies available under Mazda's written warranty or applicable law.
9. The following remedies may **not** be sought in BBB AUTO LINE: punitive or multiple damages, attorneys' fees, or consequential damages other than as provided in California Civil Code Section 1794 (a) and (b).

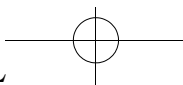



Customer Information and Reporting Safety Defects

## Customer Assistance

---

10. You may reject the decision issued by a BBB AUTO LINE arbitrator. If you reject the decision, you will be free to pursue further legal action. The arbitrator's decision and any findings will be admissible in a court action.
11. If you accept the arbitrator's decision, Mazda will be bound by the decision, and will comply with the decision within a reasonable time not to exceed 30 days after we receive notice of your acceptance of the decision.
12. Please call BBB AUTO LINE at 1-800-955-5100 for further details about the program.

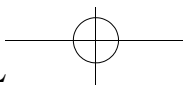

## Customer Assistance

### Customer Assistance (Canada)

#### ▼ Satisfaction Review Process

Your complete and permanent satisfaction is of primary concern to Mazda. All Authorized Mazda Dealers have both the knowledge and tools to keep your Mazda in top condition. In our experience, any questions, problems, or complaints regarding the operation of your Mazda or any other general service transactions are most effectively resolved by your dealer. If the cause of your dissatisfaction cannot adequately be addressed by normal dealership procedures, we recommend that you take the following steps:

#### ▼ STEP 1: Contact the Mazda Dealer

Discuss the matter with a member of dealership management. If the Service Manager has already reviewed your concerns, contact the owner of the dealership or its General Manager.

#### ▼ STEP 2: Contact the Mazda Regional Office

If you feel that you still require assistance, ask the dealer Service Manager to arrange for you to meet the local Mazda Service Representative. If more expedient, contact Mazda Canada Inc. Regional Office nearest you for such arrangements. Regional Office address and phone numbers are shown (page 8-9).

#### ▼ STEP 3: Contact the Mazda Customer Relations Department

If still not substantially satisfied, contact the Customer Relations Department, Mazda Canada Inc., 55 Vogell Road, Richmond Hill, Ontario, L4B 3K5 Canada TEL:1 (800) 263-4680.

Provide the Department with the following information:

1. Your name, address and telephone number
2. Year and model of vehicle
3. Vehicle Identification Number (VIN). Refer to the "Vehicle Identification Labels" page of section 9 of this manual for the location of the VIN.
4. Purchase date
5. Present odometer reading
6. Your dealer's name and location
7. The nature of your problem and/or cause of dissatisfaction

The Department, in cooperation with the local Mazda Service Representative, will review the case to determine if everything possible has been done to ensure your satisfaction.

Customer Information and Reporting Safety Defects

## Customer Assistance

---

Please recognize that the resolution of service problems in most cases requires the use of your Mazda dealer's service facilities, personnel and equipment. We urge you to follow the above three steps in sequence for most effective results.

### ▼ Mediation/Arbitration Program

Occasionally a customer concern cannot be resolved through Mazda's Customer Satisfaction Program. If after exhausting the procedures in this manual your concern is still not resolved, you have another option.

Mazda Canada Inc. participates in an arbitration program administered by the Canadian Motor Vehicle Arbitration Plan (CAMVAP). CAMVAP will advise you about how your concern may be reviewed and resolved by an independent third party through binding arbitration.

Your complete satisfaction is the goal of Mazda Canada Inc. and our dealers. Mazda's participation in CAMVAP makes a valuable contribution to our achieving that goal. There is no charge for using CAMVAP. CAMVAP results are fast, fair and final as the award is binding on both you and Mazda Canada Inc.

### ▼ Canadian Motor Vehicle Arbitration Plan (CAMVAP)

If a specific item of concern arises, where a solution cannot be reached between an owner, Mazda, and/or one of its dealers (that all parties cannot agree upon), the owner may wish to use the services offered by the Canadian Motor Vehicle Arbitration Plan (CAMVAP).

CAMVAP uses the services of Provincial Administrators to assist consumers in scheduling and preparing for their arbitration hearings. However, before you can proceed with CAMVAP you must follow your Mazda dispute resolution process as outlined previously.



Customer Information and Reporting Safety Defects

**Customer Assistance**

CAMVAP is fully implemented in all provinces and territories. Consumers wishing to obtain further information about the Program should contact the Provincial Administrator at 1 (800) 207-0685, or by contacting the Canadian Motor Vehicle Arbitration Plan Office at:

Canadian Motor Vehicle Arbitration Plan  
 235 Yorkland Boulevard, suite 300  
 North York, Ontario  
 M2J 4Y8  
<http://camvap.ca>

Provincial Administrators may be reached locally as listed below:

Province/Territory	CAMVAP Number
British Columbia & Yukon Territories	1 (800) 207-0685
Alberta & Northwest Territories	1 (800) 207-0685
Saskatchewan	1 (800) 207-0685
Manitoba	1 (800) 207-0685
Ontario	1 (800) 207-0685
Atlantic Canada	1 (800) 207-0685
Quebec	1 (800) 207-0685

▼ **Regional Offices**

REGIONAL OFFICES	AREAS COVERED
MAZDA CANADA INC. WESTERN REGION 8171 ACKROYD ROAD SUITE 2000 RICHMOND B.C. V6X 3K1 (604) 303-5670	ALBERTA, BRITISH COLUMBIA, MANITOBA, SASKATCHEWAN, YUKON
MAZDA CANADA INC. CENTRAL/ATLANTIC REGION 55 VOGELL ROAD, RICHMOND HILL, ONTARIO, L4B 3K5 (905) 787-7000	ONTARIO
MAZDA CANADA INC. QUEBEC REGION 6111 ROUTE TRANS CANADIENNE POINTE CLAIRE, QUEBEC H9R 5A5 (514) 694-6390	QUEBEC, NEW BRUNSWICK, NOVA SCOTIA, PRINCE EDWARD ISLAND, NEWFOUNDLAND

Customer Information and Reporting Safety Defects

## Customer Assistance

---

### Customer Assistance (Puerto Rico)

Your complete and permanent satisfaction is our business. That is why all Authorized Mazda Dealers have the knowledge and the tools to keep your Mazda vehicle in top condition.

If you have any questions or recommendations for improvement regarding the service of your Mazda vehicle or servicing by Mazda Dealer personnel, we recommend that you take the following steps:

#### ▼STEP 1

Discuss the matter with an Authorized Mazda Dealer. This is the quickest and best way to address the issue. If your concern has not been resolved by the CUSTOMER RELATIONS, SALES, SERVICE, or PARTS MANAGER, then please contact the GENERAL MANAGER of the dealership or the OWNER.

#### ▼STEP 2

If, after following STEP 1, you feel the need for further assistance, please contact your area's Mazda representative (Indicated on the next page).

Please help us by providing the following information:

1. Your name, address, and telephone number
2. Year and model of vehicle
3. Vehicle Identification Number (17 digits, noted on your registration or title or located on the upper driver's side corner of the dash)
4. Purchase date and current mileage
5. Your dealer's name and location
6. Your question(s)

8-10

## Customer Assistance

### Customer Assistance (Mexico)

Your complete and permanent satisfaction is our business. We are here to serve you. All Authorized Mazda Dealers have the knowledge and the tools to keep your Mazda vehicle in top condition.

If you have any questions or recommendations for improvement regarding the service of your Mazda vehicle or servicing by Mazda Dealer personnel, we recommend that you take the following steps:

#### ▼ Contact Your Mazda Dealer

Discuss the matter with an Authorized Mazda Dealer. This is the quickest and best way to address the issue.

- If your concern has not been resolved by the CUSTOMER RELATIONS, SALES, SERVICE, or PARTS MANAGER, then please contact the GENERAL MANAGER of the dealership or the OWNER.
- If it becomes necessary to have the components or wiring system for the supplementary restraint system modified to accommodate a person with certain medical condition in accordance with a certified physician you must contact your dealership in order to avoid the potential loss of the warranty of your vehicle which may occur if some third party is hired by the customer to make any modifications to this system.

Log on: at [www.MazdaMexico.com.mx](http://www.MazdaMexico.com.mx)

Answers to many questions, including how to locate or contact a local Mazda dealership in Mexico, can be found here.

E-mail: click on “Contactanos” at the top of the page at [www.MazdaMexico.com.mx](http://www.MazdaMexico.com.mx)

By phone at: 01 800 01 MAZDA (62932)

By letter at:

Attn: Customer Assistance  
Mazda Motor de Mexico  
Mario Pani #150, PB Col. Lomas de Santa Fe  
Mexico, D.F. C.P. 05300  
Del. Cuajimalpa de Morelos  
Tel: Customer Assistance  
01 800 01 MAZDA (62932).

In order to serve you efficiently and effectively, please help us by providing the following information:

1. Your name, address, and telephone number



Customer Information and Reporting Safety Defects

## Customer Assistance

---

2. Year and model of vehicle
3. Vehicle Identification Number (17 digits, noted on your registration or title or located on the upper driver's side corner of the dash)
4. Purchase date and current mileage
5. Your dealer's name and location
6. Your question(s)

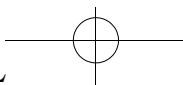

Customer Information and Reporting Safety Defects  
**Mazda Importer/Distributors**

**Importer/Distributor**

▼ **U.S.A.**

**Mazda North American Operations**

7755 Irvine Center Drive  
Irvine, CA 92618-2922 U.S.A.  
P.O. Box 19734  
Irvine, CA 92623-9734 U.S.A.  
TEL:1 (800) 222-5500 (in U.S.A.)  
(949) 727-1990 (outside U.S.A.)

**Distributor in Each Area**

▼ **CANADA**

**Mazda Canada Inc.**

55 Vogell Road, Richmond Hill,  
Ontario, L4B 3K5 Canada  
TEL:1 (800) 263-4680 (in Canada)  
(905) 787-7000 (outside Canada)

▼ **PUERTO RICO/U.S. Virgin Island**

**Plaza Motors Corp. (Mazda de Puerto Rico)**

P.O. Box 362722, San Juan, Puerto Rico  
00936-2722  
TEL: (787) 641-9300

▼ **MEXICO**

**Mazda Motor de Mexico**

Mario Pani # 150, PB Col. Lomas de  
Santa Fe Mexico, D.F. C.P. 05300 Del.  
Cuajimalpa  
TEL: Center of Attention to Clients:  
01 (800) 016 2932. in Mexico

▼ **GUAM**

**Triple J Motors**

157 South Marine Drive, Tamuning,  
GUAM 96911 USA  
P.O. Box 6066 Tamuning, Guam 96931  
TEL: (671) 649-6555

▼ **SAIPAN**

**Pacific International Marianas, Inc.  
(d.b.a. Midway Motors)**

P.O. Box 887 Saipan, MP 96950  
TEL: (670) 234-7524



Customer Information and Reporting Safety Defects

## **Mazda Importer/Distributors**

---

**Triple J Saipan, Inc.**  
**(d.b.a. Triple J Motors)**  
P.O. Box 500487 Saipan, MP 96950-0487  
TEL: (670) 234-7133/3051

### **▼ AMERICAN SAMOA**

**Polynesia Motors, Inc.**  
P.O. Box 1120, Pago Pago, American  
Samoa 96799  
TEL: (684) 699-9347

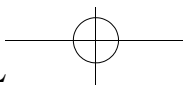

Customer Information and Reporting Safety Defects  
**Reporting Safety Defects**

**Reporting Safety Defects (U.S.A.)**

If you believe that your vehicle has a defect which could cause a crash or could cause injury or death, you should immediately inform the National Highway Traffic Safety Administration (NHTSA) in addition to notifying Mazda Motor Corporation (Your Mazda Importer/Distributor).

If NHTSA receives similar complaints, it may open an investigation, and if it finds that a safety defect exists in a group of vehicles, it may order a recall and remedy campaign. However, NHTSA cannot become involved in individual problems between you, your dealer, or Mazda Motor Corporation (Your Mazda Importer/Distributor).

To contact NHTSA, you may call the Vehicle Safety Hotline toll-free at 1-888-327-4236 (TTY:1-800-424-9153) ; go to <http://www.safercar.gov>; or write to: Administrator, NHTSA, 1200 New Jersey Avenue, SE., Washington, DC, 20590. You can also obtain other information about motor vehicle safety from <http://www.safercar.gov>.

**NOTE**

*If you live in the U.S.A., all correspondence to Mazda Motor Corporation should be forwarded to:*

*Mazda North American Operations  
7755 Irvine Center Drive  
Irvine, California 92618-2922*

*or*

*P.O. Box 19734*

*Irvine, CA 92623-9734*

*Customer Assistance Center or toll free at 1 (800) 222-5500*

*If you live outside of the U.S.A., please contact the nearest Mazda Distributor shown (page 8-13) in this booklet.*



Customer Information and Reporting Safety Defects

## Reporting Safety Defects

---

### Reporting Safety Defects (Canada)

Canadian customers who wish to report a safety-related defect to Transport Canada, Defect Investigations and Recalls, may telephone the toll free hotline 1-800-333-0510, or contact Transport Canada by mail at: Transport Canada, ASFAD, Place de Ville Tower C, 330 Sparks Street, Ottawa ON K1A 0N5.

For additional road safety information, please visit the Road Safety website at:  
<http://www.tc.gc.ca/roadsafety/menu.htm>

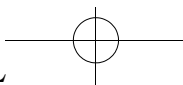



Customer Information and Reporting Safety Defects

## Warranty

### Warranties for Your Mazda

- New Vehicle Limited Warranty
- Powertrain Limited Warranty
- Safety Restraint System Limited Warranty
- Anti-perforation Limited Warranty
- Federal Emission Control Warranty/California Emission Control Warranty
  - Emission Defect Warranty
  - Emission Performance Warranty
- Emission Control Warranty
- Replacement Parts and Accessories Limited Warranty
- Tire Warranty

**NOTE**

*Warranty information varies depending on the country. Refer to the Warranty Booklet for detailed warranty information.*

Customer Information and Reporting Safety Defects

## Warranty

### Outside the United States/Canada

Government regulations in the United States/Canada require that automobiles meet specific emission regulations and safety standards. Therefore, vehicles built for use in the United States/Canada may differ from those sold in other countries.

The differences may make it difficult or even impossible for your vehicle to receive satisfactory servicing in other countries. We strongly recommend that you NOT take your Mazda outside the United States/Canada.

#### United States

However, in the event that you are moving to Canada permanently, Mazda vehicles built for use in the United States could be eligible for exportation to Canada with specific vehicle modifications to comply with the Canadian Motor Vehicle Safety Standards (CMVSS).

#### Canada

However, in the event that you are moving to the United States permanently, Mazda vehicles built for use in Canada could be eligible for exportation to the United States with specific vehicle modifications to comply with the United States Federal Motor Vehicle Safety Standards (FMVSS).

#### NOTE

*The above is applicable for a permanent import/export situation and not related to travelers on vacation.*

You may have the following problems if you do take your vehicle outside of the United States/Canada:

- Recommended fuel may be unavailable. Any kind of leaded fuel or low-octane fuel will affect vehicle performance and damage the emission controls and engine.
- Proper repair facilities, tools, testing equipment, and replacement parts may not be available.

Please refer to your Manufacturer's Warranty Booklet for more information.

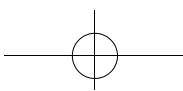

## **Registering Your Vehicle in A Foreign Country (Except United States and Canada)**

Registering your vehicle in a foreign country may be problematic depending on whether it meets the specific emission and safety standards of the country in which the vehicle will be driven. Consequently, your vehicle may require modifications at personal expense in order to meet the regulations.

In addition, you should be aware of the following issues:

Satisfactory vehicle servicing may be difficult or impossible in another country.

The fuel specified for your vehicle may be unavailable.

Parts, servicing techniques, and tools necessary to maintain and repair your vehicle may be unavailable.

There might not be an Authorized Mazda Dealer in the country you plan to take your vehicle.

The Mazda warranty is valid only in certain countries.

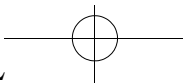
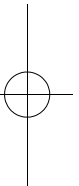
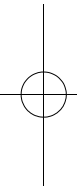

Customer Information and Reporting Safety Defects

## Warranty

### Add-On Non-Genuine Parts and Accessories

Non-genuine parts and accessories for Mazda vehicles can be found in stores. These may fit your vehicle, but they are not approved by Mazda for use with Mazda vehicles. When you install non-genuine parts or accessories, they could affect your vehicle's performance or safety systems; the Mazda warranty doesn't cover this. Before you install any non-genuine parts or accessories, consult an Authorized Mazda Dealer.

#### **WARNING**

***Always consult an Authorized Mazda Dealer before you install non-genuine parts or accessories:***

*Installation of non-genuine parts or accessories is dangerous. Improperly designed parts or accessories could seriously affect your vehicle's performance or safety systems. This could cause you to have an accident or increase your chances of injuries in an accident.*

***Be very careful in choosing and installing add-on electrical equipment, such as mobile telephones, two-way radios, stereo systems, and car alarm systems:***

*Incorrectly choosing or installing improper add-on equipment or choosing an improper installer is dangerous. Essential systems could be damaged, causing engine stalling, air-bag (SRS) activation, ABS/TCS/DSC inactivation, or a fire in the vehicle.*

Mazda assumes no responsibility for death, injury, or expenses that may result from the installation of add-on non-genuine parts or accessories.

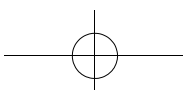

## Cell Phones

### Cell Phones Warning

#### **WARNING**

***Please comply with the legal regulations concerning the use of communication equipment in vehicles in your country:***

*Use of any electrical devices such as cell phones, computers, portable radios, vehicle navigation or other devices by the driver while the vehicle is moving is dangerous. Dialing a number on a cell phone while driving also ties-up the driver's hands. Use of these devices will cause the driver to be distracted and could lead to a serious accident. If a passenger is unable to use the device, pull off the right-of-way to a safe area before use. If use of a cell phone is necessary despite this warning, use a hands-free system to at least leave the hands free to drive the vehicle. Never use a cell phone or other electrical devices while the vehicle is moving and, instead, concentrate on the full-time job of driving.*

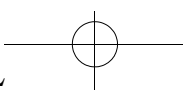
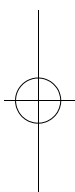
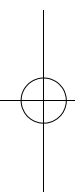



Customer Information and Reporting Safety Defects

## Event Data Recorder

### Event Data Recorder

This vehicle is equipped with an event data recorder (EDR). The main purpose of an EDR is to record, in certain crash or near crash-like situations, such as an air bag deployment or hitting a road obstacle, data that will assist in understanding how a vehicle's systems performed. The EDR is designed to record data related to vehicle dynamics and safety systems for a short period of time, typically 30 seconds or less. The EDR in this vehicle is designed to record such data as:

- How various systems in your vehicle were operating;
- Whether or not the driver and passenger safety belts were buckled/fastened;
- How far (if at all) the driver was depressing the accelerator and/or brake pedal; and,
- How fast the vehicle was traveling.

These data can help provide a better understanding of the circumstances in which crashes and injuries occur.

#### **NOTE**

*EDR data are recorded by your vehicle only if a non-trivial crash or near crash-like situation occurs; no data are recorded by the EDR under normal driving conditions and no personal data (e.g., name, gender, age, and crash location) are recorded. However, other parties, such as law enforcement, could combine the EDR data with the type of personally identifying data routinely acquired during a crash investigation.*

To read data recorded by an EDR, special equipment is required, and access to the vehicle or the EDR is needed. In addition to the vehicle manufacturer, other parties, such as law enforcement, that have the special equipment, can read the information if they have access to the vehicle or the EDR.

Mazda will not disclose any of the data recorded in an EDR to a third party unless:

- A written agreement from the vehicle owner or the lessee is obtained
- Officially requested by the police or other law enforcement authorities
- Used as a defense for Mazda in a law suit, claim, or arbitration
- Ordered by a judge or court

However, if necessary Mazda will:

- Use the data for research on Mazda vehicle performance, including safety.
- Disclose the data or the summarized data to a third party for research purposes without disclosing vehicle or owner identification information.

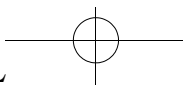



## Uniform Tire Quality Grading System (UTQGS)

### Uniform Tire Quality Grading System (UTQGS)

This information relates to the tire grading system developed by the U.S. National Highway Traffic Safety Administration for grading tires by tread wear, traction, and temperature performance.

#### ▼ Tread Wear

The tread wear grade is a comparative rating based on the wear rate of the tire when tested under controlled conditions on a specified government test course. For example, a tire graded 150 would wear one-and-a-half times as well on the government course as a tire graded 100.

The relative performance of tires depends upon the actual conditions of their use, however, and may depart significantly from the norm because of variations in driving habits, service practices and differences in road characteristics and climate.

#### ▼ Traction-AA, A, B, C

The traction grades, from highest to lowest, are AA, A, B, and C. These grades represent the tire's ability to stop on wet pavement as measured under controlled conditions on specified government test surfaces of asphalt and concrete. A tire marked C may have poor traction performance.

#### **WARNING**

*The traction grade assigned to this tire is based on braking (straight ahead) traction tests and does not include acceleration cornering (turning), hydroplaning, or peak traction characteristics.*

#### ▼ Temperature-A, B, C

The temperature grades A (the highest), B, and C, represent the tire's resistance to the generation of heat and its ability to dissipate heat when tested under controlled conditions on a specified indoor laboratory test wheel.

Sustained high temperature can cause the material of the tire to degenerate and reduce tire life, and excessive temperatures can lead to sudden tire failure.

Grade C corresponds to a level of performance which all passenger vehicle tires must meet under the Federal Motor Vehicle Safety Standard No. 109. Grades B and A represent higher levels of performance on the laboratory test wheel than the minimum required by law.

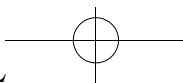

Customer Information and Reporting Safety Defects

## Uniform Tire Quality Grading System (UTQGS)

---

### **⚠ WARNING**

**Keep your vehicle's tires properly inflated and not overloaded:**

*Driving with improperly inflated or overloaded tires is dangerous. Excessive speed, underinflation, or excessive loading, either separately or in combination, can cause heat buildup and possible tire failure. The temperature grade for this tire is established for a tire that is properly inflated and not overloaded.*

These grades will be added to the sidewalls of passenger vehicle tires over the next several years according to a schedule established by the NHTSA and the tire manufacturers.

The grade of tires available as standard or optional equipment on Mazda vehicles may vary with respect to grade.

ALL PASSENGER VEHICLE TIRES MUST CONFORM TO THESE GRADES AND TO ALL OTHER FEDERAL TIRE-SAFETY REQUIREMENTS.

### ▼ Uniform Tire Quality Grading

Quality grades can be found where applicable on the tire sidewall between tread shoulder and maximum section width.

For example:

**Treadwear 200 Traction AA Temperature A**

UTQGS MARK (example)

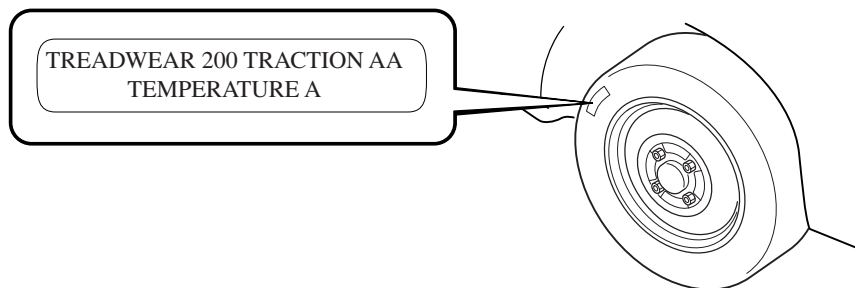



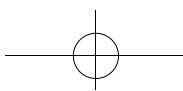

## Customer Information and Reporting Safety Defects Tire Information (U.S.A.)

### Tire Labeling

Federal law requires tire manufacturers to place standardized information on the sidewall of all tires. This information identifies and describes the fundamental characteristics of the tire and also provides a tire identification number for safety standard certification and in case of a recall.

#### ▼ Information on Passenger Vehicle Tires

Please refer to the sample below.

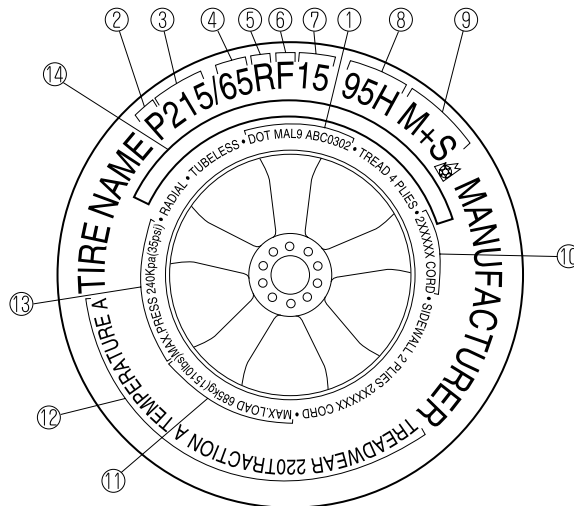

1. TIN: U.S. DOT tire identification number
2. Passenger car tire
3. Nominal width of tire in millimeters
4. Ratio of height to width (aspect ratio)
5. Radial
6. Run-flat tire
7. Rim diameter code
8. Load index & speed symbol
9. Severe snow conditions
10. Tire ply composition and materials used

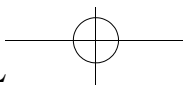



Customer Information and Reporting Safety Defects

## Tire Information (U.S.A.)

---

11. Max. load rating
12. Tread wear, traction and temperature grades
13. Max. permissible inflation pressure
14. SAFETY WARNING

P215/65R15 95H is an example of a tire size and load index rating. Here is an explanation of the various components of that tire size and load index rating. Note that the tire size and load index rating may be different from the example.

### **P**

Indicates a tire that may be installed on cars, SUVs, minivans and light trucks as designated by the Tire and Rim Association (T&RA).

### ***NOTE***

*If your tire size does not begin with a letter this may mean it is designated by either ETRTO (European Tire and Rim Technical Organization) or JATMA (Japan Tire Manufacturing Association).*

### **215**

“215” is the nominal width of the tire in millimeters. This three-digit number gives the width in millimeters of the tire from sidewall edge to sidewall edge. In general, the larger the number, the wider the tire.

### **65**

“65” is the aspect ratio. This two-digit number indicates the tire's ratio of height to width.

### **R**

“R” is the tire construction symbol. R indicates “Radial ply construction”.

### **15**

“15” is the wheel rim diameter in inches.

### **95**

“95” is the Load Index. This two-or three-digit number indicates how much weight each tire can support.

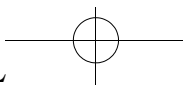

Customer Information and Reporting Safety Defects  
**Tire Information (U.S.A.)**

**H**

“H” is the speed rating. The speed rating denotes the maximum speed for which the use of the tire is rated.

Letter Rating	Speed Rating
Q	99 mph
R	106 mph
S	112 mph
T	118 mph
U	124 mph
H	130 mph
V	149 mph
W	168* mph
Y	186* mph

\* For tires with a maximum speed capability over 149 mph, tire manufacturers sometimes use the letters ZR. For tires with a maximum speed capability over 186 mph, tire manufacturers always use the letters ZR.

**M+ S or M/S: Mud and Snow**

AT: All Terrain.

AS: All Season. The “M+ S” or “M/S” indicates that the tire has some functional use in mud and snow.

**U.S. DOT Tire Identification Number (TIN)**

This begins with the letters “DOT” which indicates the tire meets all federal standards. The next two numbers or letters are the plant code where it was manufactured, and the last four numbers represent the week and year the tire was manufactured. For example, the numbers 457 means the 45st week of 1997. After 2000 the numbers go to four digits. For example, the number 2102 means the 21th week of 2002. The other numbers are marketing codes used at the manufacturer's discretion. This information is used to contact consumers if a tire defect requires a recall.

**Tire Ply Composition and Materials Used**

The number of plies indicates the number of layers of rubber-coated fabric in the tire. In general, the greater the number of plies, the more weight a tire can support. Tire manufacturers also must indicate the tire materials, which include steel, nylon, polyester, and other.

**Maximum Load Rating**

This number indicates the maximum load in kilograms and pounds that can be carried by the tire.

**Maximum Permissible Inflation Pressure**

This number is the greatest amount of air pressure that should ever be put in the tire under normal driving conditions.

Customer Information and Reporting Safety Defects

## **Tire Information (U.S.A.)**

---

### **Tread Wear, Traction and Temperature Grades**

**Tread wear:** The tread wear grade is a comparative rating based on the wear rate of the tire when tested under controlled conditions on a specified government test course. For example, a tire graded 150 would wear one and one-half (1 1/2) times as well on the government course as a tire graded 100.

**Traction:** The traction grades, from highest to lowest are AA, A, B, and C. The grades represent the tire's ability to stop on wet pavement as measured under controlled conditions on specified government test surfaces of asphalt and concrete. A tire marked C may have poor traction performance.

**Temperature:** The temperature grades are A (the highest), B and C, representing the tire's resistance to the generation of heat and its ability to dissipate heat when tested under controlled conditions on a specified indoor laboratory test wheel.

### **Snow Tires**

In some heavy snow areas, local governments may require true snow tires, those with very deeply cut tread. These tires should only be used in pairs or placed on all four wheels. Make sure you purchase snow tires that are the same size and construction type as the other tires on your vehicle.

### **SAFETY WARNING**

The following safety warning appears on the tire's sidewall.

SERIOUS INJURY MAY RESULT FROM:

- EXPLOSION OF TIRE/RIM ASSEMBLY DUE TO IMPROPER MOUNTING-MATCH TIRE DIAMETER TO RIM DIAMETER; NEVER EXCEED 40 psi (275 kPa) TO SEAT BEADS-ONLY SPECIALLY TRAINED PERSONS SHOULD MOUNT TIRES.
- TIRE FAILURE DUE TO UNDER-INFLATION/OVERLOADING/DAMAGE-FOLLOW OWNER'S MANUAL AND PLACARD IN VEHICLE-FREQUENTLY CHECK INFLATION PRESSURE AND INSPECT FOR DAMAGE.



Customer Information and Reporting Safety Defects  
**Tire Information (U.S.A.)**

▼ **Information on Temporary Tires**

Please refer to the sample below.

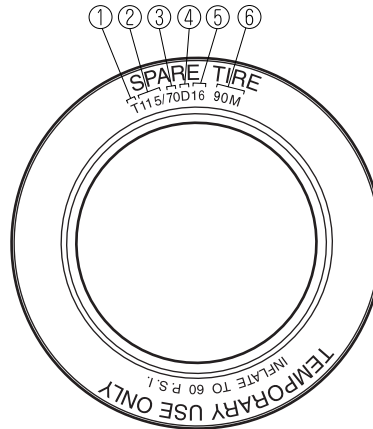

1. Temporary tires
2. Nominal width of tire in millimeters
3. Ratio of height to width (aspect ratio)
4. Diagonal
5. Rim diameter code
6. Load index & speed symbol

T115/70D 16 90M is an example of a tire size and load index rating. Here is an explanation of the various components of that tire size and load index rating. Note that the tire size and load index rating may be different from the example.

**T**

Indicates a tire that may be installed on cars, SUVs, minivans and light trucks as designated by the Tire and Rim Association (T&RA).

**115**

“115” is the nominal width of the tire in millimeters. This three-digit number gives the width in millimeters of the tire from sidewall edge to sidewall edge. In general, the larger the number, the wider the tire.

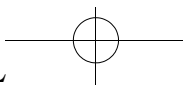



Customer Information and Reporting Safety Defects

## **Tire Information (U.S.A.)**

---

### **70**

“70” is the aspect ratio. This two-digit number indicates the tire's ratio of height to width.

### **D**

“D” is the tire construction symbol. D indicates “diagonal ply construction”.

### **16**

“16” is the wheel rim diameter in inches.

### **90**

“90” is the Load Index. This two-or three-digit number indicates how much weight each tire can support.

### **M**

“M” is the speed rating. The speed rating denotes the maximum speed for which the use of the tire is rated.

<b>Letter Rating</b>	<b>Speed Rating</b>
M	81 mph

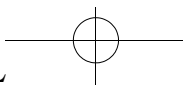

Customer Information and Reporting Safety Defects  
**Tire Information (U.S.A.)**

**Location of the Tire Label (Placard)**

You will find the tire label containing tire inflation pressure by tire size and other important information on the driver's side B-pillar or on the edge of the driver's door frame.

**SAMPLE**



TIRE AND LOADING INFORMATION RENSEIGNEMENTS SUR LES PNEUS ET LE CHARGEMENT			
SEATING CAPACITY NOMBRE DE PLACES	TOTAL 5	FRONT AVANT 2	REAR ARRIÈRE 3
The combined weight of occupants and cargo should never exceed <small>kg or lbs.*</small> Le poids total des occupants et du chargement ne doit jamais dépasser <small>xxx kg ou xxx lb.*</small>			SEE OWNER'S MANUAL FOR ADDITIONAL INFORMATION  VOIR LE MANUEL DE L'USAGER POUR PLUS DE RENSEIGNEMENTS
TIRE PNEU	SIZE DIMENSIONS	COLD TIRE PRESSURE PRESSION DES PNEUS A FROID	
FRONT AVANT	P195/70R14	200 kPa, 29 psi	
REAR ARRIÈRE	P195/70R14	200 kPa, 29 psi	
SPARE DE SECOURS	T125/70D15	420 kPa, 60 psi	(XXX)

▼ **Recommended Tire Inflation Pressure**

On the tire label you will find the recommended tire inflation pressure in both kPa and psi for the tires installed as original equipment on the vehicle. It is very important that the inflation pressure of the tires on your vehicle is maintained at the recommended pressure. You should check the tire pressure regularly to insure that the proper inflation pressure is maintained.

Refer to Tires on page 9-7.

**NOTE**

*Tire pressures listed on the vehicle placard or tire information label indicate the recommended cold tire inflation pressure, measured when the tires are cold, after the vehicle has been parked for at least 3 hours. As you drive, the temperature in the tire warms up, increasing the tire pressure.*

Customer Information and Reporting Safety Defects

## Tire Information (U.S.A.)

---

### **WARNING**

***Always check the tire inflation pressures on a regular basis according to the recommended tire inflation pressure on the tire label and in conjunction with the information in this owner's manual:***

*Driving your vehicle with under-inflated tires is dangerous.*

*Under-inflation is the most common cause of failures in any kind of tire and may result in severe cracking, tread separation or "blowout", with unexpected loss of vehicle control and increased risk of injury. Under-inflation increases sidewall flexing and rolling resistance, resulting in heat buildup and internal damage to the tire. It results in unnecessary tire stress, irregular wear, loss of control and accidents. A tire can lose up to half of its air pressure and not appear to be flat!*

*It is impossible to determine whether or not tires are properly inflated just by looking at them.*

### ▼ **Checking Tire Pressure**

1. When you check the air pressure, make sure the tires are cold —meaning they are not hot from driving even a mile.
2. Remove the cap from the valve on one tire.
3. Firmly press a tire gauge onto the valve.
4. Add air to achieve recommended air pressure.
5. If you overfill the tire, release air by pushing on the metal stem in the center of the valve. Then recheck the pressure with your tire gauge.
6. Replace the valve cap.
7. Repeat with each tire, including the spare.

### **NOTE**

*Some spare tires require higher inflation pressure.*

8. Visually inspect the tires to make sure there are no nails or other objects embedded that could poke a hole in the tire and cause an air leak.
9. Check the sidewalls to make sure there are no gouges, cuts, bulges, cracks or other irregularities.





Customer Information and Reporting Safety Defects  
**Tire Information (U.S.A.)**

---

▼ **Glossary of Terms**

**Tire Placard:** A label indicating the OE tire sizes, recommended inflation pressure, and the maximum weight the vehicle can carry.

**Tire Identification Number (TIN):** A number on the sidewall of each tire providing information about the tire brand and manufacturing plant, tire size, and date of manufacture.

**Inflation Pressure:** A measure of the amount of air in a tire.

**kPa:** Kilopascal, the metric unit for air pressure.

**psi:** Pounds per square inch, the English unit for air pressure.

**B-pillar:** The structural member at the side of the vehicle behind the front door.

**Original Equipment (OE):** Describes components originally equipped on the vehicle.

**Vehicle Load Limit:** The maximum value of the combination weight of occupants and cargo.

**Bead Area of the Tire:** Area of the tire next to the rim.

**Sidewall Area of the Tire:** Area between the bead area and the tread.

**Tread Area of the Tire:** Area on the perimeter of the tire that contacts the road when it's mounted on the vehicle.

**Seating capacity** means the total allowable number of vehicle occupants. Seating capacity is described on the tire label.

**Production options weight** is the combination weight of installed regular production options weighing over 2.3 kilograms in excess of the standard items which they replace, and not previously considered in the curb weight or accessory weight, including heavy duty brakes, ride levelers, roof rack, heavy duty battery, and special trim.

**Rim** is the metal support (wheel) for a tire or a tire and tube assembly upon which the tire beads are seated.

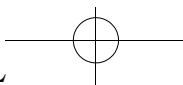

Customer Information and Reporting Safety Defects

## Tire Information (U.S.A.)

### Tire Maintenance

Improper or inadequate vehicle maintenance can cause tires to wear abnormally. Here are some important maintenance points:

#### ▼ Tire Inflation Pressure

Inspect all tire pressure monthly (including the spare) when the tires are cold. Maintain recommended pressures for the best ride, top handling, and minimum tire wear. Use the pressures specified on the vehicle tire information placard or tire label for optimum service.

#### ▼ Tire Rotation

To equalize tread wear, rotate the tires every 12,000 km (7,500 miles) or sooner if irregular wear develops. During rotation, inspect them for correct balance.

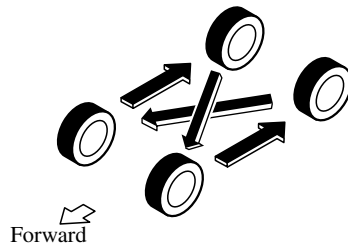

Do not include (TEMPORARY USE ONLY)  
spare tire in rotation.

Inspect the tires for uneven wear and damage. Abnormal wear is usually caused by one or a combination of the following:

- Incorrect tire pressure
- Improper wheel alignment
- Out-of-balance wheel
- Severe braking

After rotation, inflate all tire pressures to specification (page 9-7) and inspect the lug nuts for tightness.

Customer Information and Reporting Safety Defects  
**Tire Information (U.S.A.)**

**⚠ CAUTION**

*Rotate unidirectional tires and radial tires that have an asymmetrical tread pattern or studs only from front to rear, not from side to side. Tire performance will be weakened if rotated from side to side.*

**(With limited-slip differential)**

*Don't use the following:*

- *Tires not of the designated size*
- *Tires of different sizes or types at the same time*
- *Tires not sufficiently inflated*

*If these instructions aren't followed, the rotation of the left and right wheels will be different and will thus apply a constant load on the limited-slip differential. This will cause a malfunction.*

**▼ Replacing a Tire**

**⚠ WARNING**

**Always use tires that are in good condition:**

*Driving with worn tires is dangerous. Reduced braking, steering, and traction could result in an accident.*

If a tire wears evenly, a wear indicator will appear as a solid band across the tread. Replace the tire when this happens.

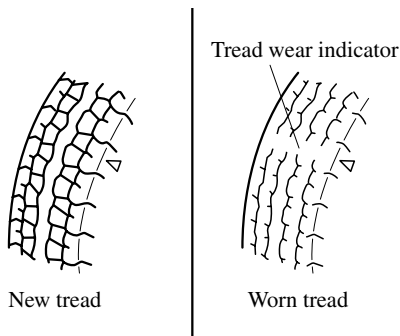

You should replace the tire before the band crosses the entire tread.

Customer Information and Reporting Safety Defects

## Tire Information (U.S.A.)

---

### **NOTE**

*Tires degrade over time, even when they are not being used on the road. It is recommended that tires generally be replaced when they are 6 years or older. Heat caused by hot climates or frequent high loading conditions can accelerate the aging process. You should replace the spare tire when you replace the other road tires due to the aging of the spare tire. The period in which the tire was manufactured (both week and year) is indicated by a 4-digit number.*

*Refer to Tire Labeling on page 8-25.*

### **▼ Safety Practices**

The way you drive has a great deal to do with your tire mileage and safety. So cultivate good driving habits for your own benefit.

- Observe posted speed limits
- Avoid fast starts, stops and turns
- Avoid potholes and objects on the road
- Do not run over curbs or hit the tire against the curb when parking

### **⚠ CAUTION**

*If you feel a sudden vibration or ride disturbance while driving or you suspect your tire or vehicle has been damaged, immediately reduce your speed. Drive with caution until you can safely pull off the road. Stop and inspect the tire for damage. If the tire is under-inflated or damaged, deflate it, remove the tire and rim and replace it with your spare tire. If you cannot detect a cause, have the vehicle towed to the nearest vehicle or tire dealer to have the vehicle inspected.*



Customer Information and Reporting Safety Defects  
**Tire Information (U.S.A.)**

## Vehicle Loading

This section will guide you in the proper loading of your vehicle and/or trailer, to keep your loaded vehicle weight within its design rating capability, with or without a trailer. Properly loading your vehicle will provide maximum return of vehicle design performance. Before loading your vehicle, familiarize yourself with the following terms for determining your vehicle's weight ratings, with or without a trailer, from the vehicle's Safety Certification Label and Tire and Load Information Label:

### **! WARNING**

#### **Overloaded Vehicle:**

*Overloading a vehicle is dangerous. The results of overloading can have serious consequences in terms of passenger safety. Too much weight on a vehicle's suspension system can cause spring or shock absorber failure, brake failure, handling or steering problems, irregular tire wear, tire failure or other damage. Overloading makes a vehicle harder to drive and control. It also increases the distance required for stopping. In cases of serious overloading, brakes can fail completely, particularly on steep grades. The load a tire will carry safely is a combination of the size of the tire, its load range, and corresponding inflation pressure.*

*Never overload the vehicle and always observe the vehicle's weight ratings from the vehicle's Safety Certification and Tire and Load Information labels.*

**Base Curb Weight** is the weight of the vehicle including a full tank of fuel and all standard equipment. It does not include passengers, cargo, or optional equipment.

**Vehicle Curb Weight** is the weight of your new vehicle when you picked it up from your dealer plus any aftermarket equipment.

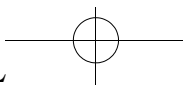
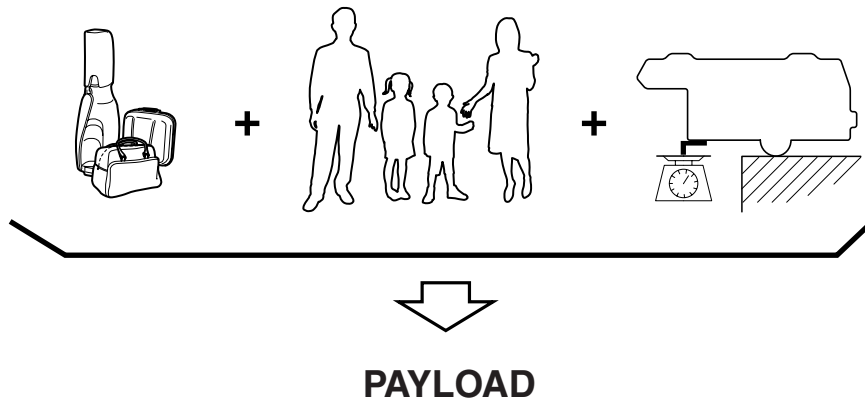

Customer Information and Reporting Safety Defects

**Tire Information (U.S.A.)**

**Payload** is the combination weight of cargo and passengers that the vehicle is designed to carry. The maximum payload for your vehicle can be found on the Tire and Load Information label on the driver's door frame or door pillar. Look for "THE COMBINATION WEIGHT OF OCCUPANTS AND CARGO SHOULD NEVER EXCEED XXX kg or XXX lbs" for your maximum payload. The payload listed on the tire label is the maximum payload for the vehicle as built by the assembly plant. If any aftermarket or dealer installed equipment has been installed on the vehicle, the weight of the equipment must be subtracted from the payload listed on the tire label in order to be accurate.

**SAMPLE**

 <b>TIRE AND LOADING INFORMATION</b> <b>RENSEIGNEMENTS SUR LES PNEUS ET LE CHARGEMENT</b>				
SEATING CAPACITY NOMBRE DE PLACES		TOTAL 5	FRONT AVANT 2	REAR ARRIÈRE 3
The combined weight of occupants and cargo should never exceed <b>xxx</b> kg or <b>xxx</b> lbs.* Le poids total des occupants et du chargement ne doit jamais dépasser <b>xxx</b> kg ou <b>xxx</b> lb.*				
TIRE PNEU	SIZE DIMENSIONS	COLD TIRE PRESSURE PRESSION DES PNEUS À FROID		SEE OWNER'S MANUAL FOR ADDITIONAL INFORMATION  VOIR LE MANUEL DE L'USAGER POUR PLUS DE RENSEIGNEMENTS
FRONT AVANT	P195/70R14	200 kPa, 29 psi		
REAR ARRIÈRE	P195/70R14	200 kPa, 29 psi		
SPARE DE SECOURS	T125/70D15	420 kPa, 60 psi		

## Tire Information (U.S.A.)

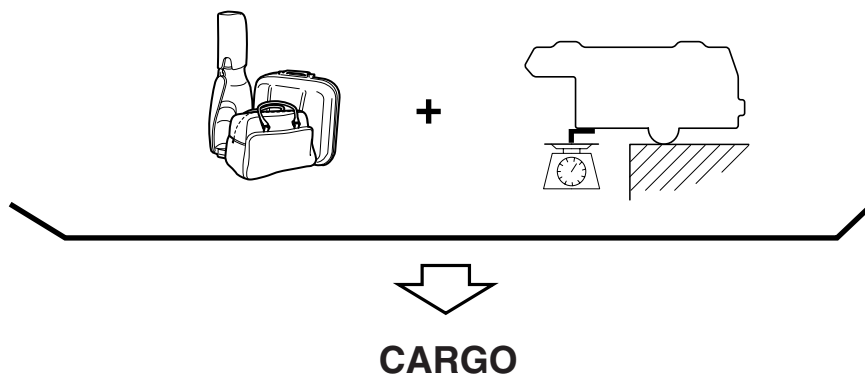

**Cargo Weight** includes all weight added to the Base Curb Weight, including cargo and optional equipment. When towing, trailer tongue load or king pin weight is also part of cargo weight.

The cargo weight limit decreases depending on the number of vehicle occupants. The cargo weight limit can be calculated by subtracting the total weight of the vehicle occupants from the “combination weight of occupants and cargo should never exceed” value on the tire label.

Examples: Based on a single occupant weight of 68 kg (150 lbs), and a value of 385 kg (849 lbs) for the “combination weight of occupants and cargo should never exceed”:  
The cargo weight limit with one occupant is  $385 \text{ kg (849 lbs)} - 68 \text{ kg (150 lbs)} = 317 \text{ kg (699 lbs)}$

The cargo weight limit with two occupants is  $385 \text{ kg (849 lbs)} - (68 \times 2) \text{ kg (} (150 \times 2) \text{ lbs)} = 249 \text{ kg (549 lbs)}$

If the weight of the occupant increases, the cargo weight limit decreases by that much.

**GAW (Gross Axle Weight)** is the total weight placed on each axle (front and rear) - including vehicle curb weight and all payload.

Customer Information and Reporting Safety Defects

## Tire Information (U.S.A.)

---

**GAWR (Gross Axle Weight Rating)** is the maximum allowable weight that can be carried by a single axle (front or rear). **These numbers are shown on the Safety Compliance Certification Label located on the driver's door frame or door pillar. The total load on each axle must never exceed its GAWR.**

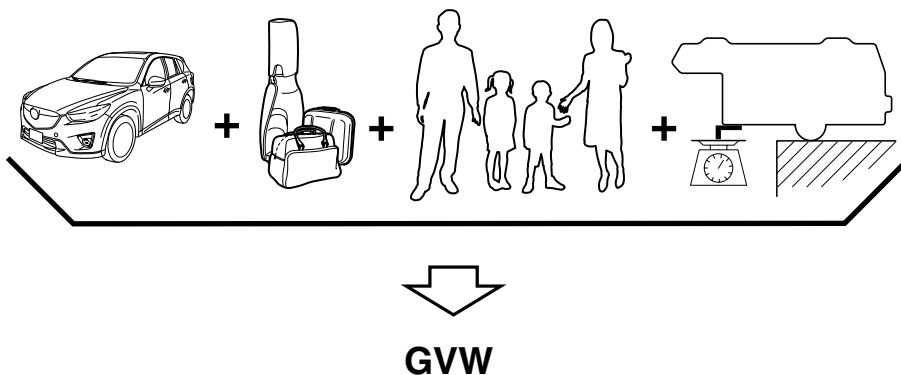

**GVW (Gross Vehicle Weight)** is the Vehicle Curb Weight + cargo + passengers.

**GVWR (Gross Vehicle Weight Rating)** is the maximum allowable weight of the fully loaded vehicle (including all options, equipment, passengers and cargo). **The GVWR is shown on the Safety Compliance Certification Label located on the driver's door frame or door pillar. The GVW must never exceed the GVWR.**





Customer Information and Reporting Safety Defects

## Tire Information (U.S.A.)

---

**GCW (Gross Combination Weight)** is the weight of the loaded vehicle (GVW) plus the weight of the fully loaded trailer.

**GCWR (Gross Combination Weight Rating)** is the maximum allowable weight of the vehicle and the loaded trailer - including all cargo and passengers - that the vehicle can handle without risking damage. (Important: The towing vehicle's braking system is rated for operation at GVWR, not at GCWR. Separate functional brakes should be used for safe control of towed vehicles and for trailers weighing more than 1,500 lbs). **The GCW must never exceed the GCWR.**

**Maximum Loaded Trailer Weight** is the highest possible weight of a fully loaded trailer the vehicle can tow. It assumes a vehicle with only mandatory options, no cargo (internal or external), a tongue load of 10–15% (conventional trailer) or king pin weight of 15–25% (fifth-wheel trailer), and driver only (150 lbs). **Consult your dealership (or the RV and Trailer Towing Guide provided by your dealership) for more detailed information.** **Tongue Load or Fifth-Wheel King Pin Weight** refers to the amount of the weight that a trailer pushes down on a trailer hitch.

**Examples:** For a 5000 lb conventional trailer, multiply 5000 by 0.10 and 0.15 to obtain a proper tongue load range of 500 to 750 lbs. For an 11,500 lb fifth-wheel trailer, multiply by 0.15 and 0.25 to obtain a proper king pin load range of 1,725 to 2,875 lbs.

### **WARNING**

#### **Exceeding GVWR or GAWR Specifications:**

*Exceeding the GVWR or the GAWR specified on the certification label is dangerous. Exceeding any vehicle rating limitation could result in a serious accident, injury, or damage to the vehicle.*

*Do not use replacement tires with lower load carrying capacities than the originals because they may lower the vehicle's GVWR and GAWR limitations. Replacement tires with a higher limit than the originals do not increase the GVWR and GAWR limitations.*

*Never exceed the GVWR or the GAWR specified on the certification label.*

Customer Information and Reporting Safety Defects  
**Tire Information (U.S.A.)**

**Steps for Determining the Correct Load Limit:**

Steps for Determining Correct Load Limit:

- (1) Locate the statement “The combined weight of occupants and cargo should never exceed XXX kg or XXX lbs” on your vehicle's placard.
- (2) Determine the combined weight of the driver and passengers that will be riding in your vehicle.
- (3) Subtract the combined weight of the driver and passengers from XXX kg or XXX lbs.
- (4) The resulting figure equals the available amount of cargo and luggage load capacity. For example, if the “XXX” amount equals 1400 lbs. and there will be five 150 lb passengers in your vehicle, the amount of available cargo and luggage load capacity is 650 lbs.  $(1400 - 750 (5 \times 150) = 650$  lbs.)
- (5) Determine the combined weight of luggage and cargo being loaded on the vehicle. That weight may not safely exceed the available cargo and luggage load capacity calculated in Step 4.
- (6) If your vehicle will be towing a trailer, the load from your trailer will be transferred to your vehicle. Consult this manual to determine how this reduces the available cargo and luggage load capacity of your vehicle.



Customer Information and Reporting Safety Defects

## Declaration of Conformity

---

### Declaration of Conformity

#### ▼ Keyless Entry System/Immobilizer System

#### FCC WARNING

Changes or modifications not expressly approved by the party responsible for compliance could void the user's authority to operate the equipment.

#### FCC/IC

This device complies with Part 15 of FCC Rules and Industry Canada licence-exempt RSS standard(s). Operation is subject to the following two conditions: (1) this device may not cause interference, and (2) this device must accept any interference, including interference that may cause undesired operation of this device.

Le présent appareil est conforme aux la Partie 15 des règles de la FCC et CNR d'Industrie Canada applicables aux appareils radio exempts de licence. L'exploitation est autorisée aux deux conditions suivantes: (1) l'appareil ne doit pas produire de brouillage, et (2) l'utilisateur de l'appareil doit accepter tout brouillage radioélectrique subi, même si le brouillage est susceptible d'en compromettre le fonctionnement.

#### (MEXICO)

Este equipo opera a título secundario, consecuentemente, debe aceptar interferencias perjudiciales incluyendo equipos de la misma clase y puede no causar interferencias a sistemas operando a título primario.

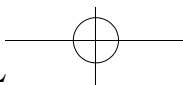

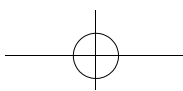

Customer Information and Reporting Safety Defects  
**Declaration of Conformity**

**▼ Blind Spot Monitoring (BSM) System**

**Radiation Hazard**

This BSM (blind spot monitoring) device emits intentional electromagnetic radiation in the 24 GHz to 25 GHz frequency range. The total radiated average power over the entire bandwidth is below  $-14$  dBm ( $40 \mu\text{W}$ ). The active emitting antenna surface is  $72 \text{ cm}^2$ ; therefore the radiated power density in front of the BSM device is  $0.55 \mu\text{W}/\text{cm}^2$ . This value is far below the legal human exposure protection limit of  $1 \text{ mW}/\text{cm}^2$  (MPE) in Europe and US.

**Declaration of compliance for 24 GHz blind spot radar**

**(U.S.A)**

**FCC ID: OAYBSDTX**

This vehicle is equipped with a 24 GHz blind spot monitoring (BSM) radar system, which complies with part 15 of the FCC rules. Operation is subject to the following conditions:

1. This device may not cause harmful interference, and
2. This device must accept any interference received, including interference that may cause undesired operation.
3. This device may only work when the vehicle is in operation pursuant to § 15. 252 (a) (4).

**(CANADA)**

**IC:4135A-BSDTX**

This device complies with the radio standards specification RSS-220 of Industry Canada. Operation is subject to the following two conditions:

1. This device may not cause harmful interference.
2. This device must accept any interference received, including interference that may cause undesired operation.

**(MEXICO)**

**RLVCOBS10-0567**

**NOTE**

*During printing time of this user manual the approvals listed above are granted. Further countries may become available or actual certification identifiers may be subject to change or update.*

**⚠ WARNING**

*Changes or modifications not expressly approved by the party responsible for compliance could void the user's authority to operate the equipment.*

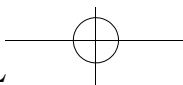

Customer Information and Reporting Safety Defects

## Declaration of Conformity

---

### ▼ HomeLink Wireless Control System

#### CAUTION

*HomeLink has been tested and complies with FCC and Industry Canada rules. Changes or modifications not expressly approved by the party responsible for compliance could void the user's authority to operate the device.*

#### **NOTE**

*FCC ID: NZLMOBHL4*

*CANADA:4112A-MOBHL4*

*This device complies with part 15 of the FCC Rules. Operation is subject to the following two conditions:*

- 1- This device may not cause harmful interference, and*
- 2- This device must accept any interference received, including interference that may cause undesired operation.*

### ▼ Satellite Radio

#### **NOTE**

*This equipment has been tested and found to comply with the limits for a Class B digital device, pursuant to Part 15 of the FCC Rules. These limits are designed to provide reasonable protection against harmful interference in a residential installation. This equipment generates, uses, and can radiate radio frequency energy and if not installed and used in accordance with the instructions, may cause harmful interference to radio communications. However, there is no guarantee that interference will not occur in a particular installation. If this equipment does cause harmful interference to radio or television reception, which can be determined by turning the equipment off and on, the user is encouraged to try to correct the interference by one or more of the following measures:*

- Increase the separation between the equipment and tuner.*
- Connect the equipment into an outlet on a circuit different from that to which the tuner is connected.*
- Consult the dealer or an experienced radio/TV technician for help.*

Customer Information and Reporting Safety Defects  
**Declaration of Conformity**

▼ **Audio System**

This CD player is made and tested to meet exacting safety standards. It meets FCC requirements and complies with safety performance standards of the U.S. Department of Health and Human Services.

**⚠ CAUTION**

- *This CD player should not be adjusted or repaired by anyone except qualified service personnel.  
If servicing is required, contact an Authorized Mazda Dealer.*
- *Use of controls or adjustments or performance of procedures other than those specified herein may result in hazardous laser exposure. Never operate the CD player with the top case of the unit removed.*
- *Changes or modifications not expressly approved by the party responsible for compliance could void the user's authority to operate this equipment.*

**NOTE**

*For CD player section:*

*This device complies with part 15 of the FCC Rules. Operation is subject to the following two conditions: (1) This device may not cause harmful interference, and (2) this device must accept any interference received, including interference that may cause undesired operation.*

**NOTE**

*This equipment has been tested and found to comply with the limits for a Class B digital device, pursuant to part 15 of the FCC Rules. These limits are designed to provide reasonable protection against harmful interference in a residential installation. This equipment generates, uses, and can radiate radio frequency energy and, if not installed and used in accordance with the instructions, may cause harmful interference to radio communications. However, there is no guarantee that interference will not occur in a particular installation.*

▼ **Bluetooth® Hands-Free**

**FCC**

FCC: CB2MAZGEN6HFT

**NOTE**

*This device complies with Part 15 of the FCC Rules. Operation is subject to the following two conditions:*

- (1) This device may not cause harmful interference, and*
- (2) This device must accept any interference received, including interference that may cause undesired operation.*

**⚠ WARNING**

*Changes or modifications not expressly approved by the party responsible for compliance could void the user's authority to operate the equipment.*

Customer Information and Reporting Safety Defects

## Declaration of Conformity

---

### **NOTE**

*This equipment has been tested and found to comply with the limits for a Class B digital device, pursuant to Part 15 of the FCC Rules. These limits are designed to provide reasonable protection against harmful interference in a residential installation. This equipment generates, uses and can radiate radio frequency energy and, if not installed and used in accordance with the instructions, may cause harmful interference to radio communications. However, there is no guarantee that interference will not occur in a particular installation. If this equipment does cause harmful interference to radio or television reception, which can be determined by turning the equipment off and on, the user is encouraged to try to correct the interference by one or more of the following measures:*

- *Reorient or relocate the receiving antenna.*
- *Increase the separation between the equipment and receiver.*
- *Connect the equipment into an outlet on a circuit different from that to which the receiver is connected.*
- *Consult the dealer or an experienced radio/TV technician for help.*

### **IC**

IC:279B-MAZGEN6HFT

Licence exempt

This device complies with Industry Canada licence-exempt RSS standard(s). Operation is subject to the following two conditions:

- (1) This device may not cause interference, and
- (2) This device must accept any interference, including interference that may cause undesired operation of the device.

The term "IC:" before the radio certification number only signifies that Industry Canada technical specifications were met. The antenna used for this transmitter must not be co-located or operating in conjunction with any other antenna or transmitter. End-users and installers must be provided with installation instructions and transmitter operating conditions for satisfying RF exposure compliance.



## Service Publications

### Service Publications

Factory-authorized Mazda service publications are available for owners who wish to do some of their own maintenance and repair.

When requesting any of our publications through an Authorized Mazda Dealer, refer to the chart below.

If they do not have what you need in stock, they can order it for you.

PUBLICATION ORDER NUMBER	PUBLICATION DESCRIPTION
9999-95-033B-13	2013 WORKSHOP MANUAL (English)
9999-MX-033B-13	2013 WORKSHOP MANUAL (Spanish)
9999-95-076G-13	2013 WIRING DIAGRAM (English)
9999-MX-076G-13	2013 WIRING DIAGRAM (Spanish)
9999-95-050C-13 (U.S.A. only)	2013 OWNER'S MANUAL
9999-EC-050C-13 (Canada only)	2013 OWNER'S MANUAL
9999-PR-050C-13 (Puerto Rico, Mexico only)	2013 OWNER'S MANUAL
9999-95-105F-13	2013 SERVICE HIGHLIGHTS
9999-95-050C-13NAV	2013 NAVIGATION SYSTEM OWNER'S MANUAL

#### ▼ WORKSHOP MANUAL:

Covers recommended maintenance and repair procedures of the drive train, body and chassis.

#### ▼ WIRING DIAGRAM:

Provides electrical schematics as well as component location for the entire electrical system.

#### ▼ OWNER'S MANUAL:

This booklet contains information regarding the proper care and operation of your vehicle. This is not a technician's manual.

#### ▼ SERVICE HIGHLIGHTS:

Provides description and operation of the many systems of your Mazda.



Customer Information and Reporting Safety Defects

## Service Publications

---

### ▼ NAVIGATION SYSTEM OWNER'S MANUAL:

This booklet contains information regarding the proper operation and use of the navigation system. This is not a technician's manual.

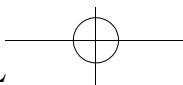



# 9

## Specifications

Technical information about your Mazda.

<b>Identification Numbers .....</b>	<b>9-2</b>
Vehicle Information Labels .....	9-2
<b>Specifications .....</b>	<b>9-4</b>
Specifications .....	9-4
<b>Personalization Features .....</b>	<b>9-8</b>
Personalization Features .....	9-8

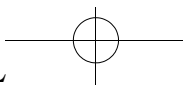

## Identification Numbers

### Vehicle Information Labels

#### ▼ Vehicle Identification Number

The vehicle identification number legally identifies your vehicle. The number is on a plate attached to the left top side of the dashboard. This plate can easily be seen through the windshield.

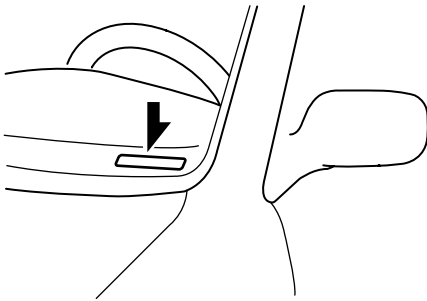

#### ▼ Motor Vehicle Safety Standard Label

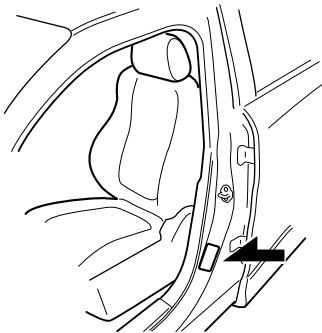

#### ▼ Chassis Number

Open the cover shown in the figure to check the chassis number.

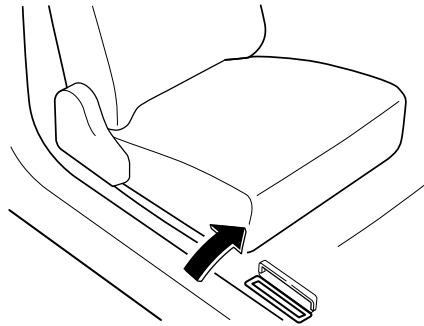

#### ▼ Vehicle Emission Control Information Label (U.S.A. and Canada)

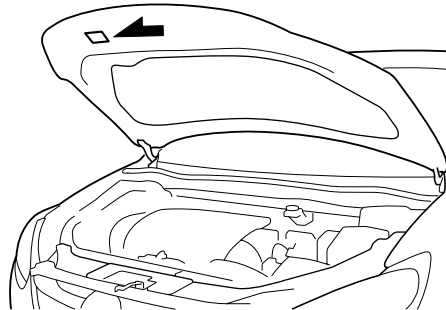

## Identification Numbers

---

### ▼ Tire Pressure Label

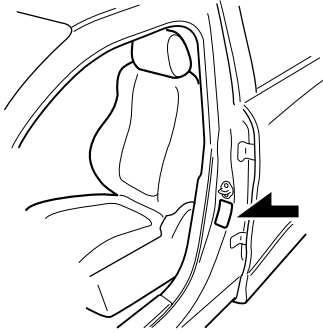

### ▼ Engine Number

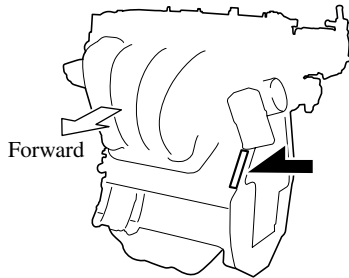

## Specifications

### Specifications

#### ▼ Engine

Item	Specification
Type	DOHC-16V in-line, 4-cylinder
Bore × Stroke	83.5 × 91.2 mm (3.29 × 3.59 in)
Displacement	1,998 ml (1,998 cc, 121.9 cu in)
Compression ratio	13.0

#### ▼ Electrical System

Item	Classification	
Battery	12V-48AH/5HR, 12V-52AH/5HR	
Spark plug	Mazda Genuine spark plug*1	PE01-18110
		PE02-18110

\*1 This Mazda genuine spark plug features specially shaped electrodes to ensure optimum performance of the SKYACTIV-G engine. For details, contact an Authorized Mazda Dealer.

### **⚠ CAUTION**

*When cleaning the iridium plugs, do not use a wire brush. The fine particulate coating on the iridium alloy and platinum tips could be damaged.*

#### ▼ Lubricant Quality

Lubricant	Classification	
Engine oil	Refer to Recommended Oil on page 6-20.	
Manual transaxle oil	API Service	GL-4
	SAE	75W-80
Automatic transaxle fluid	Mazda Genuine ATF FZ	
Transfer case oil	API Service	GL-5
	SAE	80W-90
Rear differential oil	API Service	GL-5
	SAE	80W-90
Brake/Clutch fluid	SAE J1703 or FMVSS116 DOT-3	

## Specifications

### ▼ Capacities

#### (Approximate Quantities)

Item		Capacity	
Engine oil	With oil filter replacement	4.2 L (4.4 US qt, 3.7 Imp qt)	
	Without oil filter replacement	4.0 L (4.2 US qt, 3.5 Imp qt)	
Coolant	U.S.A. and Canada	Manual transaxle	7.4 L (7.8 US qt, 6.5 Imp qt)
		Automatic transaxle	7.6 L (8.0 US qt, 6.7 Imp qt)
	Mexico	Manual transaxle	7.5 L (7.9 US qt, 6.6 Imp qt)
		Automatic transaxle	7.8 L (8.2 US qt, 6.9 Imp qt)
Manual transaxle fluid		1.65 L (1.74 US qt, 1.45 Imp qt)	
Automatic transaxle fluid		7.8 L (8.2 US qt, 6.9 Imp qt)	
Transfer case oil		0.45 L (0.48 US qt, 0.40 Imp qt)	
Rear differential oil		0.45 L (0.48 US qt, 0.40 Imp qt)	
Fuel tank	2WD	56.0 L (14.8 US gal, 12.3 Imp gal)	
	AWD	58.0 L (15.3 US gal, 12.8 Imp gal)	

Check oil and fluid levels with dipsticks or reservoir gauges.

### ▼ Dimensions

Item	Vehicle specification
Overall length	4,540 mm (178.7 in)
Overall width	1,840 mm (72.4 in)
Overall height	1,710 mm (67.3 in)
Front tread	1,585 mm (62.4 in)
Rear tread	1,590 mm (62.6 in)
Wheelbase	2,700 mm (106.3 in)

### ▼ Weights

#### 2WD

Item	Weight	
	Manual transaxle	Automatic transaxle
GVWR (Gross Vehicle Weight Rating)	1,927 kg (4,248 lbs)	1,961 kg (4,323 lbs)
GAWR (Gross Axle Weight Rating)	Front	964 kg (2,125 lbs)
	Rear	966 kg (2,130 lbs)

#### AWD

Item	Weight	
GVWR (Gross Vehicle Weight Rating)	2,024 kg (4,462 lbs)	
GAWR (Gross Axle Weight Rating)	Front	1,016 kg (2,240 lbs)
	Rear	1,011 kg (2,229 lbs)

## Specifications

### ▼ Air Conditioner

The type of refrigerant used is indicated on a label attached to the inside of the engine compartment. Check the label before recharging the refrigerant. Refer to Climate Control System on page 5-2.

Item	Classification
Refrigerant Type	HFC134a (R-134a)

### ▼ Light Bulbs

#### Exterior light

Light bulb	Category		
	Wattage	ECE R (SAE)	
With halogen bulb headlights			
Headlights	Low beam	55	H11 (H11)
	High beam	60	HB3 (HB3)
Daytime running lights			
With xenon fusion bulb headlights			
Headlights	High/Low beam	35	D4S (D4S)
Daytime running lights		13	P13W (—)
Front turn signal lights/ Parking lights (Front side-marker lights)		27/8	— (#1157NA)
Fog lights*		55	H11 (H11)
Side turn signal lights		LED* <sup>1</sup>	— (—)
High-mount brake light		LED* <sup>1</sup>	— (—)
Rear turn signal lights		21	WY21W (22.3CP)
Brake lights/Taillights		21/5	W21/5W (#7443)
Rear side-marker lights		5	W5W (4CP)
Taillights (Liftgate side)		5	W5W (4CP)
Reverse light		18	W16W (#921)
License plate lights		5	W5W (—)

\*1 LED is the abbreviation for Light Emitting Diode.

#### Interior light

Light bulb	Category	
	Wattage	ECE R
Overhead light (Front)/Map lights	8	—
Rear map light	8	—
Luggage compartment light	5	—
Vanity mirror lights*	2	—

9-6 \*Some models.



## Specifications

### ▼ Tires

#### **NOTE**

*The tires have been optimally matched with the chassis of your vehicle.  
 When replacing tires, Mazda recommends that you replace tires of the same type originally fitted to your vehicle. For details, contact an Authorized Mazda Dealer.*

Check the tire pressure label for tire size and inflation pressure.  
 Refer to Tire Inflation Pressure on page 6-35.

#### **Standard tire**

**(U.S.A. and Canada)**

Tire size	Inflation pressure	
	Front	Rear
P225/65R17 100H	230 kPa (34 psi)	230 kPa (34 psi)
P225/55R19 99V	250 kPa (36 psi)	250 kPa (36 psi)

**(Mexico)**

Tire size		Inflation pressure	
		Up to 3 persons	—Full load
225/65R17 102V	Front	230 kPa (2.3 bar, 33 psi)	260 kPa (2.6 bar, 38 psi)
	Rear	230 kPa (2.3 bar, 33 psi)	280 kPa (2.8 bar, 41 psi)
225/55R19 99V	Front	250 kPa (2.5 bar, 36 psi)	260 kPa (2.6 bar, 38 psi)
	Rear	250 kPa (2.5 bar, 36 psi)	290 kPa (2.9 bar, 42 psi)

1 person's weight: About 75 kg

#### **Temporary spare tire**

**(U.S.A. and Canada)**

Tire size	Inflation pressure
T145/90D16 106M	420 kPa (60 psi)
T155/90D18 103M	

**(Mexico)**

Tire size	Inflation pressure
185/80R17 95M	250 kPa (36 psi)

### ▼ Fuses

Refer to Fuses on page 6-49.

## Personalization Features

### Personalization Features

For vehicles with audio (On-screen function type), the following function settings can be changed by the customer.  
 For vehicles without audio (On-screen function type), the following function settings can be changed at an Authorized Mazda Dealer. Consult an Authorized Mazda Dealer for details.  
 Items in which the function setting can be changed differ depending on the market and specification.

Item	Feature	Factory Setting	Available Settings
Power door lock *1	Changes the auto lock/unlock function setting for all the doors according to the vehicle speed, the vehicle power supply condition, and the selector lever position	Lock: Driving, Unlock: IGN Off	Off/Lock When Driving/Lock: Shift From P, Unlock: In P/Lock When Shifting Out Of P
Keyless entry system	The method for unlocking the doors using the transmitter can be changed	Once: Driver's, Twice: All Doors	Touch Once: All Doors
	The time required for the doors to relock automatically after unlocking with the transmitter can be changed	60 seconds	30 seconds/90 seconds
Advanced keyless entry system	The volume of the answer-back beep during advanced keyless entry system operation can be changed	Medium	Off/Low/High
	The function to automatically lock the doors when leaving the vehicle while carrying the key can be changed	Off	On
	The method for unlocking the doors using the request switch can be changed	Once: Driver's, Twice: All Doors	Touch Once: All Doors
	The time required for the doors to relock automatically after unlocking with the transmitter can be changed	60 seconds	30 seconds/90 seconds
Illumination entry	The time required for the interior lamp to turn off automatically can be changed (prevents battery depletion when a door is open/ajar)	30 minutes	60 minutes/10 minutes
	The time required for the interior lamp to turn off automatically after all doors are closed can be changed	15 seconds	7.5 seconds/30 seconds/60 seconds
Lane-change signal (Smart turn)	The smart turn function can be changed	Off	On
Auto-wiper control	The auto-wiper control function can be changed	On (Rain Sensing)	Off (Intermittent)

## Personalization Features

Item	Feature	Factory Setting	Available Settings
Auto headlight off*2	The time required for headlights to turn off after ignition is switched off can be changed	30 seconds	0 seconds/60 seconds/90 seconds/120 seconds
Auto-light control	The headlight illumination on/off timing based on surrounding lightness/darkness can be changed	Medium	Light/Medium Light/Medium Dark/Dark

For the function setting procedure, Refer to Setup on page 5-55.

\*1 Setting changes using the door-lock switch can also be done. Refer to Auto Lock/Unlock Function on page 3-13.

\*2 If the setting is changed to 0 seconds, the following operation is performed according to the headlight switch position:

- At **AUTO** position: Headlights turn off immediately after the ignition is switched off.
- At any position other than **AUTO** : Headlights do not turn off after the ignition is switched off.

The following "Personalization Features" are available. These settings can only be changed by an Authorized Mazda Dealer.

Item	Feature	Factory Setting	Available Settings
Turn indicator	The turn indicator beep volume level can be changed	High	Low
Lights-on reminder	The volume of the lights-on reminder warning alarm can be changed	High	Low/Off
Blind Spot Monitoring (BSM) system	The volume of the BSM warning beep can be changed	High	Low/Off

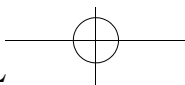
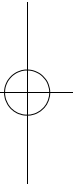
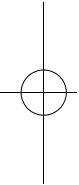
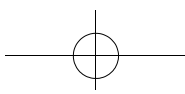

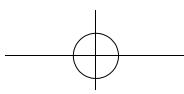

---

# **10** Index

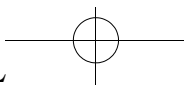
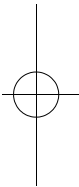
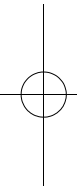

## Index

### A

Accessory Socket .....	5-100
Adaptive Front Lighting System (AFS) .....	4-44
Add-On Non-Genuine Parts and Accessories .....	8-20
Advanced Key Operational range .....	3-9
Advanced Keyless Entry System .....	3-8
Air Bag Systems .....	2-38
All-Wheel Drive (AWD) Operation .....	4-64
Ambient Temperature Display .....	4-12
Antilock Brake System (ABS) .....	4-61
Audio Control Switch Adjusting the Volume .....	5-57
Mute Switch .....	5-57
Seek Switch .....	5-57
Audio System Antenna .....	5-13
Audio Control Switch .....	5-56
Audio Set (Type A) .....	5-25
Audio Set (Type B) .....	5-35
AUX/USB/iPod mode .....	5-58
Operating Tips for Audio System .....	5-13
Satellite Radio .....	5-44
Automatic Transaxle Driving tips .....	4-39
Manual shift mode .....	4-36
Shift-lock override .....	4-35
Shift-lock system .....	4-35
Transaxle ranges .....	4-34

### B

Battery .....	6-30
Maintenance .....	6-32
Specifications .....	9-4

### B

Battery runs out .....	7-14
Jump-Starting .....	7-14
Beep Sounds Air bag/front seat belt pretensioner system warning .....	7-32
Blind spot monitoring (BSM) system warning .....	7-34
Ignition not switched off (STOP) warning .....	7-33
Key left-in-luggage compartment warning .....	7-33
Key left-in-vehicle warning .....	7-34
Key removed from vehicle warning .....	7-33
Lights-on reminder .....	7-32
Request switch inoperable warning .....	7-33
Seat belt warning .....	7-32
Tire inflation pressure warning ...	7-34
Blind Spot Monitoring (BSM) System .....	4-74
BSM OFF switch .....	4-77
BSM warning light .....	4-76
Care of radar sensors .....	4-77
Bluetooth® .....	5-77
Bluetooth® audio .....	5-89
Bluetooth® Hands-Free .....	5-84
Troubleshooting .....	5-93
Bluetooth® Audio How to use the Bluetooth® audio system .....	5-90

## Index

### B

- Bluetooth® Hands-Free
  - Cancel ..... 5-85
  - Customer Service ..... 5-89
  - DTMF (Dual Tone Multi-Frequency Signal) transmission ..... 5-88
  - Emergency calls ..... 5-87
  - Hanging up a call ..... 5-85
  - Help function use ..... 5-85
  - Making a call using a telephone number ..... 5-84
  - Making a call using the call history ..... 5-87
  - Multi-call functions ..... 5-88
  - Mute ..... 5-88
  - Phonebook usage ..... 5-85
  - Receiving an incoming call ..... 5-85
  - Returning to previous operation ..... 5-85
  - Speed dial usage ..... 5-87
  - Transferring a call ..... 5-88
- Body Lubrication ..... 6-26
- Bottle Holder ..... 5-103
- Brakes
  - Brakes assist ..... 4-58
  - Foot brake ..... 4-56
  - Pad wear indicator ..... 4-58
  - Parking brake ..... 4-57
- Break-In ..... 3-37

### C

- Capacities ..... 9-5
- Carbon Monoxide ..... 3-21
- Cargo Securing Loops ..... 5-104
- Cell Phones ..... 8-21
- Center Console ..... 5-104

### C

- Child Restraint
  - Child-restraint system installation position ..... 2-27
  - Installing child-restraint systems ..... 2-28
  - LATCH child-restraint systems ..... 2-35
- Child Safety Locks for Rear Doors ... 3-16
- Climate Control System ..... 5-2
  - Fully Automatic Type ..... 5-9
  - Gas specifications ..... 9-6
  - Manual Type ..... 5-5
  - Operating Tips ..... 5-2
  - Vent Operation ..... 5-3
- Clock ..... 5-99
- Cruise Control ..... 4-67
- Cup Holder ..... 5-102
- Customer Assistance ..... 8-2
- Customer Service (Hands-Free) ..... 5-89

### D

- Dashboard Illumination ..... 4-11
- Daytime Running Lights ..... 4-44
- Defroster
  - Mirror ..... 4-51
  - Rear window ..... 4-51
- Dimensions ..... 9-5
- Door Locks ..... 3-10
- Driving In Flooded Area ..... 3-41
- Driving on Uneven Road ..... 3-42

## Index

---

### D

Driving Tips .....	3-37
Automatic transaxle .....	4-39
Break-in .....	3-37
Driving in flooded area .....	3-41
Driving on uneven road .....	3-42
Floor mat .....	3-38
Hazardous driving .....	3-38
Money-saving suggestions .....	3-37
Overloading .....	3-41
Rocking the vehicle .....	3-39
Winter driving .....	3-39
Dynamic Stability Control (DSC) .....	4-62

### E

Emergency calls .....	5-87
Emergency Starting	
Push-Starting .....	7-17
Starting a Flooded Engine .....	7-17
Emergency Towing	
Tiedown Hooks .....	7-21
Towing Description .....	7-20
Emission Control System .....	3-20
Engine	
Coolant .....	6-22
Engine Compartment	
Overview .....	6-19
Exhaust gas .....	3-21
Hood release .....	6-17
Oil .....	6-20
Starting .....	4-3
Essential information .....	6-2
Event Data Recorder .....	8-22
Exhaust Gas .....	3-21

### E

Exterior Care .....	6-55
Aluminum Wheel	
Maintenance .....	6-59
Bright-Metal Maintenance .....	6-58
Maintaining the Finish .....	6-56
Plastic Part Maintenance .....	6-60

### F

Flasher	
Hazard warning .....	4-52
Headlights .....	4-40
Flat Tire .....	7-3
Mounting the Spare Tire .....	7-11
Removing a Flat Tire .....	7-8
Floor Mat .....	3-38
Fluid	
Brake/Clutch .....	6-24
Washer .....	6-25
Fluids	
Classification .....	9-4
Fog Lights .....	4-45
Foot Brake .....	4-56
Front Seat .....	2-4
Fuel	
Filler lid and cap .....	3-22
Gauge .....	4-11
Requirements .....	3-19
Tank capacity .....	9-5

### G

Gauges .....	4-9
Glove Compartment .....	5-104

### H

Hazard Warning Flasher .....	4-52
------------------------------	------



## Index

### H

Hazardous Driving .....	3-38
Head Restraint .....	2-11
Headlights	
Control .....	4-40
Flashing .....	4-43
High-low beam .....	4-43
Leveling .....	4-44
Hill Launch Assist (HLA) .....	4-59
HomeLink Wireless Control	
System .....	4-53
Hood Release .....	6-17
Horn .....	4-52

### I

Ignition	
Switch .....	4-2
Illuminated Entry System .....	5-98
Immobilizer System .....	3-33
Indicator Lights	
AFS OFF .....	4-28
BSM OFF .....	4-30
Cruise .....	4-29
Display indication .....	4-17
Hazard warning .....	4-29
Headlight high-beam .....	4-29
KEY .....	4-26
Lights-on .....	4-30
Low engine coolant	
temperature .....	4-28
Power steering malfunction .....	4-22
Security .....	4-29
Shift position .....	4-28
TCS OFF .....	4-28
TCS/DSC .....	4-27
Turn signal .....	4-29
Warning .....	4-17

### I

Inspecting Brake/Clutch Fluid	
Level .....	6-24
Inspecting Coolant Level .....	6-22
Inspecting Engine Oil Level .....	6-21
Inspecting Washer Fluid Level .....	6-25
Instrument Cluster .....	4-9
Interior Care .....	6-60
Cleaning the Lap/Shoulder Belt	
Webbing .....	6-62
Cleaning the Upholstery and Interior	
Trim .....	6-60
Cleaning the Window Interiors...	6-62
Dashboard Precautions .....	6-60
Interior Lights .....	5-97
Luggage Compartment Light .....	5-97
Map Lights .....	5-97
Overhead Lights .....	5-97

### J

Jack .....	7-5
Jump-Starting .....	7-14

### K

Key Suspend Function .....	3-7
Keyless Entry System .....	3-3
Keys .....	3-2
Key suspend function .....	3-7
Transmitter .....	3-4

### L

Label Information .....	9-2
Lane-Change Signals .....	4-45
Liftgate .....	3-16

## Index

---

### L

- Light Bulbs
  - Replacement ..... 6-40
  - Specifications ..... 9-6
- Lighting Control ..... 4-40
- Lubricant Quality ..... 9-4
- Luggage Compartment ..... 5-105
- Luggage Compartment Light ..... 5-97

### M

- Maintenance and Care ..... 6-2
- Manual Transaxle Operation ..... 4-31
  - Recommendations for shifting... 4-32
- Map Lights ..... 5-97
- Meters and Gauges ..... 4-9
- Mirror Defroster ..... 4-51
- Mirrors
  - Outside mirrors ..... 3-25
  - Rearview mirror ..... 3-26
- Money-Saving Suggestions ..... 3-37

### O

- Odometer and Trip Meter ..... 4-10
- Outside Mirrors ..... 3-25
- Outside Temperature Display ..... 4-12
- Overhead Console ..... 5-103
- Overhead Lights ..... 5-97
- Overheating ..... 7-18
- Overloading ..... 3-41
- Owner Maintenance
  - Closing the Hood ..... 6-18
  - Engine Compartment
    - Overview ..... 6-19
    - Opening the Hood ..... 6-17
  - Owner Maintenance
    - Precautions ..... 6-15
    - Replace Electrical Battery ..... 6-32

### P

- Parking Brake ..... 4-57
- Personalization Features ..... 9-8
- Power Steering ..... 4-66
- Power Windows ..... 3-28

### R

- Rear Coat Hooks ..... 5-105
- Rear Door Child Safety Locks ..... 3-16
- Rear Seat ..... 2-7
- Rear View Monitor ..... 4-78
- Rear Window Defroster ..... 4-51
- Rear Window Washer ..... 4-50
- Rear Window Wiper ..... 4-50
- Rearview Mirror ..... 3-26
- Recommended Oil ..... 6-20
- Recreational Towing ..... 7-23
- Registering Your Vehicle in A Foreign Country ..... 8-19
- Replacement
  - Electrical battery ..... 6-32
  - Fuse ..... 6-49
  - Light Bulbs ..... 6-40
  - Tires ..... 6-37
  - Wheel ..... 6-38
  - Wiper ..... 6-26
- Rocking the Vehicle ..... 3-39

### S

- Safety Defects, Reporting ..... 8-15
- Satellite Radio ..... 5-44
- Scheduled Maintenance ..... 6-3

## Index

### S

Seat Belt System	
3-point type .....	2-16
Automatic locking .....	2-15
Emergency locking .....	2-15
Extender .....	2-20
Pregnant women .....	2-15
Seats	
Front seat .....	2-4
Head restraint .....	2-11
Rear seat .....	2-7
Seat warmer .....	2-6
Security System	
Immobilizer system .....	3-33
Theft-deterrent system .....	3-35
Service Publications .....	8-49
Spare Tire .....	7-5
Specifications .....	9-4
Speedometer .....	4-10
SRS Air Bags	
Driver and front passenger occupant classification system .....	2-53
How the SRS air bags work .....	2-46
Limitations to SRS air bag .....	2-51
Monitoring .....	2-59
SRS air bag deployment criteria .....	2-50
Supplemental restraint system components .....	2-45
Starting the Engine .....	4-3
Steering Wheel .....	3-24
Horn .....	4-52
Storage Compartments .....	5-103
Cargo securing loops .....	5-104
Center console .....	5-104
Glove compartment .....	5-104
Luggage Compartment .....	5-105
Overhead console .....	5-103
Rear coat hooks .....	5-105

### S

Sunshade .....	3-32
Sunvisors .....	5-96

### T

Tachometer .....	4-11
Theft-Deterrent System .....	3-35
Tiedown	
Hook .....	7-21
Tire Information .....	8-25
Tire Pressure Monitoring System .....	4-70
Tires .....	6-35
Flat Tire .....	7-3
Replacing a Tire .....	6-37
Replacing a Wheel .....	6-38
Snow tires .....	3-40
Specifications .....	9-7
Temporary Spare Tire .....	6-37
Tire chains .....	3-40
Tire Inflation Pressure .....	6-35
Tire Rotation .....	6-36
Uniform tire quality grading system (UTQGS) .....	8-23
Towing	
Recreational towing .....	7-23
Trailer Towing (U.S.A. and Canada) .....	3-43
Towing Description .....	7-20
Traction Control System (TCS) .....	4-61
TCS OFF switch .....	4-62
Transmitter .....	3-4
Trip Computer .....	4-13
Trip Meter .....	4-10

## Index

---

### T

#### Trouble

Battery runs out .....	7-14
Emergency Starting .....	7-17
Emergency Towing .....	7-20
Flat Tire .....	7-3
Overheating .....	7-18
Parking in an Emergency .....	7-2
Warning/indicator lights and warning sounds .....	7-24
When liftgate cannot be opened .....	7-35
Turn and Lane-Change Signals .....	4-45

### V

Vanity Mirrors .....	5-96
Vehicle Information Labels .....	9-2

### W

#### Warning Lights

ABS .....	4-18
Air bag system .....	4-22
Automatic transaxle .....	4-21
AWD .....	4-21
Brake system .....	4-17
Charging system .....	4-19
Check engine .....	4-20
Check fuel cap .....	4-23
Display indication .....	4-17
Door-ajar .....	4-24
Engine oil pressure .....	4-19
Front seat belt pretensioner system .....	4-22
High engine coolant temperature .....	4-20
KEY .....	4-26
Low fuel .....	4-23
Low washer fluid level .....	4-25
Master .....	4-18
Seat belt .....	4-23
Tire pressure monitoring system .....	4-25
Warning .....	4-17
Warning/Buzzer .....	7-24
Warranty .....	8-17
Weights .....	9-5
Windows	
Power windows .....	3-28
Windshield Washer .....	4-50
Windshield Wipers .....	4-47
Winter Driving .....	3-39
Wiper	
Replacing Rear Window Wiper Blade .....	6-28
Replacing Windshield Wiper Blades .....	6-27