

## Your Owner's Manual

☰ Electronic version available on the Internet

<http://go.skoda.eu/owners-manuals>



ŠKODA KAMIQ 07.2019  
Angličtina/English



658012720AA

# OWNER'S MANUAL

## ŠKODA KAMIQ



**ŠKODA**  
SIMPLY CLEVER





## Vehicle owner

### First Vehicle owner

This vehicle with the registration plate

belongs to:

Title, name/company:

-----

Address:

-----

-----

Telephone:

-----

ŠKODA Partner:

### Second Vehicle owner

This vehicle with the registration plate

belongs to:

Title, name/company:

-----

Address:

-----

-----

Telephone:

-----

ŠKODA Partner:

Service consultant:

-----

Telephone:

-----

Service consultant:

-----

Telephone:

-----



658012720AA

**Table of Contents**

<b>1</b>	<b>Vehicle owner</b>	29	Rear armrest
<b>5</b>	<b>About the Owner's Manual</b>	29	Seat heating
<b>5</b>	<b>About the Owner's Manual</b>	30	Steering wheel
<b>6</b>	<b>Explanations</b>	30	Heated steering wheel
<b>7</b>	<b>Vehicle overviews</b>	31	Interior rear-view mirror
7	Front vehicle area	31	Exterior mirror
8	Rear vehicle area	<b>32</b>	<b>Restraint systems and airbags</b>
9	Driver's seat	32	Seat belts
9	Centre console and passenger seat	33	Child seat
10	Engine compartment	35	Fasteners for child seats
<b>10</b>	<b>Indicator lights</b>	37	Airbags
10	Functionality	37	Key switch for the front passenger airbag
10	Indicator light overview	<b>39</b>	<b>Lighting, windscreen wipers and washers</b>
<b>13</b>	<b>Correct and safe</b>	39	Exterior lighting
13	Introductory notes for correct use	41	COMING HOME, LEAVING HOME exterior lighting
13	New vehicle or new parts	41	Light Assist high-beam assist system
13	Regular checks	42	Replace light bulbs
13	No improper vehicle adjustments	43	Interior lighting
13	Keeping sensors and cameras in working order	43	Interior ambient light
14	Engine compartment	43	Windscreen wipers and washers
14	Vehicle battery	<b>46</b>	<b>Heating and air conditioning system</b>
14	Using electrical sockets in the vehicle	46	Heating
14	Before your journey	46	Manual air conditioning
16	Safe driving	47	Climatronic automatic air conditioning system
17	Emergency call	<b>48</b>	<b>Driver information system</b>
18	After an accident	48	Analogue instrument panel
<b>19</b>	<b>Keys, locks and alarm system</b>	49	Digital instrument cluster
19	Key	50	Instrument cluster display
19	Central locking	51	Driving data
21	Keyless locking (KESSY)	52	Speed limit warning
22	Alarm system	52	Vehicle condition
<b>23</b>	<b>Doors, windows and boot lid</b>	<b>53</b>	<b>Infotainment Swing</b>
23	Doors	53	Infotainment overview
23	Child safety lock on the rear doors	53	System
23	Protective door strip	55	Screen
24	Window - with manual operation	55	Infotainment keyboard
24	Window - with electrical operation	56	Radio
25	Sunblind - with electrical operation	58	Media
25	Sun visors	61	Mobile device management
25	Heated windscreen	62	Telephone
26	Boot lid - with manual operation	64	Wi-Fi
26	Boot lid - with electrical control	65	SmartLink
27	Unlocking the boot lid	67	ŠKODA Connect online services
<b>28</b>	<b>Seats, steering wheel and mirror</b>	<b>69</b>	<b>Infotainment Bolero</b>
28	Front seat - with manual operation	69	Infotainment overview
28	Front seat - with electrical operation	69	System
28	Rear seats	71	Screen
29	Headrests	71	Infotainment keyboard
29	Front armrest	72	Radio
		74	Media
		77	Mobile device management
		78	Telephone



80	Wi-Fi	135	Exhaust control system
81	SmartLink	135	Fuel filter
83	ŠKODA Connect online services	135	Fuel filler flap
<b>85</b>	<b>Infotainment Amundsen</b>	135	AdBlue
85	Infotainment overview	136	Petrol
85	System	138	Diesel
87	Screen	<b>139</b>	<b>Vehicle battery and fuses</b>
88	Infotainment keyboard	139	Vehicle battery
89	Voice control	140	Using the jump-starting cable
90	Radio	141	Fuses
92	Media	141	Fuses in the dash panel
95	Images	143	Fuses in the engine compartment
96	User management	<b>144</b>	<b>Wheels</b>
97	Mobile device management	144	Tyres and rims
98	Telephone	145	All-season or winter tires
101	Wi-Fi	145	Snow chains
103	SmartLink	145	Spare and emergency spare wheel
105	ŠKODA Connect online services	146	Changing the wheel and raising the vehicle
106	Navigation	147	Breakdown kit
<b>111</b>	<b>Starting and driving</b>	149	Tyre pressure
111	Starting with the key	149	Tyre pressure monitoring system
112	Start at the push of a button	150	Wheel bolt cover caps
112	Starting issues	150	Full wheel frame
113	START STOP	<b>151</b>	<b>Storage space and interior equipment</b>
113	Manual gearbox	151	Equipment in the boot
114	Automatic gearbox	151	Emergency equipment
115	Vehicle driving mode	151	Fasteners in the boot
116	Economical driving style	152	Fastening nets
117	Towing a trailer	153	Storage pocket
118	Towing eye and towing procedure	153	Net partition
118	Brakes	153	Double-sided floor covering
119	Handbrake	153	Removable light
<b>120</b>	<b>Driver assist systems</b>	154	Rigid boot cover
120	Braking and stabilising systems	154	Variable loading floor in the boot
121	Front Assist	155	Overview of passenger compartment
121	Pedestrian detection system	156	Storage compartment under the front seat
122	Speed limiter	156	Storage compartment for an umbrella
123	Cruise control system	156	Phonebox
124	Adaptive Cruise Control (ACC)	157	Cup holder
126	Lane Assist	157	Multimedia holder
126	Lane change assist system Side Assist	157	Waste container
127	Crew Protect Assist proactive occupant protection	157	Ashtray and cigarette lighter
128	Driver Alert fatigue detection assistant	158	Folding table
<b>128</b>	<b>Park Assist systems</b>	158	12-Volt power socket
128	Park Pilot parking aid	<b>159</b>	<b>Roof rack and hitch</b>
129	Rear view camera	159	Roof rack
130	Rear Traffic Alert	159	Swivelling hitch
130	Park steering assistant	<b>161</b>	<b>Maintaining and cleaning</b>
<b>132</b>	<b>Engine, exhaust system and fuel</b>	161	Service events
132	Bonnet	161	Service work, adjustments and technical changes
133	Engine oil	162	Interior
133	Coolant	162	Exterior
134	Engine electronics		
135	Particle filter		

## 4 Table of Contents

### 164 Technical data and specifications

- 164 Requirements for the technical data
- 164 Vehicle identification data
- 165 Maximum permissible weights
- 165 Operating weight
- 166 Vehicle dimensions
- 166 Engine specifications
- 167 Event Data Recorder
- 168 Information about the radio systems in the vehicle
- 168 Rights arising from defective performance, ŠKODA Warranty for new cars, ŠKODA Mobility Warranty and Optional ŠKODA Extended Warranty

### 170 Index

## About the Owner's Manual

### General

This Owner's Manual applies to all **chassis variants** of the vehicle, including all **models** and **trim levels**.

All possible **trim levels** are described here without identifying them as special trims, model variants or market-dependent equipment. This means that **not all the trim components** described in this Owner's Manual are available in your vehicle.

The **images** in this Owner's Manual are for illustrative purposes only. The images may differ from your vehicle; these are for general information purposes only.

ŠKODA AUTO is constantly working on the further development of all vehicles. It is therefore possible for changes to be made at any time to the scope of delivery in terms of shape, equipment and technology. The information contained in this Owner's Manual corresponds to the information available at the time of going to press.

No legal claims can therefore be derived from the technical data, illustrations and information in this Owner's Manual.

### Electronic version of the Owner's Manual

The printed Owner's Manual contains the most important information regarding vehicle operation and vehicle maintenance.

Complete information is included in the electronic version of the Owner's Manual. This is available on the ŠKODAweb pages as well as in the mobile application MyŠKODA, which can be downloaded.



► <http://go.skoda.eu/owners-manuals>

## About the Owner's Manual

### General

This Owner's Manual applies to all **chassis variants** of the vehicle, including all **models** and **trim levels**.

All possible **trim levels** are described here without identifying them as special trims, model variants or market-dependent equipment. This means that **not all the trim components** described in this Owner's Manual are available in your vehicle.

The **images** in this Owner's Manual are for illustrative purposes only. The images may differ from your vehicle; these are for general information purposes only.

ŠKODA AUTO is constantly working on the further development of all vehicles. It is therefore possible for changes to be made at any time to the scope of delivery in terms of shape, equipment and technology. The information contained in this Owner's Manual corresponds to the information available at the time of going to press.

No legal claims can therefore be derived from the technical data, illustrations and information in this Owner's Manual.

## Explanations

---

### Terms used

**“Specialist garage”** - A workshop that carries out specialist service tasks for ŠKODA vehicles. A specialist can be a ŠKODA Partner, a ŠKODA Service Partner, or an independent workshop.

**“ŠKODA Service Partner”** - A workshop that has been contractually authorised by ŠKODA AUTO or its distribution partner to perform service work on ŠKODA vehicles and to sell ŠKODA Genuine Parts.

**“ŠKODA Partner”** - A company that has been contractually authorised by ŠKODA AUTO or its distribution partner to sell new ŠKODA vehicles and, when applicable, to service them using ŠKODA Genuine Parts and sell ŠKODA Genuine Parts.

### Text notes

**“Press”** - short press (e.g. a button) within 1 second

**“Hold”** - long press (e.g. a button) for more than 1 second

### Direction indications

All direction indications, such as “left”, “right”, “front”, “rear”, relate to the forwards direction of travel of the vehicle.

#### **DANGER**

Texts with this symbol indicate dangerous situations which, if the safety instructions are not observed, will result in death or serious injury.

#### **WARNING**

Texts with this symbol indicate dangerous situations which, if the safety instructions are not observed, could result in death or serious injury.

#### **CAUTION**

Texts marked with this symbol indicate dangerous situations which, if the safety instructions are not observed, could result in minor or moderate injury.

#### **NOTICE**

Texts with this symbol indicate situations which, if the corresponding instructions are not observed, will result in damage to the vehicle.

 Texts with this symbol contain additional information.

## Vehicle overviews

### Front vehicle area

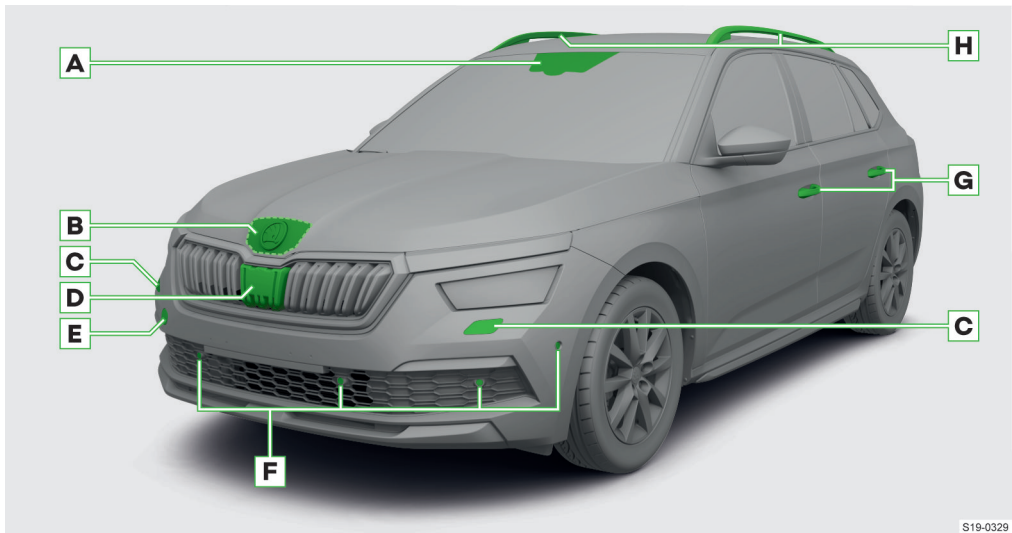

S19-0329

- A** Under the windscreen
    - ▶ Camera for assist systems
    - ▶ Light sensor for automatic driving light circuit » [page 39](#)
    - ▶ Rain sensor for automatic wiping » [page 44](#)
  - B** Bonnet release lever (under the flap) » [page 132](#)
  - C** Headlight washers » [page 44](#)
  - D** Front radar sensor for assist systems
  - E** Cover for screw-in towing eye socket » [page 118](#)
  - F** Ultrasonic sensors for assist systems
  - G** Door handles
    - ▶ Open the door » [page 23](#)
    - ▶ Keyless locking (KESSY) » [page 21](#)
  - H** Roof rails » [page 159](#)
- › Keep the sensors and cameras for the assist systems clean » [page 13](#).



## Rear vehicle area

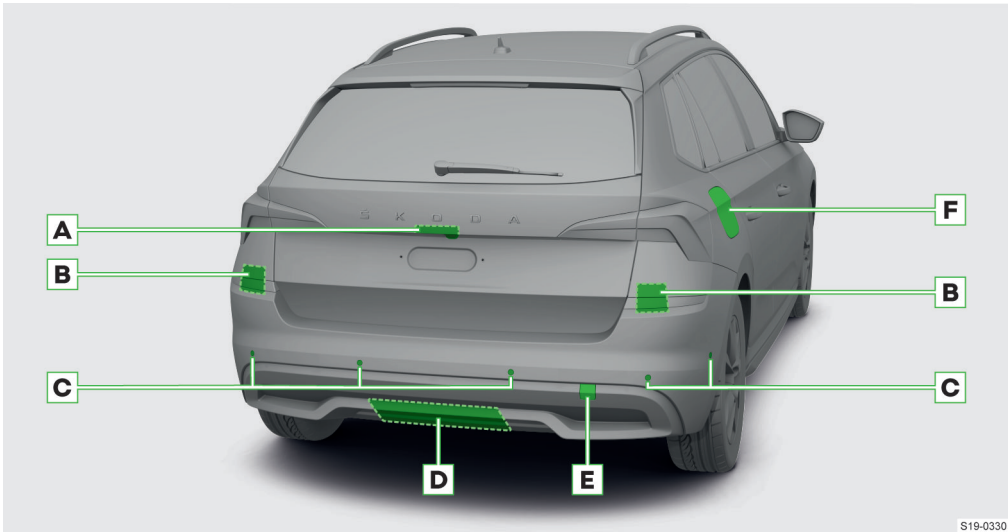

S19-0330

- A** Handle of the boot lid
    - ▶ Manually operated boot lid » [page 26](#)
    - ▶ Electrically operated boot lid » [page 26](#)
    - ▶ Camera for assist systems
  - B** Radar sensors for assist systems (in the bumper)
  - C** Ultrasonic sensors for assist systems
  - D** Swivelling hitch » [page 159](#)
  - E** Cover for screw-in towing eye socket » [page 118](#)
  - F** Fuel filler flap » [page 135](#)
    - ▶ Sticker with tyre pressures » [page 149](#)
    - ▶ Sticker with prescribed fuel
    - ▶ Ice scraper
    - ▶ Filler neck of the AdBlue® tank » [page 136](#)
- › Keep the sensors and cameras for the assist systems clean » [page 13](#).

## Driver's seat

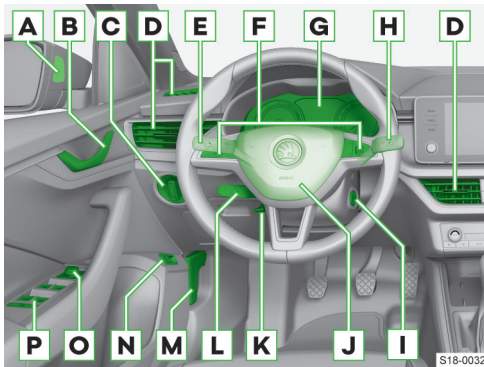

- A** Side Assist lane change assist system indicator light » [page 126](#)
- B** Door opening lever » [page 23](#)
- C** Light switch » [page 39](#)
- D** Air outlet nozzle
- E** Control lever:
  - ▶ Flashing and high beam » [page 39](#)
  - ▶ Cruise control » [page 123](#)
  - ▶ Speed limiter » [page 122](#)
  - ▶ High-beam assist system » [page 41](#)
- F** Buttons/dials on the multifunction steering wheel » [page 50](#)
- G** Depending on the equipment:
  - ▶ Analogue instrument cluster » [page 48](#)
  - ▶ Digital instrument cluster » [page 49](#)
- H** Control lever:
  - ▶ Windscreen wipers and washers » [page 44](#)
  - ▶ Information system » [page 50](#)
- I** Depending on the equipment:
  - ▶ Ignition lock » [page 111](#)
  - ▶ Starter button » [page 112](#)
- J** Steering wheel with horn/with driver's front air-bag » [page 37](#)
- K** Safety lever for steering wheel adjustment » [page 30](#)
- L** Operation of the automatic distance control » [page 124](#)
- M** Bonnet release lever » [page 132](#)
- N** Button for the electric boot lid » [page 26](#)
- O** Exterior mirror operation » [page 31](#)
- P** Window operation » [page 24](#)

## Centre console and passenger seat

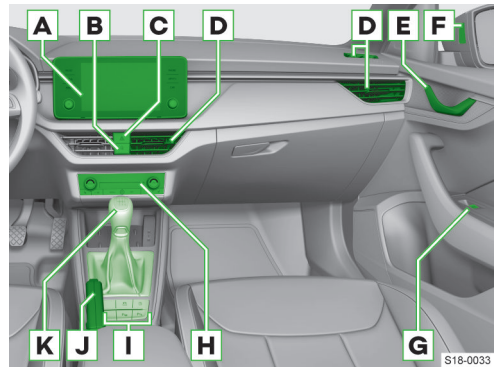

- A** Infotainment (depending on trim level):
  - ▶ Amundsen » [page 85](#)
  - ▶ Bolero » [page 69](#)
  - ▶ Swing » [page 53](#)
- B** Central locking button » [page 20](#)
- C** Hazard warning system button » [page 39](#)
- D** Air outlet nozzle
- E** Door opening lever » [page 23](#)
- F** Side Assist lane change assist system indicator light » [page 126](#)
- G** Window operation in the passenger door » [page 24](#)
- H** Operation (depending on the trim level):
  - ▶ Heating » [page 46](#)
  - ▶ Manual air conditioning » [page 46](#)
  - ▶ Climatronic » [page 47](#)
- I** Buttons (depending on the equipment):
  - ▶ START-STOP » [page 113](#)
  - ▶ Park Pilot » [page 128](#)
  - ▶ Park Assist » [page 130](#)
  - ▶ Driving mode selection » [page 115](#)
- J** Parking brake » [page 119](#)
- K** Depending on the equipment:
  - ▶ Shift lever (manual transmission) » [page 113](#)
  - ▶ Selector lever (automatic transmission) » [page 114](#)

## Engine compartment

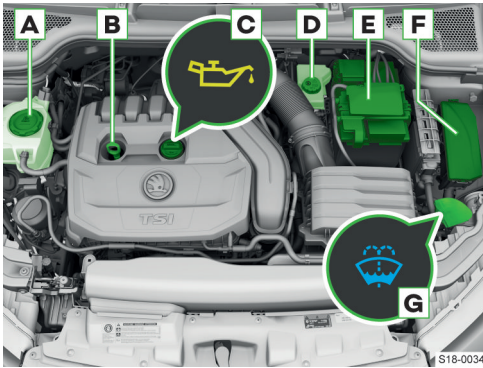

- A** Coolant expansion tank » page 134
- B** Engine oil dipstick » page 133
- C** Engine oil filler opening » page 133
- D** Brake fluid reservoir » page 119
- E** Vehicle battery » page 139
- F** Fuse box » page 143
- G** Windscreen washer fluid reservoir » page 44

## Indicator lights

### Functionality

The indicator lights in the instrument cluster indicate the current status of certain functions or faults.

The illumination of some of the indicator lights may be accompanied by acoustic signals and messages in the instrument cluster display.

### Colour display of the indicator lights

Depending on the vehicle equipment, the colour scheme of the indicator lights may vary. The coolant indicator light can, e.g. be shown in colour as follows.

↕ - colour display

⬇ - black and white display

### Additional indicator lights

Depending on the meaning, the additional indicator light will also light up in the display along with some of the indicator lights.

⚠ - Danger

⚠ - Warning















### ⚠ WARNING



















Ignoring the illuminated indicator lights and associated messages on the instrument cluster display may result in accidents, serious injury or damage to the vehicle.

### Indicator light overview





















After switching on the ignition, some indicator lights for the functional test of the vehicle systems light up briefly. If the tested systems are in order, the respective indicator lights go out a few seconds after the ignition is switched on or after the engine has been started.













Symbol	Meaning
	Indicates a warning together with another warning light » page 10.
	Vehicle battery is not charging » page 140.
	Along with ↕ - Engine fault » page 134, » page 140.
	Coolant level is too low » page 134.
	Coolant temperature too high » page 134.
	ACC does not decelerate sufficiently » page 124.
	Parking brake on » page 119.

Symbol	Meaning
	Automatic gearbox overheated » page 115.
	Automatic gearbox impaired » page 115.
	Front seat belt not fastened » page 32.
	Brake fluid level is too low » page 119.
	Together with  - Brake system and ABS faulty » page 121.
	Warning if there is a risk of a collision » page 121.
	Engine oil level too low » page 133.
	Engine oil pressure too low » page 133.
	<b>Flashing</b> - Steering lock faulty » page 30.
	<b>Illuminates</b> - Power assisted steering faulty » page 30.
	Indicates a warning along with another warning light » page 10.
	ACC not available » page 125.
	<b>Flashing</b> - Diesel engine control faulty » page 135.
	<b>illuminates</b> , if relevant, does not illuminate after switching on the ignition - Diesel preheating system faulty » page 135.
<b>OFF</b> 	Front passenger airbag switched off » page 38.
	Front passenger airbag switched on » page 38.
<b>ON</b> 	<b>Flashes</b> together with <b>OFF</b>  - Key switch for airbag deactivation faulty » page 38.
	Airbag system faulty » page 37.
	<b>Illuminates</b> 4 s - Front passenger airbag deactivated with key switch » page 38.
	<b>Illuminates</b> for 4 seconds and then <b>flashes</b> - Airbag or belt tensioner deactivated with diagnostic device » page 37.
	Crew Protect Assist faulty » page 128.

Symbol	Meaning
	ASR deactivated » page 120.
	ABS faulty » page 120.
	<b>Illuminates</b> - ESC or ASR faulty » page 120.
	<b>Flashing</b> - ESC or ASR is engaged » page 120.
	Clogged particle filter » page 135.
	Front Assist deactivated » page 121.
<b>EPC</b>	Petrol engine control faulty » page 134.
	Tyre pressure change » page 145, » page 149.
	Tyre pressure control system faulty » page 150.
	Emission control system faulty » page 135.
	Lane Assist intervenes » page 126.
	Lane Assist intervenes » page 126.
	Engine oil level too high or engine oil level sensor impaired » page 133.
	Ball rod not locked » page 160.
	Windscreen washer fluid level too low » page 45.
	Automatic gearbox overheated » page 115.
	The fuel supply has reached the reserve area. » page 137, » page 139.
	<b>Illuminates</b> - Power assisted steering faulty » page 30.
	<b>Flashing</b> - Steering lock not unlocked » page 30.
	<b>Flashing</b> - Steering lock faulty » page 30.
	Bulb faulty » page 41.
	Rear fog light switched on » page 40.
	Water in the diesel fuel filter » page 135.

## 12 Indicator lights › Indicator light overview

Symbol	Meaning
	Shock absorber faulty » page 116.
	Automatic gearbox impaired » page 115.
	ACC controls the driving speed » page 124.
	Speed limiter controls the driving speed » page 122.
	The cruise control system controls the driving speed » page 123.
	ACC controls the driving speed » page 124.
	The selector lever is locked » page 114.
	Lane Assist is activated and ready to intervene » page 126.
	Lane Assist is activated and ready to intervene » page 126.
	Turn signal light, left » page 39, » page 41.
	Turn signal light, right » page 39, » page 41.
	Trailer turn signal light » page 41.
	Front fog lights switched on » page 40.
	Low outside temperature » page 50.
	High beam or flasher activated » page 39.
	Front Assist is started » page 121.
	ACC activated » page 124.
	AdBlue® level too low » page 136.
	AdBlue® system impaired » page 136.
	High beam Assist System switched on » page 41.
	Break recommendation » page 128.
	Rear seat belt not fastened » page 32.
	A rear seat belt is fastened » page 32.

Symbol	Meaning
	Safety distance too small » page 121.
	Speed limiter activated » page 122.
	Speed limiter faulty » page 123.
	Engine was switched off automatically by START-STOP » page 113.
	Engine was not automatically switched off via START-STOP » page 113.
	No light is switched on » page 39.
	Cruise control activated » page 123.
	Cruise control system faulty » page 124.
	Consumption-friendly driving » page 116.
	Driving mode Normal » page 115.
	Driving mode Sport » page 115.
	Driving mode Eco » page 115.
	Driving mode Individual » page 115.



## Correct and safe

### Introductory notes for correct use

- ▶ Read this Owner's Manual carefully, as proceeding in accordance with this manual is a prerequisite for the correct use of the vehicle. This Owner's Manual should therefore always be in the vehicle.
- ▶ When using the vehicle, the generally binding legal provisions that are specific to the country must be observed. Such as those for transporting children, switching off airbags, using tyres, road traffic and the like.
- ▶ Do not exceed the maximum permissible weights and loads.
- ▶ Do not exceed the maximum permissible roof load.
- ▶ Use the specified fuel and operating fluids.
- ▶ Drive on roads that meet the technical vehicle parameters. Obstacles that exceed the ground clearance of the vehicle can damage the vehicle when driving over them.
- ▶ Care must be taken during operations related to operation, maintenance and self-help to avoid damage to the vehicle or injury. If required, seek the help of a specialised garage.
- ▶ All work on the vehicles and safety systems e.g. on the seatbelts or the airbag system, may only be carried out by a specialist garage.
- ▶ When using accessories, please note the instructions in the accessory manufacturer's instruction manual. These include child seats, roof racks, compressors etc.
- ▶ Please note the service intervals.

### New vehicle or new parts

#### New vehicle - Running in the engine

Driving style during the first 1500 km determines the quality of the engine run-in process.

- ▶ During the first 1000 km, rev the engine to max. 3/4 of the highest permissible engine speed and avoid using a trailer.
- ▶ Over the next 500 km, the engine speed can be slowly increased.

Depending on driving style and operating conditions, the engine consumes some oil, up to 0.5 l / 1000 km. Consumption may be higher over the next 5000 km.

#### New brake pads

New brake pads do not provide the optimum braking effect during the first 200 km, they have to be worn in first. Therefore, drive very carefully.

#### New tyres

New tyres do not have optimum grip for the first 500 km. Therefore, drive very carefully.

### Regular checks

#### What should be taken into account before driving?

A vehicle with technical defects can increase the risk of accidents and injuries.

Eliminate any defects before driving. If required, seek the help of a specialised garage.

Pay special attention to the following points.

- ▶ Is the tyre undamaged?
- ▶ Is the tyre tread sufficient?
- ▶ Is the tyre pressure sufficient?
- ▶ Do the headlamps, brake and turn signals work?
- ▶ Is the windscreen in good condition?
- ▶ Is the engine oil, brake fluid and coolant level OK?
- ▶ Is the air intake in the engine compartment free from obstruction?
- ▶ Are the air outlet nozzles or air intake in front of the windscreen free from obstruction?
- ▶ Are the windscreen wiper and washer system and windscreen wiper blades functional?
- ▶ Is the windscreen washer fluid level sufficient?
- ▶ Are the windscreen wiper blades in good condition?
- ▶ Are all seatbelt system components in good working order? Are the seatbelts clean and have the buckles been unclogged?
- ▶ Is the spoiler working properly?
- ▶ Are parts and components of the vehicle still visibly attached?
- ▶ Are there no oil stains or other operating fluids under the vehicle?

### No improper vehicle adjustments

Improper modifications can cause interference and affect safety-related functions and other functions of the vehicle.

- ▶ Adjustments and technical modifications to the vehicle should only be carried out by a specialist garage.
- ▶ Do not cover the engine with additional insulation materials, e.g. a blanket.

### Keeping sensors and cameras in working order

Some functions of your vehicle are supported by sensors and cameras inside and outside the vehicle.

The rear-mounted accessories, e.g. bike rack, may affect system and camera functionality.

- ▶ Do not cover or put a sticker over the sensors and cameras and keep them clean.

- ▶ If there is damage suspected to the sensors or cameras, seek the help of a specialist garage.

## Engine compartment

### Before opening the engine compartment flap

Risk of scalding! Do not open the engine compartment flap if steam or coolant comes out of the engine compartment.

- ▶ Stop the engine and allow it to cool.
- ▶ Remove the ignition key. On vehicles with a keyless unlocking system, open the driver's door.

### When working in the engine compartment

- ▶ Keep children away from the engine compartment.
- ▶ Do not touch the radiator fan. The radiator fan can turn itself on, even when the ignition is off.
- ▶ Do not touch electrical cables. Avoid short circuits in the electrical system, especially on the vehicle battery.
- ▶ Do not smoke near the engine and refrain from handling open flames or sparks.
- ▶ If you need to work in the engine compartment with the engine running, be mindful of rotating engine parts and electrical equipment.
- ▶ Do not leave any objects in the engine compartment.

### Handling operating fluids

Your vehicle needs various fuels to operate that can affect health or the environment when they are emitted. These include fuel, oils, battery acid, coolant and brake fluid or AdBlue®.

- ▶ Only use operating fluids outdoors or in well-ventilated areas. If required, wear protective equipment.
- ▶ Do not use or check operating fluids with the engine running.
- ▶ In the event of contact with operating fluids, wash affected areas with warm water. If required, seek medical help.
- ▶ The leaked engine oil in the engine compartment can cause a fire, so wipe it off with a cloth.
- ▶ Store soiled cloths in a well-ventilated area until disposal. Cloths with residues of engine oil can ignite and cause a fire.

## Vehicle battery

### Handling the vehicle battery

Battery acid is highly corrosive. Improper handling of the vehicle battery can cause an explosion, fire, chemical burns or poisoning!

- ▶ When handling the vehicle battery, eye and skin protection must be worn.

- ▶ Do not tilt the vehicle battery, as it may leak battery acid.
- ▶ If battery acid comes into contact with skin, wash the affected areas with water for a few minutes. Get medical help without delay.
- ▶ Do not charge a frozen or thawed vehicle battery. Replace a frozen vehicle battery.
- ▶ Do not use a damaged vehicle battery.
- ▶ Short circuit! Do not connect the battery terminals.

## Using electrical sockets in the vehicle

Improper handling of sockets can lead to life-threatening electric shock or fire.

- ▶ The sockets may get hot during operation. Do not touch hot sockets.
- ▶ Protect sockets from liquids.
- ▶ If moisture gets into the socket, let the socket dry before reusing it.
- ▶ Do not insert any objects into the socket contacts.

## Before your journey

Adults and children, cargo and objects - everything has its place in the vehicle. Observe the following instructions so that all occupants are protected in the best possible way in the event of an accident.

### Before you go

- ▶ Ensure that you have a good view of outside the vehicle.
- ▶ Adjust the rearview mirrors.
- ▶ Close all doors and the engine compartment and boot flap.
- ▶ Take the correct seating position and put on the seatbelt properly. Ensure that passengers do likewise. Always leave the seatbelt on while driving.
- ▶ Only one person can be secured with a seatbelt.
- ▶ Make sure that the seatbelts are not trapped, e.g. in the door or in the seat.
- ▶ Check seatbelts, their locks and attachment points for damage.

### Sitting safely

For the safety of the occupants and to reduce the risk of injury in the event of an accident, the following instructions must be observed.

- ▶ Stand the backrests upright. If the front passenger seat backrest has been folded forward, only the seat behind the driver's seat may be used for transporting passengers.
- ▶ Engage the rear seat backrests correctly.
- ▶ Adjust the height-adjustable headrest so that the top of the headrest is as close as possible to the top of the head.

- ▶ Keep your feet in the footwell.
- ▶ Use the entire seat.
- ▶ Do not lean forward or sit to the side.
- ▶ Do not hold your limbs out the window.

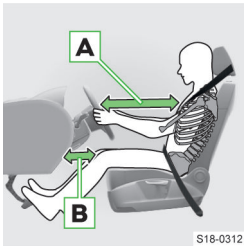

- ▶ Adjust the driver's seat in the longitudinal direction so that the pedals can be fully pushed through with slightly bent legs.
- ▶ Adjust the steering wheel so that the distance **A** between the steering wheel and sternum is at least 25

cm.

- ▶ For vehicles with driver's knee airbag, adjust the driver's seat longitudinally so that the distance **B** from the legs to the dash panel in the area of the knee airbag is at least 6 cm.
- ▶ Adjust the angle of the backrest so that the steering wheel can be reached at the top with your arms slightly bent.
- ▶ Move the passenger seat back as far as possible. The front passenger must maintain a minimum distance of 25 cm from the dash panel.

### Correct belt webbing arrangement



The webbing arrangement is extremely important for the seatbelts to offer the best possible protection.

- ▶ The shoulder belt part must run over the middle of the shoulder and rest firmly on the body.
- ▶ The lap belt part must be placed in front of the pelvis and fit tightly.
- ▶ In pregnant women, the lap belt part must be as low as possible on the pelvis, so that no pressure is exercised on the abdomen.
- ▶ The webbing must not be pinched or twisted and rub against sharp edges.
- ▶ The tongue may only be inserted into the buckle of the associated seat.
- ▶ The webbing must be tight. Therefore, do not attach clamps or similar items to the webbing for adjusting the seatbelt according to body size.

### Correct steering wheel position



- ▶ Hold the steering wheel with both hands on the outer edge in the "9 o'clock" and "3 o'clock" position. Otherwise, you may experience serious injury to the arms, hands and head when deploying the airbag.

### Be mindful of the effect of the airbag system

Airbag systems can only properly protect if all occupants have been secured and they are in the correct seating position.

No persons, animals or objects such as cup holders may be in the deployment area of the airbags » page 37.

- ▶ Do not cover or stick anything over the steering wheel or the dash panel. The front airbags were not able to deploy.

The front passenger airbag should be switched off in some situations » page 38.

### Securing children properly

- ▶ Do not carry a child on your lap, and secure the child and yourself with a seatbelt.
- ▶ Only transport children in a suitable child seat » page 34.

Children under 150 cm tall will not be properly protected without a child seat. Children that have been inadequately secured can be thrown through the vehicle in the event of an accident or a sudden manoeuvre. You can cause life-threatening injuries to yourself and other occupants.

If children lean forward or assume a wrong sitting position while driving, they are more likely to be injured in the event of an accident. This is especially true for children who are carried in the passenger seat - when the airbag system triggers, they can be seriously injured or killed!

### A child that has been incorrectly secured in the wrong sitting position - endangered by the side airbag



The child should not be in the deployment area of the side airbag.

**A child that has been properly secured in a child seat**



There must be enough room between the child and the exit area of the side airbag for the side airbag to offer the best possible protection.

S18-0111

**Transporting objects safely**

When moving heavy objects, there is a shift in emphasis. Thus, the driving behaviour of the vehicle changes.

- ▶ Adjust driving speed and driving style to this changed driving behaviour.

Unsecured or misplaced items may be thrown around in the event of an accident or sudden manoeuvre. There is a risk of serious injury and loss of control of the vehicle!

In a rear-end collision at 50 km/h unsecured objects are thrown forward with up to 50 times their weight. A 1.5 litre water bottle is thrown up to 75 kg.

- ▶ Transport objects securely.
- ▶ Stow objects so they do not hinder the driver. Keep the driver footwell clear.
- ▶ Stow small items in the storage compartments.
- ▶ Do not leave lockable storage compartments open.
- ▶ Do not let items protrude out of the slots. This note does not apply to bottles in bottle trays.
- ▶ Do not place any objects on the dash panel or on the luggage compartment cover.
- ▶ Do not exceed the maximum permissible load of fasteners and shelves.
- ▶ Distribute the load evenly in the luggage compartment and fasten it so it cannot slip.
- ▶ Place heavy objects in the luggage compartment as far forward as possible.

**Safe driving**

**Introductory notes**

- ▶ Pay attention when you are driving! As a driver, you are fully responsible for road safety.
- ▶ Always adjust driving speed to the road conditions as well as the traffic and weather conditions.

**Paying attention to warning signals**

The driver information system warns you with indicator lights and messages in the event of any faults.

Failure to follow the warnings may increase the risk of accidents and injuries.

- ▶ If the vehicle issues a warning signal, then park the vehicle safely and follow the information in the instrument cluster, and in this manual.

**Using assistance systems in a clever way**

The assistance systems are only for support and do not absolve you from your responsibility for driving the vehicle.

The assistance systems are subject to physical and technical limitations. Therefore, in certain situations, system reactions may be perceived as undesirable or delayed.

- ▶ Stay alert and be ready to intervene.
- ▶ Familiarise yourself with the assistance systems, their limitations and operating conditions.
- ▶ Activate, deactivate and adjust the assistance systems so that you have full control of the vehicle in any traffic situation.

**Driving with a substitute spare wheel or emergency wheel**

A substitute spare wheel or emergency wheel is only used to reach the nearest specialist garage.

- ▶ Inflate the wheel with the max. prescribed inflation pressure.
- ▶ Follow the instructions on the warning label on the rim.
- ▶ Do not cover the warning sign.
- ▶ Avoid full accelerations, strong braking and fast cornering.
- ▶ Do not drive with more than one mounted spare wheel.
- ▶ Avoid using snow chains on the temporary spare wheel.

**Driving with a loaded roof rack**

When transporting objects on the roof rack, the vehicle's driving behaviour changes.

- ▶ Adapt your speed and driving style to this.

**Towing a trailer**

The vehicles handling characteristics change with a trailer. The assistance systems may behave differently.

- ▶ Drive more slowly, excessive speed can lead to loss of control of the vehicle.
- ▶ Keep a larger distance from the vehicle in front.
- ▶ Do not exceed the max. vertical load and the permissible trailer load.

**Driving through water**

There must be no water ingress into the vehicle systems e.g. into the engine's air intake system!

- ▶ Therefore, determine the water depth before driving through water. The water level must not exceed the lower edge of the lower beam.

- ▶ Drive at max. walking speed. Otherwise, a wave may form in front of the vehicle, increasing the water level.
- ▶ Never stop in the water, do not drive backwards and never stop the engine.

#### Vehicle operation in different weather conditions

If you wish to operate your vehicle in countries with different weather conditions from those specified, please contact a ŠKODA Partner. They will advise you if certain precautions need to be taken to ensure the full functioning of the vehicle or to prevent damage (e.g. coolant, battery replacement, etc.).

#### Is something wrong?

- ▶ Pay attention to changes in vehicle handling.
- ▶ If in doubt about safety, stop driving and seek the help of a specialist garage.
- ▶ Unusual vibrations or the vehicle 'pulling' to the side may indicate a puncture.
- ▶ If tyre pressure loss is very quick, try to stop the vehicle carefully without heavy steering or heavy braking.
- ▶ Immediately remove foreign bodies stuck in the tyre tread.
- ▶ Do not remove foreign objects that have penetrated into the tyre. Check the tyre pressure and seek the help of a specialised garage.
- ▶ Immediately remove any objects jammed under the floor of the vehicle. These can damage the vehicle or ignite and cause a fire.

#### Parking the vehicle safely

A vehicle that has not been secured may roll away and cause accidents.

- ▶ For parking, look for a place with suitable ground. Do not park the vehicle on flammable materials such as dried leaves, spilt fuel. Hot vehicle parts can cause a fire.

Carry out the following activities in the specified order when parking.

- › Stop the vehicle and keep the brake pedal depressed.
- › Secure the vehicle with the parking brake.
- › For vehicles with an automatic gearbox, put the selector lever in the **P** position.
- › Turn off the engine.
- › For vehicles with manual transmission, engage 1st gear or reverse gear.
- › Release the brake pedal.

#### Exiting the vehicle

##### Do not leave children unattended in the vehicle!

- ▶ Children may injure themselves when handling the seats, releasing the parking brake etc.
- ▶ In emergency situations, children are not able to leave the vehicle on their own or help themselves.

- ▶ At very high or very low temperatures, there is danger to life!
- ▶ When locking the vehicle, the SAFE function switches on. As a result, no doors or windows can be opened from the inside. Turn off the SAFE function if people are left behind in the locked vehicle » page 19.

## Emergency call

#### ⚠ WARNING

Availability of a mobile network is indispensable for establishing a connection to the emergency number.

#### ⚠ WARNING

This emergency service is only available in some countries.

#### ⚠ WARNING

If the vehicle is located in an area without a functioning emergency call system infrastructure, no vehicle data shall be transmitted to the emergency call centre.

After the start of the conversation, the emergency call centre also contains information as to the accident location and the severity of the accident, the number of occupants with seatbelts on and the vehicle identification number (VIN).

Once the connection has been established, communication with the emergency call centre takes place via the loudspeaker and microphone installed in the vehicle.

#### Personal data

Personal customer data is collected, processed and used by ŠKODA AUTO in accordance with the provisions of the generally binding legal provisions in the area of personal data protection.

The current declaration on the protection of personal data can be found on the following website: <http://www.skoda-auto.com/data-privacy/>.

#### Serious accident - automatic call

In the event of an accident where the airbag or belt tensioner activates, a call is automatically started with the emergency call centre.

#### Minor accident - call option

The infotainment screen displays the option to set up a connection to the emergency call centre or breakdown service.



### Manual call

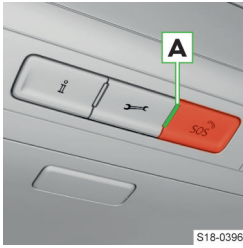

- › Keep the SOS key pressed down.
- › Confirm the connection to the emergency call centre in the Infotainment screen.

Starting a manual conversation can then be used, for example, if you also report an accident in

which you are not directly involved.

### Indicator light

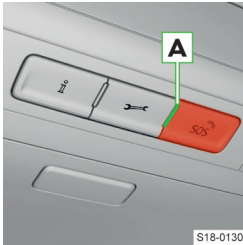

The system state is displayed after the ignition is switched on by the warning light **A** illuminating.

- ▶ Green - lit up - the system is functional.
- ▶ Green - flashing - a call is being made to the emergency call centre.
- ▶ Red - lit up - if there is a system failure, immediately seek the help of a specialist garage.
- ▶ Not lit up - the system is out of order due to a long term unavailable mobile network, if this circumstance persists, the system will require the assistance of a specialist garage.

### ⚠ WARNING

If there is a system fault, no emergency call is possible.

## After an accident

### Safety systems

After an accident, the safety systems of the vehicle, e.g. seatbelts and airbag system, may be out of action.

- ▶ Have the vehicle's safety systems checked by a specialist garage, even if no load or trip has occurred.
- ▶ Have damaged, loaded or triggered components of the safety systems replaced by a specialist garage.

## Keys, locks and alarm system

### Key

#### Key Overview

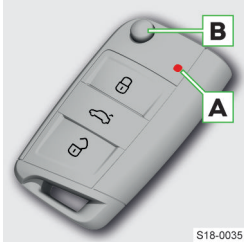

- Locking the vehicle
- Operate the boot lid
- Unlocking the vehicle
- A** Battery status warning lamp
- B** Locking button for folding the key bit in/out

#### ⓘ NOTICE

- ▶ Protect the key from moisture and strong vibrations.
- ▶ Keep the grooves in the key clean.

**i** The effective range of the key is about 30m. The effective range of the key can be reduced, e.g. due to signal interference from other transmitters.

#### Troubleshooting

##### The battery in the key is almost empty

- ▶ After pressing a button on the key, the warning light does not flash.

Or:

- ▶ A message stating it is necessary to change the battery will be displayed.
- › Replace the battery » [page 19](#).

##### The vehicle cannot be unlocked or locked with the remote control

There may be the following reasons.

- ▶ The battery in the key is empty.
- › Replace the battery » [page 19](#).

- ▶ The key is not synchronized.

Synchronize the key as follows.

- › Press one of the buttons on the key.
- › Unlock the door within 1 minute with the key via the locking cylinder » [page 20](#).

**i** If necessary, the key must be synchronized if one of the buttons on the key has been repeatedly pressed outside of the effective range of the remote control.

#### Changing the key battery

The new battery must comply with the specification of the original battery.

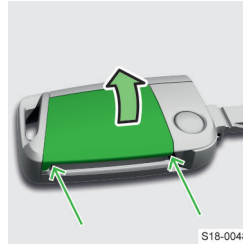

- › Fold out the key bit.
- › Release the battery cover with your thumbnail or by inserting a flat-head screwdriver at the marked points.
- › Open the battery cover.

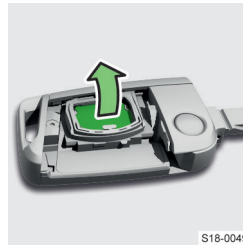

- › Remove the battery.
- › Press any button on the remote key to reset the key.
- › Insert the new battery.
- › Fit the battery cover and press until it clicks into place.

### Central locking

#### Functionality

##### Central locking system

The system unlocks and locks all doors, the fuel filler flap and the boot lid at the same time.

**Unlock indicator:** double flashing of the indicator lights.

**Lock indicator:** single flashing of the indicator lights.

The warning light in the driver's door will flash for about 2 seconds in quick succession after the vehicle is locked, then it will start flashing regularly at longer intervals.

**i** If none of the doors or the boot lid is opened within 45 seconds of unlocking, the vehicle automatically locks again.

##### SAFE function

Depending on the equipment, the SAFE function can be integrated into the central locking system.

The SAFE function prevents the doors from opening from the inside once the vehicle is locked.

The SAFE function switches on when the vehicle is locked.

In the display of the instrument cluster after the ignition is switched off, a message regarding the SAFE function is displayed.

**⚠ DANGER**

Risk of death!

When the vehicle is locked and the SAFE function is switched on, nobody is allowed to remain in the vehicle.

**Turn off the SAFE function**

▶ By double locking within 2 seconds.

Or:

▶ Together with the deactivation of the interior monitoring » page 22, Settings.

The warning light in the driver's door will flash for about 2 seconds in quick succession after the vehicle is locked, then goes out and starts flashing regularly at longer intervals after about 30 secs.

When the SAFE function is switched off, the door can be opened from the inside by pulling once on the opening lever.

The SAFE function is switched on again after unlocking and locking the vehicle.

**Operation**

**Ways in which central locking operates**

Depending on the equipment:

- ▶ Key » page 19
- ▶ Keyless locking (KESSY) » page 21
- ▶ Central locking button

**Central locking button**

The button locks all of the doors and the boot lid.

Locking and unlocking

▶ The  button in the middle part of the control panel.

The  symbol in the button comes on when locked.

Unlocking of the vehicle also takes place when opening a door from the inside or when removing the key from the ignition.

**⚠ WARNING**

A locked vehicle with a central locking button makes it difficult for responders to enter the vehicle in an emergency.

**Setting the unlocking and locking function**

The lock and unlock functions are set in the following menu in the Infotainment system.

**CAR** >  > 

Or:

**MENU** >  >  > 

**All doors**

Unlocking of all doors, the boot lid and the fuel filler flap.

**Single door**

Using the  button on the key, the driver's door and the fuel filler flap are unlocked.

In vehicles equipped with a keyless unlocking system, the door near to which the key is located and the fuel filler flap are unlocked by touching the door handle.

When unlocked again, the other doors and the boot lid are unlocked.

**Doors on a vehicle side**

Using the  button on the key, the doors on the driver's side and the fuel filler flap are unlocked.

In vehicles equipped with a keyless unlocking system, the doors on the passenger's side near to which the key is located and the fuel filler flap are unlocked by touching the door handle.

When unlocked again, the other doors and the boot lid are unlocked.

**Automatic locking after starting**

After starting, all doors and the boot lid are locked when a speed of 15 km/h is reached.

Unlocking of the vehicle takes place when opening a door from the inside or when removing the key from the ignition.

**⚠ WARNING**

An automatically locked vehicle makes it difficult for responders to enter the vehicle in an emergency.

**Troubleshooting**

**Central locking fault**

- ▶ The warning light in the driver's door first flashes for 2 secs in quick succession.
- ▶ Then it lights up continuously.
- ▶ After 30 secs, it flashes slowly.
- ▶ Seek the help of a specialist garage.

**Emergency unlocking and emergency locking of the door**

**Unlocking and locking the door with the lock cylinder**

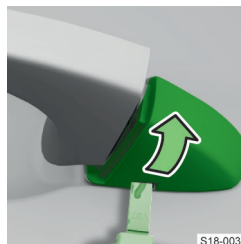

- Remove the cover
- ▶ Pull the handle on the front left door and hold it in place.
- ▶ Insert the key into the recess on the underside of the cover.
- ▶ Open the cover in the direction of the arrow.

S18-0037

- › Release the door handle.

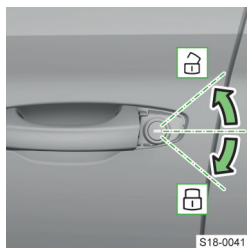

Locking and unlocking

- › Insert the key into the lock cylinder and unlock or lock it.

Install cover

- › Pull on the door handle and hold it.
- › Replace the cover.
- › Release the door handle.

S18-0041

### Locking the door without the lock cylinder

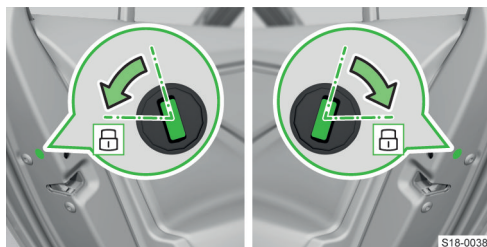

S18-0038

- › Open the door.
- › For vehicles with a panel over the opening, remove the panel.
- › Insert the key or a flat-head screwdriver into the slot.
- › Turn the key or flat-head screwdriver towards the outside of the vehicle (spring-loaded position).

After closing, the door is locked.

## Keyless locking (KESY)

### Usage

The keyless locking system, KESY, enables unlocking and locking of the vehicle without actively using the remote control key.

### Operation

Keep the key with you when unlocking and locking.

The sensors on the handle are intended to be operated with bare hands, e.g. wearing gloves may affect the function of the sensors.

### Unlocking

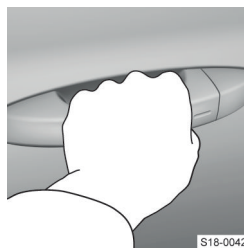

S18-0042

- › Grab the door handle.
- › Open the door.

### Lock

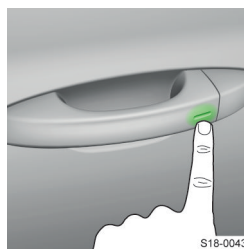

S18-0043

- › Touch the sensor.

After locking, it is not possible to unlock within 2 seconds by touching the door handle. This can be used to check whether the vehicle is locked.

### Unlocking the boot lid

- › Press the handle of the boot lid.

### Protection against accidentally locking the key inside the vehicle

If the key is locked inside the vehicle, the vehicle will unlock itself automatically. If no door is opened within 45 seconds, the vehicle automatically locks again.

If the key is locked in the luggage compartment, the luggage compartment lid will automatically unlock itself.

### Deactivating keyless unlocking and locking

- › Lock the vehicle with the button  on the key.
- › Within 5 s, touch the sensor on the door handle with your finger.

Deactivation is confirmed by a single flash of the direction indicators.

- › To check the deactivation, wait at least 10 seconds and then pull the door handle.

The door must remain locked.

Keyless unlocking and locking is automatically activated once again after the vehicle is unlocked.

### Troubleshooting

#### The vehicle cannot be unlocked or locked using the sensors on the handle

- › Lock or unlock the vehicle with the button on the key.

- › Then try to unlock or lock the vehicle using the sensors on the handle.
- › If keyless locking does not work, seek the help of a specialist garage.

## Alarm system

### Functionality

The alarm system triggers audible and visual signals during a break-in or towing attempt.

The alarm system is activated automatically approximately 30 seconds after the vehicle is locked.

The alarm system is automatically deactivated after the vehicle is unlocked.

### Alarm triggering

The activated alarm system triggers an alarm when one of the following events occurs.

- ▶ Opening the bonnet.
- ▶ Opening the boot lid.
- ▶ Opening the door.
- ▶ Manipulation of the ignition lock.
- ▶ Towing the vehicle.
- ▶ Movement in the vehicle.
- ▶ Sudden and significant voltage drop of the electrical system.
- ▶ Uncoupling the trailer.
- ▶ Opening the door unlocked via the lock cylinder.

### Switching off the triggered alarm

- › Unlock the vehicle.

Or:

- › Switch on the ignition.

### Operating conditions

For the correct functioning of the alarm system, all windows must be closed.

A trailer is integrated into the alarm system under the following conditions.

- ✓ The vehicle is factory-fitted with a towing device.
- ✓ The trailer is electrically connected to the vehicle via the trailer socket.
- ✓ The trailer is not equipped with LED taillights.

If the electrical connection to the trailer is interrupted on a vehicle with an activated alarm system, warning signals are triggered.

**[!]** Disable the alarm before connecting or disconnecting a trailer.

### Settings

The following functions of the alarm system can be deactivated once.



- ▶ Interior monitoring.
- ▶ Towing protection.

Deactivation will also switch off the SAFE function » page 19, *Functionality*.

### Deactivation

- ▶ By double locking within 2 seconds.

Or:

- ▶ In Infotainment, in the **CAR** >  >  > Interior monitoring menu

Or:

- ▶ In Infotainment, in the **MENU** >  >  >  > Interior monitoring menu

**[!]** The functions of the alarm system must be deactivated if the vehicle is being towed or transported, for example.

The functions of the alarm system are reactivated after the vehicle is unlocked and locked again.



## Doors, windows and boot lid

### Doors

#### Opening/closing the door

##### Opening from the outside

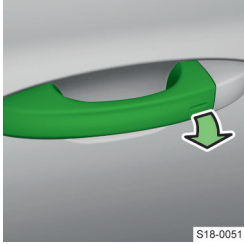

S18-0051

- › Unlock the vehicle and pull on the door handle.

##### Opening from the inside



S18-0050

- › Pull the door opening lever and push the door away from you.

##### Closing from the inside

- › Grasp the pull handle and close the door.

### Child safety lock on the rear doors

#### Operation

The child lock prevents the rear doors from being opened from the inside.

#### Switching on and off



S18-0108

- › Turn the fuse with the vehicle key or a flat-head screwdriver.

- A** Child lock switched off
- B** Child lock switched on

### Protective door strip

#### What you should be mindful of

##### ⓘ NOTICE

- Risk of damage to the strip, the door and the body!
- ▶ Do not open the door too hastily or abruptly.
- ▶ Do not hold the door on the strip when opening and closing, as the strip must be able to move in and out freely.
- ▶ If the strip prevents the door from closing freely, do not close the door forcefully! Remove the strip, and seek the help of a specialist garage.

#### Functionality

Depending on the trim level, the doors can each be equipped with a protective strip. This moves out when opening the door and protects the central area of the door edge from damage.

When the door closes the protective strip retracts.

#### Self-help

##### Replacing the damaged strip

##### ⚠ CAUTION

Risk of injury!

- ▶ Be careful when handling the strip.

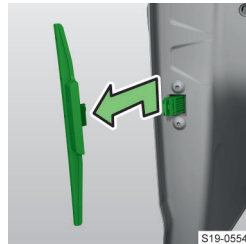

S19-0554

- › Remove the strip from the door.

##### ⓘ NOTICE

- ▶ If any part of the strip remains in the door, seek the help of a specialist garage.

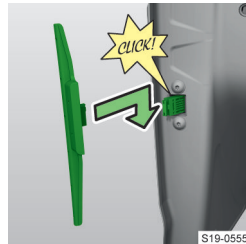

S19-0555

- › Insert a new strip in the grooves.
- › Press in the strip.

**i** A new strip can be purchased from ŠKODA Original Parts.

## Window - with manual operation

### Operation

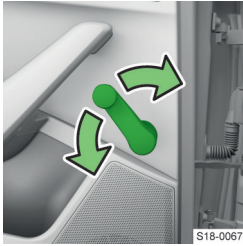

- › Turn the crank in the appropriate direction.

## Window - with electrical operation

### What you should be mindful of

#### Force limiter

To reduce the risk of pinch injuries when closing the windows, the vehicle has a force limiter.

If there is an obstacle, the window closing process is stopped and the pane retracts by several centimetres.

If the obstacle prevents the it from being closed for the next 10 seconds, the closing process is interrupted once again and the window goes down by several centimetres.

If you attempt to close the window again within 10 seconds of the window being moved down for the second time, even though the obstacle was not yet been removed, the closing process is only stopped. During this time, it is not possible to automatically close the windows by pulling the button all the way. The force limiter is, however, switched on.

The force limiter is only not operational if you attempt to close the window again within the next 10 seconds – the window will now close with full force! If you wait longer than 10 seconds, the force limiter is switched on again.

#### ⚠ CAUTION

Risk of injury!

- ▶ Close the windows carefully, even though they have a force limiter.

### Overview of the operating buttons on the driver's door

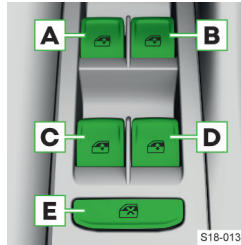

Depending on the equipment:

- A** Front door left
- B** Front door right
- C** Rear door, left
- D** Rear door, right
- E** Deactivation/activation of the buttons in

the rear doors

### Operation

#### Opening

- › Press the corresponding button slightly downwards and hold it until the window has reached the desired position.

Or:

- › Press the corresponding button until it stops; the window opens automatically. Pressing the button again will stop the opening process.

#### Closing

- › To close, pull gently upwards on the top edge of the corresponding button and hold until the window has reached the desired position.

Or:

- › Pull the corresponding button until it stops; the window closes automatically. By pressing the button again, the closing process is stopped.

**[i]** After switching off the ignition, the windows can still open and close for about 10 minutes so long as none of the doors are opened.

#### Open all of the windows at the same time

- › Press and hold the button on the key.

Or:

- › Turn off the ignition, open the driver's door, and hold down the driver's window button until it stops.

**[i]** Depending on the setting, only the driver's window can be opened in this way.

#### Close all of the windows at the same time

- › Press and hold the button on the key.

Or:

- › Turn off the ignition, open the driver's door, and pull upwards on the driver's window button until it stops.



Or:

- › For vehicles with a keyless unlocking system, hold one finger on the sensor on the outside of the handle on the front door.

**I** Depending on the setting, only the driver's window can be closed in this way.

## Settings

The window operation is set in the following menu in the Infotainment system.

**CAR** ›  ›  › Window operations

Or:

**MENU** ›  ›  ›  › Window operation

## Troubleshooting

### The window regulator has stopped working after repeated opening and closing

The window regulator mechanism could have overheated.

- › Allow the window regulator mechanism to cool down.

### The automatic window operation does not work after disconnecting the vehicle battery

- › Enable automatic window operation » page 25.

## Activation after disconnecting the vehicle battery



### Activate automatic window operation

- › Turn on the ignition.
- › Pull the corresponding button upwards and the window closes.
- › Release the button.
- › Pull up the respective button and hold for 1 second.

## Sunblind - with electrical operation

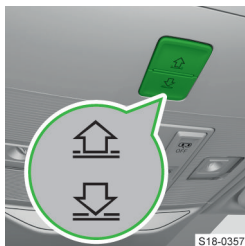
### Operation



-  Closing
-  To open

- › Press or hold the button to **move** the roller blind.
- › Press or release the button to **stop** the roller blind from moving.

## Activation after disconnecting the vehicle battery

- › Turn on the ignition.
- › Keep the  key pressed down. The sun protection blind opens and closes again.
- › Release the button.

## Sun visors

### Folding up and folding down

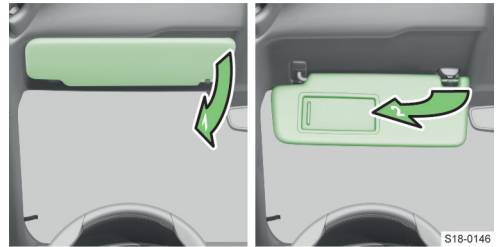

- 1 Swivel the front visor towards the windscreen
- 2 Swivel the visor towards the door

## Heated windscreen

### Usage

Windscreen heating is used for defrosting or ventilating the windscreen.

### Conditions

- ✓ The engine is running.

### Operation

#### Heated rear window



- › Press the  key to turn on the heated rear window.

#### Heated windscreen

Applies to Climatronic.

- › Press the **MENU** key on the Climatronic ›, tap the  Infotainment screen to turn on the heated windscreen.

Or:

- › tap **MENU** ›  ›  in the Infotainment screen to turn on the heated windscreen.

Windscreen heating switches off automatically after 10 minutes.

## Setting

### Automatic heated windscreen



Applies to Climatronic.

The heated windscreen switches on automatically if the windscreen mists up.

This function is set in the following menu in the Infotainment system.

- › Press the **MENU** button on the Climatronic control panel ›, tap the  functional surface on the Infotainment screen.

Or:

- › Tap the **MENU** >  >  functional surface on the Infotainment screen.

## Troubleshooting

### The indicator light in the button or below the button flashes

The heating does not work as the battery charging level is low.

## Boot lid - with manual operation

### Operation

#### To open



S18-0054

- › Press the handle and lift the lid.

The option to open by pressing the handle is deactivated once a speed of 5 km/h is reached. This is activated again after the vehicle has stopped and a door is opened.

#### Closing

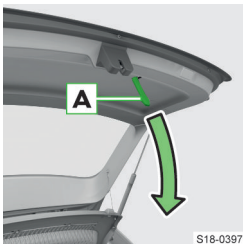

S18-0397

- › Grasp the fixture **A** and pull the lid down.

### ⚠ CAUTION

Danger of opening the lid while driving!

- › Ensure that the lock is properly engaged after closing the lid.

### Set a delayed lid lock

If the lid is unlocked with the  button on the key, the lid is automatically locked again after closing.

The period after which the lid is locked automatically can be extended by a specialist garage.

## Boot lid - with electrical control

### Operation

#### ⚠ CAUTION

Risk of injury!

- › Only operate the tailgate when nobody is within swivel range.

#### ⚠ CAUTION

Danger of opening the lid while driving!

- › Ensure that the lock is properly engaged after closing the lid.

#### ① NOTICE

- › Do not manually close the tailgate when moving.
- › Before operating the tailgate, check that there are no objects in the swivel area that could damage the tailgate. Also check that there are no objects within the immediate vicinity of the vehicle that could damage the vehicle interior and the transported objects.

**i** If the tailgate hits an obstacle when closing, it stops and an audible signal sounds.

**i** When automatically closing the tailgate, e.g. under the weight of snow, a broken beep sounds.

#### Handle in the tailgate



S18-0054

- › Press the handle to open, close or stop the movement of the tailgate.

The option to open by pressing the handle is deactivated once a speed of 5 km/h is reached. This is activated again after the vehicle has stopped and a door

is opened.

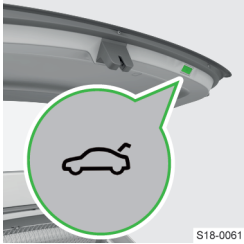
**Button in the tailgate**

- › Press the button to open, close or stop the movement of the tailgate.

**Button in the door**

- › To open the tailgate, pull and hold the button until the tailgate starts to open.
- › To close the tailgate, pull and hold the button until the tailgate is fully closed.
- › To stop the movement of the tailgate, pull or

release the button.

**Button on the key**

- › Press the  button to open, close or stop the movement of the tailgate.

The option to lock exists only on vehicles with a keyless unlocking system. The key must not be in the vehicle and must be at a distance of max. 2 m from the tail-

gate.

**I** The tailgate can also be closed by pulling it briefly downwards.

**Settings****Set the uppermost position of the tailgate and store it**

It makes sense to set the top position of the tailgate, e.g. setting for the opening of the tailgate in a limited space due to the garage height.

- › Stop the lid in the desired position.
- › Press the  button and hold down on the lower edge of the tailgate until an audible signal sounds.

**Re-adjusting the top starting position of the lid**

- › Carefully raise the flap manually to the limit.
- › Press the  button and hold down on the lower edge of the tailgate until an audible signal sounds.

**Troubleshooting****The tailgate does not react to the opening signal**

- › There is a possible obstacle, e.g. snow; remove it.

Or:

- › Press the handle in the tailgate and lift the lid.

Or:

- › Unlock the tailgate » page 27.

**The tailgate does not react to the closing signal**

- › Close the tailgate manually.

**! NOTICE**

- ▶ Close the tailgate slowly, push down the tailgate and push in the lock on the centre of the rear edge of the tailgate.

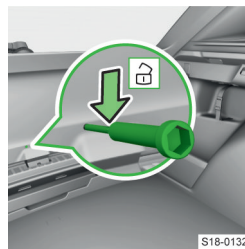
**Unlocking the boot lid****Unlocking**

- › Insert a screwdriver into the opening in the panel.
- › Release the flap by moving it in the direction of the arrow.

## Seats, steering wheel and mirror

### Front seat - with manual operation

#### Controls on the seat

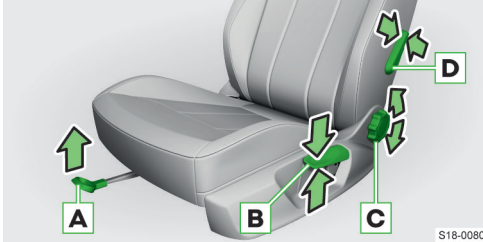

- A** Adjusting the seat in the longitudinal direction - after releasing the operating lever, the lock must audibly click into place
- B** Adjusting the height
- C** Adjusting the angle of the backrest - do not lean against the backrest during adjustment
- D** Adjusting the extent of the curvature of the lumbar support

After a certain time, play can develop within the adjustment mechanism of the backrest angle.

#### Folding passenger seat backrest

##### Folding down

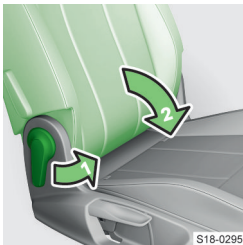

- › Pull on the operating lever.
- › Fold the backrest forwards until it clicks into place.

##### Folding back up

- › Pull on the operating lever.
- › Press the backrest backwards until it audibly clicks into place.

### Front seat - with electrical operation

#### Controls on the seat

##### Adjusting the seat

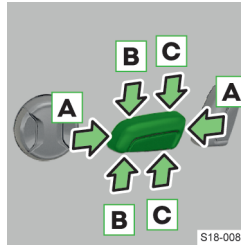

- A** Adjust in a longitudinal direction
- B** Adjust the inclination
- C** Adjusting the height

##### Adjusting the seat back

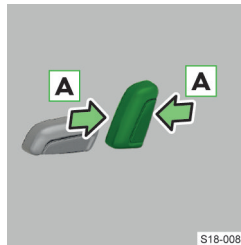

- A** Adjust the inclination

##### Adjusting the lumbar support

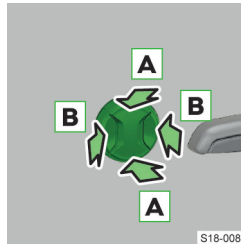

- A** Set the position of the curvature
- B** Set the extent of the curvature

### Rear seats

#### Fold the seat backs forwards

##### Before folding down

- › Insert the rear headrests as far as they will go or remove them.
- › Adjust the position of the front seats in such a way that they are not damaged by the folded-down seat backrests.
- › Pull the outer seat belt to the side trim.

### Folding down

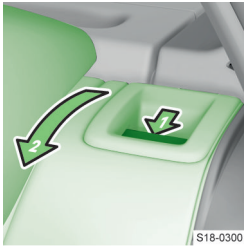

S18-0300

- › Press the release handle and fold the seat forwards.

### Folding back up

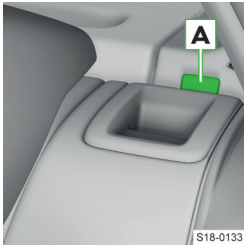

S18-0133

- › Pull the outer seat belt to the side trim.
  - › Fold the seat backrest back up.
- The release handle must audibly click into place.
- › Check that the seat backrest has locked in place. The pin **A** must not be visible.

## Headrests

### Adjusting the height of the headrests

#### Front headrests

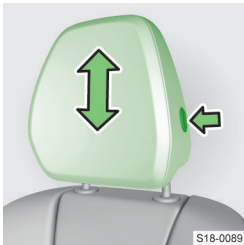

S18-0089

- › Hold the safety button and move the headrest in the desired direction.

#### Rear headrests

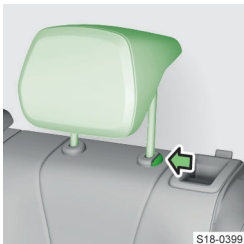

S18-0399

- › Move the headrest in the desired direction. When pushing down, press and hold the safety button.

### Removing and inserting the rear headrests

#### Removing

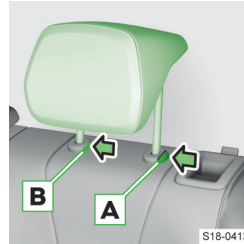

S18-0413

- › Partially fold the respective seat back forwards.
- › Move the headrest up to the stop.
- › Press safety buttons **A** and **B** at the same time and remove the support.

#### Inserting

- › Insert the headrest into the seat backrest. The safety button must click into place.

## Front armrest

### Settings

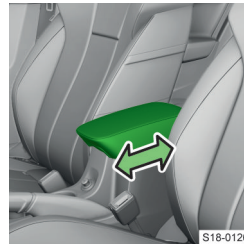

S18-0126

- › Move the backrest to the desired position.

## Rear armrest

### Settings

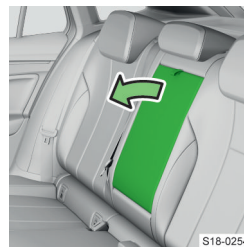

S18-0254

- › Fold down the armrest. The folded-down armrest can be used as a storage table.

## Seat heating

### What you should be mindful of

#### ⚠ WARNING

Risk of burns!

- › Do not switch on the seat heater for persons with limited perception of pain or temperature.



**NOTICE**

Risk of seat damage!

- ▶ Do not kneel on the seats or otherwise puncture them.
- ▶ Do not turn on the heater in the following situations.
  - ▶ The seat is not occupied.
  - ▶ There are objects on the seat, such as a child seat.
  - ▶ There are additional seat covers or protective covers on the seat.

**Conditions**

- ✓ The engine is running.

**Operation**

- › Press the  or  key to switch on the seat heating.

The seat heating is switched on with maximum heating output. By repeatedly pressing the button, the heating output is reduced until it is switched off.

The heat output is determined by the number of illuminated indicator lights that are shown in the key or in the Climatronic display.

If the seat heating is switched on with maximum heat output, the heating power is automatically lowered after 10 minutes.

**Steering wheel**

**Adjust the steering wheel**

**WARNING**

Risk of an accident!

- ▶ Do not adjust the steering wheel while driving.



- › Swing the safety lever downwards.



- › Adjust the steering wheel to the desired position.





- › Press the safety lever as far as it will go.

**Troubleshooting**

**Power assisted steering faulty**

 illuminates - total failure of the power assisted steering, failure of steering assistance

- › Turn off the ignition, start the engine and drive a few meters.
- › If the  indicator light does not go out, stop driving. Seek the help of a specialist garage.

 illuminates - partial failure of the power assisted steering, possible reduction in power steering

- › Turn off the ignition, start the engine and drive a few meters.
- › If the  indicator light does not go out, continue driving, exercising appropriate caution. Seek the help of a specialist garage.

**Steering column lock faulty**

 flashing  
Message regarding a fault in the steering column lock

- › Stop the vehicle.
- › Seek the help of a specialist garage.

After switching off the ignition, it is then no longer possible to switch on the ignition, to lock the steering and to switch on the electrical consumers.

 flashing  
Message regarding a fault in the steering lock

- › You may continue driving, exercising appropriate caution. Seek the help of a specialist garage.

**Steering column lock not unlocked**

 flashing  
Message concerning the required steering wheel movement

- › Move the steering wheel slightly back and forth.
- › If the steering does not unlocked, stop the vehicle and seek the help of a specialist garage.

**Heated steering wheel**

**Conditions**



- ✓ The engine is running.

## Operation

Applies to Climatronic.

- › Press the **MENU** key on the Climatronic ›, tap the  Infotainment screen to turn on steering wheel heating.

Or:

- › tap **MENU** ›  ›  in the Infotainment screen to turn on steering wheel heating.

## Settings



### Steering wheel heating together with driver's seat heating

Applies to Climatronic.

When the function is switched on, pressing the button for the driver's seat heating also turns steering wheel heating on or off.

- › Press the **MENU** button on the Climatronic in the  Infotainment screen and select the menu item for coupling the seat and steering wheel heating.

Or:

- › Tap on **MENU** ›  ›  in the Infotainment screen and select the menu item for the coupling of the seat and steering wheel heating.

When the function is switched on, the function surface  is displayed in the Infotainment screen. This can be used to switch steering wheel heating on or off.

## Interior rear-view mirror

### Operation

#### Interior mirror with manual darkening

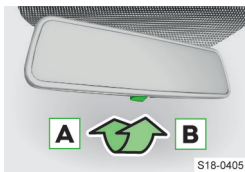

- A** Mirror is not darkened
- B** Mirror darkens

#### Interior mirror with automatic darkening

Darkening of the mirror is automatically controlled through the sensors in the mirror once the engine is started.

#### ⚠ CAUTION

Risk of an accident!

A glowing display e.g. a mobile phone or navigation device may affect the function of the automatic mirror darkening.

- ▶ Do not attach these devices close to the mirror.



## Exterior mirror

### Operation

#### Positions of the rotary knob and adjustment of the mirror surface

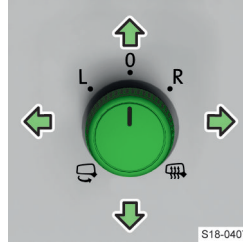
The mirrors can be folded manually or electrically, depending on the equipment.



- L** Adjust the left mirror
- 0** Switch off operation
- R** Adjust the right mirror
-  Fold mirror in electrically (to fold back out, select a different position)
-  Heat the mirror

when the engine is running

Adjusting the mirror surface

- › Select position **L** or **R**.
- › Turn the rotary knob in the direction of the arrows.

#### Folding electrically folding mirrors automatically

The mirrors fold in when the vehicle is locked and fold back out when the vehicle is unlocked, if this feature is activated.

**I** Locking of the vehicle is not indicated by the fact that the mirrors fold in. Locking of the vehicle is indicated by the turn signal lights flashing.

#### Manually foldable mirrors

- › Fold the mirror towards the side window by applying pressure with your hand.

#### ⚠ WARNING

Risk of an accident!

The exterior mirrors make objects appear farther away. Use the rear-view mirror to determine the distance from vehicles behind.

#### ⓘ NOTICE

Danger of mirror damage!

If the electrically foldable mirror is swung out by external influences (e.g. due to an impact during manoeuvring), fold the mirror in using the rotary knob and wait for an audible folding sound.

## Settings

Automatic folding of the exterior mirrors is activated or deactivated in the following menu in the Infotainment system.

**CAR** ›  › 

Or:

**MENU** ›  ›  › 

## Troubleshooting

### Electric mirror operation impaired

- › Adjust the mirror surface by pressing it lightly with your finger.

#### CAUTION

Risk of burns!

Do not touch heated exterior mirror surfaces.

## Restraint systems and airbags

### Seat belts

#### Functionality

Seat belts that are fastened correctly offer very good protection in the event of an accident. They reduce the risk of an injury and increase the chance of survival in the event of a major accident.

#### WARNING

- ▶ The seat belts must not be removed or altered in any other way.
- ▶ Do not attempt to repair the seat belts yourself. Have a damaged seat belt replaced immediately by a specialist garage.

#### Automatic belt retractor

The automatic belt retractor locks the belt when the belt is pulled jerkily or when the belt is being rolled up violently.

#### WARNING

If the seat belt does not lock when pulled jerkily, have the retractor checked by a specialist garage.

#### Belt tensioners

The safety of the driver, front passenger and passengers on the outer rear seats **who are wearing their seat belts** is enhanced by the belt tensioners fitted to the inertia reels on the front and rear external seat belts.

If there is a collision with a certain severity, the seat belt is tightened by the belt tensioner so that unwanted body movement is prevented.

The belt tensioner can also be deployed when the seat belt is not fastened.

Belt tensioners are **not activated** in the event of a roll-over, **minor** collisions or in accidents in which no major forces are produced.

 Smoke is released when the belt tensioner is deployed. This does not indicate a vehicle.

#### Reversible belt tensioner

Vehicles with a proactive occupant protection system include reversible belt tensioners › [page 127](#).

The reversible belt pretensioners increase safety for the belted driver and front passenger by automatically tightening the seat belt tightly over the body in critical driving situations and then releasing it again.

#### Status display in the instrument cluster display

 - front seat belt not fastened

 - a rear seat belt is not fastened

 - a rear seat belt is fastened

## Operation

### Fastening the seat belt

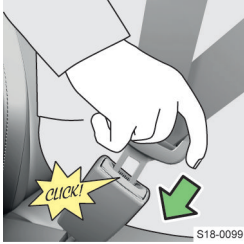

- › Grasp the buckle latch and slowly pull the belt over the chest and pelvis towards the buckle.
- › Insert the buckle latch into the buckle until there is an audible click.
- › Pull on the belt to ensure that the buckle is securely fastened.

### Unfastening the seat belt

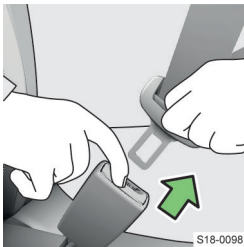

- › Grasp the buckle latch and release it by pressing the red button.
- › Hold the belt so it does not twist when rolling up.

## Setting

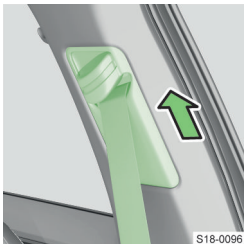

- › Move the seat belt height adjuster upwards to increase the height.

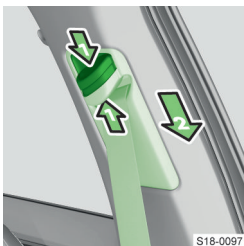

- › Press the safety button and move the seat belt height adjuster down to reduce the height.
- › After adjustment, firmly pull on the belt to ensure that the seat belt height adjuster has correctly locked in place and that the belt is locked securely.

## Troubleshooting

### Blocked belt retractor



- › Grasp the strap in the middle and pull quickly in the direction of the arrow.
- › Hold the strap and let it roll up slowly.
- › Pull on the strap to see if the retractor is working properly.
- › If the strap is still blocked, repeat the unblocking procedure once or twice.
- › If the strap is still blocked, seek the help of a specialist garage.

## Child seat

### What you should be mindful of

For how to install and use the child seat, please note the instructions in this Owner's Manual as well as the instructions of the child seat manufacturer.

For safety reasons, we always recommend that children are transported on the back seats. Carry children on the front passenger seat only in exceptional cases.

Child seats according to standard ECE-R 44 the European Economic Commission.

Child seats according to standard ECE-R 44 are marked with the test symbol: large E in a circle, with the test number below.

We recommend using child seats from the ŠKODA Genuine Accessories range. These child seats have been developed and tested for use in ŠKODA vehicles. They meet the standard ECE-R 44.

### ⚠ WARNING

- ▶ When installing the child seat on the rear seat, adjust the front seat so that there is no contact between the front seat and the child seat or the child carried in the child seat.
- ▶ If the headrest prevents the child seat from being fitted, adjust the headrest to the highest position.
- ▶ If using a separate child seat cushion, adjust the headrest so that the child's head is flush with, but not protruding above the height of the top edge of the headrest.

### Using a child seat on the front passenger seat

Never use a child seat in which the child is carried with his or her back to the direction of travel on a seat protected by an active airbag placed in front of

## 34 Restraint systems and airbags › Child seat

the seat. This could cause serious injury to the child, even death.

This is also indicated by the following stickers.



Sticker on the passenger sun visor.



Sticker on the central body pillar on the passenger side.

The following instructions must be followed when using a child seat on the front passenger seat.

- ▶ When using a rear-facing child seat, the front passenger airbag must be deactivated.
- ▶ If possible, adjust the front passenger seat backrest so that it is vertical, to ensure that there is se-

sure contact between the backrest and the child seat.

- ▶ If possible, move the front passenger seat backwards so that there is no contact between the front passenger seat and the child seat behind it.
- ▶ Adjust the height-adjustable front passenger seat as much as possible.
- ▶ Adjust the front passenger seat belt as high up as possible.

### ⚠ WARNING

Risk of the seat belt causing a neck injury to the transported child!

- ▶ For child seats in groups 2 and 3, ensure that the guide fitting attached to the child seat headrest is positioned in front of or at the same height as the seat belt height adjuster on the central body pillar.
- ▶ Adjust the height of the front passenger seat belt so that the belt passes through the guide fitting without kinking and is not bent over the edge of the guide fitting.

### ⚠ WARNING

As soon as the rear-facing child seat is no longer being used on the front passenger seat, activate the front passenger airbag again.

## Recommended child seats

Grouping of child seats according to standard ECE-R 44.

Group	Weight of the child
0	up to 10 kg
0+	up to 13 kg
1	9-18 kg
2	15-25 kg
3	22-36 kg

### Recommended child seats

Group	Manufacturer	Type	Attachment	Order number	Approval number (E1 ...)
0+ up to 13 kg	Britax Römer	Baby Safe Plus	Isfix base frame	1ST019907	04 301146
1 9-18 kg	Britax Römer	Duo Plus TT	ISOFIX and TOP TETHER	DDA000006	04 301133
2-3 15-36 kg	Britax Römer	Kidfix XP <sup>a)</sup>	ISOFIX	000019906K	04 301198
	Britax Römer	Kidfix II XP	ISOFIX	000019906L	04 301323

<sup>a)</sup> For optimum protection, especially in the event of a side impact, it is recommended that you use this child seat complete with the backrest.

## Fasteners for child seats

### Use of child seats

Overview of usability of child seats according to standard ECE-R 16.

#### Child seats that use the ISOFIX System

Group	Size category of child seat <sup>a)</sup>	Passenger seat with activated front airbag	Passenger seat with deactivated front airbag <sup>b)</sup>	Outer rear seats <sup>b)</sup>	Middle rear seat
0 up to 10 kg	E	X	IL	IL	X
0+ up to 13 kg	E	X	IL	IL	X
	D				
	C				
1 9-18 kg	D	X	IL	IL	X
	C				
	B				
	B1				
	A				
2 15-25 kg	-	X	IL	IL	X
3 22-36 kg	-	X	IL	IL	X

<sup>a)</sup> The size category of the child seat is indicated on the child seat plate.  
<sup>b)</sup> The seat is suitable for an ISO / R3 fixing.

**IL** The seat is suitable for the ISOFIX child seats with "Semi-Universal" approval.

**X** The seat is not equipped with eyelets for the ISOFIX System.

#### i-Size

Passenger seat with activated front airbag	Passenger seat with deactivated front airbag	Outer rear seats	Middle rear seat
i-UF	i-U	i-U	X

**i-UF** The seat is only suitable for forward-facing i-Size child seats of the "Universal" category.

**i-UF** The seat is suitable for forward- and backward-facing i-Size child seats of the "Universal" category.

**X** The seat is not suitable for i-Size child seats of the "Universal" category.

#### Child seat fastened with a safety belt

When using a child seat of the "Universal" category on the middle rear seat, it is necessary to move the buckle of the middle seat behind the buckle of the outer seat.

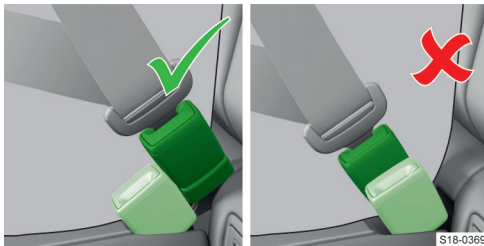

- ✓ Correct position – the belt buckles are behind each other
- ✗ Incorrect position – the buckles are next to each other

S18-0369

Group	Passenger seat with activated front air-bag	Passenger seat with deactivated front air-bag	Outer rear seats	Middle rear seat <sup>a)</sup>
0 up to 10 kg	X	U <sup>b)</sup>	U	U
0+ up to 13 kg	X	U <sup>b)</sup>	U	U
1 9-18 kg	UF	U	U	U
2 15-25 kg	UF	U	U	U
3 22-36 kg	UF	U	U	U

<sup>a)</sup> It is forbidden to install a child seat with a support foot in the middle rear seat.  
<sup>b)</sup> Adjust the height-adjustable front passenger seat as much as possible.

**U** The seat is suitable for the child seat category "Universal" and is permitted for use in this weight group.

**UF** The seat is suitable for forward-facing child seats in the "Universal" category and is permitted for use in this weight group.

**X** The seat is not suitable for children in this weight group.

**Overview**

**ISOFIX**

**⚠ WARNING**

- ▶ Do not attach any other child seats, straps or objects to the holding eyelets provided for the installation of a child seat using the ISOFIX system.

The ISOFIX system allows for the fast and secure installation of the child seat. The eyelets for installing the child seat using the ISOFIX system are located on the outer rear seats and possibly on the front passenger seat.

A child seat that uses the ISOFIX system can only be installed in the vehicle if it is approved for this vehicle type. Further information can be obtained from a ŠKODA partner or from a list of vehicles enclosed with the child seat.



- ▶ Remove the covers before installing the child seat.

**TOP TETHER**

**⚠ WARNING**

- ▶ Child seats that use the TOP TETHER system should only be used on those seats that are fitted

with holding eyes bearing the TOP TETHER symbol.

- ▶ Only attach one fastening strap on the child seat to the holding eyelet in the TOP TETHER system.
- ▶ When attaching the child seat with the TOP TETHER system, no other object must be attached to the TOP TETHER system holding eyelet.



Holding eyelets on the rear seats



Holding eyelet on the passenger seat

The belt fastened into the TOP TETHER system restricts the movement of the upper part of the child seat.

The holding eyelets for attaching the belt are located on the outer rear seats, as well as on the middle rear seat or passenger seat when necessary.



## Airbags

### Usage

The airbag system offers additional occupant protection in the event of severe frontal and side collisions, as a supplement to the seat belts.

The best possible protective effect of the airbag is achieved only when the seat belt is also worn. The airbag system is no substitute for the seat belts.

### Functionality

When sinking into the inflated airbag, the forward movement of the body is damped and the risk of injury is reduced.

**I** As the airbags inflate, smoke is released. This does not indicate a vehicle.

#### Function condition

✓ Ignition switched on.

#### Airbag deployment in the event of an accident

Airbag deployment is influenced by many factors. The deceleration rate at the time of impact is crucial.

#### ⚠ WARNING

Danger of serious or fatal injuries!

- ▶ Maintain the correct seating position.
- ▶ Do not keep your limbs in the deployment area of the airbags.

In the following situations, **no** airbags are deployed.

- ▶ Minor frontal and side collisions.
- ▶ Rear-end collision.
- ▶ Vehicle rollover.

If the measured deceleration rate is below the reference values programmed into the control unit, the airbags will not be deployed despite possible serious vehicle damage.

### Airbag overview

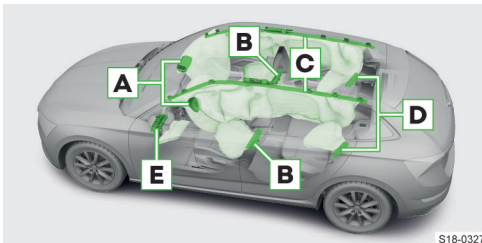

S18-0327

- A** Front airbags
- B** Side airbags - front
- C** Head airbags

**D** Side airbags - rear

**E** Driver's knee airbag

The installation location of the airbags is marked with the lettering **AIRBAG**.

#### ⚠ WARNING

Danger of a functional restriction of the side airbags!

- ▶ Do not exert excessive forces, e.g. impacts, on the seat backs.
- ▶ Have damaged seat covers at the installation location of the side airbags repaired by a specialist garage.

#### Deactivating the airbags

We recommend having airbags other than the front passenger airbag deactivated » [page 38, Operation](#) by a ŠKODA service partner.

Deactivation of the airbags is provided for the following cases, for example.

- ▶ If the driver's seat adjustment is correct, the distance of at least 25 cm between the centre of the steering wheel and the sternum can not be maintained.
- ▶ Additional operating controls for a physically disadvantaged driver are installed in the vehicle.
- ▶ The vehicle has special seats, e.g. orthopaedic seats without side airbags.



illuminates for 4 seconds after the ignition is switched on and then flashes for 12 seconds - Airbag or belt tensioner deactivated with the diagnostic device

Message regarding the deactivated airbag or belt tensioner

#### ⚠ WARNING

If an airbag is deactivated during the sale of the vehicle, inform the buyer!

### Troubleshooting

#### Airbag system faulty



illuminates  
Message regarding an airbag fault

- › Seek the help of a specialist garage.

## Key switch for the front passenger airbag

### Usage

Deactivation of the front passenger airbag is provided for the following cases, for example.

- ▶ A rear-facing child seat is mounted on the front passenger seat.

- ▶ The vehicle has special seats, e.g. orthopaedic seats without side airbags.

### What you should be mindful of

#### ⚠ WARNING

Danger of fault in the passenger airbag deactivation system!

- ▶ Only deactivate the airbag when the ignition is switched off!

#### ⚠ WARNING

Danger of unexpected deployment of the passenger airbags in an accident!

- ▶ If the front passenger airbag has been deactivated with the key, do not leave the key in the key switch while driving. Vibrations can cause the key to turn in the slot and activate the airbag!



- ▶ One of the indicator lights then lights up again depending on the position of the key switch.

**OFF**  Lights up - front passenger airbag switched off

**ON**  Lights up 65 secs after the ignition is switched on - passenger front airbag switched on

### Troubleshooting

#### Key switch for airbag deactivation is faulty

**ON**  and **OFF**  flash together  
The front passenger airbag will not be deployed in the event of an accident!

- ▶ Have the airbag system checked by a specialist garage immediately.

### Operation

#### Before switching on/off the front passenger airbag

- ▶ Completely fold out the key bit.

#### Switch front passenger airbag on/off



- ▶ Switch off the ignition.
- ▶ Open the passenger door.
- ▶ Insert the key bit into the slot in the key switch as far as it will go.
- ▶ To **Switch off**, carefully rotate the key switch into the position **OFF**.

- ▶ To **Switch on**, carefully rotate the key switch into the position **ON**.
- ▶ Remove the key bit from the slot.
- ▶ Close the passenger door.
- ▶ Turn on the ignition and check that the front passenger airbag warning lights are lit up.

#### ⚠ WARNING

When the passenger airbag is switched off, the head airbag on the passenger side is also switched off at the same time.

#### Status display in the instrument cluster display

-  lights up 4 secs after the ignition is switched on - passenger front airbag switched off

#### Indicator lights



- ▶ After switching on the ignition, the two indicator lights light up briefly.
- ▶ If the system is OK, both of the indicator lights go out.

## Lighting, windscreen wipers and washers

### Exterior lighting

#### Functionality

Unless otherwise stated, the light works when the ignition is switched on.

#### Daytime running lights

The daytime running lights illuminate the area in front of the vehicle.

For vehicles for certain markets, they also illuminate the rear vehicle area.

#### Operating conditions

- ✓ The lights switch is in position **0**, **AUTO** or  $\Rightarrow \infty$ .

#### Switching the low beam on/off automatically

The low beam is automatically switched on or off depending on the lighting conditions.

#### Operating conditions

- ✓ The light switch is in the **AUTO** position.

The automatic headlight circuit is indicated by the illumination of the  $\Rightarrow \infty$  symbol in the light switch.

#### Switching low beam on/off automatically in rain

#### Operating conditions

- ✓ The light switch is in the **AUTO** position.
- ✓ The function is activated.
- ✓ The windscreen wipers are switched on for longer than 30 seconds.

The automatic headlight circuit is indicated by the illumination of the  $\Rightarrow \infty$  symbol in the light switch.

#### Full LED headlights

When the light switch is in position **AUTO**, the headlights provide the best possible beam of light in front of the vehicle.

#### CORNER function

The CORNER function ensures the illumination of the area near the vehicle in the turning direction.

#### Operating conditions

- ✓ The turn signal is switched on or the front wheels are steered sharply.
- ✓ The low beam is switched on.
- ✓ The fog lights are not switched on.
- ✓ The driving speed is lower than 40 km/h.

#### When no light is switched on

The symbol  $\odot$  in the light switch may also light up in the instrument cluster, indicating that it is necessary to switch on the light.



illuminates

- › Switch on the light.

#### Operation

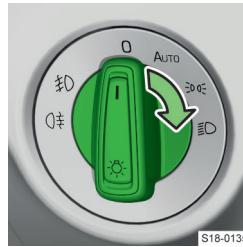

S18-0135

- 0** Switching off the lights except the daytime running lights

**AUTO** Switching the low beam on/off automatically

$\Rightarrow \infty$  Switching on the parking lights

$\infty$  Switching on the low beam

#### Main beam

The high beam works when the low beam is on.

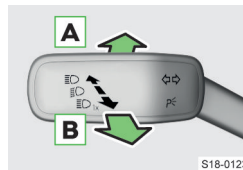

S18-0123

**A** Switch on main beam - lights up  $\infty$

**B** Switch off high beam - goes out  $\infty$  / Switch on flasher - illuminates  $\infty$

#### CAUTION

Risk of an accident!

- › Do not dazzle other road users with the high beam.

#### Turn signal

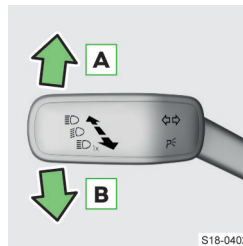

S18-0402

**A** Switch on right turn signal - flashing  $\rightarrow$

**B** Switch on left turn signal - flashing  $\leftarrow$

#### Turn signal - convenience signalling

Convenience signalling enables three flashes of the turn signal lights without having to move the lever up or down.

- › Tap the control lever up or down.

The corresponding turn signal lights flash three times.

Tap the lever in the opposite direction ahead of time to stop signalling.

**Fog light**

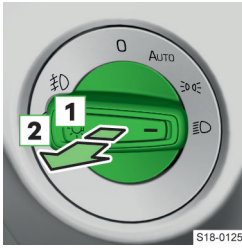

- 1 Fog light - lights up
  - 2 Rear fog light - lights up
- › Turn the light switch to position **AUTO**.
  - › Pull the light switch to the appropriate position.

The rear fog light does not illuminate when an accessory is connected to the trailer socket.

**Hazard warning light system**

To switch on or off, press the button in the central part of the dash panel.

When the hazard warning system is on and the turn signal is switched on, the hazard warning lights will be switched off temporarily and only the turn signal will flash on the relevant side of the vehicle.

The hazard warning lights can be switched on automatically during hard braking. The hazard warning lights are then switched off again automatically when starting off or accelerating.

**One-sided parking light**

The one-sided parking light allows one side of the parked vehicle to be illuminated through activation of the corresponding sidelights.

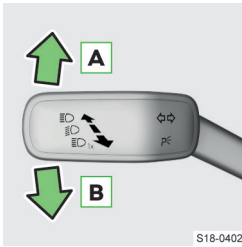

- A Switch on the sidelights on the right
  - B Switch on the sidelights on the left
- › Switch off the ignition.
  - › Move the lever to the appropriate position.
  - › Lock the vehicle.

When the parking light is switched on, an acoustic

warning signal sounds and the driver's door is opened. After a few seconds or after the driver's door is closed, the warning signal will stop.

**Double-sided parking light**

The two-sided parking light allows the parked vehicle to be illuminated through activation of the sidelights.

- › Turn on the ignition.
- › Turn the light switch to position
- › Switch off the ignition.
- › Lock the vehicle.

The light may switch off automatically if the battery is low. If the two-sided parking light is switched on

when the ignition is switched off, the light will not switch off automatically.

When the parking light is switched on, an acoustic warning signal sounds after the ignition is switched off and the driver's door is opened. After a few seconds or after the driver's door is closed, the warning signal will stop.

**Settings**

**Activating/deactivating the automatic headlights system in rain**

The function is activated or deactivated in the following menu in the Infotainment system.

CAR > > >

Or:

MENU > > > >

**Activating/deactivating convenience signalling**

The function is activated or deactivated in the following menu in the Infotainment system.

CAR > > >

Or:

MENU > > > >

**Headlight range control of the LED headlights**



- Front seats occupied, luggage compartment empty
- 1 All seats occupied, luggage compartment empty
- 2 All seats occupied, luggage compartment loaded
- 3 Driver's seat occupied, luggage compartment loaded

Select the position of the control according to the vehicle's current load status.

For the Full LED headlights, the headlight range control is adjusted automatically.

**WARNING**

Risk of an accident! An incorrectly adjusted headlight range can cause insufficient vehicle lighting or can dazzle other road users.

Adjust the headlight range correctly.

**Converting the Full LED headlights for the opposite direction of traffic**

Switch on travel mode in the Infotainment in the following menu.

CAR > > >

Or:

MENU > > >

### Troubleshooting

#### Turn signal light defective

flashes faster - turn signal light on the right defective

> Check the turn signal light on the right.

flashes faster - turn signal light on the left defective

> Check the turn signal light on the left.

does not flash when the trailer is hitched - trailer turn signal light defective

> Check the trailer lighting.

#### Light bulb or LED bulb is defective

or illuminates

Information appears in the display regarding the affected lights.

> Replace the defective bulb.

> In case of a defective LED lights, contact a specialist garage for help.

#### The headlights are misted up on the inside

Inside the headlights, moisture may occur. This is not a defect.

#### Malfunction of the automatic headlight circuit

> Clean the windscreen in the area of the rain/light sensor.

#### Beam of light in front of the vehicle has shortened

Headlight defective.

> Seek the help of a specialist garage.

#### Driving lights defective

If a message regarding the failed driving lights is displayed, the light will work in emergency mode.

> Drive on, exercising appropriate caution.

> Seek the help of a specialist garage.

## COMING HOME, LEAVING HOME exterior lighting

### Functionality

The COMING HOME function turns on the light after turning off the ignition and opening the driver's door.

The LEAVING HOME function switches on the light when unlocking the vehicle with the wireless remote control.

### Operating conditions

- ✓ Visibility has worsened.
- ✓ The light switch is in the **AUTO** position.

### Settings

This function is set in the following menu in the Infotainment system.

CAR > >

Or:

MENU > > >

## Light Assist high-beam assist system

### Functionality

The high beam assist system automatically switches the high beam on and off.

#### ⚠ WARNING

Risk of an accident!

▶ If necessary, manually switch the high beam on or off.

### Operating conditions

- ✓ The system is activated.
- ✓ The light switch is in the **AUTO** position.
- ✓ The driving speed is higher than 30 km/h (for some countries, higher than 60 km/h).
- ✓ The low beam is switched on.

### Operation

#### Switching on

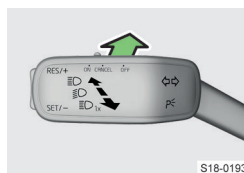

> Push the lever in the direction of the arrow.

in the instrument cluster lights up.

#### Switching off

> Manually switch the high beam on or off.



### Settings

#### Activation/deactivation

The function is activated or deactivated in the following menu in the Infotainment system.

CAR > >

Or:

MENU ›  ›  › 

## Replace light bulbs

### What you should be mindful of

DIY replacement of the following bulbs is possible. Have the remaining light sources replaced by a specialist garage.

The new bulb must conform to the specification of the original light bulb. The name of the bulb is marked on the bulb socket.

#### ⓘ NOTICE

Danger of headlight damage due to the ingress of water and dirt!

- ▶ Always fit the protective cap on the headlight correctly after changing a bulb.

### Conditions for changing a bulb

- ✓ Ignition switched off.
- ✓ Light switched off.

### Rear turn signal

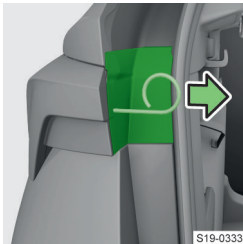

S19-0333

- ▶ Remove the cover with the bracket from the tool kit.

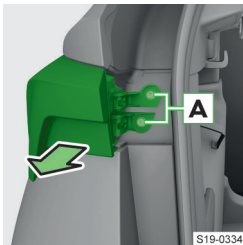

S19-0334

- ▶ Unscrew the screws **A** and remove the light.

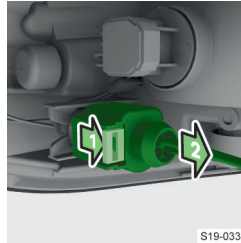

S19-0335

- ▶ Press the lock mechanisms on the connector and remove the connector.

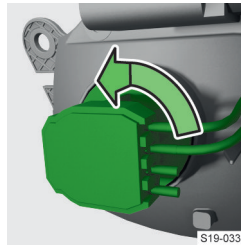

S19-0336

- ▶ Turn and remove the socket with the bulb.

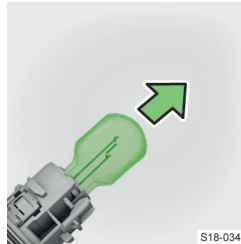

S18-0343

- ▶ Change the bulb in the socket.
- ▶ Insert the socket with the new bulb into the light so that the guide lugs on the socket are aligned with the corresponding openings in the light.
- ▶ Turn the socket clockwise  to secure.

- ▶ Insert the connector into the light until it clicks into place.

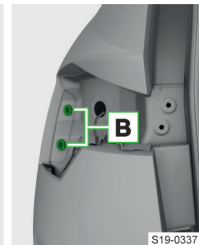
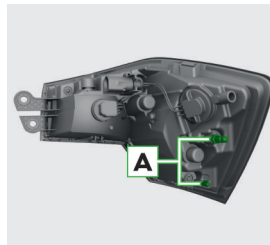

S19-0337

- ▶ Insert the pins **A** of the light into the openings **B** in the body.

#### ⓘ NOTICE

Risk of damage to the electrical system!

- ▶ Make sure that the cables between the light and the body are not pinched when the light is inserted.
- ▶ Screw the light into place.
- ▶ Fit the cover of the light, ensuring it clicks into place.

## Reversing lights

- › Open the boot lid.



S18-0341

- › Release and remove the cover cap in the boot lid.



S18-0342

- › Turn and remove the socket with the bulb.

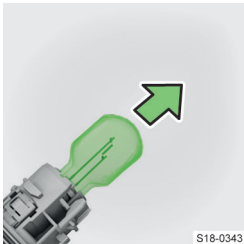

S18-0343

- › Change the bulb in the socket.
- › Insert the socket with the new bulb into the light so that the guide lugs on the socket are aligned with the corresponding openings in the light.

- › Turn the socket clockwise to secure.

- › Insert the cover cap until it clicks into place.

## Interior lighting

### Operation

#### Operation of the lighting

- ☞ Switching on
- 0 Switching off
- ☞ Reading lights
- ☞ Automatic switch on and switch off

Depending on the equipment, the rear light can be switched on and off automatically together with the front light.

When the front light is switched off, the rear light can be switched on and off manually.

#### Switching on automatically

The light switches on when one of the following events occurs.

- ▶ The vehicle is unlocked.
- ▶ One of the doors is opened.

- ▶ The ignition key is removed.

#### Automatic switch off

The light switches off when one of the following events occurs.

- ▶ The vehicle is locked.
- ▶ The ignition is switched on.
- ▶ About 30 seconds after all the doors have been closed.

#### Automatic switching on/off of the footwell lighting

The lighting only works when the dipped or parking lights are on.

The lighting is also switched on automatically after opening the door (e.g. when getting in or out).

### Settings

The footwell lighting is set in the following menu in the Infotainment system.

CAR > ☞ > ☞

Or:

MENU > 🚗 > ☞ > ☞

## Interior ambient light

### Usage

The ambient lighting ensures that various areas of the vehicle interior are lit.

The lighting only works when the dipped or parking lights are on.

The lighting is also switched on automatically after opening the door (e.g. when getting in or out).

### Settings

The ambient lighting is set in the Infotainment system, in the following menu.

CAR > ☞ > ☞

Or:

MENU > 🚗 > ☞ > ☞

## Windscreen wipers and washers

### Operating conditions

#### Operating conditions for windscreen wipers

- ✓ Engine compartment flap closed.
- ✓ Boot door closed.
- ✓ Ignition is switched on.



**Operating conditions for the windscreen washer system**

- ✓ Engine compartment flap closed.
- ✓ Boot door closed.

**Operation**

**⚠ WARNING**

Risk of an accident!

At low temperatures, windscreen washer fluid can freeze on the windscreen and restrict visibility.

- ▶ Only use the windscreen washer when the windscreen is warm.

**Wipe and wash the windscreen**

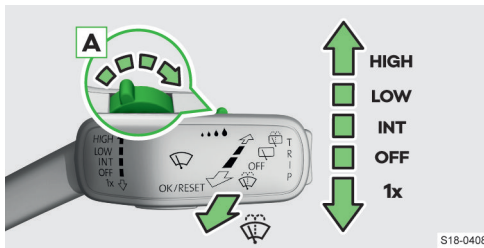

**HIGH** Fast wiping

**LOW** Slow wiping

**INT** Depending on the equipment:

- ▶ Intermittent wiping
- ▶ Automatic wiping controlled by the rain sensor

**OFF** Switching off

**1x** Tip-wiping (spring-loaded position)

**A** ... Setting the wiping speed for the position **INT**

☞ Washing and wiping (spring-loaded position)

The windscreen washer nozzles of the windscreen are automatically heated together with the exterior mirrors.

**Clean headlights**

When the headlights are switched on, they are cleaned the first time and after every tenth wash of the windscreen. The cleaning interval can be set by a specialist company.

**Wipe and wash the rear window**



☞ Washing and wiping the window (spring-loaded position)

Washing the reversing camera (spring-loaded position)

☞ Wiping

**OFF** Switching off

**Automatic rear window wiping**

When the windscreen wipers are switched on, the rear window is automatically wiped when the reverse gear is engaged.

**Settings**

**Activating/deactivating automatic wiping**

The functions for automatic rear window wiping and automatic wiping in the rain can be activated and deactivated in the following menu in the Infotainment system.

**CAR** > ☞ > ☞

Or:

**MENU** > ☞ > ☞ > ☞

**Refilling windscreen washer fluid**

**⚠ WARNING**

Risk of an accident!

- ▶ Use windscreen washer fluid that is suitable for the weather conditions.

**ⓘ NOTICE**

Risk of damage to the windscreen washer system!

- ▶ When refilling the washer fluid, do not remove the strainer from the neck of the container.

**ⓘ NOTICE**

Risk of damage to the headlights!

- ▶ Only use washer fluid that does not attack polycarbonates.

**ⓘ NOTICE**

Risk of damage to engine compartment components!

- ▶ Close the container after refilling the windscreen washer fluid.

The windscreen washer tank is located in the engine compartment » page 10.

The container can hold a volume of 3 litres and 4 litres for vehicles with a headlight cleaning system.

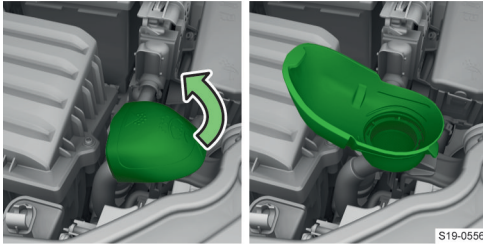

- › Gently open the top of the lid.

### Troubleshooting

#### Windscreen washer fluid level too low



or illuminates

- › Top up the windscreen washer fluid.

#### Frozen windscreen wipers

- › Carefully remove frozen windscreen wipers from the windscreen before switching on the ignition and free them from snow and ice.

### Folding down windscreen wiper arms and replacing windscreen wiper blades

#### Fold the windscreen wiper arms away from the windscreen

##### ① NOTICE

Risk of damage to the windscreen wipers and the engine compartment flap!

- ▶ Close the engine compartment flap before the windscreen wiper arms are folded away from the windscreen.
- ▶ Do not turn on the ignition when the windscreen wiper arms are folded away.
- › Switch the ignition on and off again.

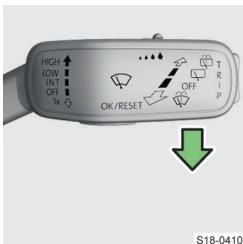

- › Within 10 seconds, press the control lever down and hold for about 2 seconds.

The windscreen wiper arms are in the folded position.

- › Fold the windscreen wiper arms away from the windscreen.

#### Replace the windscreen wiper blade

##### ⚠ CAUTION

Risk of an accident!

- ▶ Change the windscreen wiper blades once or twice a year.
- › Fold the windscreen wiper arm away from the windscreen.

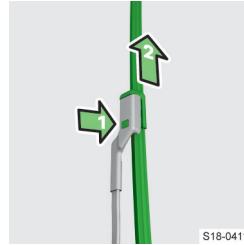

- › Press the catch and remove the wiper blade.
- › Insert the new wiper blade until it clicks into place.
- › Fold the windscreen wiper arm back onto the windscreen.
- › Turn on the ignition and push the control lever down.

## Heating and air conditioning system

### Heating

#### Overview of the heating operation components

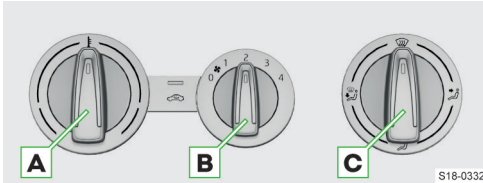

- A** Set the temperature
- B** Set the blower speed
- C** Set the direction of the air outlet
- Switch recirculated air mode on/off

**⚠ WARNING**  
 Danger of misting!  
 ▶ Always keep the fan on.

### Manual air conditioning

#### What you should be mindful of

- ▶ We recommend a difference of max. 5°C between the outside temperature and the interior temperature.
- ▶ We recommend switching the cooling system off about 10 minutes before the end of the journey to prevent odour formation.
- ▶ Annual disinfection of the air conditioning is recommended.

**⚠ WARNING**  
 Danger of misting!  
 ▶ Always keep the fan on.

#### Operating conditions for the cooling system

- ✓ The outside temperature is below 2 °C.
- ✓ The engine is running.
- ✓ The blower is switched on.

#### Overview of the controls for the manual air conditioning

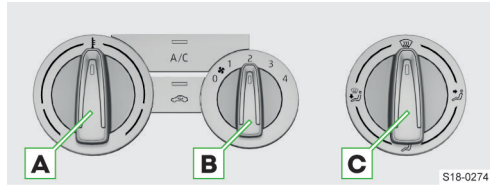

- A** Set the temperature
- B** Set the blower speed
- C** Set the direction of the air outlet
- Switch recirculated air mode on/off
- A/C** Switch the cooling system on/off

**i** After pressing the **A/C** button, the indicator light in the button illuminates, even if the conditions for switching on the cooling system are not met. The cooling system switches on when the conditions for switching on the cooling system are met.

**i** During operation of the air conditioning system, there may be an automatic increase in the engine idle speed.

#### Automatic activation of the cooling system

Automatic activation of the cooling system prevents the windows from misting up. The system switches on in the following cases.

- ▶ When the fan is on and the air distribution controller is in the position.  
 In this case, the recirculation mode is switched off and cannot be switched on.
- ▶ If the air distribution controller is not in the position, and recirculated air mode is switched on.

#### Recirculated air mode

The recirculation mode prevents contaminated outside air getting into the interior of the vehicle.

Briefly switching on recirculation mode can increase the cooling effect.

**i** Under certain circumstances, the recirculation mode may be switched on or off automatically.

**⚠ WARNING**  
 Risk of an accident!

In recirculation mode, there is no fresh air supply from the outside. This can result in loss of driver attention and fogging up of windows.

- ▶ Keep the recirculation mode switched on for a short time only.

## Troubleshooting

### Water under the vehicle

When the cooling system is switched on, water can drip off the air conditioning system. This is not a leak.

### Fogging

› Increase the blower speed and switch on the cooling system.

### Automatic switch-off of the cooling system

If the coolant temperature is too high, the cooling system may switch off automatically. This ensures sufficient engine cooling.

## Climatronic automatic air conditioning system

### What you should be mindful of

- ▶ We recommend a difference of max. 5°C between the outside temperature and the interior temperature.
- ▶ We recommend switching the cooling system off about 10 minutes before the end of the journey to prevent odour formation.
- ▶ Annual disinfection of the air conditioning is recommended.

### ⚠ WARNING

Danger of misting!

- ▶ Always keep the fan on.

### Operating conditions for the cooling system

- ✓ The outside temperature is below 2 °C.
- ✓ The engine is running.
- ✓ The blower is switched on.

### Operation

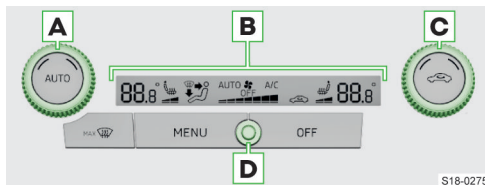

- A** Set the temperature for the left side
- B** Climatronic display
- C** Set the temperature for the right side
- D** Interior temperature sensor

### AUTO Press - Switch on automatic mode

This function keeps the temperature constant and prevents the windows from misting.

Hold - Maintain the interior temperature in accordance with the temperature setting for the driver side (SYNC function)

☁ Switch recirculated air mode on/off

MAX Switch the windscreen ventilation/defrosting mode on/off

MENU Operate Climatronic in the Infotainment system

OFF Switch Climatronic on/off

With a temperature setting outside of the number range, one of the following icons will be displayed in the Climatronic display.

LO Maximum cooling power

HI Maximum heating power

**i** During operation of the air conditioning system, there may be an automatic increase in the engine idle speed.

### Recirculated air mode

The recirculation mode prevents contaminated outside air getting into the Interior of the vehicle.

Briefly switching on recirculation mode can increase the cooling effect.

### ⚠ WARNING

Risk of an accident!

In recirculation mode, there is no fresh air supply from the outside. This can result in loss of driver attention and fogging up of windows.

- ▶ Keep the recirculation mode switched on for a short time only.

## Settings

### Displaying the settings menu

› Tap the **MENU** button on the Climatronic.

Or:

› Tap on **MENU** > in the Infotainment screen.

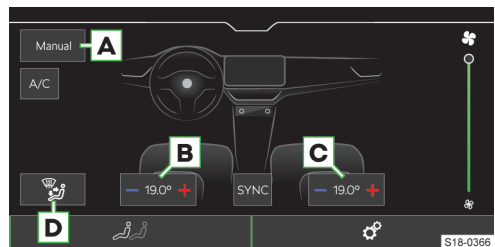

- A** Select Climatronic mode
- B** Set the temperature for the left side
- C** Set the temperature for the right side
- D** Set the direction of the air outlet in manual mode

**A/C** Switch the cooling system on/off

- ☞ According to the selected Climatronic mode:
  - ▶ Manual mode - Set the blower speed
  - ▶ Automatic mode - Set the operating power

**SYNC** Switch maintenance of the interior temperature on/off according to the temperature setting for the driver's side

**Further Climatronic settings**

- ▶ To make further settings, press the **MENU** button on the Climatronic >, tap on ☞ in the Infotainment screen.
  - ▶ *Automatic supplementary heater* - Switch fast interior heating on/off.
  - ▶ *Automatic windscreen heating* - Switch automatic windscreen heating on/off.

**Troubleshooting**

**Water under the vehicle**

When the cooling system is switched on, water can drip off the air conditioning system. This is not a leak.

**Fogging**

- ▶ Increase the blower speed and switch on the cooling system.

**Automatic switch-off of the cooling system**

If the coolant temperature is too high, the cooling system may switch off automatically. This ensures sufficient engine cooling.

**Driver information system**

**Analogue instrument panel**

**Overview**

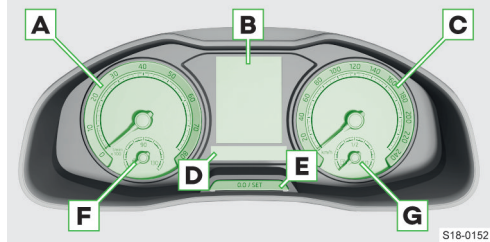

- A** Tachometer with indicator lights
- B** Display with indicator lights
- C** Speedometer with indicator lights
- D** Bar with warning lights
- E** Multifunction button:
  - ▶ Setting the time
  - ▶ Reset counter for distance travelled (trip)
  - ▶ Show distance and days until next service appointment
- F** Coolant temperature gauge
- G** Fuel gauge

**i** In poor visibility and with dipped headlights off, the brightness of the instrument cluster lighting is reduced to remind the driver to turn on the light.

**Settings**

**Setting the language**

The language is set in the following menu in the Infotainment system.

**MENU** > ☞

**Resetting the odometer**

- ▶ Briefly press the button in the instrument cluster.

**Set time**

- ▶ Press and hold the button in the instrument cluster until the **Time** menu item is shown in the display.
  - ▶ Release the button, the display shows the hour setting.
  - ▶ Press the button repeatedly to set the hours.
  - ▶ Wait 4 seconds, the display shows the minute setting.
  - ▶ Press the key repeatedly to set the minutes.

- › Wait 4 seconds, the display shows the initial setting.

The time is set in the Infotainment system in the following menu.

MENU > 

### Setting the brightness of the instrument cluster lighting

The brightness of the instrument lighting is adjusted automatically according to the given lighting conditions.

When low beam is switched on, the brightness of the instruments lighting can be adjusted in the following menu in the Infotainment system.

CAR >  > 

Or:

MENU >  >  > 

## Digital instrument cluster

### Overview

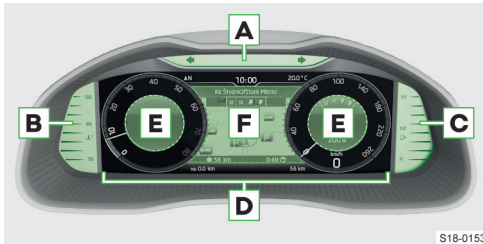

S18-0153

- A** Bar with indicator lights
- B** Coolant temperature gauge
- C** Fuel gauge
- D** Display - 5 possible display variants
- E** Additional Information
- F** Central display area

### Settings

#### Setting the language

The language is set in the following menu in the Infotainment system.

MENU > 

#### Resetting the odometer

The odometer is reset in the following menu in the Infotainment system.

CAR >  > 

Or:

MENU >  >  > 

#### Set time

The time is set in the following menu in the Infotainment system.

MENU > 

#### Setting the brightness of the instrument cluster lighting

The brightness of the instrument lighting is adjusted automatically according to the given lighting conditions.

When low beam is switched on, the brightness of the instruments lighting can be adjusted in the following menu in the Infotainment system.

CAR >  > 

Or:

MENU >  >  > 

#### Set the variant of the display

- › Press the **VIEW** button on the multifunction steering wheel to change the variant of the display presentation.

#### Select displayed variants

- › Press and hold the **VIEW** button on the multifunction steering wheel.
- › Select the menu item *Display layout* and confirm.
- › Select one of the following variants of the display and confirm.



S18-0156

- A** Classic display
- B** Advanced display
- C** Modern display
- D** Basic display
- E** Sporty display

#### Choose display of additional information

- › Press and hold the **VIEW** button on the multifunction steering wheel.
- › Select and confirm one of the following prefix options (the scope of the prefix options depends on the type of Infotainment).
  - ▶ **Auto** - Information depending on the selected driving mode

- ▶ **Classic** - Information about the selected gear and the current speed
- ▶ adjustable pre-selection options

**Setting the pre-selection option for the display of additional information**

The pre-selection option for displaying additional information is set in the Infotainment system in the following menu.

**CAR** > > > Virtual Cockpit

Or:

**MENU** > > > Virtual Cockpit

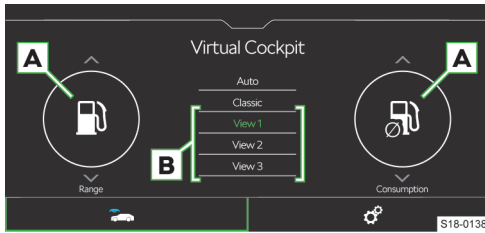

- ▶ Select the desired additional information in the **A** areas.
- ▶ The desired function area for the preselection option in the area **B** hold to save the selection (the scope of the preset options depends on the type of Infotainment).

**Instrument cluster display**

**Display overview and overview of the menu items in the main menu**

Depending on the equipment, the following information is shown in the display.

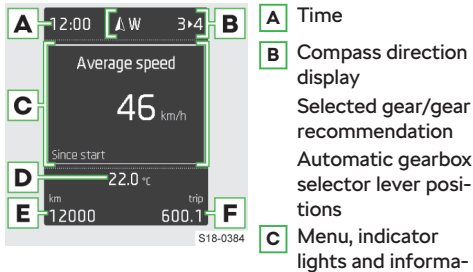

- A** Time
- B** Compass direction display
- C** Selected gear/gear recommendation
- Automatic gearbox selector lever positions
- C** Menu, indicator lights and information
- D** Outside temperature
  - ❄ or ❄ - low outside temperature
- E** Total distance travelled
- F** Trip - Distance travelled after resetting the memory

**Main menu items**

- ▶ Driving data » page 51

- ▶ Assist systems - Activate/deactivate assist systems
- ▶ Navigation - e.g. Display driving recommendations, compass, list of destination
- ▶ Audio - Using radio and media
- ▶ Telephone - Call list, accept or reject an incoming call
- ▶ Vehicle - Vehicle condition » page 52

**Operation**

**Operation via the control lever**



- A** Press - Switch between menu items/set values
- Hold** - Show main menu
- B** Press - Confirm the menu item

**Operation via the multifunction steering wheel**

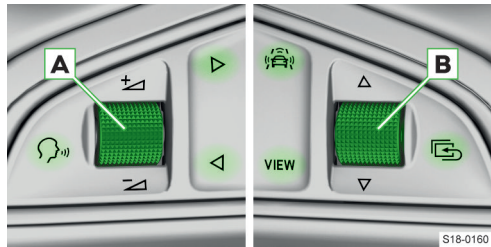

- Switch voice control on/off
- A** Rotate - Adjust the volume
- Press** - Switch the sound off/on
- ▶ Switch to the next track/station
- ◀ Switch to the previous track/station
- Show menu of assist systems
- VIEW** Depending on the equipment:
  - ▶ **Press** - Show previous menu (if one has been selected) / Show telephone menu
  - Or:
    - ▶ **Press** - Change the display
    - ▶ **Hold** - Display the menu of preset options with additional information
- B** Rotate - Switch between menu items/Set values/Manually change map scale
- Press** - Confirm the menu item
- Turn and press** - Activate automatic map scale changing
- Press** - Return to the menu one level higher
- Hold** - Show main menu



## Driving data

### Overview

The driving data display works with the ignition switched on.

#### In the instrument cluster display

- ▶ **Range** - Travel distance that can be covered with the existing tank fill level and the same driving style
- ▶ **AdBlue®-range** - Travel distance that can be covered with the existing AdBlue® tank fill level and the same driving style
- ▶ **Average fuel consumption**
- ▶ **Current fuel consumption**
- ▶ **Oil temperature** - If the temperature is less than 50°C or if there is a system error --- is displayed
- ▶ **Speed limit warning** » page 52
- ▶ **Current driving speed**
- ▶ **Average speed**
- ▶ **Distance travelled**
- ▶ **Driving time**

#### In infotainment

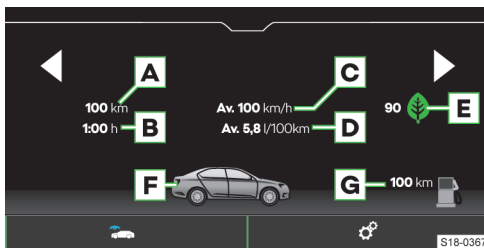

- A** Distance travelled
- B** Driving time
- C** Average speed
- D** Average fuel consumption
- E** Evaluation of driving economy - **Drive GreenFunction** (depending on Infotainment type) » page 116
- F** Graphical fuel gauge - If the expected range is less than 300 km, the vehicle slowly approaches the symbol
- G** Range

#### Memory

The system saves the driving data in the following memories.

From start or "1" (depending on display type)

- ▶ Driving data from the time of switching on the ignition until the ignition is switched off again is stored in the memory. If the journey is interrupted for more than 2 hours, the memory will be reset.

Long term or "2" (depending on display type)

- ▶ The driving data of all trips up to a total of 99 hours and 59 minutes driving time or 9999 km driving distance is stored in the memory. If one of the listed values is exceeded, the memory is reset.

From refuelling or "3" (depending on display type)

- ▶ Driving data from the time the fuel tank was last filled is stored in the memory. The memory is reset the next time the tank is filled.

### Operation

#### Display driving data in the display of the instrument cluster via the operating lever

- › The menu item *driving data* in the main menu in the display of the instrument cluster.



- A** Press - Select information/Set values
- B** Press - Confirm information

#### Display driving data in the display of the instrument cluster via the multi-functional steering wheel

- › The menu item *driving data* in the main menu in the display of the instrument cluster.

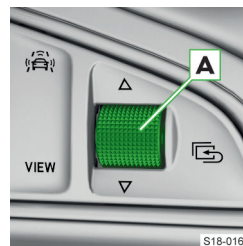

- A** Rotate - Select information/Set values
- Press - Confirm information

#### Displaying driving data in the infotainment system

The driving data is displayed in the menu in the infotainment system.

**CAR** > > *Driving data*

Or:

**MENU** > > > *Driving data*

#### Select and reset the memory for driving data in the display of the instrument cluster using the control lever



- › To **set** the memory for the displayed driving data, press button **A** repeatedly.

- › To **reset** the memory, press and hold button

**A**.

**Select memory for driving data in the display of the instrument cluster via the multifunction steering wheel and reset it**

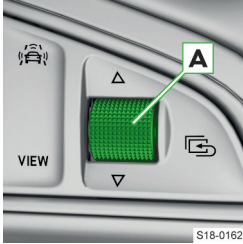

- > To **set** the memory for the displayed driving data, press selection wheel **A** repeatedly.
- > To **reset** the memory, hold the dial **A**.

**Selecting the memory in the infotainment system**

To select the memory, use the functional areas ◀ ▶ in the following menu in the infotainment system.

**CAR** > 🚗 > Driving data

Or:

**MENU** > 🏠 > 🚗 > Driving data

**Resetting the memory in the infotainment system**

The memory is reset in the following menu in the infotainment system.

**CAR** > 🚗 > 🏠

Or:

**MENU** > 🏠 > 🚗 > 🏠

**Settings**

**Select driving data to be displayed**

The driving data to be displayed is selected in the following Infotainment menu:

**CAR** > 🚗 > 🏠

Or:

**MENU** > 🏠 > 🚗 > 🏠

**Setting units**

The units are set in the following infotainment menu:

**CAR** > 🚗 > 🏠

Or:

**MENU** > 🏠 > 🚗 > 🏠

**Speed limit warning**

**Usage**

The system offers the possibility to set a speed limit beyond which an acoustic warning signal will sound and the following warning message appears in the display of the instrument cluster.

**Setting**

**Setting the speed limit**

- > Select and confirm the Warning menu item at or ⊕ (depending on display type).
- > **When the vehicle is stationary**, set the desired speed limit and confirm.
- > **While driving**, drive at the desired speed and confirm it as the speed limit.

**Resetting the speed limit**

- > Select and confirm the Warning menu item at or ⊕ (depending on display type).
- > To reset the speed limit, confirm the stored value.

If the journey is interrupted for more than 2 hours, the set limit is deactivated, but the set value remains stored.

**Vehicle condition**

**Display**

The vehicle status is displayed in the following menu in the Infotainment system.

**CAR** > 🚗 > Vehicle status

Or:

**MENU** > 🏠 > 🚗 > Vehicle status

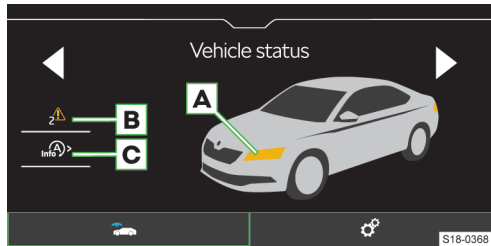



- A** Vehicle areas displayed in colour indicate associated warnings.
- B** ✓ No notification  
⚠ Warning messages regarding the vehicle condition and their quantity
- C** info > Display of information about the condition of the START-STOP system  
▶ On / Off Activation/deactivation of information regarding the messages of the START-STOP system in another screen display

**Functionality**

In the event of a system fault, messages regarding the fault in question are displayed on the instrument cluster display when the ignition is switched on.



Messages in relation to faults can also be displayed in the Infotainment.

**i** The warning messages will continue to be displayed until the malfunctions have been remedied. After the message is displayed for the first time, only the indicator lights  (Hazard) or  (Warning) remain displayed.

## Infotainment Swing

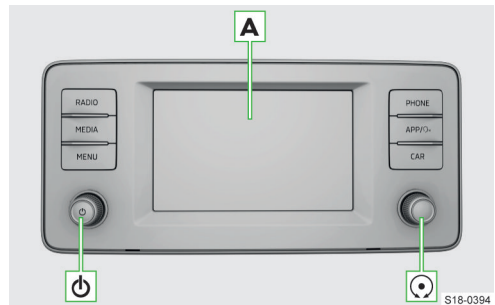
### Infotainment overview



- A** Touchscreen
-  Rotary control on the left
  - ▶ **Press:** Switch Infotainment on/off
  - ▶ **Turn:** Adjust Volume
-  Rotary control on the right
  - ▶ **Press:** Confirm menu item
  - ▶ **Turn:** select menu item/set value

**RADIO** Radio menu

**MEDIA** Media menu

**MENU** All menus

**PHONE** Phone menu

**APP/VOX** SmartLink menu

- ▶ **Press:** Display menu
- ▶ **Hold:** switch voice control for the SmartLink application on/off

**CAR** Information about vehicle settings

## System

### Control centre

#### Usage

The Infotainment control centre provides quick access to the following functions.

- ▶ Setting the instrument and key illumination.
- ▶ Setting the personal data protection level.
- ▶ Functional surfaces of preferred features.

#### Opening the control centre



- ▶ Press the bar at the top of the screen and drag down.

#### Closing the control centre

- ▶ Tap on .

Or:

- › Press the bar at the bottom of the screen and drag up.

Or:

- › Wait 5 seconds.

### Settings

- › To **open edit mode**, tap on an empty functional surface or press the occupied functional surface of the preferred feature.
- › To **add the preferred feature**, tap on the functional surface of the desired function.
- › To **remove the preferred feature**, tap on  $\text{m}$ .
- › To **close edit mode**, tap on  $\times$ .

### Restriction

For safety reasons, operation of some Infotainment functions while driving is not possible or is restricted.

The Infotainment system indicates this by means of a message in the screen.

### Basic settings

#### Setting basic functions

The following Infotainment functions are set in the **MENU** >  $\text{g}$  menu.

- ▶ Time and date.
- ▶ Language.
- ▶ Units.
- ▶ Restore factory settings.

#### Sound settings

The Infotainment sound is set in the menu **MENU** >  $\text{h}$ .

The following menu items can be set.

- ▶ Setting the equalizer.
- ▶ Adjusting the volume ratio.
- ▶ Volume adjustment of individual Infotainment functions.  
Some are adjustable, for example the following menu items.
  - ▶ Volume adjustment of voice commands.
  - ▶ Setting the maximum volume when Infotainment is turned on.
  - ▶ Speed-dependent volume setting.
  - ▶ Setting the Infotainment to mute with the parking aid switched on.

Depending on the equipment, the following advanced sound settings can be set.

- ▶ Setting space optimisation.
- ▶ Setting the audio profiles according to genre.
- ▶ Adjusting the subwoofer volume.

### Configuration wizard

The configuration wizard helps to set certain Infotainment functions.

The configuration wizard is automatically displayed if there are at least two non-selected menu items after turning on the Infotainment.

- › To **switch off the automatic display**, tap on *Don't show again* when the configuration wizard is displayed.
- › For **manual display**, tap on **MENU** >  $\text{g}$  > *Configuration wizard*.

### Setting the MENU

The position of the functional surfaces in the MENU menu can be customized as follows.

- › Press and hold the desired functional surface until it is free.
- › Move the functional surface to a different position.

### Safely disconnect the connected USB device

#### ① NOTICE

Risk of damage to the data on the connected USB device!

To safely disconnect a USB device, proceed as follows.

- › Tap **MENU** >  $\text{g}$  > *Remove safely*.
- › Select the desired device.
- › Disconnect the USB device.

### Troubleshooting

#### Infotainment not responding

The Infotainment system must be restarted.

- › Press  $\text{O}$  for more than 10 s.
- › Wait for the restart to complete.

### System update

#### We recommend having the system update carried out by a specialist company.

The system update ensures optimal function of the Infotainment system, e.g. compatibility with new phones.

#### Determine system version

- › Tap **MENU** >  $\text{g}$  > *System information*.

## Screen

### Overview

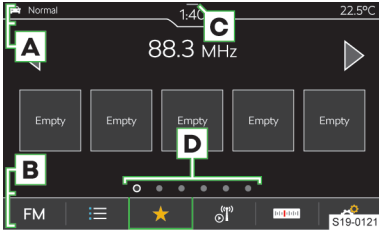

- A** Status bar
- B** Bar with the functional surfaces of the displayed menu
- C** Display of the control centre
- D** Other pages of the menu

### Operation

#### ① NOTICE

Danger of screen damage!

- ▶ The Infotainment screen is operated **by touching it lightly with your finger**.

In principle, operation by touch is identical to the operation of a mobile phone.

The following operating modes are specific to the Infotainment system.

#### Dragging up or down with two fingers

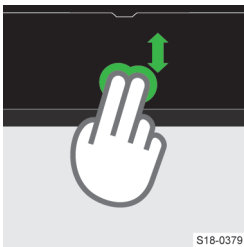

- ▶ Quickly review the list of phone contacts.

### Settings

The following basic screen functions are set in the **MENU** > > **Screen** menu.

- ▶ Brightness level of the screen.
- ▶ Switch off the screen.
- ▶ Display the time.
- ▶ Confirmation sounds and animations.

## Infotainment keyboard

### Keyboard overview

The arrangement of the keypad characters depends on the Infotainment language that has been set.

In Infotainment, the following types are used, depending on the context.

- ▶ Alphanumeric.
- ▶ Numeric.
- ▶ Keypad for input.
- ▶ Keypad for search.



#### Keypad example

- A** Line input
  - ▶ Delete characters before the cursor
  - ▶ **Tap:** delete the last character
  - ▶ **Hold:** delete all characters one after the other
- ≡ Show list of searched entries
- B** Keypad functional surfaces
  - ▶ Switch to lowercase/uppercase
  - ▶ **ABC/ABB** Switch to the language keypad
  - ▶ **123** Switch to the numeric and character keypad
  - ▶ Show additional keypad languages
  - ▶ Insert a space
  - ▶ **Hold:** Show additional character variants
  - ▶ Move cursor to the left
  - ▶ Move cursor to the right
  - ▶ **OK** Confirm the characters that have been entered

### Numeric keypad

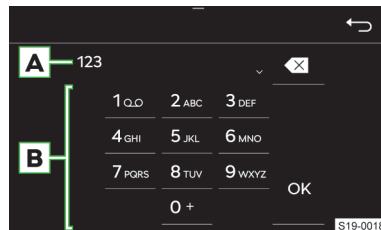

#### Keypad example

- A** Line input

- ▶ Delete characters before the cursor
- ▶ **Tap:** delete the last character
- ▶ **Hold:** delete all characters

**B** Keypad functional surfaces

- ▶ Confirm the characters that have been entered
- I** If dependent on context, alphanumeric characters can be entered by holding down a function area with the number.

**Operation**

The Infotainment keypad is used to enter characters, letters and numbers.

The keypad will be **automatically displayed** when Infotainment prompts for characters.

**Find**

During the character input, a search for corresponding entries takes place.

The entry to be searched can be entered, including diacritics.

The keypad will only provide characters that match the stored entries.

- ▶ To **display the searched entries**, tap .

**Show additional keypad languages**

To use the additional keypad languages, the desired languages must be set first.

- ▶ Tap or repeatedly tap the flag symbol until the desired language keypad is displayed.

**Further character variants**

- ▶ Press and hold the sign with the symbol .
- ▶ Select the desired symbol.

**Setting additional keypad languages**

- ▶ Tap **MENU** > > *Additional keypad languages*.

**Radio**

**Overview**

**Display main menu**

- ▶ Tap on **RADIO**.
- Or:
- ▶ Tap on **MENU** > .

**Analogue and digital radio reception**

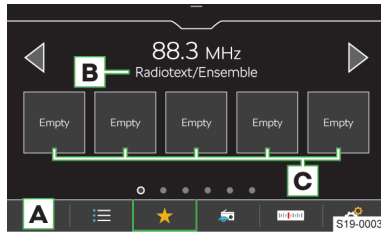

- A** Select frequency range
- B** Depending on the frequency range  
**FM:** Radio text  
**DAB:** Radio text: name of the station group
- C** Preset buttons for preferred stations
  - List of available stations
  - Show favourites
  - Show information about the station
  - Search stations manually (valid for AM and FM)
  - Settings

**I** Infotainment supports digital radio reception in DAB and DAB+ formats.

**List of available stations**

- ▶ Tap on .
- Played station
- Station stored on the presets
- TP** A traffic radio station is set
- DAB signal is not available
- Filter the stations in the list according to the programme type, e.g. culture, music, sports, etc.  
**FM:** when the RDS function is switched on
- Manual update of the station list

In the station list, information about the program type and the type of the regional station can be displayed.

**Operation**

**Select station**



- ▶ Tap or at the top of the screen.

**SCAN function**

The function plays receivable stations of the selected frequency range in succession for a few seconds each.

- › To **start automatic play** press > Scan or the right rotary control .
- › To **end automatic play** press or the right rotary control .

**Search for stations manually**

Manual search is available for AM and FM stations.

- › In the Radio main menu, tap .
- › For a **consecutive search**, tap or next to the displayed frequency range scale.

Or:

- › Hold down the scroll mark on the frequency range scale and move it to the intended value.

Or:

- › Turn the right rotary control.

**Restriction**

- ▶ Parking garages, tunnels, tall buildings or mountains can restrict radio reception.
- ▶ In the rear side windows, there are antennas for receiving the radio signal.

Covering the panes with foils or metal-coated labels may affect the reception of the radio signal.

**Settings****Save the station currently being listened to as a favourite from the Radio main menu**

- › Hold the desired station key for preferred stations until the station is stored.

**Save station to favourites from the list of available stations**

- › Hold the line with the name of the desired station.
- › Tap the desired preset button.

**Delete favourites**

- › In the **Radio** main menu, tap > Delete presets.
- › To delete **one** preset button for preferred stations, tap the desired station button and confirm the deletion.
- › To delete **all** preset buttons for preferred stations, tap *All* and confirm the deletion.

**Buttons**

Applies to AM, FM and DAB frequency ranges.

The variant for **changing stations** using buttons in the **Radio** main menu is set as follows.

- › In the **Radio** main menu, tap > Arrow buttons.

- › Choose the change variant.

**Traffic reception (TP) for FM stations on/off**  
Applies to the FM frequency range.

- › In the **Radio** main menu, tap > Traffic program (TP).

**Switch traffic reception for DAB stations on/off**  
Applies to the DAB frequency range.

- › In the **Radio** main menu, turn on menu item > Traffic Radio (TP).
- › In the **Radio** main menu, tap > Advanced settings > DAB traffic programme (TP) on/off.

**Assign station logos**

Applies to AM, FM and DAB frequency ranges.

Infotainment offers the option to assign logos from the pictures on an external source to the station buttons.

For station logos, images in jpg, gif, png, bmp format with a maximum resolution of 500x500 pixels can be used.

- › In the **Radio** main menu, tap > Station logos.
- › Tap the desired preset button.
- › Select the external source with the logo.
- › Find the desired logo and confirm.

**Delete station logos**

Applies to AM, FM and DAB frequency ranges.

- › In the **Radio** main menu, tap > Station logos.
- › To delete **a logo**, tap the desired preset button and confirm the deletion.
- › To delete **all** logos, tap on *All* and confirm the deletion.

**Switch on/off autostore of logos for stations to be stored to Favourites**

Applies to FM and DAB frequency ranges.

When the function is switched on, a station logo from the Infotainment memory is assigned when the station is stored on a preset button.

- › In the **Radio** main menu, tap on > Advanced settings > Autostore station logos.

**Regional FM station logo**

Applies to the FM frequency range.

Infotainment provides the option of using country-specific FM station logos.

- › In the **Radio** main menu, tap on > Advanced settings > Region for station logo.
- › Choose the country.

**Turn on/off radio text reception**

Applies to the FM and DAB frequency ranges.

When the function is switched on and station presets are displayed, detailed information about the broadcast content of the station being listened to, or



the name of the station group for the DAB station, is displayed.

- › In the **Radio** main menu, tap  › *Radio text*.

#### **Switch automatic frequency control (AF) on/off** *Applies to the FM frequency range.*

When the function is switched on and the signal of the FM station currently being listened to is weak, Infotainment automatically sets the same station to a different frequency with a better signal.

- › In the **Radio** main menu, tap on  › *Advanced settings* › *Automatic frequency control (AF)*.

#### **Automatic change of frequency to a regionally linked FM station**

*Applies to the FM frequency range.*

Infotainment provides the option of automatically switching to a regionally linked FM station in case of signal loss of the FM station being listened to.

- › In the **Radio** main menu, tap on  › *Advanced settings* › *RDS Regional*.
- › Select one of the following menu items.
  - ▶ *Fixed* - If there is a loss of signal, another station must be set manually.
  - ▶ *Automatic* - automatic selection of the station with the best signal reception.

If reception is lost in the given region, Infotainment will automatically set another available region.

#### **Sort stations in the list of available stations** *Applies to the FM frequency range.*

- ▶ In the **Radio** main menu, tap on  › *Advanced settings* › *Sort station list*.
- ▶ Select the sorting of stations in alphabetical order or by group.

#### **Switch RDS on/off**

*Applies to the FM frequency range.*

*This menu item is only available in some countries.*

- › In the **Radio** main menu, tap on  › *Advanced settings* › *Radio Data System (RDS)*.

If the **RDS function is disabled**, the following menu items in the **FM transmitters** settings are not available.

- ▶ Traffic programme (TP).
- ▶ Radio text.
- ▶ RDS Regional.
- ▶ Automatic frequency control (AF).
- ▶ Regional station logos.
- ▶ Sorting of stations in the list of available stations.

#### **Switch additional DAB announcements on/off** *Applies to the DAB frequency range.*

When the function is switched on, other announcements are received as traffic announcements. For ex-

ample, weather news, sports reports, financial news, etc.

- › In the **Radio** main menu, tap on  › *Advanced settings* › *Other DAB announcements*.

#### **Enable/disable automatic programme tracking of a DAB station**

*Applies to the DAB frequency range.*

When the function is switched on and the DAB station is lost, Infotainment automatically changes to the same station with a better signal in a different DAB station group.

- › In the **Radio** main menu, tap on  › *Advanced settings* › *DAB - DAB station tracking*.

#### **Turn on/off automatic switching from a DAB station to the same FM station**

*Applies to the DAB frequency range.*

When the function is switched on and the DAB station being listened to is lost, Infotainment automatically changes to the same FM station. The symbol (FM) is displayed after the station name.

When the corresponding DAB station can be received again, the station automatically changes from FM to DAB.

- › In the **Radio** main menu, tap on  › *Advanced settings* › *Automatic DAB - FM switching*.

#### **Turn on/off automatic switching to a similar DAB station**

*Applies to the DAB frequency range.*

When the function is switched on and DAB station being listened to is lost, Infotainment automatically changes to another DAB station with similar content.

- › In the **Radio** main menu, tap  › *Advanced settings* › *Switch to a similar station*.

## Media

### **What you should be mindful of**

- ▶ Do not save any important data or that which has not been backed up on the connected audio sources. ŠKODA assumes no responsibility for lost or damaged files or connected audio sources.
- ▶ When changing or connecting an audio source, this may cause sudden changes in volume. Reduce the volume before changing or connecting an audio source.
- ▶ When connecting an audio source, the source information messages can be displayed. These messages must be observed and, if necessary, confirmed.
- ▶ The national copyright laws that apply in your country must be observed.

## Overview

### Display main menu

› Tap on **MEDIA**.

Or:

› Tap on **MENU** › .

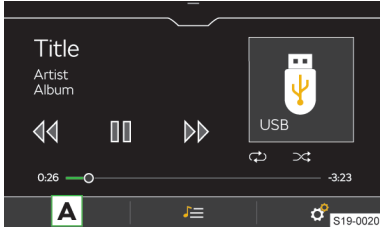

 Select source

 Manage files/multimedia database

 Settings

## Player controls

### Operation - Basics

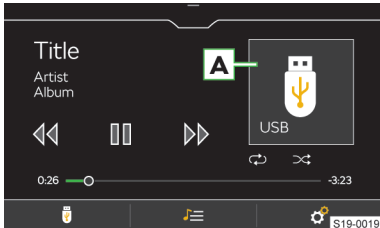

 Album picture/symbol of the connected source

▷ **Tap:** start playback

▢ **Tap:** pause

◀◀ **Tap within 3 seconds of starting playback:** play the previous title

◀◀ **Tap after 3 seconds of the starting playback:** play the current title from the beginning

◀◀ **Hold:** fast rewind within the title

▷▷ **Tap:** play the next title

▷▷ **Hold:** fast forward within the title

Movement within the title is also possible by dragging your finger over the timeline.

### Extended operation

↺ Turn repeat playback of the current track on/off

↻ Turn repeat playback of the current album/folder on/off

⌘ Turn random playback of the current album/folder on/off

## Settings

### Turn title playback including subfolders on/off

› In the **Media** main menu, tap on  › *Mix/Repeat including subfolders*.

### Enable/disable playback of online media from an Apple device

› To **turn on/off** in the **Media** main menu, tap on  › *Include online media from an iPod*.

Under the following conditions, media in the Apple iCloud is included in the list of available media.

✓ The mobile device is not connected using Apple CarPlay.

✓ The mobile device is connected to Apple iCloud.

### Traffic

› To **turn on/off** the traffic monitoring during the playback of media files, go to the **Media** main menu and tap on  › **Traffic programme (TP)**.

### Safely disconnect the connected USB device

#### ⓘ NOTICE

Risk of damage to the data on the connected USB device!

To safely disconnect a USB device, proceed as follows.

› In the **Media** main menu, tap  › *Remove USB safely*.

› Select the desired device.

› Disconnect the USB device.

## Supported sources and files

Source	Interface	Type	Specification	File system
USB	USB 1.x; 2.x 3.x or higher with USB 2.x support	MSC	USB stick	VFAT FAT16 FAT32 exFAT NTFS
			HDD (without special software)	
		USB devices that use the USB mass storage support protocol		
		MTP	Devices running the Android or Windows Phone operating system that support the Media Transfer Protocol	
		Apple	Devices with an iOS operating system	HFS+
Bluetooth® player	Bluetooth®	-	Bluetooth® protocols A2DP and AVRCP (1.0 - 1.5)	-

Supported sources

❗ Apple iAP1 protocol is not supported by Infotainment.

**Compatibility of mobile devices**

It is possible to check the ŠKODA web pages to see if Infotainment is compatible with the selected mobile device being tested. This check is carried out by using the following reference or by reading the QR code.

► <http://go.skoda.eu/compatibility>



Compression format	Codec type	File extension	Max. bit rate [kbps]	Max. sampling rate [kHz]	Multi channels
MPEG	MPEG 1 Layer 3	mp3	32 - 320	32, 44, 48	Mono, dual mono, Stereo, Joint Stereo
	MPEG 2 Layer 3				
	MPEG 2.5 Layer 3	mp3	8 - 160	16, 22, 24 8, 11, 12	Mono, Stereo, Joint Stereo
WMA	Windows Media Audio 9 and 9.1	wma	8 - 384	8, 11, 12, 16, 22, 32, 44, 48	Mono, Stereo, Joint stereo
	Windows Media Audio 9.2		8 - 320		
	Windows Media Audio 10		8 - 768	32, 44, 48, 96	
ADTS	AAC LC	aac	8 - 640	22, 24, 32, 44, 48	Mono, Stereo
	AAC HE		8 - 320		
	AAC HEv2		16 - 64	32, 44, 48	

Compression format	Codec type	File extension	Max. bit rate [kbps]	Max. sampling rate [kHz]	Multi channels
FLAC	FLAC	flac	-	8, 11, 12, 16, 22, 24, 32, 44, 48, 64, 88, 96	Mono, Stereo, 5.1, 7.1
RIFF	WAV	wav	64 - 3072	8, 11, 12, 16, 22, 24, 32, 44, 48, 96	Mono, Stereo
SBC	Bluetooth A2DP	-	8 - 345	44, 48	Mono, Stereo, Joint stereo

Supported audio files

**I** For files in MP4 format, only the soundtrack playback is carried out.

Files that are protected by the **DRM**- and **iTunes®** methods are not supported by Infotainment.

Codec type	File extension
M3U	m3u
M3U8	m3u8
PLS	pls
WPL	wpl
ASX	asx
PLA	pls

Supported playlists

## Mobile device management

### Overview

Using mobile device management, devices can be connected, disconnected, and interchanged.

### Display mobile device management

› Tap on **PHONE** ›  › Select mobile phone › .

Or:

› Tap on **MENU** ›  ›  mobile devices.

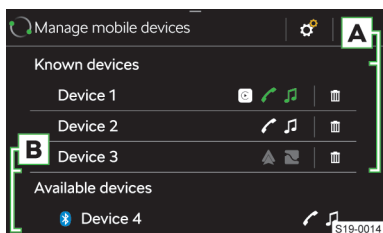

- ✓ The device enables a connection via the Bluetooth® "hands-free profile"
- ✓ The device is connected via the Bluetooth® "hands-free profile"
- 🎵 The device enables a connection via the Bluetooth® audio profile
- 🎵 The device is connected via the Bluetooth® audio profile

- ▲ The device enables a SmartLink connection to be made via Android Auto
- Remove the device from the list **previously connected devices**
- Ⓞ The device enables a SmartLink connection to be made via Apple CarPlay
- ☑ The device enables a SmartLink connection to be made via MirrorLink
- A** Connected / Previously connected devices
- B** Available devices

### Limitations of mobile devices and applications

#### Availability of features

The availability of certain features depends on the type of mobile device, as well as that of the applications installed.

#### Compatibility of mobile devices

It is possible to check the ŠKODA web pages to see if Infotainment is compatible with the selected mobile device being tested. This check is carried out by using the following reference or by reading the QR code.

► <http://go.skoda.eu/compatibility>



### Bluetooth® compatibility of mobile devices

Due to the large number of mobile devices, it is not possible to guarantee total Bluetooth® compatibility with Infotainment. Bluetooth® compatibility depends on the Bluetooth® version as well as the implementation of Bluetooth® protocols by the manufacturer of the mobile device.

### Applications in mobile devices

Mobile devices can be used to install applications that allow you to view additional information on the Infotainment screen, or to operate the Infotainment system.

Due to the variety of applications, as well as their ongoing development, the available applications may not function on all mobile devices. ŠKODA AUTO assumes no liability for their proper functioning.

The scope of available applications and their functionality is dependent on the type of Infotainment, as well as the vehicle and country.

## Connection set-up

### Connect a mobile device to Infotainment

- › Find available Bluetooth® devices in the mobile device.
- › Select the Infotainment Bluetooth® unit.

The name of the unit can be found under the menu item **MENU** › › Bluetooth › Name..

- › Confirm the PIN; enter it if necessary and then confirm.

### Connect Infotainment to a non-paired mobile device

- › Tap on **PHONE** › › Select mobile phone › .
- › Select the desired device from the list of **available devices**.
- › Select the desired Bluetooth® profile.
- › Confirm the PIN; enter it if necessary and then confirm.
- › If two devices are connected to the Infotainment, select the device to be replaced.

### Connect Infotainment to a previously connected mobile device

- › Tap on **PHONE** › › Select mobile phone.
- › Select the desired device from the list of **previously connected devices**.
- › Select the desired Bluetooth® profile.
- › If two devices are connected to the Infotainment, select the device to be replaced.

### SmartLink Connection

Infotainment provides the ability to connect SmartLink to compatible mobile devices using the following connection types.

- ▲ Android Auto
- 📱 Apple CarPlay
- 📺 MirrorLink

Mobile devices can be connected to the Infotainment via USB cable or Wi-Fi, as long as the mobile device supports it.

- › Connect the mobile device to the Infotainment.
- › Tap the icon of the supported connection.

## Telephone

### Telephone main menu

#### Display main menu

- › Tap on **PHONE**.

Or:

- › Tap on **MENU** › .

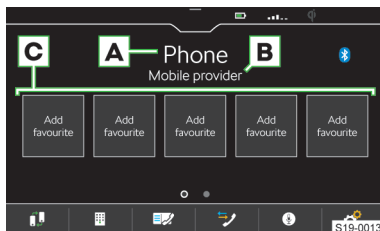

- A** Name of the connected telephone
  - ▶ **Tap:** Show list of previously connected phones
- B** Name of telephone service providers
- C** Preset buttons for preferred contacts
- Change the main telephone with the additional telephone
- Enter telephone number
- Contact list
- Call lists
- Switch on voice control for the connected telephone
- Settings

### Conditions for connecting a telephone with Infotainment

- ✓ The Bluetooth® function of the Infotainment and the telephone need to be switched on.

The Bluetooth® function of the Infotainment is switched on in the menu item **MENU** ›  › Bluetooth › Bluetooth.

- ✓ Visibility of the Infotainment is switched on.  
The visibility of the Infotainment is switched on in the menu item **MENU** ›  › Bluetooth › Visibility.
- ✓ The telephone is within signal range of the Infotainment's Bluetooth® unit.
- ✓ The telephone is compatible with Infotainment.

## Telephone operation

### Enter telephone number

- › In the **Telephone** main menu, tap .
- › Enter the telephone number using the numeric keypad that is displayed.

 The displayed numeric keypad can also be used for searching for contacts. If, for example, the digits 32 are entered, contacts with the letter sequence DA, FA, EB etc. are displayed next to the numeric keypad.

### List of telephone contacts

The list of telephone contacts is imported from the connected main telephone.

- › Tap to **display** the contact list in the **telephone** main menu .
- › To **find** details within the list, tap *Find*.
- › Enter the details you wish to find.
- › To **establish a connection** with a contact, tap the functional area showing the desired contact.

If a contact has multiple telephone numbers, select the telephone number from the displayed list.









- › To display the **details** for a contact, tap >.

### Establish a connection to the voice mailbox number

- › In the **Telephone** main menu, tap  › .

### Telephone conversation

Depending on the context of the telephone conversation, the following functions can be selected.

-  End connection / reject incoming call / end call
-  Answer an incoming call / return to the held call
-  Switch the ringer off / on
-  Hold a call
-  Switch the microphone off / on
-  Show details of the caller
-  Answer a call from the second telephone during a call on the first telephone  
The ongoing call on the first telephone is terminated by accepting the call.
- › To **switch the call tone from the speakers to the telephone**, go to the **telephone** main menu and tap on  › hands-free.



- › To **switch the call tone from the telephone to the speakers**, tap .

### Conference call





A conference call is a joint telephone conversation with a minimum of three and a maximum of six participants.

- › Make the next call during an ongoing conversation/conference.



Or:

- › Accept a new incoming call by tapping the functional area .
- › To **start** a conference call, tap on the functional area .

During an ongoing conference call, the following functions can be selected depending on the context.

-  Hold the conference call and leave temporarily (the conference will continue in the background)
-  Return to the conference being held
-  Switch the microphone off / on
-  End the conference
-  Show details of the conference call

In the details of the conference call, depending on the connected telephone, the following functions can be selected.

-  Show details of the conference call participants
-  End conversation with the conference call participant
-  Conversation with a participant outside of the conference call

## Settings for Infotainment telephone functions

### Telephone-Infotainment-Connection types

The way in which the telephone is connected depends on the number of phones currently connected to the Infotainment.

- ▶ **No telephone** - The telephone is connected as a main telephone.
- ▶ **One telephone** - The telephone is connected as an additional telephone.
- ▶ **Two telephones** - Select the telephone to be replaced.
- › To **switch between the main telephone and the supplementary telephone** in the main menu, tap **telephone** .

### Connect the telephone to Infotainment

- › Find available Bluetooth® devices on the phone.
- › Select the Infotainment Bluetooth® unit.

The name of the unit can be found under the menu item **MENU** ›  › Bluetooth › Name.

- › Confirm the PIN; enter it if necessary and then confirm.

### Connect Infotainment to a non-paired telephone - no telephone is connected

- › Tap on **PHONE**.

Or:

- › Tap on **MENU** > ↗.
- › Follow the instructions in the Infotainment screen.

### Connecting Infotainment to a non-paired telephone - another telephone is connected

- › Tap on **PHONE** > ☎ > *Select mobile phone* > ☎.
- › Select the desired device from the list of **available devices**.
- › Select the desired Bluetooth® profile.
- › Confirm the PIN; enter it if necessary and then confirm.

The telephone is connected as an additional telephone.

Or:

- › If two telephones are connected to the Infotainment, select the telephone to be replaced.

### Connect Infotainment to a previously paired telephone

- › Tap on **PHONE** > ☎ > *Select mobile phone*.
- › Select the desired device from the list of **previously connected devices**.

The telephone is connected as an additional telephone.

Or:

- › If two telephones are connected to the Infotainment, select the telephone to be replaced.

### Manage preset buttons for preferred contacts

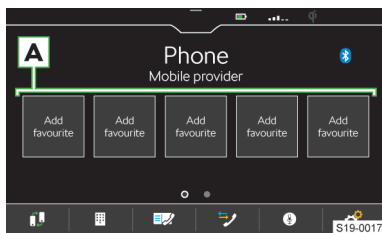

- › To **save** the desired preset button, press and hold **A**.
- › Select a contact from the displayed list.
- › Select a contact from the displayed list.
- › To **display the menu for deleting** go to the **Telephone** main menu and tap ☎ > *manage favourites*.
- › To delete **one** preset, tap on the list entry and confirm the deletion.

Or:

- › To delete **all** presets, tap on *All* and confirm the deletion.

### Import telephone contacts

After first connecting the main telephone with Infotainment, telephone contacts will start to be imported into the Infotainment memory.

Infotainment can import up to 2000 telephone contacts together with contact pictures. Each contact can include max. 5 telephone numbers.

Depending on the type of telephone, import confirmation may be required.

### Update telephone contacts

When re-connecting the telephone with Infotainment, an **automatic** update of the list is carried out.

- › For a **manual** update of the list in the **telephone** main menu, tap on ☎ > *User profile* > *Import contacts*.

### Sort contacts in the phonebook

- › In the **telephone** main menu, tap on ☎ > *User profile* > *Sort by*: and select the sort type.

### Ringer

Some phones do not allow the use of the telephone ringer; instead, the Infotainment ringer is used.

- › To set the Infotainment ringer in the **telephone** main menu, tap on ☎ > *user profile* > *Select ringtone*.
- › Select the ringtone.

### Number for the voice mailbox

- › To set the voice mailbox number in the **telephone** main menu, tap on ☎ > *user profile* > *Mailbox number*.
- › Enter the number of the voice mailbox.

### Simultaneous calls

*This applies to some countries.*

Depending on the connected telephone, it is possible to answer the next incoming call and hold the previous call.

- › To switch on simultaneous calls, tap on **telephone** ☎ > *Parallel talks*.

## Wi-Fi

### Functionality

Wi-Fi can be used for the SmartLinkConnection.

The Infotainment hotspot can connect up to 3 mobile devices.

- › To display the list of connected mobile devices, tap on **MENU** > ☎ > *Wi-Fi* > *Connected devices*.

### Settings

#### Connect a mobile device to the Infotainment hotspot

- › Turn on the Infotainment Wi-Fi hotspot in the menu item **MENU** > ☎ > *Wi-Fi* > *Wi-Fi hotspot*.



- › Turn on the Wi-Fi on the mobile device.
- › In the list of available Wi-Fi devices, look for Infotainment Wi-Fi.

The name of the Infotainment is taken from the menu item **MENU** › › *Wi-Fi* › *Network name*.

- › Select the Infotainment hotspot and enter the required password.

The password for connecting to the Infotainment hotspot is taken from the menu item **MENU** › › *Wi-Fi* › *Network key*.

- › Confirm the connection.

**Security level of the Infotainment hotspot**

The security level is factory-set at WPA2 and cannot be changed.

**Change password for connection to Infotainment hotspot**

The password must be a minimum of 8 and a maximum of 63 characters.

- ▶ Tap **MENU** › › *Wi-Fi* › *Network key*.
- ▶ Enter the password and confirm.

**SmartLink**

**Functionality**

SmartLink offers the ability to display and operate certified applications from a connected mobile device in the Infotainment screen.

Certification may be conditional upon the use of the latest update to the particular SmartLink application.

Applications include, for example, apps for route guidance, telephoning, listening to music, etc.

Mobile devices can be connected via a USB cable or Wi-Fi.

**Supported connection types**

SmartLink supports the following connection types.

- ▶ Android Auto.
- ▶ Apple CarPlay.
- ▶ MirrorLink.

**Overview of the SmartLink connection**

**Main menu SmartLink**

- › Tap on **APP**
- Or:
- › Tap on **MENU** ›

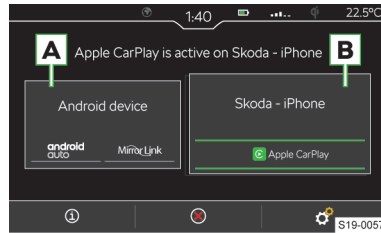

- A** Previously connected device
- B** Currently connected device
- Display information about SmartLink
- Separation of the active connection
- Settings for the SmartLink menu

**Android Auto**

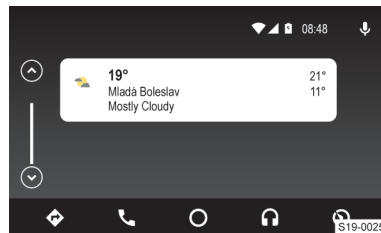

- Navigation applications
- Telephone applications
- Overview of running applications, phone calls, incoming text messages, and more.
- Music applications
- Display of other available applications as well as the option to return to the SmartLink main menu
- Turn on voice control (Google Voice)

**Apple CarPlay**

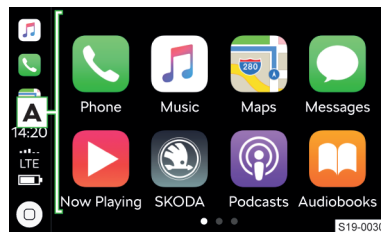

- A** List of available applications
- Depending on the duration of operation:
  - ▶ **Tap**: Return to the Apple CarPlay main menu
  - ▶ **Hold**: Switch on voice control (Siri)

## MirrorLink

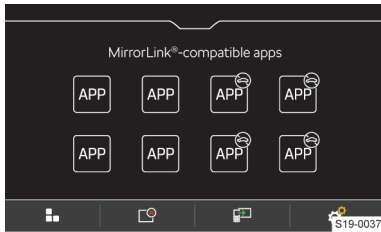

- ⊖ It is not possible to operate the application while driving
- Return to the SmartLink main menu
- ☰ List of running applications
- ☰ Display of the last running application in connected mobile devices
- ⚙ Settings

## Connection conditions

### General connection conditions

- ✓ The mobile device supports the following SmartLink connection types: Android Auto, Apple CarPlay and MirrorLink.
- ✓ Mobile devices, as well as the type of SmartLink connection, are supported in the respective market.
- ✓ Some connected mobile devices require the mobile device to be “unlocked”.

### Conditions for Android Auto

- ✓ The device to be connected must have Android AutoSupport.
- A list of devices, supported regions and applications that the Android Auto connection supports can be found on the websites of Google Inc..
- ✓ The Android Auto application needs to be installed on the mobile device.
  - ✓ Some applications require the data connection in the mobile device to be turned on.

### Conditions for Apple CarPlay

- ✓ The device to be connected must have Apple CarPlaySupport.
- A list of devices, supported regions and applications that the Apple CarPlay connection supports can be found on the websites of Apple Inc..
- ✓ Siri voice control is on.
  - ✓ The data connection is switched on in the mobile device.

### Conditions for MirrorLink

- ✓ The device to be connected must have MirrorLinkSupport.

A list of devices and applications that the MirrorLink connection supports can be found on the websites of Car Connectivity Consortium®.

- ✓ The MirrorLink application needs to be installed on the mobile device.
- ✓ Some applications require the data connection in the connected mobile device to be turned on.

## Operation

### Operation of the running MirrorLink application

- Display of control surfaces at the bottom
- Display of control surfaces at the top
- ☰ Return to the MirrorLink main menu

## Restriction

### Restriction of the Wi-Fi connection

**In some countries, the Wi-Fi connection is restricted for legal reasons. When crossing the border of the country in question, the connection with a mobile device connected via Wi-Fi can be ended or restricted.**

- ℹ Find out about country-specific legal restrictions. If necessary, switch off the Wi-Fi manually.

Establishment of a Wi-Fi connection is only possible in vehicles with online services, or when making an emergency call.

### Restriction of SmartLink applications while driving



For safety reasons, operation of some SmartLink applications while driving is not possible or is restricted.

## SmartLink settings

### Apple CarPlay - Connection via USB

- › Turn on the Infotainment.
- › Turn on the mobile device.
- › Connect the mobile device to the front USB input using a cable.
- › Choose to connect via Apple CarPlay.

### Apple CarPlay - Connection via Wi-Fi from Infotainment

- › Turn on Bluetooth® and Bluetooth® visibility in the mobile device.
- › Tap on **MENU** >  > *mobile devices*.
- › In the displayed list, look for and select the desired device with the symbol .
- › Follow the instructions on the Infotainment screen and confirm the Bluetooth® pairing.
- › If another device is connected to the Infotainment, select the device to be replaced.

### Apple CarPlay - Connection via Wi-Fi from mobile devices

To establish a connection, the following conditions must be met.

- ✓ The minimum iOS version is 9.
- ✓ No other mobile device can be connected via SmartLink.
- ✓ Wi-Fi and Bluetooth® functionality is switched on in the Infotainment system.
- › In the mobile device, turn on the CarPlay function.
- › Press and hold the  button on the multifunction steering wheel.

The Infotainment screen displays a connection message with the name of the Bluetooth® unit of the Infotainment.

- › Find available Bluetooth® devices on the phone.
- › Select the Infotainment Bluetooth® unit.
- › If necessary, confirm the PIN.
- › In the Infotainment screen, select the connection type Apple CarPlay.



### Apple CarPlay - Disconnection

- › In the Apple CarPlay main menu, tap on the “ŠKODA” functional area.
- › Tap on .



### Android Auto - Connection via USB

- › Turn on the Infotainment.
- › Turn on the mobile device.
- › Connect the mobile device to the front USB input using a cable.
- › Choose to connect via Android Auto.

### Android Auto - Connection via Wi-Fi from Infotainment

- › Tap on **MENU** >  > *mobile devices*.
- › Select the desired device from the list of **available devices**.
- › Select the Bluetooth® hands-free profile.
- › Confirm the PIN; enter it if necessary and then confirm.
- › If another device is connected to the Infotainment, select the device to be replaced.
- › From the list of **known devices**, select the desired device with the  symbol.



### Android Auto - Disconnection

- › In the main menu of Android Auto  > tap on “Return to ŠKODA”.
- › Tap on .



### MirrorLink - Connection via USB

- › Turn on the Infotainment.
- › Turn on the mobile device.
- › Connect the mobile device to the front USB input using a cable.
- › Choose to connect through MirrorLink.

### MirrorLink - Connection via Wi-Fi from Infotainment

- › Turn on Wi-Fi and visibility in the mobile device.
- › Turn on the Infotainment Wi-Fi hotspot in the menu item **MENU** >  > *Wi-Fi* > *Wi-Fi hotspot*.
- › In the list of available Wi-Fi devices, look for Infotainment Wi-Fi.
- › Enter the required password.
- › With some mobile devices, communication between the device and the Infotainment in the notification bar of the mobile device must be confirmed.
- › Tap on **MENU** >  > *mobile devices*.
- › From the list of **available devices**, select the desired device with the  symbol.

### MirrorLink - Disconnection

- › In the MirrorLink main menu, tap .
- › Tap on .

### Change to another device / connection type

Infotainment allows you to switch between currently connected devices and the connection type.

- › Tap on **MENU** > .
- › Select the desired device or connection type.

## ŠKODA Connect online services

### Functionality

ŠKODA Connect online service offer the option of connecting the vehicle to the online world. They thus represent an extension of the vehicle and Infotainment functions.

For the functionality of the ŠKODA Connect Online Services, the vehicle must be within range of a mobile network through which the services are provided. The availability, the connection speed and the technology used in the mobile network can be different in the respective countries and are dependent on the mobile network operator.

The ŠKODA Connect online services are not included in the equipment of the vehicle. They can be ordered separately on the ŠKODA Connect Portal website or in the ŠKODA Connect application.

The offer of ŠKODA Connect online services depends on the type of vehicle and its trim level, Infotainment and country. Availability in each country can be checked on the ŠKODA Connect website.

The rights and obligations of the Parties with respect to the provision of these services are governed by a separate agreement. Current legal documents regarding the online services can be found on the ŠKODA Connect Portal as well as the ŠKODA Connect application.

**ŠKODA Connect website**

▶ <http://go.skoda.eu/skoda-connect>



For example, the ŠKODA Connect website contains the latest information about the online services, a link to the ŠKODA Connect Portal as well as the option of downloading the ŠKODA Connect application.

**ŠKODA Connect Portal website**

▶ <http://go.skoda.eu/connect-portal>



The ŠKODA Connect Portal website is used, for example, for registration, activation and ordering of online services. It also provides the option of remote access to the vehicle.

**Information call**

The information call may be used in the case of problems with the online services or for information regarding the products and services of the ŠKODA brand.

- ✓ The functional condition represents the active online ŠKODA Connect services.



S19-0363

▶ Press the **i** button.

**Breakdown call**

The breakdown call can be used in the event of a breakdown.

- ✓ The functional condition represents the active online ŠKODA Connect services.



S19-0362

▶ Press the **🚚** button.

**ŠKODA Connect Application**

The ŠKODA Connect application enables remote access to the vehicle using a mobile device. It can also be used for user registration and to activate and configure the online services.

The application can be downloaded to the mobile device after scanning the following QR code or link.

▶ <http://go.skoda.eu/skodaconnectapp>

**Settings**

Use of the ŠKODA Connect online services requires **prior registration of the main user** and subsequent **activation of the online services**.

**Registration and activation of online services**

User registration, as well as the activation of the ŠKODA Connect online services, is completed on the ŠKODA Connect Portal website or in the ŠKODA Connect application.

In order to complete user registration, you will need to access your e-mails.

In order to activate ŠKODA Connect, proceed as follows.

- ▶ Switch on the ignition and the Infotainment.
- ▶ Tap **MENU** > **📶** > *ŠKODA Connect (online services)* > *Registration*.
- ▶ Enter and confirm the registration PIN you have received during user and vehicle registration on the ŠKODA Connect Portal website or in the ŠKODA Connect application.
- ▶ Wait for the *Vehicle activation complete* message to appear.
- ▶ Confirm any messages on the screen.

**Delete user**

- ▶ Switch on the ignition and the Infotainment.
- ▶ Tap **MENU** > **📶** > *ŠKODA Connect (online services)* > *Registration*.
- ▶ Tap *Delete main user* > *Delete*.
- ▶ Confirm the deletion.

**Connection status of the online services**

The status of the connection to the ŠKODA Connect online services is displayed by the discolouration of the **📶** symbol shown in the status bar on the Infotainment screen.

- ▶ **White** - online services are available.
- ▶ **Grey** - online services are not available.

**Setting the personal data protection level**

The level of protection of personal data in ŠKODA Connect online services is indicated by an icon in the status bar on the Infotainment screen.



S18-0391

- ▶ Open the Infotainment control enter by holding down the bar at the top of the screen and pulling it down.

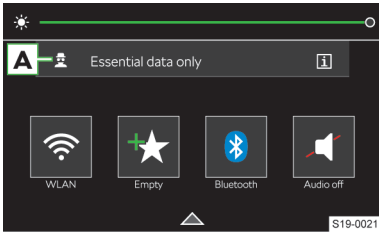

- › To **Display information**, tap **A** for the respective protection levels.
- › To display the menu for **Setting the protection level**, tap the **A** symbol.

Or:

- › Tap **MENU** › › ŠKODA Connect (online services) › Privacy settings and manage services.
- › Select one of the following options for sending vehicle and user data.
  - Send only the legally required data.
  - Send the vehicle and user data.
  - Send the vehicle and user data as well as the data regarding the vehicle position.
  - Division of vehicle position data on the website ŠKODA Connect Portal and in the ŠKODA Connect application .

### Management of online services

In the service management, it is possible to display information about the online services, the validity of their licence, or to switch the services on/off.

- › Tap **MENU** › › ŠKODA Connect (online services) › Privacy settings and manage services.

## Infotainment Bolero

### Infotainment overview

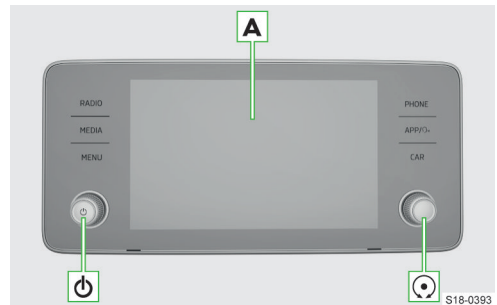

- A** Touchscreen
- B** Rotary control on the left
  - ▶ **Press:** Switch Infotainment on/off
  - ▶ **Turn:** Adjust Volume
- C** Rotary control on the right
  - ▶ **Press:** Confirm menu item
  - ▶ **Turn:** select menu item/set value

**RADIO** Radio menu

**MEDIA** Media menu

**MENU** All menus

**PHONE** Phone menu

**APPV./** SmartLink menu

- ▶ **Tap:** Display menu
- ▶ **Hold:** switch voice control for the SmartLink application on/off

**CAR** Information about vehicle settings

## System

### Control centre

#### Usage

The Infotainment control centre provides quick access to the following functions.

- ▶ Setting the instrument and key illumination.
- ▶ Setting the personal data protection level.
- ▶ Functional surfaces of preferred features.

#### Opening the control centre



- › Press the bar at the top of the screen and drag down.

#### Closing the control centre

- › Tap on .

Or:

- › Press the bar at the bottom of the screen and drag up.

Or:

- › Wait 5 seconds.

### Settings

- › To **open edit mode**, tap on an empty functional surface or press the occupied functional surface of the preferred feature.
- › To **add the preferred feature**, tap on the functional surface of the desired function.
- › To **remove the preferred feature**, tap on  $\text{⌂}$ .
- › To **close edit mode**, tap on  $\times$ .

### Restriction

For safety reasons, operation of some Infotainment functions while driving is not possible or is restricted.

The Infotainment system indicates this by means of a message in the screen.

### Basic settings

#### Setting basic functions

The following Infotainment functions are set in the **MENU** >  $\text{⚙}$  menu.

- ▶ Time and date.
- ▶ Language.
- ▶ Units.
- ▶ Restore factory settings.

#### Sound settings

The Infotainment sound is set in the menu **MENU** >  $\text{⚙}$ .

The following menu items can be set.

- ▶ Setting the equalizer.
- ▶ Adjusting the volume ratio.
- ▶ Volume adjustment of individual Infotainment functions.  
Some are adjustable, for example the following menu items.
  - ▶ Volume adjustment of voice commands.
  - ▶ Setting the maximum volume when Infotainment is turned on.
  - ▶ Speed-dependent volume setting.
  - ▶ Setting the Infotainment to mute with the parking aid switched on.

Depending on the equipment, the following advanced sound settings can be set.

- ▶ Setting space optimisation.
- ▶ Setting the audio profiles according to genre.
- ▶ Adjusting the subwoofer volume.

### Configuration wizard

The configuration wizard helps to set certain Infotainment functions.

The configuration wizard is automatically displayed if there are at least two non-selected menu items after turning on the Infotainment.

- › To **switch off the automatic display**, tap on *Don't show again* when the configuration wizard is displayed.
- › For **manual display**, tap on **MENU** >  $\text{⚙}$  > *Configuration wizard*.

### Setting the MENU

The position of the functional surfaces in the MENU menu can be customized as follows.

- › Press and hold the desired functional surface until it is free.
- › Move the functional surface to a different position.

### Safely disconnect the connected USB device

#### ⓘ NOTICE

Risk of damage to the data on the connected USB device!

To safely disconnect a USB device, proceed as follows.

- › Tap **MENU** >  $\text{⚙}$  > *Remove safely*.
- › Select the desired device.
- › Disconnect the USB device.

### Troubleshooting

#### Infotainment not responding

The Infotainment system must be restarted.

- › Press  $\text{⏻}$  for more than 10 s.
- › Wait for the restart to complete.

### System update

#### We recommend having the system update carried out by a specialist company.

The system update ensures optimal function of the Infotainment system, e.g. compatibility with new phones.

#### Determine system version

- › Tap **MENU** >  $\text{⚙}$  > *System information*.

## Screen

### Overview

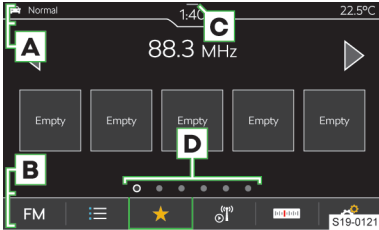

- A** Status bar
- B** Bar with the functional surfaces of the displayed menu
- C** Display of the control centre
- D** Other pages of the menu

### Operation

#### ① NOTICE

Danger of screen damage!

- ▶ The Infotainment screen is operated **by touching it lightly with your finger**.

In principle, operation by touch is identical to the operation of a mobile phone.

The following operating modes are specific to the Infotainment system.

#### Dragging up or down with two fingers

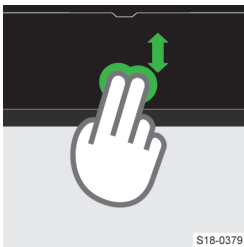

- ▶ Quickly review the list of phone contacts.

### Settings

The following basic screen functions are set in the **MENU > ⚙ > Screen** menu.

- ▶ Brightness level of the screen.
- ▶ Switch off the screen.
- ▶ Display the time.
- ▶ Confirmation sounds and animations.

## Infotainment keyboard

### Keypad overview

The arrangement of the keypad characters depends on the Infotainment language that has been set.

In Infotainment, the following types are used, depending on the context.

- ▶ Alphanumeric.
- ▶ Numeric.
- ▶ Keypad for input.
- ▶ Keypad for search.



#### Keypad example

- A** Line input
  - ▶ Delete characters before the cursor
  - ▶ **Tap:** delete the last character
  - ▶ **Hold:** delete all characters one after the other
- ≡ Show list of searched entries
- B** Keypad functional surfaces
  - ▶ Switch to lowercase/uppercase
  - ▶ **ABC/ABB** Switch to the language keypad
  - ▶ **123** Switch to the numeric and character keypad
  - ▶ Show additional keypad languages
  - ▶ Insert a space
  - ▶ **Hold:** Show additional character variants
  - ▶ Move cursor to the left
  - ▶ Move cursor to the right
  - ▶ **OK** Confirm the characters that have been entered

### Numeric keypad

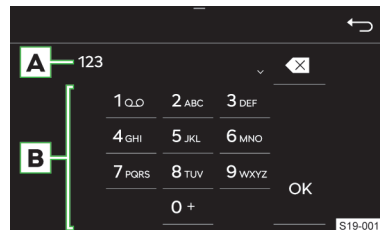

#### Keypad example

- A** Line input



- ▶ Delete characters before the cursor
- ▶ **Tap:** delete the last character
- ▶ **Hold:** delete all characters

**B** Keypad functional surfaces

- ▶ Confirm the characters that have been entered
- I** If dependent on context, alphanumeric characters can be entered by holding down a function area with the number.

**Operation**

The Infotainment keypad is used to enter characters, letters and numbers.

The keypad will be **automatically displayed** when Infotainment prompts for characters.

**Find**

During the character input, a search for corresponding entries takes place.

The entry to be searched can be entered, including diacritics.

The keypad will only provide characters that match the stored entries.

- › To **display the searched entries**, tap .

**Show additional keypad languages**

To use the additional keypad languages, the desired languages must be set first.

- › Tap or repeatedly tap the flag symbol until the desired language keypad is displayed.

**Further character variants**

- › Press and hold the sign with the symbol .
- › Select the desired symbol.

**Setting additional keypad languages**

- › Tap **MENU** > > *Additional keypad languages*.

**Radio**

**Overview**

**Display main menu**

- › Tap on **RADIO**.
- Or:
- › Tap on **MENU** > .

**Analogue and digital radio reception**

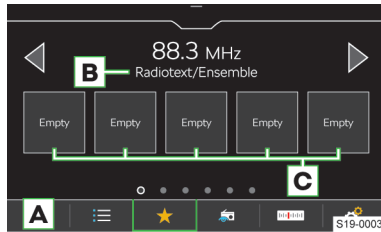

- A** Select frequency range
- B** Depending on the frequency range  
**FM:** Radio text  
**DAB:** Radio text: name of the station group
- C** Preset buttons for preferred stations
  - List of available stations
  - Show favourites
  - Show information about the station
  - Search stations manually (valid for AM and FM)
  - Settings

**I** Infotainment supports digital radio reception in DAB and DAB+ formats.

**List of available stations**

- › Tap on .
- Played station
- Station stored on the presets
- TP** A traffic radio station is set
- DAB signal is not available
- Filter the stations in the list according to the programme type, e.g. culture, music, sports, etc.  
**FM:** when the RDS function is switched on
- Manual update of the station list

In the station list, information about the program type and the type of the regional station can be displayed.

**Operation**

**Select station**



- › Tap or at the top of the screen.

**SCAN function**

The function plays receivable stations of the selected frequency range in succession for a few seconds each.

- › To **start automatic play** press > Scan or the right rotary control .
- › To **end automatic play** press or the right rotary control .

**Search for stations manually**

Manual search is available for AM and FM stations.

- › In the Radio main menu, tap .
- › For a **consecutive search**, tap or next to the displayed frequency range scale.

Or:

- › Hold down the scroll mark on the frequency range scale and move it to the intended value.

Or:

- › Turn the right rotary control.

**Restriction**

- ▶ Parking garages, tunnels, tall buildings or mountains can restrict radio reception.
- ▶ In the rear side windows, there are antennas for receiving the radio signal.

Covering the panes with foils or metal-coated labels may affect the reception of the radio signal.

**Settings****Save the station currently being listened to as a favourite from the Radio main menu**

- › Hold the desired station key for preferred stations until the station is stored.

**Save station to favourites from the list of available stations**

- › Hold the line with the name of the desired station.
- › Tap the desired preset button.

**Delete favourites**

- › In the **Radio** main menu, tap > Delete presets.
- › To delete **one** preset button for preferred stations, tap the desired station button and confirm the deletion.
- › To delete **all** preset buttons for preferred stations, tap *All* and confirm the deletion.

**Buttons**

Applies to AM, FM and DAB frequency ranges.

The variant for **changing stations** using buttons in the **Radio** main menu is set as follows.

- › In the **Radio** main menu, tap > Arrow buttons.

- › Choose the change variant.

**Traffic reception (TP) for FM stations on/off**  
Applies to the FM frequency range.

- › In the **Radio** main menu, tap > Traffic program (TP).

**Switch traffic reception for DAB stations on/off**  
Applies to the DAB frequency range.

- › In the **Radio** main menu, turn on menu item > Traffic Radio (TP).
- › In the **Radio** main menu, tap > Advanced settings > DAB traffic programme (TP) on/off.

**Assign station logos**

Applies to AM, FM and DAB frequency ranges.

Infotainment offers the option to assign logos from the pictures on an external source to the station buttons.

For station logos, images in jpg, gif, png, bmp format with a maximum resolution of 500x500 pixels can be used.

- › In the **Radio** main menu, tap > Station logos.
- › Tap the desired preset button.
- › Select the external source with the logo.
- › Find the desired logo and confirm.

**Delete station logos**

Applies to AM, FM and DAB frequency ranges.

- › In the **Radio** main menu, tap > Station logos.
- › To delete **a logo**, tap the desired preset button and confirm the deletion.
- › To delete **all** logos, tap on *All* and confirm the deletion.

**Switch on/off autostore of logos for stations to be stored to Favourites**

Applies to FM and DAB frequency ranges.

When the function is switched on, a station logo from the Infotainment memory is assigned when the station is stored on a preset button.

- › In the **Radio** main menu, tap on > Advanced settings > Autostore station logos.

**Regional FM station logo**

Applies to the FM frequency range.

Infotainment provides the option of using country-specific FM station logos.

- › In the **Radio** main menu, tap on > Advanced settings > Region for station logo.
- › Choose the country.

**Automatic change of frequency to a regionally linked FM station**

Applies to the FM frequency range.

Infotainment provides the option of automatically switching to a regionally linked FM station in case of signal loss of the FM station being listened to.

> In the **Radio** main menu, tap on  > *Advanced settings* > *RDS Regional*.

> Select one of the following menu items.

▶ *Fixed* - If there is a loss of signal, another station must be set manually.

▶ *Automatic* - automatic selection of the station with the best signal reception.

If reception is lost in the given region, Infotainment will automatically set another available region.

#### Switch automatic frequency control (AF) on/off

*Applies to the FM frequency range.*

When the function is switched on and the signal of the FM station currently being listened to is weak, Infotainment automatically sets the same station to a different frequency with a better signal.

> In the **Radio** main menu, tap on  > *Advanced settings* > *Automatic frequency control (AF)*.

#### Sort stations in the list of available stations

*Applies to the FM frequency range.*

▶ In the **Radio** main menu, tap on  > *Advanced settings* > *Sort station list*.

▶ Select the sorting of stations in alphabetical order or by group.

#### Turn on/off radio text reception

*Applies to the FM and DAB frequency ranges.*

When the function is switched on and station presets are displayed, detailed information about the broadcast content of the station being listened to, or the name of the station group for the DAB station, is displayed.

> In the **Radio** main menu, tap on  > *Radio text*.

#### Switch RDS on/off

*Applies to the FM frequency range.*

*This menu item is only available in some countries.*

> In the **Radio** main menu, tap on  > *Advanced settings* > *Radio Data System (RDS)*.

If the **RDS function is disabled**, the following menu items in the **FM transmitters** settings are not available.

▶ Traffic programme (TP).

▶ Radio text.

▶ RDS Regional.

▶ Automatic frequency control (AF).

▶ Regional station logos.

▶ Sorting of stations in the list of available stations.

#### Switch additional DAB announcements on/off

*Applies to the DAB frequency range.*

When the function is switched on, other announcements are received as traffic announcements. For ex-

ample, weather news, sports reports, financial news, etc.

> In the **Radio** main menu, tap on  > *Advanced settings* > *Other DAB announcements*.

#### Enable/disable automatic programme tracking of a DAB station

*Applies to the DAB frequency range.*

When the function is switched on and the DAB station is lost, Infotainment automatically changes to the same station with a better signal in a different DAB station group.

> In the **Radio** main menu, tap on  > *Advanced settings* > *DAB - DAB station tracking*.

#### Turn on/off automatic switching from a DAB station to the same FM station

*Applies to the DAB frequency range.*

When the function is switched on and the DAB station being listened to is lost, Infotainment automatically changes to the same FM station. The symbol (FM) is displayed after the station name.

When the corresponding DAB station can be received again, the station automatically changes from FM to DAB.

> In the **Radio** main menu, tap on  > *Advanced settings* > *Automatic DAB - FM switching*.

#### Turn on/off automatic switching to a similar DAB station

*Applies to the DAB frequency range.*

When the function is switched on and DAB station being listened to is lost, Infotainment automatically changes to another DAB station with similar content.

> In the **Radio** main menu, tap on  > *Advanced settings* > *Switch to a similar station*.

## Media

### What you should be mindful of

▶ Do not save any important data or that which has not been backed up on the connected audio sources. ŠKODA assumes no responsibility for lost or damaged files or connected audio sources.

▶ When changing or connecting an audio source, this may cause sudden changes in volume. Reduce the volume before changing or connecting an audio source.

▶ When connecting an audio source, the source information messages can be displayed. These messages must be observed and, if necessary, confirmed.

▶ The national copyright laws that apply in your country must be observed.

## Overview

### Display main menu

> Tap on **MEDIA**.

Or:

> Tap on **MENU** > .

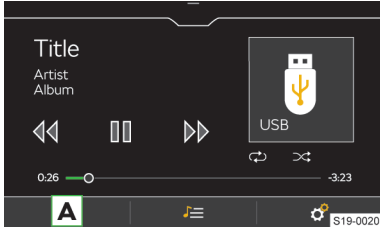

**A** Select source

 Manage files/multimedia database

 Settings

## Player controls

### Operation - Basics

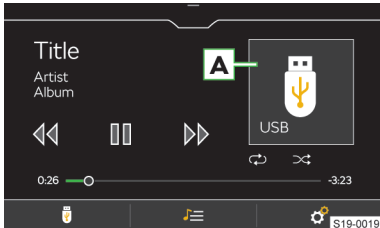

**A** Album picture/symbol of the connected source

▷ **Tap:** start playback

▢ **Tap:** pause

◀◀ **Tap within 3 seconds of starting playback:** play the previous title

◀◀ **Tap after 3 seconds of the starting playback:** play the current title from the beginning

◀◀ **Hold:** fast rewind within the title

▷▷ **Tap:** play the next title

▷▷ **Hold:** fast forward within the title

Movement within the title is also possible by dragging your finger over the timeline.

### Extended operation

↺ Turn repeat playback of the current track on/off

↻ Turn repeat playback of the current album/folder on/off

⌘ Turn random playback of the current album/folder on/off

## Settings

### Turn title playback including subfolders on/off

> In the **Media** main menu, tap on  > *Mix/Repeat including subfolders*.

### Enable/disable playback of online media from an Apple device

> To **turn on/off** in the **Media** main menu, tap on  > *Include online media from an iPod*.

Under the following conditions, media in the Apple iCloud is included in the list of available media.

✓ The mobile device is not connected using Apple CarPlay.

✓ The mobile device is connected to Apple iCloud.

### Traffic

> To **turn on/off** the traffic monitoring during the playback of media files, go to the **Media** main menu and tap on  > **Traffic programme (TP)**.

### Safely disconnect the connected USB device

#### ⓘ NOTICE

Risk of damage to the data on the connected USB device!

To safely disconnect a USB device, proceed as follows.

> In the **Media** main menu, tap  > *Remove USB safely*.

> Select the desired device.

> Disconnect the USB device.

## Supported sources and files

Source	Interface	Type	Specification	File system
USB	USB 1.x; 2.x 3.x or higher with USB 2.x support	MSC	USB stick	VFAT FAT16 FAT32 exFAT NTFS
			HDD (without special software)	
		USB devices that use the USB mass storage support protocol		
		MTP	Devices running the Android or Windows Phone operating system that support the Media Transfer Protocol	
		Apple	Devices with an iOS operating system	HFS+
Bluetooth® player	Bluetooth®	-	Bluetooth® protocols A2DP and AVRCP (1.0 - 1.5)	-

Supported sources

❗ Apple iAP1 protocol is not supported by Infotainment.

**Compatibility of mobile devices**

It is possible to check the ŠKODA web pages to see if Infotainment is compatible with the selected mobile device being tested. This check is carried out by using the following reference or by reading the QR code.

► <http://go.skoda.eu/compatibility>



Compression format	Codec type	File extension	Max. bit rate [kbps]	Max. sampling rate [kHz]	Multi channels
MPEG	MPEG 1 Layer 3	mp3	32 - 320	32, 44, 48	Mono, dual mono, Stereo, Joint Stereo
	MPEG 2 Layer 3			16, 22, 24	
	MPEG 2.5 Layer 3	mp3	8 - 160	8, 11, 12	Mono, Stereo, Joint Stereo
WMA	Windows Media Audio 9 and 9.1	wma	8 - 384	8, 11, 12, 16, 22, 32, 44, 48	Mono, Stereo, Joint stereo
	Windows Media Audio 9.2		8 - 320		
	Windows Media Audio 10		8 - 768	32, 44, 48, 96	
ADTS	AAC LC	aac	8 - 640	22, 24, 32, 44, 48	Mono, Stereo
	AAC HE		8 - 320	16, 22, 24,	
	AAC HEv2		16 - 64	32, 44, 48	

Compression format	Codec type	File extension	Max. bit rate [kbps]	Max. sampling rate [kHz]	Multi channels
FLAC	FLAC	flac	-	8, 11, 12, 16, 22, 24, 32, 44, 48, 64, 88, 96	Mono, Stereo, 5.1, 7.1
RIFF	WAV	wav	64 - 3072	8, 11, 12, 16, 22, 24, 32, 44, 48, 96	Mono, Stereo
SBC	Bluetooth A2DP	-	8 - 345	44, 48	Mono, Stereo, Joint stereo

Supported audio files

**I** For files in MP4 format, only the soundtrack playback is carried out.

Files that are protected by the **DRM-** and **iTunes®** methods are not supported by Infotainment.

Codec type	File extension
M3U	m3u
M3U8	m3u8
PLS	pls
WPL	wpl
ASX	asx
PLA	pls

Supported playlists

## Mobile device management

### Overview

Using mobile device management, devices can be connected, disconnected, and interchanged.

### Display mobile device management

› Tap on **PHONE** › › Select mobile phone › .

Or:

› Tap on **MENU** › › mobile devices.

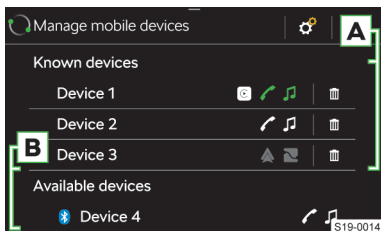

- ✔ The device enables a connection via the Bluetooth® "hands-free profile"
- ✔ The device is connected via the Bluetooth® "hands-free profile"
- 🎵 The device enables a connection via the Bluetooth® audio profile
- 🎵 The device is connected via the Bluetooth® audio profile

- ▲ The device enables a SmartLink connection to be made via Android Auto
- Remove the device from the list **previously connected devices**
- Ⓜ The device enables a SmartLink connection to be made via Apple CarPlay
- 📺 The device enables a SmartLink connection to be made via MirrorLink
- A** Connected / Previously connected devices
- B** Available devices

### Limitations of mobile devices and applications

#### Availability of features

The availability of certain features depends on the type of mobile device, as well as that of the applications installed.

#### Compatibility of mobile devices

It is possible to check the ŠKODA web pages to see if Infotainment is compatible with the selected mobile device being tested. This check is carried out by using the following reference or by reading the QR code.

► <http://go.skoda.eu/compatibility>



### Bluetooth® compatibility of mobile devices

Due to the large number of mobile devices, it is not possible to guarantee total Bluetooth® compatibility with Infotainment. Bluetooth® compatibility depends on the Bluetooth® version as well as the implementation of Bluetooth® protocols by the manufacturer of the mobile device.

### Applications in mobile devices

Mobile devices can be used to install applications that allow you to view additional information on the Infotainment screen, or to operate the Infotainment system.

Due to the variety of applications, as well as their ongoing development, the available applications may not function on all mobile devices. ŠKODA AUTO assumes no liability for their proper functioning.

The scope of available applications and their functionality is dependent on the type of Infotainment, as well as the vehicle and country.

## Connection set-up

### Connect a mobile device to Infotainment

- › Find available Bluetooth® devices in the mobile device.
- › Select the Infotainment Bluetooth® unit.

The name of the unit can be found under the menu item **MENU** > > Bluetooth > Name..

- › Confirm the PIN; enter it if necessary and then confirm.

### Connect Infotainment to a non-paired mobile device

- › Tap on **PHONE** > > Select mobile phone > .
- › Select the desired device from the list of **available devices**.
- › Select the desired Bluetooth® profile.
- › Confirm the PIN; enter it if necessary and then confirm.
- › If two devices are connected to the Infotainment, select the device to be replaced.

### Connect Infotainment to a previously connected mobile device

- › Tap on **PHONE** > > Select mobile phone.
- › Select the desired device from the list of **previously connected devices**.
- › Select the desired Bluetooth® profile.
- › If two devices are connected to the Infotainment, select the device to be replaced.

### SmartLink Connection

Infotainment provides the ability to connect SmartLink to compatible mobile devices using the following connection types.

- ▲ Android Auto
- 📱 Apple CarPlay
- 📺 MirrorLink

Mobile devices can be connected to the Infotainment via USB cable or Wi-Fi, as long as the mobile device supports it.

- › Connect the mobile device to the Infotainment.
- › Tap the icon of the supported connection.

## Telephone

### Telephone main menu

#### Display main menu

- › Tap on **PHONE**.

Or:

- › Tap on **MENU** > .

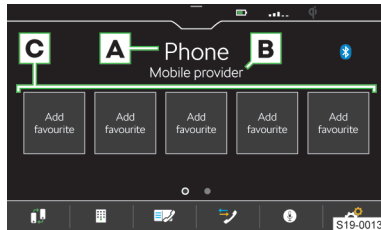



- A** Name of the connected telephone
  - ▶ **Tap:** Show list of previously connected phones
- B** Name of telephone service providers
- C** Preset buttons for preferred contacts
- Change the main telephone with the additional telephone
- Enter telephone number
- Contact list
- Call lists
- Switch on voice control for the connected telephone
- Settings

### Conditions for connecting a telephone with Infotainment

- ✓ The Bluetooth® function of the Infotainment and the telephone need to be switched on.





The Bluetooth® function of the Infotainment is switched on in the menu item **MENU** >  > Bluetooth > Bluetooth.

- ✓ Visibility of the Infotainment is switched on.  
The visibility of the Infotainment is switched on in the menu item **MENU** >  > Bluetooth > Visibility.
- ✓ The telephone is within signal range of the Infotainment's Bluetooth® unit.
- ✓ The telephone is compatible with Infotainment.

## Telephone operation

### Enter telephone number

- > In the **Telephone** main menu, tap .
- > Enter the telephone number using the numeric keypad that is displayed.

 The displayed numeric keypad can also be used for searching for contacts. If, for example, the digits 32 are entered, contacts with the letter sequence DA, FA, EB etc. are displayed next to the numeric keypad.

### List of telephone contacts



The list of telephone contacts is imported from the connected main telephone.

- > Tap to **display** the contact list in the **telephone** main menu .
- > To **find** details within the list, tap *Find*.
- > Enter the details you wish to find.
- > To **establish a connection** with a contact, tap the functional area showing the desired contact.

If a contact has multiple telephone numbers, select the telephone number from the displayed list.









- > To display the **details** for a contact, tap >.

### Establish a connection to the voice mailbox number

- > In the **Telephone** main menu, tap  > .

### Telephone conversation

Depending on the context of the telephone conversation, the following functions can be selected.

-  End connection / reject incoming call / end call
-  Answer an incoming call / return to the held call
-  Switch the ringer off / on
-  Hold a call
-  Switch the microphone off / on
-  Show details of the caller
-  Answer a call from the second telephone during a call on the first telephone  
The ongoing call on the first telephone is terminated by accepting the call.
- > To **switch the call tone from the speakers to the telephone**, go to the **telephone** main menu and tap on  > hands-free.



- > To **switch the call tone from the telephone to the speakers**, tap .

### Conference call





A conference call is a joint telephone conversation with a minimum of three and a maximum of six participants.

- > Make the next call during an ongoing conversation/conference.



Or:

- > Accept a new incoming call by tapping the function area .
- > To **start** a conference call, tap on the functional area .

During an ongoing conference call, the following functions can be selected depending on the context.

-  Hold the conference call and leave temporarily (the conference will continue in the background)
-  Return to the conference being held
-  Switch the microphone off / on
-  End the conference
-  Show details of the conference call

In the details of the conference call, depending on the connected telephone, the following functions can be selected.

-  Show details of the conference call participants
-  End conversation with the conference call participant
-  Conversation with a participant outside of the conference call

## Settings for Infotainment telephone functions

### Telephone-Infotainment-Connection types

The way in which the telephone is connected depends on the number of phones currently connected to the Infotainment.

- ▶ **No telephone** - The telephone is connected as a main telephone.
- ▶ **One telephone** - The telephone is connected as an additional telephone.
- ▶ **Two telephones** - Select the telephone to be replaced.
- > To **switch between the main telephone and the supplementary telephone** in the main menu, tap **telephone** .

### Connect the telephone to Infotainment

- > Find available Bluetooth® devices on the phone.
- > Select the Infotainment Bluetooth® unit.

The name of the unit can be found under the menu item **MENU** >  > Bluetooth > Name.

- > Confirm the PIN; enter it if necessary and then confirm.

### Connect Infotainment to a non-paired telephone - no telephone is connected

- › Tap on **PHONE**.

Or:

- › Tap on **MENU** > ↗.
- › Follow the instructions in the Infotainment screen.

### Connecting Infotainment to a non-paired telephone - another telephone is connected

- › Tap on **PHONE** > ☎ > *Select mobile phone* > ☎.
- › Select the desired device from the list of **available devices**.
- › Select the desired Bluetooth® profile.
- › Confirm the PIN; enter it if necessary and then confirm.

The telephone is connected as an additional telephone.

Or:

- › If two telephones are connected to the Infotainment, select the telephone to be replaced.

### Connect Infotainment to a previously paired telephone

- › Tap on **PHONE** > ☎ > *Select mobile phone*.
- › Select the desired device from the list of **previously connected devices**.

The telephone is connected as an additional telephone.

Or:

- › If two telephones are connected to the Infotainment, select the telephone to be replaced.

### Manage preset buttons for preferred contacts

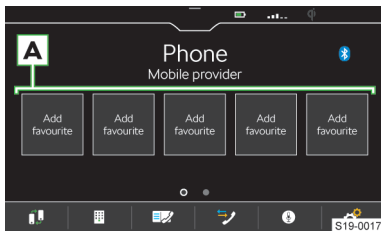

- › To **save** the desired preset button, press and hold **A**.
- › Select a contact from the displayed list.
- › Select a contact from the displayed list.
- › To **display the menu for deleting** go to the **Telephone** main menu and tap ☎ > *manage favourites*.
- › To delete **one** preset, tap on the list entry and confirm the deletion.

Or:

- › To delete **all** presets, tap on *All* and confirm the deletion.

### Import telephone contacts

After first connecting the main telephone with Infotainment, telephone contacts will start to be imported into the Infotainment memory.

Infotainment can import up to 2000 telephone contacts together with contact pictures. Each contact can include max. 5 telephone numbers.

Depending on the type of telephone, import confirmation may be required.

### Update telephone contacts

When re-connecting the telephone with Infotainment, an **automatic** update of the list is carried out.

- › For a **manual** update of the list in the **telephone** main menu, tap on ☎ > *User profile* > *Import contacts*.

### Sort contacts in the phonebook

- › In the **telephone** main menu, tap on ☎ > *User profile* > *Sort by*: and select the sort type.

### Ringer

Some phones do not allow the use of the telephone ringer; instead, the Infotainment ringer is used.

- › To set the Infotainment ringer in the **telephone** main menu, tap on ☎ > *user profile* > *Select ringtone*.
- › Select the ringtone.

### Number for the voice mailbox

- › To set the voice mailbox number in the **telephone** main menu, tap on ☎ > *user profile* > *Mailbox number*.
- › Enter the number of the voice mailbox.

### Simultaneous calls

*This applies to some countries.*

Depending on the connected telephone, it is possible to answer the next incoming call and hold the previous call.

- › To switch on simultaneous calls, tap on **telephone** ☎ > *Parallel talks*.

## Wi-Fi

### Functionality

Wi-Fi can be used for the SmartLinkConnection.

The Infotainment hotspot can connect up to 3 mobile devices.

- › To display the list of connected mobile devices, tap on **MENU** > ☎ > *Wi-Fi* > *Connected devices*.

### Settings

#### Connect a mobile device to the Infotainment hotspot

- › Turn on the Infotainment Wi-Fi hotspot in the menu item **MENU** > ☎ > *Wi-Fi* > *Wi-Fi hotspot*.

- > Turn on the Wi-Fi on the mobile device.
- > In the list of available Wi-Fi devices, look for Infotainment Wi-Fi.

The name of the Infotainment is taken from the menu item **MENU** > > *Wi-Fi* > *Network name*.

- > Select the Infotainment hotspot and enter the required password.

The password for connecting to the Infotainment hotspot is taken from the menu item **MENU** > > *Wi-Fi* > *Network key*.

- > Confirm the connection.

**Security level of the Infotainment hotspot**

The security level is factory-set at WPA2 and cannot be changed.

**Change password for connection to Infotainment hotspot**

The password must be a minimum of 8 and a maximum of 63 characters.

- ▶ Tap **MENU** > > *Wi-Fi* > *Network key*.
- ▶ Enter the password and confirm.

**SmartLink**

**Functionality**

SmartLink offers the ability to display and operate certified applications from a connected mobile device in the Infotainment screen.

Certification may be conditional upon the use of the latest update to the particular SmartLink application.

Applications include, for example, apps for route guidance, telephoning, listening to music, etc.

Mobile devices can be connected via a USB cable or Wi-Fi.

**Supported connection types**

SmartLink supports the following connection types.

- ▶ Android Auto.
- ▶ Apple CarPlay.
- ▶ MirrorLink.

**Overview of the SmartLink connection**

**Main menu SmartLink**

- > Tap on **APP**
- Or:
- > Tap on **MENU** >



- A** Previously connected device
- B** Currently connected device
- Display information about SmartLink
- Separation of the active connection
- Settings for the SmartLink menu

**Android Auto**

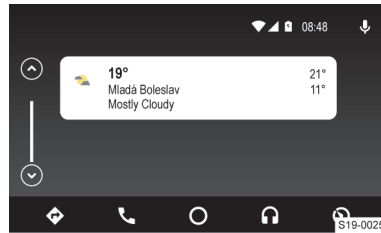

- Navigation applications
- Telephone applications
- Overview of running applications, phone calls, incoming text messages, and more.
- Music applications
- Display of other available applications as well as the option to return to the SmartLink main menu
- Turn on voice control (Google Voice)

**Apple CarPlay**

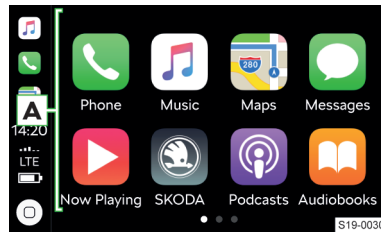

- A** List of available applications
- Depending on the duration of operation:
  - ▶ **Tap**: Return to the Apple CarPlay main menu
  - ▶ **Hold**: Switch on voice control (Siri)

**MirrorLink**



- ⊖ It is not possible to operate the application while driving
- Return to the SmartLink main menu
- ☰ List of running applications
- ☰ Display of the last running application in connected mobile devices
- ⚙ Settings

**Connection conditions**

**General connection conditions**

- ✓ The mobile device supports the following SmartLink connection types: Android Auto, Apple CarPlay and MirrorLink.
- ✓ Mobile devices, as well as the type of SmartLink connection, are supported in the respective market.
- ✓ Some connected mobile devices require the mobile device to be “unlocked”.

**Conditions for Android Auto**

- ✓ The device to be connected must have Android AutoSupport.
- A list of devices, supported regions and applications that the Android Auto connection supports can be found on the websites of Google Inc..
- ✓ The Android Auto application needs to be installed on the mobile device.
  - ✓ Some applications require the data connection in the mobile device to be turned on.

**Conditions for Apple CarPlay**

- ✓ The device to be connected must have Apple CarPlaySupport.
- A list of devices, supported regions and applications that the Apple CarPlay connection supports can be found on the websites of Apple Inc..
- ✓ Siri voice control is on.
  - ✓ The data connection is switched on in the mobile device.

**Conditions for MirrorLink**

- ✓ The device to be connected must have MirrorLinkSupport.

A list of devices and applications that the MirrorLink connection supports can be found on the websites of Car Connectivity Consortium®.

- ✓ The MirrorLink application needs to be installed on the mobile device.
- ✓ Some applications require the data connection in the connected mobile device to be turned on.

**Operation**

**Operation of the running MirrorLink application**

- Display of control surfaces at the bottom
- Display of control surfaces at the top
- ☰ Return to the MirrorLink main menu

**Restriction**

**Restriction of the Wi-Fi connection**

**In some countries, the Wi-Fi connection is restricted for legal reasons. When crossing the border of the country in question, the connection with a mobile device connected via Wi-Fi can be ended or restricted.**

- ℹ Find out about country-specific legal restrictions. If necessary, switch off the Wi-Fi manually.

Establishment of a Wi-Fi connection is only possible in vehicles with online services, or when making an emergency call.

**Restriction of SmartLink applications while driving**

For safety reasons, operation of some SmartLink applications while driving is not possible or is restricted.

**SmartLink settings**

**Apple CarPlay - Connection via USB**

- Turn on the Infotainment.
- Turn on the mobile device.
- Connect the mobile device to the front USB input using a cable.
- Choose to connect via Apple CarPlay.

**Apple CarPlay - Connection via Wi-Fi from Infotainment**

- Turn on Bluetooth® and Bluetooth® visibility in the mobile device.
- Tap on **MENU** > **SmartLink** > **mobile devices**.
- In the displayed list, look for and select the desired device with the symbol **■**.
- Follow the instructions on the Infotainment screen and confirm the Bluetooth® pairing.
- If another device is connected to the Infotainment, select the device to be replaced.

### Apple CarPlay - Connection via Wi-Fi from mobile devices

To establish a connection, the following conditions must be met.

- ✓ The minimum iOS version is 9.
- ✓ No other mobile device can be connected via SmartLink.
- ✓ Wi-Fi and Bluetooth® functionality is switched on in the Infotainment system.
- › In the mobile device, turn on the CarPlay function.
- › Press and hold the  button on the multifunction steering wheel.

The Infotainment screen displays a connection message with the name of the Bluetooth® unit of the Infotainment.

- › Find available Bluetooth® devices on the phone.
- › Select the Infotainment Bluetooth® unit.
- › If necessary, confirm the PIN.
- › In the Infotainment screen, select the connection type Apple CarPlay.



### Apple CarPlay - Disconnection

- › In the Apple CarPlay main menu, tap on the “ŠKODA” functional area.
- › Tap on .



### Android Auto - Connection via USB

- › Turn on the Infotainment.
- › Turn on the mobile device.
- › Connect the mobile device to the front USB input using a cable.
- › Choose to connect via Android Auto.

### Android Auto - Connection via Wi-Fi from Infotainment

- › Tap on **MENU** >  > *mobile devices*.
- › Select the desired device from the list of **available devices**.
- › Select the Bluetooth® hands-free profile.
- › Confirm the PIN; enter it if necessary and then confirm.
- › If another device is connected to the Infotainment, select the device to be replaced.
- › From the list of **known devices**, select the desired device with the  symbol.



### Android Auto - Disconnection

- › In the main menu of Android Auto  > tap on “Return to ŠKODA”.
- › Tap on .



### MirrorLink - Connection via USB

- › Turn on the Infotainment.
- › Turn on the mobile device.
- › Connect the mobile device to the front USB input using a cable.
- › Choose to connect through MirrorLink.

### MirrorLink - Connection via Wi-Fi from Infotainment

- › Turn on Wi-Fi and visibility in the mobile device.
- › Turn on the Infotainment Wi-Fi hotspot in the menu item **MENU** >  > *Wi-Fi* > *Wi-Fi hotspot*.
- › In the list of available Wi-Fi devices, look for Infotainment Wi-Fi.
- › Enter the required password.
- › With some mobile devices, communication between the device and the Infotainment in the notification bar of the mobile device must be confirmed.
- › Tap on **MENU** >  > *mobile devices*.
- › From the list of **available devices**, select the desired device with the  symbol.

### MirrorLink - Disconnection

- › In the MirrorLink main menu, tap .
- › Tap on .

### Change to another device / connection type

Infotainment allows you to switch between currently connected devices and the connection type.

- › Tap on **MENU** > .
- › Select the desired device or connection type.

## ŠKODA Connect online services

### Functionality

ŠKODA Connect online service offer the option of connecting the vehicle to the online world. They thus represent an extension of the vehicle and Infotainment functions.

For the functionality of the ŠKODA Connect Online Services, the vehicle must be within range of a mobile network through which the services are provided. The availability, the connection speed and the technology used in the mobile network can be different in the respective countries and are dependent on the mobile network operator.

The ŠKODA Connect online services are not included in the equipment of the vehicle. They can be ordered separately on the ŠKODA Connect Portal website or in the ŠKODA Connect application.

The offer of ŠKODA Connect online services depends on the type of vehicle and its trim level, Infotainment and country. Availability in each country can be checked on the ŠKODA Connect website.

The rights and obligations of the Parties with respect to the provision of these services are governed by a separate agreement. Current legal documents regarding the online services can be found on the ŠKODA Connect Portal as well as the ŠKODA Connect application.

**ŠKODA Connect website**

▶ <http://go.skoda.eu/skoda-connect>



For example, the ŠKODA Connect website contains the latest information about the online services, a link to the ŠKODA Connect Portal as well as the option of downloading the ŠKODA Connect application.

**ŠKODA Connect Portal website**

▶ <http://go.skoda.eu/connect-portal>



The ŠKODA Connect Portal website is used, for example, for registration, activation and ordering of online services. It also provides the option of remote access to the vehicle.

**Information call**

The information call may be used in the case of problems with the online services or for information regarding the products and services of the ŠKODA brand.

- ✓ The functional condition represents the active online ŠKODA Connect services.

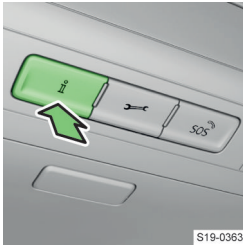

S19-0363

▶ Press the **i** button.

**Breakdown call**

The breakdown call can be used in the event of a breakdown.

- ✓ The functional condition represents the active online ŠKODA Connect services.

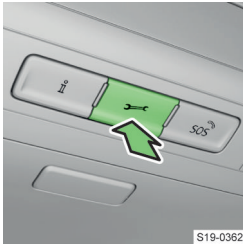

S19-0362

▶ Press the **🚚** button.

**ŠKODA Connect Application**

The ŠKODA Connect application enables remote access to the vehicle using a mobile device. It can also be used for user registration and to activate and configure the online services.

The application can be downloaded to the mobile device after scanning the following QR code or link.

▶ <http://go.skoda.eu/skodaconnectapp>



**Settings**

Use of the ŠKODA Connect online services requires **prior registration of the main user** and subsequent **activation of the online services**.

**Registration and activation of online services**

User registration, as well as the activation of the ŠKODA Connect online services, is completed on the ŠKODA Connect Portal website or in the ŠKODA Connect application.

In order to complete user registration, you will need to access your e-mails.

In order to activate ŠKODA Connect, proceed as follows.

- ▶ Switch on the ignition and the Infotainment.
- ▶ Tap **MENU** > **📶** > *ŠKODA Connect (online services)* > *Registration*.
- ▶ Enter and confirm the registration PIN you have received during user and vehicle registration on the ŠKODA Connect Portal website or in the ŠKODA Connect application.
- ▶ Wait for the *Vehicle activation complete* message to appear.
- ▶ Confirm any messages on the screen.

**Delete user**

- ▶ Switch on the ignition and the Infotainment.
- ▶ Tap **MENU** > **📶** > *ŠKODA Connect (online services)* > *Registration*.
- ▶ Tap *Delete main user* > *Delete*.
- ▶ Confirm the deletion.

**Connection status of the online services**

The status of the connection to the ŠKODA Connect online services is displayed by the discolouration of the **📶** symbol shown in the status bar on the Infotainment screen.

- ▶ **White** - online services are available.
- ▶ **Grey** - online services are not available.

**Setting the personal data protection level**

The level of protection of personal data in ŠKODA Connect online services is indicated by an icon in the status bar on the Infotainment screen.



S18-0391

- ▶ Open the Infotainment control enter by holding down the bar at the top of the screen and pulling it down.

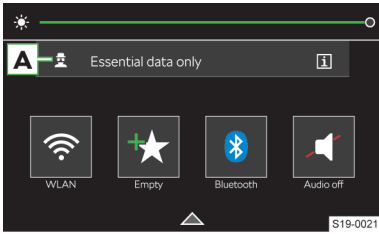

- › To **Display information**, tap **A** for the respective protection levels.
- › To display the menu for **Setting the protection level**, tap the **A** symbol.

Or:

- › Tap **MENU** > > ŠKODA Connect (online services) > Privacy settings and manage services.
- › Select one of the following options for sending vehicle and user data.

- Send only the legally required data.
- Send the vehicle and user data.
- Send the vehicle and user data as well as the data regarding the vehicle position.
- Division of vehicle position data on the website ŠKODA Connect Portal and in the ŠKODA Connect application .

### Management of online services

In the service management, it is possible to display information about the online services, the validity of their licence, or to switch the services on/off.

- › Tap **MENU** > > ŠKODA Connect (online services) > Privacy settings and manage services.

## Infotainment Amundsen

### Infotainment overview

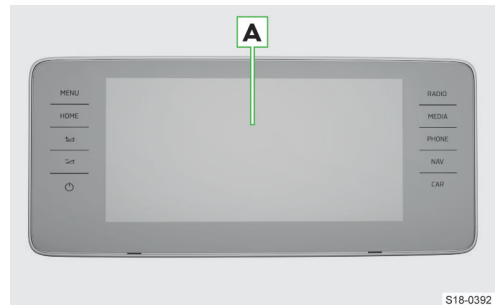

**A** Touchscreen

**MENU** All menus

**HOME** Favourite menus

Increase the volume

Decrease the volume

Condition-based:

▶ **Infotainment switched off**

▶ **Tap:** Turn on Infotainment

▶ **Infotainment switched on**

▶ **Tap:** Switch sound off/on

▶ **Hold:** Switch off Infotainment

**RADIO** Radio menu

**MEDIA** Media menu

**PHONE** Phone menu

**NAV** Navigation menu

**CAR** Information about vehicle settings

## System

### Control centre

#### Usage

The Infotainment control centre provides quick access to the following functions.

- ▶ Setting the instrument and key illumination.
- ▶ User account management.
- ▶ Setting the personal data protection level.
- ▶ Functional surfaces of preferred features.
- ▶ List of information messages.

**Opening the control centre**

- › Press the bar at the top of the screen and drag down.

**Closing the control centre**

- › Tap on  $\Delta$ .

Or:

- › Press the bar at the bottom of the screen and drag up.

Or:

- › Wait 5 seconds.

**Settings**

- › To **open edit mode**, press any functional surface of the preferred feature.
- › To **add the preferred feature**, move the desired function from the top of the screen to the functional surface at the bottom of the screen.
- › To **close edit mode**, tap on  $\times$ .

**Restriction**

For safety reasons, operation of some Infotainment functions while driving is not possible or is restricted.

The Infotainment system indicates this by means of a message in the screen.

**Basic settings****Setting basic functions**

The following Infotainment functions are set in the **MENU** >  $\text{⚙}$  menu.

- ▶ Time and date.
- ▶ Language.
- ▶ Units.
- ▶ Restore factory settings.

**Sound settings**

The Infotainment sound is set in the menu **MENU** >  $\text{🔊}$ .

The following menu items can be set.

- ▶ Setting the equalizer.
- ▶ Adjusting the volume ratio.
- ▶ Volume adjustment of individual Infotainment functions.  
Some are adjustable, for example the following menu items.
  - ▶ Volume adjustment of voice commands.
  - ▶ Setting the maximum volume when Infotainment is turned on.
  - ▶ Speed-dependent volume setting.

- ▶ Setting the Infotainment to mute with the parking aid switched on.

Depending on the equipment, the following advanced sound settings can be set.

- ▶ Setting space optimisation.
- ▶ Setting the audio profiles according to genre.
- ▶ Adjusting the subwoofer volume.

**Configuration wizard**

The configuration wizard helps to set certain Infotainment functions.

The configuration wizard is automatically displayed if there are at least two non-selected menu items after turning on the Infotainment.

- › To **switch off the automatic display**, tap on *Don't show again* when the configuration wizard is displayed.
- › For **manual display**, tap on **MENU** >  $\text{⚙}$  > *Configuration wizard*.

**Setting the HOME menu**

- › To **display another page** of the HOME menu, press the screen with two fingers and drag it to the left or right.

To **add the preferred menu**, proceed as follows.

- › Tap on an empty functional surface.

Or:

- › Press and hold an occupied functional surface and then tap on an empty functional area.
- › Select a menu with the desired dimension of the functional surface.
- › Tap on  $\times$  to exit edit mode.

To **remove the preferred menu**, proceed as follows.

- › Press an occupied functional surface.
- › Tap on  $\text{⌫}$ .
- › Tap on  $\times$  to exit edit mode.

**Setting the MENU**

The position of the functional surfaces in the MENU menu can be customized as follows.

- › Press and hold the desired functional surface until it is free.
- › Move the functional surface to a different position.

**Troubleshooting****Infotainment not responding**

The Infotainment system must be restarted.

- › Press  $\text{⏻}$  for more than 10 s.
- › Wait for the restart to complete.



## System update

We recommend having the system update carried out by a specialist company.

The system update ensures optimal function of the Infotainment system, e.g. compatibility with new phones.

### Determine system version

> Tap MENU >  > System information.

## Screen

### Overview

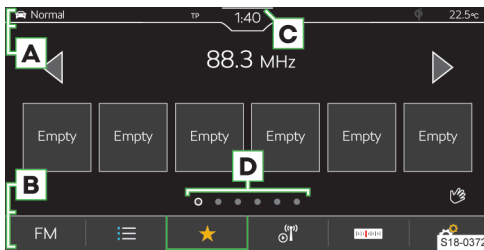

- A** Status bar
- B** Bar with the functional surfaces of the displayed menu
- C** Display of the control centre
- D** Other pages of the menu

### Operation

#### ⓘ NOTICE

Danger of screen damage!

> The Infotainment screen is operated by **touching it lightly with your finger**.

In principle, operation by touch is identical to the operation of a mobile phone.

The following operating modes are specific to the Infotainment system.

#### Dragging up or down with two fingers

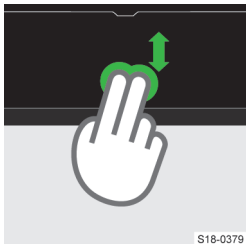

- > Quickly review the list of phone contacts.
- > Change 2D/3D map display.

#### Dragging left or right with two fingers

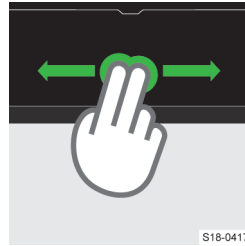

- > Display next page of the HOME menu.

#### Pulling apart with two fingers

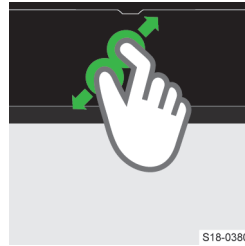

- > Enlarge image.
- > Zoom in to the map.

#### Pulling together with two fingers



- > Minimize image.
- > Zoom out of the map.

#### Turn two fingers

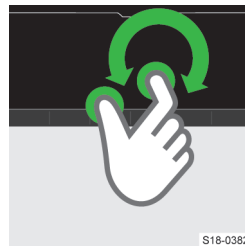

- > Rotate image.
- > Rotate the map.

#### Contactless gesture control

The Infotainment menus marked with the  symbol can be controlled by hand gestures.

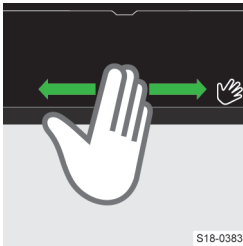

› Gesture control is achieved by slowly moving the hand back and forth approximately 8 cm above the lower edge of the screen.

Depending on the setting, a recognized gesture can be confirmed acoustically and animated.

**Displaying operation help**

› Tap on **MENU** › › .

**Settings**

The following basic screen functions are set in the **MENU** › › **Screen** menu.

- ▶ Brightness level of the screen.
- ▶ Switch off the screen.
- ▶ Display the time.
- ▶ Confirmation sounds and animations.

**Infotainment keyboard**

**Keyboard overview**

The arrangement of the keypad characters depends on the Infotainment language that has been set.

In Infotainment, the following types are used, depending on the context.

- ▶ Alphanumeric.
- ▶ Numeric.
- ▶ Keypad for input.
- ▶ Keypad for search.



Keyboard example

**A** Input line

- ▶ Delete characters before the cursor
- ▶ **Tap**: delete the last character
- ▶ **Hold**: delete all characters one after the other

- ▶ Display functional surfaces for moving the cursor in the input line
  - ▶ Move cursor to the left
  - ▶ Move cursor to the right

**B** Entries searched for

- ▶ Show list

**C** Keypad function surfaces

- ▶ Switch to lowercase
- ▶ Switch to the first capital letter, followed by lowercase letters
- ▶ Switch to uppercase
- ▶ **ABC/ABB** Switch to the language keypad
- ▶ **12#** Switch to the numeric and character keypad
- ▶ **1/2/2/2** Switch to other character variants
- ▶ Show additional keypad languages
- ▶ Insert a space
- ▶ The next line
- ▶ **Hold**: Show other character variants
- ▶ Display the entered password
- ▶ **OK** Confirm the entered characters

**Numeric keypad**

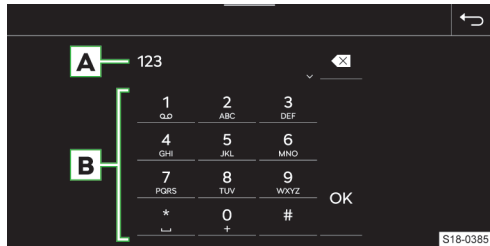

Keyboard example

**A** Input line

- ▶ Delete characters before the cursor
  - ▶ **Tap**: delete the last character
  - ▶ **Hold**: delete all characters

**B** Keypad function surfaces

- ▶ **OK** Confirm the entered characters

**I** If context-sensitive, alphanumeric characters can be entered by holding down a functional surface with a digit.

**Operation**

The Infotainment keypad is used to enter characters, letters and numbers.

The keypad will be **automatically displayed** when Infotainment prompts for characters.

**Find**

When entering characters, corresponding entries are searched for.

The entry to be searched for can be entered including diacritics.

The keyboard will only provide characters that match the stored entries.

- › To **Display searched entries** tap ∨.

**Show additional keypad languages**

To use the additional keypad languages, the desired languages must be set first.

- › Tap 🌐 or repeatedly tap the flag symbol until the desired language keypad is displayed.

**Further character variants**

- › Press and hold the sign with the symbol Ⓐ.
- › Select the desired symbol.

**Setting additional keypad languages**

- › Tap **MENU** > ⚙️ > *Additional keypad languages*.

**Voice control****Functionality****Voice control principle**

Voice control works according to the principle of dialogue between the user and the Infotainment system.

The user says a voice command. The Infotainment system responds or executes the voice command.

**Operating conditions**

- ✓ Ignition is switched on.
- ✓ Infotainment is switched on.

**Operation****Voice control process**

- › To **switch on** voice control on the multifunction steering wheel, press the 🗣️ button.

Or:

- › Say the "OK Laura" activation command.

After switching on, the 🗣️ icon is displayed.

- › Say a voice command.

During recognition of the voice command, the 🗣️ icon is displayed.

The Infotainment system then executes the voice command or plays the message. During the message, the 🗣️ icon is displayed.

After the execution of the voice command, voice control is switched off.

**Correcting a voice command**

- › During voice command input, press the 🗣️ button on the multifunction steering wheel and say a new voice command.

**Stopping voice control**

Stopping leaves more time for voice command input, e.g. for searching for a phone contact.

- › Move your finger up or down over the Infotainment screen.

Or:

- › Say the "pause" voice command.

**Resuming stopped voice control**

- › Press the 🗣️ button on the multifunction steering wheel.

Or:

- › Tap on 🗣️ in the Infotainment screen.

**Stopping the played back message**

- › Press the 🗣️ button on the multifunction steering wheel.

**Ending voice control**

- › Press and hold the 🗣️ button on the multifunction steering wheel.

Or:

- › Say the voice command "cancel" during voice command input.

**Restriction**

For some Infotainment languages, no voice control is available. The Infotainment system will indicate this.

The messages are generated by the Infotainment system. Flawless clarity (e.g. road or city name) cannot always be guaranteed.

You cannot use voice control while a phone call is in progress.

**Settings**

The following voice control functions are set in the menu **MENU** > ⚙️ > *Voice control*.

- ▶ Confirmation tones.
- ▶ Use of the activation window.

**Self-help****Starting acoustic help**

- › If the Infotainment system is expecting a voice command, say "Help".

The “Help” voice command can be issued repeatedly for further tips on voice control.

**Displaying the help**

› Tap on **MENU** > ⓘ > ?.

Or:

› If Infotainment is expecting a voice command, say “Overview”.

**Switch example voice commands display on / off**

The system offers the option of displaying example voice commands after switching on the voice control in the Infotainment screen.

› To **turn MENU** > ⚙ > voice control on/off, tap > Show in Infotainment system.

**Radio**

**Overview**

**Display main menu**

› Tap on **RADIO**.

Or:

› Tap on **MENU** > 📁.

**Analogue and digital radio reception**

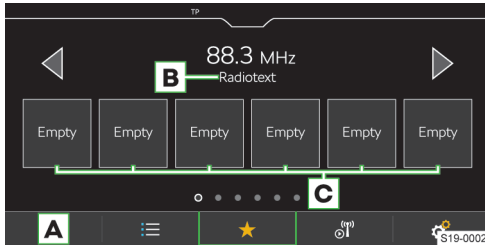

- A** Select frequency range
- B** Radio text
- C** Preset buttons for preferred stations
- ☰ List of available stations
- ★ Show favourites
- ⓘ Information about the station
- 🔍 Search stations manually (valid for AM and FM)
- ⚙ Settings

**I** Infotainment supports digital radio reception in DAB and DAB+ formats.

**List of available stations**

- › Tap on ☰.
- ⊙ Played station
- ★ Station stored on the presets
- TP A traffic radio station is set

- 📺 The DAB transmitter emits images which are displayed in the information to the station
- Manual update of the station list

In the station list, information about the program type and the type of the regional station can be displayed.

**Operation**

**Select station**

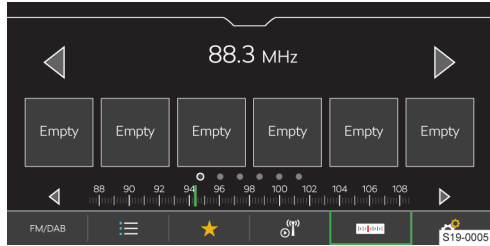

› Tap ◀ or ▶ at the top of the screen.

**SCAN function**

The function plays receivable stations of the selected frequency range in succession for a few seconds each.

- › To **start automatic play** ⚙, tap Scan.
- › To **stop automatic play**, tap ⏸.

**Find stations manually**

Manual search is available for AM and FM stations.

- › To display the 🔍 functional surface for the FM station, turn on the ⚙ > Advanced settings > Show stations: turn on > FM.
- › In the Radio main menu, tap 📁.
- › To **search in sequence**, tap ◀ or ▶ next to the displayed frequency range scale.

Or:

› Hold down the scroll mark on the frequency range scale and move it to the desired value.

**Restriction**

- ▶ Parking garages, tunnels, tall buildings or mountains can restrict radio reception.
- ▶ In the rear side windows, there are antennas for receiving the radio signal.

Covering the panes with foils or metal-coated labels may affect the reception of the radio signal.

## Settings

### Save the station currently being listened to as a favourite from the Radio main menu

- › Hold the desired station key for preferred stations until the station is stored.

### Save station to favourites from the list of available stations

- › Hold the line with the name of the desired station.
- › Tap the desired preset button.

### Deleting favourites

- › In the **Radio** main menu, tap  > Delete presets.
- › To delete a station button for preferred stations, tap the desired station button and confirm the deletion.
- › To delete all presets for preferred stations, tap *Delete all* and confirm the deletion.

### Buttons ◀ ▶

Applies to AM, FM and DAB frequency ranges.

The variant for **changing stations** using buttons ◀ ▶ in the **Radio** main menu is set as follows.

- › In the **Radio** main menu, tap  > Arrow buttons.
- › Choose the change variant.

### Switch traffic reception (TP) for stations on/off

Applies to FM and DAB frequency range.

- › In the **Radio** main menu, tap  > Traffic program (TP).

### Assign station logo from the Infotainment memory

Applies to the FM and DAB frequency ranges.

Infotainment offers the option of assigning logos, which are stored in the Infotainment memory, to the stations.

- › In the **Radio** main menu, tap  > Station logos.
- › Select the desired station and logo.

### Switching off the station logo display

Applies to the FM and DAB frequency ranges.

- › In the **Radio** main menu, tap  > Station logos.
- › Select the desired station and *No station logo*.

### Activating / deactivating automatic station logo assignment

Applies to the FM and DAB frequency ranges.

When the function is switched on, a station logo from the Infotainment memory is assigned when the station is stored on a preset.

- › In the **Radio** main menu, tap  > Advanced settings > Auto-select station logos.

### Turn on/off radio text reception

Applies to the FM and DAB frequency ranges.

When the function is switched on and the station buttons are displayed, you can see more information

about the content broadcast from the station to which you are listening.

- › In the **Radio** main menu, tap  > Radio text.

### Regional FM station logo

Applies to the FM frequency range.

Infotainment provides the option of using country-specific FM station logos.

- › In the **Radio** main menu, tap on  > Advanced settings > Region for station logo.

- › Choose the country.

### Switching additional announcements of the DAB transmitter on / off

Applies to the DAB frequency range.

When the function is switched on, other announcements are received as traffic announcements. E.g. weather news, sports reports, financial news etc.

- › In the **Radio** main menu, tap  > Advanced settings > Additional DAB announcements.

### Switch RDS on/off

Applies to the FM frequency range.

The menu item is only available for some countries.

- › In the **Radio** main menu, tap  > Advanced settings > Radio Data System (RDS).

If the **RDS function is disabled**, the following menu items in **FM station** settings are not available.

- ▶ Traffic programme (TP).
- ▶ Radio text.
- ▶ RDS Regional.
- ▶ Automatic frequency change (AF).
- ▶ Regional station logo.

### Switch automatic switching to a similar DAB transmitter on / off

Applies to the DAB frequency range.

When the function is switched on and there is signal loss from the DAB station being listened to, Infotainment automatically sets another DAB station with similar content.

- › In the **Radio** main menu, tap  > Advanced settings > Switch to a similar station if reception is poor.

### Displaying FM / DAB stations or FM stations in the list of available stations

Applies to the FM and DAB frequency ranges.

Depending on the following setting, the stations of the selected frequency range are displayed in the list of available stations.

- › In the **Radio** main menu, tap  > Advanced settings > Show stations.
- › Select one of the following menu items.
  - ▶ FM/DAB - the list shows available FM and DAB stations.

- ▶ FM - the list shows available FM stations.

## Media

### What you should be mindful of

- ▶ Do not save any important data or that which has not been backed up on the connected audio sources. ŠKODA assumes no responsibility for lost or damaged files or connected audio sources.
- ▶ When changing or connecting an audio source, this may cause sudden changes in volume. Reduce the volume before changing or connecting an audio source.
- ▶ When connecting an audio source, the source information messages can be displayed. These messages must be observed and, if necessary, confirmed.
- ▶ The national copyright laws that apply in your country must be observed.

### Overview

#### Display main menu

- ▶ Tap on **MEDIA**.



Or:

- ▶ Tap on **MENU** › .

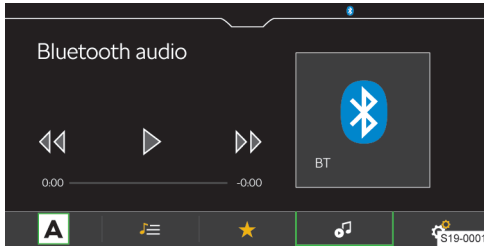
#### Music player





- A** Select source

-  Manage files / multimedia database
- ★ Show favourites
-  Details about the track being played
-  Settings

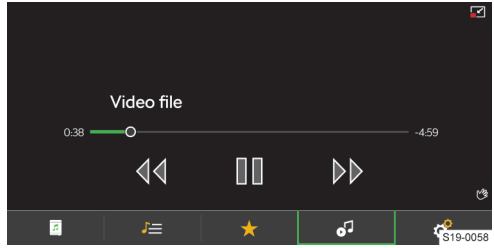
### Video player



-  Manage files / multimedia database
- ★ Show favourites
-  Show video
- Shrink image display
- Enlarge the image display
-  Settings

### Player controls

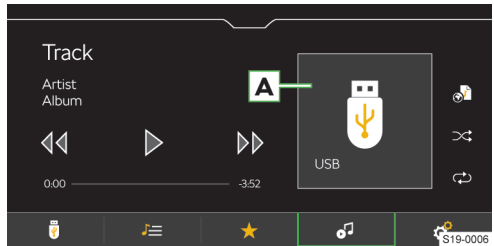

#### Operation - Basics



- A** Album image / symbol of the connected source
  - ▶ **Tap:** list available albums
- ▶ **Tap:** start playback
- ▢ **Tap:** pause
- ◀◀ **Within 3 seconds of starting playback, tap:** play the previous song
- ◀◀ **After 3 seconds, tap from the start of playback:** to play the current title from the beginning
- ◀◀ **Hold:** fast rewind within the title
- ▶▶ **Tap:** play the next song
- ▶▶ **Hold:** fast forward within the title

Movement within the title is also possible by dragging the finger over the timeline.

#### Advanced operation

-  Turn on / off repeat playback of the current track
-  Turn on / off repeat playback of the current album / folder

- › Turn on / off random playback of the current album / folder
- › Save the played track in the "My playlist" playlist

**"My playlist" management**

- ▶ To display the playlist, tap › › › .
- ▶ To manage the playlist tap in the displayed playlist.

The following activities can be carried out in playlist management.

- ▶ Control playback.
- ▶ Change the order of a title in the list by holding and moving to the desired position.
- ▶ Delete title.

- › Choose one of the available list entries **B**.
- › To **delete**, in the **media** main menu, tap on › manage favourites.
- › To delete a **favourite**, tap on the list entry and confirm the deletion.

Or:

- › To delete **all favourites**, tap on *Delete all* and confirm the deletion.

**Traffic**

- › To **turn on/off** the traffic monitoring during the playback of media files, go to the **Media** main menu and tap on › **Traffic programme (TP)**.

**Settings**

**Manage favourites**

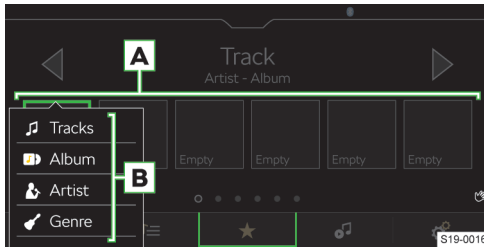

- › To **save**, hold the desired functional area for favourites **A**.

**Supported sources and files**

Source	Interface	Type	Specification	File system
USB	USB 1.x; 2.x 3.x or higher with USB 2.x support	MSC	USB stick	VFAT FAT16 FAT32 exFAT NTFS
			HDD (without special software)	
		USB devices that use the USB mass storage support protocol		
MTP	Devices running the Android or Windows Phone operating system that support the Media Transfer Protocol			
Apple	Devices with the iOS operating system and the iAP2 protocol		HFS+	

Source	Interface	Type	Specification	File system
Bluetooth® player	Bluetooth®	-	Bluetooth® protocols A2DP and AVRCP (1.0 - 1.5)	-

Supported sources

#### Compatibility of mobile devices

It is possible to check the ŠKODA web pages to see if Infotainment is compatible with the selected mobile device being tested. This check is carried out by using the following reference or by reading the QR code.

► <http://go.skoda.eu/compatibility>



Compression format	Codec type	File extension	Max. bit rate [kbps]	Max. sampling rate [kHz]	Multi channels
MPEG	MPEG 1 Layer 2	mp2	32 - 384	32, 44, 48	Mono, stereo, Joint stereo
	MPEG 2 Layer 2		8 - 160	16, 22, 24	
	MPEG 1 Layer 3	mp3	32 - 320	32, 44, 48	Mono, dual mono, Stereo, Joint Stereo
	MPEG 2 Layer 3		8 - 160	16, 22, 24	
MPEG 2.5 Layer 3	8, 11, 12				
WMA	Windows Media Audio 7	wma	6 - 192	8, 16, 22, 32, 44, 48, 96	Mono, stereo, Joint stereo
	Windows Media Audio 8		8 - 384	8, 11, 16, 22, 32, 44, 48, 96	
	Windows Media Audio 9 and 9.1		8 - 768		
	Windows Media Audio 9.2		8 - 320		
	Windows Media Audio 10		32 - 768	32, 44, 48, 96	
ADTS	AAC LC	aac	16 - 2048	22, 24, 32, 44, 48	Stereo
	AAC HE			16, 22, 24, 32, 44, 48	
	AAC HEv2			32, 44, 48	
MP4	M4A LC	m4a	16 - 400	22, 24, 32, 44, 48	Stereo
	M4A HE			16, 22, 24, 32, 44, 48	
	M4A HEv2			16 - 64	
OGG	OGG-Vorbis	ogg	8 - 576	8, 11, 12, 16, 22, 24, 32, 44, 48, 96	Mono, Stereo
FLAC	FLAC	flac	-	8, 11, 12, 16, 22, 24, 32, 44, 48, 64, 88, 96, 192	Mono, stereo, Joint stereo
RIFF	WAV	wav	64 - 3072	8, 11, 12, 16, 22, 24, 32, 44, 48, 96	Mono, Stereo
Monkey's	Monkey's	ape	8 - 192		
SBC	Bluetooth A2DP	-	8 - 345	8, 11, 12, 16, 22, 24, 32, 44, 48	Mono, stereo, Joint stereo



Compression format	Codec type	File extension	Max. bit rate [kbps]	Max. sampling rate [kHz]	Multi channels
OPUS	OPUS	opus	6 - 2000	8 - 48	Mono, stereo, Multichannel

Supported audio files

Files that are protected by **DRM-** and **iTunes®** methods are not supported by Infotainment.

Codec type	File extension	Max. recordings per second bit rate [Mbit/s]
MPEG 1	mpg mpeg m1v mPV	1.5
MPEG 2	mpg mpeg ps m2v	15
MPEG 4 (H.264)	m4p mp4 m4v mp4v mov	50
MPJEG		
MPEG 4 (ISO)		
Xvid	Xvid	20
WMV9	wmv asf	50

Supported video files

Codec type	File extension
M3U	m3u
M3U8	m3u8
PLS	pls
WPL	wpl
ASX	asx

Supported playlists

## Images

⚙ Settings

### Overview

### Operation

#### Display main menu

> Tap on MENU >

#### Touch operation

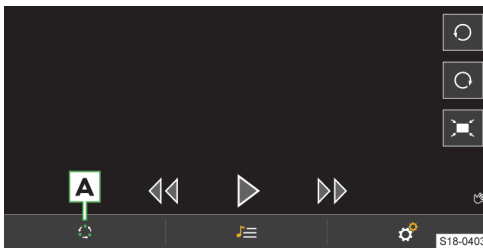

**A** Select source

Manage files

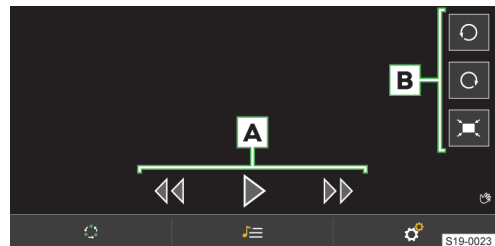

**A** Look at images

Show the next image

- ▶ ◀◀ Show the previous image
- ▶ ▶ Start slideshow
- ▶ ◻◻ Stop slideshow

**B**

- View image
  - ▶ ○ Turn to the left
  - ▶ ○ Turn to the right
  - ▶ ✖ Display in initial size

**Gesture control**

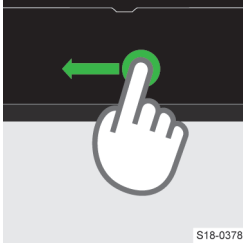

▶ Show the next image.

S18-0378

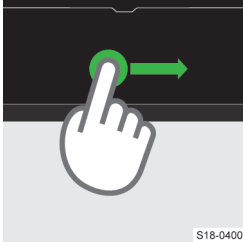

▶ Show the previous image.

S18-0400

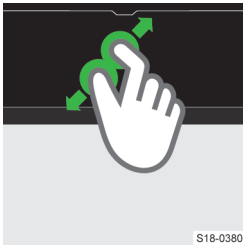

▶ Enlarge view.

S18-0380

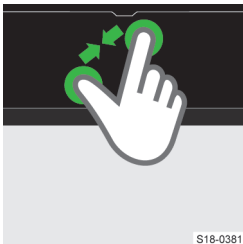

▶ Zoom out.

S18-0381

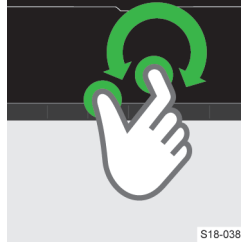

▶ Turn 90°.

S18-0382

**Settings**

The following Infotainment functions are set in the MENU > > menu.

- ▶ Display image size.
- ▶ Display image duration during the slideshow.
- ▶ Slideshow repeat.

**Supported sources and files**

Source	Interface	Specifica- tion	File system
USB	USB 1.x; 2.x 3.x or higher with USB 2.x support	USB stick	VFAT
		HDD (without special software)	FAT16 FAT32 exFAT NTFS

**Supported sources**

Codec type	File extension	Max. resolution [Mpx]
BMP	bmp	4
JPG; JPEG	jpg; jpeg	4 (Progressive Mode) 64
GIF	gif	4
PNG	png	4

**Supported files**

The maximum supported image size is 20 MB.

**User management**

**Functionality**

User Management displays the accounts of the last active users.

In the user management, new user accounts can be edited and added.

## Settings

### Logging in

After turning on Infotainment, a menu of one of the following user accounts is displayed.

- ▶ **User account associated with the key** with which the unlocking of the vehicle took place.

When the vehicle is locked, the Infotainment assigns the last used user account to the key.

The requirement is the activated **MENU** › › › *Assign vehicle keys automatically* menu item.

- ▶ **User account of the last logged in user.**

The **MENU** › › › *Assign vehicle keys automatically* menu item is not switched on.

- ▶ **Guest user account.**

No user account was detected.

Some user accounts can be protected. Protected accounts are in the user list showing the icon .

To **log in** to the protected user account you need the S-PIN created when creating the account on the ŠKODA Connect Portal website, in the ŠKODA Connect application or when registering the user in infotainment.

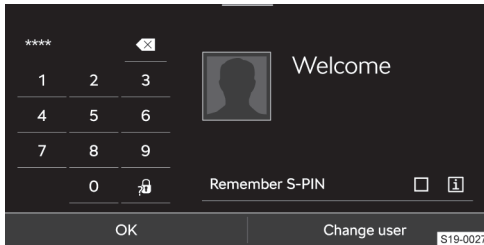

- ▶ If you do not want to enter the S PIN next time, please select the *Remember S-PIN* option.

Verification of the user by entering the S-PIN can be **switched off/on** in the **MENU** › › › *Protect user profile* › *Protect user profile* menu item.

- ▶ To register another user, tap on **Change users**.

A menu with additional users and the option to enter a new user will be displayed.

### Log out user

When the ignition is switched on, the user logs off automatically.

If the user account is protected by the S-PIN, the following functional areas are displayed.

- ▶ **OK** - after switching on the ignition again within 30 minutes, no registration for the protected user account using the S-PIN is necessary.
- ▶ **Sign out** - after switching on the ignition, the S-PIN is required to log in to the protected user account.

### Delete user

- ▶ To display the user accounts **MENU** › › ›, tap *Delete users*.

- ▶ To delete the user, select the user and confirm the deletion.

When the user is a “Main user”, the rights of the main user can be withdrawn.

### Delete the current user account

- ▶ **MENU** › › › Tap *Delete user profile* and confirm the deletion.

### User management

- ▶ Tap on **MENU** › .

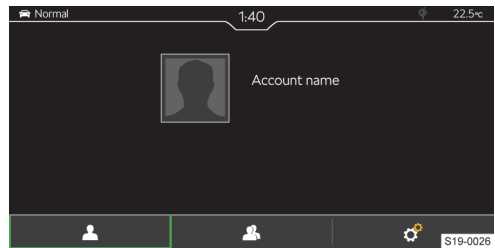

- ▶ Details of the currently selected user

- ▶ - A user account protected by the S-PIN

- ▶ Change to another user / input data for a new user

- ▶ Settings

## Mobile device management

### Overview

Using mobile device management, devices can be connected, disconnected, and interchanged.

### Display mobile device management

- ▶ Tap on **MENU** › › *Manage mobile devices*.

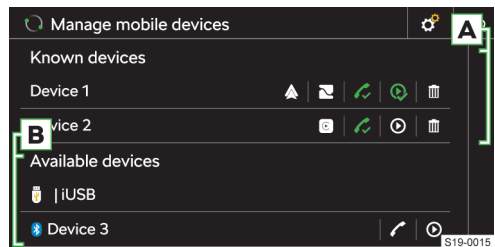

- ✓ The device enables a connection via the Bluetooth®“hands-free profile”
- ✓ The device is connected via the Bluetooth®“hands-free profile”
- ⊙ The device enables a connection via the Bluetooth® audio profile
- ⊙ The device is connected via the Bluetooth® audio profile

- ▣ Remove the device from the list **previously connected devices**
- ▲ The device enables a SmartLink connection to be made via Android Auto
- Ⓜ The device enables a SmartLink connection to be made via Apple CarPlay
- ▣ The device enables a SmartLink connection to be made via MirrorLink
- A Connected / Previously connected devices
- B Available devices

## Limitations of mobile devices and applications

### Availability of features

The availability of certain features depends on the type of mobile device, as well as that of the applications installed.

### Compatibility of mobile devices

It is possible to check the ŠKODA web pages to see if Infotainment is compatible with the selected mobile device being tested. This check is carried out by using the following reference or by reading the QR code.

▶ <http://go.skoda.eu/compatibility>



### Bluetooth® compatibility of mobile devices

Due to the large number of mobile devices, it is not possible to guarantee total Bluetooth® compatibility with Infotainment. Bluetooth® compatibility depends on the Bluetooth® version as well as the implementation of Bluetooth® protocols by the manufacturer of the mobile device.

### Applications in mobile devices

Mobile devices can be used to install applications that allow you to view additional information on the Infotainment screen, or to operate the Infotainment system.

Due to the variety of applications, as well as their ongoing development, the available applications may not function on all mobile devices. ŠKODA AUTO assumes no liability for their proper functioning.

The scope of available applications and their functionality is dependent on the type of Infotainment, as well as the vehicle and country.

## Connection set-up

### Connect a mobile device to Infotainment

- › Find available Bluetooth® devices in the mobile device.

- › Select the Infotainment Bluetooth® unit.

The unit name can be determined by tapping **MENU** > > *Manage mobile devices* > > *device name*.

- › Confirm the PIN; enter it if necessary and then confirm.

### Connect Infotainment to a non-paired mobile device

- › Tap on **MENU** > > *Manage mobile devices*.
- › Select the desired device from the list of **available devices**.
- › Select the desired Bluetooth® profile.
- › Confirm the PIN; enter it if necessary and then confirm.
- › If two devices are connected to the Infotainment, select the device to be replaced.

### Connect Infotainment to a previously connected mobile device

- › Tap on **MENU** > > *Manage mobile devices*.

Or:

- › Tap on **PHONE** > > *Select mobile phone*.
- › Select the desired device from the list of **previously connected devices**.
- › Select the desired Bluetooth® profile.
- › If two devices are connected to the Infotainment, select the device to be replaced.

### SmartLink Connection

Infotainment provides the ability to connect SmartLink to compatible mobile devices using the following connection types.

- ▲ Android Auto
- Ⓜ Apple CarPlay
- ▣ MirrorLink

Mobile devices can be connected to the Infotainment via USB cable or Wi-Fi, as long as the mobile device supports it.

- › Connect the mobile device to the Infotainment.
- › Tap the icon of the supported connection.

## Telephone

### Telephone main menu

#### Display main menu

- › Tap on **PHONE**.

Or:

- › Tap on **MENU** > .

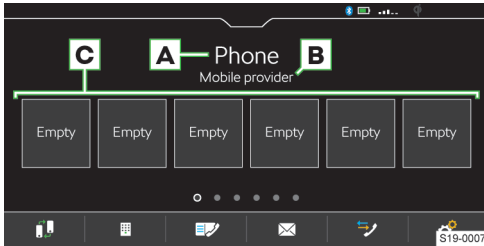

- A** Name of the connected telephone
  - ▶ **Tap:** Show list of previously connected phones
- B** Name of telephone service providers
  - ▶ If the symbol ▶ is displayed in front of the name, roaming is active.
- C** Preset buttons for preferred contacts
  - 📞 Change the main telephone with the additional telephone
  - ☎ Enter telephone number
  - 📞 Contact list
  - ✉ Text messages / emails
  - 📞 Call lists
  - ⚙ Settings

### Conditions for connecting a telephone with Infotainment

- ✓ The Bluetooth® function of the Infotainment and the telephone needs to be switched on.
 

The Bluetooth® function of the Infotainment is switched on in the menu item **MENU** > ☰ > *Manage mobile devices* > 📶 > *Bluetooth*.
- ✓ Visibility of the Infotainment is switched on.
 

The visibility of the Infotainment is switched on in the menu item **MENU** > 📶 > *Manage mobile devices* > 📶 > *Visibility*.
- ✓ The telephone is within signal range of the Infotainment's Bluetooth® unit.
- ✓ The telephone is compatible with Infotainment.
- ✓ Through Infotainment, no mobile device can be connected using Apple CarPlay.

### Telephone operation

#### Enter telephone number

- › In the **Telephone** main menu, tap 📞.
  - › Enter the telephone number using the numeric keypad that is displayed.
- I** The displayed numeric keypad can also be used for searching for contacts.

If, for example, the digits 32 are entered, contacts with the letter sequence DA, FA, EB etc. are displayed next to the numeric keypad.

#### List of telephone contacts

The list of telephone contacts is imported from the connected main telephone.

- › Tap to **display** the contact list in the **telephone** main menu 📞.
- › To **search** within the list, tap *Enter contact*.
- › Enter the details you wish to find.
- › To **establish a connection** with a contact, tap the functional area showing the desired contact.

If a contact has multiple telephone numbers, select the telephone number from the displayed list.

- › To display the **details** for a contact, tap >.

#### Establish a connection to the voice mailbox number

- › In the **Telephone** main menu, tap 📞 > ☎.

#### Telephone conversation

Depending on the context of the telephone conversation, the following functions can be selected.

- 🔴 End connection / reject incoming call / end call
- 🟢 Answer an incoming call / return to the held call
- 🔊/🔇 Switch the ringer off / on
- 📞 Hold a call
- 🔇/🔊 Switch the microphone off / on
- 👤 Show details of the caller
- 📞 Answer a call from the second telephone during a call on the first telephone
 

The ongoing call on the first telephone is terminated by accepting the call.

- › To **switch the call tone from the speakers to the telephone**, go to the **telephone** main menu and tap on 📞 > *hands-free*.

- › To **switch the call tone from the telephone to the speakers**, tap 📞.

#### Conference call

A conference call is a joint telephone conversation with a minimum of three and a maximum of six participants.

- › Make the next call during an ongoing conversation/conference.

Or:

- › Accept a new incoming call by tapping the functional area 🟢.
- › To **start** a conference call, tap on the functional area 📞+📞.

During an ongoing conference call, the following functions can be selected depending on the context.

- 📞 Hold the conference call and leave temporarily (the conference will continue in the background)

- ↶ Return to the conference being held
- 🔇/🔊 Switch the microphone off / on
- 🔴 End the conference
- 👤 Show details of the conference call

In the details of the conference call, depending on the connected telephone, the following functions can be selected.

- 👤 Show details of the conference call participants
- 🔴 End conversation with the conference call participant
- 👤👤 Conversation with a participant outside of the conference call

#### Send a text message

- In the **Telephone** main menu, tap > Messages > New text message.
- Write a text message and confirm; a view of the message is displayed.  
The message can be edited when the text area within the view is tapped.
- Search for or select the recipient of the message.
- Add more recipients or confirm selected recipients.
- Tap **Send**.

#### Display received text messages

- In the **Telephone** main menu, tap > Messages > or .
- Messages that are received are displayed as individual messages or as messages in a conversation, depending on the following setting.  
In order to **switch the display of text messages in a conversation on or off**, go to the **Telephone** main menu and tap > *Show messages as a conversation*.
- To **switch on or off a graphic notification** regarding the receipt of a new message, go to the **Telephone** main menu and tap > *New message notifications*.

**[i]** Infotainment offers the possibility to read the text message (context-dependent) by means of the generated Infotainment voice if is tapped.

#### Send E-mails

- In the **Telephone** main menu, tap on > E-mails > New e-mail.
- Write an e-mail and confirm that an e-mail is displayed.  
The text can be edited when the text area within the view is tapped.
- Search for or select the recipient of the email.
- Add more recipients or confirm selected recipients.
- Enter the subject of the e-mail.
- Tap **Send**.

#### Show received e-mails

- In the **Telephone** main menu, tap > E-mails > .

- Select the desired e-mail.
- To **switch on or off a graphic notification** regarding the receipt of a new e-mail, go to the **Telephone** main menu and tap > *New message notifications*.

### Settings for Infotainment telephone functions

#### Telephone-Infotainment-Connection types

The way in which the telephone is connected depends on the number of phones currently connected to the Infotainment.

- ▶ **No telephone** - The telephone is connected as a main telephone.
- ▶ **One telephone** - The telephone is connected as an additional telephone.
- ▶ **Two telephones** - Select the telephone to be replaced.
- To **switch between the main telephone and the supplementary telephone** in the main menu, tap **telephone** .

#### Connect the telephone to Infotainment

- Find available Bluetooth® devices on the phone.
- Select the Infotainment Bluetooth® unit.

The unit name can be determined by the menu item **MENU** > > *Manage mobile devices* > > *Device name*.

- Confirm the PIN; enter it if necessary and then confirm.

#### Connect Infotainment to a non-paired telephone - no telephone is connected

- Tap on **PHONE**.

Or:

- Tap on **MENU** > .
- Follow the instructions in the Infotainment screen.

#### Connecting Infotainment to a non-paired telephone - another telephone is connected

- Tap on **MENU** > > *Manage mobile devices*.
- Select the desired device from the list of **available devices**.
- Select the desired Bluetooth® profile.
- Confirm the PIN; enter it if necessary and then confirm.

The telephone is connected as an additional telephone.

Or:

- If two telephones are connected to the Infotainment, select the telephone to be replaced.

#### Connect Infotainment to a previously paired telephone

- Tap on **MENU** > > *Manage mobile devices*.

Or:

Tap on **PHONE** > > *Select mobile phone.*

- > Select the desired device from the list of **previously connected devices**.

The telephone is connected as an additional telephone.

Or:

- > If two telephones are connected to the Infotainment, select the telephone to be replaced.

**Manage preset buttons for preferred contacts**

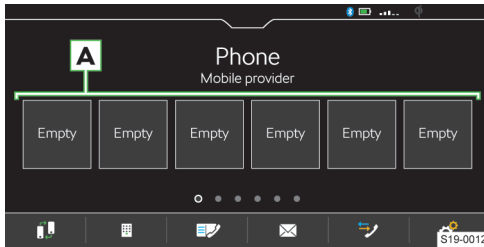

- > To **save** the desired preset button, press and hold

**A**.

- > Select a contact from the displayed list.
- > If the contact contains multiple telephone numbers, choose the desired telephone number.
- > To **display the menu for deleting** go to the **Telephone** main menu and tap > *manage favourites*.
- > To delete **one** preset, tap on the list entry and confirm the deletion.

Or:

- > To delete **all** presets, tap on *Delete all* and confirm the deletion.

**Import telephone contacts**

After first connecting the main telephone with Infotainment, telephone contacts will start to be imported into the Infotainment memory.

Infotainment can import up to 5000 telephone contacts together with contact pictures. Each contact can include max. 5 telephone numbers.

Depending on the type of telephone, import confirmation may be required.

**Update telephone contacts**

When re-connecting the telephone with Infotainment, an **automatic** update of the list is carried out.

- > For a **manual** update of the list in the **telephone** main menu, tap on > *Import contacts*.

**Sort contacts in the phone book**

- > In the **telephone** main menu, tap on > *Sort by*: and select the sort type.

**Ringer**

Some phones do not allow the use of the telephone ringtones; instead, the Infotainment ringtone is used.

- > To **set the Infotainment ring** go to the **Telephone** main menu and tap > *Select ringtone*.
- > Select the ringtone.

**Number for the voice mailbox**

- > To **set the voice mailbox number** go to the **Telephone** main menu and tap on > *Mailbox number*.
- > Enter the number of the voice mailbox.

**Turn the graphic notice regarding receiving a new message/email on or off**

When the feature is on, the new message icon appears on the status bar and in the feature area for the messages when a new message/e-mail is received.

- > In the **Telephone** main menu, tap > *New message notifications*.

**Simultaneous calls**

*This applies to some countries.*

Depending on the connected telephone, it is possible to answer the next incoming call and hold the previous call.

- > To switch on simultaneous calls, tap on **telephone** > *Parallel talks*.

**Wi-Fi**

**Functionality**

The Wi-Fi can be used for the internet connection or for the SmartLinkConnection.

The Infotainment hotspot can connect up to 8 mobile devices. At the same time, the Infotainment can be connected to another hotspot.

- > To display the list of connected mobile devices, tap **MENU** > > *Wi-Fi* > *Infotainment system as hotspot* > *Connected devices*.

**Overview of available hotspots**

**Display available hotspots**

- > Tap **MENU** > > *Wi-Fi* > *Wi-Fi*.

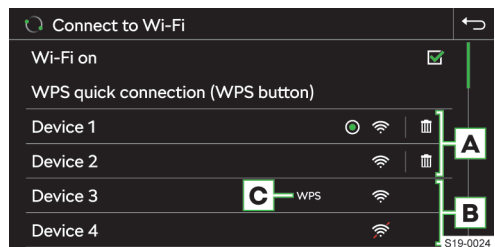

**A** Previously connected hotspots

**B** Available hotspots

- C** The hotspot supports the WPS connection
- ⊙ Currently connected hotspot
- ☰ Delete information about the hotspot connection
- 📶 Wi-Fi signal strength of the hotspot
- 📶 The Wi-Fi signal from the hotspot is not available

### Function restriction

The Infotainment system can only be connected to a hotspot with WPA2 access protection.

### Settings

#### Connect a mobile device to the Infotainment hotspot

- › Turn on the Infotainment's Wi-Fi hotspot in the menu item **MENU** › 📶 › Wi-Fi › Infotainment system as a hotspot › Use as a hotspot.
- › Turn on the Wi-Fi on the mobile device.
- › In the list of available Wi-Fi devices, look for Infotainment Wi-Fi.

The name of the Infotainment is taken from the menu item **MENU** › 📶 › Wi-Fi › Infotainment system as a hotspot › Network name..

- › Select the Infotainment hotspot and enter the required password.

The password for connecting to the Infotainment hotspot is taken from the menu item **MENU** › 📶 › Wi-Fi › Infotainment system as hotspot › Network key.

- › Confirm the connection.

#### Connect Infotainment to the mobile device hotspot

- › Turn on the Infotainment's Wi-Fi unit in the menu item **MENU** › 📶 › Wi-Fi › Wi-Fi: › Wi-Fi on.
- › Select the desired hotspot in the list of available hotspots.
- › Enter the password for connecting to mobile devices.

- I** Infotainment stores passwords for previously connected hotspots.

#### Security level of the Infotainment hotspot

The security level is factory-set at WPA2 and cannot be changed.

#### Data transmission with the connected device

- › To turn data transmission with the connected device on or off, tap **MENU** › 📶 › Wi-Fi › Infotainment system as hotspot › Connected devices › 📶.

#### Change the name of the Infotainment hotspot

- ▶ Tap **MENU** › 📶 › Wi-Fi › Infotainment system as hotspot › Network name..
- ▶ Enter the name and confirm.

#### Change password for connection to Infotainment hotspot

The password must be a minimum of 8 and a maximum of 63 characters.

- ▶ Tap **MENU** › 📶 › Wi-Fi › Infotainment system as a hotspot › Network key..
- ▶ Enter the password and confirm.

#### Quick connection of Infotainment with the mobile device hotspot

- › On the mobile device, turn on the hotspot, its visibility, and the option for WPS connection.
- › Tap **MENU** › 📶 › Wi-Fi › Wi-Fi: › WPS quick connection (WPS button).

#### Automatic WPS connection

- › Tap **MENU** › 📶 › Wi-Fi › Quick connection to Infotainment system.
- › In the mobile device, switch on the option for connection via WPS.
- › Wait for the connection to be established and, if necessary, confirm the respective messages.

#### Manual WPS connection

- › In the mobile device, switch on the option for connection via WPS PIN.

The mobile device display will show the WPS PIN for connecting to the Infotainment.

- › Tap **MENU** › 📶 › Wi-Fi › Quick connection to Infotainment system › 📶 › WPS PIN.
- › Enter the WPS PIN in the Infotainment and confirm.
- › Wait for the connection to be established and, if necessary, confirm the respective messages.

#### Automatic connection using the QR code

- › Tap **MENU** › 📶 › Wi-Fi › Quick connection to Infotainment system.
- › In the mobile device, switch on the option for connection via QR Code.
- › With the mobile device, read the QR code displayed on the Infotainment screen.
- › Wait for the connection to be established and, if necessary, confirm the respective messages.

#### Tips for a perfect connection

- I**
- ▶ Keep only the hotspot to be connected switched on and switch off the other hotspots.
- ▶ Delete unused hotspots. This shortens the time required to establish a connection.
- ▶ For some hotspots, the connection takes longer, so wait for the connection to finish.
- ▶ If the connection is interrupted, recheck the available hotspots and repeat the connection.



## SmartLink

### Functionality

SmartLink offers the ability to display and operate certified applications from a connected mobile device in the Infotainment screen.

Certification may be conditional upon the use of the latest update to the particular SmartLink application.

Applications include, for example, apps for route guidance, telephoning, listening to music, etc.

Mobile devices can be connected via a USB cable or Wi-Fi.

### Supported connection types

SmartLink supports the following connection types.

- ▶ Android Auto.
- ▶ Apple CarPlay.
- ▶ MirrorLink.

### Overview of the SmartLink connection

#### Main menu SmartLink

▶ Tap on MENU > 

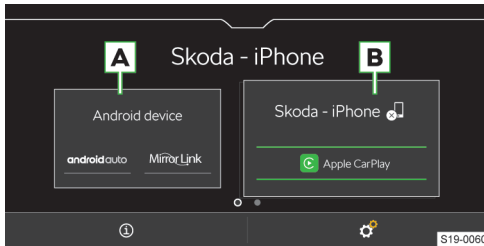

**A** Previously connected device

**B** Currently connected device

- ① Display information about SmartLink
- 🔊 Separation of the active connection
- ⚙️ Settings for the SmartLink menu

### Android Auto

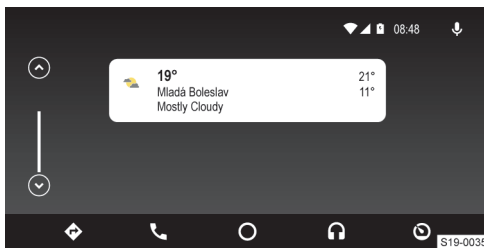

- 📍 Navigation applications
- ☎️ Telephone applications

○ Overview of running applications, phone calls, incoming text messages, and more.

🔊 Music applications

📺 Display of other available applications as well as the option to return to the SmartLink main menu

🗣️ Turn on voice control (Google Voice)

### Apple CarPlay

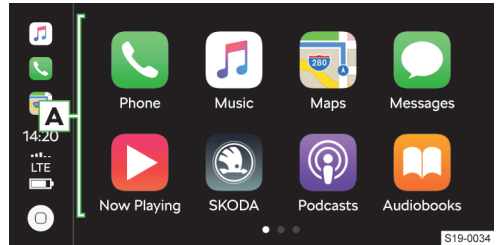

**A** List of available applications

○ Depending on the duration of operation:

- ▶ **Tap:** Return to the Apple CarPlay main menu
- ▶ **Hold:** Turn on voice control (Siri)

### MirrorLink

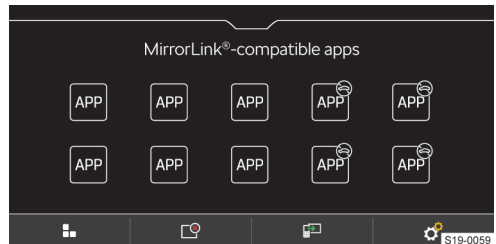

⊖ It is not possible to operate the application while driving

🏠 Return to the SmartLink main menu

📺 List of running applications

📺 Display of the last running application in connected mobile devices

⚙️ Settings

### Connection conditions

#### General connection conditions

- ✓ The mobile device supports the following SmartLink connection types: Android Auto, Apple CarPlay and MirrorLink.
- ✓ Mobile devices, as well as the type of SmartLink connection, are supported in the respective market.
- ✓ Some connected mobile devices require the mobile device to be "unlocked".

**Conditions for Android Auto**

- ✓ The device to be connected must have Android AutoSupport.
- A list of devices, supported regions and applications that the Android Auto connection supports can be found on the websites of Google Inc..
- ✓ The Android Auto application needs to be installed on the mobile device.
- ✓ Some applications require the data connection in the mobile device to be turned on.

**Conditions for Apple CarPlay**

- ✓ The device to be connected must have Apple CarPlaySupport.
- A list of devices, supported regions and applications that the Apple CarPlay connection supports can be found on the websites of Apple Inc..
- ✓ Siri voice control is on.
- ✓ The data connection is switched on in the mobile device.

**Conditions for MirrorLink**

- ✓ The device to be connected must have MirrorLinkSupport.
- A list of devices and applications that the MirrorLink connection supports can be found on the websites of Car Connectivity Consortium®.
- ✓ The MirrorLink application needs to be installed on the mobile device.
- ✓ Some applications require the data connection in the connected mobile device to be turned on.

**Restriction****Restriction of the navigation function**

If route guidance is currently being carried out through Infotainment, this is ended when you start route guidance in the Apple CarPlay application.

If there is route guidance in the Apple CarPlay application, it is ended by starting the destination guidance using Infotainment.

**Restriction of SmartLink applications while driving**

For safety reasons, operation of some SmartLink applications while driving is not possible or is restricted.



**Operation****Operation of the running MirrorLink application**

- Display of control surfaces at the bottom
- Display of control surfaces at the top
- ☰ Return to the MirrorLink main menu

**SmartLink settings****Apple CarPlay - Connection via USB**

- › Turn on the Infotainment.
- › Turn on the mobile device.
- › Connect the mobile device to the front USB input using a cable.
- › Choose to connect via Apple CarPlay.

**Apple CarPlay - Connection via Wi-Fi from Infotainment**

- › Turn on Bluetooth® and Bluetooth® visibility in the Apple mobile device.
- › Tap on **MENU** ›  › *Manage mobile devices*.
- › In the displayed list, look for and select the desired device with the symbol .
- › Follow the instructions on the Infotainment screen and confirm the Bluetooth® pairing.
- › If another device is connected to the Infotainment, select the device to be replaced.

**Apple CarPlay - Connection via Wi-Fi from mobile devices**

To establish a connection, the following conditions must be met.

- ✓ The minimum iOS version is 9.
- ✓ No other mobile device can be connected via SmartLink.
- ✓ Wi-Fi and Bluetooth® functionality is switched on in the Infotainment system.
- › In the mobile device, turn on the CarPlay function.
- › Press and hold the  button on the multifunction steering wheel.

The Infotainment screen displays a connection message with the name of the Bluetooth® unit of the Infotainment.

- › Find available Bluetooth® devices on the phone.
- › Select the Infotainment Bluetooth® unit.
- › If necessary, confirm the PIN.
- › In the Infotainment screen, select the connection type Apple CarPlay.

**Apple CarPlay - Disconnection**

- › In the Apple CarPlay main menu, tap on the "ŠKODA" functional area.
- › Tap on .

**Android Auto - Connection via USB**

- › Turn on the Infotainment.
- › Turn on the mobile device.
- › Connect the mobile device to the front USB input using a cable.
- › Choose to connect via Android Auto.

**Android Auto - Disconnection**



- › In the main menu of Android Auto  › tap on "Return to ŠKODA".

- › Tap on .

**MirrorLink - Connection via USB**

- › Turn on the Infotainment.
- › Turn on the mobile device.
- › Connect the mobile device to the front USB input using a cable.
- › Choose to connect through MirrorLink.

**MirrorLink - Disconnection**

- › In the MirrorLink main menu, tap .
- › Tap on .

**Change to another device / connection type**

Infotainment allows you to switch between currently connected devices and the connection type.

- › Tap on MENU › .
- › Select the desired device or connection type.

**ŠKODA Connect online services**

**Functionality**

ŠKODA Connect online service offer the option of connecting the vehicle to the online world. They thus represent an extension of the vehicle and Infotainment functions.

For ŠKODA Connect Services functionality, the vehicle must be within range of a mobile network through which the ŠKODA Connect Services are provided. The availability, the connection speed and the technology used in the mobile network can be different in the respective countries and are dependent on the mobile network operator.

The ŠKODA Connect online services are not included in the equipment of the vehicle. These will be published separately on the ŠKODA Connect Portal website, in the ŠKODA Connect application or ordered in Infotainment.

The offer of ŠKODA Connect online services depends on the type of vehicle and its trim level, Infotainment and country. Availability in each country can be checked on the ŠKODA Connect website.

The rights and obligations of the Parties with respect to the provision of these services are governed by a separate agreement. Current legal documents regarding the online services can be found on the ŠKODA Connect Portal as well as the ŠKODA Connect application.

**ŠKODA Connect website**

- › <http://go.skoda.eu/skoda-connect>



For example, the ŠKODA Connect website contains the latest information about the online services, a link to the ŠKODA Connect Portal as well as the

option of downloading the ŠKODA Connect application.

**ŠKODA Connect Portal website**

- › <http://go.skoda.eu/connect-portal>



The ŠKODA Connect Portal website is used, for example, for registration, activation and ordering of online services. It also provides the option of remote access to the vehicle.

**Information call**

The information call may be used in the case of problems with the online services or for information regarding the products and services of the ŠKODA brand.

- ✓ The functional condition represents the active online ŠKODA Connect services.

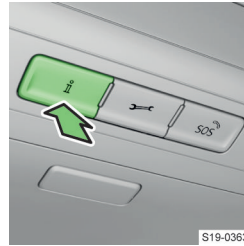

- › Press the  button.

**Breakdown call**

The breakdown call can be used in the event of a breakdown.

- ✓ The functional condition represents the active online ŠKODA Connect services.

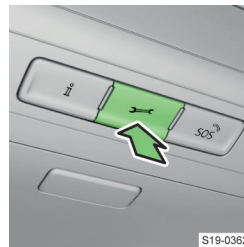

- › Press the  button.

**ŠKODA Connect Application**

The ŠKODA Connect application enables remote access to the vehicle using a mobile device. It can also be used for user registration and to activate and configure the online services.

The application can be downloaded to the mobile device after scanning the following QR code or link.

- › <http://go.skoda.eu/skodaconnectapp>



## Settings

Use of the ŠKODA Connect online services requires **prior registration of the main user** and subsequent **activation of the online services**.

### Registration and activation of online services

User registration and activating ŠKODA Connect online services is carried out on the ŠKODA Connect Portal website, in the ŠKODA Connect application, or in Infotainment.



In order to complete user registration, you will need to access your e-mails.

To activate ŠKODA Connect online services in the vehicle, two original keys from your vehicle are required.



### Registering and activating online services in infotainment - no user

- › Turn on the Infotainment.
- › In the welcome window that appears, tap *Register*.
- › Enter the required information and confirm.
- › Follow the instructions on the screen.

### Registration and activation of online services in Infotainment - new user

- › Turn on the Infotainment.
- › Tap **MENU** ›  ›  › *New user*.
- › Enter the required information and confirm.
- › Follow the instructions on the screen.

### Delete user

- › Tap **MENU** ›  ›  › *Delete user*.
- › Select the user and confirm the deletion.

### Connection status of the online services

The status of the connection to the ŠKODA Connect online services is displayed by the discolouration of the  symbol shown in the status bar on the Infotainment screen.

- ▶ **White** - online services are available.
- ▶ **Grey** - online services are not available.

### Setting the personal data protection level

The level of protection of personal data in ŠKODA Connect online services is indicated by an icon in the status bar on the Infotainment screen.





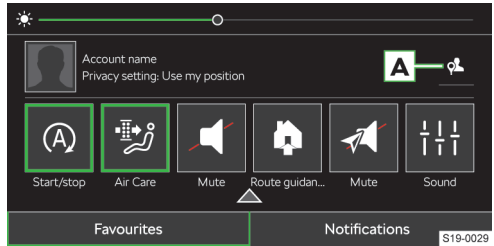

S18-0391

- › Open the Infotainment control enter by holding down the bar at the top of the screen and pulling it down.

› To **Display information**, tap  for the respective protection levels.



- › To display the menu for **Setting the protection level**, tap the  symbol.
- › Select one of the following options for sending vehicle and user data.
  -  Send only the legally required data.
  -  Send the vehicle and user data.
  -  Send the vehicle and user data as well as the data regarding the vehicle position.
  -  Division of vehicle position data on the website ŠKODA Connect Portal and in the ŠKODA Connect application .

### Switching the online service data connection on / off

For ŠKODA Connect online services, the prepaid data connection for online services can be used.

- › Tap **MENU** ›  › *Data connection* › *Integrated data connection (eSIM)*.

### Overview of online service data connection usage

- › To display, tap **MENU** ›  › *Data connection* › *Data plans*.

## Navigation

### Navigation announcements

Infotainment route guidance takes place using graphic driving recommendations and navigation announcements.

The navigation announcements are generated by the Infotainment system. Navigation announcement clarity (e.g. road or city name) cannot always be guaranteed.

### Repeat the last navigation announcement

- › Tap on  › .

### Turn off navigation announcements

- › Tap on  › .

### Navigation overviews

#### Display main menu

- › Tap on **MENU** › .

Map overview

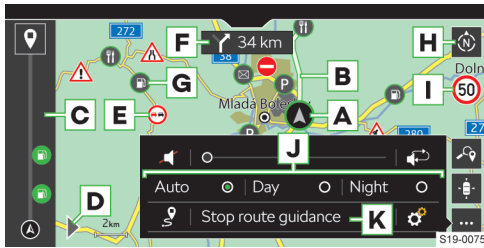

- A** Vehicle position
- B** Route
- C** Route view
- 📍 End route guidance
- D** Display the destination input and route view menu
- E** Traffic obstruction
- F** Following driving recommendation
- G** POI
- H** Change map orientation
  - ▶ North-facing 2D map
  - ▶ 2D map facing the direction of travel
  - ▶ 3D map facing the direction of travel
- I** Road sign for the affected route section
- 🔍 Find destination
- 📍 Centre the map on the vehicle position
- ⋮ **Displaying the settings menu**
  - 🔊 Turn off navigation announcements
  - 🔊 Repeat the last navigation announcement
- J** Display map in accordance with the following setting
  - ▶ *Auto* - Map in day / night mode depending on the vehicle lighting currently switched on
  - ▶ *Day* - Map in day mode
  - ▶ *Night* - Map in night mode
- 📏 Show the entire route
- K** End route guidance
- ⚙️ Settings

**Find destination**

- ▶ Tap on ▶ > 🔍.



- A** Input line
- B** List of destinations that have recently been searched for
- C** POI categories
  - ▶ **Tap:** search for the selected category
  - ✓ Show destination list
  - 📍 Enter destination via address / find destination

**Select the destination you are looking for**

- ▶ Enter the details for the destination search.
- ▶ Select the desired destination.

Destination details are displayed with the option of starting route guidance.

**Selecting the destination entered via the address**

- ▶ Tap on 📍.

A menu for entering the destination via the address is displayed.

- ▶ Enter the required information.

Destination details are displayed with the option of starting route guidance.

**List of stored destinations**

- ▶ Tap on ▶ > 📍.



- A** List of stored destinations
- B** Select category of stored destinations
  - ▶ 📍 - Favourites
  - ▶ 📍 - Last destinations
  - ▶ 📞 - Telephone contact destinations

**Selecting the stored destination**

- ▶ Select the category of stored destinations.
- ▶ Select the desired destination.

Destination details are displayed with the option of starting route guidance.

**Recommended destinations**

› Tap on › › h.

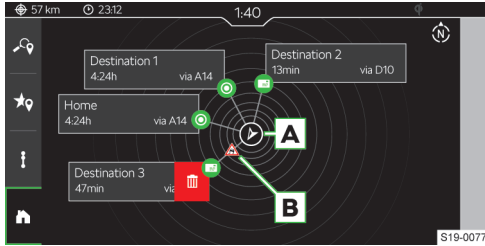

- A** North-facing vehicle position
- B** Traffic obstruction

☒ Delete the recommended destination

The view can display up to 5 recommended destinations in the following categories.

- ▶ Home address destination.
- ▶ Business address destination.
- ▶ Favourites.
- ▶ Last destinations.

Destination alignment depends on the direction in relation to the current vehicle position. The functional surface with the destination displays information about the estimated travel time to the destination.

If the vehicle has active online services and there is a traffic obstruction on the route to the destination, the traffic obstruction icon will be displayed.

**Delete the recommended destination**

- › Touch the functional surface for the recommended destination and swipe left.
- › Tap on ☒.

**Selecting destination by tapping the map point**

- › Tap the desired item or the POI icon in the map.



- A** Show destination details with the following possible settings
  - ▶ ☆ - Save destination as a favourite
  - ▶ ★ - Delete favourites

- ▶ ⓘ - Set destination as a starting point for route guidance in demo mode

- B** Start direct route guidance
- C** Route calculation

**Route calculation**

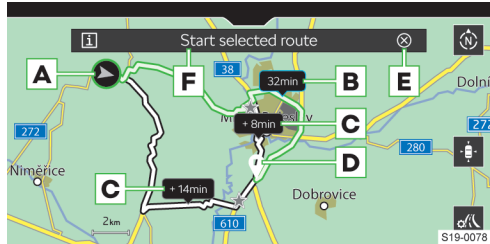

- A** Current vehicle position
- B** Proposed fastest route
- C** Alternative routes
- D** Target position
- E** 15 s time countdown before automatic start of the route guidance
  - › Tap: Interrupt time countdown
- F** Start route guidance

☒ Show information on the selected route

⚙ Set parameters for route calculation

**Route overview**

› Tap on › › i.

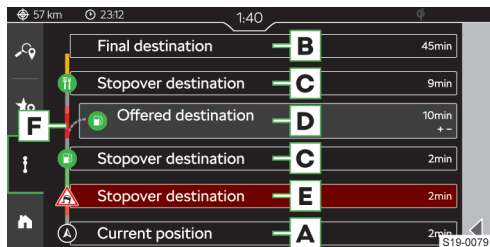

- A** Information on current vehicle position
- B** Final route destination
  - Tap: the following menu items can be selected.
  - › Show on map
  - › Stop route guidance
- C** Destination provided by Infotainment on the route
  - Tap: the following menu items can be selected.
  - › Show on map
  - › Add stopover destination
- D** Route stopover

**Tap:** the following menu items can be selected.

- › Show on map
- › Delete

**E** Traffic obstruction on the route

**Tap:** the following menu items can be selected.

- › Show on map
- › Avoid

**F** Route view

**Changing route destinations**

In the route overview, it is possible to exchange the destination and the intermediate destinations with each other and thus change their order.

- › Hold the line with the desired destination until the functional surface for the destination becomes free.
- › Move the destination to the desired position and release the functional surface.

The route is re-calculated.

**Traffic density**

When ŠKODA online services are activated, traffic density information can be displayed in the form of the following colour scale in the route view **F**.

**Low density** — — — — **High density**

— Traffic density information is not available

**Touch operation**

**Move map**

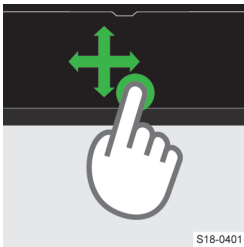

**Enter destination by tapping the map item**

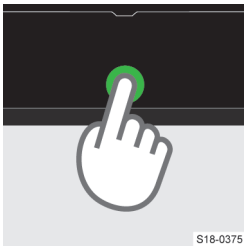

**Switch 2D/3D map display**

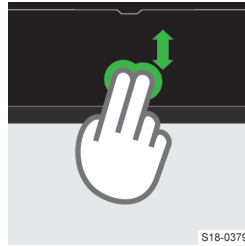

**Zoom into the map**

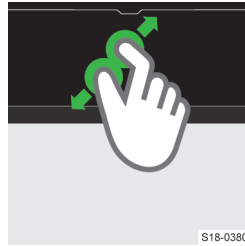

**Zoom out of the map**



**Rotate the map**



**Restriction**

Infotainment may give incorrect driving recommendations if the road conditions or the traffic do not match the navigation data. This can lead to the route guidance being carried out using a different route or proposing a change of direction in a one-way street.

Information for updating the navigation data must be requested from a ŠKODA partner.

## Settings

### Avoiding traffic obstructions

If the function is switched on and the Infotainment receives information about a traffic obstruction on the route from online traffic information, the route is recalculated.

Infotainment may suggest a detour to avoid traffic obstructions, depending on the following attitude.

- › Tap ... ›  › Route guidance › Avoid traffic congestion.
- › Select the desired menu item.

### Showing information on the destination / waypoint

The status line displays information on the distance and travel time to the destination, depending on the following setting.

- › Tap ... ›  › Route guidance › Show information for..
- › Select the desired menu item for the destination type.

### Showing arrival time information in the destination / driving time

The status line displays information on the travel time depending on the following setting.

- › Tap ... ›  › Route guidance › Time display..
- › Select the desired menu item.

### Switching display of country-specific speed limits on / off

When the function is switched on, the country-specific speed limits are displayed when crossing national borders.

- › Tap ... ›  › Route guidance › Country information at border crossings.

### Switching the display of road signs on motorways and expressways on / off

When the function is switched on, Infotainment displays traffic and information signs on motorways and expressways.

- › Tap ... ›  › Route guidance › Information signs on motorways and dual carriageways.

### Switching the fuel warning on / off

When the function is switched on and the fuel supply reaches the reserve area, a warning message appears with the option of going to the nearest petrol station.

- › Tap ... ›  › Route guidance › Fuel warning.

### Switching the speed limit warning on / off

- › Tap ... ›  › Route guidance › Road signs.

- › Set the note type and the value for exceeding the permissible speed.

### Toggle suggestions for frequently visited points of interest

In order to search for or display destinations in recommended destinations, the suggestion of POIs can

be switched on/off based on the frequency of destination guidance to these destinations.

- › In the **Navigation** main menu, tap ... ›  › Basic functions › Learn usage pattern.

### Delete information for suggesting frequently visited points of interest

- › In the **Navigation** main menu, tap ... ›  › Basic functions › Delete usage pattern.
- › Confirm the deletion.

### Towing a trailer

To calculate the correct route for trailer operation, switch on trailer inclusion.

- › Tap ... ›  › Route guidance › Trailer › Include trailer.

Set the maximum speed for trailer operation to correctly calculate the route time.

- › Tap ... ›  › Route guidance › Trailer › Maximum speed for trailers.
- › Set the maximum speed for the trailer.

### Setting navigation announcements

- › Tap ... ›  › navigation announcements.
- › Select and set the desired menu item.

### Favourite POI categories

Favourite POI categories are displayed on the map and provided in the destination search.

- › Tap ... ›  › Basic functions › Define preferred POI categories.
- › Set favourite categories.

### Setting home address

The defined destination of the home address is displayed in the overview of recommended destinations.

- › Tap ... ›  › Basic functions › Enter home address.

### Setting business address

The defined destination of the business address is displayed in the overview of recommended destinations.

- › Tap ... ›  › Basic functions › Enter business address.

### Switching demo mode on / off

In demo mode, the route guidance from the starting point of the demo mode to the selected destination is simulated.

When the function is switched on, Infotainment issues a query before the start of route guidance as to where whether the route guidance should be carried out in the normal way or in demo mode.

- › Tap ... ›  › Basic functions › Demo mode.

### Defining the starting point of the demo mode

- › Select or locate the desired destination to be the starting point of demo mode.
- › In the displayed destination details, tap *More* › .



## Updating the navigation database

Information on updating the navigation database must be requested from a ŠKODA partner, or refer to the following ŠKODA websites.

► <http://go.skoda.eu/updateportal>

### Automatic update

Infotainment automatically offers an update option if the following conditions are met.

- ✓ The “Infotainment Online” online services are activated.
- ✓ An update of the navigation database for the current vehicle position or route destination is available.

### Determining the navigation database version

► Tap **MENU** ›  › System information.

## Starting and driving

### Starting with the key

#### Notes on starting

##### ⚠ DANGER

Danger of poisoning by exhaust gases!

► Do not run the engine in an enclosed space.

#### Positions of the key in the ignition lock

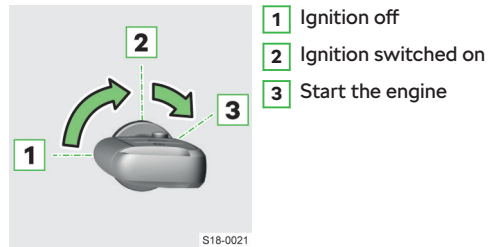



#### Starting the vehicle with manual transmission

- Secure the vehicle with the parking brake.
- Move the shift lever to the neutral position.
- Keep the clutch pedal depressed.
- Turn the key to position **3**.
- Release the key.

#### Starting the vehicle with automatic transmission

- Secure the vehicle with the parking brake.
- Keep the brake pedal depressed.
- Move the selector lever to position **P** or **N**.
- Turn the key to position **3**.
- Release the key.

**i** After switching on the ignition on vehicles with diesel engines, the indicator light  - Preheating system illuminates. The engine starts after  goes out.

##### ⚠ CAUTION

Danger of unexpected vehicle movement!

► At temperatures below  $-10^{\circ}\text{C}$ , start the vehicle with the selector lever in the **P** position.

#### Stopping the engine

- Secure the vehicle with the parking brake.
- Turn the key to position **1**.

On vehicles with automatic transmission, the key can only be removed when the selector lever is in the **P** position.

##### ⚠ WARNING

Steering lock hazard!

During a journey with the engine stopped, the ignition must always be switched on.

① **NOTICE**

Risk of engine overheating!

- ▶ Do not switch the engine off immediately at the end of your journey after the engine has been running at high loads. Leave it to run at an idling speed for about 1 minute.

## Start at the push of a button

### Notes on starting

⚠ **DANGER**

Danger of poisoning by exhaust gases!

- ▶ Do not run the engine in an enclosed space.

### Operating conditions

- ✓ The vehicle key is located in the vehicle interior.

① **NOTICE**

Risk of key loss, possibly of key damage!

The system can detect the key even if it has been forgotten on the vehicle roof.

- ▶ Always keep the key with you.

### Switching the ignition on and off





- ▶ Press the starter button.

### Starting the vehicle with manual transmission

- ▶ Secure the vehicle with the parking brake.
- ▶ Move the shift lever to the neutral position.
- ▶ Keep the clutch pedal depressed.
- ▶ Press the starter button.

### Starting the vehicle with automatic transmission

- ▶ Secure the vehicle with the parking brake.
- ▶ Keep the brake pedal depressed.
- ▶ Move the selector lever to position **P** or **N**.
- ▶ Press the starter button.

ⓘ After switching on the ignition on vehicles with diesel engines, the indicator light  - Preheating system illuminates. The engine starts after  goes out.

⚠ **CAUTION**

Danger of unexpected vehicle movement!

- ▶ At temperatures below -10°C, start the vehicle with the selector lever in the **P** position.

### Stopping the engine

- ▶ Secure the vehicle with the parking brake.
- ▶ Press the starter button.

⚠ **WARNING**

Steering lock hazard!

During a journey with the engine stopped, the ignition must always be switched on.

① **NOTICE**

Risk of engine overheating!

- ▶ Do not switch the engine off immediately at the end of your journey after the engine has been running at high loads. Leave it to run at an idling speed for about 1 minute.

## Starting issues

### Troubleshooting

① **NOTICE**

Danger of engine and catalyst damage!

- ▶ Do not start the vehicle by towing.

### The engine does not start

- ▶ Switch off the ignition.
- ▶ Wait 30 seconds and repeat the starting procedure.
- ▶ If the engine does not start, use the jump start cables with the battery of another vehicle » page 140 or seek the help of a specialist garage.

### The engine does not start, the display shows a message regarding the immobilizer

- ▶ Use the other vehicle key.
- ▶ If the engine does not start, seek the help of a specialist garage.

### The key cannot be turned in the ignition

- ▶ Move the steering wheel back and forth while turning the key.

### Starting is not possible with the starter button, the system did not detect the key

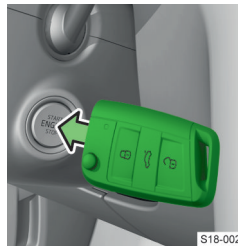

- ▶ Press the starter button with the key.
- ▶ If the engine does not start, seek the help of a specialist garage.

ⓘ The key might not be detected if the battery in the key is nearly discharged or the signal is faulty.

### The engine cannot be turned off with the starter button

- ▶ Hold the starter button or press twice.

### The radiator fan keeps running even after the engine has stopped

The radiator fan can continue to run for approximately 10 minutes after the engine is stopped. This is not a defect.

**The engine makes noises after the cold start**

The increased running noise is due to the briefly increased engine speed. This is not a defect.

**START STOP****Usage**

The START STOP system reduces environmentally damaging emissions, including CO<sub>2</sub>, and saves fuel.

If the system determine that the engine is not needed when the vehicle stops, it turns off the engine and starts it again when moving off.

**Functionality****Vehicle with manual transmission**

A system-related engine switch-off occurs when stopping, when switching the gear lever into the neutral position, and when releasing the clutch pedal.

A system-related engine start occurs when the clutch pedal is pressed down.

**Vehicle with automatic transmission**

A system-related engine switch-off occurs when the brake pedal is actuated and the engine is stopped.

A system-related engine start takes place after releasing the brake pedal.

**Status display in the instrument cluster display**

 Engine is switched off via the START-STOP system

 Engine is not switched off via the START-STOP system due to operating conditions that are not met

**Display of detailed information in the infotainment screen**

CAR >  > Vehicle status

Or:

MENU >  >  > Vehicle status

**Operating conditions**

Some conditions are systemic and can neither be influenced nor recognised. Therefore, the system may react differently in situations which seem identical from the driver's perspective.

The driver must fulfil the following conditions.

- ✓ The driver's door is closed.
- ✓ The driver has fastened the seat belt.
- ✓ The driving speed was higher than 4 km.h after the last stop.

**Settings****Automatic activation**

- ▶ Upon start-up of the engine.
- ▶ By selecting driving mode Eco » page 115, *Operation*.

**Deactivate/activate system**

- ▶ Press the  button.

When the system is deactivated, the symbol  illuminates in the button.

If a system-related engine switch-off occurs and the system is deactivated, the engine will start.

**Troubleshooting****The engine does not switch off when stopping, or it starts before starting up**

The system has detected that the engine is running.

**Manual gearbox****Operation****ⓘ NOTICE**

Danger of engine damage!

- ▶ Shift to a higher gear before reaching the red area on the tachometer scale.

**ⓘ NOTICE**

Danger of gearbox damage!

- ▶ Fully depress the clutch pedal when changing gear.
- ▶ When not shifting gear, do not put your hand on the shift lever.

**Engaging reverse gear**

- ▶ Stop the vehicle.
- ▶ Fully depress the clutch.
- ▶ Move the shift lever to the neutral position.
- ▶ Push the shift lever down.
- ▶ Turn it completely to the left.
- ▶ Wait briefly.
- ▶ Engage reverse gear.

## Automatic gearbox

### Lever positions

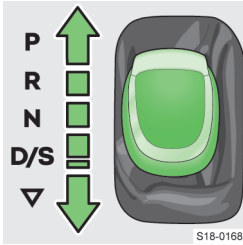

- P Parked vehicle**  
The drive wheels are locked.  
**P Only** set the position when the vehicle is stationary.
- R Reverse gear**  
**R Only** set the position when the vehicle is stationary.

#### N Neutral

There is no transmission of engine power to the wheels.

#### D/S Forward drive / sports program

The gear is changed automatically.

#### ▽ Choose between D and S (spring-loaded position)

In **S** mode, the gear is changed at higher speeds than in **D** mode.

#### Moving the selector lever out of the P or N position



lights up - the selector lever is locked



- › Press the brake pedal, and at the same time, press the button in the selector lever.

#### ⚠ WARNING

Risk of the stationary vehicle rolling away automatically!

- ▶ When the selector lever is in the **D/S** position, **R** position or in manual shift mode, secure the vehicle with the brake.

### Operation

#### Starting up

- › Keep the brake pedal depressed.
- › Start the engine.
- › Press the button in the selector lever and set it to the desired position.
- › Release the brake pedal and accelerate.

#### Speeding up while driving (kick-down)

- › Fully depress the accelerator.

#### Stopping temporarily (e.g. at a junction)

- › Leave the selector lever in the **D/S** position and secure the vehicle with the brake pedal.

#### Stopping

- › Keep the brake pedal depressed.
- › Secure the vehicle with the parking brake.
- › Press the button in the selector lever and set it to the **P** position.
- › Turn off the engine.

#### Driving in neutral

If the system detects that no gear is engaged while driving, it automatically switches to neutral position.

Ⓢ in the instrument cluster lights up.

#### Requirements for driving in neutral position

- ✓ Neither the accelerator nor the brake pedal is pressed.
- ✓ Driving speed between 20-130 km/h.
- ✓ There is no device connected to the trailer socket.

#### Manually switching gear with the selector lever

- › To **turn on**, put the selector lever in the **D/S** position to the right (to the left for right-hand drive vehicles).
- › To **turn off**, put the selector lever back in the **D/S** position.

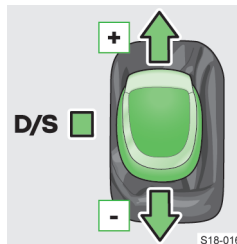

- + Changing up a gear
- Changing down a gear

#### Manually changing gear with the shift paddles on the steering wheel

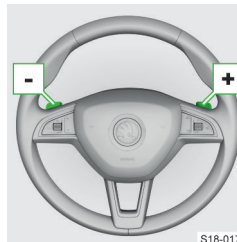

- Changing down a gear
- + Changing up a gear

- › To switch on the **rocker switch**, press **-** or **+**.
- › To **Turn off** the rocker switch, hold **+**.

If none of the shift paddles are pressed for a certain time, manual shift mode turns off automatically.

#### If the engine threatens to over-rev

- ▶ The gearbox automatically changes to the next higher gear.

- ▶ The transmission prevents changing to the next lower gear.

## Troubleshooting

### The selector lever cannot be moved out of position P in the normal way

- › Unlock the lever like in an emergency » page 115.

### Gearbox overheated



or illuminates

Message regarding the gearbox overheating

- › You may continue driving, exercising appropriate caution.



or illuminates

Message regarding the gearbox overheating

- › Stop driving! Stop the vehicle and stop the engine.
- › After the indicator light goes out, your journey can continue.
- › If the warning light does not go out, stop driving! Seek the help of a specialist garage.

### Gearbox impaired



or illuminates

Message regarding the gearbox in emergency mode

- › You may continue driving, exercising appropriate caution.
- › Immediately seek the help of a specialist garage.



or illuminates

Message regarding a gearbox fault

- › Stop driving! Seek the help of a specialist garage.

### Starting up a vehicle that is stuck

- › Adjust the selector lever between **D/S** and **R**. The vehicle will then start to rock and be easier to free.

## Selector lever emergency unlocking

- › Secure the vehicle with the parking brake.

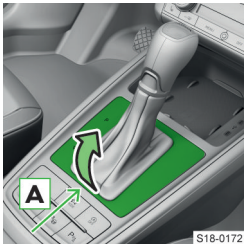

S18-0172

- › Insert a flat-head screwdriver or push a similar tool into the gap in the area of arrow **A**.
- › Carefully loosen and lift the quadrant cover.
- › Push the foam insert away until the yellow release lever is visible.



S18-0173

- › Press with the vehicle key on the release lever, and at the same time, press the key in the selector lever.
- › Put the selector lever in **N** position.

## Vehicle driving mode

### Usage

The driving mode offers the possibility of adapting the driving behaviour to the desired driving style.

### Overview

Information about the selected driving mode is displayed in the status bar in the Infotainment screen as well as in the digital instrument cluster.

#### Eco mode

Eco mode is suitable for a relaxed driving style and helps to save fuel.

#### Normal mode

Normal mode is suitable for a normal driving style.

#### Sports mode

Sport mode is suitable for a sporty driving style.

#### Individual mode

Individual mode allows the individual configuration of certain vehicle systems.

## Operation

### Select driving mode

- › Press the button.

In the Infotainment, a driving mode menu appears.

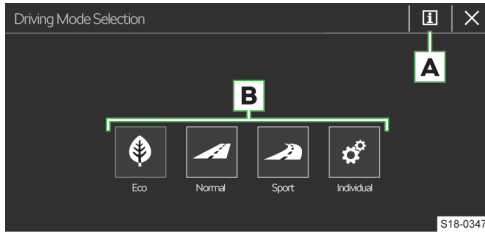

**A** Information on the system settings of the currently selected mode/system settings for the selected Individual mode

**B** Driving mode menu

› Tap the relevant function surface **B**.

Or:

› Press the button again.

### Troubleshooting

#### Sport Chassis Preset shock absorber faulty

or illuminates

› Drive on, exercising appropriate caution. Seek the help of a specialist garage.

## Economical driving style

### Tips for economical driving and evaluation of driving economy

#### Tips for economical driving

- › Avoid unnecessary acceleration and braking.
- › Observe the recommended gear » [page 50, Display overview and overview of the menu items in the main menu.](#)
- › Avoid full throttle and too high speeds.
- › Avoid engine idling during longer periods of stationary time.
- › Do not warm up the engine while the vehicle is stationary. If possible, start your journey as soon as the engine starts.
- › Observe the prescribed tyre pressure » [page 149, Sticker with prescribed tyre pressures.](#)
- › Remove unnecessary ballast.
- › Remove the roof rack when it is not needed.
- › Switch on electric consumers for as long as necessary.
- › Do not leave the windows open while driving.

#### Display of evaluation in the infotainment screen

**CAR** › › DriveGreen

Or:

**MENU** › › › Drive Green

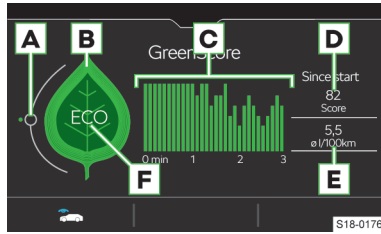

**A** A driving liquid display

With the driving is fluid, the display is located near the green dot.

**B** Leaf

The greener the leaf, the more economic the driving style. Tapping the screen near the leaf displays tips for reducing fuel consumption and energy consumption.

**C** Driving efficiency chart

Each bar indicates driving efficiency in 5 second increments. The current bar is on the left. The higher the green bars, the more economical the driving style.

**D** Point value (0-100)

The higher the indicated value, the more economical the driving style. Tapping the screen near the value **D** displays a rating for the last 30 minutes of driving.

**E** Average fuel consumption

Tapping the screen near the value **E** displays the average fuel consumption during the last 30 minutes of driving.

**F** Information about the current driving style

› **ECO** Economical driving style

› The speed has a negative effect on fuel consumption

› The ride is not smooth

› 4 Recommended gear

#### Consumption-friendly driving

In the following situations, a small reduction in fuel consumption occurs. in the instrument cluster lights up.

- › Active cylinder management has temporarily disabled some cylinders in the engine (applies to certain engine types).
- › A vehicle with automatic transmission, rolls in neutral position.

## Towing a trailer

### What you should be mindful of

#### ⚠ **WARNING**

When driving with a trailer, special care is required!

#### ① **NOTICE**

With frequent towing, the vehicle is excessively loaded so this must also be checked between service intervals.

#### **Recommendations for using a trailer**

- ▶ Adjust the tyre pressure on the vehicle for full load.
- ▶ Do not exceed the maximum permissible total weight of the vehicle and the combination weight specified in the technical vehicle documentation (e.g. in the vehicle registration documentation, in the COC document) and on the type plate.
- ▶ For trailer operation, consider the current load condition of the vehicle as well as the distribution of the load in the trailer. The coupled trailer increases the rear axle load and can therefore reduce the payload.
- ▶ Adjust the headlight range of the headlights according to the load status of the vehicle. The front

of the vehicle may lift up when a trailer is being towed and the headlights may dazzle other road users.

- ▶ A speed of **100 km/h** should not be exceeded.
- ▶ Reduce the speed by releasing the accelerator pedal as soon as a pendulum movement of the trailer is noticeable. Never attempt to stop the trailer from swaying by accelerating.
- ▶ If the traffic area behind the trailer can not be viewed, install additional exterior mirrors.
- ▶ Apply the brakes in good time. If the trailer is fitted with a trailer brake, apply the brakes gently at first, then brake firmly. This will avoid brake jolts resulting from the trailer wheels locking.
- ▶ Select a lower gear before descending to also use the braking force of the engine.

#### **Distribution of the load over the vehicle and trailer combination**

- ▶ Secure heavy objects against slipping, as close to the trailer axle as possible.
- ▶ Transport small and light objects in the luggage compartment.

### Permitted trailer loads

The details in the technical vehicle documentation take precedence over the information in this Owner's Manual.

#### ⚠ **WARNING**

Risk of an accident!

Do not exceed the permissible trailer load.

Engine type	Transmission	Permissible trailer load, braked (kg) <sup>a)</sup>	Permissible trailer load, unbraked (kg)
1.0 l/70 kW TSI	Manual gearbox	- <sup>b)</sup>	- <sup>b)</sup>
1.0 l/85 kW TSI	Manual gearbox	1200	610
	DSG <sup>c)</sup>	- <sup>b)</sup>	- <sup>b)</sup>
1.5 l/110 kW TSI	Manual gearbox	- <sup>b)</sup>	- <sup>b)</sup>
	DSG <sup>c)</sup>	- <sup>b)</sup>	- <sup>b)</sup>
1.6 l/85 kW TDI CR	Manual gearbox	1250	660
	DSG <sup>c)</sup>	1250	680

<sup>a)</sup> With gradients up to 12%.  
<sup>b)</sup> The values were not available at the time of going to press.  
<sup>c)</sup> Automatic dual-clutch transmission.

## Towing eye and towing procedure

### Towing eye

#### Removing the front cap



- › Press on the cap and remove it.

#### Removing the rear cap



- › Press on the cap and remove it.

#### Installing the towing eye

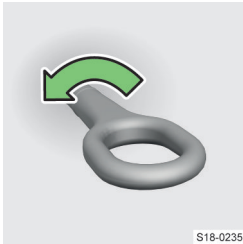

- › Screw in the towing eye.
- › Insert the wheel wrench or similar object through the towing eye.
- › Tighten the towing eye.

#### After the towing process

- › Unscrew the towing eye.
- › Insert the cover cap.

### Towing the vehicle

#### ⚠ WARNING

Risk of an accident!

- › The tow rope must not be twisted.
- › When towing, drive at a speed of max. 50 km/h.

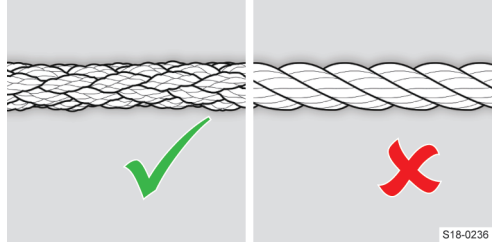

#### ⚠ WARNING

Risk of an accident!

- › Use a braided synthetic fibre rope for towing. Do not use a twisted tow rope.

#### ① NOTICE

- › Always keep the tow rope taut during the towing procedure.
- › Do not exceed a towing distance of 50 km.

#### ① NOTICE

Danger of gearbox damage!

- › If the gearbox no longer contains any oil, the vehicle must only be towed with the front axle raised clear of the ground or transported on a special breakdown vehicle.
- › Vehicles with automatic transmission must not be towed with the rear axle raised.

#### Where should the tow rope or the tow bar be secured?

- › At the front towing eye.
- › At the rear towing eye.
- › On the ball bar of the factory-installed towing hitch.

#### Information for the driver of the towing vehicle

- › Drive slowly and smoothly.
- › Only accelerate when the rope is taut.

#### Information for the driver of the towed vehicle

#### ⚠ WARNING

Risk of an accident!

When the ignition is switched off, the brake booster and the power steering do not work. In addition, there is a risk that the steering lock will engage.

- › If it is not possible to start the engine, switch on the ignition!
- › Move the shift lever to the neutral position or the selector lever to the N position.

## Brakes

### What you should be mindful of

#### ⚠ WARNING

Problems and faults with the brake system can extend the braking distance of the vehicle!



**⚠ DANGER**

Danger of a functional restriction of the brake booster!

- ▶ When braking in a vehicle with manual transmission, when the vehicle is in gear and at low revs, depress the clutch pedal.

**⚠ DANGER**

Danger of the brakes overheating!

- ▶ Do not depress the brake pedal unless braking is required.
- ▶ If the standard front spoiler is damaged, ensure the air supply to the front brakes is guaranteed.

**Checking the brake fluid level****Test conditions**

- ✓ Park the vehicle on a horizontal surface.
- ✓ Engine turned off.

**Checking**

The fill level must be within the marked range.

- › If the level is below the mark **MIN**, do not continue.
- › Do not refill liquid.
- › Seek the help of a specialist garage.

If the brake fluid level is too low, this will be indicated in the instrument cluster by the illumination of **(!)**. Nevertheless, we recommend checking the brake fluid level regularly directly at the reservoir.

**Specification**

The brake fluid must comply with the standard VW 501 14 (this standard meets the requirements of the standard FMVSS 116 DOT4).

Have the brake fluid **replaced** by a specialist garage.

**⚠ WARNING**

Danger of brake failure!

- ▶ If the brake fluid change date is exceeded, heavy braking may cause vapour bubbles to form in the brake system.
- ▶ If the fluid level falls significantly within a short time or drops below the mark **MIN**, the brake system may have become leaky.

Stop driving! Seek the help of a specialist garage.

**Troubleshooting****Brake fluid level is too low**

**(!)** illuminates

- › Do not drive the vehicle! Seek the help of a specialist garage.

**Brake system and anti-lock braking system faulty**

**(!)** illuminates together with **(ABS)**

- › Do not drive the vehicle! Seek the help of a specialist garage.

**Reduced braking effect**

Damp, frozen, salt-affected or corroded brakes can impair the braking effect.

- › Clean the brakes by braking several times if traffic conditions allow it.

**When the engine is stopped, the brake booster does not work**

- › Depress the brake pedal more forcefully.

**Handbrake****Operation****⚠ WARNING**

Risk of an accident!

An insufficiently released parking brake will impair the function of the brake system.

- ▶ Fully release the parking brake before driving.

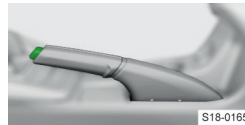
**Applying**

- › Pull the lever up to the stop position.  
The display **(P)** lights up.

**Releasing**

- › Pull the lever up a little and push in the lock button.
- › Press and hold the lock button and pull the lever completely down.

## Driver assist systems

### Braking and stabilising systems

#### Overview

##### Electronic Stability Control (ESC)

ESC helps to stabilize the vehicle in borderline situations (e.g. when the vehicle starts to skid). ESC brakes the individual wheels to maintain the direction of travel.



flashing - ESC is engaged

##### Anti-Slip Regulation (ASR)

ASR helps to stabilize the vehicle when accelerating or driving on low-grip roads. ASR reduces the drive power transmitted to the wheels when the wheels spin.



flashing - ASR is engaged

##### Anti-lock Braking System (ABS)

ABS helps maintain control of the vehicle during emergency braking. An ABS intervention is noticeable by pulsating movements of the brake pedal.

##### Motor Slip Regulation (MSR)

MSR helps to keep control of the vehicle when downshifting or abruptly decelerating, e.g. on an icy road surface. If the drive wheels lock, MSR increases the engine speed. As a result, the braking effect of the engine is reduced and the wheels can turn freely again.

##### Electronic Differential Lock (EDL)

EDL helps to stabilize the vehicle when driving on road surfaces with different grip under the individual wheels. EDL brakes a spinning wheel and transmits power to a different drive wheel.

##### Electronic Differential Lock (XDL+)

XDL+ helps to stabilize the vehicle during fast cornering by braking the inside wheel of the driven axle.

##### Active steering assistance (DSR)

In difficult situations, the DSR provides the driver with a steering recommendation in order to stabilise the vehicle.

##### Hill Hold Control

Hill Hold Control helps when starting off on uphill gradients by braking the vehicle for about 2 seconds after the brake pedal is released.

##### Operating conditions

- ✓ The gradient is at least 5%.
- ✓ The driver's door is closed.

##### Multi-Collision Brake (MCB)

MCB helps to decelerate and stabilize the vehicle after a collision with an obstacle. This reduces the risk of further collisions.

##### Operating conditions

- ✓ There has been a frontal, side and rear collision of a certain severity.
- ✓ The impact speed was greater than 10 km/h.
- ✓ The brakes, ESC and other required systems remained functional after the impact.
- ✓ The accelerator pedal is not pressed.

##### Trailer Stability Assist (TSA)

TSA helps to stabilize the trailer. As the trailer begins to lurch, TSA stabilizes the trailer by slowing down the individual vehicle wheels.

##### Operating conditions

- ✓ The hitch was supplied from the factory or purchased from ŠKODA Genuine Accessories.
- ✓ The trailer is connected to the trailer socket.
- ✓ ASR activated.
- ✓ The driving speed is higher than 60 km/h.

#### Settings

##### Deactivating/activating ASR

The function is deactivated or activated in the following Infotainment menu.

CAR >  > 

Or:

MENU >  >  > 

When deactivating  lights up in the instrument cluster.

 goes out on renewed activation.

Deactivating the ASR may be helpful in the following situations.

- ▶ Driving with snow chains.
- ▶ Driving in deep snow or on very loose ground.
- ▶ Starting up a vehicle that is stuck.

#### Troubleshooting

##### ESC or ASR faulty/deactivated by the system

 illuminates

- › Stop the engine and start again.
- › If the indicator light does not go out after covering a short distance, seek the help of a specialist garage.

##### ABS faulty

 illuminates

- › You may continue driving, exercising appropriate caution. Seek the help of a specialist garage.

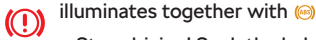
**Brake system and anti-lock braking system faulty**

illuminates together with

- › Stop driving! Seek the help of a specialist garage.

**Front Assist****Functionality**

Front Assist monitors the distance to the vehicle ahead and points out when the safety distance is exceeded. In borderline situations, it helps to avoid a collision by braking interventions.

**Status display in the instrument cluster display**

- Safety distance too small



or - Warning in case of collision

**Automatic braking if there is a risk of a collision**

If there is a risk of a collision, the following symbol or is displayed as a warning. If you do not respond to the warning, the vehicle will slow down.

At a driving speed of up to 30 km/h, the vehicle is braked without prior warning.

Automatic braking can be stopped by pressing the accelerator pedal or by a steering intervention.

With automatic braking, the pressure in the brake system increases. The brake pedal can not be operated by using the pedal as normal.

**⚠ WARNING**

Risk of an accident!

Front Assist does not respond to crossing or oncoming vehicles.

**Operating conditions**

- ✓ ASR activated.
- ✓ The driving speed is higher than 5 km/h.

**Function restriction**

The function may be restricted or unavailable in the following cases.

- ▶ About 30 seconds after starting. is lit up in the instrument cluster.
- ▶ When driving around a sharp bend.
- ▶ During an ESC intervention.

**Settings****Automatic activation**

Front Assist is automatically activated when the ignition is switched on.

**Activation/deactivation in the instrument cluster**

In the display in the *Assist systems* menu item

**Activation / deactivation and setting in Infotainment**

In the menu: MENU > >

**Show system deactivation in the display of the instrument cluster**

or - Front Assist is deactivated

Deactivate Front Assist when handling the vehicle on a truck, a car ferry etc.

**Troubleshooting****Front Assist is not available**

- › Clean the front radar sensor.
- › Stop the engine and start again.
- › If Front Assist is still unavailable, check the brake lights on the vehicle or on the attached trailer.
- › Replace the defective bulb.
- › If the brake lights are working and Front Assist is still unavailable, seek the help of a specialist garage.

**There was an unfounded warning or system intervention**

- › Clean the front radar sensor.
- › If the system is not working properly, disable Front Assist and seek the help of a specialist garage.

**Pedestrian detection system****Functionality**

Pedestrian recognition helps to prevent a collision with crossing pedestrians by enabling automatic braking interventions.

**Status display in the instrument cluster display**

or - Risk of collision

**Risk of collision in a speed range of 5-30 km/h**

The system triggers automatic braking.

**Risk of collision in a speed range of 30-60 km/h**

The system warns of a collision hazard first. If the driver does not respond, the vehicle is automatically braked.

### Operating conditions

- ✓ Front Assist activated.
- ✓ Driving speed between 5-60 km/h.

### Speed limiter

#### Functionality



The speed limiter controls the maximum driving speed according to the set speed limit.

If the limit is exceeded when driving downhill, brake the vehicle with the brake pedal.

#### Status display in the instrument cluster display

 - Speed limiter is activated

When the control starts,  is highlighted and the set limit is displayed.

-  illuminated - Control is active
-  flashing - the set limit is exceeded

### Operating conditions

- ✓ The driving speed is higher than 30 km/h.

### Operation

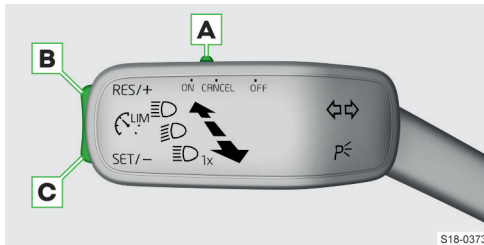

#### Variant without GRA

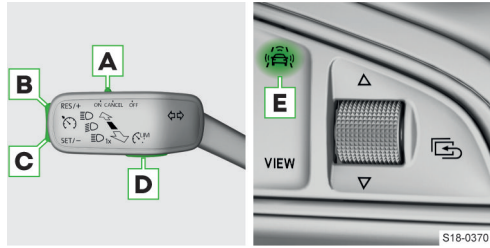

- A** ON Activate limiter (control inactive)  
OFF Deactivate limiter  
CANCEL Interrupt control (sprung position)
- B** RES/+ Resume control<sup>1)</sup>/Increase limit
- C** SET/- Start control with current speed/Reduce limit

#### Variant with GRA



- A** ON Activate GRA (condition for the subsequent activation of the limiter).  
To activate the speed limiter, press button **D** or **E**.  
OFF Deactivate limiter  
CANCEL Interrupt control (sprung position)
- B** RES/+ Resume control<sup>1)</sup>/Increase limit
- C** SET/- Start control with current speed/Reduce limit
- D** Depending on the equipment:  
 Switch between GRA and speed limiter  
Or:  
 Show menu of assist systems - Possibility of switching between GRA and speed limiter  
Switching to GRA interrupts the control.
- E** Show menu of assist systems - Possibility of switching between GRA and speed limiter  
Switching to GRA interrupts the control.

#### Adjusting the speed limit with the buttons **B** and **C**

- C** By pressing in steps of 1 km/h.
- By holding in steps of 10 km/h.

<sup>1)</sup> If no speed limit is set, the current speed is set as the speed limit.

**Variant with ACC**

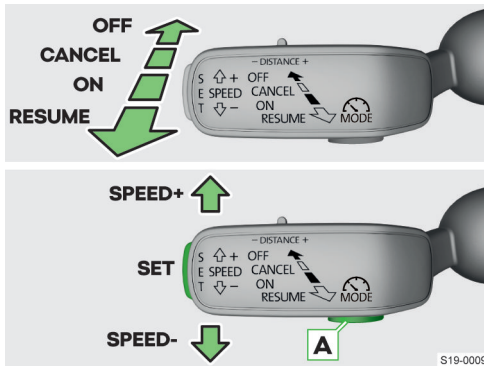

**ON** Activate ACC (condition for the subsequent activation of the limiter). To activate the limiter, press button **A**.

**RESUME** Resume control<sup>1)</sup>/Increase limit in steps of 1 km/h (sprung position)

**CANCEL** Interrupt control (sprung position)

**OFF** Deactivate the limiter

**SPEED+** Increase limit in steps of 10 km/h

**SPEED-** Decrease limit in steps of 10 km/h

**SET** Start control/Reduce limit in steps of 1 km/h

**A** Change between ACC and speed limiter (by switching to GRA, control is interrupted)

**Limit exceeded**

➤ Fully depress the accelerator.

Control will continue as soon as the vehicle has decelerated to below the set limit.

**Troubleshooting**

**Speed limiter faulty**

**LIM** illuminates

➤ Seek the help of a specialist garage.

**Cruise control system**

**Functionality**

The cruise control system maintains the set speed without the accelerator pedal having to be operated.

However, this is only done to the extent permitted by engine performance or engine braking.

**WARNING**

Risk of the cruise control system starting unintentionally!

► Deactivate cruise control after use.

**Status display in the instrument cluster display**

- the cruise control system is activated

- cruise control is active

When cruise control starts, the set speed is displayed.

**Operating conditions**

✓ The driving speed is higher than 20 km/h.

**Operation**

**Operating with the lever**

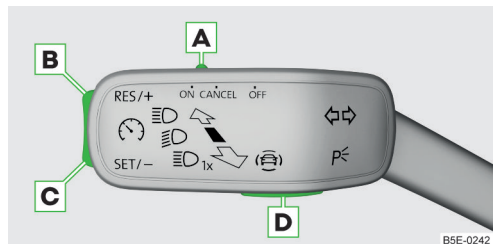

**A** **ON** Activate cruise control (cruise control deactivated)

**OFF** Deactivate cruise control

**CANCEL** Interrupt control (sprung position)

**B** **RES/+** Resume cruise control<sup>2)</sup>/Increase speed

**C** **SET/-** Start control with current speed/Reduce limit

**D** Show menu of assist systems - Possibility of switching between GRA and speed limiter

**Accelerate temporarily**

➤ Depress the accelerator pedal.

After you release the accelerator, the speed drops to the previously stored value.

**Interrupting cruise control**

► After pressing the brake pedal.

► After an ESC intervention.

<sup>1)</sup> If no speed limit is set, the current speed is set as the speed limit.

<sup>2)</sup> If no speed is set, the current speed is adopted.

## Troubleshooting

### Cruise control system faulty

- ! illuminates
  - › Seek the help of a specialist garage.

## Adaptive Cruise Control (ACC)

### Functionality

#### Control

ACC maintains the set speed. When your vehicle approaches the vehicle in front, ACC will automatically start to maintain the set distance to this vehicle.

Maintaining the set speed and the distance will hereinafter be referred to as **Control**.

#### ⚠ WARNING

ACC does not respond to stationary objects or to crossing or oncoming objects.

- ☐ ACC is intended primarily for use on motorways.

#### Speed range

Depending on the equipment, ACC allows a speed setting in the range of 30-160 or 30-210 km/h.

If control is started at a speed of less than 30 km/h on vehicles with an automatic transmission, the speed is automatically increased to 30 km/h or controlled according to the speed of the vehicle ahead.

#### Distance level

The distance from the vehicle ahead can be adjusted in the range from 1 to 3.6 s in five different levels.

#### Automatic stop and start

A vehicle with an automatic transmission can be decelerated to a stop using the ACC and start moving again. In the event of a long stop, a message will appear in the display, indicating that you must operate the brake pedal.

- › Keep the brake pedal depressed until the vehicle in front starts moving.

If the brake pedal is not depressed, control is interrupted.

#### Overtaking

If your vehicle changes to the fast lane and no vehicle is detected in front, ACC accelerates up to the set speed.

#### Status display in the instrument cluster display

- ! - ACC is activated

Depending on the equipment:

- ! or ! along with ! - Control is active
- When the control starts, the set speed is displayed.

- ! - ACC does not decelerate sufficiently
  - › Depress the brake pedal.

## Operation

### Operating with the lever

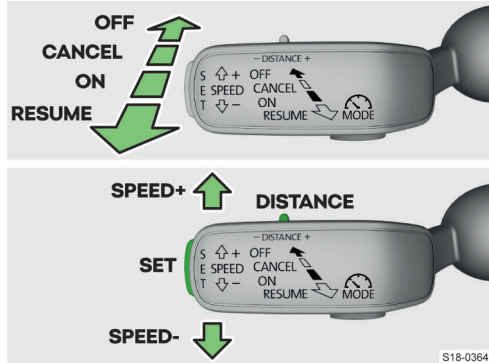

- ON** Activate ACC (control inactive)
- RESUME** Start or resume control/Increase speed in steps of 1 km/h (sprung position)
- CANCEL** Interrupt control (sprung position)
- OFF** Deactivate ACC
- SPEED+** Increase speed in steps of 10 km/h
- SPEED-** Reduce speed in steps of 10 km/h
- DISTANCE** Set distance level
- SET** Start control/Reduce speed in steps of 1 km/h

### Starting control with the current speed

- › Tap on **SET**.

Or:

- › If no speed is saved, move the lever to the sprung position **RESUME**.

### Set distance level

- › Move the **DISTANCE** switch to the sprung position - or +.

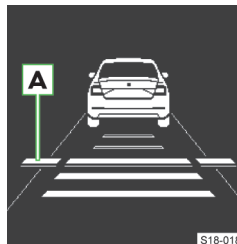

Line **A** appears in the display, indicating the change in distance.

- › Use the **DISTANCE** switch to set the desired distance level.

### For temporary acceleration

- › Depress the accelerator pedal.

The vehicle accelerates and control is temporarily interrupted. Upon releasing the accelerator, control is resumed.

**Interrupting cruise control**

- ▶ After pressing the brake pedal while driving.
- ▶ By operating the clutch pedal for a long time.
- ▶ After an ESC intervention.
- ▶ After deactivation of the ASR.

**Resuming control**

- If a speed is stored, move the lever to the sprung position **RESUME**.

The vehicle is controlled at the set speed. The set speed is shown in the instrument cluster display.

**Function restriction**

**⚠ WARNING**

- ▶ Be particularly attentive and alert in the following situations.

**Regulation according to the vehicle in the adjacent lane**

If your vehicle is moving faster than the vehicle in the next lane on the driver's side, at a speed of more than 80 km/h, this may cause your vehicle to be controlled according to that vehicle.

**When cornering**

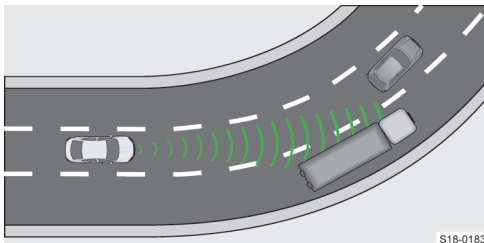

When cornering, a vehicle in the next lane may enter the detected area. Your vehicle will be controlled according to this vehicle.

**Narrow or staggered vehicle**

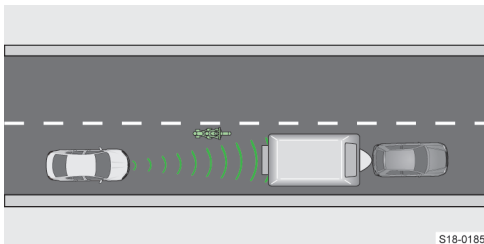

ACC detects a narrow or staggered vehicle only when it is in the area covered by the radar.

**Lane change by another vehicle**

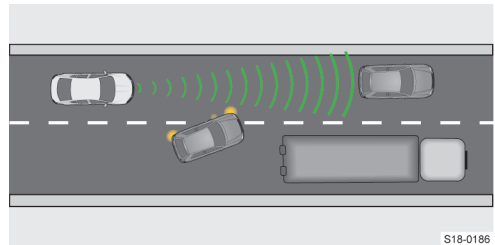

A vehicle that changes to the lane a short distance away may not be recognized by the ACC in time.

**Stationary vehicle**

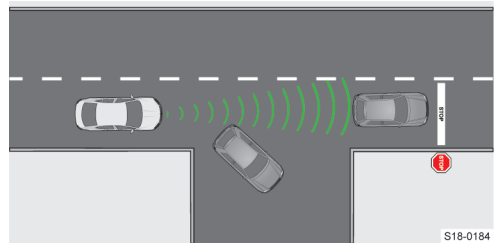

If a vehicle in front turns and there is a stationary vehicle in front of this vehicle, the ACC will not respond to the stationary vehicle.

**Vehicles with special load or special bodies**

A load or superstructure that protrudes outside the vehicle might not be detected by the ACC.

**Settings**

In the infotainment system, in menu: **MENU > ⚙️ > ⚙️**

■ ACC (Automatic cruise control)

- ▶ **Driving programme:** - Setting the vehicle acceleration when the ACC is switched on (this setting is made for vehicles with driving mode selection » page 115)
- ▶ **Last selected distance** - Switch the last selected distance level on/off
- ▶ **Distance:** - Setting the distance to vehicles in front

**Troubleshooting**

**ACC not available**

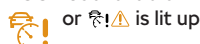

- Stop the engine and start again.

- If ACC is still unavailable, check the brake lights on the vehicle or on the attached trailer.
- Replace the defective bulb.
- If the brake lights are working and ACC is still unavailable, seek the help of a specialist garage.

## Lane Assist

### Usage

Lane Assist helps to keep the vehicle within the lane. It is based on the boundaries of a lane. These may include lane markings, road edges or objects such as curbs or possibly traffic cones.

The system is intended primarily for use on highways.

### Functionality

As the vehicle approaches a lane marking, the system executes a steering movement in the opposite direction from the lane marking. The steering intervention can be overridden manually.

No system intervention occurs when changing lane with the turn signal on.

#### Status display in the instrument cluster display



lights up - System is activated and ready to intervene



lights up - System is activated and ready to intervene



lights up - System intervenes



lights up - System intervenes

### Display

Display example in monochromatic display.

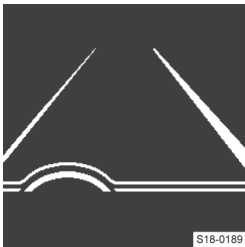

Lane boundary highlighted on the right: system intervenes on the right when approaching the lane marking.

In the coloured display, the lines are highlighted in colour.

S18-0189

#### Warning through steering wheel vibrations

If the steering wheel vibrates, this means the system is unable to keep the vehicle in the lane.

- › Correct the steering movement.

### Operating conditions

- ✓ The driving speed is higher than 60 km/h.
- ✓ The lane markings are clearly visible.

### Function restriction

The system function may be restricted in the following cases.

- ▶ The field of view of the sensor is limited by a dirty screen or an obstacle or a preceding vehicle.
- ▶ In the event of unfavourable weather conditions.
- ▶ When driving around a sharp bend.
- ▶ When driving on a steep road or in ruts.
- ▶ Driving lane too narrow.

#### ⚠ WARNING

Danger of incorrect steering intervention!

Certain objects or markings on the road may be erroneously recognized as lane markings.

- ▶ Always keep your hands on the steering wheel and be prepared to override the steering intervention.

### Settings

#### Activation/deactivation in the instrument cluster

In the display in the Assist systems menu item

#### Setting in Infotainment

In the menu: MENU › › ›

### Troubleshooting

#### Message regarding system unavailability

- › Clean the windscreen in the sensor area.
- › Stop the engine and start again.
- › If the system is still not available, seek the help of a specialist garage.

## Lane change assist system Side Assist

### Usage

Side Assist monitors the area beside and behind the vehicle up to a distance of approximately 70 m.

The system uses optical signals in the exterior mirror to alert the driver to vehicles that could be dangerous when changing lanes.

### Functionality

The system warns of an approaching vehicle through the illumination of the indicator light in the exterior mirror cover on the vehicle side where the vehicle is detected.



### Driving situations in which a system warning occurs

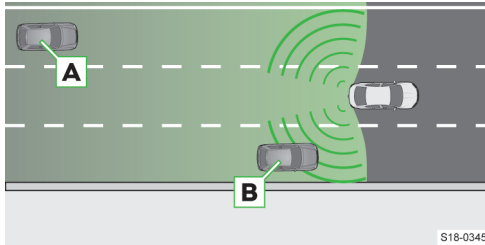

Your vehicle is overtaken by vehicle **A**. The faster vehicle **A** approaches, the sooner the warning is given by the indicator light.

Vehicle **B** is overtaken by your vehicle at a speed that is faster by max. 10 km/h. If the speed increases the overtaking process, no warning will be provided by the indicator light.

#### Indicator light

■ **illuminated** - There is another vehicle behind your vehicle

■ **flashing** - There is another vehicle behind your vehicle, and the turn signal on the same side is switched on

For vehicles with Lane Assist, the indicator light will also flash if your vehicle crosses the lane markings in the direction of the approaching vehicle. The system will trigger a steering wheel vibration in this case.

For this, Lane Assist must be activated and the lane marking between the vehicles must be detected.

### Operating conditions

- ✓ The driving speed is higher than 15 km/h.
- ✓ No accessories are connected to the trailer socket.

### Function restriction

The system cannot detect lane width. For this reason, it may, for example, draw attention to a vehicle in a distant lane in the following cases.

- ▶ Driving on a road with narrow lanes or on the lane edge.
- ▶ Driving round bends.

The system can draw attention to objects along the road, such as high guard rails or noise barriers.

The system might not warn of a vehicle e.g. in the following cases, or a warning may only be issued incorrectly.

- ▶ Unfavourable weather conditions.

- ▶ A very fast approaching vehicle.
- ▶ When going round a sharp bend or a roundabout.

### Settings

The system settings are made in the display of the instrument cluster in menu item *Assist Systems*.

The system settings are made in the infotainment system in the following menu.

MENU > >

### Troubleshooting

#### Message regarding system unavailability

- › Stop the engine and start again.
- › If the system is still not available, seek the help of a specialist garage.

## Crew Protect Assist proactive occupant protection

### Usage

The Crew Protect Assist system increases occupant protection in the front seats if a collision is imminent.

### Functionality

#### The first level of protection

With a dynamic driving style, the system tightens the front seat belts on the body.

#### The second level of protection

If the system evaluates the situation as critical:

- ▶ The front seat belts are tightened on the body.
- ▶ Open windows are closed except for a small gap.

### Settings

#### Automatic activation

The system is automatically activated when the ignition is switched on.

#### Deactivation of the first protection level

The first protection level can be deactivated as follows.

- ▶ By deactivating the ASR.
- ▶ By selecting the driving mode Sport.
- ▶ In Infotainment, in the MENU > > menu.

## Troubleshooting

### Crew Protect Assist faulty

 illuminates  
Message concerning unavailability or functional restriction

- › Seek the help of a specialist garage.

## Driver Alert fatigue detection assistant

### Functionality

Driver Alert evaluates the steering behaviour. If it detects fatigue in the driver, a break is recommended. In the display of the instrument cluster, the  lights up.

#### **WARNING**

There will be no system warning during the so-called micro-sleep.

#### Resetting the break recommendation

The break recommendation is reset in the following cases.

- ▶ The vehicle stops and the ignition is switched off.
- ▶ The vehicle stops, the seat belt is removed and the driver's door is opened.
- ▶ The vehicle stops for more than 15 minutes.

 In some situations, the system may erroneously issue a break recommendation.

### Operating conditions

- ✓ Driving speed between 60-200 km/h.

### Settings

#### Activation/deactivation

In the infotainment system, in menu: **MENU** ›  › 

## Park Assist systems

### Park Pilot parking aid

#### Functionality

If an obstacle is detected, the Infotainment will display a visible message and an audible signal will sound. The interval between the signals becomes shorter as the clearance is reduced. At a distance of less than 30 cm from the obstacle, a continuous tone sounds.

If the driver does not respond to the warning, the system triggers automatic emergency braking at speeds below 8 km/h in order to reduce the impact. Automatic braking can be activated and deactivated in the infotainment.

#### Display

The recorded areas vary according to the equipment.

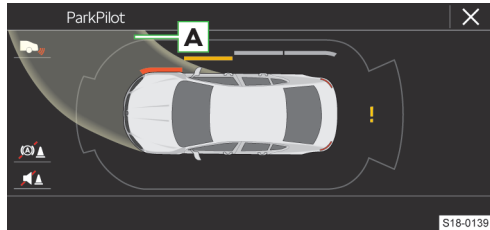

 **A** Route controlled at the current steering angle

 Acoustic signals on/off

 One-time deactivation/activation of automatic braking

 Change to the rear view camera display

 System fault

 Obstacle at a distance of less than 30 cm

 Obstacle at a distance of more than 30 cm

 Obstacle outside the route

#### Operating conditions

- ✓ The driving speed is lower than 15 km/h.
- ✓ No accessories are connected to the trailer socket.

#### Operation

##### Switching on

- › Engage reverse gear.

Or:

- › Press the **P** button.

#### Automatic switch-on during forward travel

When approaching an obstacle at a speed of less than 10 km/h.

Automatic switch-on does not activate automatic braking.

#### Switching off

- › Disengage reverse gear.

Or:

- › Press the **P** button.

#### Automatic switch off

The driving speed is higher than 15 km/h.

#### Function restriction

The system might not warn of an obstacle e.g. in the following cases, or a warning may only be issued incorrectly.



- ▶ Unfavourable weather conditions.
- ▶ The detected obstacles are moving.
- ▶ Sensor signals are not reflected by the surface of the obstacles.
- ▶ It is a small obstacle, e.g. a stone or a pillar.

#### Settings

The system settings are made in the infotainment system in the following menu.

**CAR** ›  › **P**

Or:

**MENU** ›  ›  › **P**

#### Troubleshooting

**After switching on, an audible signal sounds for 3 seconds and there is no obstacle near the vehicle**

- › Seek the help of a specialist garage.

**After switching on, the symbol **P** flashes in the button**

- › Seek the help of a specialist garage.

**After switching on, not all scanned areas are displayed on the Infotainment screen**

- › Move the vehicle a few meters forwards or backwards.
- › If the scanned areas are still not displayed, seek the help of a specialist garage.

## Rear view camera

### Functionality

When reversing, the area behind the vehicle is displayed in the Infotainment screen complete with orientation lines.

**I** The camera is equipped with a cleaning system. Cleaning takes place automatically when the rear window is washed.

### Orientation lines and functional surfaces

#### Orientation lines

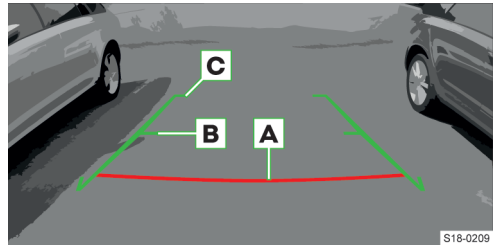



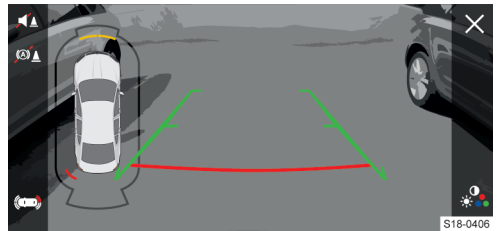

- A** Distance about 40 cm
- B** Distance about 100 cm
- C** Distance about 200 cm

The distance between the side lines corresponds approximately to the vehicle width including mirrors.

#### Function surfaces



-  Brightness, contrast and colour settings of the screen
-  Turns off the display of the area behind the vehicle
-  Switching audible parking signals on/off
-  One-time deactivation/activation of automatic braking
-  Park Pilot full screen view.

### Operating conditions

- ✓ The luggage compartment lid is closed.

- ✓ The ignition is switched on.
- ✓ The driving speed is lower than 15 km/h.

## Operation

### Switching on

- › Engage reverse gear.

### Switching off

- › Disengage reverse gear.

## Restriction

The camera image is distorted in contrast to the naked eye. The display may only be used to estimate the distance.

Some items may not be displayed properly on the screen. These include narrow columns, wire mesh fences, grids or road bumps.

## Rear Traffic Alert

### Functionality

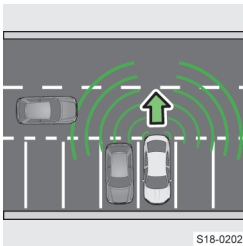

When reversing, the Rear Traffic Alert warns of approaching vehicles. If the driver does not respond to the warning, the vehicle is braked automatically at a speed below 10 km/h.

### ⚠ WARNING

When the ESC/ASR system is deactivated, automatic braking is not performed.

### Vehicle with Park Pilot

If an approaching vehicle is detected in the area behind your vehicle, a graphical warning is displayed in the Infotainment. At the same time, a continuous tone sounds.

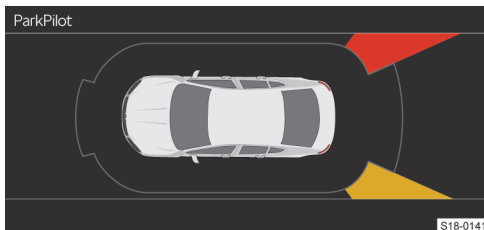

- Vehicle in collision area - danger of collision!
- Approaching vehicle

### Vehicle without Park Pilot

If an approaching vehicle is detected in the area behind your vehicle, the a warning is displayed in the instrument cluster display, indicating to the driver to monitor the traffic behind. At the same time, an acoustic signal sounds.

## Operating conditions

- ✓ ASR activated.
- ✓ No accessories are connected to the trailer socket.

## Function restriction

Manoeuvre Assist's functionality may be limited in unfavourable weather conditions.

## Settings

The system is activated or deactivated in the instrument cluster display in the *Assist systems* menu item.

The system is activated or deactivated in the following menu in the Infotainment system.

**CAR** > > **P**

Or:

**MENU** > > > **P**

## Troubleshooting

### Message regarding system unavailability

- › Stop the engine and start again.
- › If the system is still not available, seek the help of a specialist garage.

## Park steering assistant

### Usage

Park Assist helps drivers park in parallel and perpendicular parking places and to manoeuvre out of parallel parking spaces.

## What you should be mindful of

Do not use the system in the following cases.

- ▶ On unpaved or slippery surfaces.
- ▶ If snow chains or a spare wheel are mounted on the vehicle.
- ▶ If the system chooses an inappropriate parking space for parking.

## Functionality

The system looks for a parking space and only takes over the steering during the parking procedure or when leaving a parking place. The driver operates the pedals and the shift lever/gear selector.

The system displays information and notes on the instrument cluster display.

If the system detects a risk of collision, automatic emergency braking takes place to prevent a collision.

## Operating conditions

- ✓ The driving speed is lower than 7 km/h.
- ✓ The ASR is activated and there is no intervention.
- ✓ There is no driver intervention in the automatic steering operation.
- ✓ No accessories are connected to the trailer socket.

## Operation

### Turn on/turn off

- › Press the **P** button.

When the system is switched on, the symbol lights up in the button **P**.

### Select the lane side for the parking procedure

The system automatically searches for a suitable parking space on the passenger side.

- › Press the driver's side indicator to find a parking space on this side of the road.

### Operation while searching for a parking space

- › Drive past a number of parked vehicles at a distance of 0.5–1.5 m.
- › To search for a parking space across the road, drive slower than 20 km/h.
- › To search for a parking space along the road, drive slower than 40 km/h.

If the symbol  (km/h) appears in the display, reduce the driving speed. If the system finds a parking space, the display will show the recommended parking mode.

### Changing the parking mode

If a suitable parking space is found, the following Park modes can be shown in the display.

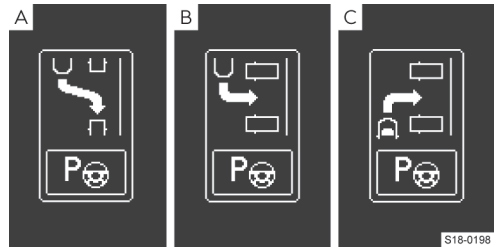

- A Park backwards longitudinally
- B Park backwards crosswise
- C Park forwards across

The parking mode can be changed by pressing the button **P**.

Press the button again **P** and the system is switched off.

- › To return to the original recommended parking mode, press the button **P** again.



### Before the parking process

- › If a suitable parking space is found, stop and drive backwards or forwards as indicated by the arrow in the display.
- › When a steering intervention message is displayed, release the steering wheel. The steering operation is taken over by the system.

### Parking operation

#### ⚠ CAUTION

Risk of injury!

- ▶ Do not reach between the steering wheel spokes during the parking manoeuvre.
- ▶ Only operate the pedals and the shift / selector lever.
- › Observe the area around the vehicle and drive backwards or forwards in accordance with the arrow in the display.
- › As soon as the symbol  appears in the display and an audible signal sounds, stop the vehicle. The steering wheel is taken over accordingly. The symbol  goes out.
- › Travel backwards or forwards in accordance with the arrow in the display.

As soon as the parking process is completed, the corresponding message is displayed and an audible signal sounds.

The parking procedure can be ended at any time by pressing the button **P**.

- i When partially parked in a suitable transverse parking space forward, press button **P**. The parking process is completed by the system.

### Exiting a parking space

- › Press the **P** button.

When the system is switched on, the symbol lights up in the button **P**.

- › Follow the instructions on the screen.

### Automatic speed reduction

If a speed of 7 km/h is exceeded during the parking process, the system will reduce the speed.

Upon the speed being exceeded by 7 km/h a second time, the parking process is terminated.

### Function restriction

If the parking space is too small, it is not possible to use the system to initiate a parking manoeuvre. A message is shown on the instrument cluster display.

### Troubleshooting

#### Message regarding system unavailability

- › Stop the engine and start again.
- › If the system is still not available, seek the help of a specialist garage.

#### Incorrect resulting position of the vehicle in the parking space

The correct parking procedure depends on the size of the wheels. If other wheels approved by ŠKODA AUTO are fitted, have the system readjusted by a specialist garage.

## Engine, exhaust system and fuel

### Bonnet

#### Opening the bonnet

##### Before opening

- › Make sure the windscreen wiper arms are folded down onto the windscreen.
- › Keep everyone away from the engine compartment.

##### To open

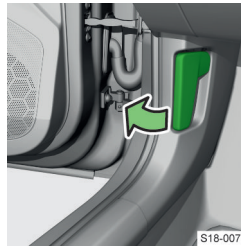

- › Pull the release lever underneath the dash panel.

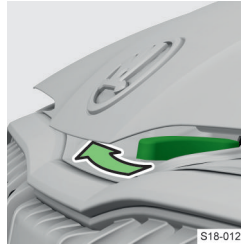

- › Release the lock.

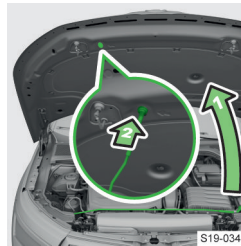

- › Open the bonnet.
- › Remove the bonnet stay from the holder and insert the end of the stay into the opening in the bonnet.

##### Closing

- › Lift the bonnet.
- › Unhook the bonnet stay and insert it into the holder.
- › Fold the bonnet down and release it with a distance of 30 cm remaining.
- › Check that the bonnet is closed.

##### ① NOTICE

- › Do not press down on an unclosed bonnet.

## Engine oil

### Checking the fill level and topping up

#### Test conditions

- ✓ Park the vehicle on a horizontal surface.
- ✓ The parked engine is warm.

#### Checking the level

- › Wait a few minutes for the engine oil to flow back into the oil sump.
- › Remove the dipstick and wipe with a clean cloth.
- › Insert the dipstick as far as it will go and pull it out again.
- › Read the oil level and push the dipstick back in again.

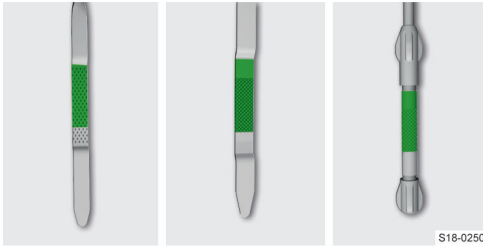

S18-0250

The oil level must be within the marked range.

#### ⓘ NOTICE

Risk of damage to the engine and the exhaust system!

- ▶ The oil level must not be outside the marked range. If it is not possible to top up the engine oil or if the oil level is above the marked range, do not continue driving. Stop the engine and seek the help of a specialist garage.
- ▶ Do not use any oil additives.

Depending on driving style and operating conditions, the engine consumes some oil, up to 0.5 l/1000 km. Consumption may be higher over the next 5000 km.

#### Refilling

- › Unscrew the cover of the engine oil filler opening.
- › Top up the oil to the correct specification in 0.5 litre portions.
- › Check the oil level.
- › Screw on the cover of the engine oil filler opening.

#### Specification

Ask a specialist garage for the correct engine oil specification for your vehicle.

If no oil of the correct specification is available, **max. 0.5 l** of oil with the following specifications may be used until the next oil change.

- ▶ **Petrol engines:** VW 504 00, VW 508 00, ACEA C3, ACEA C5.

- ▶ **Diesel engines:** VW 507 00, ACEA C3 or API CJ-4. For vehicles without a particulate filter, VW 505 01 can be optionally used.

#### Changing

Have the oil changed by a specialist garage.

### Troubleshooting

#### Engine oil pressure too low

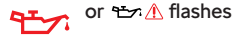

- › Check the engine oil level.

The oil level is OK, the warning light continues to flash:

- › Stop the engine and seek the help of a specialist garage.

#### Engine oil level too low



Message regarding required engine oil top up

- › Check the engine oil level, top up with oil if required.

#### Engine oil level too high



Message regarding the need to reduce the engine oil level

- › Check the engine oil level.

The oil level is too high:

- › Drive on, exercising appropriate caution.
- › Seek the help of a specialist garage.

#### Engine oil level sensor impaired



Message regarding the engine oil sensor

- › Drive on, exercising appropriate caution.
- › Seek the help of a specialist garage.

## Coolant

### Coolant temperature gauge

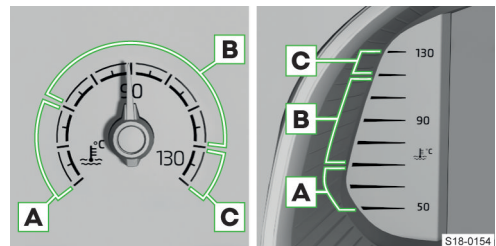

S18-0154

- A Cold area

- › Avoid high engine speed.

- B** Operating range
- C** High temperature range

### Checking the fill level and topping up

#### Test conditions

- ✓ Park the vehicle on a horizontal surface.
- ✓ The engine is turned off and cooled.

#### Checking the level



The fill level must be within the marked range.

- › If the fill level is below the mark **MIN**, top up the coolant.

#### ⓘ NOTICE

Danger of damage to the engine compartment! Do not top up the coolant above the marked area. The coolant could be forced out of the cooling system when heated.

#### ⓘ NOTICE

There must be a small quantity of coolant in the tank. Do not add coolant when the tank is empty.

- ▶ Stop driving! Seek the help of a specialist garage.

#### Refilling

#### ⚠ CAUTION

Risk of scalding!

The cooling system is pressurised. Do not open the cap of the coolant expansion tank while the engine is warm. Let the engine cool down.

- › Place a rag on the lid of the tank and carefully unscrew the lid.
- › Refill with coolant of the correct specification.
- › Screw on the cap until it clicks into place.

#### Specification

For refilling, use coolant additive G12evo (TL 774 L) or G13 (TL 774 J).



#### ⓘ NOTICE

Risk of damage to the cooling system and the engine!

Adding coolant that does not conform to the correct specification can reduce the corrosion protection of the cooling system.

### Troubleshooting

#### Coolant level is too low

 or  illuminates  
Message concerning the required coolant check

- › Check the coolant level.



The coolant level is OK:

- › Check the fuse for radiator fan, replace if required » [page 141, Replacing a fuse.](#)

The fuse is OK, the indicator light comes on again:

- › Stop driving! Seek the help of a specialist garage.

#### Coolant temperature too high

 or  illuminates  
Report regarding the engine overheating

- › Stop driving.
- › Stop the engine and allow it to cool.
- › Drive on after the indicator light goes out.

#### Engine fault

 or  lights up.  
› Stop driving!

- › Stop the engine and seek the help of a specialist garage.

#### There is no coolant of the correct specification available

- › Top up with distilled or demineralised water.
- › Have the correct coolant mixing ratio corrected by a specialist garage as soon as possible.

Another substance was used for topping up, other than distilled or demineralised water:

- › Have the coolant changed by a specialist garage.

#### It is not possible to top up with a sufficient amount of coolant

- › Stop driving.
- › Stop the engine and seek the help of a specialist garage.

#### There is a loss of coolant

- › Top up the coolant and seek the help of a specialist garage.

### Engine electronics

#### Troubleshooting

#### Petrol engine control faulty

**EPC** illuminates  
Driving in emergency mode is possible - a noticeable reduction in engine performance may occur.



- › Continue driving, exercising appropriate caution, and seek the help of a specialist garage.

**Diesel engine control faulty**



flashing

Driving in emergency mode is possible - a noticeable reduction in engine performance may occur.

- › Continue driving, exercising appropriate caution, and seek the help of a specialist garage.

**Diesel preheating system faulty**



illuminates, or does not illuminate after the ignition is switched on

Driving in emergency mode is possible - a noticeable reduction in engine performance may occur.

- › Continue driving, exercising appropriate caution, and seek the help of a specialist garage.

**Particle filter**

**Troubleshooting**

**Clogged particle filter**



or illuminates

- › Clean the filter.

**i** When the indicator light is on, it must be assumed that fuel consumption will be higher, engine power will be reduced, and the START-STOP function will not be available.

**Filter cleaning**

**Conditions for cleaning**

- ✓ The engine is warm.

**Procedure for vehicles with diesel engines**

- › Drive at a speed of at least 60 km/h at engine speeds of at least 2000 rpm.

If the filter is successfully cleaned, the indicator light goes off.

If the indicator light does not go off within 40 minutes, no filter cleaning was performed.

- › Continue driving, exercising appropriate caution, and seek the help of a specialist garage.

**Procedure for vehicles with petrol engines**

- › Drive at a speed of at least 80 km/h at engine speeds between 3000-5000 rpm.
- › Release the accelerator pedal and let the vehicle roll with the gear engaged for a few seconds.
- › Repeat this procedure several times.

If the filter is successfully cleaned, the indicator light goes off.

If the indicator light does not go off within 30 minutes, no filter cleaning was performed.

- › Continue driving, exercising appropriate caution, and seek the help of a specialist garage.

**Exhaust control system**

**Troubleshooting**

**Emission control system faulty**



illuminates

Driving in emergency mode is possible - a noticeable reduction in engine performance may occur.

- › Continue driving, exercising appropriate caution, and seek the help of a specialist garage.

**Fuel filter**

**Troubleshooting**

**Water in the diesel fuel filter**



or illuminates

- › Continue driving, exercising appropriate caution, and seek the help of a specialist garage.

**Fuel filler flap**

**Opening the fuel filler flap**



- › Press the flap and open it.

**AdBlue**

**Regulations**

Only use AdBlue® that complies with the ISO 22241-1 standard. Do not mix any additives to the AdBlue®.

AdBlue® is a registered trademark of VDA and is also known as OFF 32 (Aqueous Urea Solution) or DEF (Diesel Exhaust Fluid).

## Functionality

In order to reduce pollutant emissions, a urea solution is automatically injected into the exhaust system - AdBlue®.

AdBlue® freezes at temperatures below - 11 C. System function is ensured by an automatic heating system.

## Checking the fill level and topping up

### Checking the level

The AdBlue® level is automatically monitored.

The range with the existing AdBlue® tank fill level as well as the indication of the minimum and maximum AdBlue® top up quantity can be displayed in the driving data in the instrument cluster display.

If the range with the existing AdBlue® tank filling level drops to 0 km, it is not possible to start the engine.

- › If possible, top up AdBlue® to the maximum level.

### Requirements for refilling

- ✓ Vehicle unlocked.
- ✓ Ignition switched off.
- ✓ Park the vehicle on a horizontal surface.

### Methods of refilling

- ▶ With the fuel nozzle at the gas station.
- ▶ With the refill bottle.
- ▶ At a specialist garage.

We recommend refilling with a refill bottle, using refill bottles from the ŠKODA Genuine Parts. These are equipped with an overflow protection.

### Refilling

- › Open the tank flap.

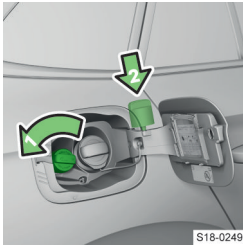

S18-0249

- › Turn the tank cap in the direction of the arrow and remove it.
- › Place the tank cap on the tank flap.
- › Top up AdBlue®.

The AdBlue® tank is full when the fuel nozzle switches off or as soon as no more AdBlue®

flows out of the refill bottle. Do not continue refilling.

- › Place the tank cap on the filler neck and turn it in the opposite direction to the arrow until it clicks into place.
- › Close the tank flap and click into place.
- › Before starting the engine, leave the ignition on for 30 seconds to allow the system to detect the refilling.

### ⓘ NOTICE

Risk of damage to the AdBlue® system!

- ▶ Do not exceed the maximum refill quantity specified in the instrument cluster.
- ▶ The service life of AdBlue® is 4 years. If the tank contents are not consumed within this period, have them replaced by a specialist garage. For refilling, do not use any AdBlue® which has passed its expiry date.

## Troubleshooting

### AdBlue® level too low

- or or lights up.
- › Top up AdBlue®.

### AdBlue® system impaired.

- or or lights up
- › Seek the help of a specialist garage.

## Technical data

The AdBlue® tank capacity is approximately 12 litres.

## Petrol

### What you should be mindful of

#### ⚠ DANGER

Risk of death!  
Fuel and fuel vapours are explosive.

#### ⓘ NOTICE

Risk of damage to the engine and the exhaust system!  
› Never empty the fuel tank completely!

If you would like to operate your vehicle in a country other than that intended for vehicle operation, please contact a ŠKODA Partner. They will let you know whether a suitable fuel is offered in the associated country.

## Regulations

### Standards

Petrol must comply with European standard EN 228 (in Russia, GOST 32513-2013).

Only use **unleaded petrol** that contains **max 10%** bi-ethanol (**E10**).

ⓘ We recommend using petrol with additives, which is available at petrol stations at the petrol pumps.

**Octane number**

Use the petrol with the octane number prescribed for your vehicle.

Petrol with an octane number that is one **higher** than the one prescribed for your vehicle can be used without restriction.

**NOTICE**

Risk of damage to the engine and the exhaust system!

- ▶ If petrol is used that has an octane number that is lower than the one prescribed for your vehicle, then drive at moderate speeds with minimal engine stress.
- ▶ Fill up with the prescribed octane number as soon as possible.
- ▶ Do not use petrol with an octane number that **lower** than **91**!

**Prescribed petrol 95 / min. 92 or 93 RON / ROZ**

We recommend using **95 RON** petrol.

**92 or. 93 RON** petrol may be used as an option (low power loss, slightly increased fuel consumption).

In an **emergency**, **91 RON** petrol may be used (low power loss, slightly increased fuel consumption).

**Prescribed petrol min. 95 RON / ROZ**

Use min. **95** petrol.

Using higher octane petrol than 95 RON may result in improved performance and lower fuel consumption.

In an **emergency 91. 92 or. 93 RON** may be used (low power loss, slightly increased fuel consumption).

**Prescribed petrol 98 / (95) RON / ROZ**

We recommend using **98 RON** petrol.

**95 RON** petrol may be used as an option (low power loss, slightly increased fuel consumption).

In an **emergency 91. 92 or. 93 RON** may be used (low power loss, slightly increased fuel consumption).

**Additive****NOTICE**

Risk of damage to the engine and the exhaust system!

- ▶ Do not use petrol containing metal-based additives, e.g. manganese, iron, lead, and do not use, for example, any LRP petrol – lead replacement petrol.
- ▶ Do not add any additional additives to the petrol in accordance with EN 228.
- ▶ If petrol is not used in accordance with EN 228, we recommend obtaining information from a specialist company regarding the possible use of petrol additives approved by ŠKODA AUTO.

**Requirements for refuelling**

- ✓ Vehicle unlocked.
- ✓ Ignition switched off.

**Refilling****Refilling**

- › Open the tank flap.

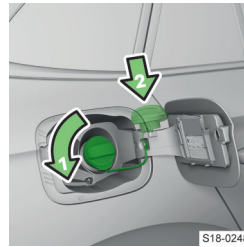

- › Turn the tank cap in the direction of the arrow and remove it.
- › Place the tank cap on the tank flap.
- › Insert the fuel nozzle into the fuel filler neck up to the stop and refuel.

- › Do not continue refuelling after the fuel nozzle

switches off.

- › Remove the fuel nozzle and put it back on the petrol pump.
- › Place the fuel cap on the fuel filler neck and turn it in the opposite direction to the arrow until it clicks into place.
- › Close the tank flap and click into place.

**Troubleshooting****If fuel other than unleaded petrol has been refuelled according to the standards applicable to your vehicle**

- › Do not start the engine or switch on the ignition.
- › Seek the help of a specialist garage.

**Technical data**

The fuel prescribed for your vehicle is indicated on a sticker on the inside of the fuel filler flap.

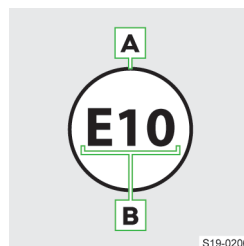

**A** Unleaded petrol

**B** Organic share as a percentage

The fuel tank has a capacity of about 50 litres, including a reserve of approx. 7 litres.



The fuel supply has reached the reserve area.

## Diesel

### What you should be mindful of

#### ⚠ DANGER

Risk of death!

Fuel and fuel vapours are explosive.

#### ⓘ NOTICE

Risk of damage to the engine and the exhaust system!

› Never empty the fuel tank completely!

If you would like to operate your vehicle in a country other than that intended for vehicle operation, please contact a ŠKODA Partner. They will let you know whether a suitable fuel is offered in the associated country.

### Regulations

#### Standards

The diesel fuel must comply with European standard EN 590 (in Russia, GOST 32511-2013 or GOST R 55475-2013).

Only use a **diesel fuel** that contains a **maximum** of 7 % biodiesel (**B7**).

ⓘ We recommend using diesel with additives, which is available at petrol stations at the petrol pumps.

#### Operation in different weather conditions

Only use a diesel fuel according to the current or the expected weather conditions.

#### Additive

#### ⓘ NOTICE

Risk of damage to the engine and the exhaust system!

- ▶ Do not use RME biofuel, even as a diesel fuel additive.
- ▶ Do not add any additional additives to the diesel in accordance with EN 590.
- ▶ If diesel is not used in accordance with EN 590, we recommend obtaining information from a specialist company regarding the possible use of diesel additives approved by ŠKODA AUTO.

### Requirements for refuelling

- ✓ Vehicle unlocked.
- ✓ Ignition switched off.

### Refuelling

#### Misfuelling protection

The fuel filler neck on diesel vehicles may be equipped with a misfuelling protection device.

In some countries, the diameter of the diesel fuel nozzle may be identical to that of the petrol nozzle. Before driving in these countries, have the protection device removed by a specialist garage.

#### Refuelling

› Open the tank flap.

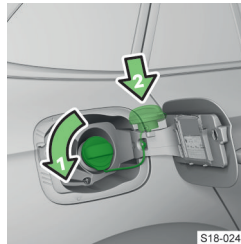

› Turn the tank cap in the direction of the arrow and remove it.

› Place the tank cap on the tank flap.

› Insert the fuel nozzle into the fuel filler neck up to the stop and refuel.

› Do not continue refuelling after the fuel nozzle switches off.

zle switches off.

› Remove the fuel nozzle and put it back on the petrol pump.

› Place the fuel cap on the fuel filler neck and turn it in the opposite direction to the arrow until it clicks into place.

› Close the tank flap and click into place.

### Troubleshooting

#### If a fuel other than diesel fuel has been refuelled to the appropriate standard

- › Do not start the engine or switch on the ignition.
- › Seek the help of a specialist garage.

#### The diesel fuel nozzle cannot be correctly inserted into the filler neck

- › If the fuel nozzle cannot be properly inserted into the fuel filler neck, move it slightly back and forth when inserting it.

### Technical data

The fuel prescribed for your vehicle is indicated on a sticker on the inside of the fuel filler flap.

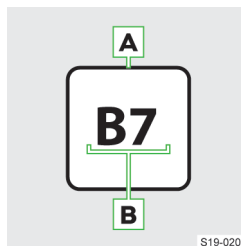

**A** Diesel

**B** Organic share as a percentage

The fuel tank has a capacity of about 50 litres, including a reserve of approx. 7 litres.



The fuel supply has reached the reserve area.

## Vehicle battery and fuses

### Vehicle battery

#### Functionality - Discharge protection

##### Possible causes of battery discharge

- ▶ Frequent short-distance traffic.
- ▶ Low temperatures.
- ▶ Vehicle stationary for a long period of time.

##### System-related discharge protection measures

- ▶ Increasing the engine idling speed.
- ▶ Switching off certain consumers or limiting their power.

##### Measures to be taken when vehicle stationary for more than three weeks

- › Disconnect the ⊖ terminal of the vehicle battery.

#### Checking and charging the vehicle battery

##### Checking the condition

The battery condition is checked by a specialist garage during servicing.

##### Checking the acid level

Applies to a vehicle battery with an acid level indicator.

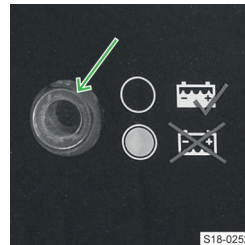

S16-0252

- › Tap on the indicator before testing, to clear air bubbles.

Black colour - the acid level is OK.

Colourless or pale yellow colour - acid level is too low, the battery must be replaced.

##### Requirements for the charging process

- ✓ Ignition switched off.
- ✓ Power consumers switched off.

##### Vehicle battery charging process

To charge the vehicle battery fully, set a charging current of max. of 0.1 times the battery capacity.

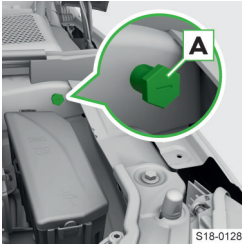

Earth point

- › Connect the ⊕ terminal of the charger to the ⊕ terminal of the vehicle battery.
- › Connect the ⊖ terminal of the charger to the earth point **A**.
- › Plug the charger's power cable into the socket and switch on the device.

- › After charging, switch off the charger and unplug the power cable from the socket.
- › Disconnect the charger terminals from the vehicle battery.

**⚠ WARNING**

Risk of explosion!

- ▶ During charging, hydrogen is released. An explosion can also be caused by sparks, for example, when disconnecting or loosening the cable connector.
- ▶ Never charge a frozen or thawed vehicle battery.
- ▶ Do not carry out the so-called quick charging of the vehicle battery yourself, but have it carried out by a specialist garage.

**ⓘ NOTICE**

A discharged vehicle battery can freeze easily.



**Troubleshooting**

**Vehicle battery does not charge while the engine is running**

 or  **⚠** is lit up

- › Seek the help of a specialist garage.

**Engine fault**

  or  **⚠** is lit up

- › Stop driving!

- › Stop the engine and seek the help of a specialist garage.

**Disconnecting, connecting and replacing**

**⚠ CAUTION**

Risk of fire!

- ▶ Do not mix up the connection cables.

**Disconnecting**

- › Close the electric boot lid, all windows and the electric sunblind.
- › Switch off the ignition and any connected power consumers.
- › Disconnect the ⊖ terminal and then the ⊕ terminal.

**Connecting**

- › Connect the ⊕ terminal and then the ⊖ terminal. After switching on the ignition, the warning lights are lit up. .
- › If, after a short distance, one of the above-mentioned indicator lights does not go out, seek the help of a specialist garage.

**Commission these functions after disconnecting and connecting the vehicle battery**

- ▶ Clock setting » page 48.
- ▶ Window operation » page 25.
- ▶ Sunblind » page 25.

**Changing**

The new vehicle battery must have the same parameters as the original battery. Have the replacement carried out by a specialist garage.

**Using the jump-starting cable**

**What you should be mindful of**

**⚠ WARNING**

Risk of explosion and chemical burns!

- ▶ Do not jump start with the battery of another vehicle under the following conditions.
  - ▶ The discharged vehicle battery is frozen. A discharged vehicle battery can freeze at temperatures just below 0°C.
  - ▶ The battery acid level is too low » page 139.

Use jump leads with a sufficient cross section and insulated terminal clamps.

The rated voltage of both batteries must be 12V. The capacity (in Ah) of the charging battery must not be significantly lower than the capacity of the discharged battery.

**Jump-starting with the battery of another vehicle**

**⚠ WARNING**

Risk of injury and danger of vehicle damage!

- ▶ Lay the jump start cables so that they cannot become caught by rotating parts in the engine compartment.

**ⓘ NOTICE**

Short circuit!

- ▶ The non-insulated parts of the terminal clamps must not touch each other.
- ▶ The cable connected to the positive pole of the battery must not come into contact with electrically conductive vehicle parts.
- ▶ The vehicles must not touch each other.

### Start the engine

- › Connect the terminal clamps of the jump start cables in the order shown in the legend.

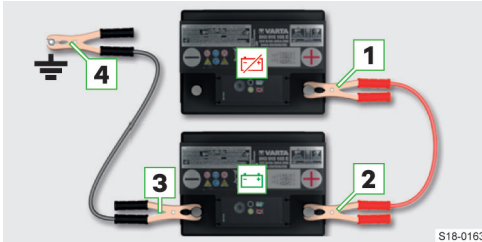

- 1 ⊕ pole of the flat battery.
- 2 ⊕ pole of the current-giving battery.
- 3 ⊖ pole of the current-giving battery.
- 4 ⚡ Earth point of the engine to be started.

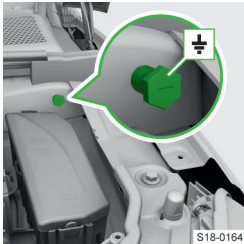

Earth point

- › Start the engine of the current-giving vehicle and let it idle.
- › Start the engine of the vehicle with the flat battery.
- › If the engine of the vehicle with the discharged battery does not start within 10 seconds, repeat the starting procedure after ap-

proximately 30 seconds.

### Disconnecting the cable

- › Disconnect the cables in the reverse order from connection.

## Fuses

### What you should be mindful of

#### ⓘ NOTICE

Fire hazard and risk of damage to the electrical system.

- ▶ Do not repair fuses or replace them with stronger fuses.
- ▶ Replace the defective fuse with a new fuse with the same amperage.
- ▶ We recommend using replacement fuses from the ŠKODA Genuine Accessories range. These guarantee reliable and safe consumer protection.
- ▶ If a newly inserted fuse blows again, seek the help of a specialist garage.

ⓘ One fuse may belong to several consumers. One consumer may have several fuses.

### Functionality

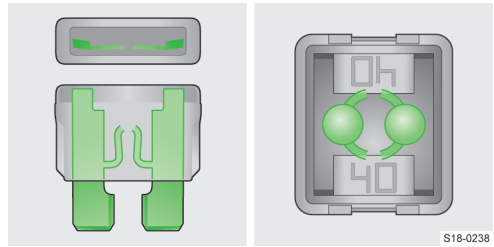

Blown fuse

### Conditions for the replacing a fuse

- ✓ Ignition key removed (vehicle without starter button).
- ✓ Ignition switched off and driver's door open (vehicle with starter button).
- ✓ All consumers switched off.

### Replacing a fuse

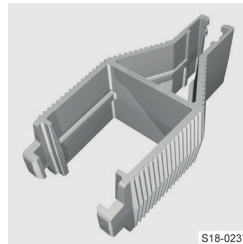

- › Replace the fuse with the clamp located on the inside of the fuse box cover in the engine compartment.
- › Use the appropriate end of the clamp according to the fuse dimensions.

## Fuses in the dash panel

### Overview

#### Access to the fuses

- › Open the storage compartment on the driver's side.

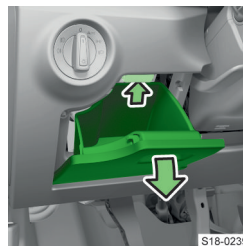

- › Press the button and open the tray.
- › Pull the tray out by pulling it towards you.
- › Change the fuse.
- › Insert and close the tray at the original location.



Fuses overview

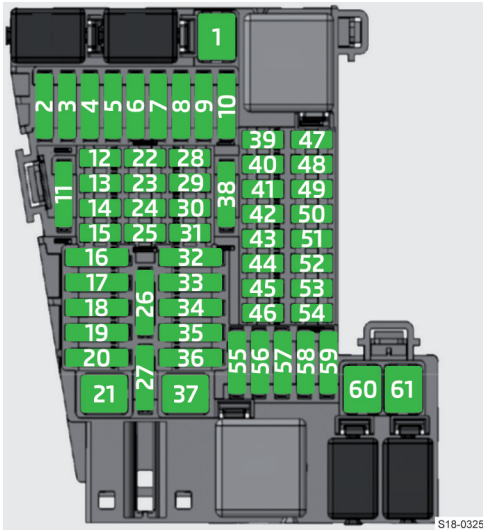

S18-0325

Fuse number	Consumer
1	Tow hitch
2	LED headlights - left side
3	Music amplifier
4	Headlight washers
5	Tilting/sliding sunroof
6	Central locking, windscreen washer, rear window wiper
7	Seat heating - rear
8	Climatronic
9	LED headlights - right side
10	Tow hitch
11	Electric boot lid
12	Heated steering wheel
13	Light switch, diagnosis connection, rain sensor, control lever under the steering wheel, front windscreen heating
14	Windscreen washer system
15	Instrument cluster, emergency call
16	Light - right side
17	Electric windows - right side
18	Windscreen wiper
19	Infotainment
20	Heated rear window
21	SCR (AdBlue®)
22	Not used
23	Reversing camera
24	Phonebox, GSM antenna, USB connection, Infotainment screen
25	Control lever under the steering wheel
26	Databus
27	Shock absorber adjustment (adaptive suspension)

Fuse number	Consumer
28	Alarm system sensor
29	Alarm system horn
30	Ignition (ignition lock)
31	Air conditioning, heating
32	Passenger belt tensioners
33	Electric windows - left side
34	Driver belt tensioners
35	Light - left side
36	Horn
37	Heating of the front seats
38	Interior lighting, button lighting, headlight cleaning system, ambient lighting, manual air conditioning, heating
39	Assist systems
40	Light switch, headlights, headlight leveling, diagnostic connection, reversing light switch, control lever under the steering wheel
41	Interior mirror dimming, exterior mirror adjustment
42	Clutch pedal switch, engine start, air conditioning
43	Rear window wiper
44	Airbag system, airbag control lamp
45	Windscreen wiper
46	Seat heating - rear
47	Not used
48	Electric steering column lock, Kessy (keyless lock and start system)
49	SCR (AdBlue®)
50	USB connections at the back
51	Not used
52	Cigarette lighter / 12 volt socket in front
53	Ignition key trigger lock, automatic transmission
54	12 volt socket in the luggage compartment
55	Not used
56	Manual air conditioning, heating
57	Not used
58	Windscreen washer system
59	Exterior mirror heating, washer nozzle heating
60	Tow hitch
61	Tow hitch



## Fuses in the engine compartment

### Overview

#### Access to the fuses

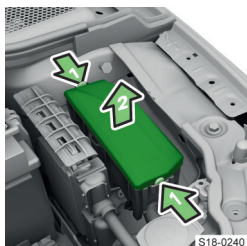

- › Simultaneously press the locking buttons on the fuse box cover and remove the cover.
- › Change the fuse.
- › Fit the cover and click into place.

#### ⚠ NOTICE

Danger of water entering the fuse box.

- ▶ Fit the cover correctly and click into place securely.

#### Fuses overview

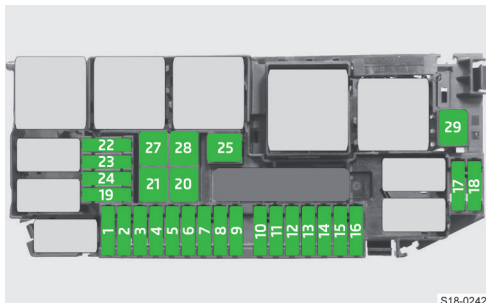

Fuse number	Consumer
15	Automatic gearbox
16	Not used
17	Engine control system
18	Starter
19	Not used
20	ESC
21	ESC
22	Not used
23	Not used
24	Not used
25	Electric auxiliary heater, radiator fan
27	Electric auxiliary heater, radiator fan
28	Electric auxiliary heater
29	Heated windscreen

Fuse number	Consumer
1	Engine control unit
2	Exhaust flap, coolant pump, radiator blinds, SCR (AdBlue®), engine components
3	Lambda sensors, NOx control unit
4	Fuel pump, engine components
5	Radiator fan, boost pressure regulator, oil level and oil temperature sensor, engine components
6	Crankcase breather, glow plug system, engine components
7	Brake system (vacuum pump)
8	Fuel pump, engine components
9	Brake light switch
10	Databus, BCM controller, battery data module
11	Not used
12	Air Conditioning
13	Not used
14	ESC, engine control system, engine components

## Wheels

### Tyres and rims

#### What you should be mindful of

##### ① NOTICE

- ▶ Protect tyres from contact with lubricants and fuel.
- ▶ Always store wheels or tyres in a cool, dry and, where possible, dark place. Tyres without rims should be stored in an upright position.
- ▶ Alloy rims can be damaged by grit.

##### Causes of uneven tyre wear

- ▶ Improper tyre pressure.
- ▶ Driving style (e.g. fast cornering, rapid acceleration and deceleration).
- ▶ Wheel alignment error.
- ▶ Incorrect wheel balancing.

##### Wheel changes

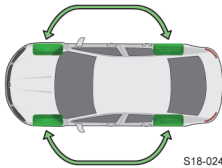

S18-0243

For uniform wear on all tyres, we recommend that you change the wheels every 10,000 km according to the schedule.

##### Advice for tyre assembly

- ▶ Follow the specified running direction, otherwise the driving characteristics may be impaired. The direction of rotation of the tyres is marked by arrows on the wall of the tyre.
- ▶ Always replace the tyres by the axle.

##### Additional information

Only fit radial tyres of the same type, size (rolling circumference) and the same tread pattern on one axle.

Approved tyre sizes are specified in the technical vehicle documentation and in the declaration of conformity (in the so-called COC Document).

The declaration of conformity can be obtained from a ŠKODA Partner (valid for some countries and some models).

#### Overview of tyre labelling

##### Explanation of tyre markings

e.g. 205/60 R 16 92 H

- 205** Tyre width in mm
- 60** Height/width ratio in %
- R** Code letter for the type of tyre - Radial
- 16** Diameter of wheel in inches
- 92** load index
- H** Speed symbol

##### load index

The load index indicates the maximum permissible load for each individual tyre.

- 88** 560 kg
- 89** 580 kg
- 90** 600 kg
- 91** 615 kg
- 92** 630 kg
- 93** 650 kg
- 94** 670 kg
- 95** 690 kg

##### Speed symbol

The speed symbol indicates the maximum permissible speed for a vehicle fitted with tyres in the category concerned.

- S** 180 km/h
- T** 190 km/h
- U** 200 km/h
- H** 210 km/h
- V** 240 km/h
- W** 270 km/h
- Y** 300 km/h

##### ⚠ WARNING

- ▶ Do not exceed the maximum permissible load bearing capacity and speed for the tyres fitted.

##### Tread wear indicators



S18-0245

Wear indicators are located in the profile of the tyres that display the permissible minimum tread depth.

Markings on the walls of the tyres with the letters "TWI" or other symbols (e.g. Δ) indicate the position of the wear indicators.

A tyre is to be regarded as worn out when this wear indicator is flush with the tread.

① The tread depth can be measured using a tread depth gauge on the ice scraper. The ice scraper is located on the inside of the fuel filler flap.

##### ⚠ WARNING

- Risk of an accident!
- ▶ Do not use worn tyres.

##### Tyre manufacturing date

The date of manufacture is indicated on the tyre sidewall.

For example, DOT ... 10 19 means that the tyres were produced in the 10th week of the year 2019.

##### ⚠ WARNING

- Risk of an accident!
- ▶ Do not use tyres that are older than 6 years.

## Troubleshooting

### Help with a flat tyre

- ▶ Spare and emergency spare wheel » page 145.
- ▶ Changing the wheel and raising the vehicle.
- ▶ Breakdown kit » page 147.

### Change of tyre pressure



Change of tyre pressure

- ▶ Stop the vehicle.
- ▶ Check the tyres and tyre pressures.

The tyre highlighted by the system can be seen in the infotainment in the following menu item.

**CAR** >  > Vehicle status

Or:

**MENU** >  >  > Vehicle status

## All-season or winter tires

### Usage

All-season (or "winter") tyres improve handling in winter weather conditions. They are characterised by 'M+S' and a mountaintop and snowflake symbol .

### What you should be mindful of

For the best possible handling, use tyres on all four wheels with a minimum tread depth of 4 mm.

Change winter tyres to summer tyres at the appropriate time. Summer tyres have better driving and braking characteristics on snow- and ice-free roads and at temperatures above 7 °C.

### Usage conditions

If all-season tyres are installed that have a lower speed category than the actual specified maximum vehicle speed, then proceed as follows.

- ▶ In infotainment, set the speed limit according to the category of tyres fitted.
- ▶ In the driver's field of view, affix a warning label with the maximum value of the speed category intended for the tyres fitted (applies only to certain countries).

### Settings

The speed limit setting for tyres is set in the infotainment in the following menu item.

**CAR** >  > 

Or:

**MENU** >  >  > 

## Snow chains

### Usage

The snow chains improve driving in wintry road conditions.

#### **WARNING**

Risk of accident as well as tyre damage!

- ▶ Do not use chains on routes that are free from snow and ice.

### What you should be mindful of

- ▶ Before fitting the snow chains, remove the full wheel trims.
- ▶ Only mount the snow chains on the front wheels.

### Technical data

Permitted rim/tyre combinations for mounting of snow chains.

Rim size	Tyre size
6Jx16 ET35	195/60 R16

Only fit snow chains with links and locks that are no larger than 13 mm.

## Spare and emergency spare wheel

### Overview

#### Spare wheel

- ▶ A full spare wheel is identical to the wheels mounted on the vehicle.
- ▶ A temporary spare wheel is provided with a warning label on the rim. This wheel is intended to enable you to reach the nearest specialist garage.

Inflate a space saver wheel with the maximum prescribed pressure.

#### Emergency wheel

A warning label is displayed on the rim of the temporary spare wheel. This wheel is intended to enable you to reach the nearest specialist garage.

An emergency wheel is significantly narrower than the wheels mounted ex-factory.

### Remove the wheel on vehicles without sound system and replace

The spare wheel or emergency wheel is mounted in a recess under the floor covering or the variable loading floor in the boot.



#### Removing

- › Loosen the retaining belt and take out the box with the tool kit.
- › Unscrew the locking screw.
- › Take out the wheel.

#### Inserting

- › Insert the wheel into the wheel well with the outside facing downwards.
- › Pull the fixing band through the opposite holes in the wheel rim.
- › Screw in the locking screw until it stops.
- › Replace the box with the tool kit into the wheel and secure it with the tape.

### Remove the wheel on vehicles with sound system and replace

#### Removing

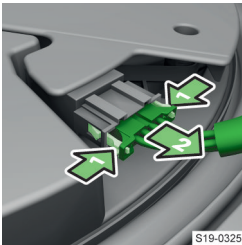

- › Press the safety button and remove the plug.

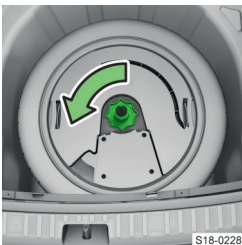

- › Unscrew the lock nut.
- › Remove the bass loudspeaker.
- › Take out the wheel.

#### Inserting

- › Insert the wheel into the wheel well with the outside facing downwards.
- › Insert the bass loudspeaker.
- › Screw in the locknut until it stops.
- › Insert the connector in the bass loudspeaker.

### Changing the wheel and raising the vehicle

#### What you should be mindful of

##### Before changing

- › Park the vehicle securely and secure it from rolling away.
- › Turn off the engine.
- › Let all of the occupants get out. During the wheel change they should not stand on the road, e.g. behind the crash barriers.
- › All doors, the luggage compartment and tailgate close.
- › Uncouple any trailers.

##### Raise vehicle

##### ⚠ WARNING

Always ensure the base plate of the lifting jack cannot slip!

- ▶ Provide a wide and firm base under the jack on loose surfaces.
- ▶ Create a non-slip base (e.g. a rubber floor mat) under the jack on a smooth surface.
- ▶ Always raise the vehicle with the doors closed.
- ▶ Do not insert any body parts under the raised vehicle.
- ▶ Do not start the engine of the lifted vehicle.

##### ⓘ NOTICE

Danger of damage to vehicle!

- ▶ Make sure that the jack is attached correctly to the bridge of the sill.

##### After having been changed

- › Check the tyre pressure on the mounted wheel and adjust if necessary.
- › In vehicles with a tyre indicator, save the tyre pressure values in the system.
- › Have the tightening torque of the wheel bolts of the mounted tyres checked with a torque wrench as soon as possible.

The specified tightening torque is 120 Nm.

Drive carefully until the tightening torque is checked.

Replace the damaged tyre. It is not recommended to repair the tyre.

**⚠ WARNING**

Risk of an accident!

- ▶ Too low a tightening torque may cause the wheel to disengage while driving.
- ▶ Too high a tightening torque can damage the threads and cause the rim to deform.

**⚠ WARNING**

Risk of an accident!

- ▶ Do not grease or lubricate screws.
- ▶ Do not use corroded or damaged screws.

## Changing the wheel and raising the vehicle

### Release screws

- ▶ If the vehicle has covers over the wheel bolts or wheel trims, remove them.

**⚠ WARNING**

If you step on the key end when loosening the screw, hold on to the vehicle for better stability.



Some vehicles may have anti-theft wheel bolts that protect the wheels from theft.

- ▶ Insert the upper section on the anti-theft wheel bolt until it stops.



- ▶ Place the key on the wheel bolt or on the attachment piece.
- ▶ Turn the screw a maximum of half a turn so that the wheel does not come loose and fall off.

### Jacking points for the jack

The jacking points are located on the lower sill of the vehicle.

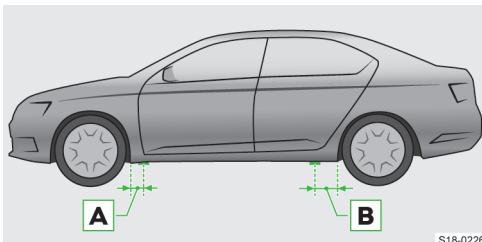

**A** - 15.5 cm

**B** - 25.8 cm

### Position the jack and lift the vehicle

Use the jack from the tool kit.

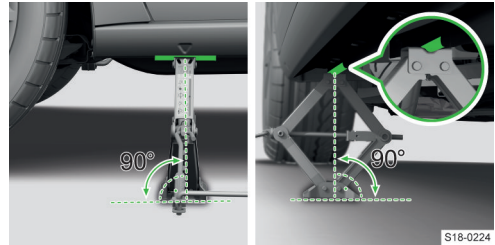

- ▶ Position the jack at the jacking point closest to the wheel to be replaced.
- ▶ Insert the crank into the mount on the car jack.
- ▶ Support the base plate of the jack with its full area resting on level ground and ensure that the jack is located in a vertical position at the jacking point.
- ▶ Use the crank to raise the jack until its claw encloses the bar.
- ▶ Continue to lift the vehicle until the wheel is just off the floor.

### Changing a wheel

- ▶ Unscrew the screws and place them on a clean surface.
- ▶ Remove the wheel carefully.
- ▶ Attach the wheel.
- ▶ Slightly screw in the screws.
- ▶ Lower the vehicle.

**① NOTICE**

Applies to wheel trims supplied ex-factory or from ŠKODA Original Accessories: the anti-theft wheel bolt should be installed in the position marked on the back of the wheel trim.

### Tighten screws

- ▶ Tighten the opposite wheel bolts including the anti-theft wheel bolt one after the other.
- ▶ Reinstall the cover caps of the wheel bolts or the full wheel covers.

**[i]** Keep the label with the code number of the anti-theft wheel bolts. A replacement upper section can be acquired from ŠKODA original parts based on this.

## Breakdown kit

### Content overview

The kit is located in a box under the floor covering in the luggage compartment.

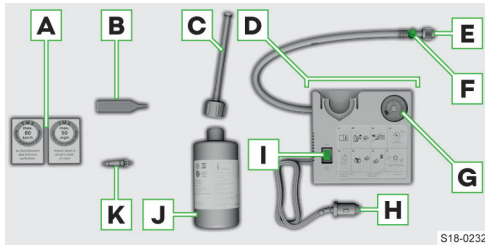

S18-0232

- A** Sticker with speed indication
- B** Valve remover
- C** Inflation hose with plug
- D** Air compressor (the layout of the controls may be different depending on the type of air compressor)
- E** Tyre inflation hose
- F** Button for pressure reduction
- G** Pressure indicator
- H** 12 volt cable connector
- I** ON and OFF switch
- J** Tyre inflation bottle
- K** Replacement valve core

The declaration of conformity is included with the air compressor or the log folder.

### Usage conditions

Performing a repair with the breakdown kit not at all intended to replace a permanent repair on the tyre.

The purpose of the repair is to get you to the nearest specialist garage.

Change the tyre repaired by the breakdown kit as soon as possible.

#### Before using the kit

- › Park the vehicle securely and secure it from rolling away.
- › Turn off the engine.
- › Let all of the occupants get out. During the wheel repair they should not stand on the road, e.g. behind the crash barriers.
- › Close all doors as well as the bonnet and boot lid.
- › Uncouple any trailers.

#### After using the kit

If a tyre pressure of 2.0 bar can not be achieved, the tyre is too damaged and cannot be sealed with the puncture set.

- › Stop driving. Seek the help of a specialist garage.

Once a tyre pressure of 2.0–2.5 bar is achieved, continue the journey at a maximum speed of 80 km/h (50 mph).

- › Avoid full accelerations, strong braking and fast cornering.

#### Information for driving with repaired tyres

- › The pressure of the repaired tyre must be checked after driving for 10 minutes.
- › If the tyre pressure is 1.3 bar and less, do not continue! Seek the help of a specialist garage.
- › If the tyre pressure is higher than 1.3 bar, correct the pressure to the correct value of at least 2 bar and continue driving.

#### ⓘ NOTICE

Danger of damage to the compressor!

- ▶ After the maximum running time of the air compressor, allow it to cool for a few minutes.

#### ⚠ WARNING

Risk of burns!

The tyre inflation hose and the air compressor may become hot when inflated.

- ▶ Allow the air compressor and hose to cool for a few minutes.

### Usage restrictions

Do not use the kit in the following cases.

- ▶ The rim is damaged.
- ▶ The outdoor temperature is below the minimum temperature indicated in the manual of the tyre filling bottle.
- ▶ Tyre punctures are greater than 4 mm.
- ▶ There is damage to the tyre wall.
- ▶ The expiry date stated on the tyre inflation bottle has expired.

### Self-help

#### Seal the tyres

- › Unscrew the valve cap from the damaged tyre.
- › Unscrew the valve core with the valve insert and place it on a clean surface.
- › Shake the tyre inflation bottle back and forth with sealant.
- › Screw the inflation hose onto the tyre inflator bottle. The film on the closure is pierced automatically.
- › Remove the plug from the inflation hose and push it fully onto the tyre valve.
- › Hold the bottle with the bottom facing upwards and fill all of the sealing agent into the tyre.
- › Remove the filler plug from the valve.
- › Screw in the valve insert.

**Inflate tyres**

- › Fit the tyre inflation hose of the air compressor to the tyre valve.
- › Secure the vehicle with the parking brake.
- › Start the engine.
- › Plug the connector into the 12 volt socket .
- › Turn on the air compressor.
- › Once a tyre pressure of 2.0-2.5 bar is reached, turn off the air compressor.

Observe the maximum running time of the air compressor according to the directions of the repair kit manufacturer.

- › If an air pressure of 2.0 - 2.5 bar has not been reached, remove the tyre inflation hose from the valve.
- › Drive approx. 10 metres forwards or backwards to allow the sealing agent to distribute in the tyre.
- › Replace the tire inflation hose on the valve and repeat the inflation procedure.

**Tyre pressure****What you should be mindful of****ⓘ NOTICE**

- ▶ Always adjust the tyre pressure to the load.
- ▶ Check the pressure in all tyres at least once a month and before each longer ride.
- ▶ Check the pressure when the tyres are cold. If necessary, do not reduce the elevated pressure when the tyres are warm.
- ▶ After each tyre pressure change, save the new values in the tyre pressure monitoring system.

**⚠ WARNING**

Risk of an accident!

If tyre pressure loss is very quick, try to stop the vehicle carefully without heavy steering or heavy braking.

**Sticker with prescribed tyre pressures**

The sticker with prescribed tyre pressures is located on the inside of the fuel filler flap.

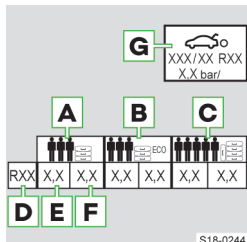

- A** Inflation pressure for half load
- B** Inflation pressure for environmentally friendly operation (slightly lower fuel consumption and emissions)
- C** Inflation pressure for full load

**D** Tyre diameter in inches

This information only serves as information for the prescribed tyre pressure. This is not a listing of approved tyre sizes for your vehicle. These are listed in the technical vehicle documentation and in the declaration of conformity (in the so-called COC Document).

**E** Tyre pressure reading for the front axle tyres**F** Tyre pressure reading for the rear axle tyres**G** Prescribed tyre pressure value for the emergency wheel**Tyre pressure monitoring system****Functionality**

The tyre pressure monitoring indicator indicates a change in tyre pressure.

**Warning when pressure changes**

Illuminated - Tyre pressure change

- › Stop the vehicle.
- › Check the tyres and tyre pressures.

**Show tyres with modified pressure**

- › In Infotainment, select the following menu.

**CAR** > > Vehicle status

Or:

**MENU** > > > Vehicle status

**Function restriction**

The system is unable to provide a warning in the event of a very rapid tyre pressure loss, e.g. sudden puncture.

The system function may be restricted in the following cases.

- ▶ Uneven loading of the wheels, e.g. with a trailer attached.
- ▶ Sporty driving style.
- ▶ Driving on dirt roads.
- ▶ Snow chains fitted.

**Saving tyre pressure values****Store the tyre pressure values in the infotainment**

- › Inflate the tyres to the prescribed inflation pressure.
- › Turn on the ignition.
- › In Infotainment, select the following menu.



**CAR** > > Vehicle status

Or:



MENU ›  ›  › Vehicle status

- › Tap on the functional surface  SET.

Using the functional surfaces   select the tyre control display menu.

- › Then follow the instructions on the screen.

Save the tyre pressures in the following cases.

- ▶ Change of tyre pressure.
- ▶ Change of one or more wheels.
- ▶ Change of position of a wheel on the vehicle.
- ▶ Always after covering a distance of 10,000 km or once a year.

## Troubleshooting

### Tyre pressure monitoring system faulty

 flashes for about 1 minute and stays on

- › Stop the vehicle, switch off the ignition and start the engine.

If the  symbol flashes again after starting the engine, there is a system fault.

- › Continue driving, exercising appropriate caution, and seek the help of a specialist garage.

## Wheel bolt cover caps

### Remove cover caps and install

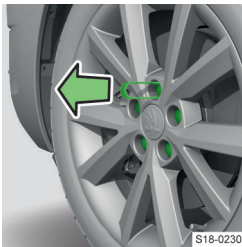

#### Disconnecting

- › Push the pull-off clamp onto the cover cap up to the stop.
- › Remove the cover cap.

#### Installing

- › Push the cover cap onto the wheel bolt to the stop.

## Full wheel frame

### Removing and installing the trim

Applies to factory built or original accessory trims from ŠKODA.

#### Disconnecting

- › Hang the clamps for removing the wheel trims at the edge of one of the openings in the trim.
- › Push the wheel wrench through the clamp, support on the tyre and pull off the wheel trim.

#### Installing

- › Press the wheel trim onto the wheel rim at the designated valve opening.

When using an anti-theft wheel bolt, it must be located at the location indicated on the bezel.

- › Press the trim, starting at the valve, into the rim on both sides until it engages around the entire circumference.

#### NOTICE

- ▶ Use hand pressure, do not hit the wheel cover.



## Storage space and interior equipment

### Equipment in the boot

#### Overview

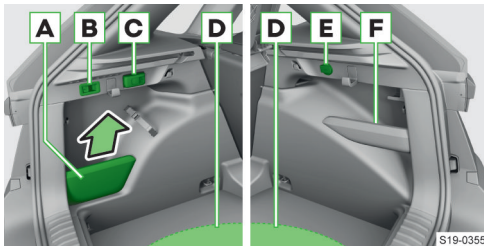

- A** Storage tray  
Max. load 2.5 kg  
The partition wall of the storage compartment on vehicles with the variable loading floor cannot be removed.
- B** Trailer hitch switch
- C** Removable light
- D** Storage compartment for spare or emergency wheel and vehicle tools
- E** 12 volt socket
- F** Storage tray  
Max. load 1.5 kg

### Emergency equipment

#### Overview of the emergency equipment

##### Emergency equipment in the luggage compartment

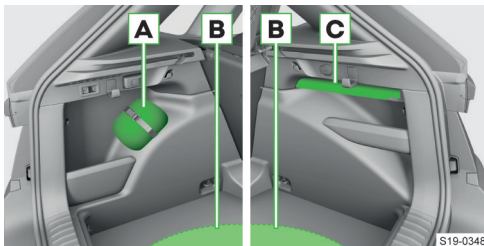

- A** Placing the first-aid kit
- B** Tool kit
- C** Placing of the warning triangle

##### Storage compartment for the reflective vest

The storage compartment for the reflective vest is in the storage compartment of the front door.

#### Fire extinguisher under the passenger seat



#### Tool kit

Depending on the equipment, not all of the following components may be included in the tool kit.

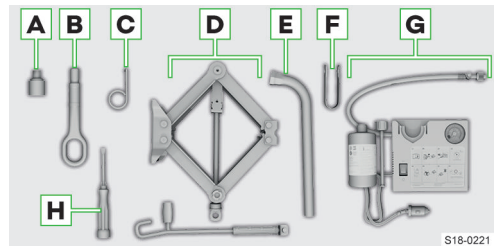

- A** Attachment for the anti-theft wheel bolts
- B** Towing eye
- C** Bracket for removing the full wheel covers
- D** Jack with sign and crank
- E** Wheel wrench
- F** Removal clip for the wheel bolt cover caps
- G** Breakdown kit
- H** Screwdriver

The declaration of conformity is enclosed with the jack or the logbook folder.

### Fasteners in the boot

#### Overview

##### Vehicle without variable loading floor

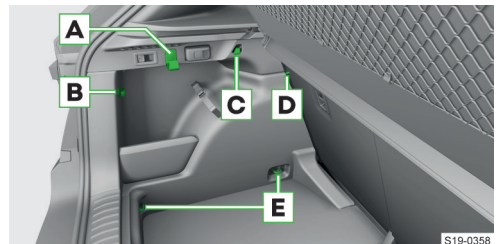

- A** Bag hooks

Max. load 7.5 kg

- B** Fasteners for securing the fastening nets
- C** Hook for securing the storage bag  
Max. load 1.5 kg
- D** Lashing eyes for securing the fixing nets and the storage bag
- E** Lashing eyes for securing the load and the fastening nets  
Max. load 350 kg

**Vehicle with variable loading floor**

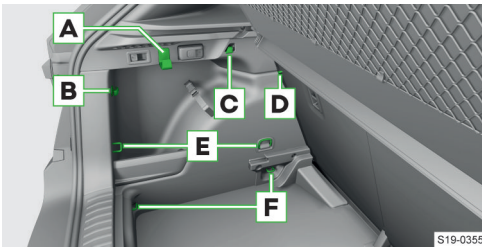

- A** Bag hooks  
Max. load 7.5 kg
- B** Fasteners for securing the fastening nets
- C** Hook for securing the storage bag  
Max. load 1.5 kg
- D** Lashing eyes for securing the fixing nets and the storage bag
- E** Lashing eyes for securing the load and the fastening nets  
Max. load 350 kg
- F** Lashing eyes for securing the load and the fastening nets  
Max. load 350 kg

**Other fasteners**

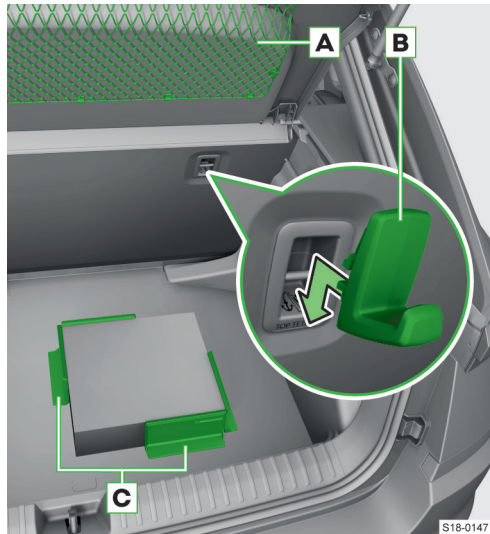

- A** Net on the luggage compartment cover  
Max. load 1.5 kg
- B** Hook for securing the load to the eyelet of the TOP TETHER system  
Max. load 5 kg
- C** Cargo elements  
Max. load 8 kg  
A storage compartment for the cargo elements is located under the floor covering in the luggage compartment.  
› Fold up the cargo element and fasten it to the floor covering in the luggage compartment.

**Fastening nets**

**Overview**

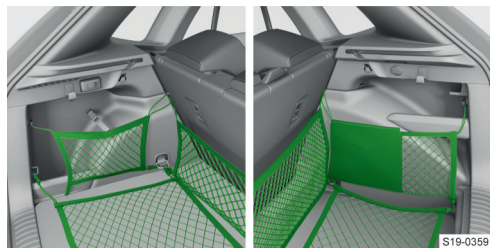

- I** The side net has a lockable storage bag.  
The maximum load of the lockable storage bags is 0.5 kg.  
The maximum load of the fastening net with the lockable storage bag is 0.5 kg.

The maximum load of the other fastening nets is 1.5 kg.

## Storage pocket

### Suspension

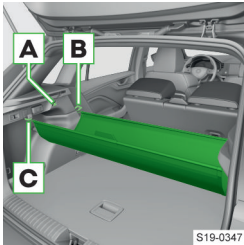

› The storage bag at the attachment points **A**, **B** or **C** is hung.

The maximum load of the other fastening nets is 3.5 kg.

## Net partition

### Attach the net partition

#### Attach at the back

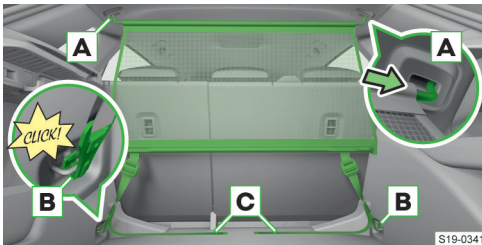

- › Place the crossbar in the supports **A**.
- › Snap the carabiners **B** into the lashing eyes.
- › Pull the straps firmly at the free ends **C**.

#### Fasten in the front

The procedure is analogous to the process behind.

The lashing eyes for the carabiner are located under the central body pillars.

#### Releasing

Loosening takes place in the reverse order for fixing.

## Double-sided floor covering

### Overview

Depending on the equipment, the vehicle may be equipped with a double-sided floor covering in the luggage compartment. One side is made of fabric, the other side is washable.

## Removable light

### Overview

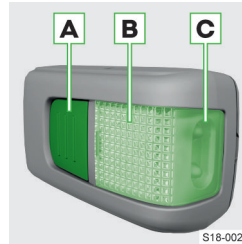

- A** Button for switching on and off
- B** Light (lights up when the light is in the bracket and the boot lid is open)
- C** Light (lights up when the light is outside the bracket)

**I** The batteries in the light are charged while the engine is running. A full charge of the batteries takes about 3 hours.

### Remove and insert

#### ⓘ NOTICE

› Protect the light from moisture.

#### Removing

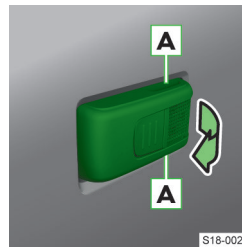

› Grasp the light in area **A** and swivel it out.

**I** Thanks to the integrated magnets, the light can be attached, for example, to the vehicle body.

#### Inserting

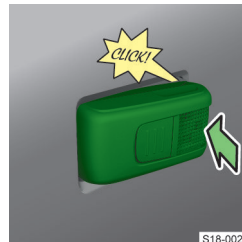

› Insertion takes place in reverse order.

### Replace batteries



- › Pry off the cover with a narrow, pointed object in the area of the arrow.
- › Replace the batteries.
- › Fit the cover and click into place.

**ⓘ NOTICE**

New batteries must comply with the specifications of the original battery.

### Rigid boot cover

#### Remove and insert

The maximum load of the other fastening nets is 1 kg.

#### Removing

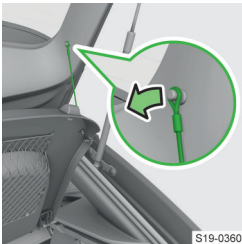

- › Unhook the straps.

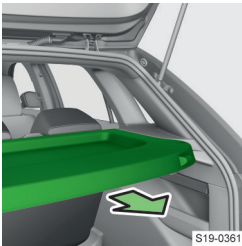

Remove the cover by pulling it quickly.  
The cover is released by slowly pulling on the floor of the boot.

#### Inserting

- › Insert the cover until it clicks into place.
- › Hook in the retaining straps.

### Store the cover behind the rear seats



- › Hook the cover behind the rear seats.

### Variable loading floor in the boot

#### Setting the position

The maximum load of the variable loading floor is 75 kg.

#### Set the variable loading floor to the upper or lower position



- › Lift the variable load floor and pull it towards you.

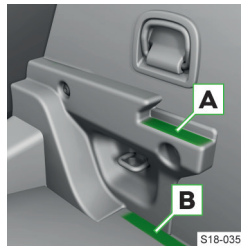

- › To set in the upper position, position the variable loading floor in the front area on area **A**.
- › To set in the lower position, position the variable loading floor in the front area on space **B**.



- › Press the variable loading floor forward and hang up.

**Fasten the raised variable loading floor in the upper position**



- › Secure the raised variable loading floor with the help of hinged corners in areas **A**.

**Remove and insert**

- › Lift the variable loading floor up to a distance of about 15 cm below the luggage compartment cover and then remove it.
- › Insertion takes place in reverse order.

**Overview of passenger compartment**

**Overview of practical equipment in the front**

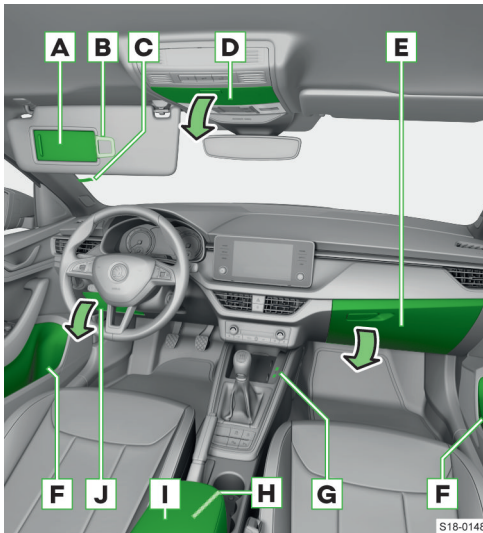

- A** Make up mirror
- B** Ticket holder
- C** Ticket holder
- D** Spectacles compartment  
Max. load 0.25 kg  
› To open, press the button.
- E** Storage compartment with air outlet nozzle  
Max. load 3 kg  
› Pull the handle to open the compartment.
- F** Storage tray  
▶ Bottle holder with a capacity of max. 1.5 l  
▶ Storage compartment for the waste container  
▶ Storage compartment for the reflective vest
- G** USB connections  
The USB connection can be used for charging and for data transfer.
- H** 12 volt socket
- I** Openable and adjustable armrest with storage compartment  
In the lower part of the armrest, there is a card holder.  
› Pull the handle to open the compartment.
- J** Storage tray  
Max. load 0.5 kg  
› Pull on the handle to open.

- › Turn the knob to position to open the air outlet nozzle.

- F** Storage tray  
▶ Bottle holder with a capacity of max. 1.5 l  
▶ Storage compartment for the waste container  
▶ Storage compartment for the reflective vest
- G** USB connections  
The USB connection can be used for charging and for data transfer.
- H** 12 volt socket
- I** Openable and adjustable armrest with storage compartment  
In the lower part of the armrest, there is a card holder.  
› Pull the handle to open the compartment.
- J** Storage tray  
Max. load 0.5 kg  
› Pull on the handle to open.

**NOTICE**

- ▶ Do not leave heat-sensitive objects behind in the glasses compartment **D**.

**Overview of the practical equipment in the rear**

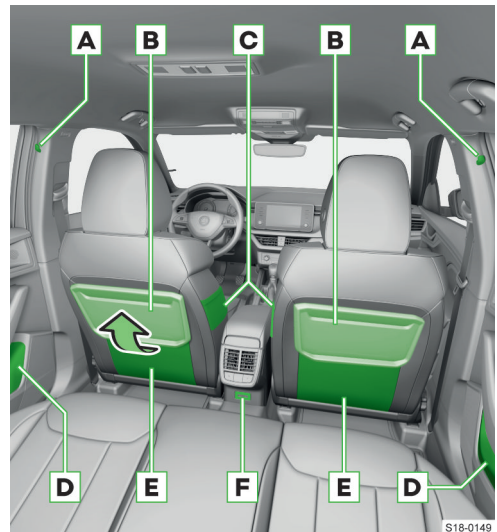

- A** Coat hook  
Max. load 2 kg
- B** Folding table
- C** Storage pocket
- D** Storage tray



- ▶ Bottle holder with a capacity of max. 0.5 l
- ▶ Storage compartment for the reflective vest

**E** Storage pocket

**F** USB connections

The USB connection is for charging only.

## Storage compartment under the front seat

### Opening the storage compartment

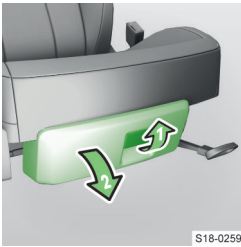

The maximum permissible load for storage compartment is 1.5 kg.

S18-0259

## Storage compartment for an umbrella

### Overview



S18-0260

## Phonebox

### What you should be mindful of

#### ⚠ CAUTION

Risk of burns during charging.

- ▶ The phone may get warm, remove it carefully from the storage compartment.
- ▶ Do not leave any metal objects in the compartment under the phone. If there is a metallic object in the storage compartment, which has become hot, remove the phone and let it cool down in the storage compartment!

### Functionality

#### Functions of the Phonebox

- ▶ Wireless charging of phones.

- ▶ Amplification of the telephone signal (only valid for some countries).

The Phonebox is located in the storage compartment in the centre console at the front.

Insert a telephone with a maximum size of 160x80 mm into the storage compartment.

#### Charging Indicator

The state of charge is indicated by the colour of the  $\Phi$  symbol in the status bar on the Infotainment screen.

- ▶ White - the phone is in the storage compartment, is detected and is charging.
- ▶ Grey - the phone is not in the storage compartment/does not support wireless charging/is fully charged.
- ▶ Red - the phone is in the storage compartment, is detected, but cannot be charged.
- ▶ No icon displayed - the function is not available.

#### Recommendations for optimal function

- ✓ The phone is positioned with the screen facing up.
- ✓ The protective cover of the phone is removed.
- ✓ The phone is centred on the phone icon on the pad.

### Operating conditions

#### Conditions for wireless charging

- ✓ Ignition is switched on.
- ✓ The phone supports the Qi standard.
- ✓ There is no object between the pad and the phone.

### Troubleshooting

A message has been displayed on the Infotainment screen indicating that the mobile phone cannot be charged.

- ▶ Check that there is no object between the pad and the phone to be charged. If this is the case, remove the phone and the item. Place the phone centrally on the phone symbol on the pad again.
- ▶ Check that the position of the phone to be charged has not changed. If this is the case, remove the phone and put it back in the centre of the phone symbol on the pad.

## Cup holder

### Overview

#### Front cup holder



S18-0371

In the front holder area, a bottle can be opened with one hand.

- ▶ Press the bottle into the holder and unscrew the cap.

#### Rear cup holder



S18-0257

#### ⚠ CAUTION

Risk of scalding!

- ▶ Never put hot beverage containers in the cup holder.

#### ⓘ NOTICE

Risk of damage to the electrical system and to the panels due to spilled drinks.

## Multimedia holder

### Overview

The multimedia holder is inserted in the cup holder.

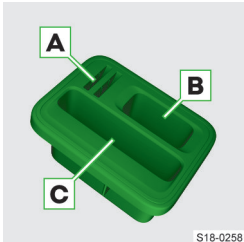

S18-0258

- A** Storage compartment for coins
- B** Storage compartment for the vehicle key
- C** Storage compartment for a mobile phone

## Waste container

### Replace bags

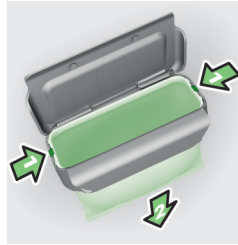

S18-0255

## Ashtray and cigarette lighter

### What you should be mindful of

#### ⚠ CAUTION

Risk of burning or fire!

- ▶ Do not use the ashtray for storing hot or burning objects.
- ▶ Handle the lighter carefully.

### Operation

The ashtray is inserted in the cup holder.

#### Open the ashtray

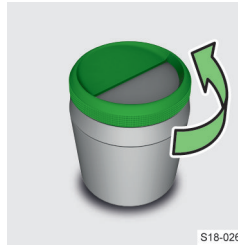

S18-0264

#### Remove the lid



S18-0265

### Cigarette lighter

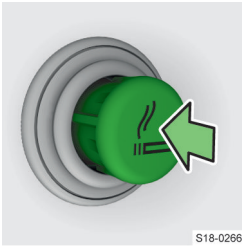

- › Push in the lighter.
- › Wait until the glowing lighter pops back out.
- › Remove the lighter and use.
- › Push the lighter back in.

The socket of the cigarette lighter serves as a 12 V socket.

### 12-Volt power socket

#### Operating conditions

ⓘ **NOTICE**

Risk of damage to the electrical system of the vehicle!

- ▶ Use the sockets only for the connection of approved electrical accessories with a total power consumption of up to 120 watts.

ⓘ **NOTICE**

Danger of damage to the connected consumers!

- ▶ Switch off the consumers before switching the ignition on or off and before starting the engine.

### Folding table

#### Operation

##### Fold up the table



- › Fold the table up to the desired position.

##### Unfold the table

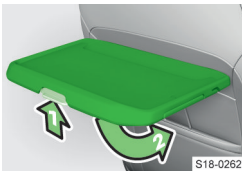

- › Press the safety button and unfold the table.

##### Slide out the cup holder

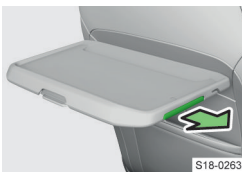

The maximum load for the table is 8.5 kg.

⚠ **CAUTION**

Risk of injury!

- ▶ During the trip the table must be in folded-down.



## Roof rack and hitch

### Roof rack

#### Overview

The maximum weight of the load incl. roof rack is 75 kg.

### Swivelling hitch

#### What you should be mindful of

##### ⚠ WARNING

Risk of an accident!

- ▶ Do not manipulate the switch for swinging the tow bar in and out while a trailer or another accessory is coupled to the tow bar. The tow bar could be unlocked.

##### ⚠ CAUTION

Risk of injury!

- ▶ Handle the trailer coupling carefully.
- ▶ When swinging out the tow bar, do not stand in the middle area of the rear bumper.

##### ⓘ NOTICE

Risk of damage to the trailer coupling!

- ▶ When not using the towing device, swing the tow bar under the bumper.

#### Tow bar: swivel out/in

##### Swing out the tow bar



S18-0296

- ▶ Pull on the switch. The tow bar swings out. The indicator light → inside the switch illuminates.



S18-0297

- ▶ Press the tow bar until it audibly clicks into place.

**Check latching:** the indicator light → within the switch lights up.

##### Swivel tow bar

##### ⓘ NOTICE

- ▶ No trailer or any other accessory can be connected to the tow bar.
- ▶ A socket or adapter may not be plugged into the socket.



S18-0296

- ▶ Pull on the switch. The tow bar is unlocked. The indicator light → inside the switch illuminates.



S18-0298

- ▶ Swing in the tow bar under the bumper until it audibly clicks into place.

**Check latching:** the indicator light → within the switch lights up.

#### Couple or unhitch trailer or accessory

The following information describes the procedure for coupling and uncoupling a trailer. The information also refers to another accessory, e.g. a bike carrier.

##### ⚠ WARNING

Risk of an accident!

- ▶ Do not use the safety eye for towing.
- ▶ Distribute and fix the load correctly.

ⓘ The trailer has a 13-pin electrical socket. If the trailer have a 7-pin connector, use a corresponding adapter from the ŠKODA Original Accessories.

##### Coupling

- ▶ Swing out the tow bar.
- ▶ Put the trailer drawbar onto the ball head.

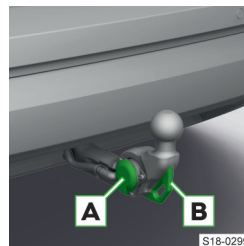

S18-0299

- ▶ Plug the electrical trailer plug into the socket **A**.
- ▶ Hook the tear-off rope of the trailer onto the safety eye **B**. The tear-off rope must sag against the vehicle in all trailer positions.

##### Uncoupling

Uncoupling takes place in reverse order.

### Power supply of the trailer power network

In the electrical connection between the vehicle and trailer, the trailer is powered by the vehicle.

#### ⓘ NOTICE

Risk of damage to the vehicle electronics!

The total power consumption of all consumers connected to the trailer power supply must not exceed 350 watts.

### Troubleshooting

#### Trailer coupling error

The indicator light → inside the switch does not light up or flash, or the tow bar does not lock into place.

- › Do not use the trailer coupling.
- › Seek the help of a specialist garage.

#### Tow bar not locked

 illuminates

- › Engage the tow bar.

### Technical data

#### Maximum vertical load for trailer operation

The maximum vertical load for trailer operation depends on the engine type and the vehicle equipment.

The valid specification for your vehicle can be found in the technical vehicle documentation, (e.g. vehicle approval documentation, COC document) or at a ŠKODA partner.

Other information (e.g. on the nameplate of the trailer device) merely provides information on the test values of the device.

#### Support load with mounted accessories

When using the accessories (e.g. bicycle carrier), the maximum length and the permissible total weight including load must be considered.

The maximum length of the mounted accessories (from the ball of the towing device) may not exceed 70 cm.

The permissible total weight of the installed accessory, including its load, corresponds to the maximum load on trailers.

This value applies if the centre of gravity is at a distance of no more than 30 cm from the towing device ball head.

If the distance of the centre gravity of the load to the ball head of the towing device is greater than 30 cm, then the max. permissible total weight of the accessory, including its load, decreases (e.g. at a distance of 60 cm from the ball head, the permissible weight decreases by half).

#### ⚠ WARNING

Risk of an accident!

- ▶ Do not exceed the maximum vertical load.
- ▶ The permissible trailer load and the weight of another accessory, e.g. of the bike carrier, is not to be exceeded.

#### ⓘ NOTICE

Risk of damage to the trailer and the vehicle itself!

- ▶ When using the accessory (e.g. bicycle carrier), observe the maximum length and the permissible total weight of the accessory incl.

## Maintaining and cleaning

### Service events

#### Service intervals

Compliance with service intervals is crucial for the life and value of the vehicle.

You will be notified about a due service appointment by the symbol  and the corresponding message in the instrument cluster display.

The specialist garage will inform you of the type of service interval, the option of changing this and the scope of service.

**I** All services and the replacement or refilling of operating fluids are chargeable to the customer, even during the warranty period, unless the ŠKODA AUTO warranty conditions or other binding agreements determine otherwise.

#### Proof of service

A specialist garage stores the proof of service in the information system called Digital Service Plan.



The proof of service can be printed out.

#### Show service appointment

In Infotainment, select the following menu.

**CAR** >  > Service

Or:

**MENU** >  >  > Service

#### Resetting information

We recommend that you do not reset the information regarding service events on your own. It can lead to incorrect setting of the service intervals and thus also to possible faults in the vehicle.

For vehicles with a variable service interval, new service interval values calculated according to the previous operating conditions will be displayed after the oil change service indicator is reset. These values will then continue to be adjusted according to the current operating conditions.

### Service work, adjustments and technical changes

The instructions and guidelines from ŠKODA AUTO must be observed when carrying out any modifications, repairs or technical alterations to the vehicle.

Adhering to these instructions and guidelines helps ensure road safety and helps keep the vehicle in a good technical condition.

We advise only using ŠKODA Original Accessories and ŠKODA Original Parts which have been expressly approved for use on your vehicle. Reliability, safety

and suitability for your vehicle are guaranteed with these.

#### ŠKODA Service Partner

All ŠKODA Service Partners operate according to the most recent guidelines and instructions from ŠKODA AUTO. Service and repair work is therefore carried out on time and at the appropriate quality. Adhering to these instructions and guidelines helps ensure road safety and helps keep the vehicle in a good technical condition.

We therefore advise having all modifications, repairs and technical alterations to the vehicle carried out by a ŠKODA Service Partner.

#### ŠKODA original parts

We recommend the use of ŠKODA Original Parts for your vehicle, as these parts are approved by ŠKODA AUTO. These parts correspond exactly to the ŠKODA AUTO regulations and are identical to the parts used in series production.

ŠKODA AUTO is able to warrant the safety, suitability, and long life of these products.

ŠKODA Service Partners are liable for any defects of ŠKODA Genuine Parts for a period of 2 years after sale in accordance with the materials defect liability, unless agreed otherwise in the purchase agreement.

#### ŠKODA original accessories

We recommend that you use ŠKODA Genuine Accessories in your vehicle. With these accessories, ŠKODA AUTO stands for safety, reliability and the suitability for your vehicle type.

ŠKODA Service Partners are liable for any defects of ŠKODA Genuine Accessories for a period of 2 years after installation or delivery in accordance with the materials defect liability, unless agreed otherwise in the purchase agreement or any other agreements.

#### Spoiler

##### WARNING

Risk of an accident!

- ▶ Only use the original spoiler on the front bumper in combination with the original spoiler on the boot lid.
- ▶ The original spoiler on the front bumper cannot be left on its own without the spoiler on the luggage compartment lid or in combination with an unsuitable spoiler on the luggage compartment lid.
- ▶ We recommend that you consult the ŠKODA Service Partner for any repairs to or replacement, addition or removal of spoilers.

#### Component protection

Some electronic vehicle components (such as the instrument cluster) are factory-equipped with component protection. This component protection ensures the functional limitation of these components in a

non-legitimate installation in another vehicle (e.g. after a theft) or operation outside the vehicle.

## Interior

### What you should be mindful of

#### ① NOTICE

- ▶ Use cleaning agents intended for cleaning and care of the individual materials.
- ▶ Do not use aggressive cleaning agents or chemical solvents.

#### Natural leather / Faux leather / Alcantara® suede / material

#### ① NOTICE

- ▶ Remove impurities as soon as possible.
- ▶ Do not use solvents, floor wax, shoe cream, stain remover or similar agents on Alcantara® suede seat upholstery.
- ▶ Make sure that natural leather is not moistened when cleaning and that no water seeps into the seams.
- ▶ Do not clean the roof cladding with a brush.

#### ① NOTICE

- Risk of fading to the cover fabric.
- ▶ If necessary, do not leave the covers for long periods in the blazing sun.

#### ⓘ

- ▶ During use, the leather and Alcantara® and suede materials may show minor changes (e.g. folds, discoloration).
- ▶ Some clothing fabrics, e.g. dark denim, sometimes do not have sufficient colour fastness. As a result, discoloration that is clearly visible on the seat upholstery can occur. This is not a defect in the fabric.
- ▶ Sharp-edged zippers, rivets, clamps and similar garments can damage the upholstery in the vehicle. Such damages cannot be subsequently recognised as a justified complaint.

#### Plastic parts

#### ① NOTICE

- Risk of damaging the dash panel.
- ▶ Do not attach fragrances and air fresheners to the dash panel.

#### Windows

#### ① NOTICE

- Risk of damage to the filaments or the glass antenna.
- ▶ Do not stick stickers on the heating filaments.

#### Covers of electrically heated seats

#### ① NOTICE

- Risk of damaging the heating system.

- ▶ Do not clean the seats with water or other liquids.
- ▶ Do not dry the seats by switching on the heating.

#### Seat belts

#### ① NOTICE

- Risk of damage to the seat belts.
- ▶ Do not dry clean the seat belts.
  - ▶ Allow cleaned belts to dry before rolling up.

### Instructions for cleaning

#### Natural leather / Faux leather / Alcantara® suede / material

- ▶ Remove dust and dirt on the surface with a vacuum cleaner.
- ▶ Remove fresh impurities with water, slightly moistened cotton cloth or woolen cloth; if necessary, use a mild soap solution and wipe with a dry cloth.
- ▶ Remove stubborn stains with a suitable cleaning agent.
- ▶ For regular care of natural leather, use the equipment provided for this purpose. After each clean, use a care cream with light protection and impregnation effect.
- ▶ When looking after Alcantara®, remove stubborn hair from suede and fabric surfaces with a cleaning brush. Remove pills from materials with a brush.

#### Plastic parts

- ▶ Remove impurities with water, slightly moistened cloth or sponge with a suitable cleaning agent if necessary.

#### Windows

- ▶ Remove impurities with clean water and dry with a cloth provided for this purpose.

#### Covers of electrically heated seats

- ▶ Remove impurities with a suitable cleaning agent.

#### Seat belts

- ▶ Remove impurities with a soft cloth and mild soap solution.

## Exterior

### What you should be mindful of

#### ⚠ WARNING

Risk of an accident!

- After washing the vehicle, the functionality of the brake system may be affected by moisture and, in winter, by ice.
- ▶ Dry and clean the brakes by braking several times.

**① NOTICE**

- ▶ Bird droppings, insect residues, litter and sea salt residues, overflowed fuel, AdBlue® etc. are to be removed as soon as possible.
- ▶ Do not use rough sponges, scourers or similar to remove dirt.
- ▶ Use cleaning agents intended for cleaning and care of the individual materials.
- ▶ Do not use aggressive cleaning agents or chemical solvents.
- ▶ Do not polish the vehicle in a dusty environment.

**① NOTICE**

AdBlue® picks up some materials, e.g. paint and plastics.

- ▶ Clean the affected area with a damp cloth and cold water.
- ▶ Remove any dried solution with warm water and a sponge.

**① NOTICE**

- ▶ Paint damage should be repaired as soon as possible.
- ▶ Do not treat painted parts with or hard waxes.
- ▶ Do not polish panels.
- ▶ Door seals and window guides must not be treated with anything. Exempted from this are products that are ŠKODA Original accessories. These ensure that the protective lacquer layer of the seals and window guides is not attacked.
- ▶ Do not use abrasive cleaners to clean the reversing camera.

**Before driving through a car wash**

- › Observe the usual specifications of the car wash, e.g. close all windows, fold the mirrors, etc.
- › Move the windscreen wiper lever to position **OFF** to adjust.
- › If there are special attachments on your vehicle, observe the instructions of the car wash operator.

**① NOTICE**

In vehicles with an electric boot lid, this can open automatically due to the pressure of the washing brushes.

- ▶ Lock the vehicle, e.g. with the central lock button.

**After washing with a wax preservation**

- › Wipe off the windscreen wiper blades with a dry cloth.

**Wash with a pressure washer****① NOTICE**

- ▶ Follow the operating instructions for the high-pressure cleaner. This particularly applies to information with respect to the pressure and spray distance from the vehicle surface.
- ▶ Do not direct the water jet directly at the following vehicle parts.

- ▶ Foils.
- ▶ Locks.
- ▶ Columns on the vehicle.
- ▶ Trailer connection.
- ▶ Swivelling ball bar.
- ▶ Sensors.
- ▶ Camera lenses.
- ▶ Plastic, chromed and anodised parts.

**Remove snow and ice****① NOTICE**

- ▶ Remove snow and ice with a plastic scraper or a suitable deicing agent.
- ▶ Clean the cameras with a hand brush.
- ▶ Only move the scraper in one direction.
- ▶ Do not use scratchers or other sharp objects for foils.
- ▶ Do not remove snow and ice with hot or warm water.
- ▶ Do not remove snow and ice from surfaces with coarse dirt.

**Instructions for cleaning****Handwash**

- › Wash the vehicle from top to bottom with a soft sponge or wash glove and plenty of water, if necessary with additional suitable cleaning agents.
- › For foils and headlights, use a mild soap solution that contains two tablespoons of white neutral soap to one litre of lukewarm water.
- › Use a glass cleaner for the windscreen wiper blades.
- › Wash the cameras with clean water and dry with a suitable clean wipe.

**① NOTICE**

- ▶ Wash out the sponge or wash mitt regularly.
- ▶ Use a different sponge for wheels, sills and the lower part of the vehicle than that used for the other vehicle parts.
- ▶ Do not wash the vehicle in the blazing sun.
- ▶ Do not dry the headlights or use sharp objects.
- ▶ Do not put pressure on the bodywork when washing.
- ▶ The temperature of the washing water may be a max. 60 °C.

**After hand washing**

- › Rinse the vehicle and wipe it with a suitable clean cloth.

**Vehicle paint**

- › Preserve the varnish at least twice a year with hard wax.
- › Use a polish for matt lacquers.

**Foils**

Films will age and become brittle – this is entirely normal: this is not an error.

The following factors have a negative effect on the life or colour fastness of the films.

- ▶ Sun rays.
- ▶ Moisture.
- ▶ Air pollution.
- ▶ Stones, e.g. the rebound of the cargo during transport on the roof rack.

**Protection of hollow spaces**

Corrosion-prone cavities of the vehicle are permanently protected by preservative wax at the factory.

- › Remove spilled wax with a plastic scraper, clean stains with mineral spirits.

**Underbody protection**

The underside is permanently protected by the factory against chemical and mechanical influences.

- › Have the protective coating checked by a specialist garage before starting and at the end of the cold season.

**Wheels**

- › After washing, preserve the wheels with suitable means.

ⓘ **NOTICE**

Severe dirt on the wheels can result in the wheels unbalancing.

**Car jack**

- › If necessary, treat moving parts with suitable grease.

**Trailer towing coupling**

- › Coat the ball head of the towing device with a suitable grease whenever necessary.

**Technical data and specifications**

**Requirements for the technical data**

The emission standard, information on fuel consumption and other information pertaining to your vehicle can be found listed in the technical vehicle documentation and in the declaration of conformity, in the so-called COC Document. The information can also be requested from a ŠKODA partner.

The declaration of conformity can be obtained from a ŠKODA partner.

The details in the technical vehicle documentation take precedence over the information in this Owner's Manual.

The listed performance values were determined without performance-reducing equipment, e.g. air conditioning system.

The values listed are for the basic model without any optional equipment. The values have been determined in accordance with the rules and conditions specified in statutory or technical regulations for determining operational and technical data for motor vehicles.

**Vehicle identification data**

**Vehicle Identification Number (VIN)**

The vehicle identification number is found at the following locations.

- ▶ Directly in the engine compartment on the suspension turret.
- ▶ On a plate under the wind shield in the lower left corner.
- ▶ On the rating plate at the bottom of the middle body pillar on the right side of the vehicle.



S18-0344

Type plate.

- A** Vehicle manufacturers
- B** Vehicle Identification Number (VIN)

The display of the VIN takes place in the infotainment in the following menu item.

**CAR** > > Service

Or:

MENU > > > Service

### Engine number

The engine number is embossed in the engine block.

## Maximum permissible weights

The maximum permissible weights are listed on the nameplate.

The type plate is located at the bottom of the middle body pillar on the right side of the vehicle.

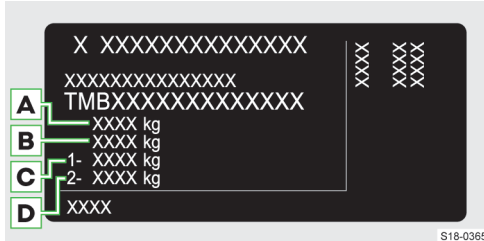

- A** Maximum permissible gross weight
- B** Maximum permissible towed weight (towing vehicle and trailer)
- C** Maximum permissible front axle load
- D** Maximum permissible rear axle load

### Maximum permissible towed weight

The specified value is valid for altitudes up to 1000 m above sea level.

The engine output falls as altitude increases, as does the vehicle's climbing power.

Therefore, for every additional 1,000 m in height (or part), the maximum permissible towed weight must be reduced by 10 %.

The towed weight is made up of the actual weights of the loaded towing vehicle and the loaded trailer.

### Payloads

It is possible to calculate the approximate maximum payload from the difference between the permissible total weight and the operating weight.

The payload consists of the following weights.

- ▶ The weight of the passengers.
- ▶ The weight of all items of luggage and other loads.
- ▶ The weight of the roof load including the roof rack system.
- ▶ The weight of the equipment that is excluded from the operating weight.
- ▶ Trailer bearing load for trailer towing » [page 160](#).

### ⚠ WARNING

Risk of accident and danger of vehicle damage!

- ▶ Do not exceed the specified values for the maximum permissible weights.

## Operating weight

### Information about the operating weight

The specification corresponds to the lowest possible operating weight without additional weight-increasing equipment. This includes 75 kg driver's weight, the weight of the operating fluids and the on-board tool kit and a fuel tank filled to min. 90%.

## Operating weight - Kamiq

Engine type	Transmission	Operating weight (kg)
1.0 l/70 kW TSI	Manual gearbox	- a)
1.0 l/85 kW TSI	Manual gearbox	1231
	DSG <sup>b)</sup>	- a)
1.5 l/110 kW TSI	Manual gearbox	- a)
	DSG <sup>b)</sup>	- a)
1.6 l/85 kW TDI CR	Manual gearbox	1336
	DSG <sup>b)</sup>	1364

<sup>a)</sup> The values were not available at the time of going to press.

<sup>b)</sup> Automatic dual-clutch transmission.

**i** Ask about the exact vehicle weight in a specialist garage.

## Vehicle dimensions

### Dimensions

Specification	Value (in mm)
Vehicle height	1531
Vehicle width with folded-in mirrors	1793
Vehicle width with folded-out mirrors	1988
Ground clearance of the vehicle	182
Vehicle length	4241

### Engine specifications

- ▶ 1.0 I/85 kW TSI » page 166.
- ▶ 1.5 I/110 kW TSI » page 167.
- ▶ 1.6 I/85 kW TDI CR » page 167.

### Overview

- ▶ 1.0 I/70 kW TSI » page 166.

#### 1.0 I/70 kW TSI engine

Power (kW at 1/min)	70/5000-5500	
Highest torque (Nm at 1/min)	175/2000-3500	
Number of cylinders/displacement (cm <sup>3</sup> )	3/999	
Transmission	Manual gearbox	
Maximum speed (km/h)	- a)	
With specified gear engaged	- a)	
Acceleration 0-100 km/h (s)	- a)	
a) The values were not available at the time of going to press.		

#### 1.0 I/85 kW TSI engine

Power (kW at 1/min)	85/5000-5500	
Highest torque (Nm at 1/min)	200/2000-3500	
Number of cylinders/displacement (cm <sup>3</sup> )	3/999	
Transmission	Manual gearbox	DSG <sup>a)</sup>
Maximum speed (km/h)	194	- b)
With specified gear engaged	5	- b)
Acceleration 0-100 km/h (s)	9.9	- b)
a) Automatic dual-clutch transmission.		
b) The values were not available at the time of going to press.		



### 1.5 l/110 kW TSI engine

Power (kW at 1/min)	110/5000-6000	
Highest torque (Nm at 1/min)	250/1500-3500	
Number of cylinders/displacement (cm <sup>3</sup> )	4/1498	
Transmission	Manual gearbox	DSG <sup>a)</sup>
Maximum speed (km/h)	- b)	- b)
With specified gear engaged	- b)	- b)
Acceleration 0-100 km/h (s)	- b)	- b)
<sup>a)</sup> Automatic dual-clutch transmission.		
<sup>b)</sup> The values were not available at the time of going to press.		

### 1.6 l/85 kW TDI CR engine

Power (kW at 1/min)	85/3250-4000	
Highest torque (Nm at 1/min)	250/1500-3250	
Number of cylinders/displacement (cm <sup>3</sup> )	4/1598	
Transmission	Manual gearbox	DSG <sup>a)</sup>
Maximum speed (km/h)	193	192
With specified gear engaged	6	7
Acceleration 0-100 km/h (s)	10.2	10.4
<sup>a)</sup> Automatic dual-clutch transmission.		

## Event Data Recorder

The vehicle is equipped with a device that acts as an event data recorder (hereinafter referred to solely as "EDR"). The main purpose of the EDR is to record data during a traffic accident or other exceptional traffic situation (hereinafter referred to solely as "accident") during which the restraint systems are activated.

The EDR records the accident in a short time (approximately 10 seconds), including the following information, for example:

- ▶ The function of certain systems in the vehicle.
- ▶ The seat belt status of the driver and front passenger.
- ▶ The actuation of the brake and accelerator pedals.
- ▶ The speed of the vehicle at the time of the accident.

The recorded data helps with the analysis of how the vehicle systems were behaving shortly before, during and shortly after the accident, thereby ensuring better information regarding the circumstances under which the accident occurred, resulting in material damage and possibly personal injury.

The data relating to assist systems in the vehicle is then also recorded. In addition to the information on whether the affected systems were switched on or off at the relevant time, whether these were only

partially available or were inactive, it is also possible to track whether these vehicle functions controlled, accelerated or braked the vehicle during the accident. Depending on the equipment, these functions are, e.g:

- ▶ Adaptive Cruise Control (ACC).
- ▶ Lane Assist.
- ▶ Park Assist.
- ▶ Emergency brake function (Front Assist).

EDR data is only recorded if an accident causes the restraint systems to be activated. Under normal driving conditions no data is recorded and there is no audio or video recording of the vehicle interior or the vehicle environment. Personal data such as name, gender, age or location at which the accident occurred is also not stored in the EDR. However, third parties such as law enforcement authorities may use certain resources to connect EDR content to other data sources, and therefore deduce the identification of some of the people involved in the accident when investigating the causes of the accident.

Reading out the EDR data requires special equipment with specific access authorisation, a legally prescribed diagnostic connection in the vehicle ("on-board diagnostics") and the ignition to be switched on.

ŠKODA AUTO will not read or otherwise process any accident data from the EDR without the approval of

the vehicle owner or other person authorised for use of the vehicle. Exceptions are specified in the contractual arrangements, or are subject to generally binding regulations.

Due to legal requirements, ŠKODA AUTO is required to monitor the quality and safety of its products, meaning that it is only entitled to use data from the EDR to monitor the product on the market, for further research and development, and to improve the quality of the vehicle's safety systems. For the purpose of research and development, ŠKODA AUTO will also make data available to third parties. This is done exclusively in anonymous form, i.e. without any connection to the specific vehicle, the vehicle owner or any other authorised user.

### Information about the radio systems in the vehicle

Your vehicle has various radio systems.

Manufacturers of this radio equipment declare that this equipment complies with the requirements of **Directive 2014/53 / EU** and the **Technical Regulation on Radio Equipment, approved by the Decision of the Cabinet of Ministers of Ukraine of 25 May 2017 no. 355**.



To display information about **Directive 2014/53 / EU** on the approximation of the laws of the Member States relating to the marketing of radio equipment, **Technical regulation on radio equipment, approved by the decision of the Cabinet of Ministers of Ukraine of May 25, 2017 No. 355** as well as regarding **declaration of conformity**, proceed as follows.

1. Import the QR code or enter the following address in the web browser.  
<http://go.skoda.eu/owners-manuals>
2. Click on "Choose your manual".
3. Select the desired model - a menu with the instructions will be displayed.
4. Select the construction period and the language.
5. Choose the **Information on Directive 2014/53 / EU** or **Information on the Technical Regulations on Radio Systems No. 355** file in PDF format.

### Rights arising from defective performance, ŠKODA Warranty for new cars, ŠKODA Mobility Warranty and Optional ŠKODA Extended Warranty

#### Rights arising from defective performance

Your ŠKODA Partner, as a seller, is liable to you for material defects in your new ŠKODA vehicle, ŠKODA Genuine Parts and ŠKODA Genuine Accessories, in accordance with the legal requirements and the purchase contract.

The buyer is entitled to assert the rights arising from defective performance with the responsible ŠKODA partner from the time of vehicle handover. The date of the vehicle handover is properly documented together with the vehicle identification number (VIN) in the chapter "Documentation of vehicle handover" in this Owner's Manual.

#### ŠKODA warranty for new cars

Beyond the rights arising from defective performance under the law, the company ŠKODA AUTO grants you the ŠKODA warranty for new cars (hereinafter referred to as ŠKODA Warranty), according to the conditions described below.

Under the ŠKODA Warranty, the company ŠKODA AUTO shall provide the following services.

- ▶ Free repair of damage due to a defect that occurs in your vehicle within two years of the start of the ŠKODA Warranty.
- ▶ Free repair of damage due to paintwork flaws that occur on your vehicle within three years of the start of the ŠKODA Warranty.
- ▶ Free repair of rust corrosion on the body, which occurs on your vehicle within twelve years of the start of the warranty. In terms of rust corrosion on the body, the ŠKODA Warranty shall cover only rust corrosion through body panels from the inside to the outside.

The start of the ŠKODA Warranty is the day on which the new car is handed over for use by a ŠKODA partner to the first buyer who is not a ŠKODA Partner<sup>1)</sup>.

The ŠKODA Partner enters this date into the corresponding systems of the manufacturer. Any one ŠKODA Partner can notify you of this date on request.

Vehicle repairs under the ŠKODA Warranty can be carried out by means of a replacement or repair of the defective parts. The ŠKODA Service Partner decides about the type of vehicle repair. The vehicle repair takes place in accordance with the availability of the ŠKODA Service partners and within a reasonable

<sup>1)</sup> Due to the requirements of the generally binding country-specific legal regulations, the date of the first registration can be specified instead of the date of the vehicle handover.

period of time. Replaced parts become the property of the ŠKODA service partner.

There shall be no entitlement to further claims from the ŠKODA Warranty. In particular, no claim for replacement, no right of withdrawal, no claim to provision of a replacement car for the duration of repair and compensation.

The ŠKODA Warranty can be claimed at any ŠKODA service partner.

There are no claims under the ŠKODA warranty if vehicle damage has occurred in causal connection with one of the following circumstances.

- ▶ The service work was not carried out on time and professionally according to the specifications of ŠKODA AUTO, or its execution was not proven by the customer when asserting claims under the ŠKODA Warranty.
- ▶ Damage refers to parts that are subject to natural wear, such as tyres, spark plugs, wiper blades, brake pads and brake discs, clutch, bulbs, synchronizer rings, batteries, etc.
- ▶ The damage refers to third-party superstructures, third-party installations and third-party installations as well as defects in the vehicle caused by these.
- ▶ The same applies to accessories that were not installed and/or delivered by the factory.
- ▶ On/in the vehicle, parts have been attached, installed or connected, the use of which has not been approved by ŠKODA AUTO, or the vehicle has been modified in a manner not approved by ŠKODA AUTO (e.g. tuning).
- ▶ Unauthorized use, improper handling (e.g. use in motor sport competitions or overloading), improper care and maintenance or unauthorized modifications to your vehicle.
- ▶ Failure to comply with regulations in the Owner's Manual or in other factory-supplied instructions.
- ▶ External impact or influences (e.g. accident, hail, flood, etc.).
- ▶ Damage has not been reported immediately to a specialist company or has not been properly remedied.

The customer shall prove the lack of causation.

The present ŠKODA Warranty shall not affect the purchaser's statutory rights arising from unsatisfactory performance in respect of the seller of the vehicle and possible claims arising from product liability laws.

### ŠKODA Mobility warranty

The Mobility Warranty provides you with a sense of certainty for journeys in your vehicle.

As part of the mobility warranty, if your car breaks down as a result of an unexpected fault when you

are on the move, you can access services to ensure your continued mobility. These services include the following: Breakdown service at the breakdown location and towing to the ŠKODA Service Partner, technical assistance by phone or on-site operation.

If your vehicle is not repaired on the same day, then the ŠKODA service partner may, if necessary, arrange additional subsequent services, such as replacement transport (bus, train, etc.), the provision of a replacement vehicle, and the like.

Claims for free provision of services under the ŠKODA Mobility Warranty only exist if your vehicle has remained in a causal connection with a defect which is to be remedied on the basis of fulfilment under the ŠKODA Warranty.

Check the conditions for provision of the Mobility Warranty for your vehicle with your ŠKODA Partner. They will also inform you of the detailed terms and conditions of the Mobility Warranty in relation to your vehicle. In the event that your vehicle is not covered by a mobility warranty, he will inform you of the possibilities for subsequent conclusion.

### Optional ŠKODA Extended Warranty

If you also purchased a ŠKODA warranty extension when purchasing your new car, ŠKODA AUTO will provide you with a free repair of vehicle damage caused by a defect in the vehicle during the warranty period.

The ŠKODA Extended Warranty for your vehicle is valid for the agreed period or until the agreed mileage limit is reached, whichever comes first.

For the evaluation of claims under the ŠKODA Extended Warranty, the same rules apply as for the ŠKODA Warranty.

The vehicle repair under the ŠKODA Extended Warranty can therefore only be carried out by replacement or repair of the defective parts, whereby the ŠKODA service partner decides on the type of vehicle repair. The vehicle repair takes place in accordance with the availability of the ŠKODA Service partners and within a reasonable period of time.

There shall in any case be no entitlement to further claims from the ŠKODA Extended Warranty. In particular, no claim for replacement, no right of withdrawal, no claim to provision of a replacement car for the duration of repair and compensation.

The ŠKODA Extended Warranty does not apply to exterior and interior foils.

Your ŠKODA partner will provide you with information about the detailed conditions of the ŠKODA Extended Warranty.

**i** The ŠKODA Mobility Warranty and the ŠKODA Extended Warranty are only available in some countries.

## Index

### A

#### ABS

Functionality	120
Troubleshooting	120

#### ACC

Automatic stop and start	124
Distance adjustment	124
Functionality	124
Indicator light	124
Interruption of cruise control	125
Lever	124
Operation	124
Restriction	125
Setting in Infotainment	125
Troubleshooting	125

#### Accident data recorder

	167
--	-----

#### Active steering assistance

DSR	120
-----	-----

#### Adaptive Cruise Control

see ACC	124
---------	-----

#### AdBlue

Check	136
functionality	136
Indicator light	136
Refilling	136
Safety	14
standard	135
tank capacity	136

#### Air bag

Switch off	37
------------	----

#### Air conditioning system

see Climatronic	47
-----------------	----

#### Airbag

Deployment	37
Functionality	37
Overview	37
Safety	15
Switching off front passenger airbag	38
Troubleshooting	37

#### Alarm system

Conditions	22
Deactivation	22
Functionality	22
Setting	22
Trailer	22

#### All-season tyres

Conditions	145
Settings	145
Usage	145
What you should be mindful of	145

#### Ambient lighting

	43
--	----

#### Analogue

instrument panel	48
------------------	----

#### Analogue instrument cluster

Overview	48
Setting	48

#### Analogue instrument panel

48

#### Android Auto

Infotainment Amundsen	103
Infotainment Bolero	81
Infotainment Swing	65
see electronic version of the manual	5

#### Anti-lock Braking System

see ABS	120
---------	-----

#### Anti-Slip Regulation

see ASR	120
---------	-----

#### Apple CarPlay

Infotainment Amundsen	103
Infotainment Bolero	81
Infotainment Swing	65
see electronic version of the manual	5

#### Armrest

Front	29
Rear	29

#### Ashtray

	157
--	-----

#### ASR

Deactivation and activation	120
Functionality	120
Troubleshooting	120

#### Assist systems

Driver assist	120
Park Assist	128

#### Assistance systems

Safety	16
--------	----

#### Automatic gearbox

Driving in neutral	114
indicator light	115
Kick-down	114
Lever positions	114
Manually changing gear with the selector lever	114

manually changing gear with the shift paddles on the steering wheel	114
---	-----

Operation	114
-----------	-----

Releasing selector lever	114
--------------------------	-----

Selector lever emergency unlocking	115
------------------------------------	-----

Starting up	114
-------------	-----

Stopping	114
----------	-----

Troubleshooting	115
-----------------	-----

#### Automatic gearbox modes

	114
--	-----

#### Automatic headlights system

Setting	40
---------	----

#### Automatic transmission

Starting	111, 112
----------	----------

### B

#### Backup camera

Functional surfaces	129
Orientation	129

#### Battery

see vehicle battery	139
---------------------	-----

#### Battery acid

	139
--	-----

#### Blinker

see flashing light	39
--------------------	----

- Bluetooth**
  - see electronic version of the manual 5
- Bonnet** 132
- Boot** 151
  - 12 volt socket 151
  - Double-sided floor covering 153
  - Fasteners 151
  - Hitch switch 151
  - Rigid cover 154
  - Storage compartments 151
  - Transporting objects safely 16
  - Variable loading floor 154
- Boot cover** 154
- Boot lid**
  - Automatic locking 26
  - electrical operation 26
  - manual operation 26
- Boot storage**
  - see boot compartment lid 26
- Brake fluid** 119
  - Checking 119
  - Indicator light 119
  - Safety 14
  - Specification 119
- Brakes** 118
  - Brake fluid 119
  - Hand brake 119
  - Troubleshooting 119
  - What you should be mindful of 118
- Braking systems** 120
- Breakdown call**
  - Infotainment Amundsen 105
  - Infotainment Bolero 83
  - Infotainment Swing 67
- Breakdown kit**
  - Conditions 148
  - Overview 147
  - Purpose 148
  - Restriction 148
- Bulbs** 42
  - Rear turn signal - Replacing 42
  - Reversing light - Replacing 43
  - Safety 42
- C**
- Car adaptations**
  - Recommendations 161
- Car wash**
  - Outside 163
- Cargo elements** 151
- Central locking** 19
- Central locking system**
  - Button 20
  - Fault 20
  - Functionality 19
  - Operation 20
  - SAFE function 19
  - Setting 20
- Centre console** 9
- Changing gear**
  - Manually changing gear with the selector lever 114
  - manually changing gear with the shift paddles on the steering wheel 114
- Changing gear with a manual gearbox** 113
- Changing gears with an automatic gearbox** 114
- Changing the protective door strip** 23
- Charging your phone wirelessly** 156
- Check the vehicle before your journey** 14
- Child lock** 23
- Child seat** 33
  - Child seat fastened with a belt 35
  - Grouping 34
  - i-Size 35
  - Installation 36
  - ISOFIX 35, 36
  - Keyword child seat 33
  - On the passenger seat 33
  - Recommended child seats 34
  - Safety 15
  - Securing children properly 15
  - TOP TETHER 36
  - What you should be mindful of 33
- Cigarette lighter** 157
- Cleaning the vehicle**
  - Outside 162
- Climatronic**
  - Automatic mode 47
  - Climatronic Display 47
  - Operating conditions for the cooling system 47
  - Operation 47
  - Recirculated air mode 47
  - Setting 47
  - Setting the blower speed 47
  - Troubleshooting 48
  - What you should be mindful of 47
- COMING HOME** 41
  - functionality 41
  - Operating conditions 41
  - Setting 41
- Compartments** 155
- Configuration wizard**
  - Infotainment Amundsen 86
  - Infotainment Bolero 70
  - Infotainment Swing 54
- Control centre**
  - Infotainment Amundsen 85
- Control Centre**
  - Infotainment Bolero 69
  - Infotainment Swing 53
- Convenience signalling** 39
  - Setting 40
- Coolant** 133
  - Checking 134

- Indicator light \_\_\_\_\_ 134
- Refilling \_\_\_\_\_ 134
- Safety \_\_\_\_\_ 14
- Specification \_\_\_\_\_ 134
- Temperature gauge \_\_\_\_\_ 133
- Troubleshooting \_\_\_\_\_ 134
- Crew Protect Assist**
- Functionality \_\_\_\_\_ 127
- see Proactive occupant protection \_\_\_\_\_ 127
- Troubleshooting \_\_\_\_\_ 128
- Crew Protect Assist system**
- Deactivation \_\_\_\_\_ 127
- Cruise control** \_\_\_\_\_ 123
- Functionality \_\_\_\_\_ 123
- Indicator light \_\_\_\_\_ 123
- Operation \_\_\_\_\_ 123
- Troubleshooting \_\_\_\_\_ 124
- Cup holder** \_\_\_\_\_ 157
- D**
- Date**
- Infotainment Amundsen \_\_\_\_\_ 86
- Infotainment Bolero \_\_\_\_\_ 70
- Infotainment Swing \_\_\_\_\_ 54
- Daytime running lights** \_\_\_\_\_ 39
- Diesel** \_\_\_\_\_ 138
- Misfuelling protection \_\_\_\_\_ 138
- Prescribed fuel \_\_\_\_\_ 138
- Refilling \_\_\_\_\_ 138
- Requirements for refuelling \_\_\_\_\_ 138
- Standards \_\_\_\_\_ 138
- Tank capacity \_\_\_\_\_ 138
- Troubleshooting \_\_\_\_\_ 138
- Digital**
- instrument cluster \_\_\_\_\_ 49
- Digital instrument cluster** \_\_\_\_\_ 49
- Additional Information \_\_\_\_\_ 49, 50
- Overview \_\_\_\_\_ 49
- Presentation \_\_\_\_\_ 49
- Setting \_\_\_\_\_ 49
- Display of the instrument cluster**
- Operation \_\_\_\_\_ 50
- Door**
- Opening/closing \_\_\_\_\_ 23
- Door protect**
- see door protection strip \_\_\_\_\_ 23
- Door protection strip**
- functionality \_\_\_\_\_ 23
- Double-sided floor covering in the boot**
- Double-sided floor covering \_\_\_\_\_ 153
- DriveGreen** \_\_\_\_\_ 116
- Driver Alert**
- Activation/deactivation \_\_\_\_\_ 128
- fatigue detection assistant \_\_\_\_\_ 128
- Functionality \_\_\_\_\_ 128
- Indicator light \_\_\_\_\_ 128
- Driver's seat** \_\_\_\_\_ 9
- Driving data** \_\_\_\_\_ 51
- Display \_\_\_\_\_ 51
- Memory \_\_\_\_\_ 51, 52
- Overview \_\_\_\_\_ 51
- Setting \_\_\_\_\_ 52
- Speed limit warning \_\_\_\_\_ 52
- Driving with trailer**
- Safety \_\_\_\_\_ 16
- Trailer Stability Assist \_\_\_\_\_ 120
- DSR** \_\_\_\_\_ 120
- E**
- Earth point** \_\_\_\_\_ 141
- Economical driving**
- Drive Green \_\_\_\_\_ 116
- Tips for economical driving \_\_\_\_\_ 116
- EDL** \_\_\_\_\_ 120
- Electric windows**
- Activation \_\_\_\_\_ 25
- Buttons on the door \_\_\_\_\_ 24
- Force limiter \_\_\_\_\_ 24
- Operation \_\_\_\_\_ 24
- Settings \_\_\_\_\_ 25
- Troubleshooting \_\_\_\_\_ 25
- Electronic Differential Lock**
- EDL \_\_\_\_\_ 120
- XDL+ \_\_\_\_\_ 120
- Electronic Stability Control** \_\_\_\_\_ 120
- Emergency**
- Emergency call \_\_\_\_\_ 17
- Selector lever emergency unlocking \_\_\_\_\_ 115
- Towing the vehicle \_\_\_\_\_ 118
- Unlocking/locking the door \_\_\_\_\_ 20
- Using jump start cables \_\_\_\_\_ 140
- Emergency call** \_\_\_\_\_ 17
- Emergency equipment**
- Extinguisher \_\_\_\_\_ 151
- First aid kit \_\_\_\_\_ 151
- Jack \_\_\_\_\_ 151
- Reflective vest \_\_\_\_\_ 151
- Tool kit \_\_\_\_\_ 151
- Warning triangle \_\_\_\_\_ 151
- Emergency wheel** \_\_\_\_\_ 145
- Safe driving \_\_\_\_\_ 16
- Take out and insert \_\_\_\_\_ 146
- Engine compartment** \_\_\_\_\_ 10
- Bonnet \_\_\_\_\_ 132
- Brake fluid \_\_\_\_\_ 119
- Coolant \_\_\_\_\_ 133
- Engine oil \_\_\_\_\_ 133
- Safety \_\_\_\_\_ 14
- Vehicle battery \_\_\_\_\_ 139
- Windscreen washer fluid \_\_\_\_\_ 44, 45
- Engine number** \_\_\_\_\_ 164
- Engine oil** \_\_\_\_\_ 133
- Changing \_\_\_\_\_ 133
- Checking \_\_\_\_\_ 133
- Indicator light \_\_\_\_\_ 133
- Refilling \_\_\_\_\_ 133

- Safety.....14
- Specification.....133
- Engine start**
- Ignition lock.....111
- Starter button.....112
- Troubleshooting.....112
- Using jump start cables.....140
- EPC**.....134
- Equipment in the boot**.....151
- ESC**.....120
- Functionality.....120
- Troubleshooting.....120
- Exhaust control system**.....135
- Explanations**.....6
- Exterior**
- lighting.....39
- Exterior mirror**.....31
- External Mirrors**
- Adjust the position of the mirror surface and the mirror housing.....31
- Extinguisher**.....151
- F**
- Fasteners in the boot**.....151
- First aid kit**.....151
- Fog light**
- Rear.....40
- Fog lights**.....40
- Front.....40
- Fogged windows**.....47
- Folding table**.....158
- Freewheeling**
- See Driving in neutral.....114
- Front Assist**
- automatic braking.....121
- distance warning system.....121
- Functionality.....121
- Operating conditions.....121
- restriction.....121
- setting.....121
- Troubleshooting.....121
- Front seats**
- Electrical adjustment.....28
- Manual adjustment.....28
- Front vehicle area**.....7
- Fuel**
- Diesel.....138
- Petrol.....136
- Fuel filler flap**.....135
- Fuel filter**.....135
- Fuel tank**.....135
- Opening the flap.....135
- Full LED headlights**.....39
- Fuses**
- Blown fuse.....141
- In the dash panel.....141
- In the engine compartment.....143
- Replacing.....141
- H**
- Handbrake**.....119
- Hazard warning light system**.....40
- Headlights**
- Full LED.....39
- Full LED setting.....40
- Headlight range control.....40
- Headrests**
- Adjusting the height.....29
- Removing and inserting.....29
- Heated**
- steering wheel.....31
- Heated seats**
- Conditions.....30
- Heated steering wheel**
- Conditions.....30
- Operation.....31
- Settings.....31
- Heated windscreen**
- Operation.....25
- Setting.....26
- Heating**.....46
- HHC**
- see Hill Hold Control.....120
- High beam assist system**
- Functionality.....41
- High-beam**
- High-beam assist system.....41
- High-beam assist**
- Activation and deactivation in the infotainment system.....41
- Conditions.....41
- Switching off.....41
- Switching on.....41
- High-beam assist system**.....41
- Hill Hold Control**.....120
- Hook**
- In the interior.....155
- Hooks**
- in the boot.....151
- Hotspot**
- see electronic version of the manual.....5
- I**
- i-Size**.....35
- Ice scraper**.....8
- Ignition lock**.....111
- Images**
- see electronic version of the manual.....5
- Images - Infotainment Amundsen**
- Gesture control.....95
- Main menu overview.....95
- Settings.....96
- Show main menu.....95
- Supported sources.....96
- Touch operation.....95
- Immobilizer**.....112
- Indicator lights**

Foreword	10	Settings	88
Overview	10	<b>Infotainment screen Bolero</b>	
<b>Information call</b>		Overview	71
Infotainment Amundsen	105	Settings	71
Infotainment Bolero	83	<b>Infotainment screen Swing</b>	
Infotainment swing	67	Overview	55
<b>Infotainment Amundsen</b>		Settings	55
Contactless operation	87	<b>Infotainment Swing</b>	
Function restriction	86	contactless operation	55
Keypad	88	Contactless operation	55
Operation by touch	87	Function restriction	54
Overview	85	Keypad	55
Restart	86	Operation by touch	55
System update	87	Overview	53
System version	87	Restart	54
Voice control	89	System update	54
<b>Infotainment Amundsen overview</b>	85	System version	54
<b>Infotainment Bolero</b>		Touch operation	55
Contactless operation	71	<b>Instrument cluster</b>	
Function restriction	70	Instrument cluster display	50
Keypad	71	<b>Instrument cluster display</b>	50
Operation by touch	71	Menu	50
Overview	69	Overview	50
Restart	70	<b>Interior</b>	
System update	70	lighting	43
System version	70	<b>Interior lighting</b>	43
<b>Infotainment control centre</b>		Ambient lighting	43
Infotainment Amundsen	85	Operation	43
<b>Infotainment keyboard</b>		Settings	43
see electronic version of the manual	5	<b>Interior monitoring - Deactivation</b>	22
<b>Infotainment keyboard Amundsen</b>		<b>Interior rear-view mirror</b>	31
Additional keypad languages	88	see interior rear-view mirror	31
Character variants	88	<b>ISOFIX</b>	
Find	88	Functionality	36
Service	88	Use of child seats	35
Setting additional keypad languages	89	<b>J</b>	
<b>Infotainment keypad Amundsen</b>		<b>Jump start cables</b>	141
Overview	88	<b>Jump-starting</b>	140
<b>Infotainment keypad Bolero</b>		<b>K</b>	
Additional keypad languages	72	<b>Key</b>	
Character variants	72	Changing the battery	19
Overview	71	Overview	19
Search	72	Troubleshooting	19
Service	72	<b>Key switch for switching off airbag</b>	38
Setting additional keypad languages	72	<b>Keyless locking (KESSY)</b>	21
<b>Infotainment keypad Swing</b>		Deactivation	21
Additional keypad languages	56	Operation	21
Character variants	56	Protection against locking the key inside the vehicle	21
Find	56	Purpose	21
Operation	56	Troubleshooting	21
Overview	55	<b>L</b>	
Setting additional keypad languages	56	<b>Lane Assist</b>	126
<b>Infotainment Operation Centre</b>		Conditions	126
Infotainment Bolero	69	Restriction	126
Infotainment Swing	53		
<b>Infotainment overview Bolero</b>	69		
<b>Infotainment Overview Swing</b>	53		
<b>Infotainment screen Amundsen</b>			
Overview	87		



- see Lane Assist \_\_\_\_\_ 126
- Setting \_\_\_\_\_ 126
- Troubleshooting \_\_\_\_\_ 126
- Lane change assist system**
- see Side Assist \_\_\_\_\_ 126
- LEAVING HOME** \_\_\_\_\_ 41
- functionality \_\_\_\_\_ 41
- Operating conditions \_\_\_\_\_ 41
- Setting \_\_\_\_\_ 41
- Lever**
- ACC \_\_\_\_\_ 124
- Cruise control \_\_\_\_\_ 123
- High beam \_\_\_\_\_ 39
- High-beam assist \_\_\_\_\_ 41
- Speed limiter \_\_\_\_\_ 122
- Turn signal \_\_\_\_\_ 39
- Windscreen wiper and washer \_\_\_\_\_ 44
- Liability for defects** \_\_\_\_\_ 168
- Light** \_\_\_\_\_ 39
- Change bulbs \_\_\_\_\_ 42
- Changing bulbs \_\_\_\_\_ 42
- Clean headlights \_\_\_\_\_ 44
- CORNER function \_\_\_\_\_ 39
- Daytime running lights \_\_\_\_\_ 39
- Driving in the opposite direction of traffic \_\_\_\_\_ 40
- Fog light \_\_\_\_\_ 40
- Full LED headlights \_\_\_\_\_ 39
- Hazard warning lights \_\_\_\_\_ 40
- Headlight range control of the headlights \_\_\_\_\_ 40
- High beam \_\_\_\_\_ 39
- High-beam assist system \_\_\_\_\_ 41
- Indicator light \_\_\_\_\_ 41
- Low beam \_\_\_\_\_ 39, 40
- Parking light \_\_\_\_\_ 40
- Sidelights \_\_\_\_\_ 40
- Switching on and off \_\_\_\_\_ 39
- Switching on and off automatically \_\_\_\_\_ 39, 40
- Troubleshooting \_\_\_\_\_ 41
- Turn signal \_\_\_\_\_ 39
- Light Assist**
- see high beam assist system \_\_\_\_\_ 41
- Light switch** \_\_\_\_\_ 39
- Lighting**
- Ambient lighting \_\_\_\_\_ 43
- Lighting range** \_\_\_\_\_ 40
- Limiter**
- see speed limiter \_\_\_\_\_ 122
- List of radio stations**
- see electronic version of the manual \_\_\_\_\_ 5
- Loads** \_\_\_\_\_ 165
- Lock**
- Setting \_\_\_\_\_ 20
- Locking**
- Central locking button \_\_\_\_\_ 20
- Emergency locking \_\_\_\_\_ 20
- functionality \_\_\_\_\_ 19
- Keyless \_\_\_\_\_ 21
- Low beam** \_\_\_\_\_ 39, 40
- Luggage compartment**
- Fastening nets \_\_\_\_\_ 152
- Net partition \_\_\_\_\_ 153
- Storage pocket \_\_\_\_\_ 153
- Luggage Storage**
- removable light \_\_\_\_\_ 151
- M**
- Main beam** \_\_\_\_\_ 39
- Manoeuvre Assist**
- Operating conditions \_\_\_\_\_ 130
- Restriction \_\_\_\_\_ 130
- Troubleshooting \_\_\_\_\_ 130
- Manual air conditioning**
- Operating conditions for the cooling system \_\_\_\_\_ 46
- Operation \_\_\_\_\_ 46
- Recirculated air mode \_\_\_\_\_ 46
- see manual air conditioning \_\_\_\_\_ 46
- Troubleshooting \_\_\_\_\_ 47
- What you should be mindful of \_\_\_\_\_ 46
- Manual gearbox** \_\_\_\_\_ 113
- MCB** \_\_\_\_\_ 120
- Media**
- Playlist \_\_\_\_\_ 93
- see electronic version of the manual \_\_\_\_\_ 5
- Media - Infotainment Amundsen**
- Main menu \_\_\_\_\_ 92
- Manage favourites \_\_\_\_\_ 93
- Service \_\_\_\_\_ 92
- Settings \_\_\_\_\_ 93
- Supported audio files \_\_\_\_\_ 93
- Supported playlists \_\_\_\_\_ 93
- Supported sources \_\_\_\_\_ 93
- Supported video files \_\_\_\_\_ 93
- Traffic news \_\_\_\_\_ 93
- what you should be mindful of \_\_\_\_\_ 92
- Media - Infotainment Bolero**
- iCloud \_\_\_\_\_ 75
- Main menu \_\_\_\_\_ 75
- Operation \_\_\_\_\_ 75
- Play online media from an Apple device \_\_\_\_\_ 75
- safely remove the connected USB device \_\_\_\_\_ 75
- Settings \_\_\_\_\_ 75
- Supported audio files \_\_\_\_\_ 76
- Supported playlists \_\_\_\_\_ 76
- Supported sources \_\_\_\_\_ 76
- things to be considered \_\_\_\_\_ 74
- Title playback including subfolders \_\_\_\_\_ 75
- Traffic \_\_\_\_\_ 75
- Media - Infotainment Swing**
- iCloud \_\_\_\_\_ 59
- Main menu \_\_\_\_\_ 59
- Play online media from an Apple device \_\_\_\_\_ 59
- Safely remove the connected USB device \_\_\_\_\_ 59
- Service \_\_\_\_\_ 59
- Settings \_\_\_\_\_ 59
- Supported audio files \_\_\_\_\_ 60
- Supported playlists \_\_\_\_\_ 60
- Supported sources \_\_\_\_\_ 60

- Title playback including subfolders ..... 59
- Traffic news ..... 59
- what you should be mindful of ..... 58
- Mirror**
  - see exterior mirror ..... 31
- MirrorLink**
  - Infotainment Amundsen ..... 103
  - Infotainment Bolero ..... 81
  - Infotainment Swing ..... 65
  - see electronic version of the manual ..... 5
- Mirrors**
  - Set functions ..... 31
  - Troubleshooting ..... 32
- Mobile device management - Infotainment Amundsen**
  - Connect a mobile device to Infotainment ..... 98
  - Connect Infotainment to a non-paired mobile device ..... 98
  - Connect Infotainment to a previously connected mobile device ..... 98
- Mobile Device Management - Infotainment Amundsen**
  - Applications in mobile devices ..... 98
  - Mobile device Bluetooth compatibility ..... 98
  - Mobile device compatibility ..... 98
  - Overview ..... 97
  - Show main menu ..... 97
  - SmartLink connection ..... 98
- Mobile device management - Infotainment Bolero**
  - Applications in mobile devices ..... 77
  - Bluetooth compatibility of mobile devices ..... 77
  - Compatibility of mobile devices ..... 77
  - Connect a mobile device to Infotainment ..... 78
  - Connect Infotainment to a non-paired mobile device ..... 78
  - Connect Infotainment to a previously connected mobile device ..... 78
- Mobile Device Management - Infotainment Bolero**
  - Display main menu ..... 77
  - Overview ..... 77
  - SmartLink connection ..... 78
- Mobile device management - Infotainment Swing**
  - Connect a mobile device to Infotainment ..... 62
  - Connect Infotainment to a non-paired mobile device ..... 62
  - Connect Infotainment to a previously connected mobile device ..... 62
- Mobile Device Management - Infotainment Swing**
  - Applications in mobile devices ..... 61
  - Mobile device Bluetooth compatibility ..... 61
  - Mobile device compatibility ..... 61
  - Overview ..... 61
  - Show main menu ..... 61
  - SmartLink connection ..... 62
- Motor Slip Regulation**
  - see MSR ..... 120
- MSR** ..... 120
- Multi-Collision Brake**
  - see MCB ..... 120
- Multimedia holder** ..... 157
- N**
- Navigation - infotainment Amundsen**
  - Fuel warning ..... 110
- Navigation - Infotainment Amundsen**
  - Automatic update ..... 111
  - Business address ..... 110
  - Change route destinations ..... 106
  - Delete the recommended destination ..... 106
  - Demo mode ..... 110
  - Destination information ..... 110
  - Driving with a trailer ..... 110
  - Enter destination via the address ..... 106
  - Find destination ..... 106
  - Home address ..... 110
  - Information on driving time ..... 110
  - List of stored destinations ..... 106
  - Map overview ..... 106
  - Navigation announcements ..... 106
  - Navigation database version ..... 111
  - POI categories ..... 110
  - Recommended destinations ..... 106
  - Route calculation ..... 106
  - Route summary ..... 106
  - Select destination in the map ..... 106
  - Select destination you are looking for ..... 106
  - Select the stored destination ..... 106
  - Set navigation announcements ..... 110
  - Settings ..... 110
  - Show main menu ..... 106
  - Speed limit warning ..... 110
  - Speed limits ..... 110
  - Starting point of demo mode ..... 110
  - Touch operation ..... 109
  - Traffic density ..... 106
  - Traffic obstruction ..... 110
  - Traffic sign display ..... 110
  - Update the navigation database ..... 111
- Net partition** ..... 153
- Nets in the luggage compartment** ..... 152
- O**
- Oil**
  - see engine oil ..... 133
- Online services - Infotainment Amundsen**
  - Breakdown call ..... 105
  - Connection status ..... 106
  - Delete users ..... 106
  - Information call ..... 105
  - Registration and activation of online services ..... 106
  - Registration and activation of online services in Infotainment ..... 106
  - Rights and obligations ..... 105
  - Set the level of protection for personal data ..... 106
  - Settings ..... 106
  - ŠKODA Connect application ..... 105
  - ŠKODA Connect Portal website ..... 105

ŠKODA Connect website	105	<b>Park Pilot</b>	
Switch data services on / off	106	Operating conditions	128
Use of data services	106	Operation	128
<b>Online Services - Infotainment Bolero</b>		Restriction	129
Breakdown call	83	Setting	129
Connection status	84	Troubleshooting	129
Delete user	84	<b>Parking</b>	
Information call	83	Park steering assistant	130
Registration and activation of online services	84	Parking aid	128
Rights and obligations	83	Parking the vehicle safely	17
Service management	84	Rear Traffic Alert	130
Setting the level of protection of personal data	84	Reversing camera	129
Settings	84	<b>Parking aid</b>	
ŠKODA Connect Application	83	functionality	128
ŠKODA Connect Portal Website	83	Overview	128
ŠKODA Connect Website	83	<b>Parking brake</b>	119
<b>Online Services - Infotainment Swing</b>		<b>Parking light</b>	40
Breakdown call	67	<b>ParkPilot</b>	
Connection status	68	see parking aid	128
Delete user	68	<b>Particle filter</b>	135
Information call	67	<b>Particle Filter</b>	
Registration and activation of online services	68	Troubleshooting	135
Rights and obligations	67	<b>Particulate Filter</b>	
Service management	68	Cleaning	135
Setting the level of protection of personal data	68	<b>Passenger seat</b>	9
Settings	68	<b>Pedestrian detection</b>	
ŠKODA Connect Application	67	functionality	121
ŠKODA Connect Portal Website	67	operating conditions	122
ŠKODA Connect Website	67	<b>Petrol</b>	136
<b>Online services ŠKODA Connect</b>		Prescribed fuel	137
Infotainment Swing	67	Prescribed petrol	137
<b>Operating Infotainment Amundsen</b>		Refilling	137
by language	89	Requirements for refuelling	137
<b>Operation of Infotainment Amundsen</b>		standards	136
by touch	87	Tank capacity	137
contactless	87	Troubleshooting	137
<b>Operation of Infotainment Bolero</b>		<b>Phonebox</b>	
by touch	71	Functionality	156
contactless	71	operating conditions	156
<b>Overspeed limiter</b>		What you should be mindful of	156
functionality	122	<b>Pictures - Infotainment Amundsen</b>	
<b>P</b>		Supported files	96
<b>Park Assist</b>		<b>Power assisted steering</b>	30
Change parking mode	131	<b>Practical equipment</b>	155
exiting from a longitudinal parking space	132	12 volt socket	151, 155, 158
functionality	131	Ashtray	157
Operating conditions	131	Cigarette lighter	157
Operation	131	Coat hook	155
Parking	131	cup holder	157
Parking operation	131	Folding table	158
Purpose	130	Make up mirror	155
Restriction	132	Multimedia holder	157
see park steering assistant	130	Spectacles compartment	155
Troubleshooting	132	Storage compartment for the umbrella	156
Turn on/turn off	131	Storage compartment under the front seat	156
What you should be mindful of	130	Storage compartments	155
<b>Park Assist systems</b>	128	Storage pockets	155
		Ticket holder	155
		Waste container	157

## R

**Radio**

see electronic version of the manual 5

**Radio - Infotainment Amundsen**

Arrow buttons 91  
 Assign station logo 91  
 Automatic station logo assignment 91  
 Delete favourites 91  
 Find stations manually 90  
 Information on the station 91  
 List of available stations 90  
 Main menu overview 90  
 Other DAB announcements 91  
 Radio text 91  
 RDS 91  
 Regional station logo 91  
 Restriction 90  
 Save station to favourites from station list 91  
 Save station to favourites from the main menu 91  
 SCAN function 90  
 Select station 90  
 Settings 91  
 Show main menu 90  
 Stations displayed in the list of available stations 91  
 Switch off the station logo display 91  
 Switch to a similar station if reception is poor 91  
 Traffic programme (TP) 91

**Radio - Infotainment Bolero**

Arrow keys 73  
 Assign station logo 73  
 Automatic assignment of the station logo 73  
 Automatic frequency change (AF) 73  
 Change from DAB station to similar FM station 73  
 Change from DAB station to similar FM station in event of weak signal 73  
 Change from the DAB station to the same DAB station 73  
 Change to a regionally linked FM station 73  
 DAB traffic 73  
 Delete favourites 73  
 Delete station logo 73  
 Display main menu 72  
 Information about the station 73  
 List of available stations 72  
 Main menu overview 72  
 other DAB announcements 73  
 Radio text 73  
 RDS 73  
 Regional station logos 73  
 Restriction 73  
 Save station to favourites from station list 73  
 Save station to favourites from the main menu 73  
 SCAN function 72  
 Search for stations manually 72  
 Select station 72  
 Settings 73  
 Sort stations in the list of available stations 73

Traffic Radio (TP) 73

**Radio - Infotainment Swing**

Arrow buttons 57  
 Assign station logo 57  
 Automatic frequency control (AF) 57  
 Automatic station logo assignment 57  
 Change from DAB station to similar FM station 57  
 Change from DAB station to similar FM station in event of weak signal 57  
 Change from the DAB station to the same DAB station 57  
 Change to a regionally linked FM station 57  
 DAB traffic 57  
 Delete favourites 57  
 Delete station logo 57  
 Find stations manually 56  
 Information on the station 57  
 List of available stations 56  
 Main menu overview 56  
 Other DAB announcements 57  
 Radio text 57  
 RDS 57  
 Regional station logo 57  
 Restriction 57  
 Save station to favourites from station list 57  
 Save station to favourites from the main menu 57  
 SCAN function 56  
 Select station 56  
 Settings 57  
 Show main menu 56  
 Sort stations in the list of available stations 57  
 Traffic programme (TP) 57

**Rear fog light**

**Rear seats**  
 Folding down 28

**Rear Traffic Alert**

Functionality 130  
 Setting 130

**Rear vehicle area**

8

**Rear View Camera**

Operation 130

**Refilling**

AdBlue 136  
 Coolant 134  
 Diesel 138  
 Engine oil 133  
 Petrol 137

**Reflective vest**

151

**Removable light**

Overview 153  
 Replace batteries 154  
 Take out and insert 153

**Restarting Infotainment Amundsen** 86

**Restarting Infotainment Swing** 54

**Restarting the Infotainment Bolero** 70

**Reversing camera**

functionality 129  
 Operating conditions 129  
 Overview 129

- Restriction.....130
- Rights arising from defective performance**.....168
- Rigid boot cover**.....154
- Roof rack**.....159
  - Roof load.....159
  - Safe driving.....16
- S**
- Safe driving**.....16
- SAFE function**
  - Description.....19
  - Turn off.....20
- Safely remove connected USB device**
  - Infotainment Bolero.....70
  - Infotainment Swing.....54
- Safety**
  - after an accident.....18
  - Airbag.....15
  - Assistance systems.....16
  - Belt webbing arrangement.....15
  - Car adaptations.....13
  - Child seat.....15
  - Correct seating position.....14
  - Driving through water.....16
  - Driving with a trailer.....16
  - Emergency call.....17
  - Engine compartment.....14
  - Exiting the vehicle.....17
  - Indicator lights.....16
  - New brake pads.....13
  - New tyres.....13
  - Operating fluids.....14
  - Parking.....17
  - regular checks.....13
  - Roof rack.....16
  - Running in the engine.....13
  - safe driving.....16
  - Sensors and cameras.....13
  - Sockets.....14
  - Spare and emergency wheel.....16
  - Transporting cargo.....16
  - Transporting children.....15
  - Transporting objects.....16
  - Vehicle battery.....14
  - weather conditions.....17
- Seat**
  - Heating.....30
- Seat belts**.....32
  - Adjusting the height.....33
  - Automatic belt retractor.....32
  - Belt tensioners.....32
  - Blocked strap.....33
  - Fastening and unfastening.....33
  - Reversible belt tensioner.....32
  - Status display in the instrument cluster display.....32
  - Troubleshooting.....33
- Seat heating**
  - Operation.....30
- What you should be mindful of.....29
- Seatbelts**
  - Correct arrangement.....15
- Seats**
  - Adjusting the headrests.....29
  - Electrical adjustment.....28
  - Folding down.....28
  - folding passenger seat backrest.....28
  - ISOFIX.....36
  - Manual adjustment.....28
  - Sitting safely.....14
  - TOP TETHER.....36
- Selector lever**.....114
- Service event**
  - Interval.....161
  - Proof.....161
  - Reset information.....161
  - Show appointment.....161
- Service work**.....161
- Set the MENU menu**
  - Infotainment Bolero.....70
  - Infotainment Swing.....54
- Setting the HOME menu**
  - Infotainment Amundsen.....86
- Setting the MENU menu**
  - Infotainment Amundsen.....86
- Side Assist**
  - Functionality.....126
  - operating conditions.....127
  - Purpose.....126
  - Restrictions.....127
  - Setting.....127
  - Troubleshooting.....127
- Sidelights**
  - see Parking light.....40
- ŠKODA Connect application**
  - Infotainment Amundsen.....105
- ŠKODA Connect Application**
  - Infotainment Bolero.....83
  - Infotainment Swing.....67
- ŠKODA Connect online services**
  - Infotainment Amundsen.....105
- ŠKODA Connect Online services**
  - Infotainment Bolero.....83
- Sliding/tilting sunroof**
  - electric operation of the sun blinds.....25
- SmartLink**
  - see electronic version of the manual.....5
- SmartLink - Infotainment Amundsen**
  - Android Auto.....103
  - Android Auto - Connection via USB.....104
  - Android Auto - Disconnection.....104
  - Android Auto connection conditions.....103
  - Apple CarPlay.....103
  - Apple CarPlay - Connection via USB.....104
  - Apple CarPlay - Connection via Wi-Fi from Infotainment.....104
  - Apple CarPlay - connection via Wi-Fi from mobile devices.....104

- Apple CarPlay - Disconnection\_\_\_\_\_104
- Apple CarPlay connection conditions\_\_\_\_\_103
- Change to another connection type\_\_\_\_\_104
- Change to another device\_\_\_\_\_104
- Functionality\_\_\_\_\_103
- General connection conditions\_\_\_\_\_103
- Main menu\_\_\_\_\_103
- MirrorLink\_\_\_\_\_103
- MirrorLink - Connection via USB\_\_\_\_\_104
- MirrorLink - Disconnection\_\_\_\_\_104
- MirrorLink connection conditions\_\_\_\_\_103
- Mobile device management\_\_\_\_\_98
- Navigation restriction\_\_\_\_\_104
- Operating the running MirrorLink application\_\_\_\_104
- Restriction while driving\_\_\_\_\_104
- Route guidance restriction\_\_\_\_\_109
- Show main menu\_\_\_\_\_103
- Supported connection types\_\_\_\_\_103
- SmartLink - Infotainment Bolero**
- Android Auto\_\_\_\_\_81
- Android Auto - connection via USB\_\_\_\_\_82
- Android Auto - connection via Wi-Fi from Infotainment\_\_\_\_\_82
- Android Auto - disconnection\_\_\_\_\_82
- Android Auto connection conditions\_\_\_\_\_82
- Apple CarPlay\_\_\_\_\_81
- Apple CarPlay - connection via USB\_\_\_\_\_82
- Apple CarPlay - connection via Wi-Fi from Infotainment\_\_\_\_\_82
- Apple CarPlay - connection via Wi-Fi from mobile devices\_\_\_\_\_82
- Apple CarPlay - disconnection\_\_\_\_\_82
- Apple CarPlay connection conditions\_\_\_\_\_82
- Change to another connection type\_\_\_\_\_82
- Change to another device\_\_\_\_\_82
- Display main menu\_\_\_\_\_81
- Functionality\_\_\_\_\_81
- General connection conditions\_\_\_\_\_82
- Main menu\_\_\_\_\_81
- MirrorLink\_\_\_\_\_81
- MirrorLink - connection via USB\_\_\_\_\_82
- MirrorLink - connection via Wi-Fi from Infotainment\_\_\_\_\_82
- MirrorLink - disconnection\_\_\_\_\_82
- MirrorLink connection conditions\_\_\_\_\_82
- Mobile device management\_\_\_\_\_78
- Operation of the MirrorLink running application\_\_\_\_82
- Restriction of the Wi-Fi connection\_\_\_\_\_82
- Restrictions while driving\_\_\_\_\_82
- supported connection types\_\_\_\_\_81
- SmartLink - Infotainment Swing**
- Android Auto\_\_\_\_\_65
- Android Auto - connection via USB\_\_\_\_\_66
- Android Auto - connection via Wi-Fi from Infotainment\_\_\_\_\_66
- Android Auto - disconnection\_\_\_\_\_66
- Android Auto connection conditions\_\_\_\_\_66
- Apple CarPlay\_\_\_\_\_65
- Apple CarPlay - connection via USB\_\_\_\_\_66
- Apple CarPlay - connection via Wi-Fi from Infotainment\_\_\_\_\_66
- Apple CarPlay - connection via Wi-Fi from mobile devices\_\_\_\_\_66
- Apple CarPlay - disconnection\_\_\_\_\_66
- Apple CarPlay connection conditions\_\_\_\_\_66
- Change to another connection type\_\_\_\_\_66
- Change to another device\_\_\_\_\_66
- Display main menu\_\_\_\_\_65
- Functionality\_\_\_\_\_65
- General connection conditions\_\_\_\_\_66
- Main menu\_\_\_\_\_65
- MirrorLink\_\_\_\_\_65
- MirrorLink - connection via USB\_\_\_\_\_66
- MirrorLink - connection via Wi-Fi from Infotainment\_\_\_\_\_66
- MirrorLink - disconnection\_\_\_\_\_66
- MirrorLink connection conditions\_\_\_\_\_66
- Mobile device management\_\_\_\_\_62
- Operation of the MirrorLink application\_\_\_\_\_66
- Restriction of the Wi-Fi connection\_\_\_\_\_66
- Restrictions while driving\_\_\_\_\_66
- supported connection types\_\_\_\_\_65
- Snow chains**
- Conditions\_\_\_\_\_145
- Usage\_\_\_\_\_145
- Sockets**
- 12-volt socket\_\_\_\_\_158
- Safety\_\_\_\_\_14
- Sound**
- Infotainment Amundsen\_\_\_\_\_86
- Infotainment Bolero\_\_\_\_\_70
- Infotainment Swing\_\_\_\_\_54
- Spare wheel**\_\_\_\_\_145
- Safe driving\_\_\_\_\_16
- Take out and insert\_\_\_\_\_146
- Speed limit warning**\_\_\_\_\_52
- Setting\_\_\_\_\_52
- Speed limiter**
- Indicator light\_\_\_\_\_122
- Operation\_\_\_\_\_122
- Troubleshooting\_\_\_\_\_123
- Stabilising systems**\_\_\_\_\_120
- START STOP**\_\_\_\_\_113
- START-STOP**
- functionality\_\_\_\_\_113
- indicator light\_\_\_\_\_113
- Operating conditions\_\_\_\_\_113
- Purpose\_\_\_\_\_113
- Settings\_\_\_\_\_113
- Troubleshooting\_\_\_\_\_113
- Starter button**
- Notes on starting\_\_\_\_\_112
- Stopping the engine\_\_\_\_\_112
- Switching the ignition on and off\_\_\_\_\_112
- Troubleshooting\_\_\_\_\_112
- Steering column lock**\_\_\_\_\_30
- Steering wheel**

- Correct position.....15
- Dials/buttons.....50
- manually changing gear with the shift paddles on
  - the steering wheel.....114
- Set position.....30
- Troubleshooting.....30
- Stopping the engine**
- Ignition lock.....111
- Starter button.....112
- Storage**.....155
- Storage pocket**.....153
- Sun protection**
- Activating sun visor operation.....25
- electric operation of the sun blinds.....25
- Operation of the sun visors.....25
- Supported media files**
- see electronic version of the manual.....5
- Switch off front passenger airbag**
- Indicator lights.....38
- Key switch.....38
- Status display in the instrument cluster display.....38
- Switching low beam on automatically**.....39
- System update**
- Infotainment Amundsen.....87
- Infotainment Bolero.....70
- Infotainment Swing.....54
- T**
- Tailgate**
- Settings.....27
- Troubleshooting.....27
- Tank capacity**
- Diesel.....138
- Petrol.....137
- Technical data**.....164
- Technical specifications**
- Consumption.....164
- Dimensions.....166
- Emission standard.....164
- engine specifications.....166
- maximum permitted weights.....165
- Telephone - Infotainment Amundsen**
- Conference call.....99
- Connect Infotainment to a telephone.....100
- Connect the telephone to Infotainment.....100
- Connection conditions.....99
- Display accepted text messages.....99
- Enter phone number.....99
- Establish a connection to the voice mailbox number
  - .....99
- Import phone contacts.....100
- Infotainment telephone connection types.....100
- List of telephone contacts.....99
- Main menu overview.....98
- Manage preset buttons for preferred contacts
  - .....100
- Note about an incoming SMS / email.....100
- Ringer.....100
- Send email.....99
- Send text message.....99
- Show main menu.....98
- Show received emails.....99
- Simultaneous calls.....100
- Sort contacts in the phonebook.....100
- Telephone call.....99
- Update phone contacts.....100
- Voice mailbox number.....100
- Telephone - Infotainment Bolero**
- Conference call.....79
- Connect the telephone to Infotainment.....79
- Connecting Infotainment with a telephone.....79
- Connection conditions.....78
- Display main menu.....78
- Enter telephone number.....79
- Establish a connection to the voice mailbox number
  - .....79
- Import telephone contacts.....79
- List of telephone contacts.....79
- Main menu overview.....78
- Manage preset buttons for preferred contacts.....79
- Number of voice mailbox.....79
- Ringer.....79
- Simultaneous calls.....79
- Sort contacts in the phonebook.....79
- Telephone conversation.....79
- Telephone-Infotainment-Connection types.....79
- Update telephone contacts.....79
- Telephone - Infotainment Swing**
- Conference call.....63
- Connect Infotainment to a telephone.....63
- Connect the telephone to Infotainment.....63
- Connection conditions.....62
- Enter phone number.....63
- Establish a connection to the voice mailbox number
  - .....63
- Import phone contacts.....63
- List of telephone contacts.....63
- Main menu overview.....62
- Manage preset buttons for preferred contacts.....63
- Ringer.....63
- Show main menu.....62
- Simultaneous calls.....63
- Sort contacts in the phonebook.....63
- Telephone call.....63
- Telephone-Infotainment-Connection types.....63
- Update phone contacts.....63
- Voice mailbox number.....63
- Time**
- Infotainment Amundsen.....86
- Infotainment Bolero.....70
- Infotainment Swing.....54
- Tiptronic**
- Manually changing gear with the selector lever
  - .....114
- manually changing gear with the shift paddles on
  - the steering wheel.....114
- Tool**.....151

- Top speed ..... 166
  - TOP TETHER** ..... 36
  - Topping up**
    - Windscreen washer fluid ..... 44, 45
  - Tow hitch** ..... 159
  - Towing a trailer** ..... 117
  - Towing eye** ..... 118
  - Towing the vehicle**
    - Tow rope ..... 118
    - Towing ..... 118
  - Traffic accident**
    - Data recorder ..... 167
    - Emergency call ..... 17
  - Trailer** ..... 117
    - Coupling and uncoupling ..... 159
    - Distribution of load ..... 117
    - Driving with a trailer ..... 117
    - Safe driving ..... 16
    - Swing out the tow bar and back in ..... 159
  - Trailer attachment**
    - Vertical load ..... 160
  - Trailer coupling**
    - indicator light ..... 160
    - Troubleshooting ..... 160
    - What you should be mindful of ..... 159
  - Trailer Stability Assist** ..... 120
  - Trailers**
    - Permissible load ..... 117
  - Transport**
    - Transporting objects safely ..... 16
  - Transporting**
    - tow hitch ..... 159
  - Transporting a trailer** ..... 117
  - Transporting the roof rack** ..... 159
  - TSA**
    - see Trailer Stability Assist ..... 120
  - Turn signal** ..... 39
  - Type plate** ..... 164
  - Tyre pressure monitor**
    - Indicator light ..... 149, 150
    - Restriction ..... 149
    - Saving tyre pressure values ..... 149
    - Troubleshooting ..... 150
    - Tyre pressure change ..... 149
  - Tyre pressure monitoring system** ..... 149
  - Tyres**
    - All-season or winter tyres ..... 145
    - Overview of the labelling ..... 144
    - Pressure ..... 149
    - Snow chains ..... 145
    - Tyre pressure monitoring system ..... 149
    - What you should be mindful of ..... 144
- U**
- Umbrella** ..... 156
  - Units**
  - Infotainment Amundsen ..... 86
  - Infotainment Bolero ..... 70
  - Infotainment Swing ..... 54
  - Unlock**
    - Setting ..... 20
  - Unlocking**
    - Central locking button ..... 20
    - Emergency unlocking ..... 20
    - functionality ..... 19
    - Keyless ..... 21
    - the boot lid ..... 27
  - Updating the infotainment system**
    - see electronic version of the manual ..... 5
  - USB** ..... 155
    - see electronic version of the manual ..... 5
  - User account**
    - see electronic version of the manual ..... 5
  - User management**
    - see electronic version of the manual ..... 5
  - User Management - Infotainment Amundsen**
    - Functionality ..... 96
    - Management ..... 97
    - Registration ..... 97
- V**
- Variable loading floor in the boot** ..... 154
  - Variable loading floor in the luggage compartment**
    - Removal and insertion ..... 155
  - Vehicle battery** ..... 139
    - Charging ..... 139
    - Checking the condition ..... 139
    - Discharge protection ..... 139
    - Disconnecting and connecting ..... 140
    - Indicator light ..... 140
    - Safety ..... 14
    - Troubleshooting ..... 140
  - Vehicle cleaning**
    - interior space ..... 162
    - What you should be mindful of ..... 162
  - Vehicle condition** ..... 52
  - Vehicle dimensions** ..... 166
  - Vehicle driving mode** ..... 115
    - Driving mode selection ..... 115
    - Eco ..... 115
    - Individual ..... 115
    - Normal ..... 115
    - Overview ..... 115
    - Sport ..... 115
    - Troubleshooting ..... 116
    - Usage ..... 115
  - Vehicle height** ..... 166
  - Vehicle Identification Number (VIN)** ..... 164
  - Vehicle length** ..... 166
  - Vehicle width** ..... 166
  - Video**
    - see electronic version of the manual ..... 5
  - VIN**
    - see vehicle identification number ..... 164



- Virtual cockpit**
  - see digital instrument cluster 49
- Voice control - Infotainment Amundsen**
  - Functionality 89
  - Help 89
  - Operating conditions 89
  - Operation 89
  - Restriction 89
  - Settings 89
- Volume when switching on the Infotainment**
  - Infotainment Amundsen 86
  - Infotainment Bolero 70
  - Infotainment Swing 54
- W**
- Warning triangle** 151
- Warranty** 168
  - Extended warranty 169
  - Mobility warranty 169
  - Rights arising from defective performance 168
  - Warranty for new cars 168
- Washers**
  - Operating conditions 43
- Waste container** 157
- Water in the fuel filter** 135
- Weight**
  - Maximum allowed 165
  - payload 165
- Wheels**
  - Change 146, 147
  - Cover caps for the screws 150
  - Full wheel covers 150
  - Overview of tyre labelling 144
  - Spare wheel and emergency wheel 145
  - Troubleshooting 145
  - Tyre pressure 149
  - Tyre pressure monitoring system 149
  - What you should be mindful of 144
- Wi-Fi - Infotainment Amundsen**
  - Automatic connection using the QR code 102
  - Automatic WPS connection 102
  - Change password for connection to the Infotainment hotspot 102
  - Change the name of the Infotainment hotspot 102
  - connect a mobile device to the Infotainment hotspot 102
  - Connect Infotainment to the mobile device hotspot 102
  - Data transmission to the connected device 102
  - Function restriction 102
  - Functionality 101
  - Manual WPS connection 102
  - Overview of available hotspots 101
  - Quick connection of the Infotainment to the hotspot 102
  - Security level of the Infotainment hotspot 102
  - Tips for a perfect connection 102
- Wi-Fi - Infotainment Bolero**
  - Change password for connection to the Infotainment hotspot 80
  - connect a mobile device to the Infotainment hotspot 80
  - Functionality 80
  - Security level of the Infotainment hotspot 80
- Wi-Fi - Infotainment Swing**
  - Change password for connection to the Infotainment hotspot 64
  - connect a mobile device to the Infotainment hotspot 64
  - Functionality 64
  - Security level of the Infotainment hotspot 64
- Window**
  - electrical operation 24
  - heating 25
  - Mechanical operation 24
- Window heating**
  - Conditions 25
  - Troubleshooting 26
  - Usage 25
- Windscreen washer fluid**
  - indicator light 45
  - Refill washer fluid 44
- Windscreen washer system**
  - Operation 44
  - Refilling 44
- Windscreen washing system**
  - Windscreen washer fluid level too low 45
- Windscreen wiper and washer**
  - Automatic rear window wiper 44
  - Fold away windscreen wiper arms 45
  - Refill windscreen washer fluid 44
  - Replace the windscreen wiper blade 45
- Windscreen wipers and washers**
  - Operating conditions 43
  - Operation 44
  - Setting 44
  - Troubleshooting 45
- Winter tires**
  - Conditions 145
- Winter tyres**
  - Settings 145
  - Usage 145
  - What you should be mindful of 145
- Wireless network**
  - see electronic version of the manual 5
- X**
- XDL +** 120